



Shenzhen Huaxia Testing Technology Co., Ltd

1F., Block A of Tongsheng Technology Building, Huahui Road, Dalang Street, Longhua District, Shenzhen, China

Telephone: +86-755-26648640

Fax: +86-755-26648637

Website: www.cqa-cert.com

Report Template Version: V03

Report Template Revision Date: Mar.1st, 2017

Test Report

Report No. : CQASZ20190400249E-01
Applicant: Shenzhen PENGLIXIN Technology Co., Limited
Address of Applicant: Rm. 532-540, C Building, Huahui Road No.73, Dalang, Longhua District, Shenzhen, China
Manufacturer: Shenzhen PENGLIXIN Technology Co., Limited
Address of Manufacturer: Rm. 532-540, C Building, Huahui Road No.73, Dalang, Longhua District, Shenzhen, China
Equipment Under Test (EUT):
Product: WIFI Oscope
Model No.: WF-500
Brand Name: N/A
FCC ID: 2AKMMPLXWF-500
Standards: 47 CFR Part 15, Subpart C
Date of Test: 2019-04-16 to 2019-05-09
Date of Issue: 2019-05-09
Test Result : **PASS***

Tested By:

Daisy Qin

(Daisy Qin)

Reviewed By:

Aaron Ma

(Aaron Ma)

Approved By:

Jack Ai
(Jack Ai)



* In the configuration tested, the EUT complied with the standards specified above.

The test report is effective only with both signature and specialized stamp, The result(s) shown in this report refer only to the sample(s) tested. Without written approval of CQA, this report can't be reproduced except in full.

1 Version

Revision History Of Report

Report No.	Version	Description	Issue Date
CQASZ20190400249E-01	Rev.01	Initial report	2019-05-09

2 Test Summary

Test Item	Test Requirement	Test method	Result
Antenna Requirement	47 CFR Part 15, Subpart C Section 15.203/15.247 (c)	ANSI C63.10 2013	PASS
AC Power Line Conducted Emission	47 CFR Part 15, Subpart C Section 15.207	ANSI C63.10 2013	N/A
Conducted Peak & Average Output Power	47 CFR Part 15, Subpart C Section 15.247 (b)(3)	ANSI C63.10 2013	PASS
6dB Occupied Bandwidth	47 CFR Part 15, Subpart C Section 15.247 (a)(2)	ANSI C63.10 2013	PASS
Power Spectral Density	47 CFR Part 15, Subpart C Section 15.247 (e)	ANSI C63.10 2013	PASS
Band-edge for RF Conducted Emissions	47 CFR Part 15, Subpart C Section 15.247(d)	ANSI C63.10 2013	PASS
RF Conducted Spurious Emissions	47 CFR Part 15, Subpart C Section 15.247(d)	ANSI C63.10 2013	PASS
Radiated Spurious Emissions	47 CFR Part 15, Subpart C Section 15.205/15.209	ANSI C63.10 2013	PASS
Restricted bands around fundamental frequency (Radiated Emission)	47 CFR Part 15, Subpart C Section 15.205/15.209	ANSI C63.10 2013	PASS

N/A: Not Applicable

Note: When the EUT charging, WIFI will not work.

3 Contents

	Page
1 VERSION	2
2 TEST SUMMARY	3
3 CONTENTS	4
4 GENERAL INFORMATION.....	5
4.1 CLIENT INFORMATION	5
4.2 GENERAL DESCRIPTION OF EUT	5
4.3 TEST ENVIRONMENT AND MODE	7
4.4 DESCRIPTION OF SUPPORT UNITS	10
4.5 TEST LOCATION	10
4.6 TEST FACILITY	10
4.7 STATEMENT OF THE MEASUREMENT UNCERTAINTY	11
4.8 DEVIATION FROM STANDARDS	11
4.9 ABNORMALITIES FROM STANDARD CONDITIONS	11
4.10 OTHER INFORMATION REQUESTED BY THE CUSTOMER	11
4.11 EQUIPMENT LIST	12
5 TEST RESULTS AND MEASUREMENT DATA.....	13
5.1 ANTENNA REQUIREMENT.....	13
5.2 CONDUCTED PEAK & AVERAGE OUTPUT POWER	14
5.3 6dB OCCUPY BANDWIDTH	16
5.4 POWER SPECTRAL DENSITY	30
5.5 BAND-EDGE FOR RF CONDUCTED EMISSIONS	38
5.6 RF CONDUCTED SPURIOUS EMISSIONS	44
5.7 RADIATED SPURIOUS EMISSIONS.....	63
5.7.1 <i>Radiated emission below 1GHz</i>	66
5.7.2 <i>Transmitter emission above 1GHz</i>	68
5.8 RESTRICTED BANDS AROUND FUNDAMENTAL FREQUENCY	70
6 PHOTOGRAPHS - EUT TEST SETUP	76
6.1 RADIATED SPURIOUS EMISSION.....	76
7 PHOTOGRAPHS - EUT CONSTRUCTIONAL DETAILS	78

4 General Information

4.1 Client Information

Applicant:	Shenzhen PENGLIXIN Technology Co., Limited
Address of Applicant:	Rm. 532-540, C Building, Huahui Road No.73, Dalang, Longhua District, Shenzhen, China
Manufacturer:	Shenzhen PENGLIXIN Technology Co., Limited
Address of Manufacturer:	Rm. 532-540, C Building, Huahui Road No.73, Dalang, Longhua District, Shenzhen, China

4.2 General Description of EUT

Product Name:	WIFI Oscope
Model No.:	WF-500
Trade Mark:	N/A
Hardware version:	V1.3
Software version:	V1.2
Operation Frequency:	IEEE 802.11b/g/n(HT20): 2412MHz to 2462MHz IEEE 802.11n(HT40): 2422MHz to 2452MHz
Channel Numbers:	IEEE 802.11b/g, IEEE 802.11n HT20: 11 Channels IEEE 802.11n HT40: 7 Channels
Channel Separation:	5MHz
Type of Modulation:	IEEE for 802.11b: DSSS(CCK,DQPSK,DBPSK) IEEE for 802.11g : OFDM(64QAM, 16QAM, QPSK, BPSK) IEEE for 802.11n(HT20 and HT40) : OFDM (64QAM, 16QAM, QPSK,BPSK)
Transfer Rate:	IEEE for 802.11b: 1Mbps/2Mbps/5.5Mbps/11Mbps IEEE for 802.11g : 6Mbps/9Mbps/12Mbps/18Mbps/24Mbps/36Mbps/48Mbps/54Mbps IEEE for 802.11n(HT20) : 6.5Mbps/13Mbps/19.5Mbps/26Mbps/39Mbps/52Mbps/58.5Mbps/65Mbps IEEE for 802.11n(HT40) : 13.5Mbps/27Mbps/40.5Mbps/54Mbps/81Mbps/108Mbps/121.5Mbps/135Mbps
Product Type:	<input checked="" type="checkbox"/> Mobile <input type="checkbox"/> Portable <input type="checkbox"/> Fix Location
Test Software of EUT:	SecureCRT (manufacturer declare)
Antenna Type:	internal antenna
Antenna Gain:	0dBi
Power Supply:	DC3.7V, 420mAh; Charge by USB

Operation Frequency each of channel(802.11b/g/n HT20)							
Channel	Frequency	Channel	Frequency	Channel	Frequency	Channel	Frequency
1	2412MHz	4	2427MHz	7	2442MHz	10	2457MHz
2	2417MHz	5	2432MHz	8	2447MHz	11	2462MHz
3	2422MHz	6	2437MHz	9	2452MHz		
Operation Frequency each of channel(802.11n HT40)							
Channel	Frequency	Channel	Frequency	Channel	Frequency		
1	2422MHz	4	2437MHz	7	2452MHz		
2	2427MHz	5	2442MHz				
3	2432MHz	6	2447MHz				

Note:

In section 15.31(m), regards to the operating frequency range over 10 MHz, the Lowest frequency, the middle frequency, and the highest frequency of channel were selected to perform the test, and the selected channel see below:

For 802.11b/g/n (HT20):

Channel	Frequency
The Lowest channel	2412MHz
The Middle channel	2437MHz
The Highest channel	2462MHz

For 802.11n (HT40):

Channel	Frequency
The Lowest channel	2422MHz
The Middle channel	2437MHz
The Highest channel	2452MHz

Note:

Software provided by client enabled the EUT to transmit and receive data at lowest, middle and highest channel individually.

4.3 Test Environment and Mode

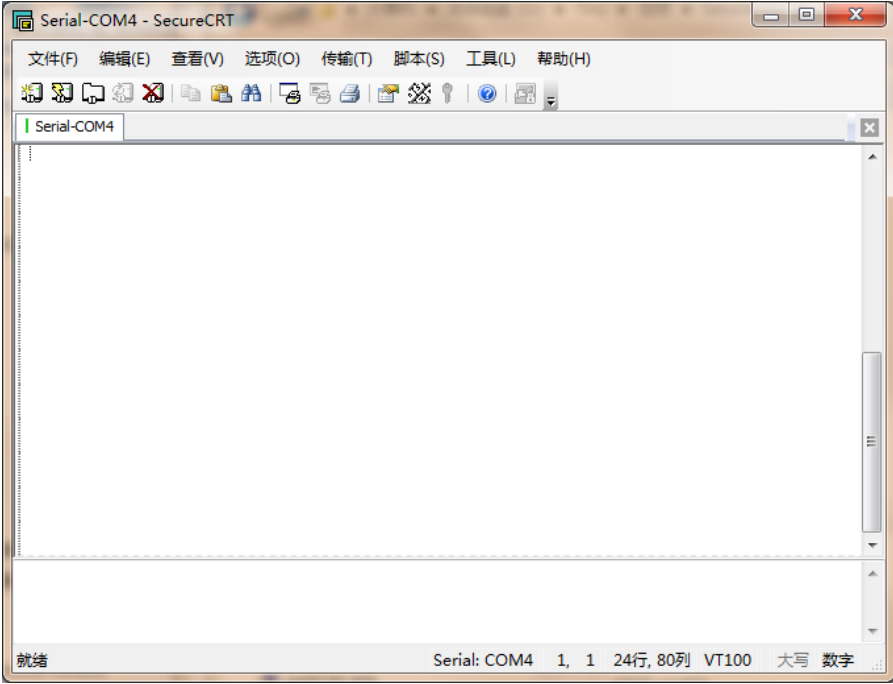
Operating Environment:		
Temperature:	24.0 °C	
Humidity:	52 % RH	
Atmospheric Pressure:	1008 mbar	
Test mode:		
Transmitting mode:	Keep the EUT in transmitting mode with all kind of modulation and all kind of data rate.	
Run Software:		
		
Operated Mode for Worst Duty Cycle:		
Test Mode	Duty Cycle(x)	Average correction factor(dB)
IEEE802.11b	99.5%	0.02
IEEE802.11g	93.6%	0.29
IEEE802.11n (HT20)	92.65%	0.33
IEEE802.11n (HT40)	81.82%	0.87

Remark:

- 1) Duty cycle= On Time/ Period;
- 2) Duty Cycle factor = 10 * log(1/ Duty cycle);

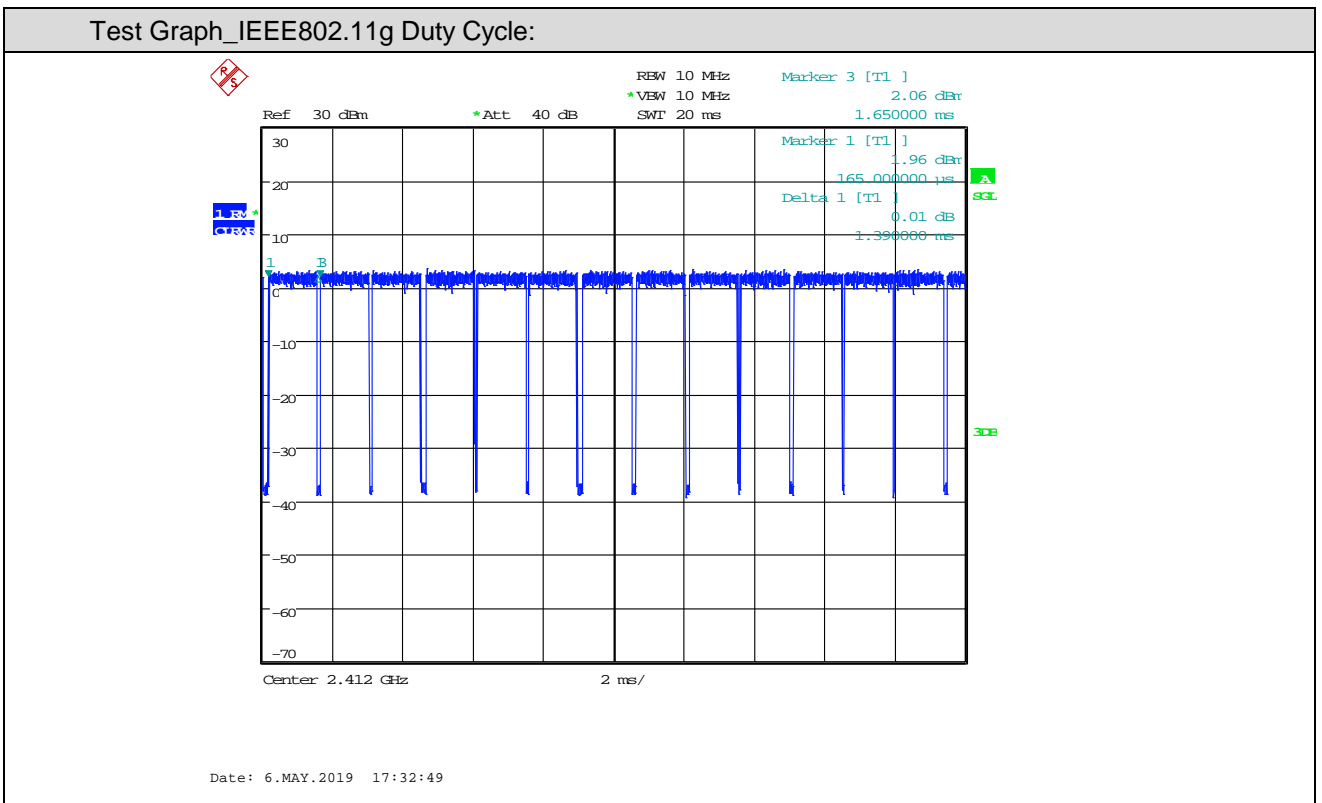
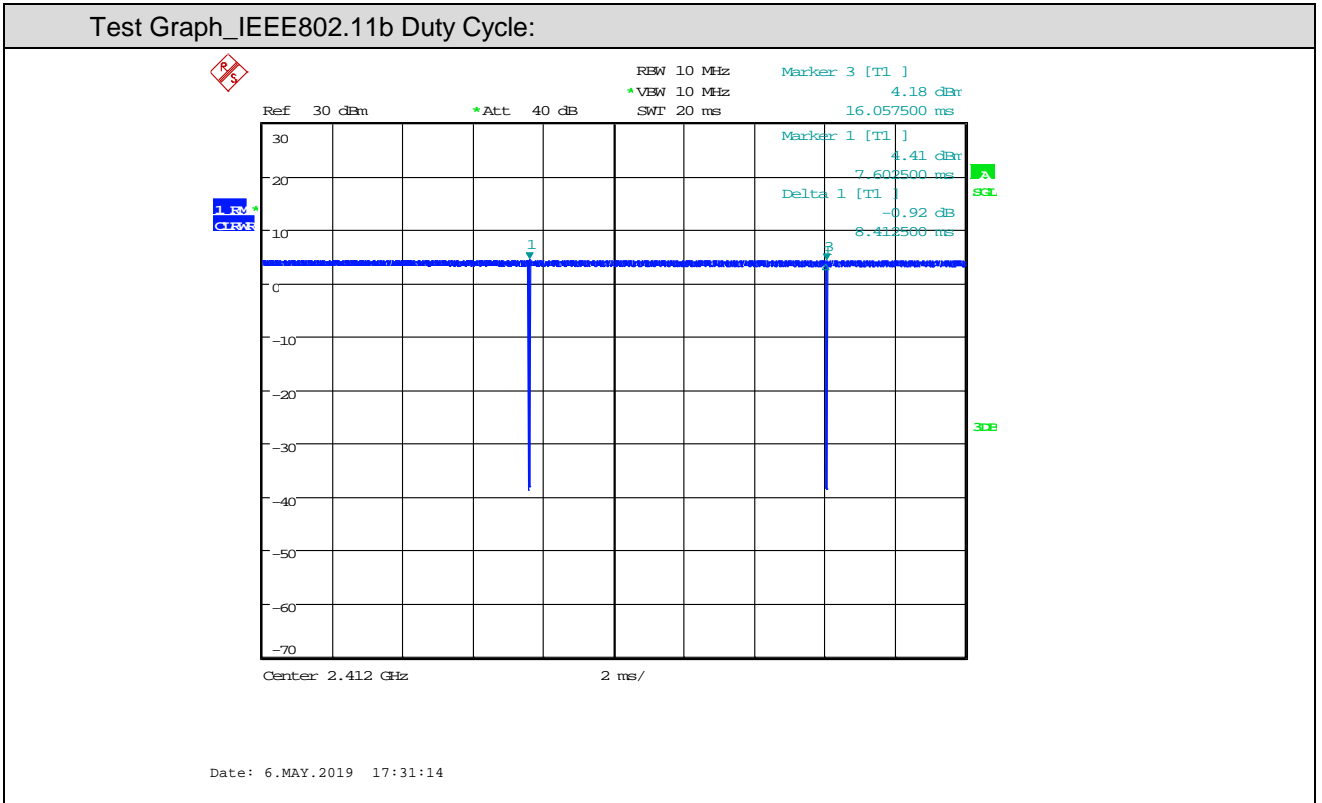

Test Graph_IEEE802.11 n (HT20) Duty Cycle:

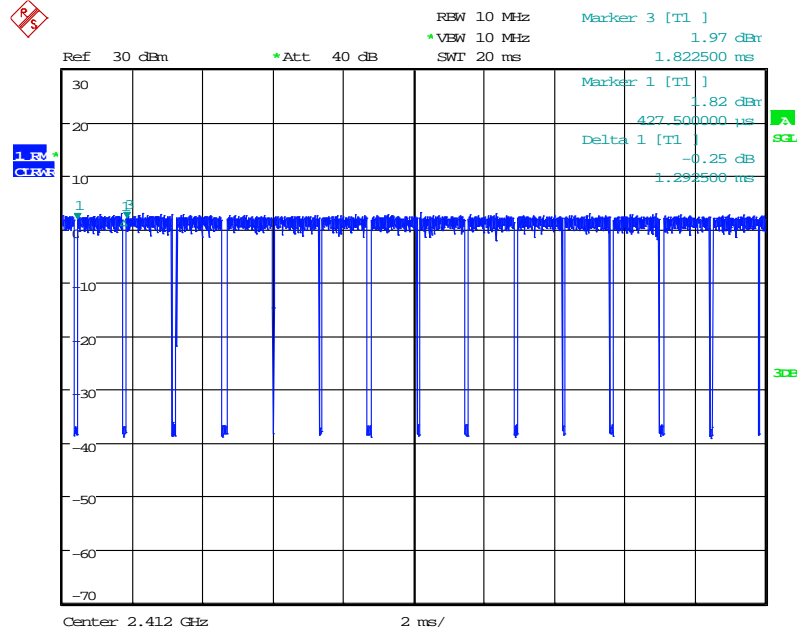

Date: 6.MAY.2019 17:38:06

Test Graph_IEEE802.11 n (HT40) Duty Cycle:

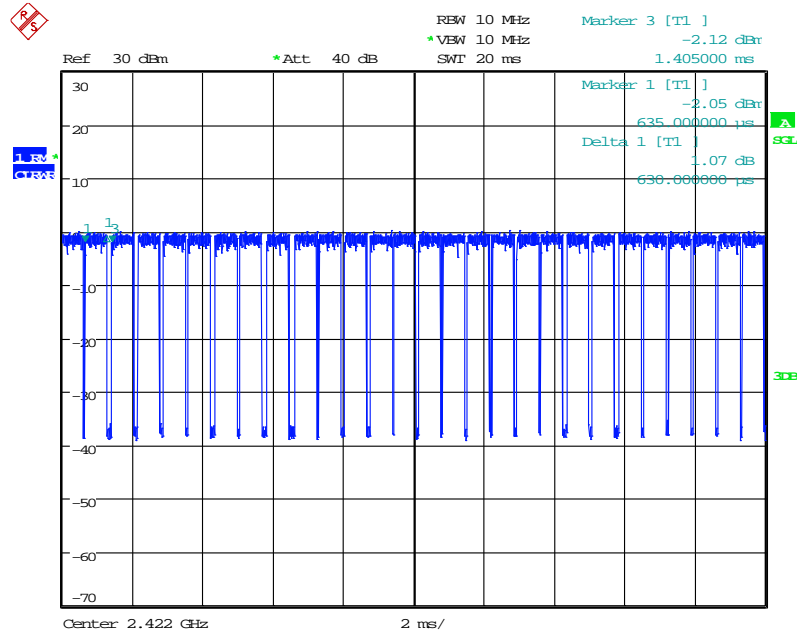

Date: 6.MAY.2019 17:36:14

4.4 Description of Support Units

The EUT has been tested with associated equipment below.

Description	Manufacturer	Model No.	Remark	FCC certification
PC	Lenovo	ThinkPad E450c	Provide by lab	ID

4.5 Test Location

All tests were performed at:

Shenzhen Huaxia Testing Technology Co., Ltd.,

1F., Block A of Tongsheng Technology Building, Huahui Road, Dalang Street, Longhua New District, Shenzhen, Guangdong, China

4.6 Test Facility

The test facility is recognized, certified, or accredited by the following organizations:

- **CNAS (No. CNAS L5785)**

CNAS has accredited Shenzhen Huaxia Testing Technology Co., Ltd. Shenzhen Branch EMC Lab to ISO/IEC 17025:2005 General Requirements for the Competence of Testing and Calibration Laboratories (CNAS-CL01 Accreditation Criteria for the Competence of Testing and Calibration Laboratories) for the competence in the field of testing.

- **ISED Registration No.: 22984-1**

The 3m Semi-anechoic chamber of Shenzhen Huaxia Testing Technology Co., Ltd. has been registered by Certification and Engineering Bureau of Industry Canada for radio equipment testing

- **A2LA (Certificate No. 4742.01)**

Shenzhen Huaxia Testing Technology Co., Ltd., Shenzhen EMC Laboratory is accredited by the American Association for Laboratory Accreditation(A2LA). Certificate No. 4742.01.

- **FCC Registration No.: 522263**

Shenzhen Huaxia Testing Technology Co., Ltd., Shenzhen EMC Laboratory has been registered and fully described in a report filed with the (FCC) Federal Communications Commission. The acceptance letter from the FCC is maintained in our files. Registration No.:522263

4.7 Statement of the measurement uncertainty

The data and results referenced in this document are true and accurate.

The reader is cautioned that there may be errors within the calibration limits of the equipment and facilities.

The measurement uncertainty was calculated for all measurements listed in this test report acc. to CISPR 16 - 4 „Specification for radio disturbance and immunity measuring apparatus and methods – Part 4: Uncertainty in EMC Measurements“ and is documented in the **Shenzhen Huaxia Testing Technology Co., Ltd.** quality system acc. to DIN EN ISO/IEC 17025.

Furthermore, component and process variability of devices similar to that tested may result in additional deviation. The manufacturer has the sole responsibility of continued compliance of the device.

Hereafter the best measurement capability for CQA laboratory is reported:

No.	Item	Uncertainty	Notes
1	Radiated Emission (Below 1GHz)	±5.12dB	(1)
2	Radiated Emission (Above 1GHz)	±4.60dB	(1)
3	Conducted Disturbance (0.15~30MHz)	±3.34dB	(1)
4	Radio Frequency	3×10^{-8}	(1)
5	Duty cycle	0.6 %.	(1)
6	Occupied Bandwidth	1.1%	(1)
7	RF conducted power	0.86dB	(1)
8	RF power density	0.74	(1)
9	Conducted Spurious emissions	0.86dB	(1)
10	Temperature test	0.8℃	(1)
11	Humidity test	2.0%	(1)
12	Supply voltages	0.5 %.	(1)
13	time	0.6 %.	(1)
14	Frequency Error	5.5 Hz	(1)

(1) This uncertainty represents an expanded uncertainty expressed at approximately the 95% confidence level using a coverage factor of k=2.

4.8 Deviation from Standards

None.

4.9 Abnormalities from Standard Conditions

None.

4.10 Other Information Requested by the Customer

None.

4.11 Equipment List

Test Equipment	Manufacturer	Model No.	Instrument No.	Calibration Date	Calibration Due Date
EMI Test Receiver	R&S	ESR7	CQA-005	2018/9/26	2019/9/25
Spectrum analyzer	R&S	FSU26	CQA-038	2018/10/28	2019/10/27
Preamplifier	MITEQ	AFS4-00010300-18-10P-4	CQA-035	2018/9/26	2019/9/25
Preamplifier	MITEQ	AMF-6D-02001800-29-20P	CQA-036	2018/11/2	2019/11/1
Loop antenna	Schwarzbeck	FMZB1516	CQA-087	2018/10/28	2020/10/27
Bilog Antenna	R&S	HL562	CQA-011	2018/9/26	2020/9/25
Horn Antenna	R&S	HF906	CQA-012	2018/9/26	2020/9/25
Horn Antenna	Schwarzbeck	BBHA 9170	CQA-088	2018/9/26	2020/9/25
Coaxial Cable (Above 1GHz)	CQA	N/A	C019	2018/9/26	2019/9/25
Coaxial Cable (Below 1GHz)	CQA	N/A	C020	2018/9/26	2019/9/25
Antenna Connector	CQA	RFC-01	CQA-080	2018/9/26	2019/9/25
RF cable(9KHz~40GHz)	CQA	RF-01	CQA-079	2018/9/26	2019/9/25
Power Sensor	KEYSIGHT	U2021XA	CQA-30	2018/9/26	2019/9/25
N1918A Power Analysis Manager Power Panel	Agilent	N1918A	CQA-074	2018/9/26	2019/9/25
Power divider	MIDWEST	PWD-2533-02-SMA-79	CQA-067	2018/9/26	2019/9/25
EMI Test Receiver	R&S	ESPI3	CQA-013	2018/9/26	2019/9/25
LISN	R&S	ENV216	CQA-003	2018/11/5	2019/11/4
Coaxial cable	CQA	N/A	CQA-C009	2018/9/26	2019/9/25

Note:

The temporary antenna connector is soldered on the PCB board in order to perform conducted tests and this temporary antenna connector is listed in the equipment list.

5 Test results and Measurement Data

5.1 Antenna Requirement

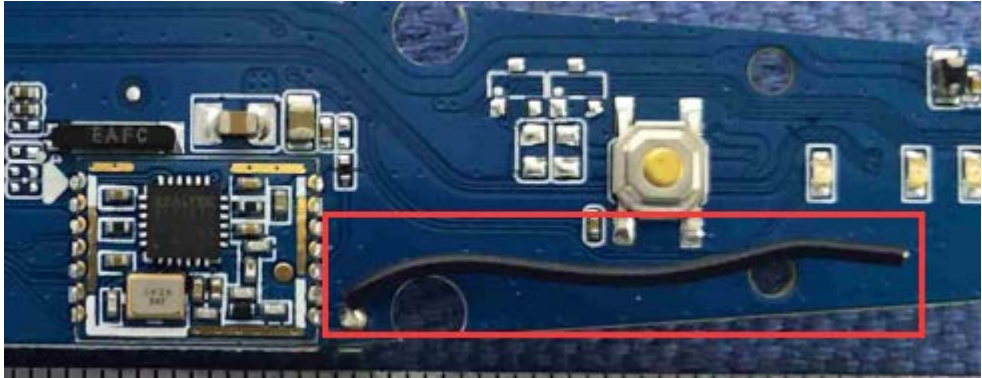
Standard requirement:	47 CFR Part 15C Section 15.203 /247(c)
<p>15.203 requirement: An intentional radiator shall be designed to ensure that no antenna other than that furnished by the responsible party shall be used with the device. The use of a permanently attached antenna or of an antenna that uses a unique coupling to the intentional radiator, the manufacturer may design the unit so that a broken antenna can be replaced by the user, but the use of a standard antenna jack or electrical connector is prohibited.</p> <p>15.247(b) (4) requirement: The conducted output power limit specified in paragraph (b) of this section is based on the use of antennas with directional gains that do not exceed 6 dBi. Except as shown in paragraph (c) of this section, if transmitting antennas of directional gain greater than 6 dBi are used, the conducted output power from the intentional radiator shall be reduced below the stated values in paragraphs (b)(1), (b)(2), and (b)(3) of this section, as appropriate, by the amount in dB that the directional gain of the antenna exceeds 6 dBi.</p>	
EUT Antenna:	
<p>The antenna is internal antenna. The best case gain of the antenna is 0dBi.</p>	

5.2 Conducted Peak & Average Output Power

Test Requirement:	47 CFR Part 15C Section 15.247 (b)(3)
Test Method:	ANSI C63.10: 2013
Test Setup:	 <pre> graph LR EUT[EUT] --- PM[Power Meter] </pre>
Exploratory Test Mode:	Transmitting with all kind of modulations, data rates
Final Test Mode:	Through Pre-scan, find the 1Mbps of rate is the worst case of 802.11b; 6Mbps of rate is the worst case of 802.11g ; 6.5Mbps of rate is the worst case of 802.11n(HT20) ; 13.5Mbps of rate is the worst case of 802.11n(HT40) Only the worst case is recorded in the report.
Limit:	30dBm
Test Results:	Pass

Measurement Data

802.11b mode				
Test channel	Peak Output Power (dBm)	Average Output Power (dBm)	Limit (dBm)	Result
Lowest	10.79	7.38	30.00	Pass
Middle	10.97	7.89	30.00	Pass
Highest	11.22	8.21	30.00	Pass
802.11g mode				
Test channel	Peak Output Power (dBm)	Average Output Power (dBm)	Limit (dBm)	Result
Lowest	15.12	6.98	30.00	Pass
Middle	15.68	7.78	30.00	Pass
Highest	15.41	7.63	30.00	Pass
802.11n(HT20)mode				
Test channel	Peak Output Power (dBm)	Average Output Power (dBm)	Limit (dBm)	Result
Lowest	14.5	6.86	30.00	Pass
Middle	15.11	7.57	30.00	Pass
Highest	14.92	7.42	30.00	Pass
802.11n(HT40)mode				
Test channel	Peak Output Power (dBm)	Average Output Power (dBm)	Limit (dBm)	Result
Lowest	14.68	6.77	30.00	Pass
Middle	15.31	7.47	30.00	Pass
Highest	15.41	7.34	30.00	Pass
Remark:				
1. Average Output Power was for reference only				
2. Average Output Power had added duty cycle factor				

5.3 6dB Occupy Bandwidth

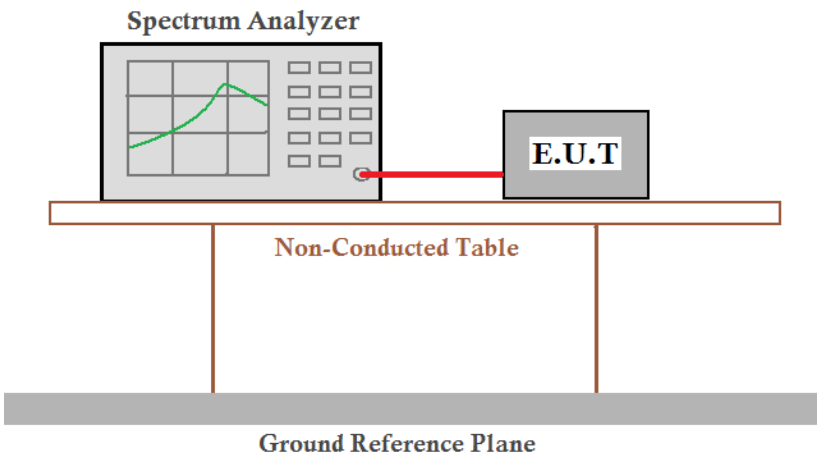
Test Requirement:	47 CFR Part 15C Section 15.247 (a)(2)
Test Method:	ANSI C63.10: 2013
Test Setup:	 <p style="text-align: center;">Offset=cable loss+ attenuation factor</p>
Exploratory Test Mode:	Transmitting with all kind of modulations, data rates
Final Test Mode:	Through Pre-scan, find the 1Mbps of rate is the worst case of 802.11b; 6Mbps of rate is the worst case of 802.11g ; 6.5Mbps of rate is the worst case of 802.11n(HT20) ; 13.5Mbps of rate is the worst case of 802.11n(HT40) Only the worst case is recorded in the report.
Limit:	≥ 500 kHz
Test Results:	Pass

Measurement Data

802.11b mode				
Test channel	6dB Occupy Bandwidth (MHz)	99% OBW [MHz]	Limit (kHz)	Result
Lowest	9.120	13.360	≥500	Pass
Middle	9.160	13.520	≥500	Pass
Highest	8.600	13.440	≥500	Pass
802.11g mode				
Test channel	6dB Occupy Bandwidth (MHz)	99% OBW [MHz]	Limit (kHz)	Result
Lowest	16.400	16.480	≥500	Pass
Middle	16.400	16.520	≥500	Pass
Highest	16.320	16.560	≥500	Pass
802.11n(HT20) mode				
Test channel	6dB Occupy Bandwidth (MHz)	99% OBW [MHz]	Limit (kHz)	Result
Lowest	17.400	17.600	≥500	Pass
Middle	17.640	17.600	≥500	Pass
Highest	17.440	17.600	≥500	Pass
802.11n(HT40)mode				
Test channel	6dB Occupy Bandwidth (MHz)	99% OBW [MHz]	Limit (kHz)	Result
Lowest	34.000	35.840	≥500	Pass
Middle	35.920	35.840	≥500	Pass
Highest	35.360	36.000	≥500	Pass
Remark:				
1. 99% OBW was for reference only				

Test plot as follows:

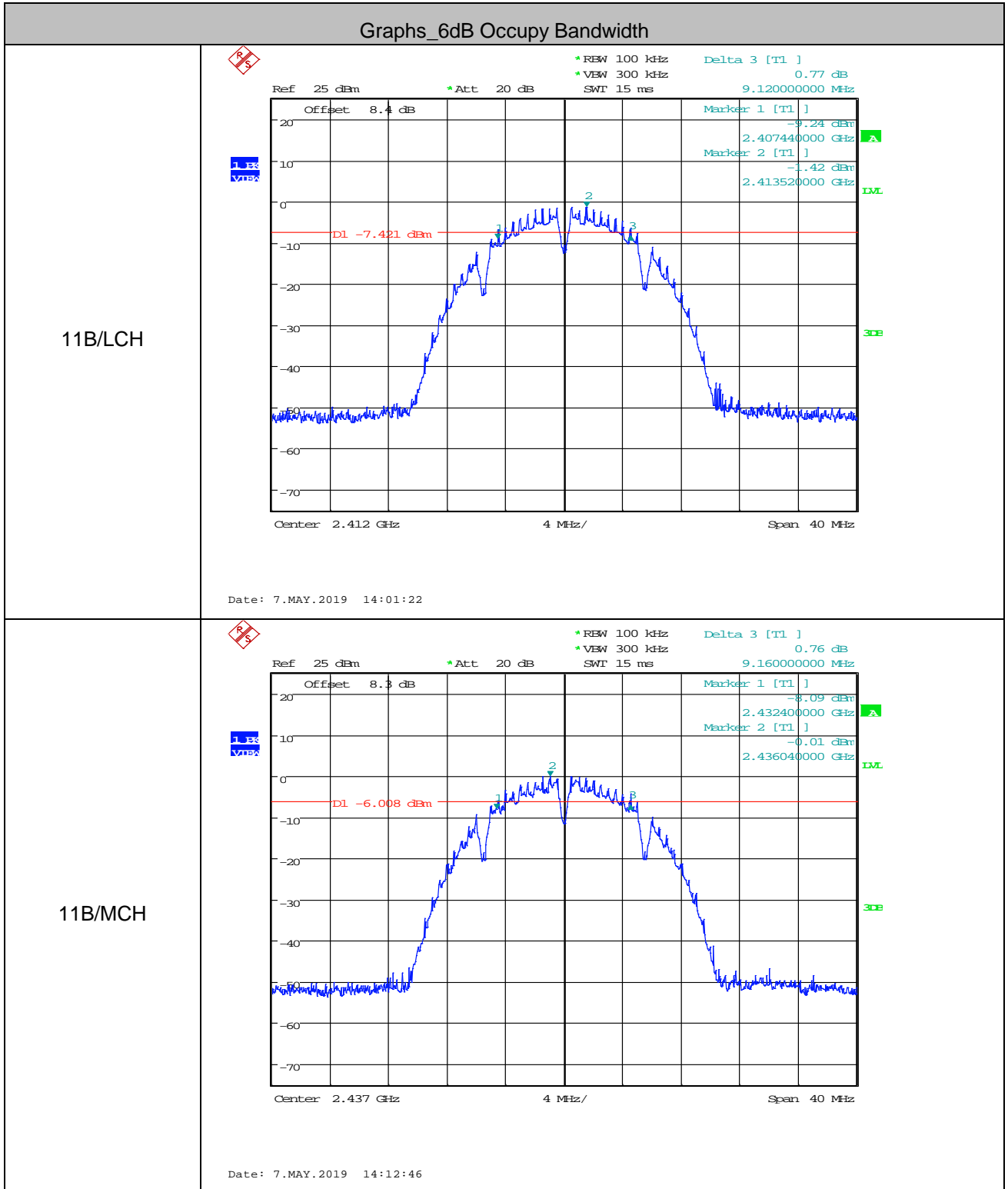

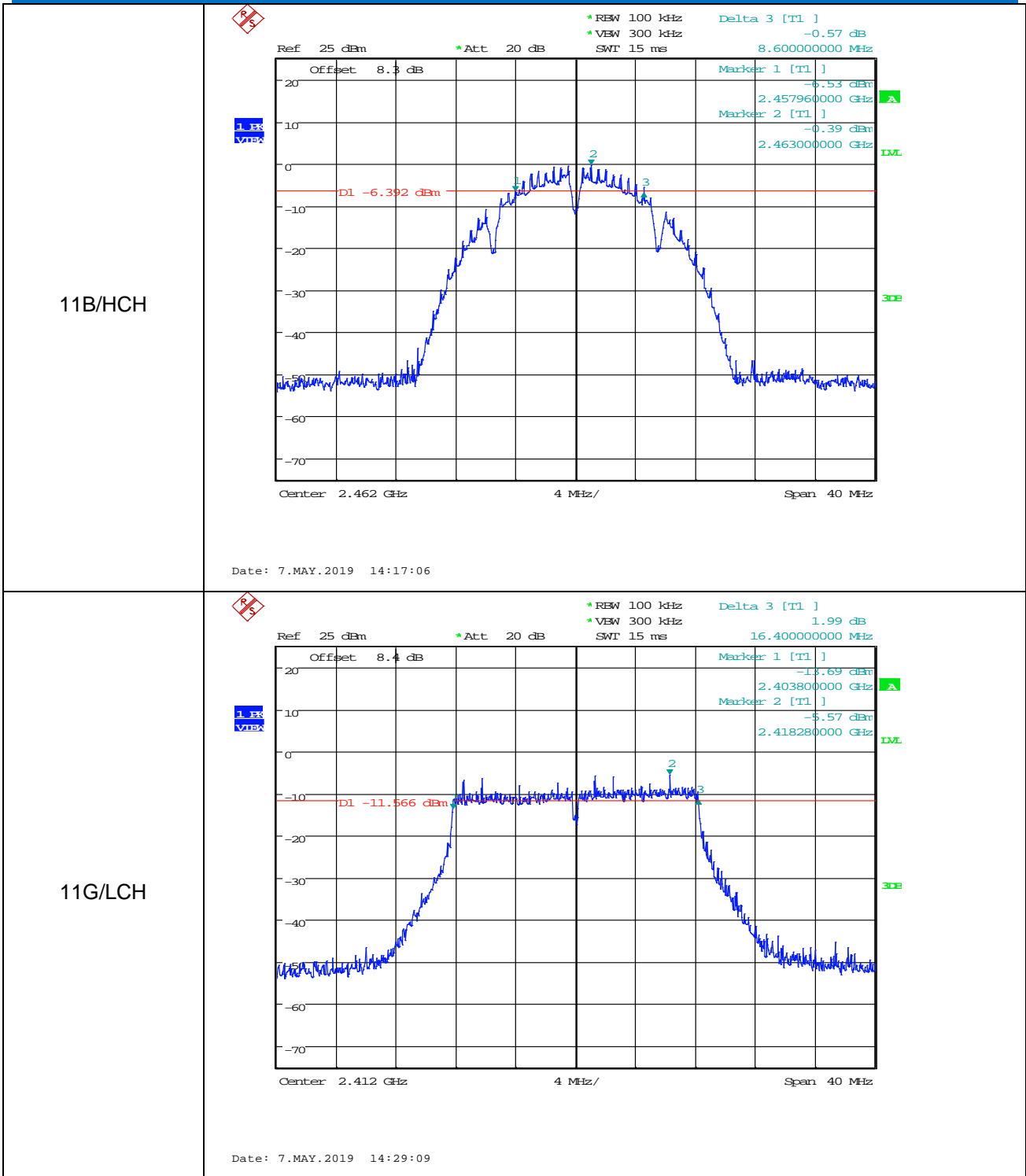

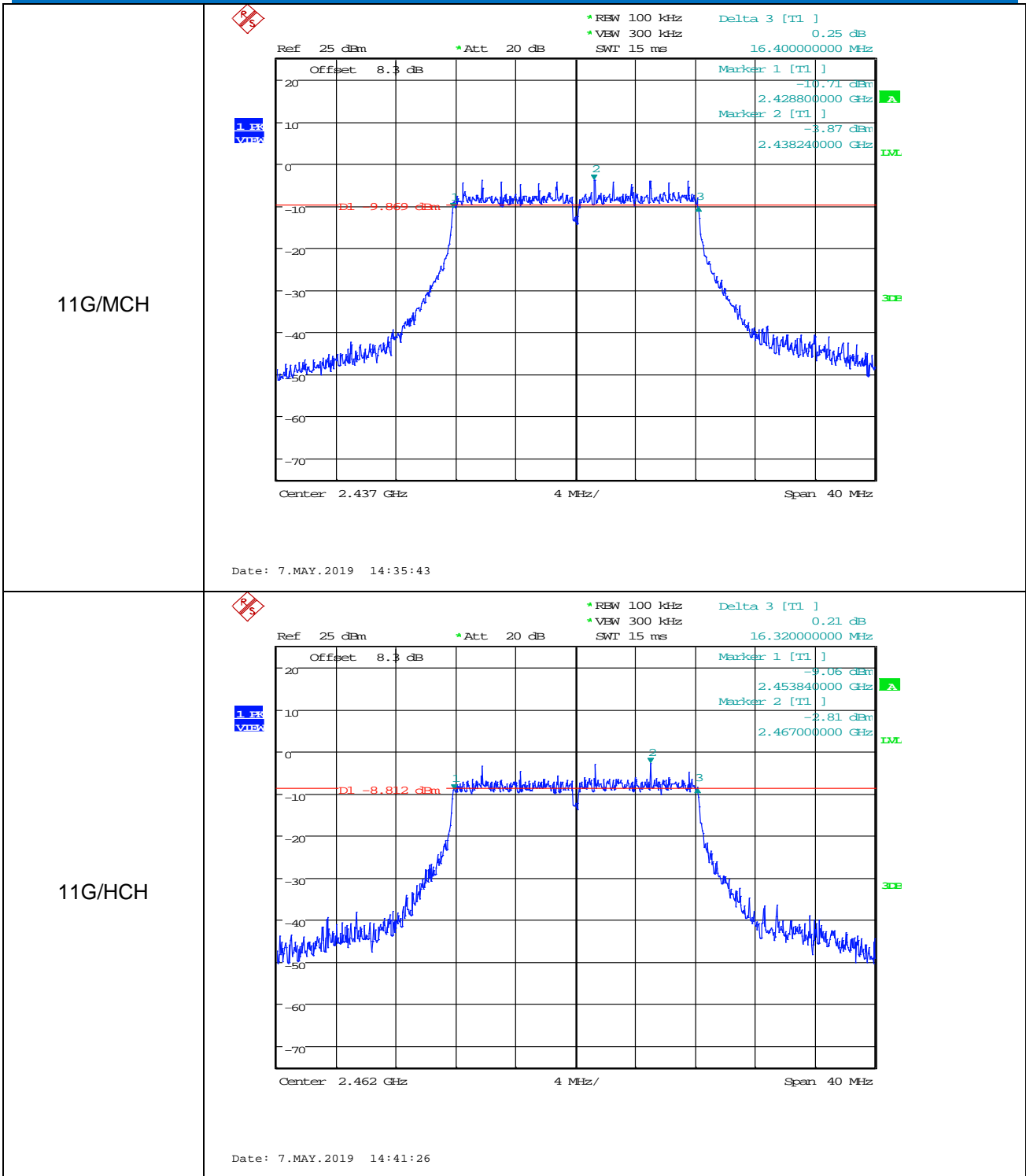

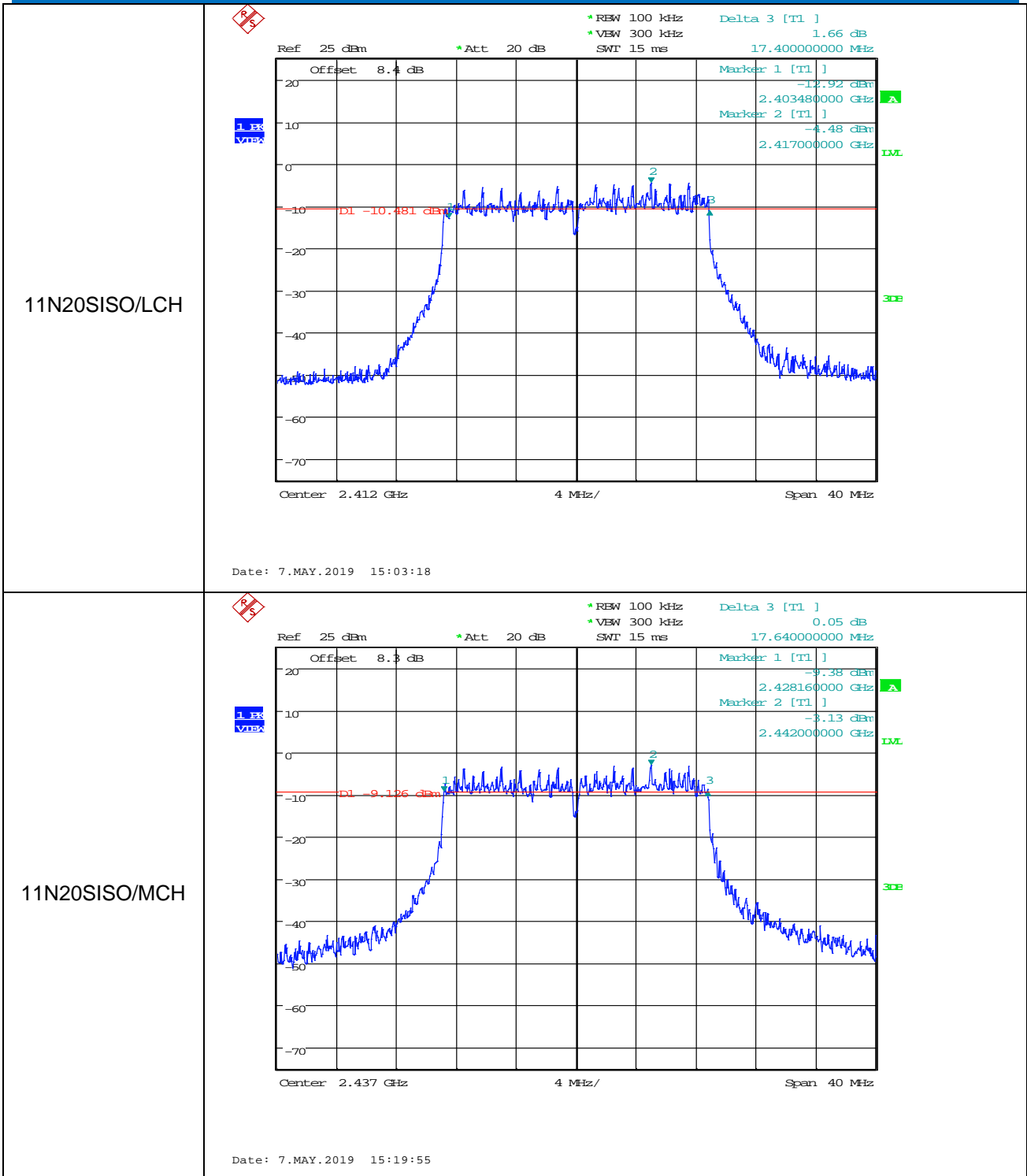

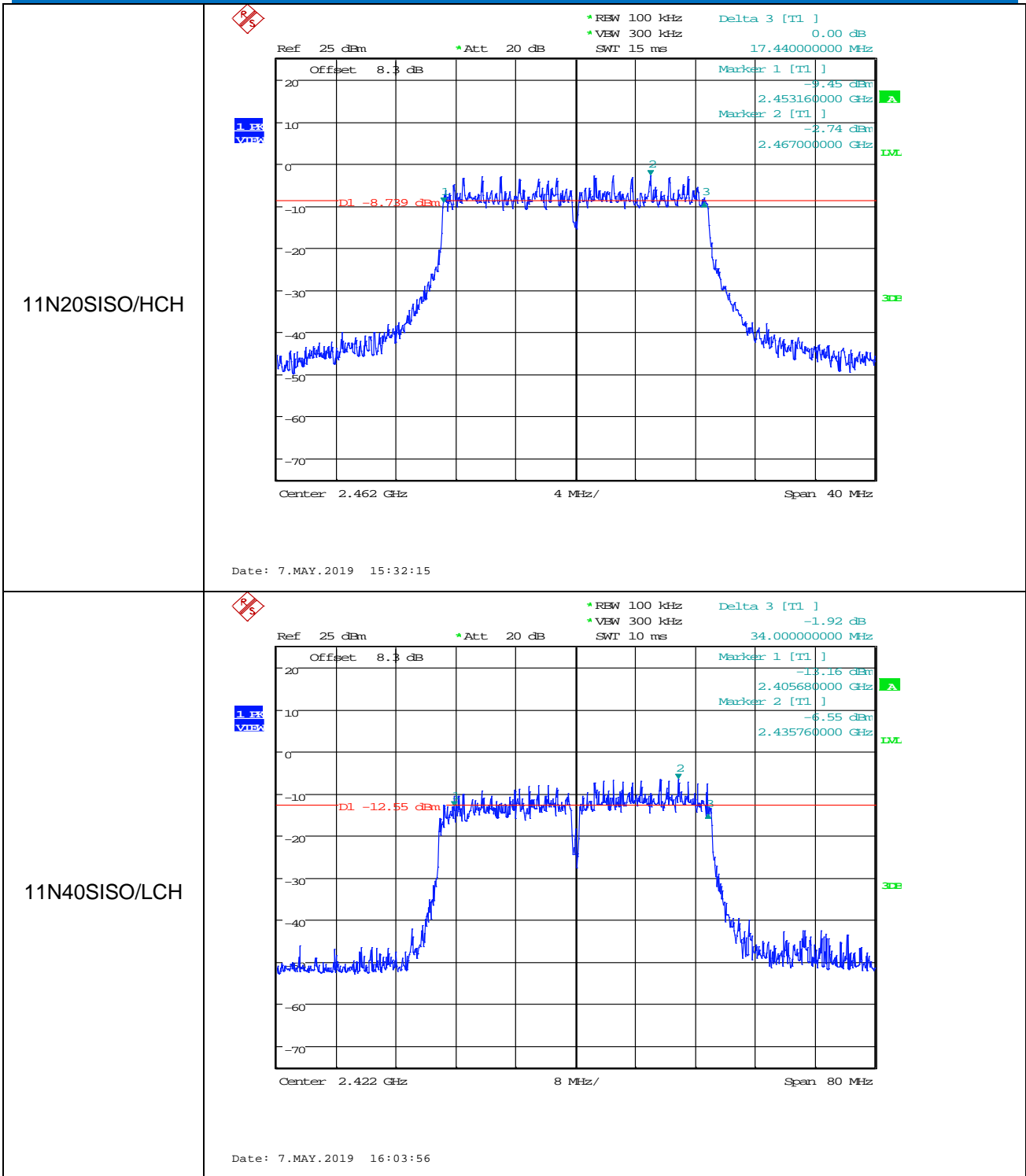

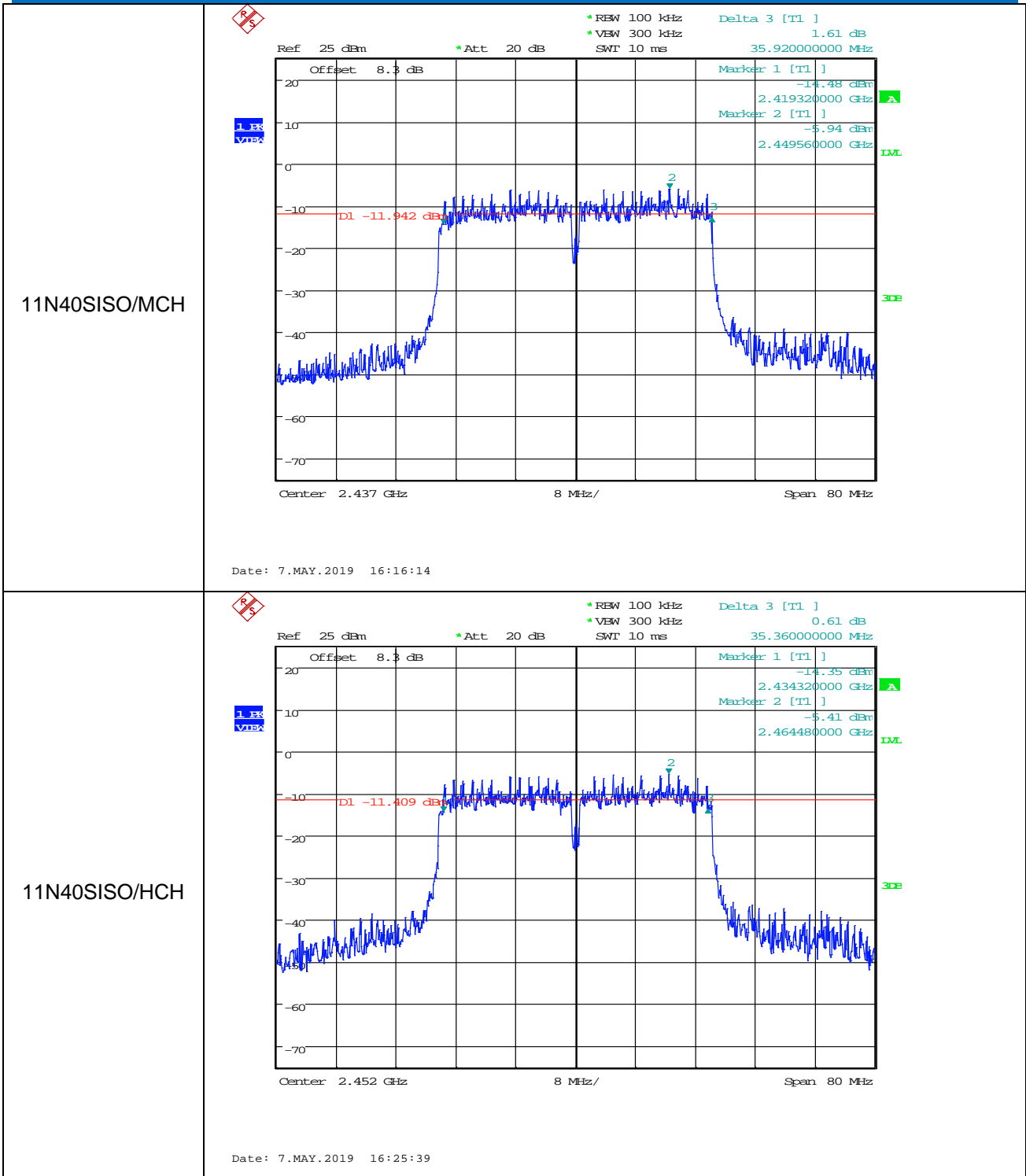

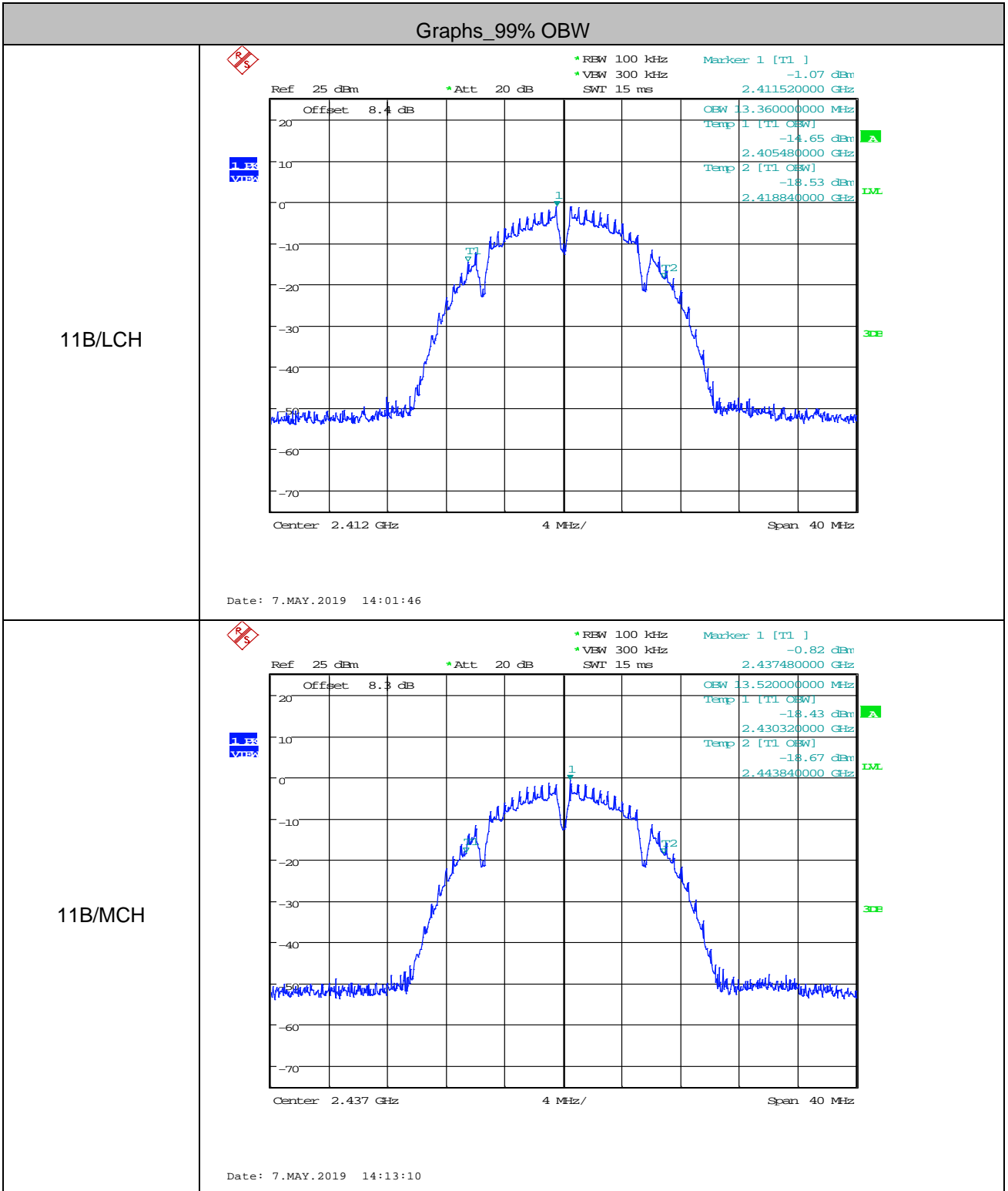

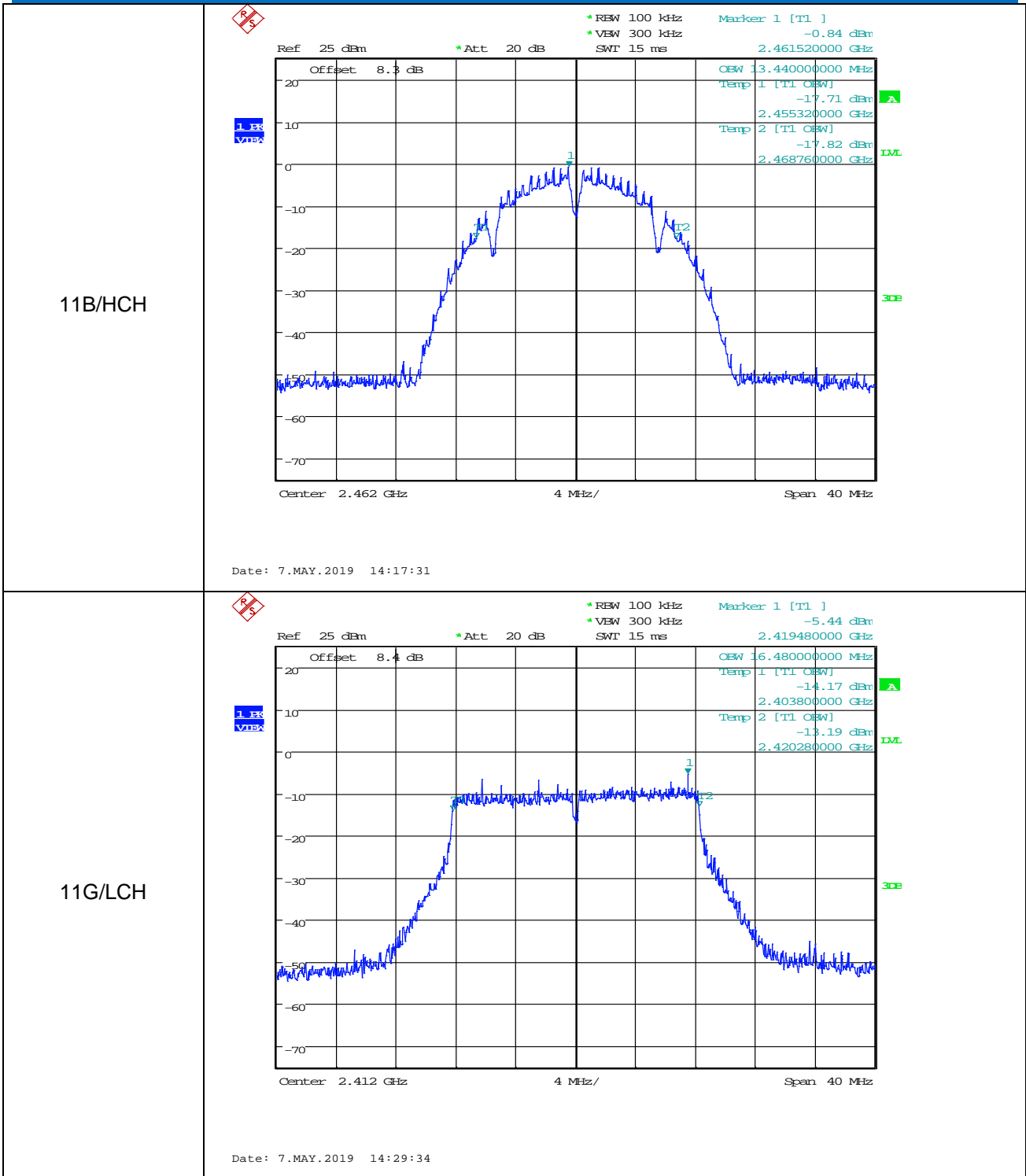

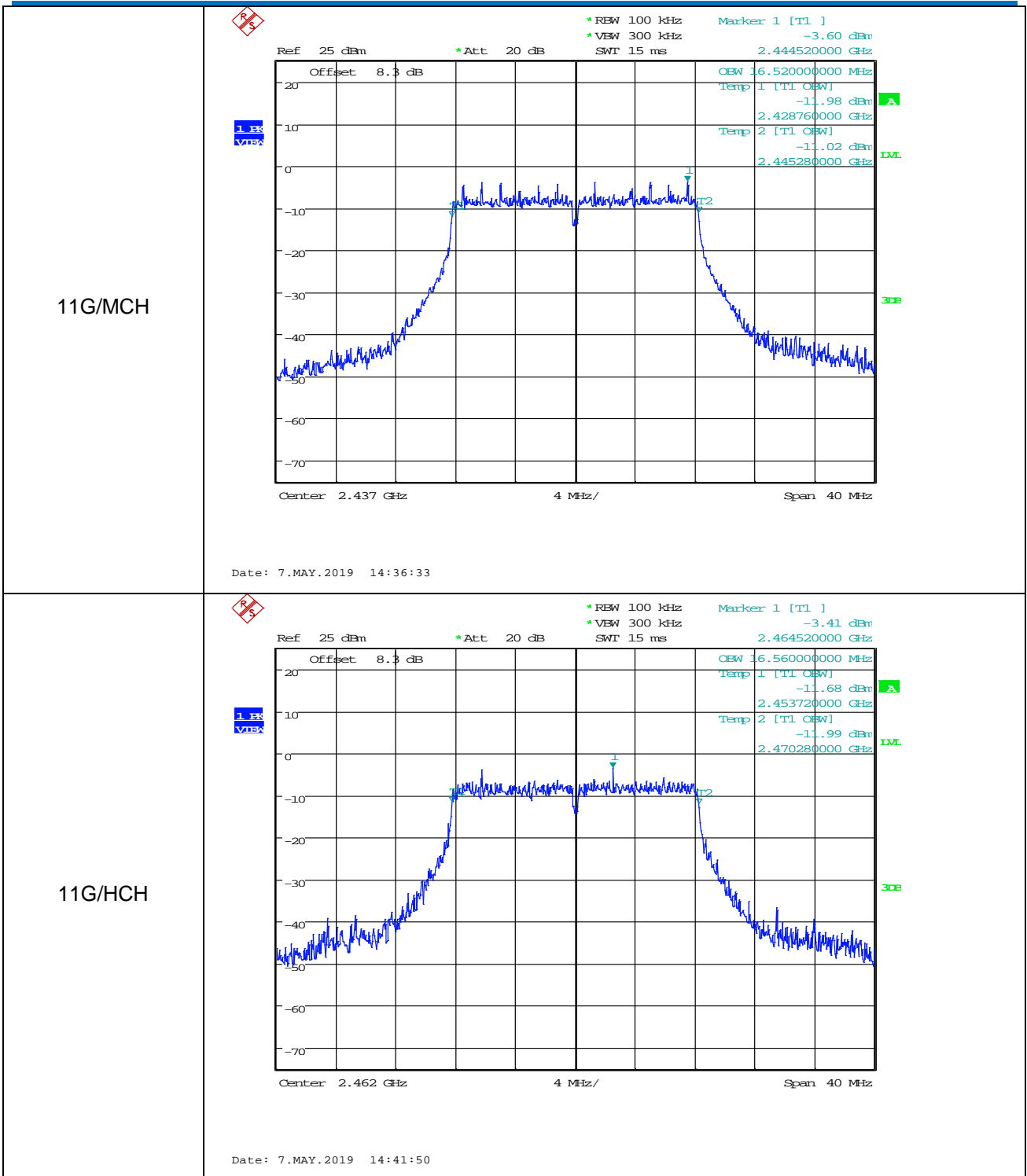

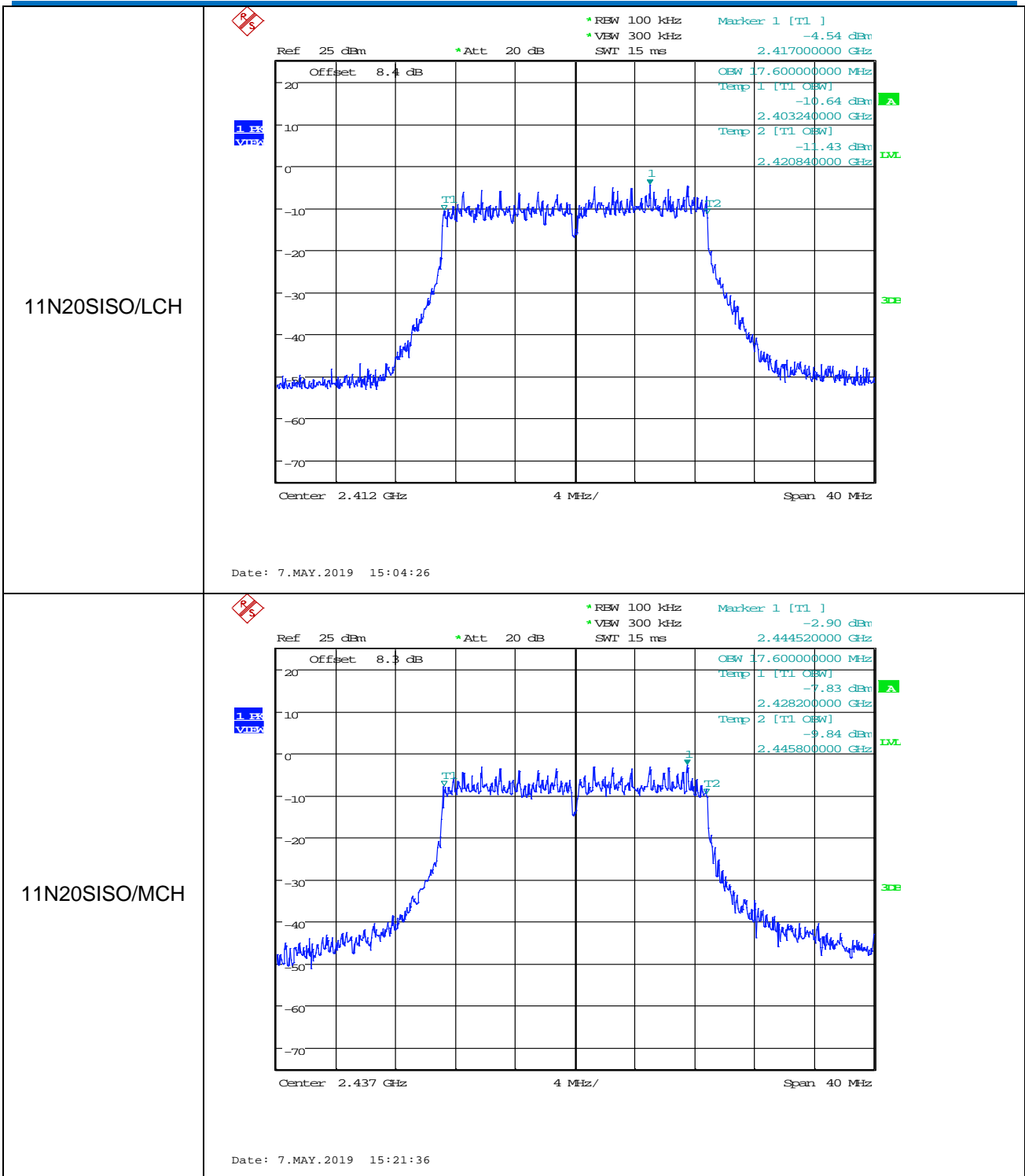

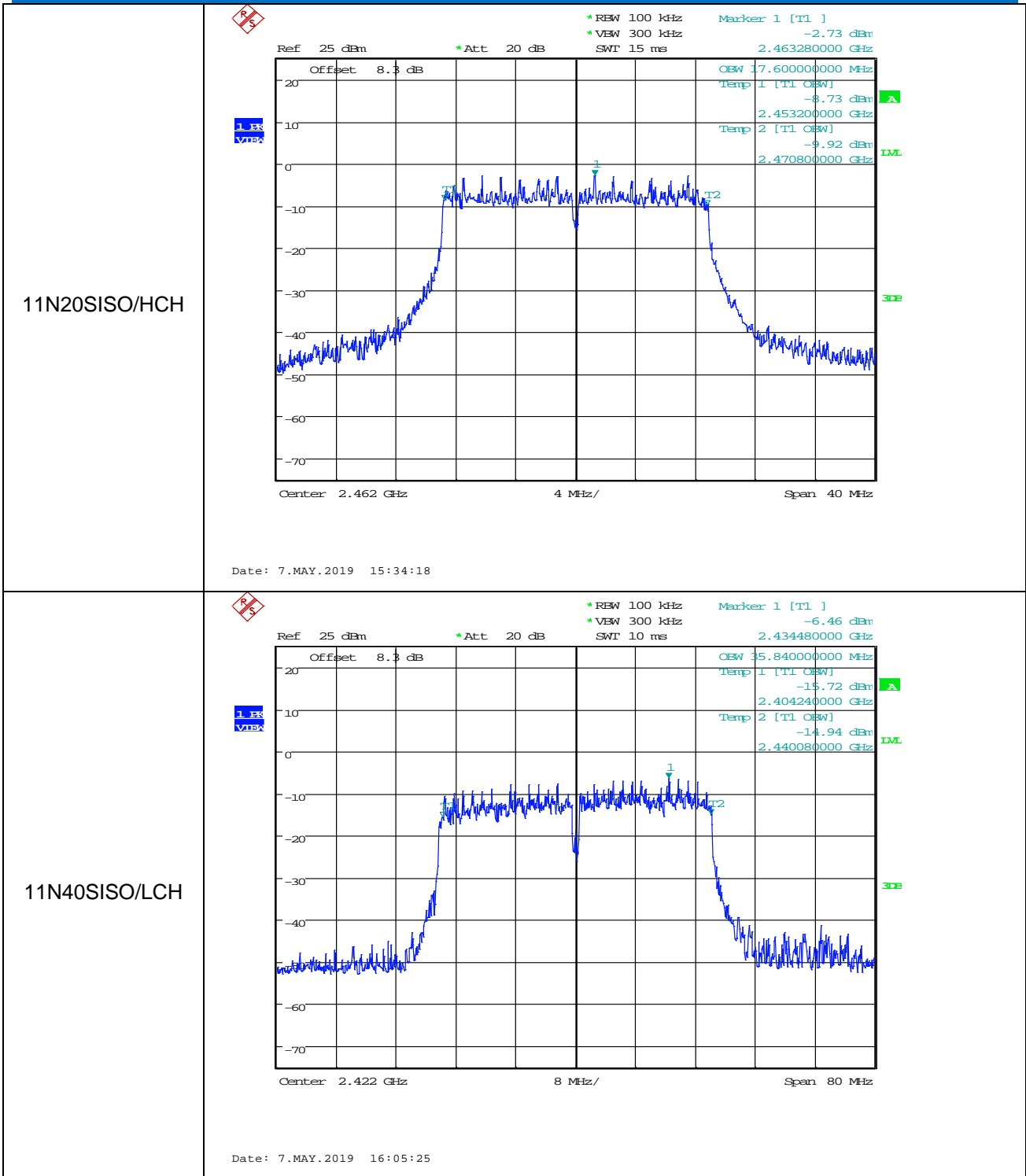

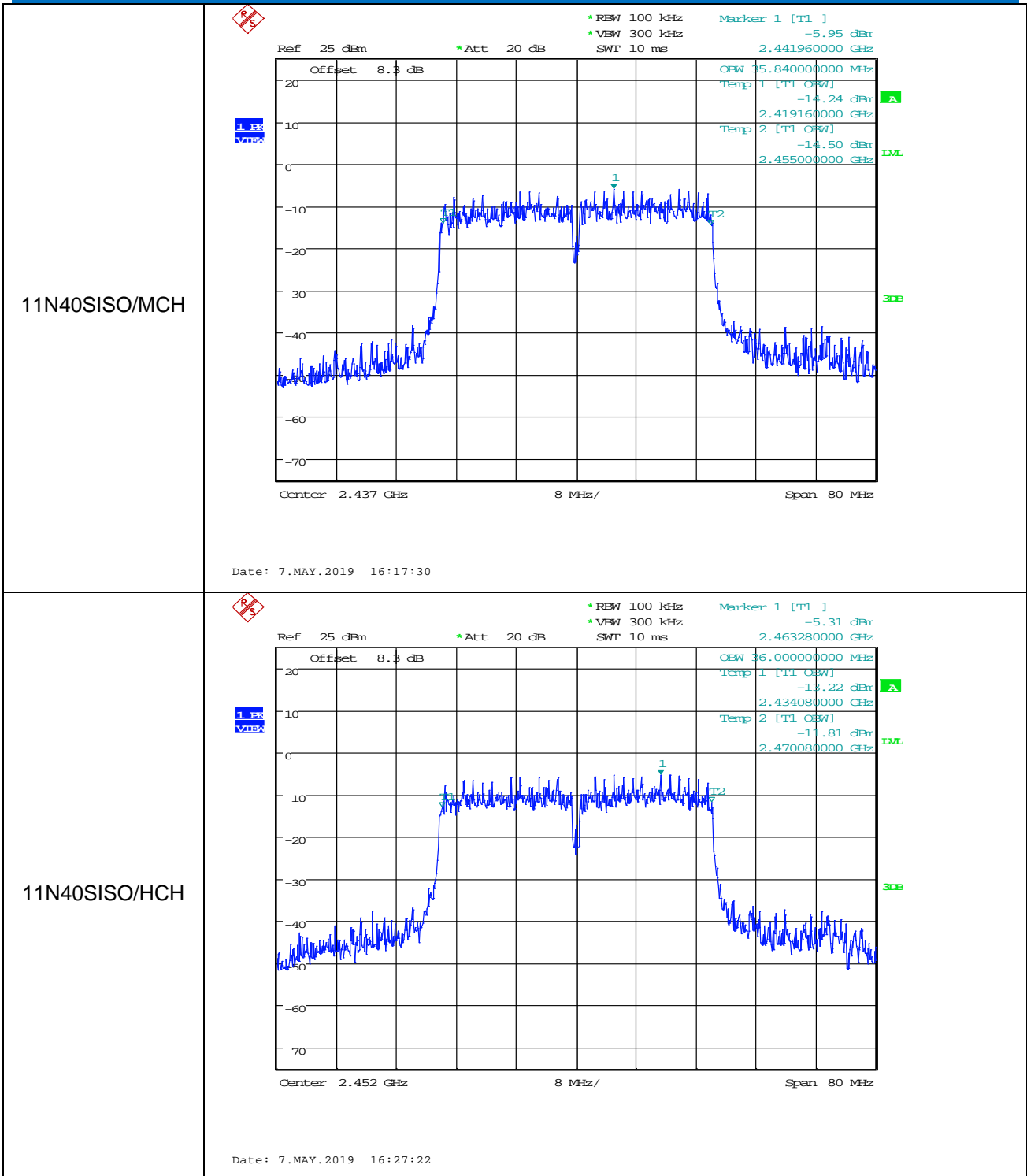

5.4 Power Spectral Density

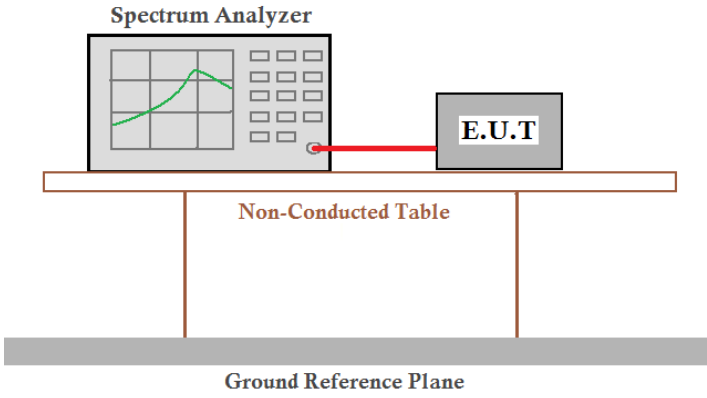
Test Requirement:	47 CFR Part 15C Section 15.247 (e)
Test Method:	ANSI C63.10: 2013
Test Setup:	 <p>Offset=cable loss+ attenuation factor</p>
Exploratory Test Mode:	Transmitting with all kind of modulations, data rates
Final Test Mode:	Through Pre-scan, find the 1Mbps of rate is the worst case of 802.11b; 6Mbps of rate is the worst case of 802.11g ; 6.5Mbps of rate is the worst case of 802.11n(HT20) ; 13.5Mbps of rate is the worst case of 802.11n(HT40) Only the worst case is recorded in the report.
Limit:	≤8.00dBm/3kHz
Test Results:	Pass

Measurement Data

802.11b mode			
Test channel	Power Spectral Density (dBm/3kHz)	Limit (dBm/3kHz)	Result
Lowest	-15.560	≤8.00	Pass
Middle	-16.330	≤8.00	Pass
Highest	-14.920	≤8.00	Pass
802.11g mode			
Test channel	Power Spectral Density (dBm/3kHz)	Limit (dBm/3kHz)	Result
Lowest	-19.790	≤8.00	Pass
Middle	-18.650	≤8.00	Pass
Highest	-18.010	≤8.00	Pass
802.11n(HT20) mode			
Test channel	Power Spectral Density (dBm/3kHz)	Limit (dBm/3kHz)	Result
Lowest	-20.080	≤8.00	Pass
Middle	-19.380	≤8.00	Pass
Highest	-18.600	≤8.00	Pass
802.11n(HT40) mode			
Test channel	Power Spectral Density (dBm/3kHz)	Limit (dBm/3kHz)	Result
Lowest	-21.990	≤8.00	Pass
Middle	-22.580	≤8.00	Pass
Highest	-23.630	≤8.00	Pass

Test plot as follows:

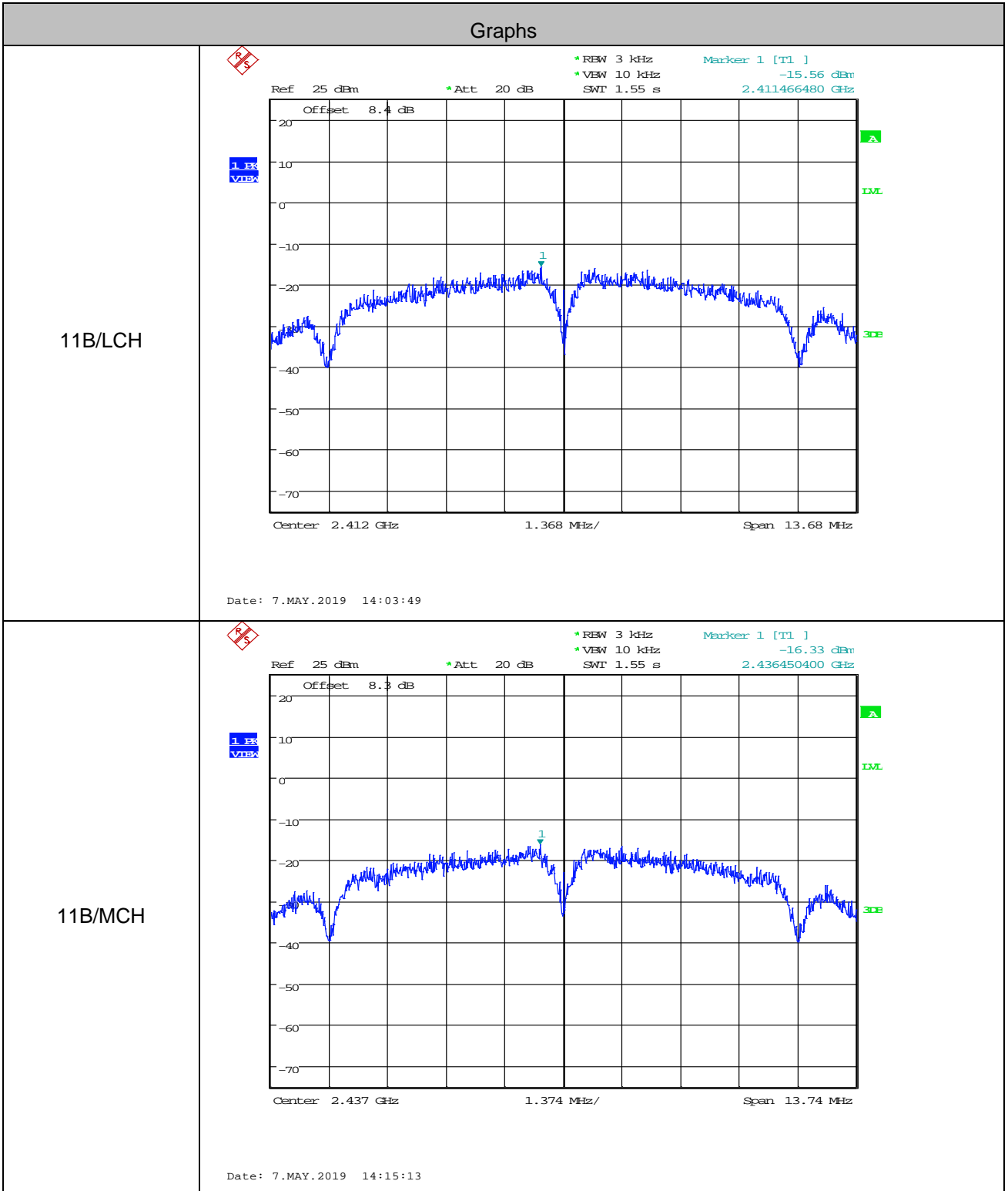

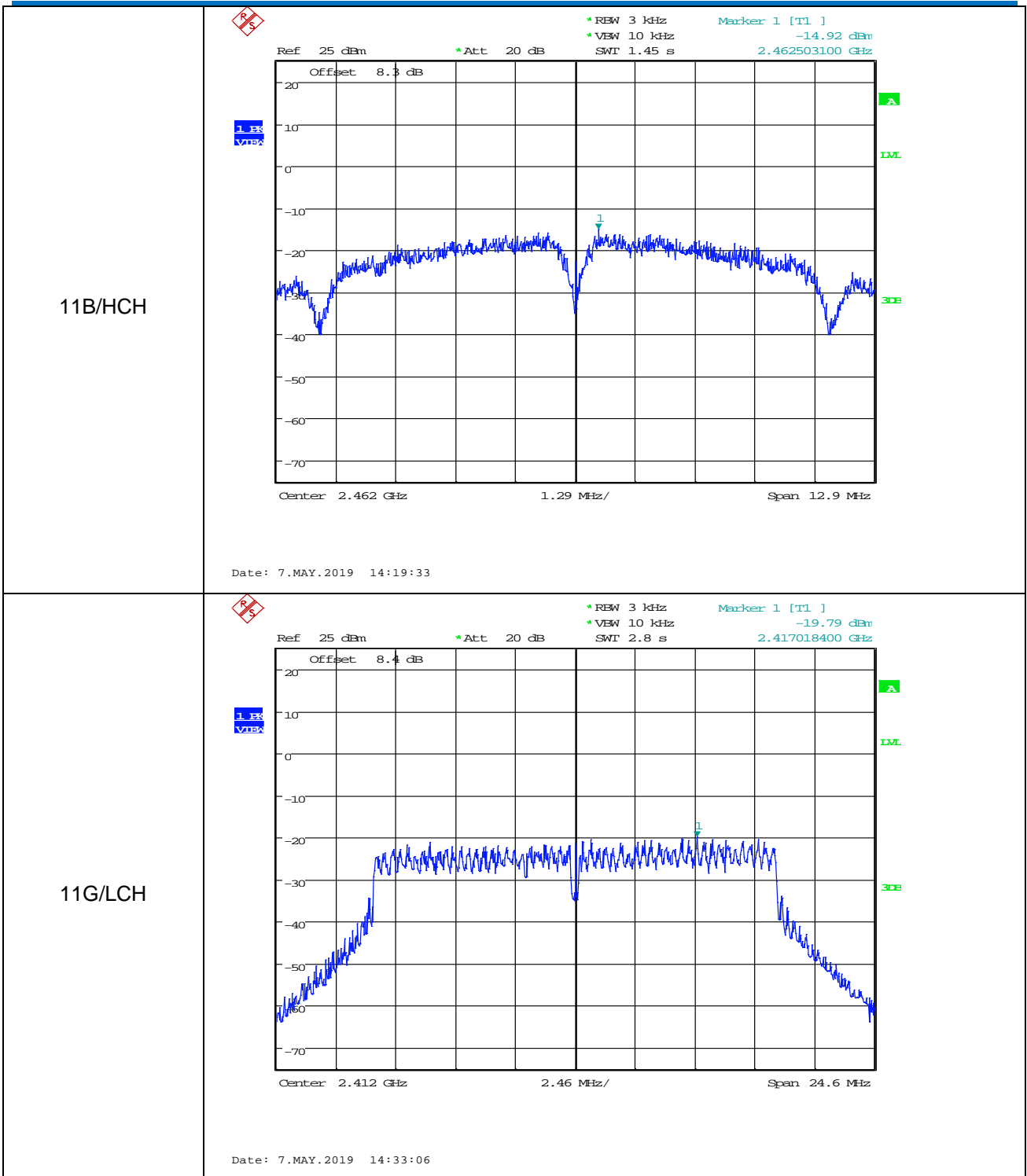

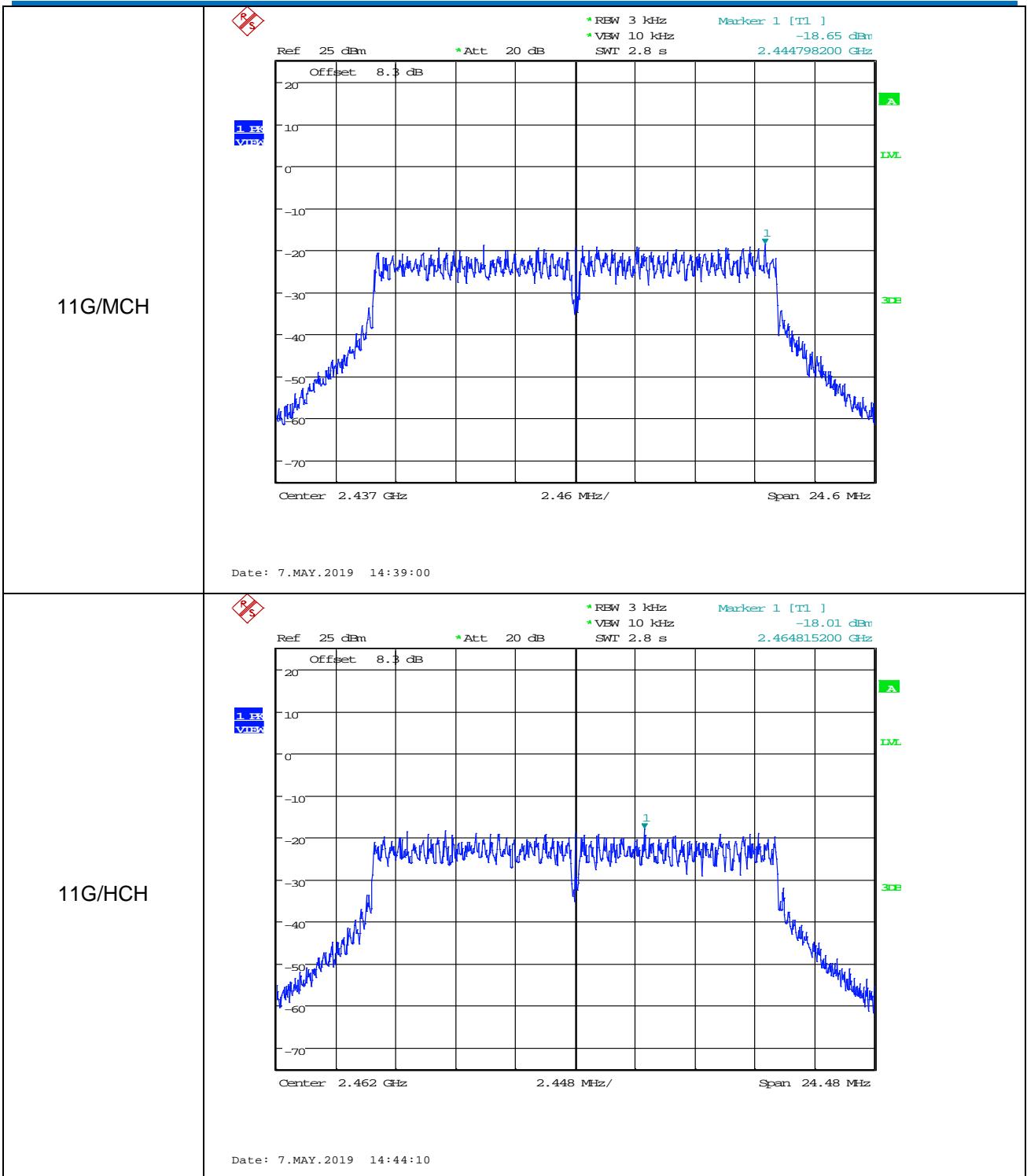

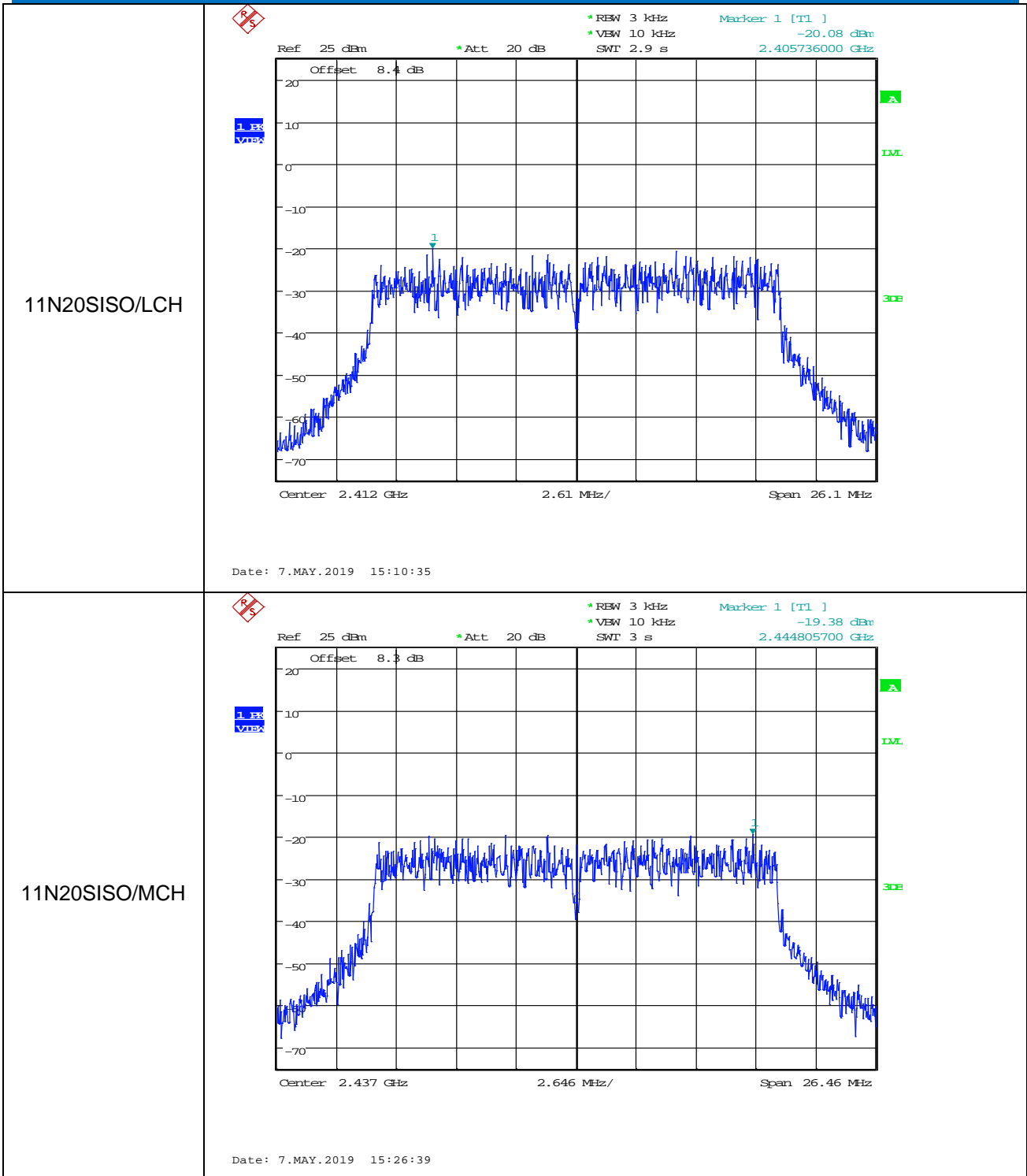

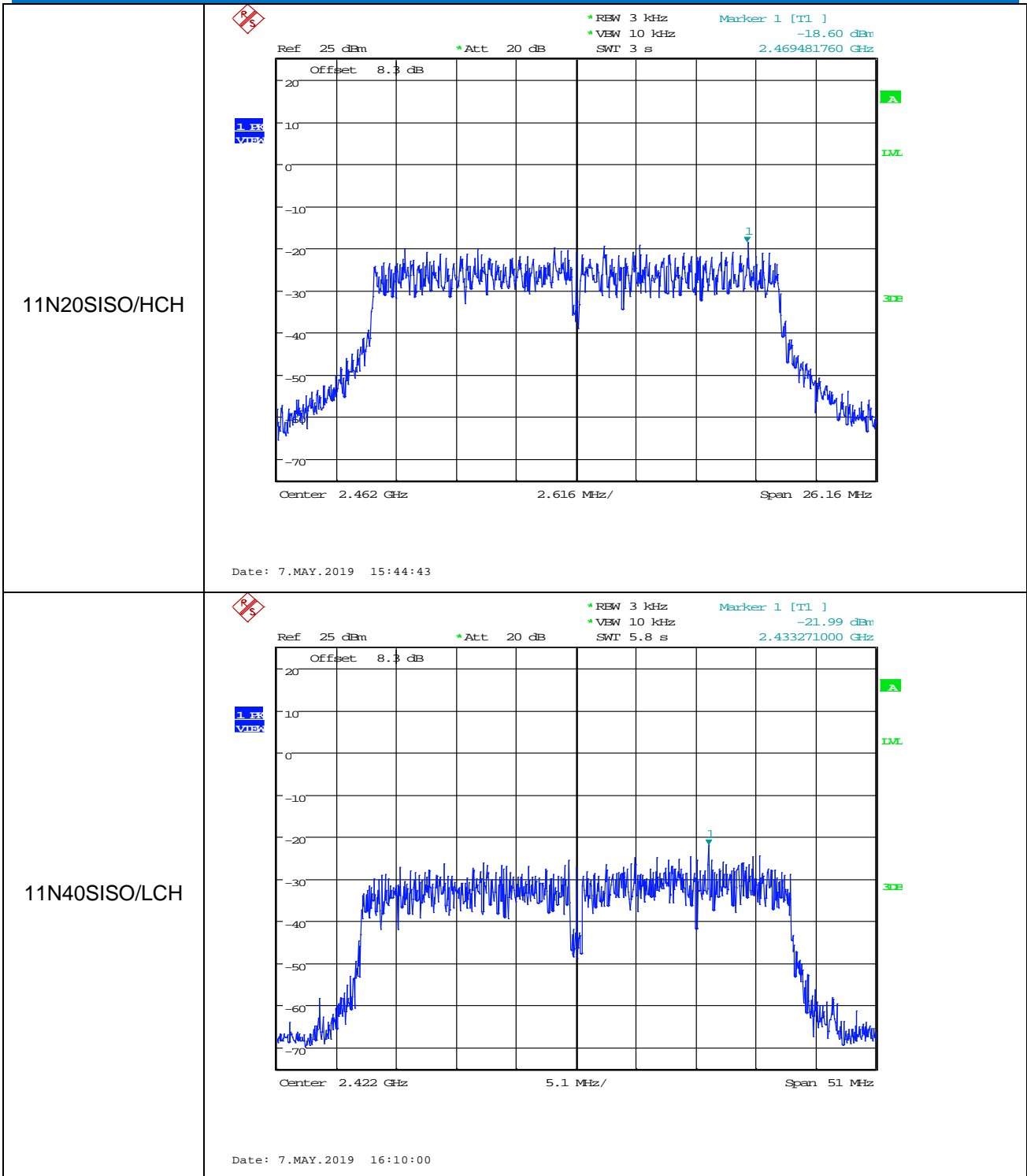

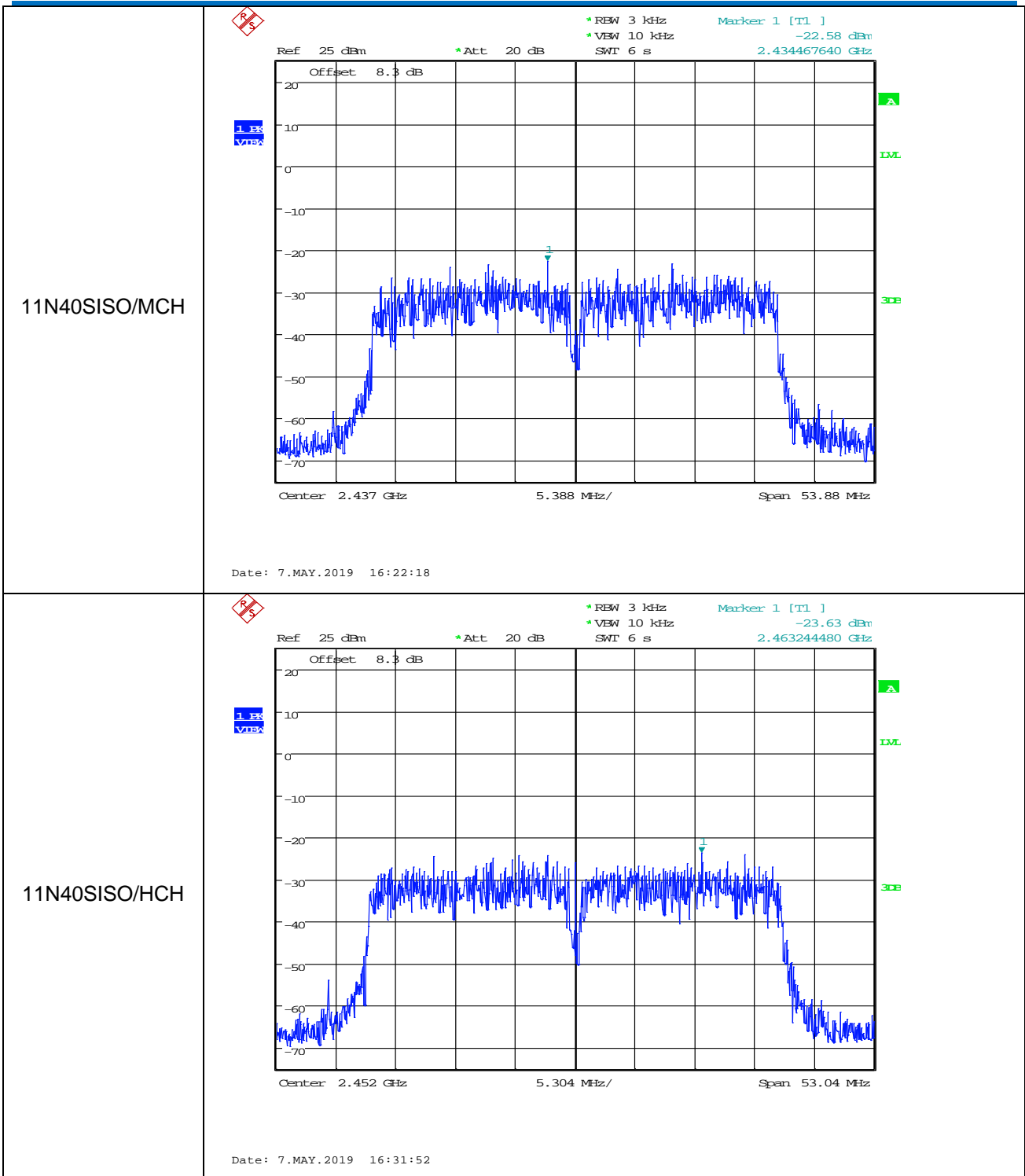

5.5 Band-edge for RF Conducted Emissions

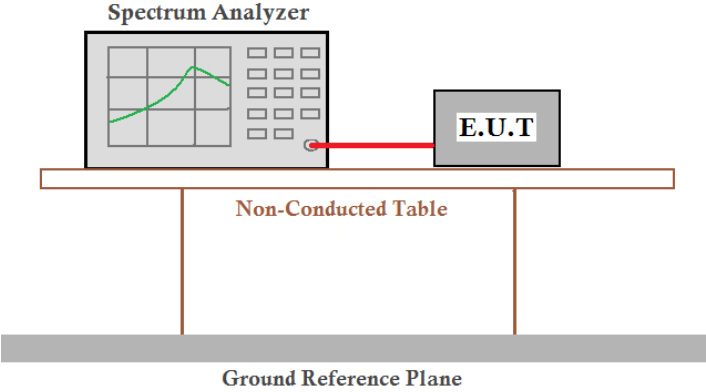
Test Requirement:	47 CFR Part 15C Section 15.247 (d)
Test Method:	ANSI C63.10: 2013
Test Setup:	 <p>Offset=cable loss+ attenuation factor</p>
Exploratory Test Mode:	Transmitting with all kind of modulations, data rates
Final Test Mode:	Through Pre-scan, find the 1Mbps of rate is the worst case of 802.11b; 6Mbps of rate is the worst case of 802.11g ; 6.5Mbps of rate is the worst case of 802.11n(HT20) ; 13.5Mbps of rate is the worst case of 802.11n(HT40) Only the worst case is recorded in the report.
Limit:	In any 100 kHz bandwidth outside the frequency band in which the spread spectrum intentional radiator is operating, the radio frequency power that is produced by the intentional radiator shall be at least 20 dB below that in the 100 kHz bandwidth within the band that contains the highest level of the desired power, based on either an RF conducted or a radiated measurement.
Test Results:	Pass

Test Data:

Test mode: 802.11b				
Test channel	Frequency(MHz)	Emission Level(dBm)	Limit(dBm)	Result
Lowest	2400	-37.720	-20.98	Pass
Highest	2483.5	-53.000	-20.6	Pass
Test mode: 802.11g				
Test channel	Frequency(MHz)	Emission Level(dBm)	Limit(dBm)	Result
Lowest	2400	-38.110	-26.46	Pass
Highest	2483.5	-51.620	-23.57	Pass
Test mode: 802.11n(HT20)				
Test channel	Frequency(MHz)	Emission Level(dBm)	Limit(dBm)	Result
Lowest	2400	-36.930	-24.42	Pass
Highest	2483.5	-48.480	-24.2	Pass
Test mode: 802.11n(HT40)				
Test channel	Frequency(MHz)	Emission Level(dBm)	Limit(dBm)	Result
Lowest	2400	-38.330	-26.2	Pass
Highest	2483.5	-47.660	-25.67	Pass

Test plot as follows:

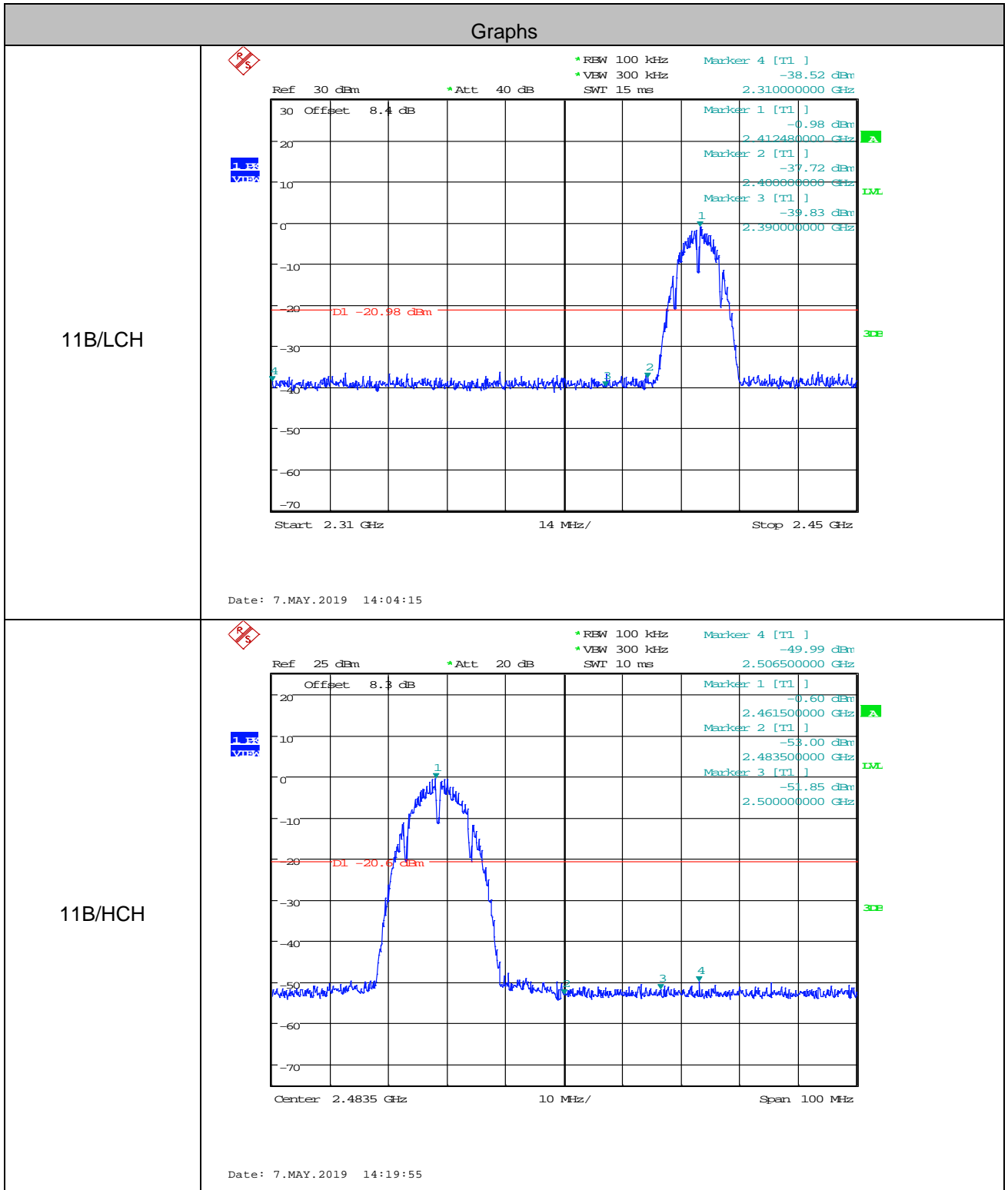

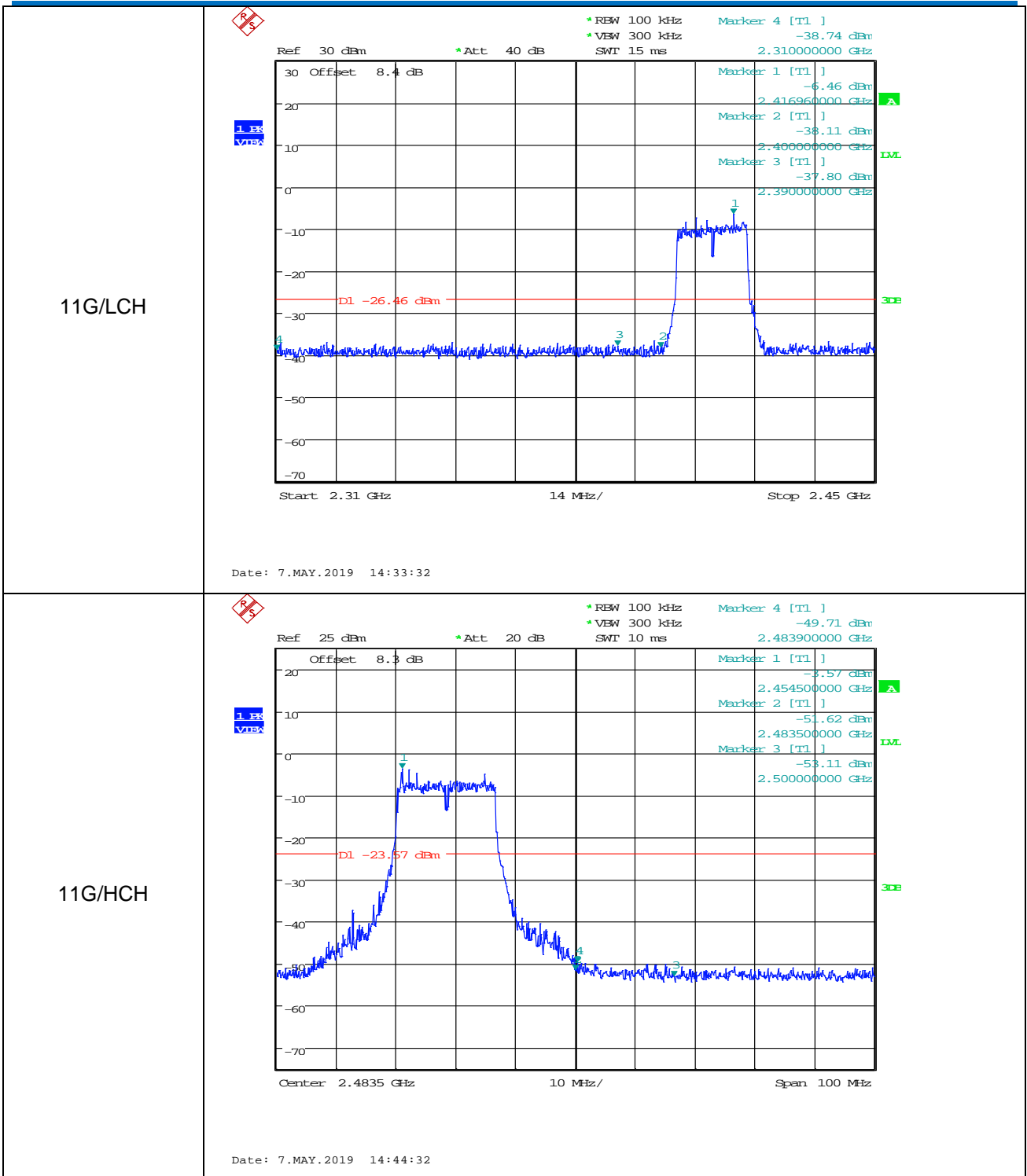

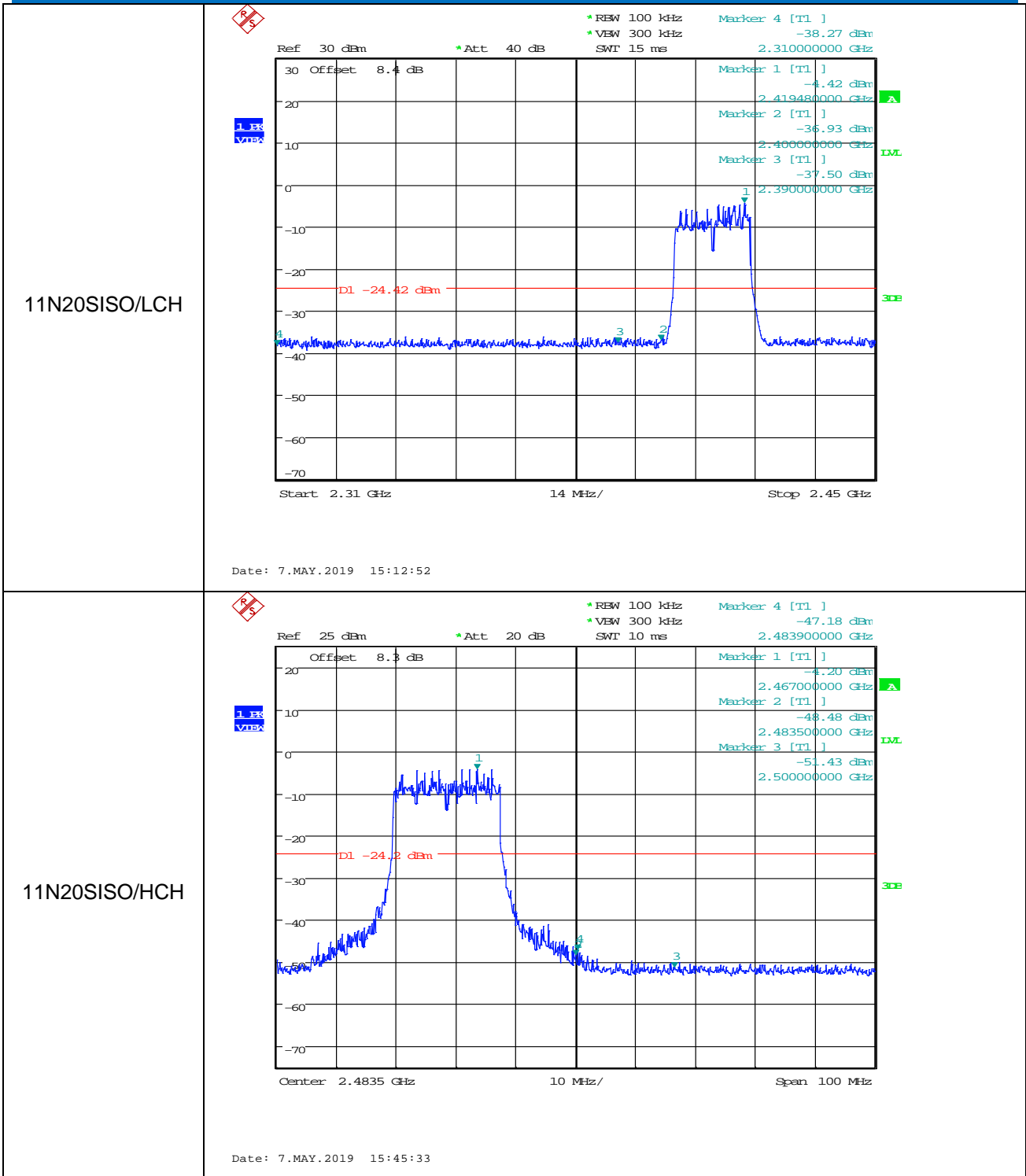

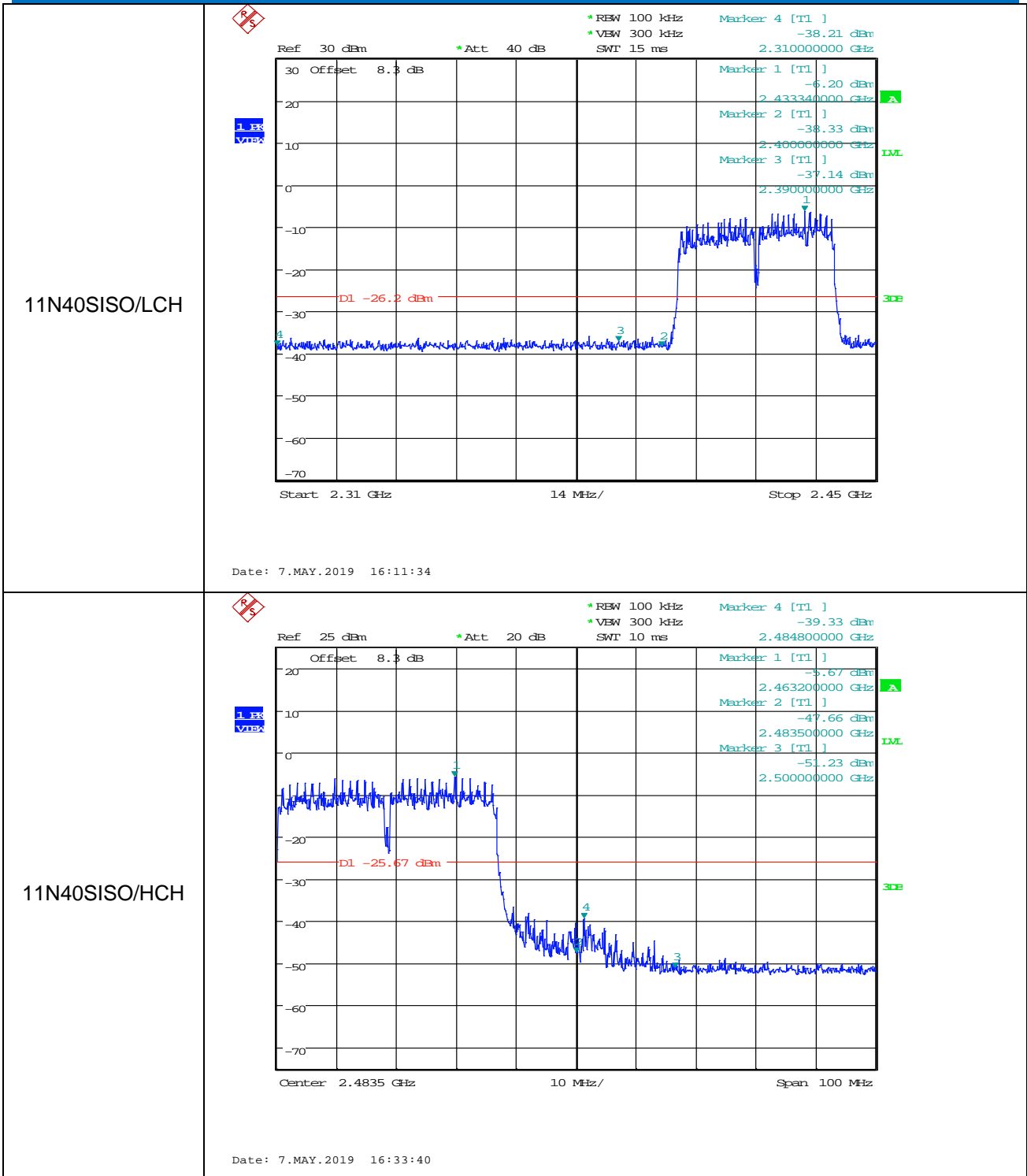

5.6 RF Conducted Spurious Emissions

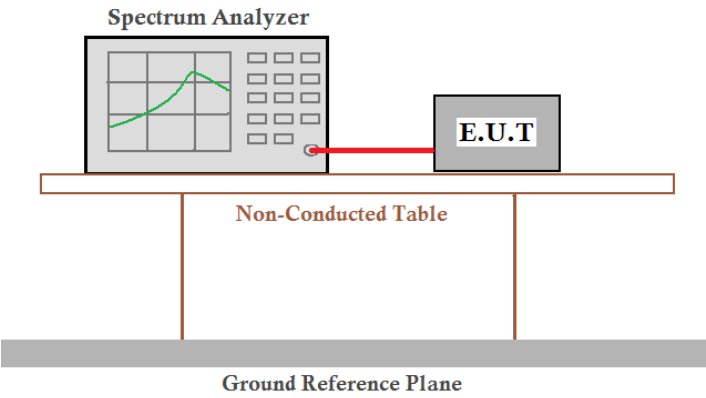
Test Requirement:	47 CFR Part 15C Section 15.247 (d)
Test Method:	ANSI C63.10: 2013
Test Setup:	 <p>The diagram illustrates the test setup for RF conducted spurious emissions. A Spectrum Analyzer is connected to an E.U.T. (Equipment Under Test) via a red cable. Both are placed on a Non-Conducted Table, which is supported by two vertical legs. Below the table is a Ground Reference Plane, represented by a thick grey bar.</p>
	Offset=cable loss+ attenuation factor
Exploratory Test Mode:	Transmitting with all kind of modulations, data rates
Final Test Mode:	Through Pre-scan, find the 1Mbps of rate is the worst case of 802.11b; 6Mbps of rate is the worst case of 802.11g ; 6.5Mbps of rate is the worst case of 802.11n(HT20) ; 13.5Mbps of rate is the worst case of 802.11n(HT40) Only the worst case is recorded in the report.
Limit:	In any 100 kHz bandwidth outside the frequency band in which the spread spectrum intentional radiator is operating, the radio frequency power that is produced by the intentional radiator shall be at least 20 dB below that in the 100 kHz bandwidth within the band that contains the highest level of the desired power, based on either an RF conducted or a radiated measurement.
Test Results:	Pass

Test plot as follows:

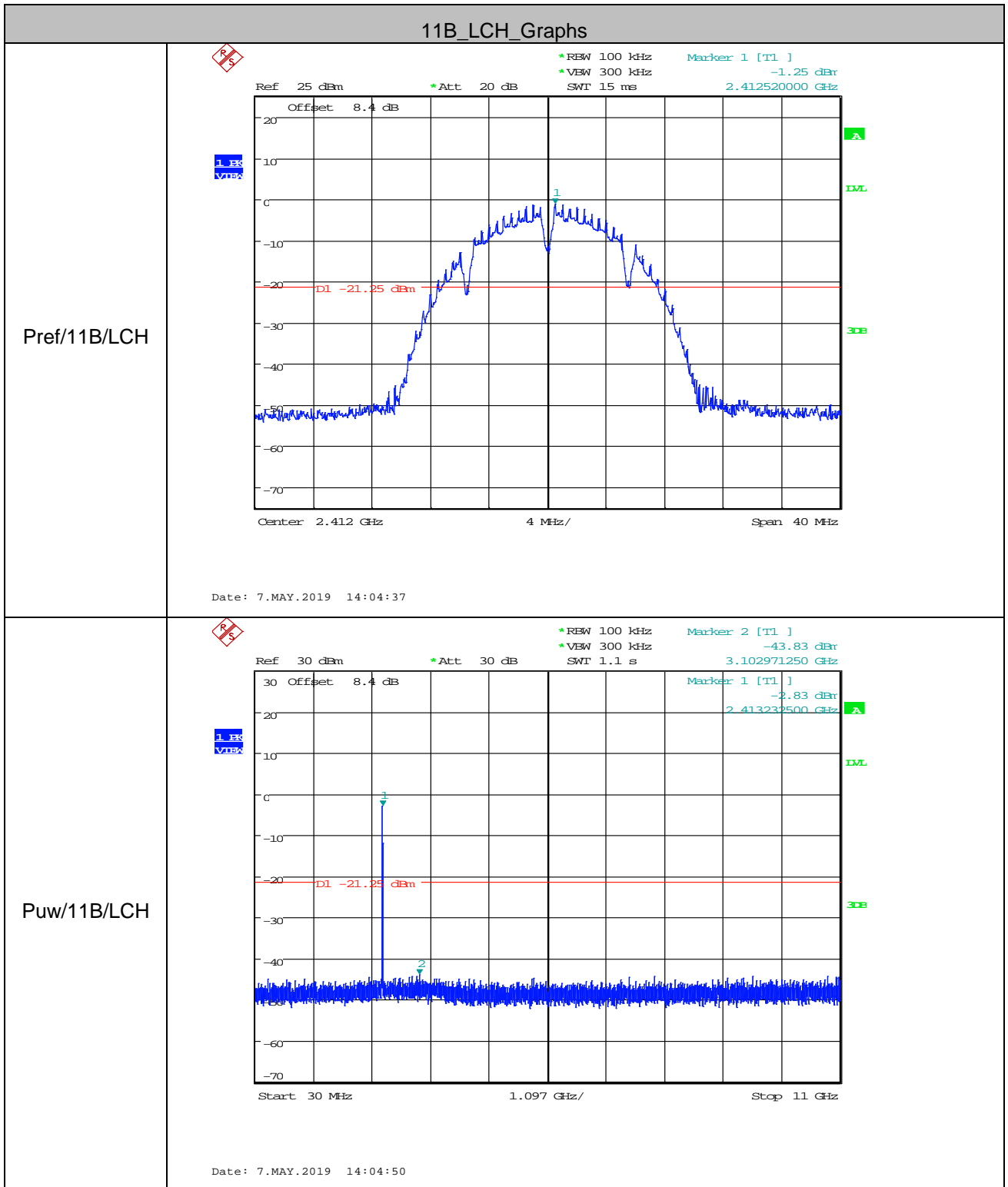

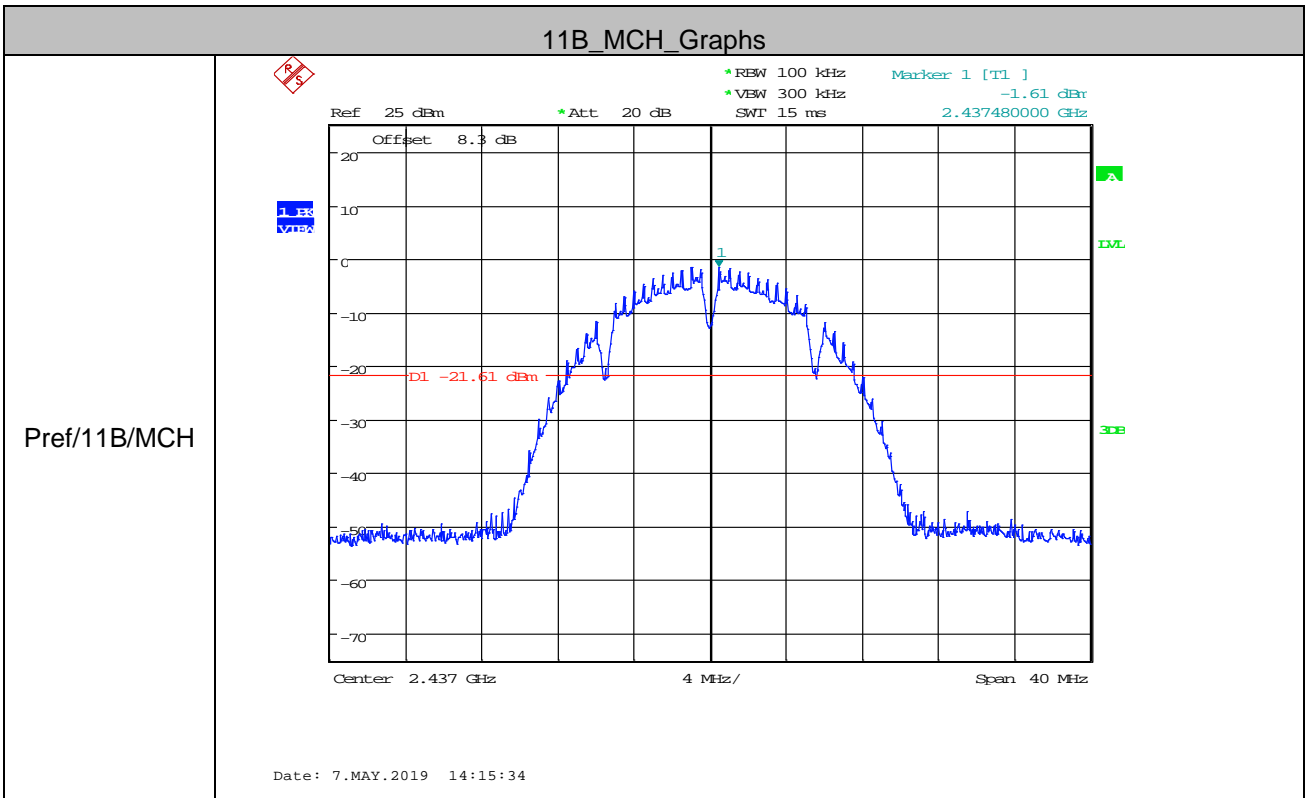
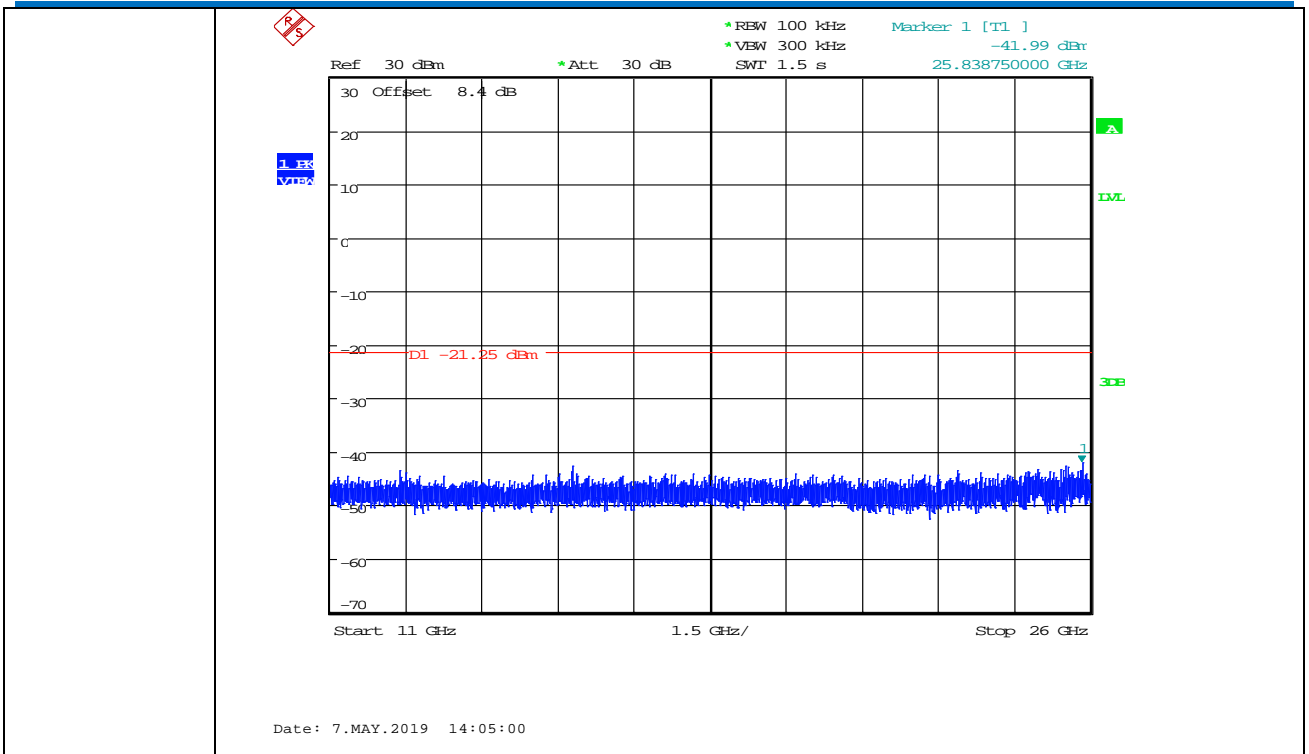

Pref/11B/MCH

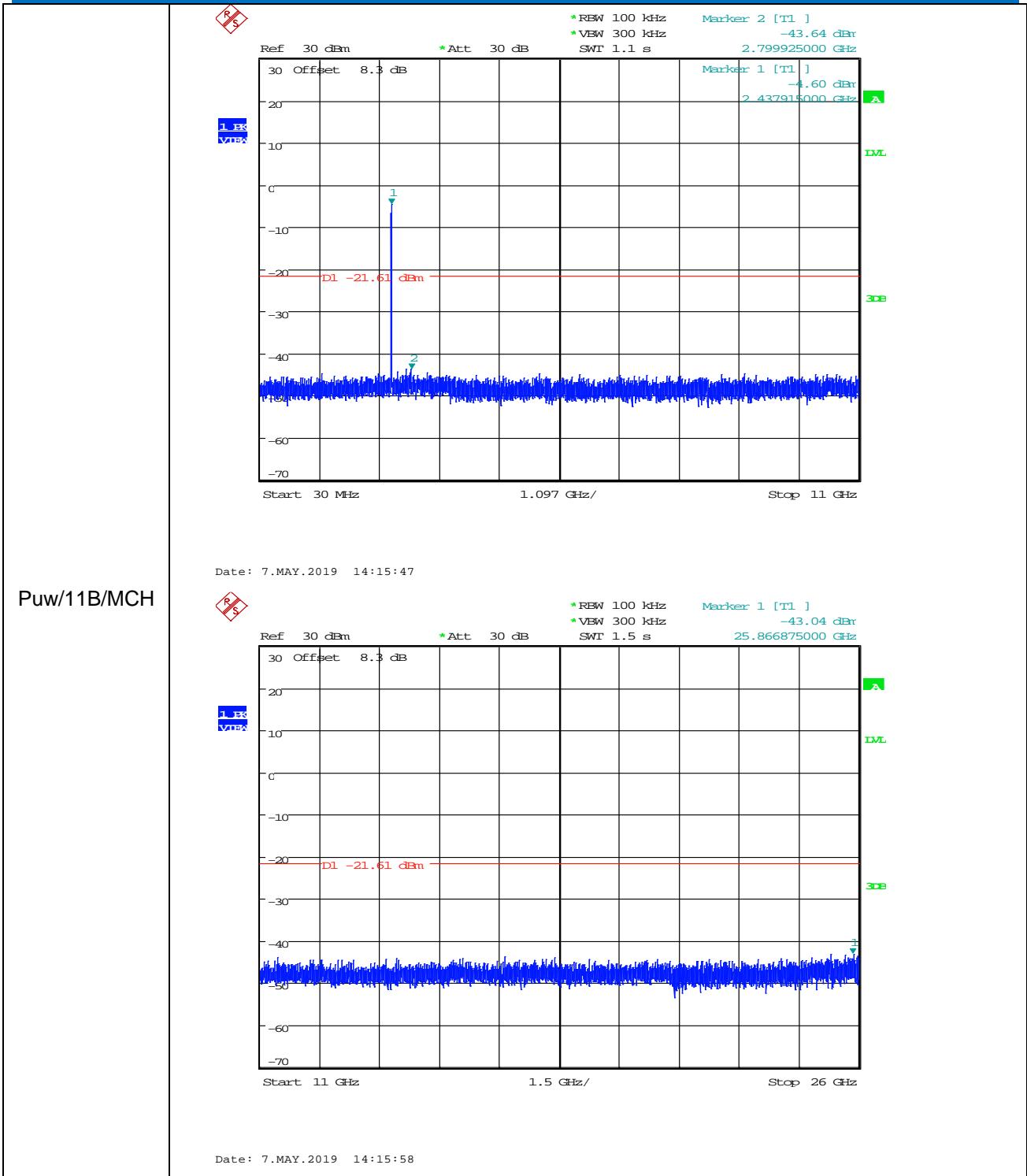

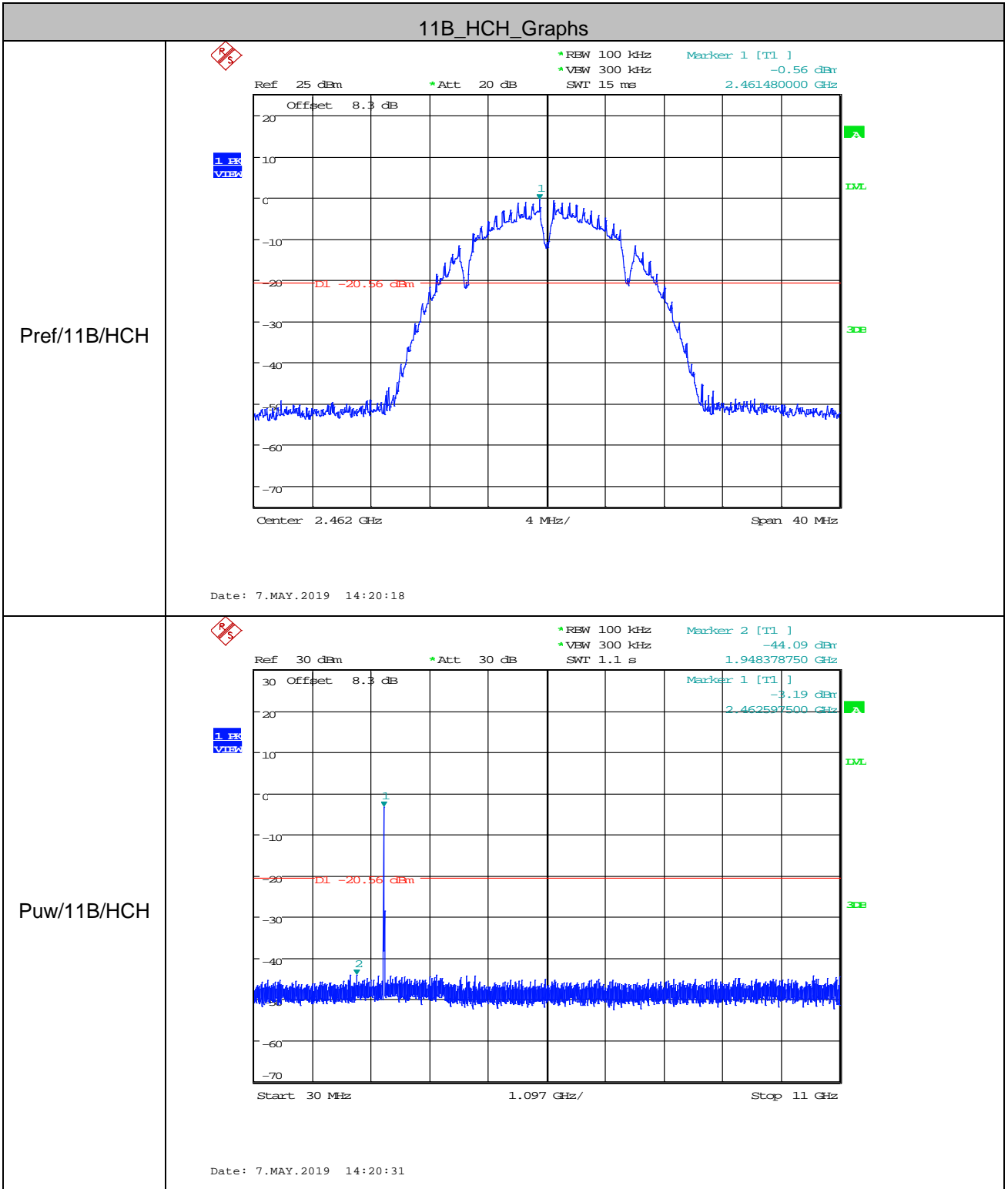

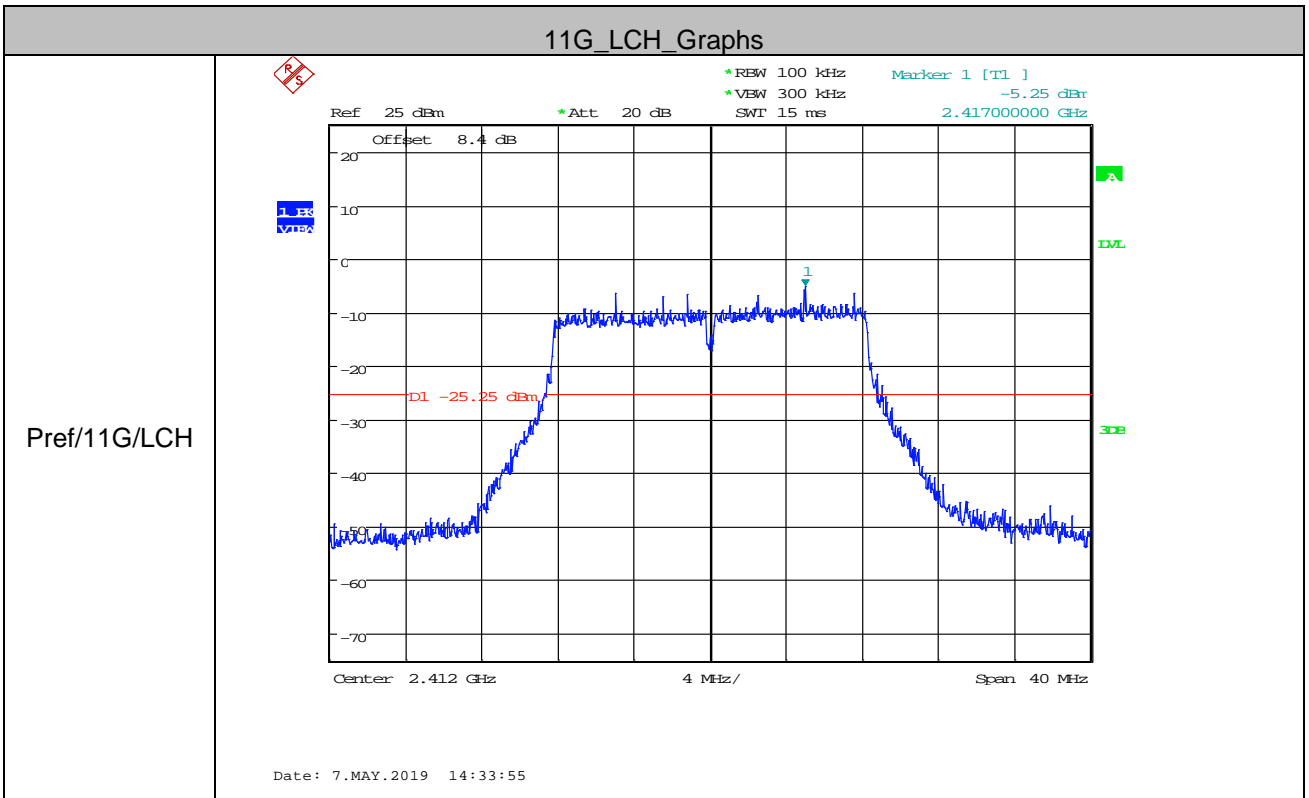
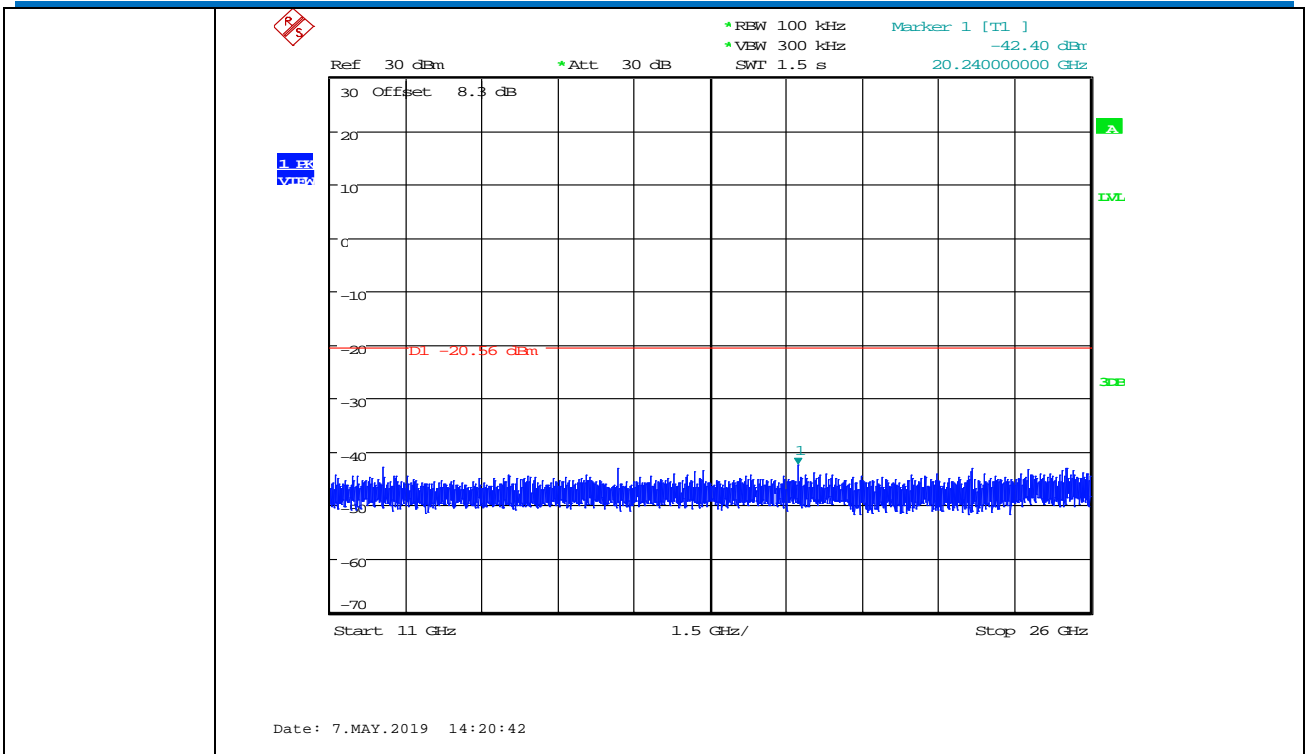

Pref/11G/LCH

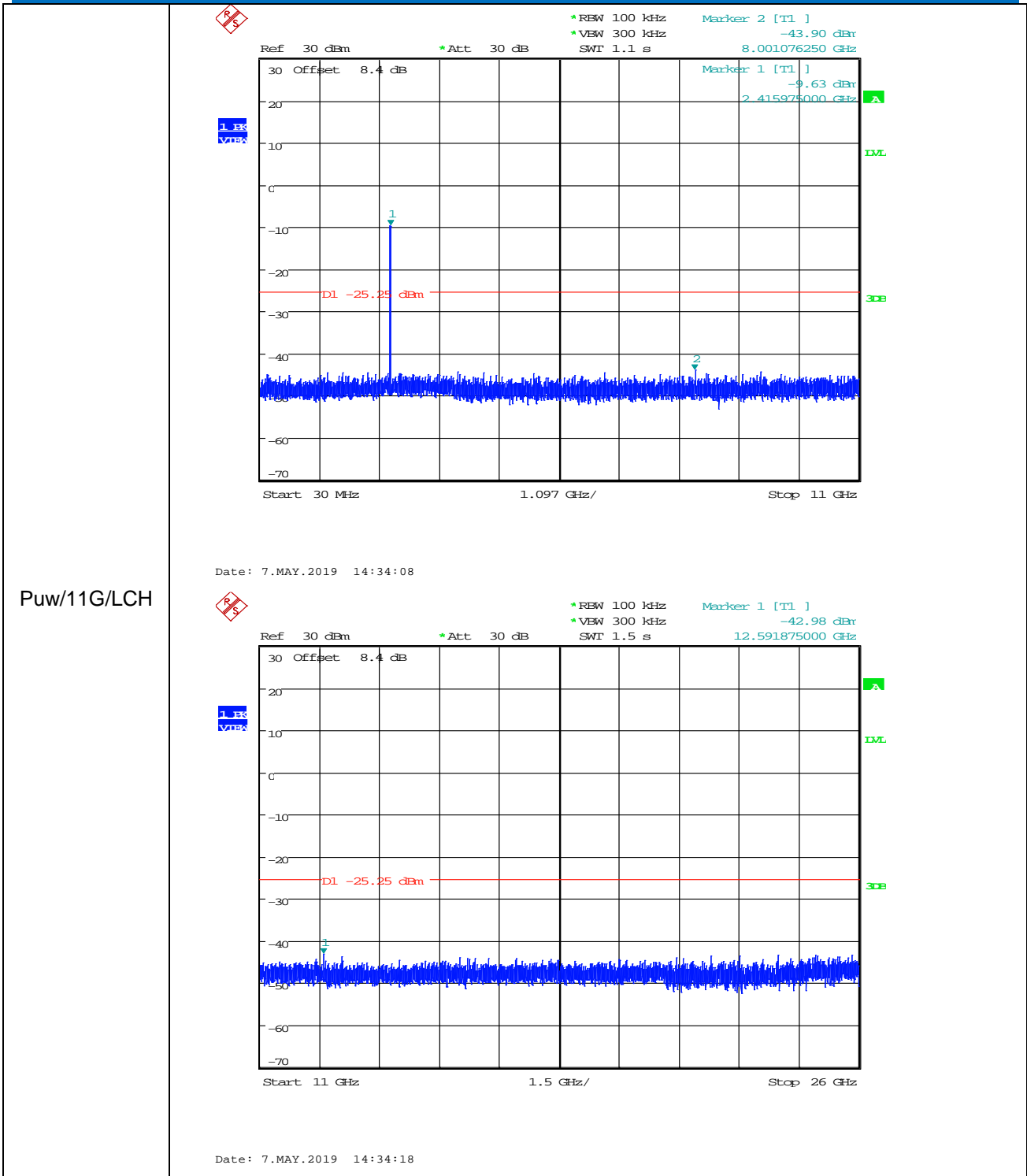

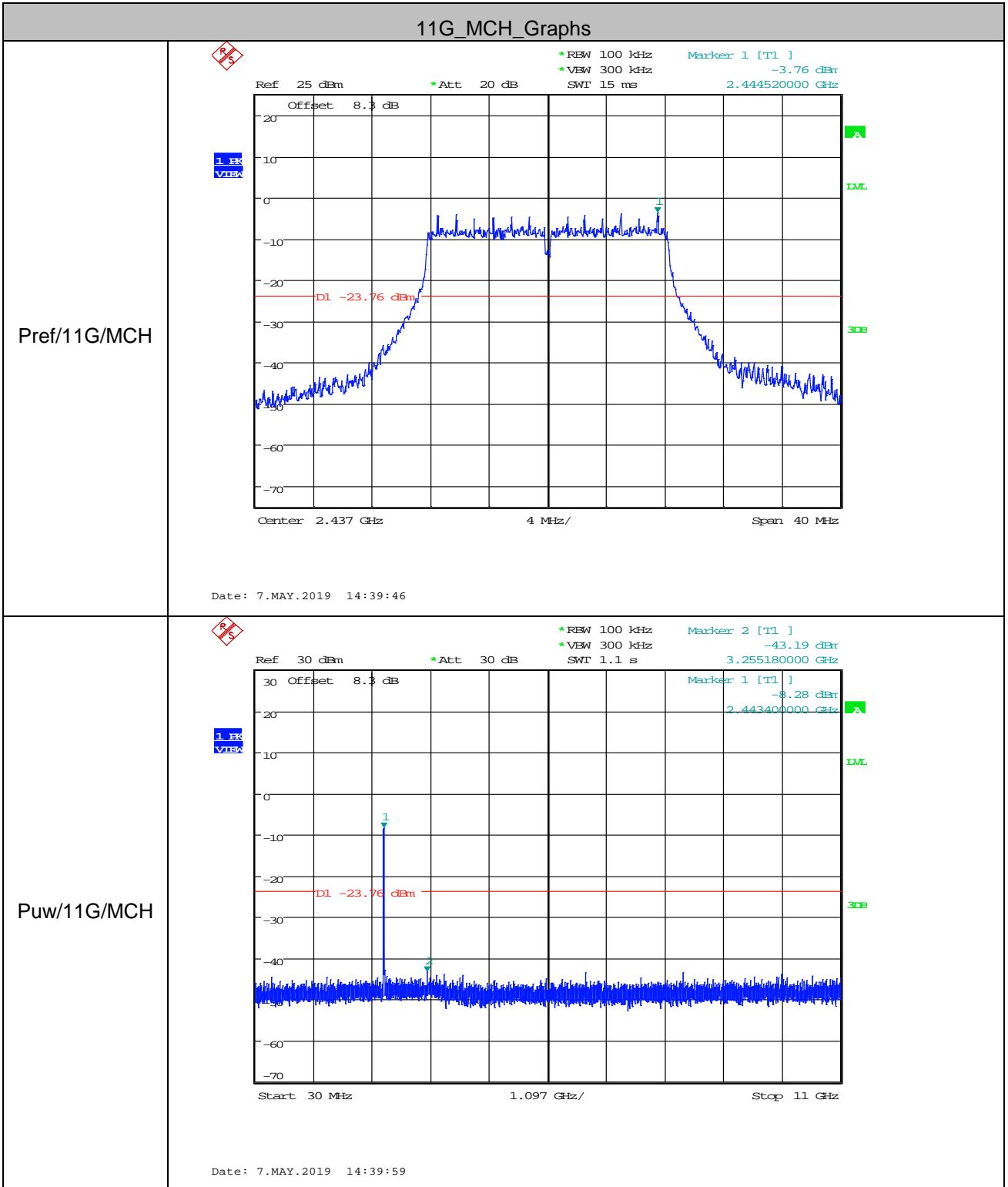

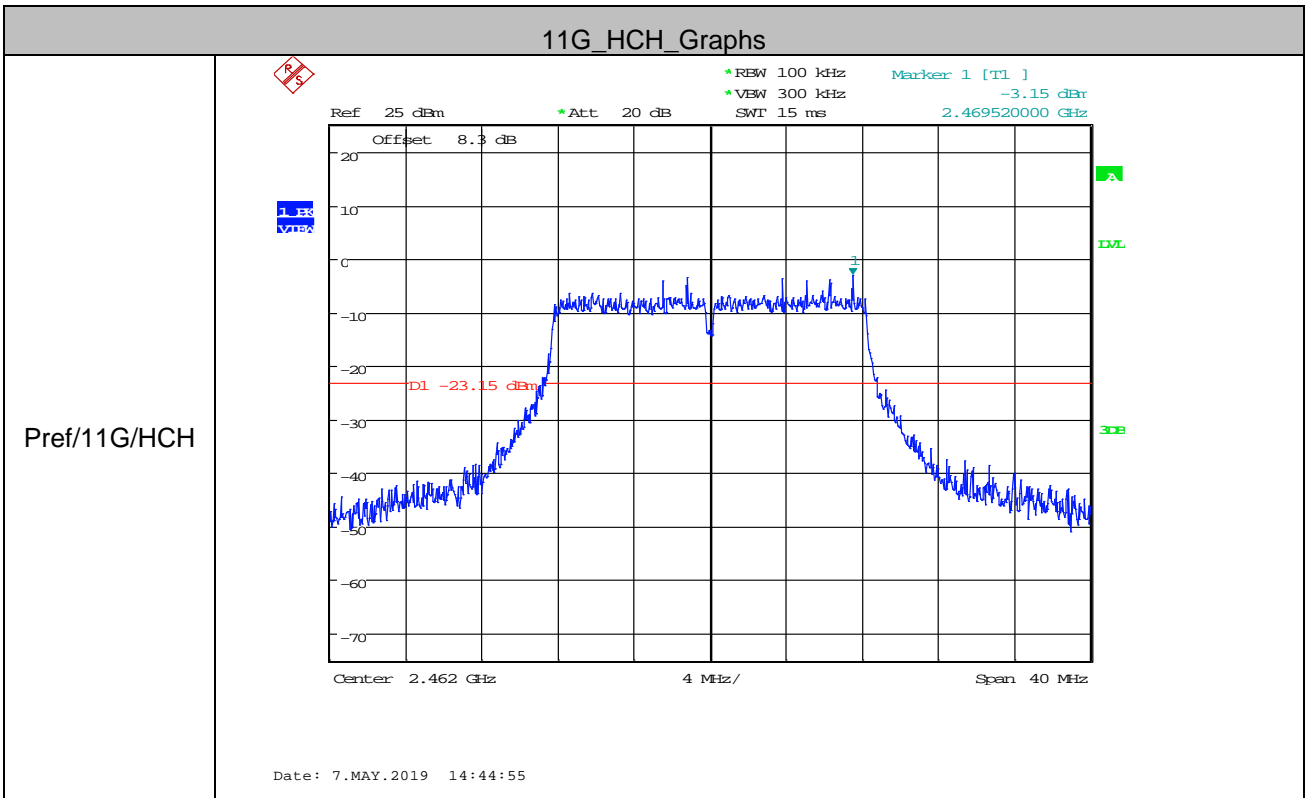
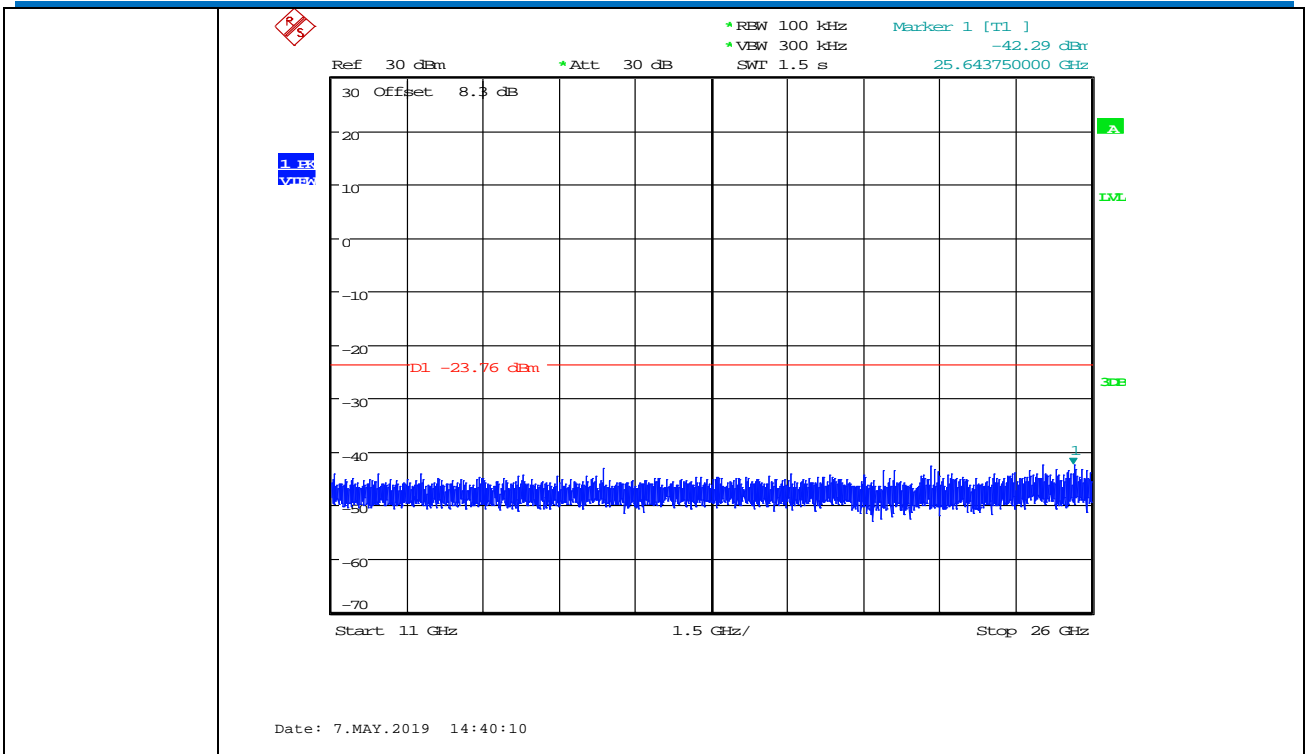

Pref/11G/HCH

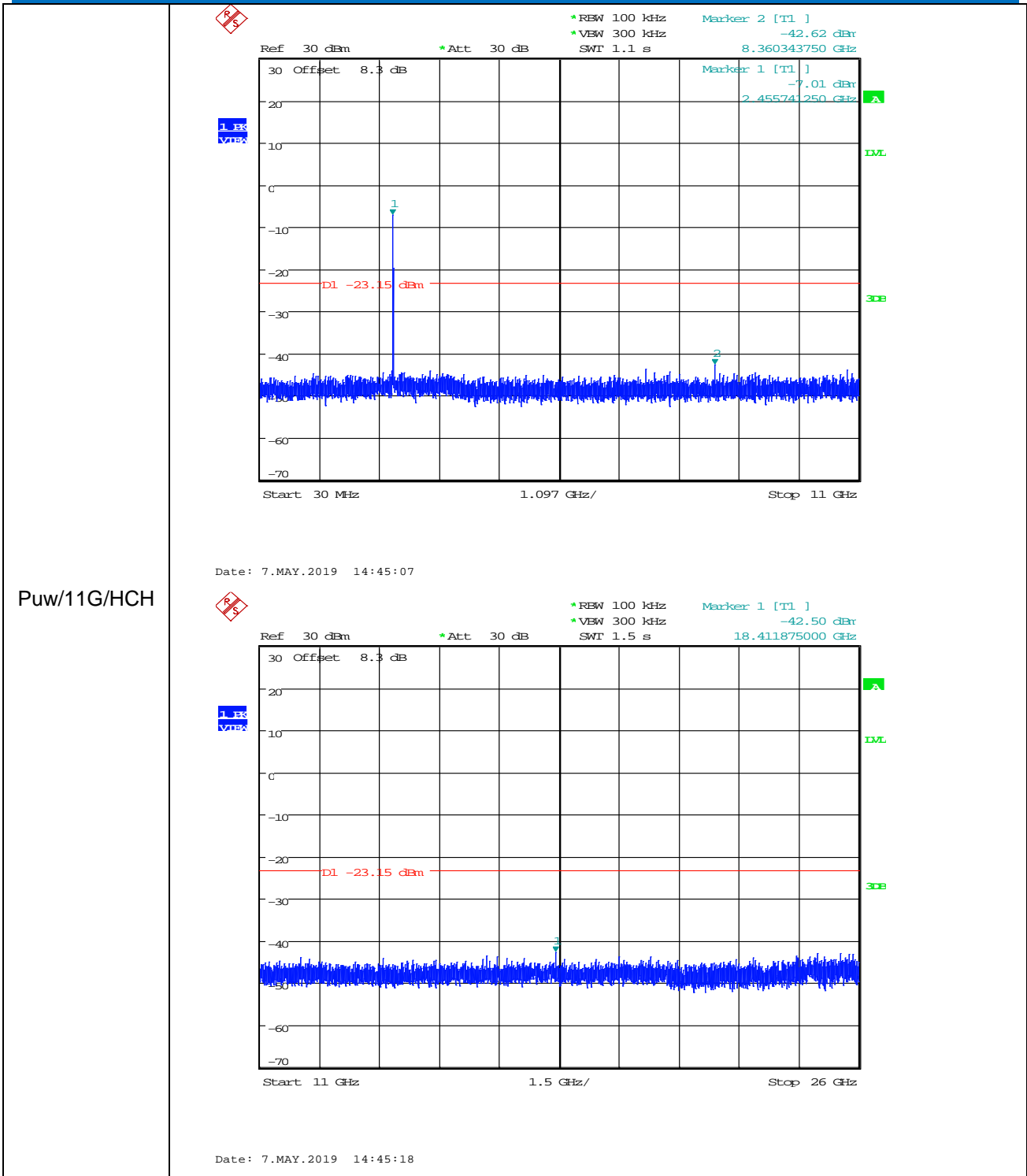

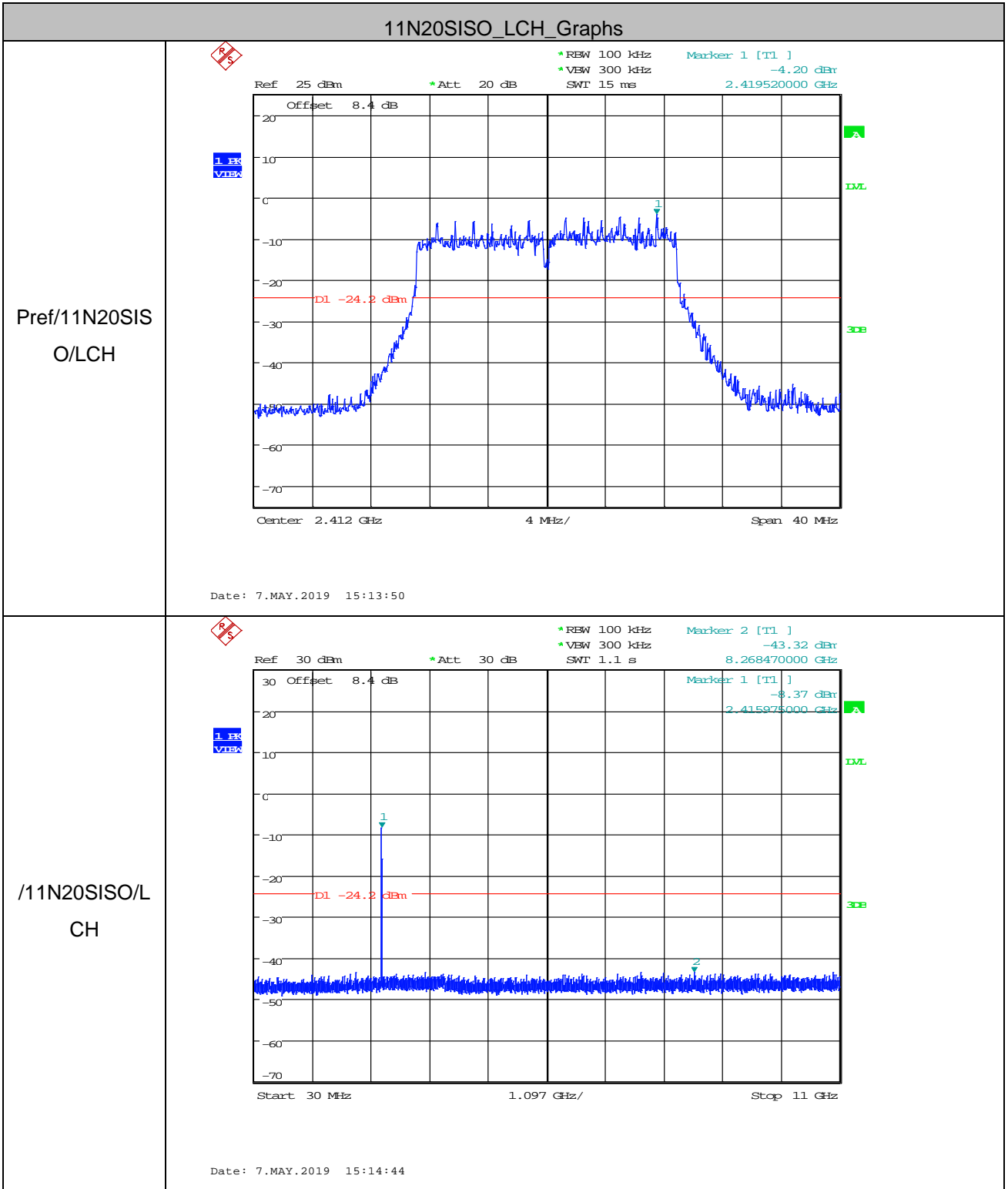

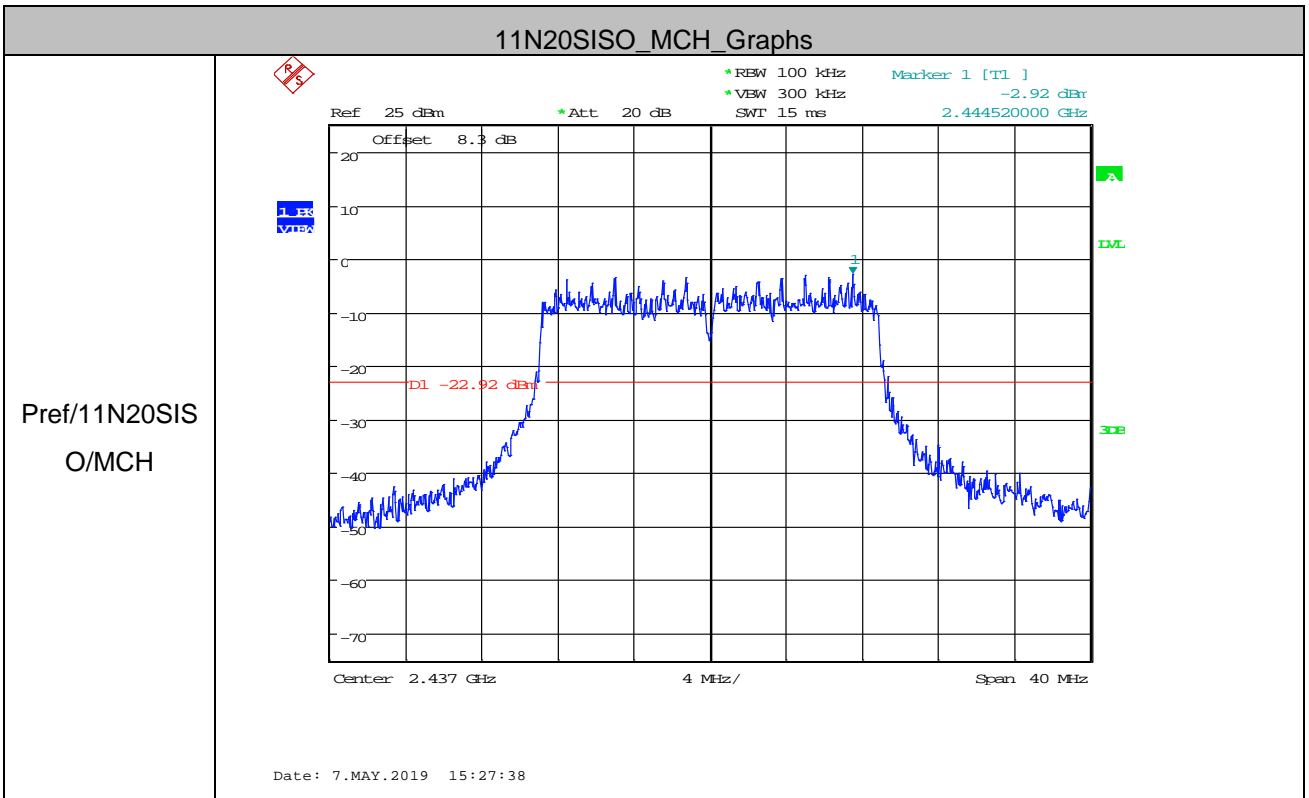
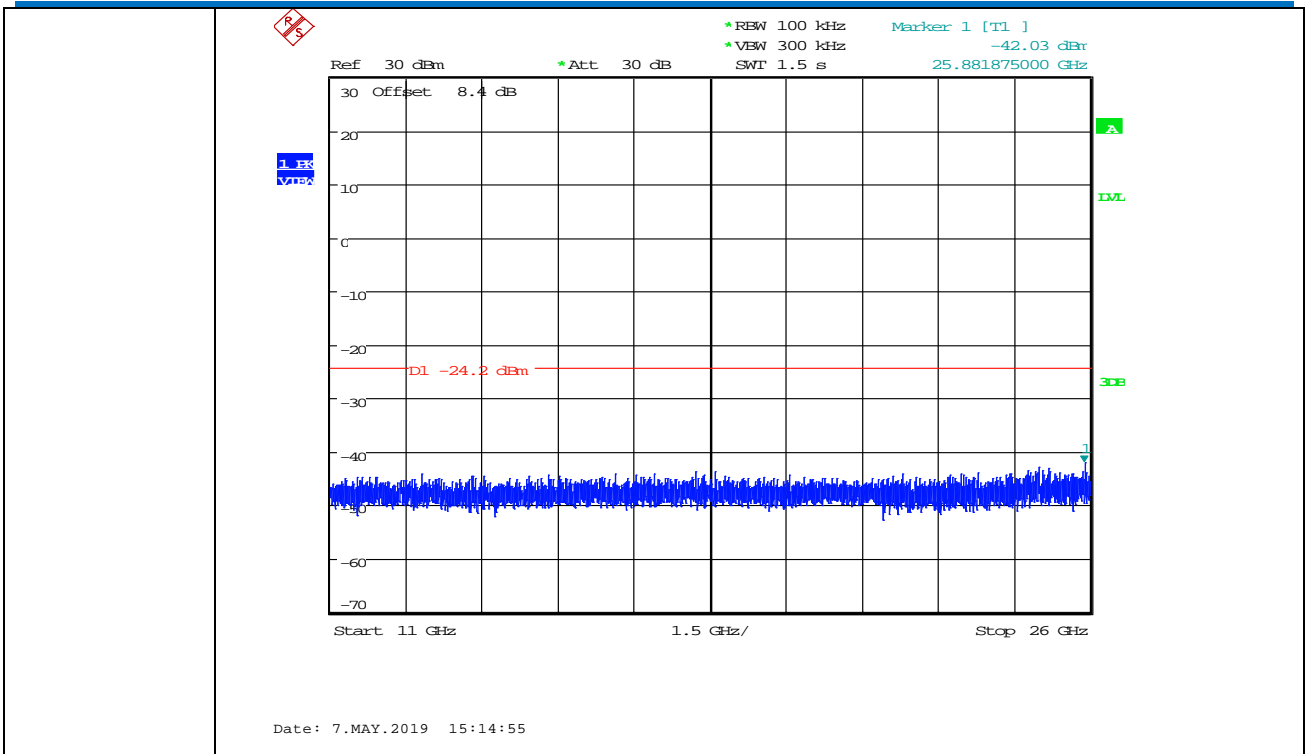

Puw/11N20SIS
 O/MCH

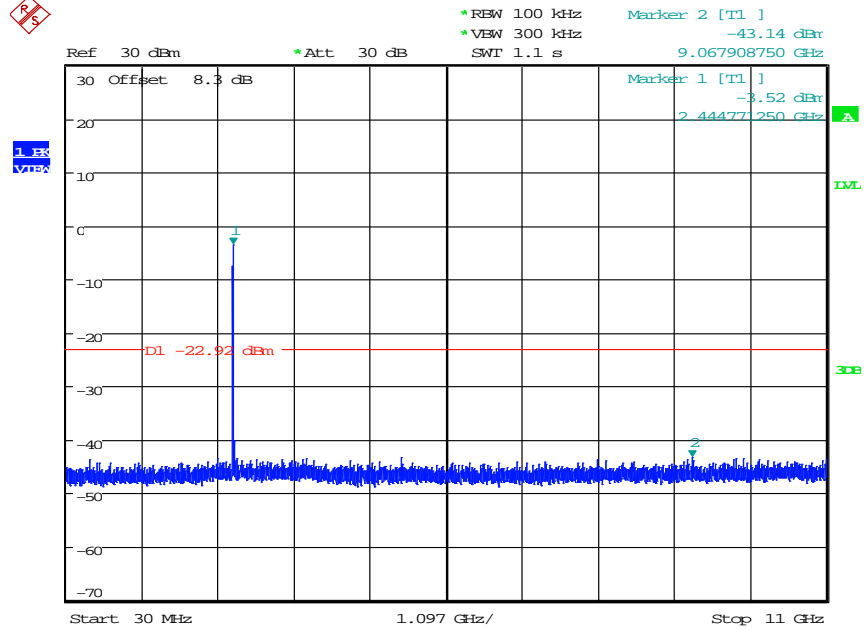

Date: 7.MAY.2019 15:28:24

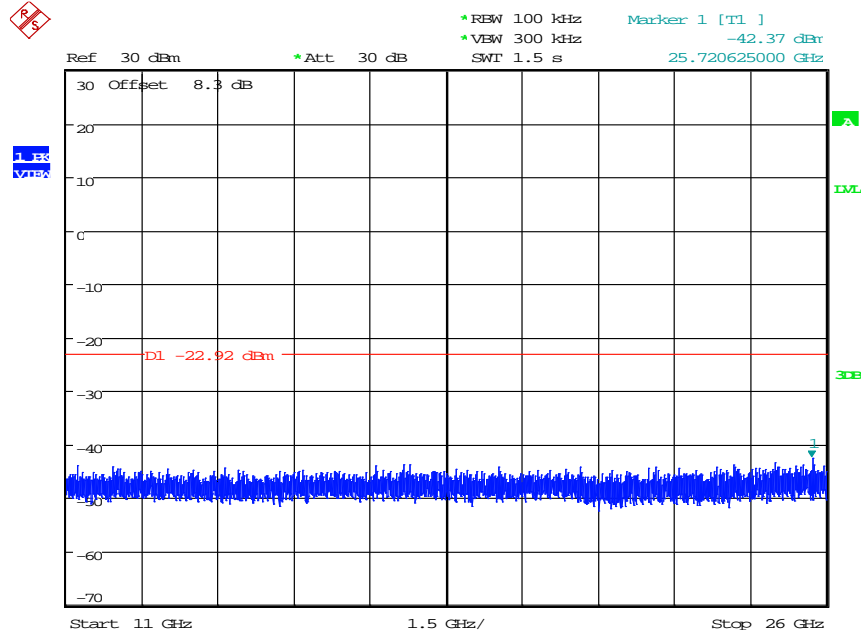

Date: 7.MAY.2019 15:28:35

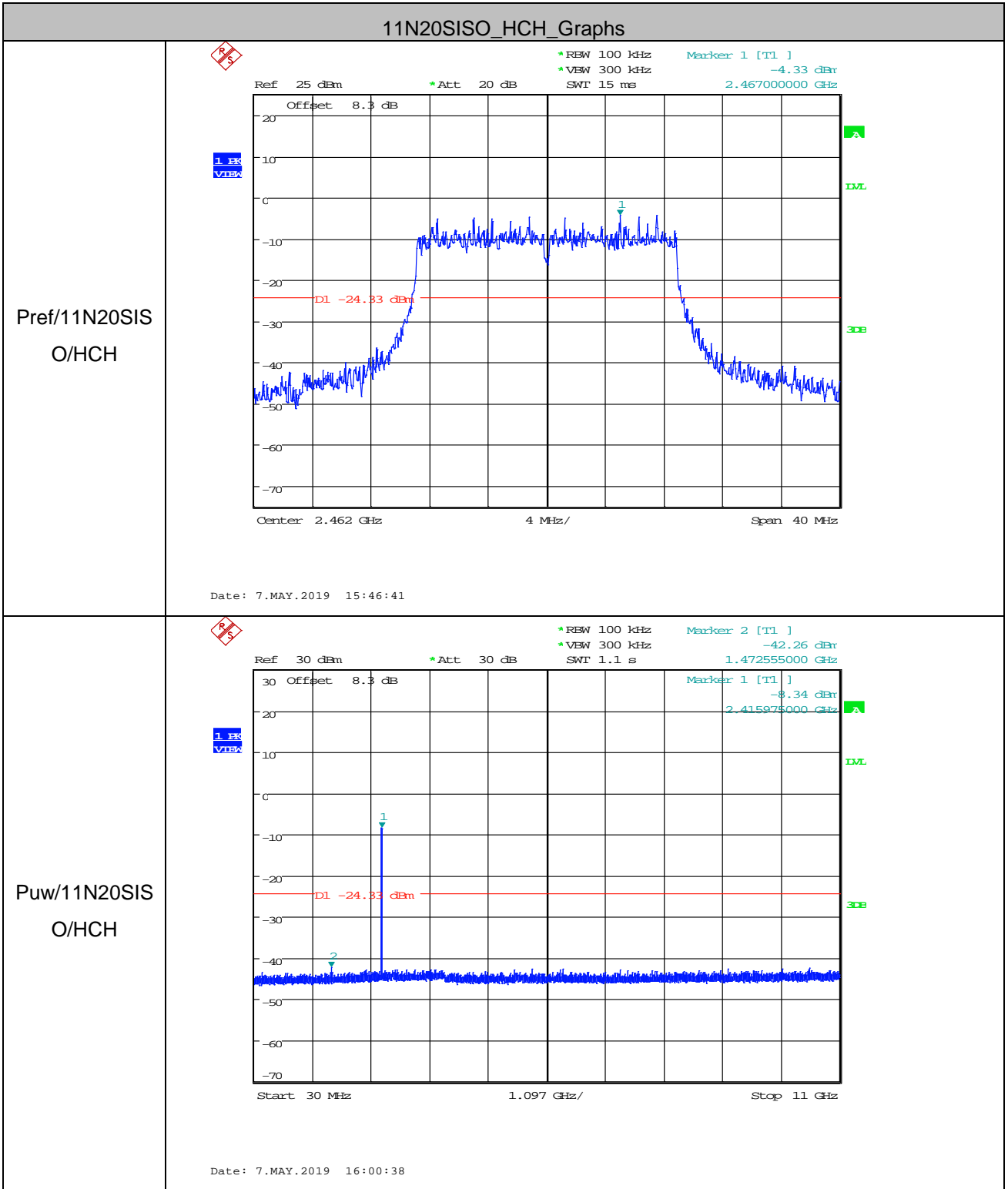

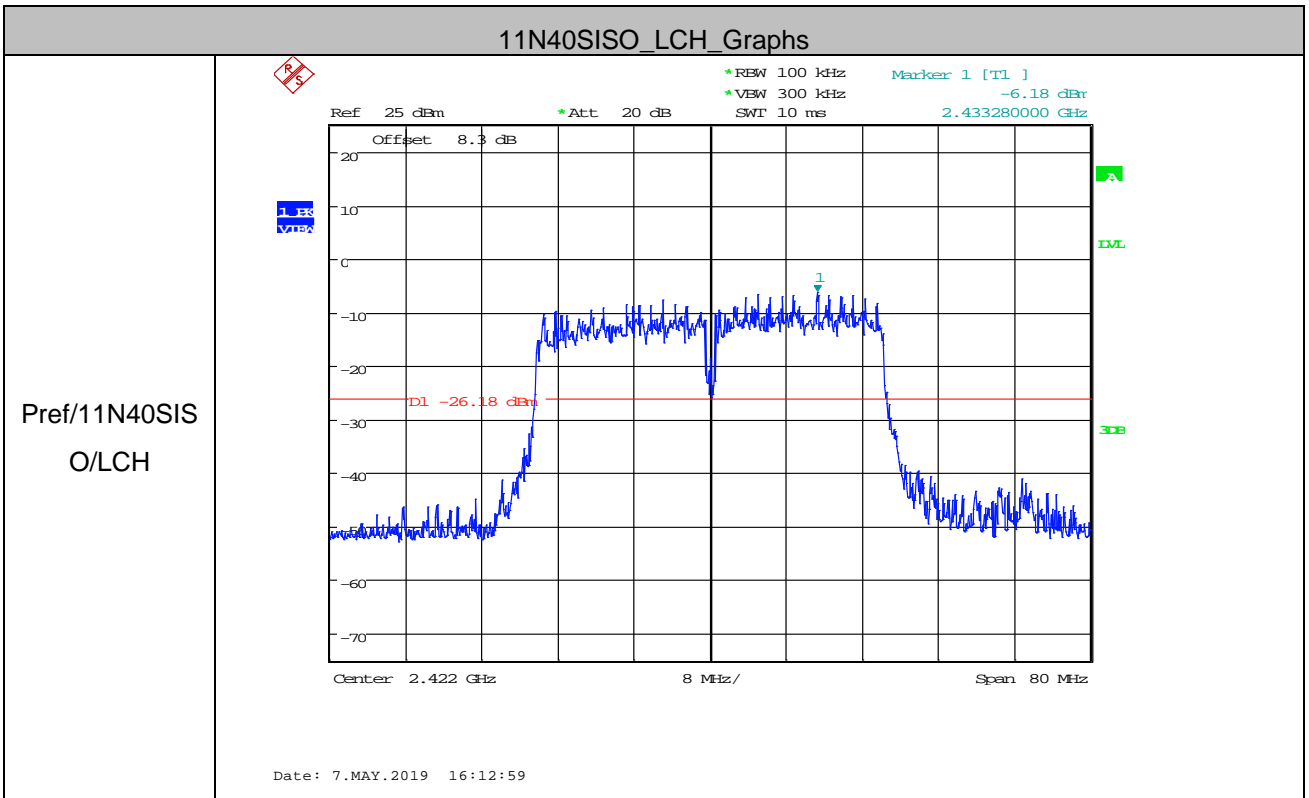
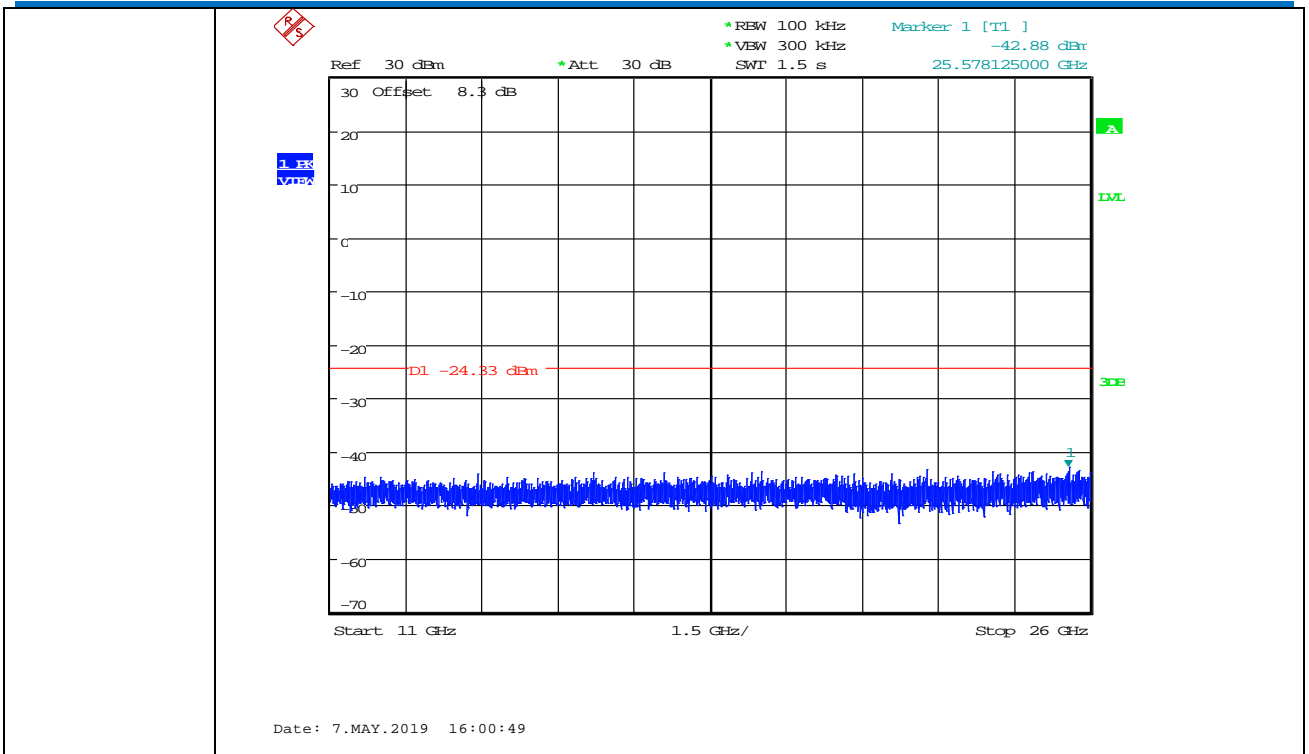

Pref/11N40SIS
 O/LCH

Puw/11N40SIS
 O/LCH

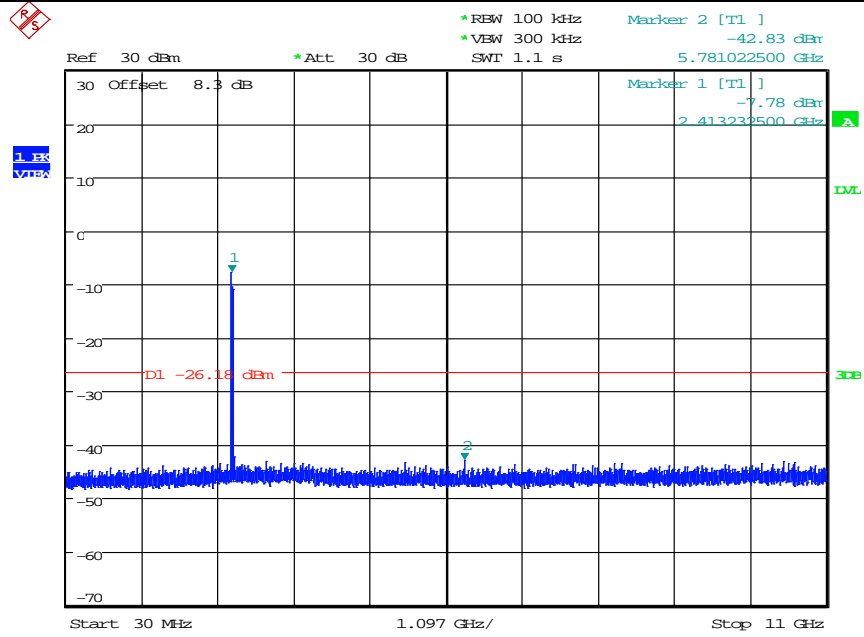

Date: 7.MAY.2019 16:14:04

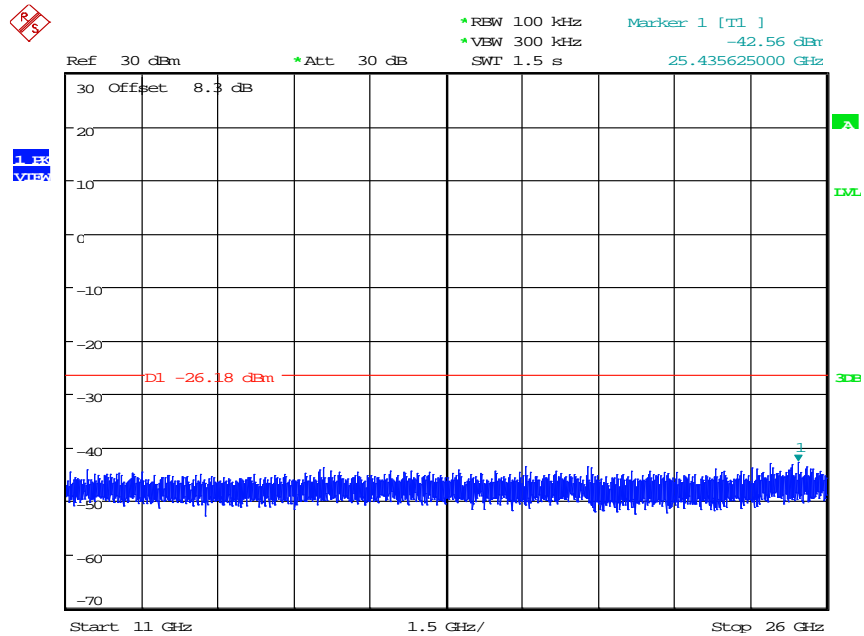

Date: 7.MAY.2019 16:14:15

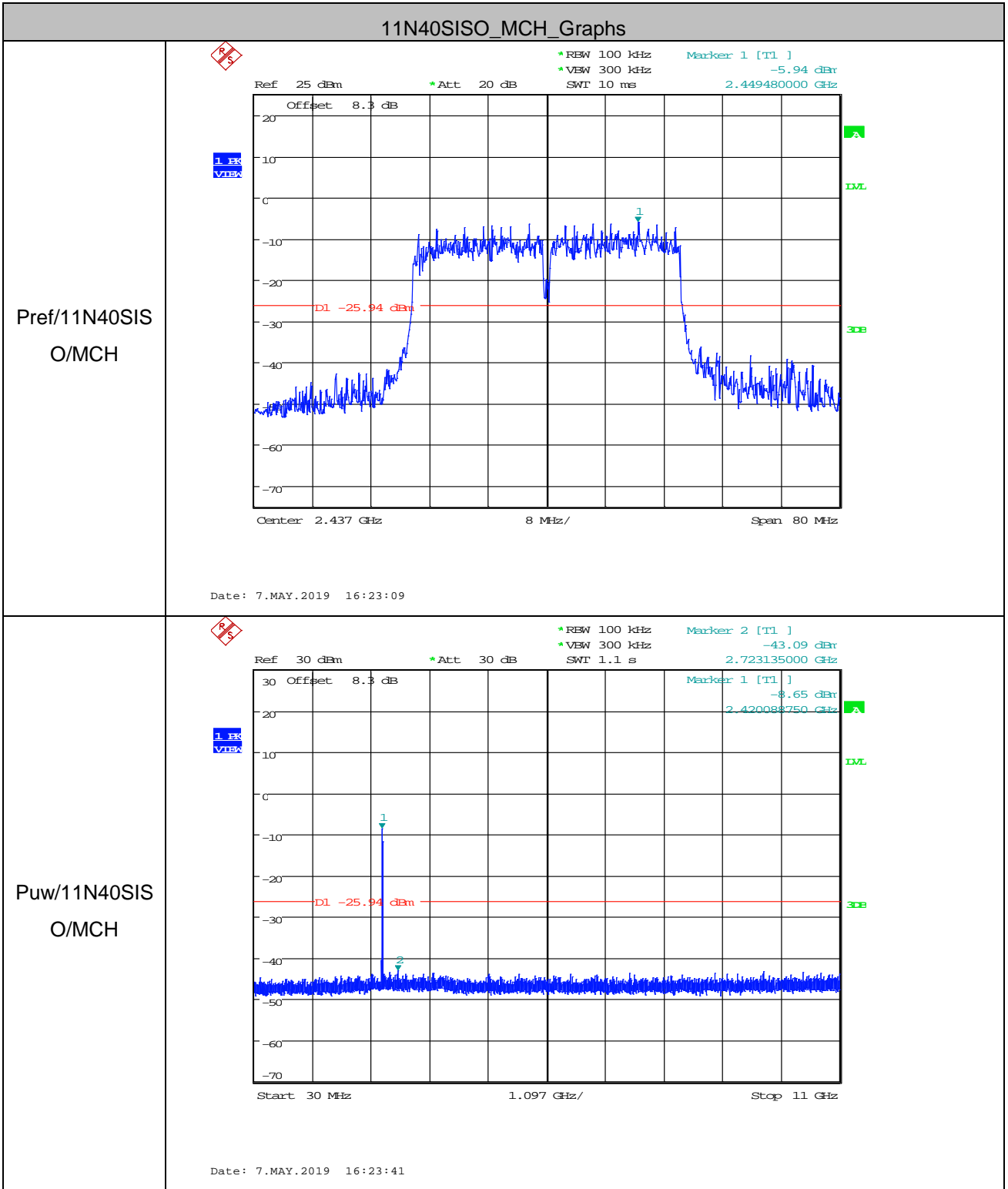

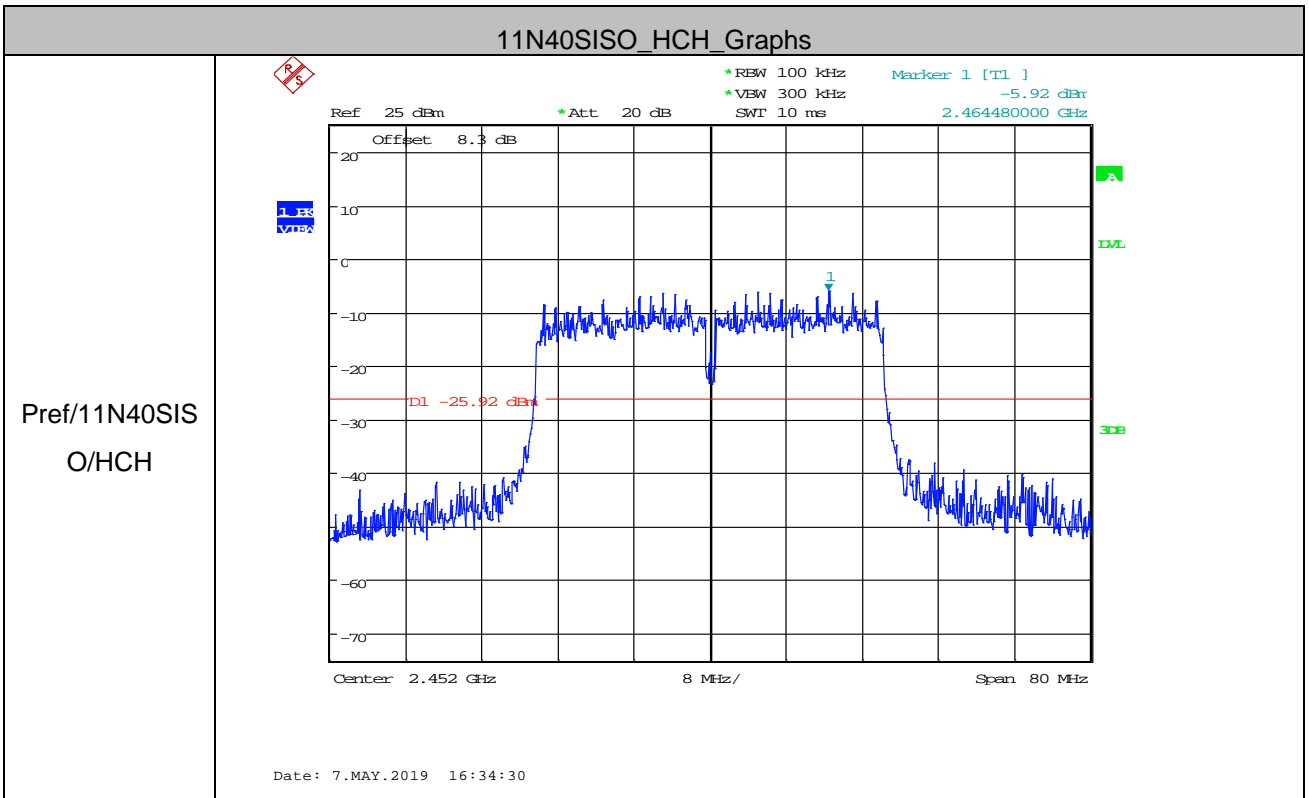
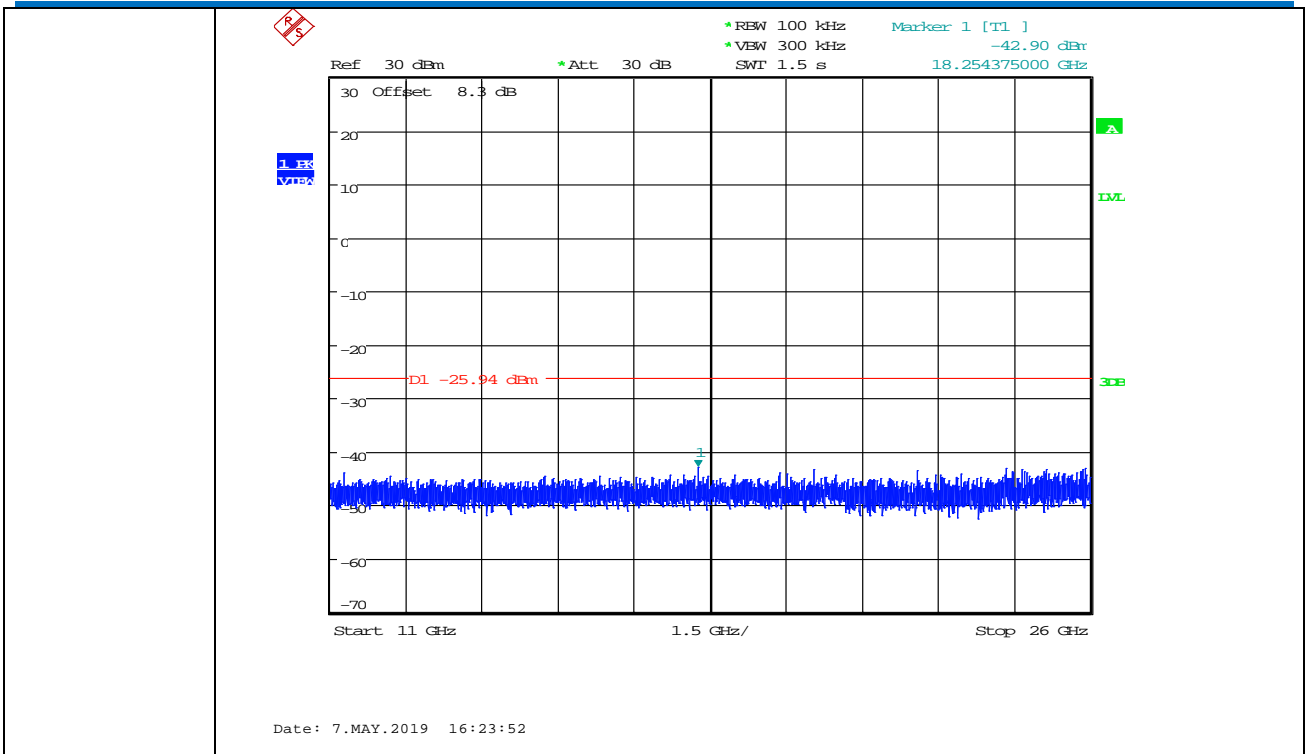

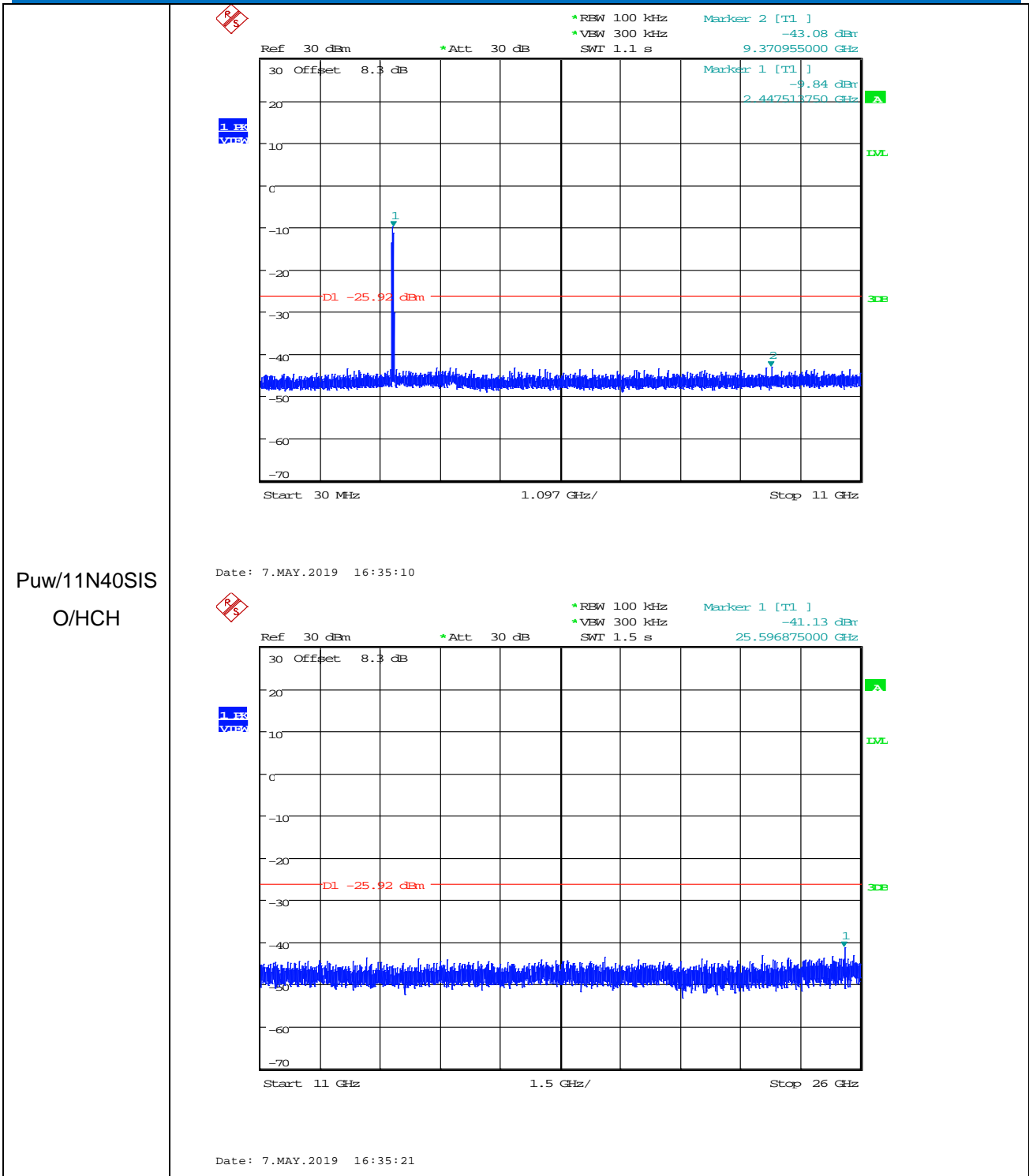

Remark:

Pretest 9kHz to 25GHz, find the highest point when testing, so only the worst data were shown in the test report. Per FCC Part 15.33 (a) and 15.31 (o), The amplitude of spurious emissions from intentional radiators which are attenuated more than 20 dB below the permissible value need not be reported unless specifically required elsewhere in this part.

5.7 Radiated Spurious Emissions

Test Requirement:	47 CFR Part 15C Section 15.209 and 15.205				
Test Method:	ANSI C63.10 2013				
Test Site:	Measurement Distance: 3m (Semi-Anechoic Chamber)				
Receiver Setup:	Frequency	Detector	RBW	VBW	Remark
	0.009MHz-0.090MHz	Peak	10kHz	30kHz	Peak
	0.009MHz-0.090MHz	Average	10kHz	30kHz	Average
	0.090MHz-0.110MHz	Quasi-peak	10kHz	30kHz	Quasi-peak
	0.110MHz-0.490MHz	Peak	10kHz	30kHz	Peak
	0.110MHz-0.490MHz	Average	10kHz	30kHz	Average
	0.490MHz -30MHz	Quasi-peak	10kHz	30kHz	Quasi-peak
	30MHz-1GHz	Quasi-peak	100 kHz	300kHz	Quasi-peak
	Above 1GHz	Peak	1MHz	3MHz	Peak
Peak		1MHz	10Hz	Average	
Limit:	Frequency	Field strength (microvolt/meter)	Limit (dBuV/m)	Remark	Measurement distance (m)
	0.009MHz-0.490MHz	2400/F(kHz)	-	-	300
	0.490MHz-1.705MHz	24000/F(kHz)	-	-	30
	1.705MHz-30MHz	30	-	-	30
	30MHz-88MHz	100	40.0	Quasi-peak	3
	88MHz-216MHz	150	43.5	Quasi-peak	3
	216MHz-960MHz	200	46.0	Quasi-peak	3
	960MHz-1GHz	500	54.0	Quasi-peak	3
	Above 1GHz	500	54.0	Average	3
Note: 15.35(b), Unless otherwise specified, the limit on peak radio frequency emissions is 20dB above the maximum permitted average emission limit applicable to the equipment under test. This peak limit applies to the total peak emission level radiated by the device.					

Test Setup:

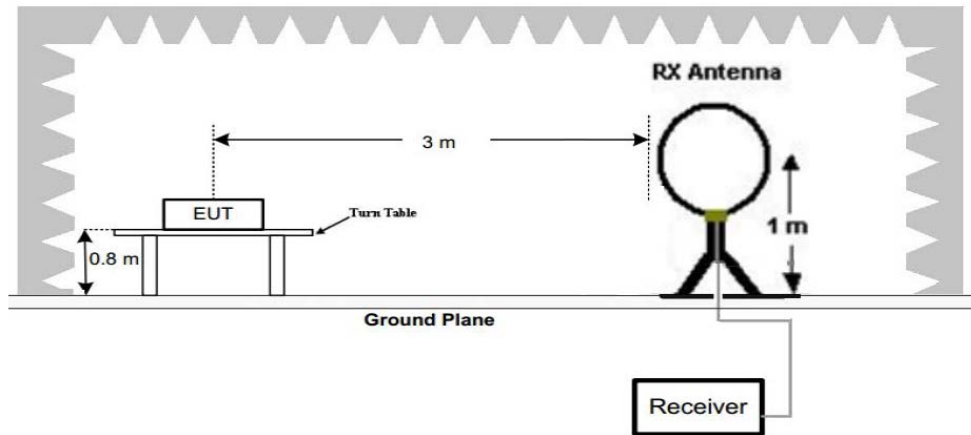

Figure 1. Below 30MHz

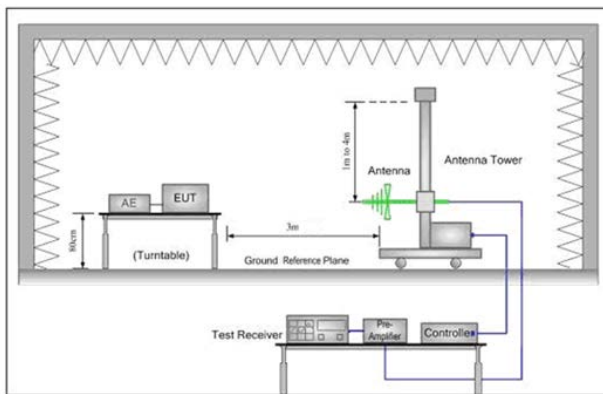

Figure 2. 30MHz to 1GHz

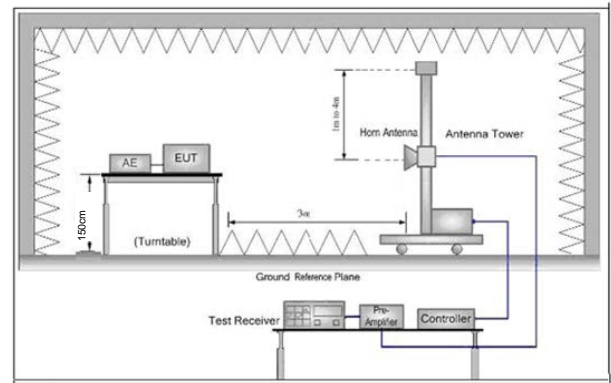

Figure 3. Above 1 GHz

<p>Test Procedure:</p>	<p>a. 1) Below 1G: The EUT was placed on the top of a rotating table 0.8 meters above the ground at a 3 meter semi-anechoic chamber. The table was rotated 360 degrees to determine the position of the highest radiation. 2) Above 1G: The EUT was placed on the top of a rotating table 1.5 meters above the ground at a 3 meter semi-anechoic chamber. The table was rotated 360 degrees to determine the position of the highest radiation. Note: For the radiated emission test above 1GHz: Place the measurement antenna away from each area of the EUT determined to be a source of emissions at the specified measurement distance, while keeping the measurement antenna aimed at the source of emissions at each frequency of significant emissions, with polarization oriented for maximum response. The measurement antenna may have to be higher or lower than the EUT, depending on the radiation pattern of the emission and staying aimed at the emission source for receiving the maximum signal. The final measurement antenna elevation shall be that which maximizes the emissions. The measurement antenna elevation for maximum emissions shall be restricted to a range of heights of from 1 m to 4 m above the ground or reference ground plane.</p> <p>b. The EUT was set 3 meters away from the interference-receiving antenna, which was mounted on the top of a variable-height antenna tower.</p> <p>c. The antenna height is varied from one meter to four meters above the ground to determine the maximum value of the field strength. Both horizontal and vertical polarizations of the antenna are set to make the measurement.</p> <p>d. For each suspected emission, the EUT was arranged to its worst case and then the antenna was tuned to heights from 1 meter to 4 meters (for</p>
------------------------	--

	<p>the test frequency of below 30MHz, the antenna was tuned to heights 1 meter) and the rotatable table was turned from 0 degrees to 360 degrees to find the maximum reading.</p> <p>e. The test-receiver system was set to Peak Detect Function and Specified Bandwidth with Maximum Hold Mode.</p> <p>f. If the emission level of the EUT in peak mode was 10dB lower than the limit specified, then testing could be stopped and the peak values of the EUT would be reported. Otherwise the emissions that did not have 10dB margin would be re-tested one by one using peak, quasi-peak or average method as specified and then reported in a data sheet.</p> <p>g. Test the EUT in the lowest channel ,the middle channel ,the Highest channel</p> <p>h. Repeat above procedures until all frequencies measured was complete.</p>
Exploratory Test Mode:	<p>Transmitting with all kind of modulations, data rates. Transmitting mode.</p>
Final Test Mode:	<p>Pretest the EUT at Transmitting mode which it is worse case Through Pre-scan, find the 1Mbps of rate is the worst case of 802.11b; 6Mbps of rate is the worst case of 802.11g ; 6.5Mbps of rate is the worst case of 802.11n(HT20) ; 13.5Mbps of rate is the worst case of 802.11n(HT40) For below 1GHz, through Pre-scan, find the 1Mbps of rate of 802.11b at highest channel is the worst case. Only the worst case is recorded in the report.</p>
Test Results:	<p>Pass</p>

5.7.1 Radiated emission below 1GHz

30MHz~1GHz		
Test mode:	Transmitting	Vertical

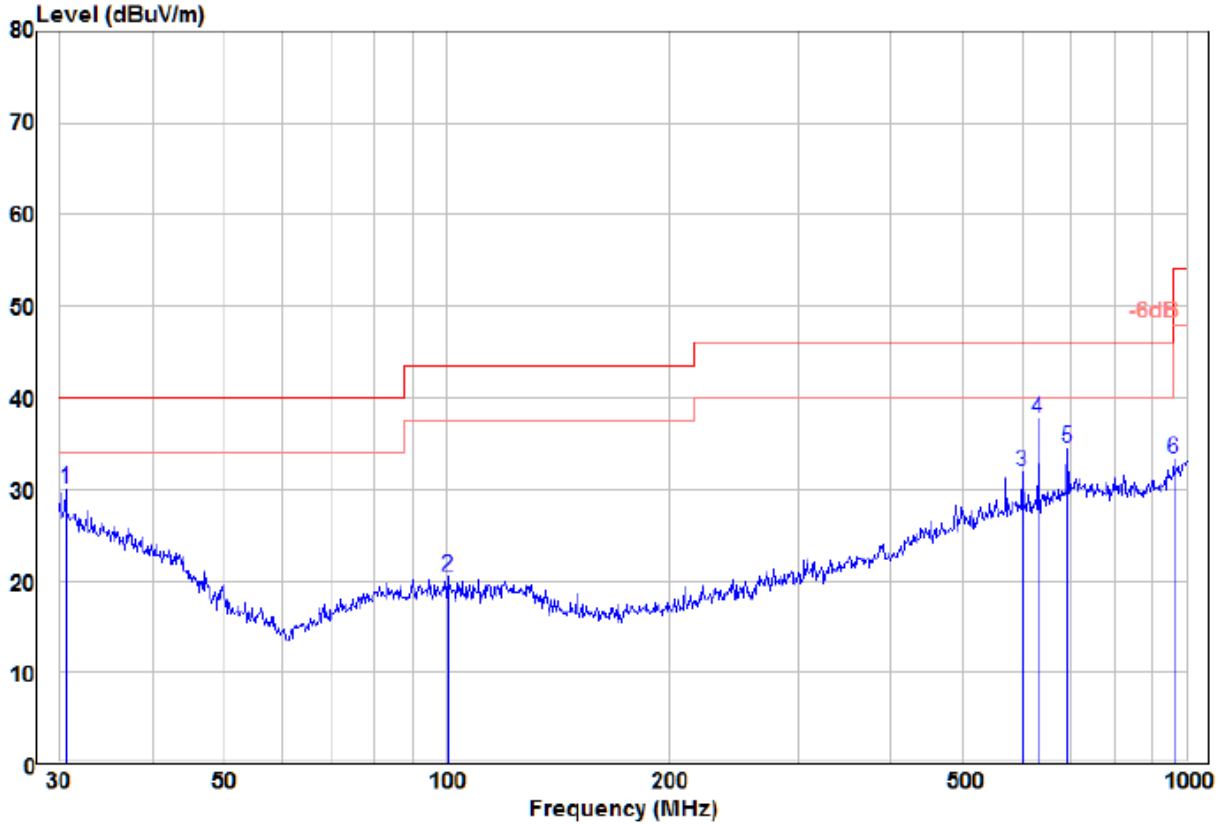

	Read Freq	Read Level	Factor	Level	Limit	Over	Remark	Pol/Phase
	MHz	dBuV	dB/m	dBuV/m	dBuV/m	dB		
1	30.64	1.93	28.08	30.01	40.00	-9.99	Peak	VERTICAL
2	100.58	-0.08	20.53	20.45	43.50	-23.05	Peak	VERTICAL
3	601.43	3.61	28.26	31.87	46.00	-14.13	Peak	VERTICAL
4 pp	631.69	8.94	28.80	37.74	46.00	-8.26	Peak	VERTICAL
5	691.99	4.54	29.87	34.41	46.00	-11.59	Peak	VERTICAL
6	962.16	1.26	32.01	33.27	54.00	-20.73	Peak	VERTICAL

Remark:

The field strength is calculated by adding the Antenna Factor, Cable Factor & Preamplifier. The basic equation with a sample calculation is as follows:

Factor= Antenna Factor + Cable Factor – Preamplifier Factor,

Level = Read Level + Factor,

Over Limit=Level-Limit Line.

Test mode:	Transmitting	Horizontal
------------	--------------	------------

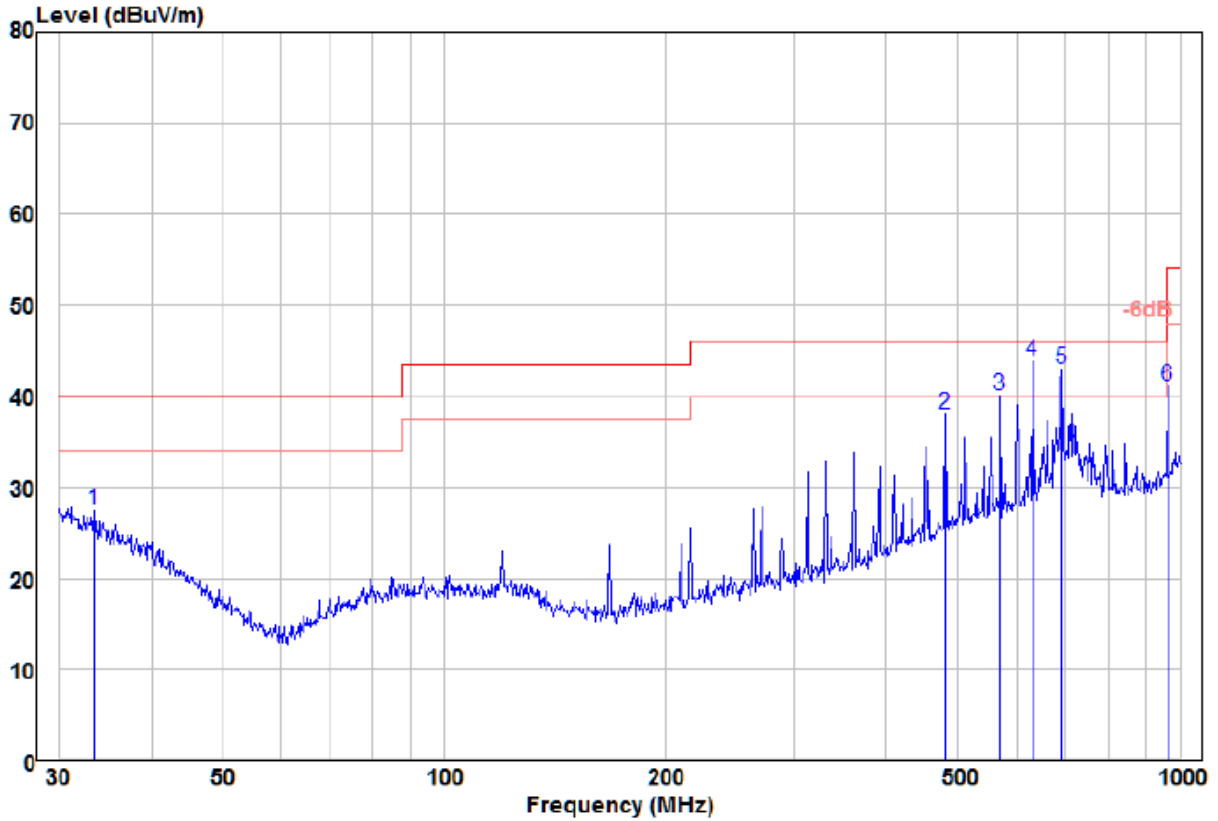

	Read Freq	Read Level	Factor	Limit Level	Over Limit	Remark	Pol/Phase
	MHz	dBuV	dB/m	dBuV/m	dBuV/m	dB	
1	33.44	0.35	27.07	27.42	40.00	-12.58 Peak	HORIZONTAL
2	480.53	11.35	26.63	37.98	46.00	-8.02 Peak	HORIZONTAL
3 !	570.61	12.08	27.95	40.03	46.00	-5.97 Peak	HORIZONTAL
4 pp	631.69	14.99	28.80	43.79	46.00	-2.21 Peak	HORIZONTAL
5 !	691.99	13.13	29.87	43.00	46.00	-3.00 Peak	HORIZONTAL
6	962.16	9.08	32.01	41.09	54.00	-12.91 Peak	HORIZONTAL

Remark:

The field strength is calculated by adding the Antenna Factor, Cable Factor & Preamplifier. The basic equation with a sample calculation is as follows:

Factor= Antenna Factor + Cable Factor – Preamplifier Factor,

Level = Read Level + Factor,

Over Limit=Level-Limit Line.

5.7.2 Transmitter emission above 1GHz

Test mode:		802.11b(1Mbps)		Test channel:		Lowest	
Frequency	Meter Reading	Factor	Emission Level	Limits	Over	Detector Type	Ant. Pol.
(MHz)	(dBμV)	(dB)	(dBμV/m)	(dBμV/m)	(dB)		H/V
4824.000	52.81	-4.26	48.55	74	-25.45	peak	H
4824.000	36.37	-4.26	32.11	54	-21.89	AVG	H
7236.000	50.25	1.18	51.43	74	-22.57	peak	H
7236.000	37.79	1.18	38.97	54	-15.03	AVG	H
4824.000	55.23	-4.26	50.97	74	-23.03	peak	V
4824.000	38.04	-4.26	33.78	54	-20.22	AVG	V
7236.000	51.80	1.18	52.98	74	-21.02	peak	V
7236.000	35.82	1.18	37.00	54	-17.00	AVG	V

Test mode:		802.11b(1Mbps)		Test channel:		Middle	
Frequency	Meter Reading	Factor	Emission Level	Limits	Over	Detector Type	Ant. Pol.
(MHz)	(dBμV)	(dB)	(dBμV/m)	(dBμV/m)	(dB)		H/V
4874.000	52.05	-4.12	47.93	74	-26.07	peak	H
4874.000	37.01	-4.12	32.89	54	-21.11	AVG	H
7311.000	48.73	1.46	50.19	74	-23.81	peak	H
7311.000	36.44	1.46	37.90	54	-16.10	AVG	H
4874.000	53.11	-4.12	48.99	74	-25.01	peak	V
4874.000	36.96	-4.12	32.84	54	-21.16	AVG	V
7311.000	48.82	1.46	50.28	74	-23.72	peak	V
7311.000	36.89	1.46	38.35	54	-15.65	AVG	V

Test mode:		802.11b(1Mbps)		Test channel:		Highest	
Frequency	Meter Reading	Factor	Emission Level	Limits	Over	Detector Type	Ant. Pol.
(MHz)	(dBμV)	(dB)	(dBμV/m)	(dBμV/m)	(dB)		H/V
4924.000	51.53	-4.03	47.50	74	-26.50	peak	H
4924.000	38.55	-4.03	34.52	54	-19.48	AVG	H
7386.000	49.71	1.66	51.37	74	-22.63	peak	H
7386.000	37.56	1.66	39.22	54	-14.78	AVG	H
4924.000	54.76	-4.03	50.73	74	-23.27	peak	V
4924.000	37.46	-4.03	33.43	54	-20.57	AVG	V
7386.000	50.80	1.66	52.46	74	-21.54	peak	V
7386.000	37.97	1.66	39.63	54	-14.37	AVG	V

Remark:

- 1) The 1Mbps of rate of 802.11b is the worst case.
- 2) The field strength is calculated by adding the Antenna Factor, Cable Factor & Preamplifier. The basic equation with a sample calculation is as follows:

$$\text{Final Test Level} = \text{Receiver Reading} + \text{Antenna Factor} + \text{Cable Factor} - \text{Preamplifier Factor}$$
- 3) Scan from 9kHz to 25GHz, The disturbance above 13GHz and below 30MHz was very low, and the above harmonics were the highest point could be found when testing, so only the above harmonics had been displayed. The amplitude of spurious emissions from the radiator which are attenuated more than 20dB below the limit need not be reported.

5.8 Restricted bands around fundamental frequency

Test Requirement:	47 CFR Part 15C Section 15.209 and 15.205		
Test Method:	ANSI C63.10 2013		
Test Site:	Measurement Distance: 3m (Semi-Anechoic Chamber)		
Limit:	Frequency	Limit (dBuV/m @3m)	Remark
	30MHz-88MHz	40.0	Quasi-peak Value
	88MHz-216MHz	43.5	Quasi-peak Value
	216MHz-960MHz	46.0	Quasi-peak Value
	960MHz-1GHz	54.0	Quasi-peak Value
	Above 1GHz	54.0	Average Value
		74.0	Peak Value

Test Setup:

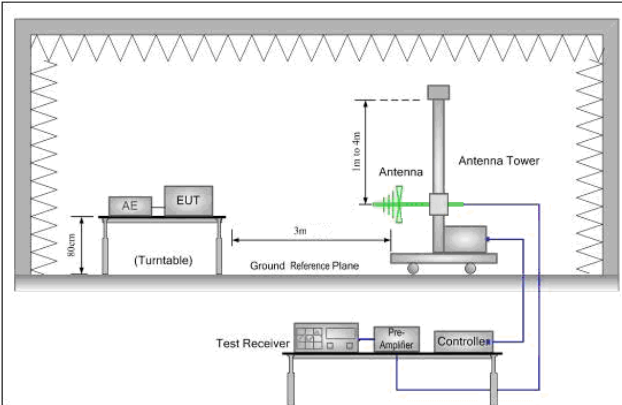

Figure 1. 30MHz to 1GHz

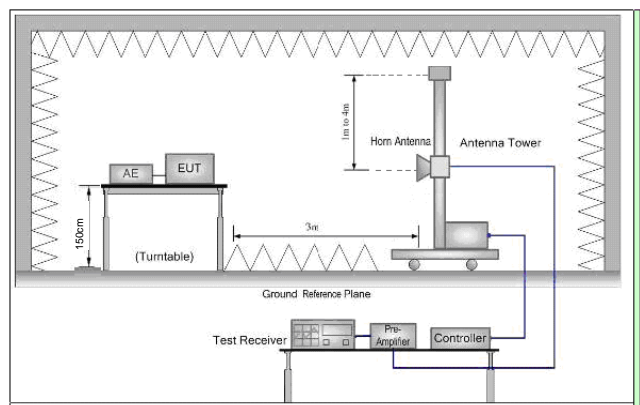

Figure 2. Above 1 GHz

Test Procedure:

- a. 1) Below 1G: The EUT was placed on the top of a rotating table 0.8 meters above the ground at a 3 meter semi-anechoic chamber. The table was rotated 360 degrees to determine the position of the highest radiation.
2) Above 1G: The EUT was placed on the top of a rotating table 1.5 meters above the ground at a 3 meter semi-anechoic chamber. The table was rotated 360 degrees to determine the position of the highest radiation.
Note: For the radiated emission test above 1GHz:
Place the measurement antenna away from each area of the EUT determined to be a source of emissions at the specified measurement distance, while keeping the measurement antenna aimed at the source of emissions at each frequency of significant emissions, with polarization oriented for maximum response. The measurement antenna may have to be higher or lower than the EUT, depending on the radiation pattern of the emission and staying aimed at the emission source for receiving the maximum signal. The final measurement antenna elevation shall be that which maximizes the emissions. The measurement antenna elevation for maximum emissions shall be restricted to a range of heights of from 1 m to 4 m above the ground or reference ground plane.
- b. The EUT was set 3 meters away from the interference-receiving antenna, which was mounted on the top of a variable-height antenna tower.
- c. The antenna height is varied from one meter to four meters above the ground to determine the maximum value of the field strength. Both horizontal and vertical polarizations of the antenna are set to make the measurement.

	<p>d. For each suspected emission, the EUT was arranged to its worst case and then the antenna was tuned to heights from 1 meter to 4 meters and the rotatable table was turned from 0 degrees to 360 degrees to find the maximum reading.</p> <p>e. The test-receiver system was set to Peak Detect Function and Specified Bandwidth with Maximum Hold Mode.</p> <p>f. Place a marker at the end of the restricted band closest to the transmit frequency to show compliance. Also measure any emissions in the restricted bands. Save the spectrum analyzer plot. Repeat for each power and modulation for lowest and highest channel</p> <p>g. Test the EUT in the lowest channel , the Highest channel</p> <p>h. Repeat above procedures until all frequencies measured was complete.</p>
Exploratory Test Mode:	<p>Transmitting with all kind of modulations, data rates. Transmitting mode.</p>
Final Test Mode:	<p>Pretest the EUT at Transmitting mode, found the Transmitting mode which it is worse case</p> <p>Through Pre-scan, find the 1Mbps of rate is the worst case of 802.11b; 6Mbps of rate is the worst case of 802.11g ; 6.5Mbps of rate is the worst case of 802.11n(HT20) ; 13.5Mbps of rate is the worst case of 802.11n(HT40)</p> <p>Only the worst case is recorded in the report.</p>
Test Results:	<p>Pass</p>

Test data:

Worse case mode:		802.11b(1Mbps)		Test channel:		Lowest	
Frequency	Meter Reading	Factor	Emission Level	Limits	Over	Detector Type	Ant. Pol.
(MHz)	(dB μ V)	(dB)	(dB μ V/m)	(dB μ V/m)	(dB)		H/V
2390.000	58.46	-9.2	49.26	74	-24.74	peak	H
2390.000	44.74	-9.2	35.54	54	-18.46	AVG	H
2400.000	59.38	-9.39	49.99	74	-24.01	peak	H
2400.000	46.08	-9.39	36.69	54	-17.31	AVG	H
2390.000	58.80	-9.2	49.60	74	-24.40	peak	V
2390.000	44.90	-9.2	35.70	54	-18.30	AVG	V
2400.000	59.62	-9.39	50.23	74	-23.77	peak	V
2400.000	46.87	-9.39	37.48	54	-16.52	AVG	V

Worse case mode:		802.11b(1Mbps)		Test channel:		Highest	
Frequency	Meter Reading	Factor	Emission Level	Limits	Over	Detector Type	Ant. Pol.
(MHz)	(dB μ V)	(dB)	(dB μ V/m)	(dB μ V/m)	(dB)		H/V
2483.500	57.46	-9.29	48.17	74	-25.83	peak	H
2483.500	43.77	-9.29	34.48	54	-19.52	AVG	H
2483.500	58.31	-9.29	49.02	74	-24.98	peak	V
2483.500	46.05	-9.29	36.76	54	-17.24	AVG	V

Worse case mode:		802.11g(6Mbps)		Test channel:		Lowest	
Frequency	Meter Reading	Factor	Emission Level	Limits	Over	Detector Type	Ant. Pol.
(MHz)	(dB μ V)	(dB)	(dB μ V/m)	(dB μ V/m)	(dB)		H/V
2390.000	58.57	-9.2	49.37	74	-24.63	peak	H
2390.000	44.86	-9.2	35.66	54	-18.34	AVG	H
2400.000	60.00	-9.39	50.61	74	-23.39	peak	H
2400.000	46.22	-9.39	36.83	54	-17.17	AVG	H
2390.000	59.20	-9.2	50.00	74	-24.00	peak	V
2390.000	44.05	-9.2	34.85	54	-19.15	AVG	V
2400.000	59.91	-9.39	50.52	74	-23.48	peak	V
2400.000	46.83	-9.39	37.44	54	-16.56	AVG	V

Worse case mode:		802.11g(6Mbps)		Test channel:		Highest	
Frequency	Meter Reading	Factor	Emission Level	Limits	Over	Detector Type	Ant. Pol.
(MHz)	(dB μ V)	(dB)	(dB μ V/m)	(dB μ V/m)	(dB)		H/V
2483.500	58.39	-9.29	49.10	74	-24.90	peak	H
2483.500	44.35	-9.29	35.06	54	-18.94	AVG	H
2483.500	58.39	-9.29	49.10	74	-24.90	peak	V
2483.500	45.84	-9.29	36.55	54	-17.45	AVG	V

Worse case mode:		802.11n(HT20)(6.5Mbps)		Test channel:		Lowest	
Frequency	Meter Reading	Factor	Emission Level	Limits	Over	Detector Type	Ant. Pol.
(MHz)	(dB μ V)	(dB)	(dB μ V/m)	(dB μ V/m)	(dB)		H/V
2390.000	58.72	-9.2	49.52	74	-24.48	peak	H
2390.000	44.23	-9.2	35.03	54	-18.97	AVG	H
2400.000	59.33	-9.39	49.94	74	-24.06	peak	H
2400.000	46.03	-9.39	36.64	54	-17.36	AVG	H
2390.000	58.71	-9.2	49.51	74	-24.49	peak	V
2390.000	44.06	-9.2	34.86	54	-19.14	AVG	V
2400.000	59.52	-9.39	50.13	74	-23.87	peak	V
2400.000	46.77	-9.39	37.38	54	-16.62	AVG	V

Worse case mode:		802.11n(HT20)(6.5Mbps)		Test channel:		Highest	
Frequency	Meter Reading	Factor	Emission Level	Limits	Over	Detector Type	Ant. Pol.
(MHz)	(dB μ V)	(dB)	(dB μ V/m)	(dB μ V/m)	(dB)		H/V
2483.500	57.44	-9.29	48.15	74	-25.85	peak	H
2483.500	44.35	-9.29	35.06	54	-18.94	AVG	H
2483.500	57.65	-9.29	48.36	74	-25.64	peak	V
2483.500	46.32	-9.29	37.03	54	-16.97	AVG	V

Worse case mode:		802.11n(HT40)(13.5Mbps)		Test channel:		Lowest	
Frequency	Meter Reading	Factor	Emission Level	Limits	Over	Detector Type	Ant. Pol.
(MHz)	(dBμV)	(dB)	(dBμV/m)	(dBμV/m)	(dB)		H/V
2390.000	59.02	-9.2	49.82	74	-24.18	peak	H
2390.000	44.26	-9.2	35.06	54	-18.94	AVG	H
2400.000	59.26	-9.39	49.87	74	-24.13	peak	H
2400.000	46.94	-9.39	37.55	54	-16.45	AVG	H
2390.000	58.77	-9.2	49.57	74	-24.43	peak	V
2390.000	44.58	-9.2	35.38	54	-18.62	AVG	V
2400.000	59.55	-9.39	50.16	74	-23.84	peak	V
2400.000	46.94	-9.39	37.55	54	-16.45	AVG	V

Worse case mode:		802.11n(HT40)(13.5Mbps)		Test channel:		Highest	
Frequency	Meter Reading	Factor	Emission Level	Limits	Over	Detector Type	Ant. Pol.
(MHz)	(dBμV)	(dB)	(dBμV/m)	(dBμV/m)	(dB)		H/V
2483.500	58.34	-9.29	49.05	74	-24.95	peak	H
2483.500	43.80	-9.29	34.51	54	-19.49	AVG	H
2483.500	58.25	-9.29	48.96	74	-25.04	peak	V
2483.500	45.80	-9.29	36.51	54	-17.49	AVG	V

Note:

The field strength is calculated by adding the Antenna Factor, Cable Factor & Preamplifier. The basic equation with a sample calculation is as follows:

Final Test Level = Receiver Reading + Antenna Factor + Cable Factor – Preamplifier Factor

6 Photographs - EUT Test Setup

6.1 Radiated Spurious Emission

9KHz~30MHz:



30MHz~1GHz:

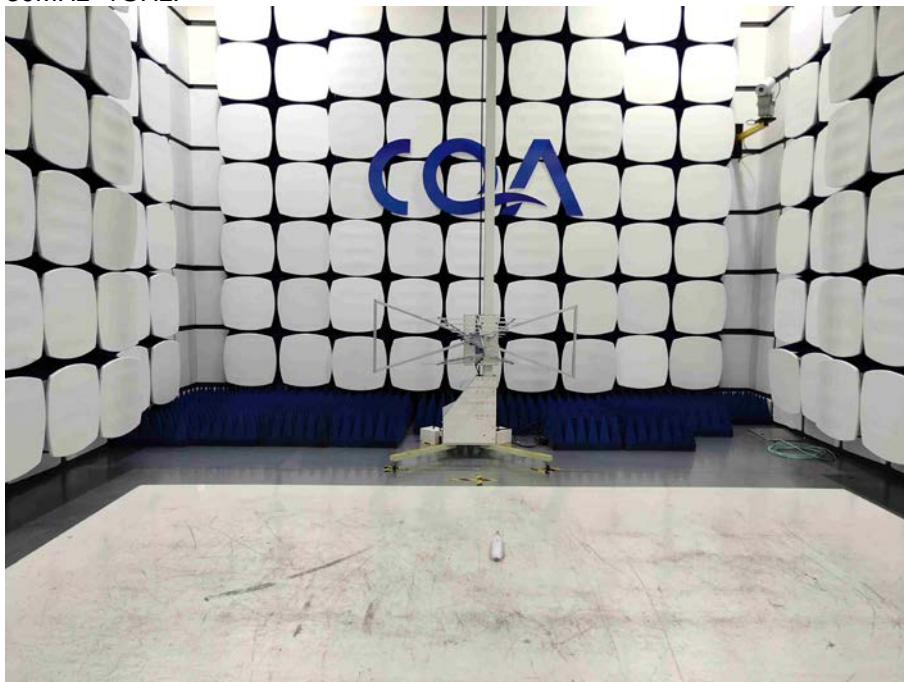

Above 1GHz:



7 Photographs - EUT Constructional Details

Test model No.: WF-500

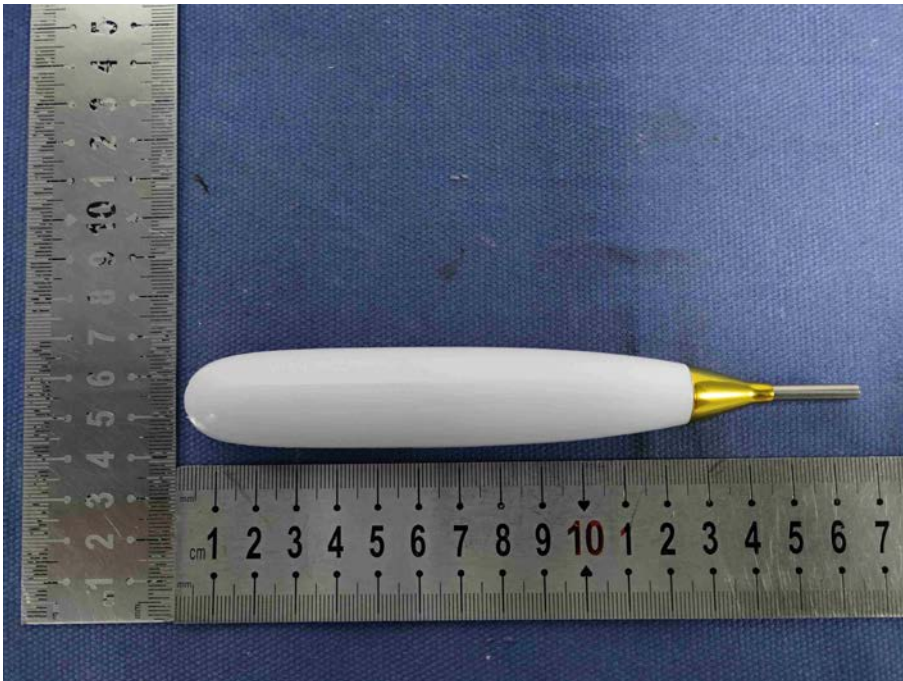

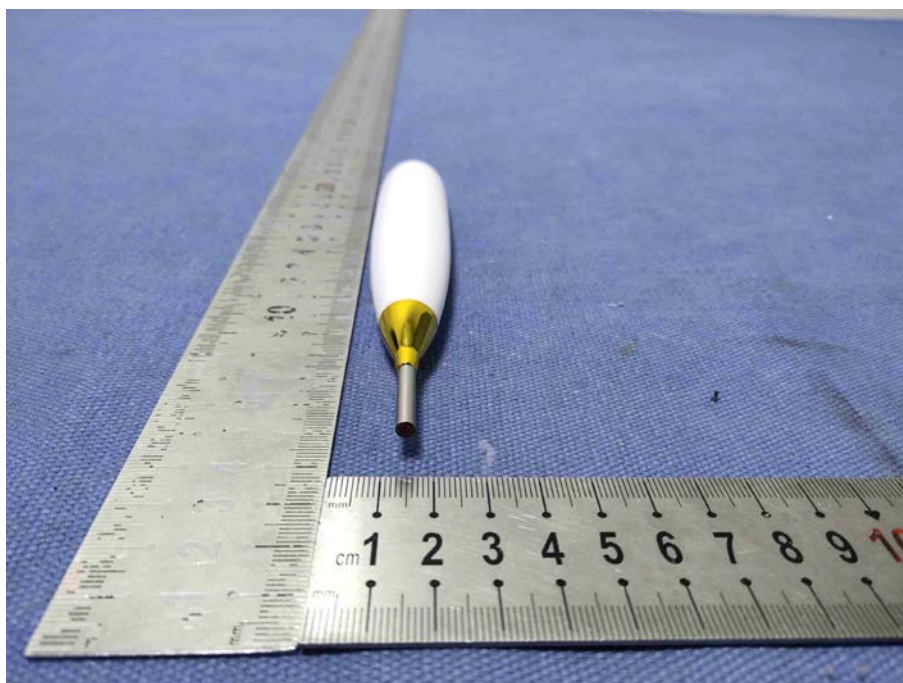
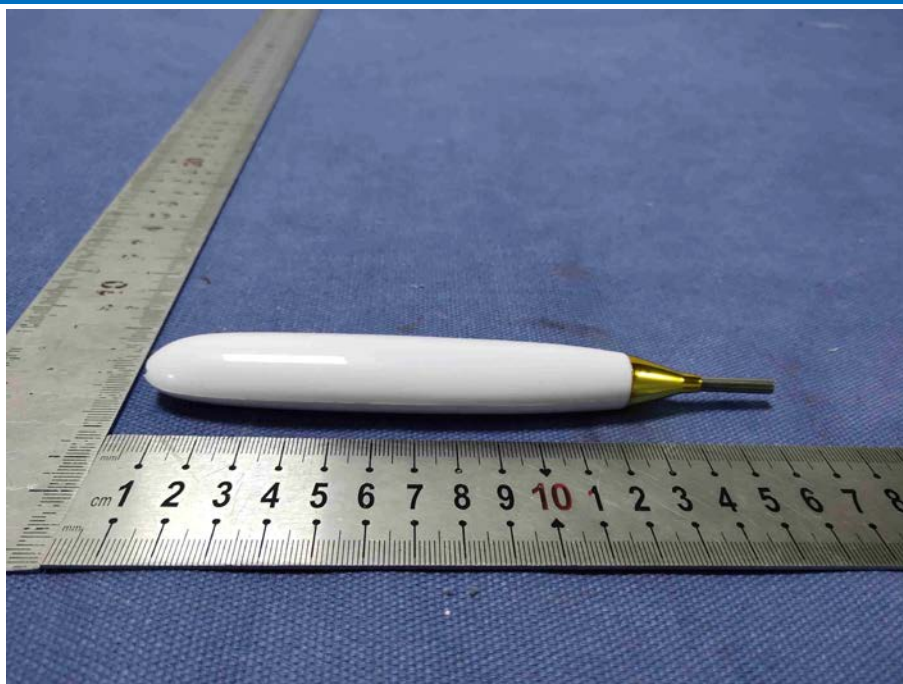

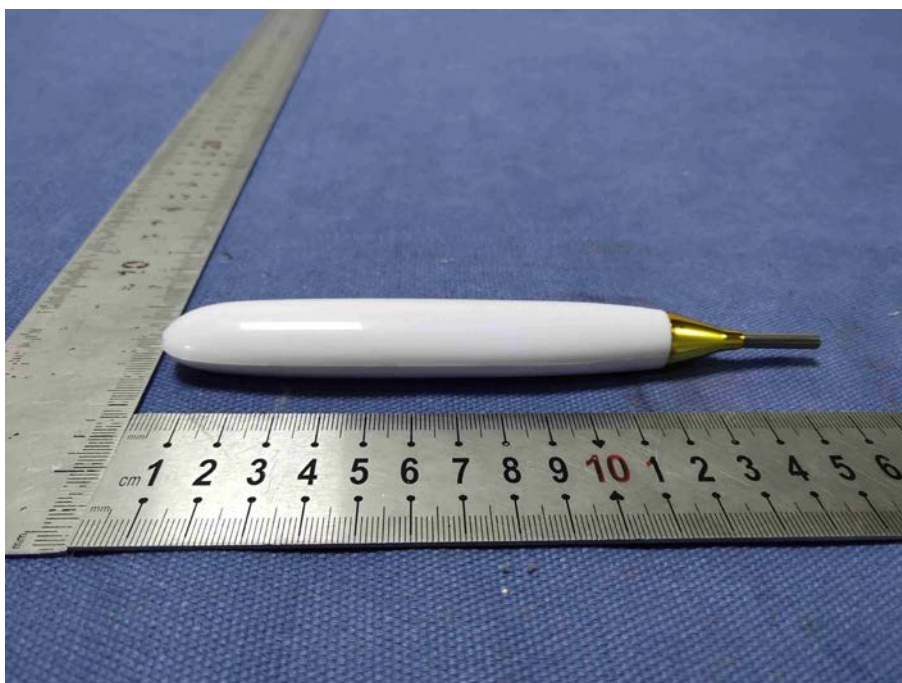
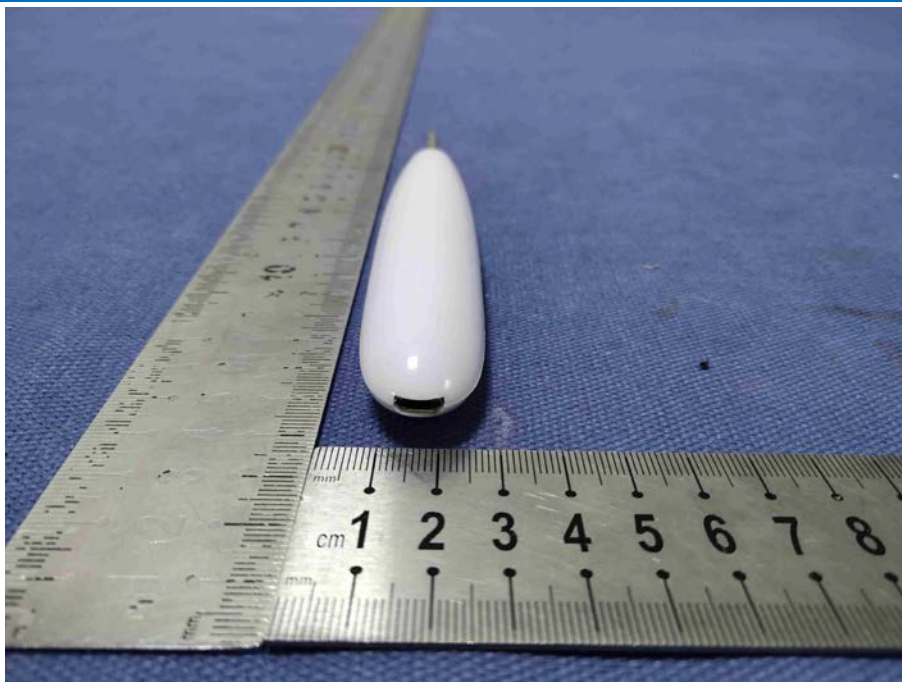

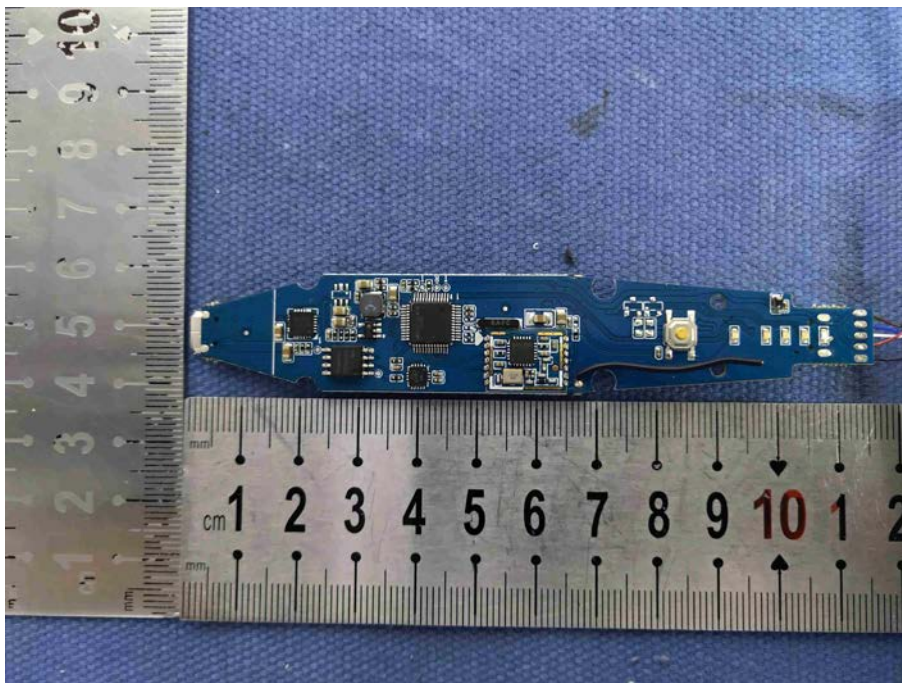

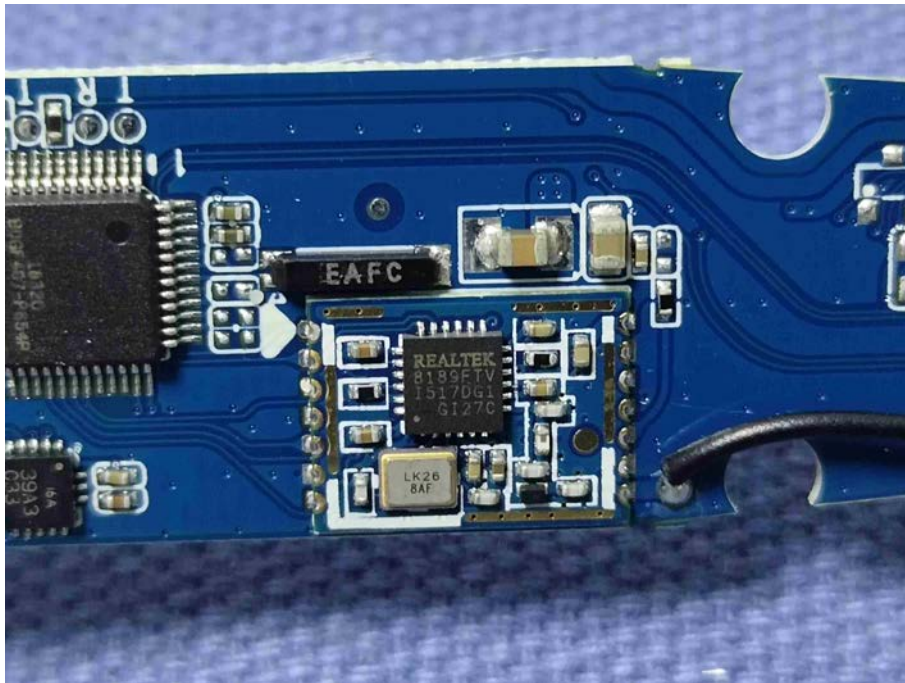
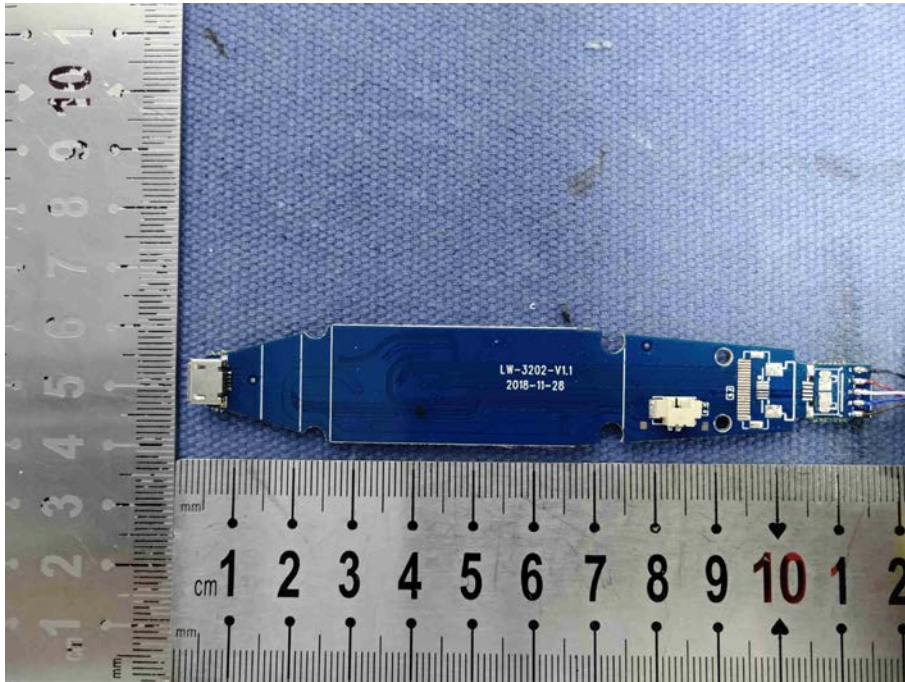

THE END