

FCC AND IC CERTIFICATION TEST REPORT

FOR

Applicant	:	Kingstate Electronics (Dongguan) Co., Ltd.
Address	:	Shi Chong Industrial Park, Shi Chong Avenue, Xiang Xi Village, Shi Pai Town, Dong Guan City, Guang Dong Province, China
Equipment under Test	:	Bluetooth Headset
Model No.	:	HA-FX39BT
Trade Mark	:	JVC
FCC ID	:	2AKMBHA-FX39BT
IC	:	12522A-FX39BT
Manufacturer	:	Kingstate Electronics (Dongguan) Co., Ltd.
Address	:	Shi Chong Industrial Park, Shi Chong Avenue, Xiang Xi Village, Shi Pai Town, Dong Guan City, Guang Dong Province, China

Issued By: Dongguan Dongdian Testing Service Co., Ltd.

Add: No. 17, Zongbu Road 2, Songshan Lake Sci&Tech, Industry Park, Dongguan City,
Guangdong Province, China, 523808

Tel: +86-0769-22891499 [Http://www.dgddt.com](http://www.dgddt.com)

REPORT

TABLE OF CONTENTS

	Test report declares.....	4
1.	Summary of test results	5
2.	General test information.....	6
2.1.	Description of EUT	6
2.2.	Accessories of EUT.....	6
2.3.	Assistant equipment used for test.....	6
2.4.	Block diagram of EUT configuration for test	6
2.5.	Deviations of test standard	7
2.6.	Test environment conditions	7
2.7.	Test laboratory.....	7
2.8.	Measurement uncertainty	8
3.	Equipment used during test.....	9
4.	Maximum Peak Output Power	10
4.1.	Block diagram of test setup.....	10
4.2.	Limits	10
4.3.	Test Procedure.....	10
4.4.	Test Result.....	10
5.	20dB Bandwidth and 99% Bandwidth	11
5.1.	Block diagram of test setup.....	11
5.2.	Limits	11
5.3.	Test Procedure.....	11
5.4.	Test Result.....	11
5.5.	Original test data	12
6.	Carrier Frequency Separation.....	14
6.1.	Block diagram of test setup.....	14
6.2.	Limits	14
6.3.	Test Procedure.....	14
6.4.	Test Result.....	14
6.5.	Original test data	14
7.	Number Of Hopping Channel	15
7.1.	Block diagram of test setup.....	15
7.2.	Limits	15
7.3.	Test Procedure.....	15
7.4.	Test Result.....	15
7.5.	Original test data	15
8.	Dwell Time.....	17
8.1.	Block diagram of test setup	17

8.2.	Limits	17
8.3.	Test Procedure.....	17
8.4.	Test Result.....	17
8.5.	Original test data	18
9.	Radiated emission	20
9.1.	Block diagram of test setup	20
9.2.	Limit	21
9.3.	Test Procedure.....	22
9.4.	Test result	23
10.	Band Edge Compliance (radiated method)	27
10.1.	Block diagram of test setup	27
10.2.	Limit	27
10.3.	Test Procedure.....	27
10.4.	Test result	27
11.	Band Edge Compliance (conducted method).....	36
11.1.	Block diagram of test setup.....	36
11.2.	Limit	36
11.3.	Test result	36
11.4.	Original test data	36
12.	Power Line Conducted Emission	40
12.1.	Block diagram of test setup	40
12.2.	Power Line Conducted Emission Limits(Class B).....	40
12.3.	Test Procedure.....	40
12.4.	Test Result.....	41
13.	Antenna Requirements	44
13.1.	Limit	44
13.2.	Result.....	44
14.	Test setup photograph	45
15.	Photos of the EUT	47

TEST REPORT DECLARE

Applicant	:	Kingstate Electronics (Dongguan) Co., Ltd.
Address	:	Shi Chong Industrial Park, Shi Chong Avenue, Xiang Xi Village, Shi Pai Town, Dong Guan City, Guang Dong Province, China
Equipment under Test	:	Bluetooth Headset
Model No.	:	HA-FX39BT
Trade Mark	:	JVC
Manufacturer	:	Kingstate Electronics (Dongguan) Co., Ltd.
Address	:	Shi Chong Industrial Park, Shi Chong Avenue, Xiang Xi Village, Shi Pai Town, Dong Guan City, Guang Dong Province, China

Test Standard Used:

FCC Rules and Regulations Part 15 Subpart C: 2015, RSS-247 Issue 1 May 2015.

Test procedure used:

ANSI C63.10:2013, ANSI C63.4:2014, RSS-Gen Issue 4, Nov. 2014.

We Declare:

The equipment described above is tested by Dongguan Dongdian Testing Service Co., Ltd and in the configuration tested the equipment complied with the standards specified above. The test results are contained in this test report and Dongguan Dongdian Testing Service Co., Ltd is assumed of full responsibility for the accuracy and completeness of these tests.

After test and evaluation, our opinion is that the equipment provided for test compliance with the requirement of the above FCC&IC standards.

Report No:	DDT-R16Q1114-2E2		
Date of Test:	Nov. 15, 2016 ~ Dec. 2, 2016	Date of Report:	Dec. 2, 2016

Prepared By:



Leo Liu/Engineer



Kevin Peng/EMC Manager

Note: This report applies to above tested sample only. This report shall not be reproduced in parts without written approval of Dongguan Dongdian Testing Service Co., Ltd.

1. Summary of test results

Description of Test Item	Standard	Results
Maximum Peak Output Power	FCC Part 15: 15.247(b)(1) ANSI C63.10:2013 ANSI C63.4:2014 RSS-247 Issue 1 clause 5.1	PASS
20dB Bandwidth and 99% Bandwidth	FCC Part 15: 15.215 ANSI C63.10:2013 ANSI C63.4:2014 RSS-247 Issue 1 clause 5.1	PASS
Carrier Frequency Separation	FCC Part 15: 15.247(a)(1) ANSI C63.10:2013 ANSI C63.4:2014 RSS-247 Issue 1 clause 5.1	PASS
Number Of Hopping Channel	FCC Part 15: 15.247(a)(1)(iii) ANSI C63.10:2013 ANSI C63.4:2014 RSS-247 Issue 1 clause 5.1	PASS
Dwell Time	FCC Part 15: 15.247(a)(1)(iii) ANSI C63.10:2013 ANSI C63.4:2014 RSS-247 Issue 1 clause 5.1	PASS
Radiated Emission	FCC Part 15: 15.209 FCC Part 15: 15.247(d) ANSI C63.10:2013 ANSI C63.4:2014 RSS-247 Issue 1 clause 5.1 RSS-Gen Issue 4 clause 7.2.2 RSS-Gen Issue 4 clause 7.2.5	PASS
Band Edge Compliance	FCC Part 15: 15.247(d) ANSI C63.10:2013 ANSI C63.4:2014 RSS-247 Issue 1 clause 5.1 RSS-Gen Issue 4 clause 7.2.2 RSS-Gen Issue 4 clause 7.2.5	PASS
Power Line Conducted Emissions	FCC Part 15: 15.207 ANSI C63.10:2013 ANSI C63.4:2014 RSS-Gen Issue 4 clause 7.2.4	PASS
Antenna requirement	FCC Part 15: 15.203 ANSI C63.4:2014 RSS-Gen Issue 4 clause 7.1.2	PASS

2. General test information

2.1. Description of EUT

EUT* Name	: Bluetooth Headset
Model Number	: HA-FX39BT
EUT function description	: Please reference user manual of this device
Power supply	: DC 3.7V from built-in battery DC 5V from Adapter input AC 120V/60Hz
Radio Specification	: Bluetooth V3.0+EDR
Operation frequency	: 2402MHz -2480MHz
Modulation	: GFSK, $\pi/4$ QPSK, 8-DPSK
Data rate	: 1Mbps, 2Mbps, 3Mbps
Antenna Type	: Integrated antenna, maximum PK gain: 3.09 dBi
Date of Receipt	: Nov. 15, 2016
Sample Type	: Series production

Note: EUT is the ab. of equipment under test.

2.2. Accessories of EUT

Description of Accessories	Manufacturer	Model number or Type	Serial No.	Other
/	/	/	/	/

2.3. Assistant equipment used for test

Description of Assistant equipment	Manufacturer	Model number or Type	EMC Compliance	Other
Adapter	GPT	F5V-2.3C-1U	/	Output: 5V/2.3A

2.4. Block diagram of EUT configuration for test



Test software: BlueSuite2.6.0

The test software was used to control EUT work in Continuous TX mode, and select test channel, wireless mode as blow table.

Tested mode, channel, information		
Mode	Channel	Frequency (MHz)
GFSK hopping on Tx Mode	CH0 to CH78	2402 to 2480
$\pi/4$ QPSK Hopping on TX mode	CH0 to CH78	2402 to 2480
8-DPSK hopping on Tx Mode	CH0 to CH78	2402 to 2480
GFSK hopping off Tx Mode	CH0	2402
	CH39	2441
	CH78	2480
$\pi/4$ QPSK hopping off Tx Mode	CH0	2402
	CH39	2441
	CH78	2480
8-DPSK hopping off Tx Mode	CH0	2402
	CH39	2441
	CH78	2480

Note: For $\pi/4$ QPSK its same modulation type with 8-DPSK, and based exploratory test, there is no significant difference of that two types test result, so except output power, all other items final test were only performed with the worse case 8-DPSK and GFSK.

2.5. Deviations of test standard

No Deviation.

2.6. Test environment conditions

During the measurement the environmental conditions were within the listed ranges:

Temperature range:	21-25°C
Humidity range:	40-75%
Pressure range:	86-106kPa

2.7. Test laboratory

Dongguan Dongdian Testing Service Co., Ltd

Add: No. 17, Zongbu Road 2, Songshan Lake Sci&Tech, Industry Park, Dongguan City, Guangdong Province, China, 523808 Tel: +86-0769-22891499 <http://www.dgddt.com>

FCC Registration Number: 270092 Industry Canada site registration number: 10288A-1

2.8. Measurement uncertainty

Test Item	Uncertainty
Bandwidth	1.1%
Peak Output Power(Conducted)(Spectrum analyzer)	0.86dB(10 MHz \leq f < 3.6GHz);
	1.38dB(3.6GHz \leq f < 8GHz)
Peak Output Power(Conducted)(Power Sensor)	0.74dB
Power Spectral Density	0.74dB(10 MHz \leq f < 3.6GHz);
	1.38dB(3.6GHz \leq f < 8GHz)
Conducted spurious emissions	0.86dB(10 MHz \leq f < 3.6GHz);
	1.40dB(3.6GHz \leq f < 8GHz)
	1.66dB(8GHz \leq f < 22GHz)
Uncertainty for radio frequency (RBW<20KHz)	3×10^{-8}
Temperature	0.4°C
Humidity	2%
Uncertainty for Radiation Emission test (30MHz-1GHz)	4.70 dB (Antenna Polarize: V)
	4.84 dB (Antenna Polarize: H)
Uncertainty for Radiation Emission test (1GHz-18GHz)	4.10dB(1-6GHz)
	4.40dB (6GHz-18Gz)
Uncertainty for Power line conduction emission test	3.32dB (150KHz-30MHz)
Note: This uncertainty represents an expanded uncertainty expressed at approximately the 95% confidence level using a coverage factor of k=2.	

3. Equipment used during test

Equipment	Manufacturer	Model No.	Serial No.	Last Cal.	Cal. Interval
RF Connected test					
Spectrum analyzer	R&S	FSU26	1166.1660.26	2016/10/16	1Year
Vertor Signal Generator	Agilent	E8267D	MY52098743	2016/10/20	1Year
Vector Signal Generator	Agilent	N5182A	MY48180737	2016/07/05	1Year
Power Sensor	Agilent	U2021XA	MY55150010	2016/04/18	1Year
Power Sensor	Agilent	U2021XA	MY55150011	2016/04/19	1Year
DC Power Source	MATRIS	MPS-3005L-3	D813058W	2016/10/24	1Year
Attenuator	Mini-Circuits	BW-S10W2	101109	2016/08/18	1Year
RF Cable	Micable	C10-01-01-1	100309	2016/08/18	1Year
Temp&Humi Programmable Chamber	Dongguan Bell	BE-TH-150M3	201208153364	2016/09/23	1Year
Test Software	JS Tonscend	JS1120-2	Ver.2.5	N/A	N/A
USB Data acquisition	Agilent	U2531A	TW55043503	N/A	N/A
Auto control Unit	JS Tonscend	JS0806-2	158060010	N/A	N/A
RE/RF in chamber					
EMI Test Receiver	R&S	ESU8	100316	2016/10/16	1Year
Spectrum analyzer	R&S	FSU26	1166.1660.26	2016/10/16	1Year
Trilog Broadband Antenna	Schwarzbeck	VULB9163	9163-462	2016/10/27	1 Year
Active Loop antenna	Schwarzbeck	FMZB-1519	1519-038	2016/10/27	1 Year
Double Ridged Horn Antenna	R&S	HF907	100276	2016/10/12	1 Year
Pre-amplifier	A.H.	PAM-0118	360	2016/10/16	1 Year
RF Cable	HUBSER	CP-X2	W11.03	2016/10/16	1Year
RF Cable	HUBSER	CP-X1	W12.02	2016/10/16	1 Year
MI Cable	HUBSER	C10-01-01-1M	1091629	2016/10/16	1 Year
Test software	Audix	E3	V 6.11111b	/	/
Conducted disturbance at mains terminals/Telecommunication port					
Test Receiver	R&S	ESU8	100316	2016/10/16	1 Year
LISN 1	R&S	ENV216	101109	2016/10/16	1 Year
LISN 2	R&S	ESH2-Z5	100309	2016/10/16	1 Year
8 Line ISN	R&S	ENY81	100063	2016/10/16	1Year
Pulse Limiter	R&S	ESH3-Z2	101242	2016/10/16	1 Year
CE Cable 1	HUBSER	ESU8/RF2	W10.01	2016/10/16	1 Year
Test software	Audix	E3	V 6.11111b	/	/

4. Maximum Peak Output Power

4.1. Block diagram of test setup

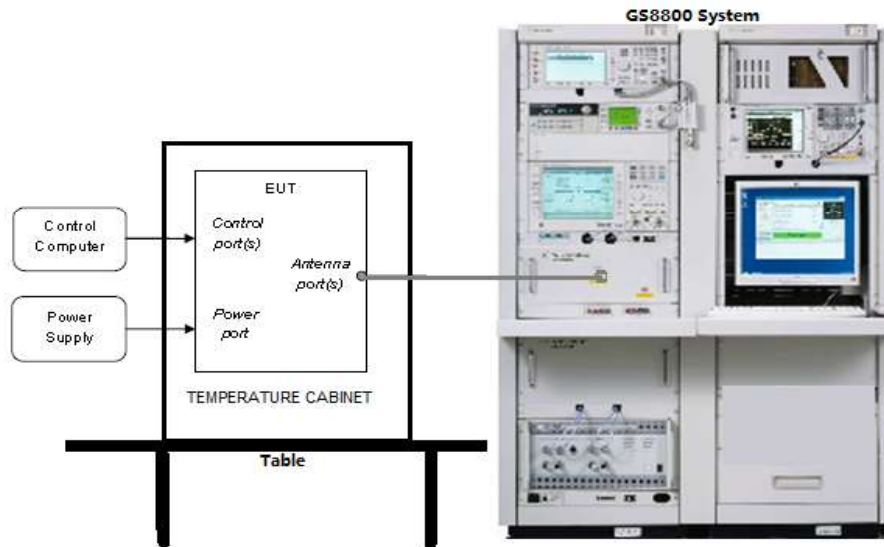

4.2. Limits

For frequency hopping systems operating in the 2400-2483.5 MHz band employing at least 75 non-overlapping hopping channels, and all frequency hopping systems in the 5725-5850 MHz band: 1 watt. For all other frequency hopping systems in the 2400-2483.5 MHz band: 0.125 watts, the e.i.r.p shall not exceed 4W.

4.3. Test Procedure

- (1) Connect EUT's antenna output to spectrum analyzer by RF cable.
- (2) Measure the maximum output power of EUT by spectrum analyzer with PK detector and RBW=2MHz(above 20dB bandwidth of measured signal), VBW=3MHz

Note: The attenuator loss was inputted into spectrum analyzer as amplitude offset.

4.4. Test Result

Mode	Freq (MHz)	Result (dBm)	Limit (dBm)	Conclusion
GFSK	2402	-0.080	21	PASS
	2441	0.120	21	PASS
	2480	0.210	21	PASS
8-DPSK	2402	1.810	21	PASS
	2441	0.440	21	PASS
	2480	0.670	21	PASS
Test Date : Nov. 16, 2016				Test Engineer : Toby Ren

5. 20dB Bandwidth and 99% Bandwidth

5.1. Block diagram of test setup

Same as section 4.1

5.2. Limits

Intentional radiators operating under the alternative provisions to the general emission limits, as contained in § 15.217 through 15.257 and in Subpart E of this part, must be designed to ensure that the 20 dB bandwidth of the emission, or whatever bandwidth may otherwise be specified in the specific rule section under which the equipment operates, is contained within the frequency band designated in the rule section under which the equipment is operated.

5.3. Test Procedure

- (1) Connect EUT's antenna output to spectrum analyzer by RF cable.
- (2) The bandwidth of the fundamental frequency was measured by spectrum analyzer with 30 kHz RBW and 100 kHz VBW. The 20dB bandwidth is defined as the total spectrum the power of which is higher than peak power minus 20dB.

5.4. Test Result

Mode	Freq (MHz)	20dB bandwidth Result (MHz)	99% bandwidth Result (MHz)	Limit (MHz)	Margin (MHz)	Conclusion
GFSK	2402	1.126	0.982	/	/	PASS
	2441	1.120	0.982	/	/	PASS
	2480	1.124	0.982	/	/	PASS
8-DPSK	2402	1.376	1.216	/	/	PASS
	2441	1.376	1.214	/	/	PASS
	2480	1.370	1.218	/	/	PASS
Test Date : Nov. 16, 2016				Test Engineer: Leo		

5.5. Original test data

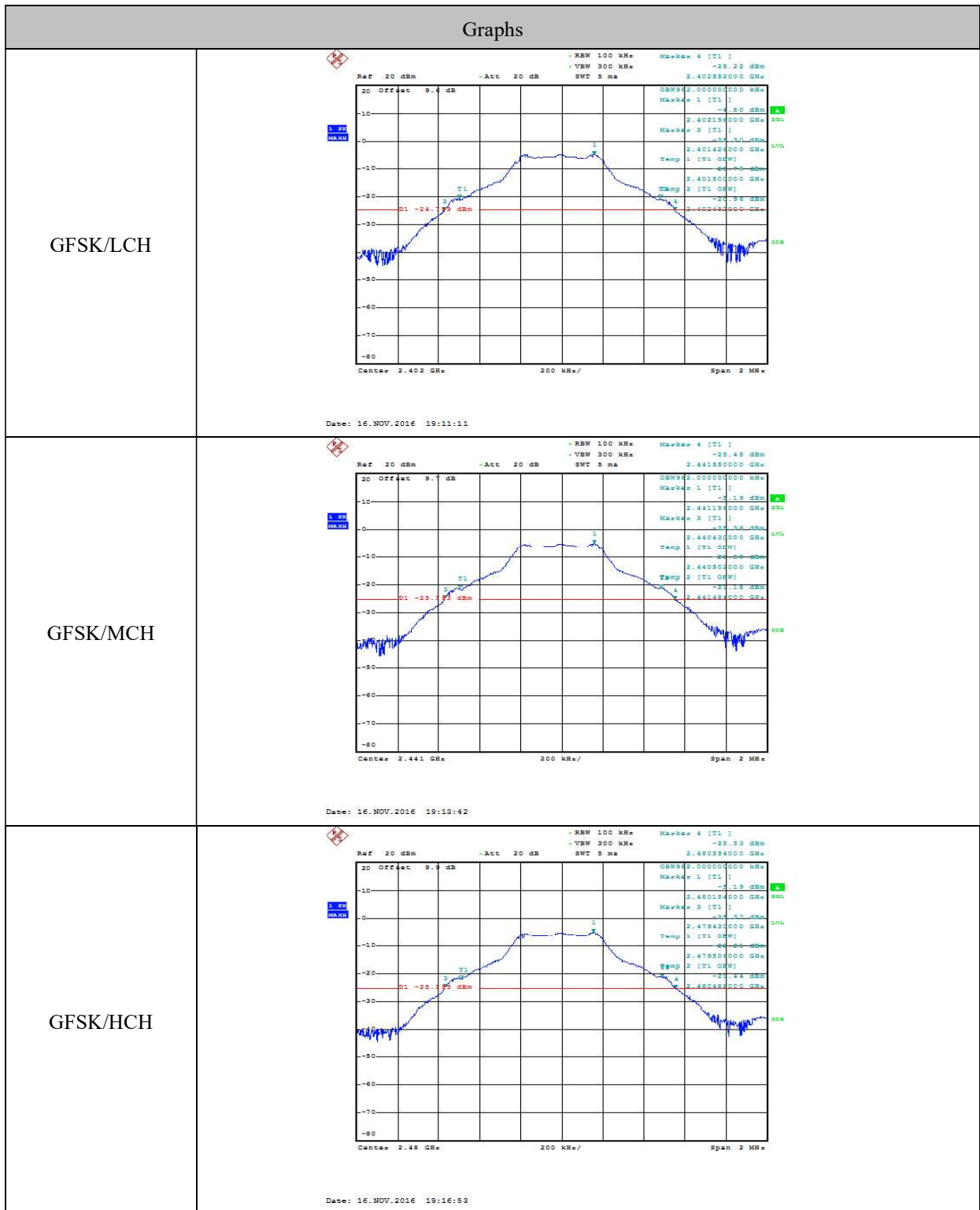

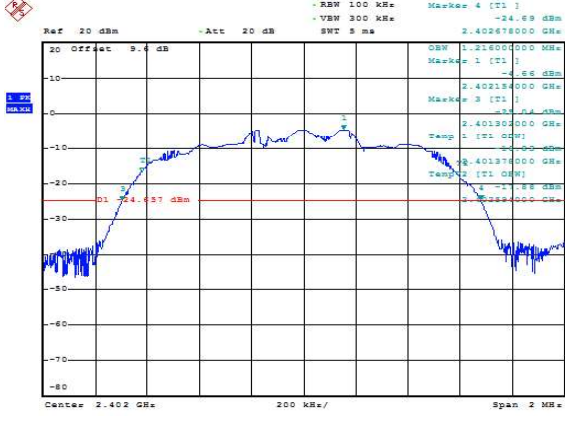
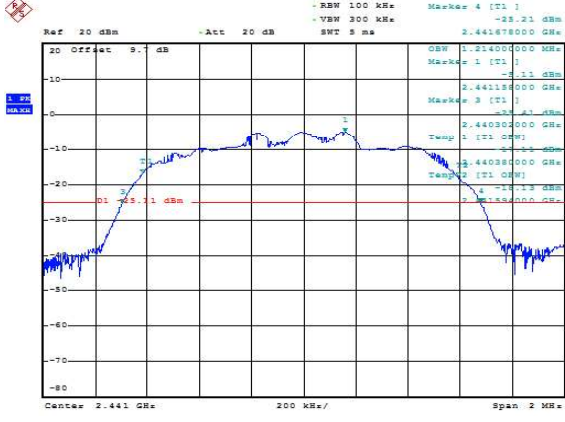
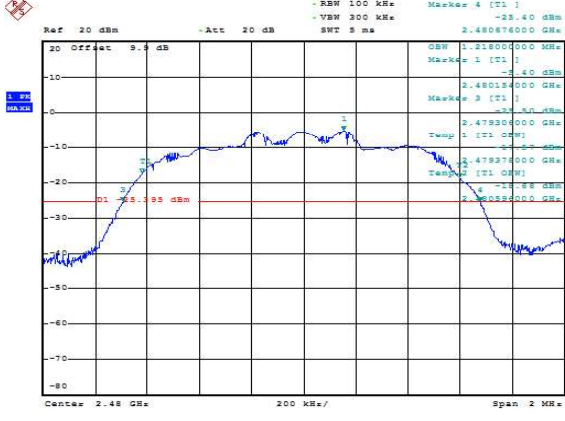
<p>8DPSK/LCH</p>	 <p>Ref 20 dBm -Att 20 dB -RBW 100 KHz -VBW 300 KHz SWT 5 ms</p> <p>OSW 1.21600000 MHz -24.69 dBm Marker 1 [T1] 2.40215000 GHz -24.69 dBm Marker 3 [T1] 2.40230000 GHz Temp 1 [T1 OFF] 2.40137000 GHz Temp 2 [T1 OFF] 2.40229000 GHz</p> <p>Center 2.402 GHz 200 kHz/ Span 2 MHz</p> <p>Date: 16.NOV.2016 19:18:32</p>
<p>8DPSK/MCH</p>	 <p>Ref 20 dBm -Att 20 dB -RBW 100 KHz -VBW 300 KHz SWT 5 ms</p> <p>OSW 1.22400000 MHz -25.21 dBm Marker 1 [T1] 2.44115000 GHz -25.21 dBm Marker 3 [T1] 2.44030000 GHz Temp 1 [T1 OFF] 2.44038000 GHz Temp 2 [T1 OFF] 2.44113000 GHz</p> <p>Center 2.441 GHz 200 kHz/ Span 2 MHz</p> <p>Date: 16.NOV.2016 19:20:10</p>
<p>8DPSK/HCH</p>	 <p>Ref 20 dBm -Att 20 dB -RBW 100 KHz -VBW 300 KHz SWT 5 ms</p> <p>OSW 1.23200000 MHz -25.40 dBm Marker 1 [T1] 2.48015000 GHz -25.40 dBm Marker 3 [T1] 2.47930000 GHz Temp 1 [T1 OFF] 2.47937000 GHz Temp 2 [T1 OFF] 2.48029000 GHz</p> <p>Center 2.48 GHz 200 kHz/ Span 2 MHz</p> <p>Date: 16.NOV.2016 19:21:42</p>

6. Carrier Frequency Separation

6.1. Block diagram of test setup

Same as section 4.1

6.2. Limits

Frequency hopping systems shall have hopping channel carrier frequencies separated by a minimum of 25 kHz or the 20 dB bandwidth of the hopping channel, whichever is greater. Alternatively, frequency hopping systems operating in the 2400-2483.5 MHz band may have hopping channel carrier frequencies that are separated by 25 kHz or two-thirds of the 20 dB bandwidth of the hopping channel, whichever is greater, provided the systems operate with an output power no greater than 125 mW.

6.3. Test Procedure

- (1) Connect EUT's antenna output to spectrum analyzer by RF cable.
- (2) The carrier frequency was measured by spectrum analyzer with 100 KHz RBW and 300 KHz VBW.

6.4. Test Result

Mode	Channel separation (MHz)	20dB Bandwidth (MHz)	Limit (MHz) 2/3 of 20dB bandwidth	Conclusion
GFSK	0.848	1.126	0.751	PASS
8-DPSK	1.000	1.376	0.917	PASS

Test Date : Nov. 16, 2016 Test Engineer : Toby Ren

6.5. Original test data

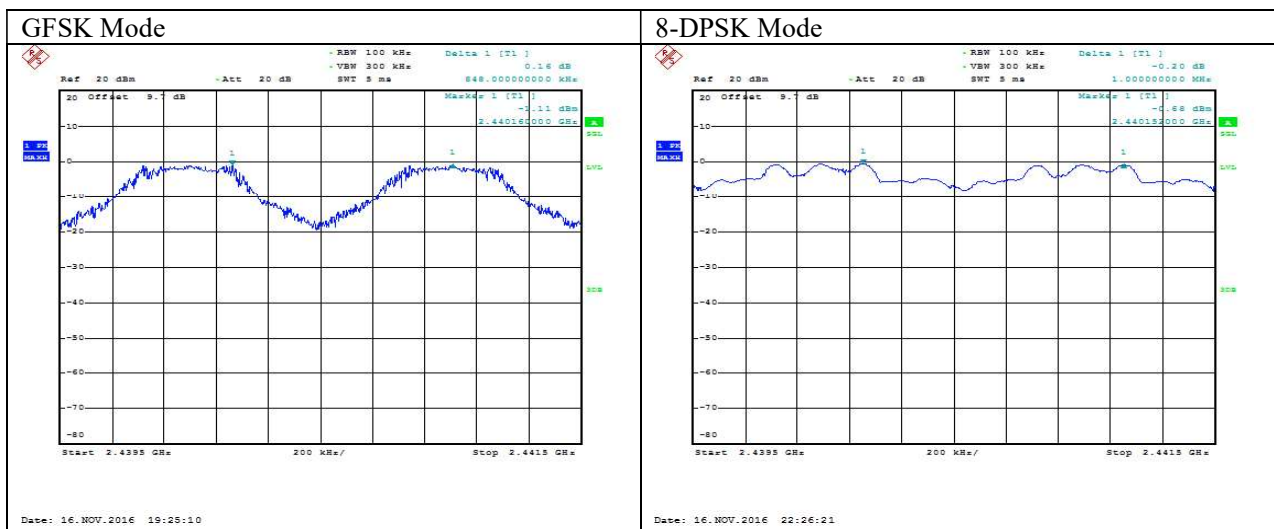

7. Number Of Hopping Channel

7.1. Block diagram of test setup

Same as section 4.1

7.2. Limits

Frequency hopping systems in the 2400-2483.5 MHz band shall use at least 15 channels.

7.3. Test Procedure

- (1) Connect EUT's antenna output to spectrum analyzer by RF cable.
- (2) The number of hopping channel was measured by spectrum analyzer with 100 kHz RBW and 300KHz VBW.

7.4. Test Result

Mode	Number of hopping channel	Limit	Conclusion
GFSK	79	>15	PASS
8-DPSK	79	>15	PASS
Test Date : Nov. 16, 2016		Test Engineer : Toby Ren	

7.5. Original test data

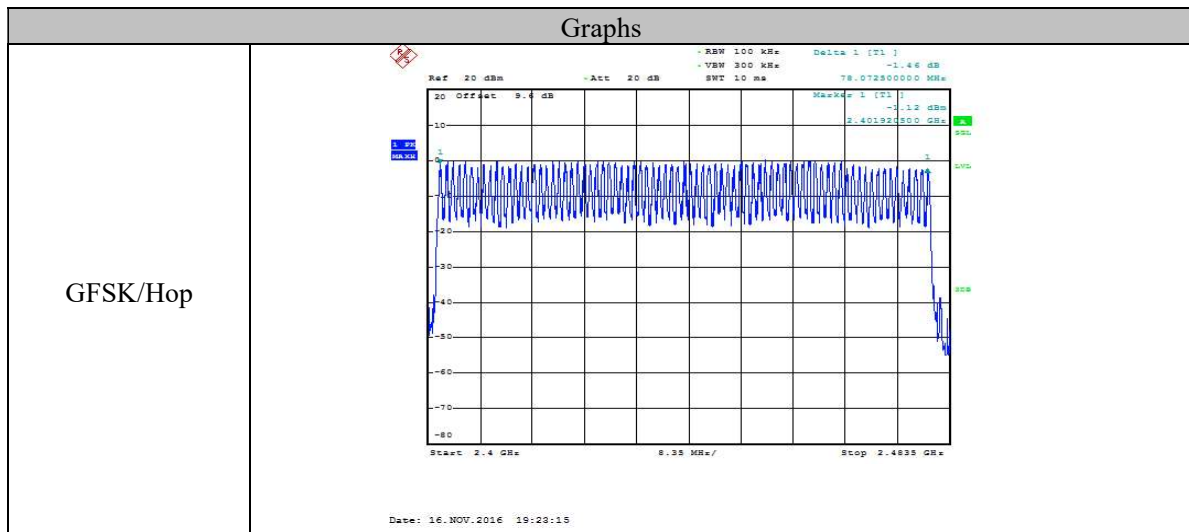

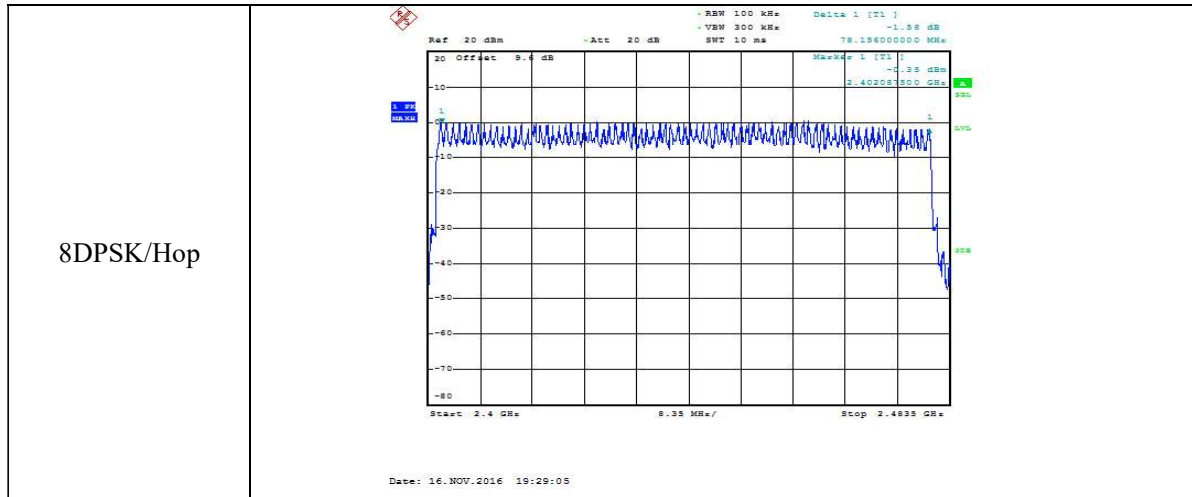

8. Dwell Time

8.1. Block diagram of test setup

Same as section 4.1

8.2. Limits

The average time of occupancy on any channel shall not be greater than 0.4 seconds within a period of 0.4 seconds multiplied by the number of hopping channels employed.

8.3. Test Procedure

- (1) Connect EUT's antenna output to spectrum analyzer by RF cable.
- (2) Measure the hopping number and on time of each pulse with spectrum analyzer in zero span set, and calculate dwell time with formula Dwell time = total hops *pulse's on time.

DH1 Packet permit maximum $1600 / 79 / 2 = 10.12$ hops per second in each channel (1 time slot RX, 1 time slot TX). So, total hops is $10.12 \times 31.6 = 320$.

DH3 Packet permit maximum $1600 / 79 / 4 = 5.06$ hops per second in each channel (3 time slots RX, 1 time slot TX). So, total hops is $5.06 \times 31.6 = 160$.

DH5 Packet permit maximum $1600 / 79 / 6 = 3.37$ hops per second in each channel (5 time slots RX, 1 time slot TX). So, total hops is $3.37 \times 31.6 = 106.6$.

3DH1 Packet permit maximum $1600 / 79 / 2 = 10.12$ hops per second in each channel (1 time slot RX, 1 time slot TX). So, total hops is $10.12 \times 31.6 = 320$.

3DH3 Packet permit maximum $1600 / 79 / 4 = 5.06$ hops per second in each channel (3 time slots RX, 1 time slot TX). So, total hops is $5.06 \times 31.6 = 160$.

3DH5 Packet permit maximum $1600 / 79 / 6 = 3.37$ hops per second in each channel (5 time slots RX, 1 time slot TX). So, total hops is $3.37 \times 31.6 = 106.6$.

8.4. Test Result

Mode	Pulse's on time (ms)	Total hops	Dwell time (s)	Limit	Conclusion
DH1	0.41	320	0.131	<400ms	PASS
DH3	1.66	160	0.266	<400ms	PASS
DH5	2.91	106.6	0.310	<400ms	PASS
3-DH1	0.42	320	0.134	<400ms	PASS
3-DH3	1.67	160	0.267	<400ms	PASS
3-DH5	2.92	106.6	0.312	<400ms	PASS
Test Date : Nov. 16, 2016			Test Engineer : Toby Ren		
Note: Dwell time = total hops *pulse's on time.					

8.5. Original test data

Graphs	
GFSK_DH1/MCH	<p>Ref 20 dBm -Att 20 dB RBW 1 MHz -VSW 3 MHz SWT 10 ms</p> <p>Marker 3 [D1] -14.96 GHz 2.160000 ms</p> <p>Marker 1 [D1] -14.78 GHz 890.000000 us</p> <p>Marker 2 [D1] -14.18 GHz 1.1370000 ms</p> <p>Center 2.441 GHz 1 ms/</p> <p>Date: 16.NOV.2016 19:36:02</p>
GFSK_DH3/MCH	<p>Ref 20 dBm -Att 20 dB RBW 1 MHz -VSW 3 MHz SWT 10 ms</p> <p>Marker 3 [D1] -14.92 GHz 3.780000 ms</p> <p>Marker 1 [D1] -14.88 GHz 1.280000 ms</p> <p>Marker 2 [D1] -14.13 GHz 1.1370000 ms</p> <p>Center 2.441 GHz 1 ms/</p> <p>Date: 16.NOV.2016 19:36:31</p>
GFSK_DH5/MCH	<p>Ref 20 dBm -Att 20 dB RBW 1 MHz -VSW 3 MHz SWT 10 ms</p> <p>Marker 3 [D1] -14.86 GHz 5.680000 ms</p> <p>Marker 1 [D1] -14.88 GHz 1.700000 ms</p> <p>Marker 2 [D1] -14.13 GHz 1.1370000 ms</p> <p>Center 2.441 GHz 1 ms/</p> <p>Date: 16.NOV.2016 19:36:57</p>

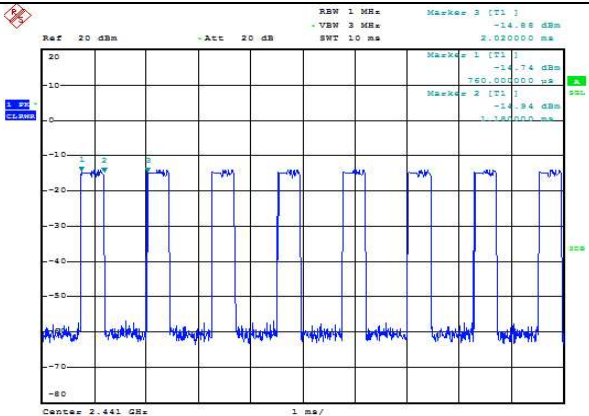
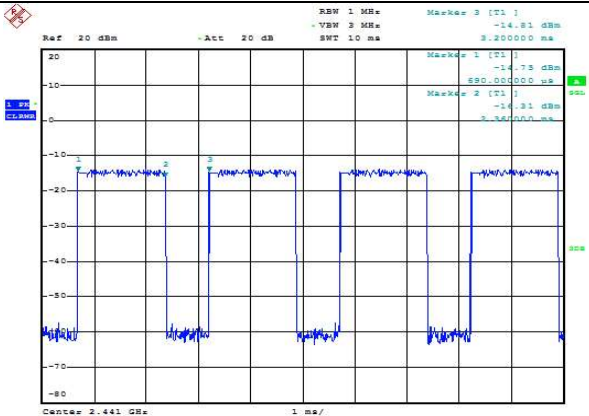
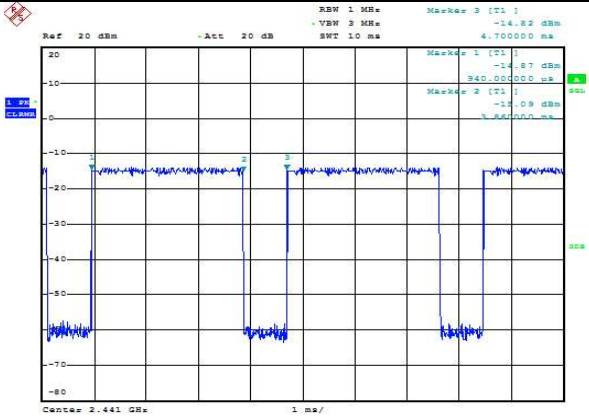
<p>8-DPSK_3DH1/MCH</p>	 <p>Ref 20 dBm -Att 20 dB RBW 1 MHz Marker 3 [T1] -14.88 dBm -VSW 3 MHz SWT 10 ms 2.000000 ms Marker 1 [T1] -14.74 dBm 760.000000 us Marker 2 [T1] -14.94 dBm 1.166667 ms Center 2.441 GHz 1 ms/</p> <p>Date: 16.NOV.2016 19:37:24</p>
<p>8-DPSK_3DH3/MCH</p>	 <p>Ref 20 dBm -Att 20 dB RBW 1 MHz Marker 3 [T1] -14.81 dBm -VSW 3 MHz SWT 10 ms 3.000000 ms Marker 1 [T1] -14.73 dBm 880.000000 us Marker 2 [T1] -14.31 dBm 1.166667 ms Center 2.441 GHz 1 ms/</p> <p>Date: 16.NOV.2016 19:37:50</p>
<p>8-DPSK_3DH5/MCH</p>	 <p>Ref 20 dBm -Att 20 dB RBW 1 MHz Marker 3 [T1] -14.82 dBm -VSW 3 MHz SWT 10 ms 4.700000 ms Marker 1 [T1] -14.87 dBm 940.000000 us Marker 2 [T1] -14.59 dBm 1.166667 ms Center 2.441 GHz 1 ms/</p> <p>Date: 16.NOV.2016 19:38:13</p>

9. Radiated emission

9.1. Block diagram of test setup

In 3m Anechoic Chamber Test Setup Diagram for 9KHz-30MHz

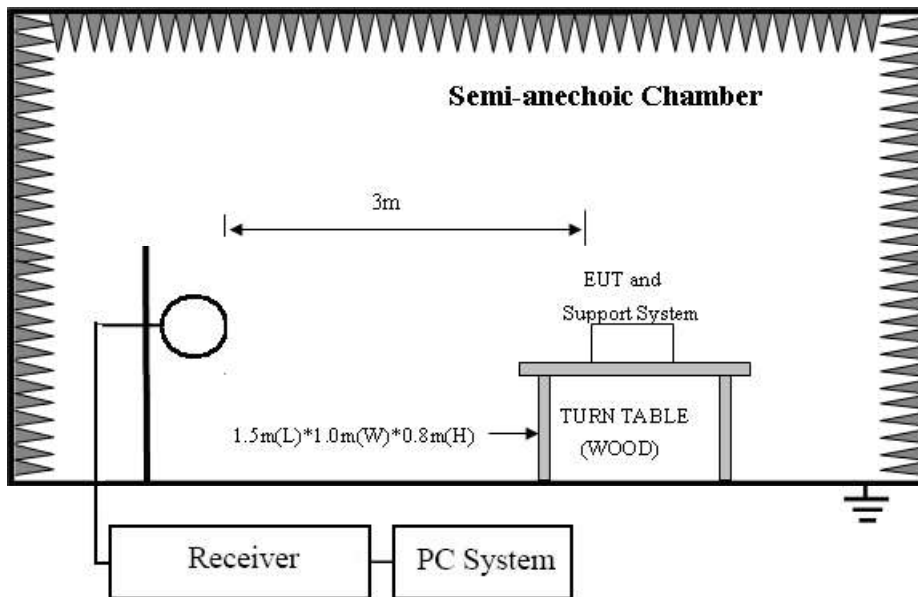

In 3m Anechoic Chamber Test Setup Diagram for below 1GHz

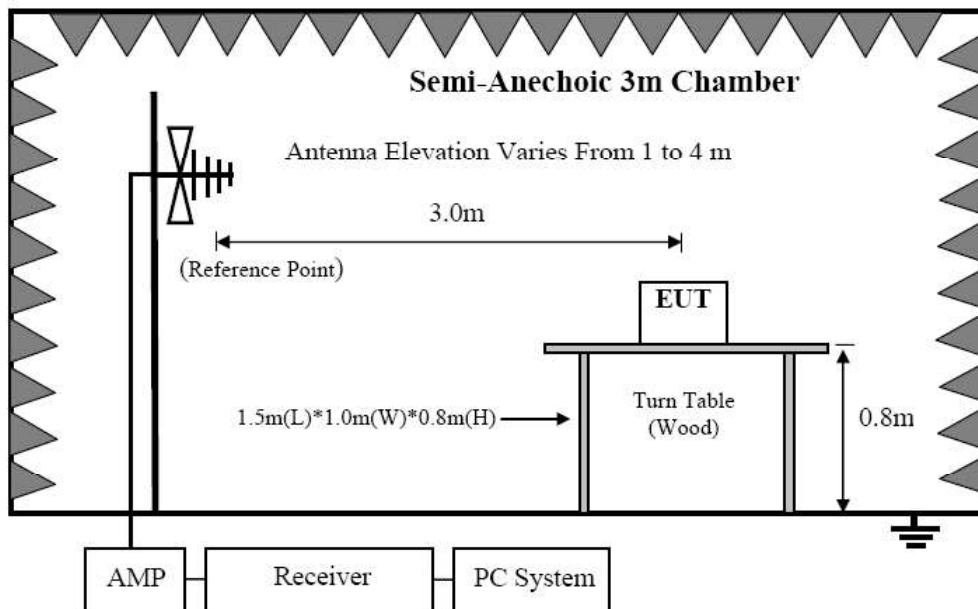

In 3m Anechoic Chamber Test Setup Diagram for frequency above 1GHz

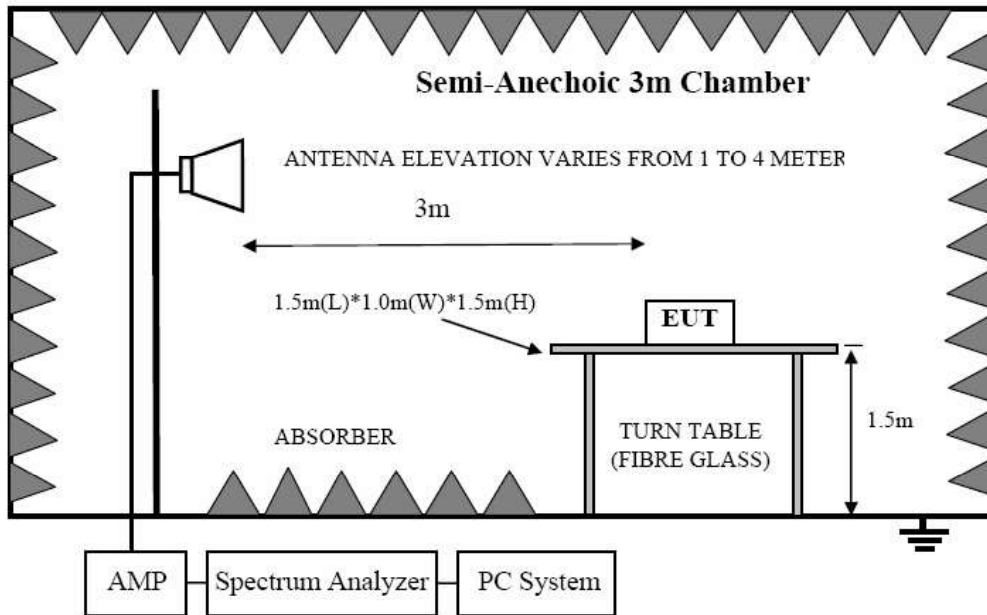

Note: For harmonic emissions test a appropriate high pass filter was inserted in the input port of AMP.

9.2. Limit

9.2.1 FCC 15.205 Restricted frequency band

MHz	MHz	MHz	GHz
0.090 - 0.110	16.42 - 16.423	399.9 - 410	4.5 - 5.15
¹ 0.495 - 0.505	16.69475 - 16.69525	608 - 614	5.35 - 5.46
2.1735 - 2.1905	16.80425 - 16.80475	960 - 1240	7.25 - 7.75
4.125 - 4.128	25.5 - 25.67	1300 - 1427	8.025 - 8.5
4.17725 - 4.17775	37.5 - 38.25	1435 - 1626.5	9.0 - 9.2
4.20725 - 4.20775	73 - 74.6	1645.5 - 1646.5	9.3 - 9.5
6.215 - 6.218	74.8 - 75.2	1660 - 1710	10.6 - 12.7
6.26775 - 6.26825	108 - 121.94	1718.8 - 1722.2	13.25 - 13.4
6.31175 - 6.31225	123 - 138	2200 - 2300	14.47 - 14.5
8.291 - 8.294	149.9 - 150.05	2310 - 2390	15.35 - 16.2
8.362 - 8.366	156.52475 - 156.52525	2483.5 - 2500	17.7 - 21.4
8.37625 - 8.38675	156.7 - 156.9	2690 - 2900	22.01 - 23.12
8.41425 - 8.41475	162.0125 - 167.17	3260 - 3267	23.6 - 24.0
12.29 - 12.293	167.72 - 173.2	3332 - 3339	31.2 - 31.8
12.51975 - 12.52025	240 - 285	3345.8 - 3358	36.43 - 36.5
12.57675 - 12.57725	322 - 335.4	3600 - 4400	(²)

9.2.2 FCC 15.209 Limit.

FREQUENCY MHz	DISTANCE Meters	FIELD STRENGTHS LIMIT	
		μV/m	dB(μV)/m
0.009 ~ 0.490	300	2400/F(KHz)	67.6-20log(F)
0.490 ~ 1.705	30	24000/F(KHz)	87.6-20log(F)
1.705 ~ 30.0	30	30	29.54
30 ~ 88	3	100	40.0
88 ~ 216	3	150	43.5
216 ~ 960	3	200	46.0
960 ~ 1000	3	500	54.0

Above 1000	3	74.0 dB(μ V)/m (Peak) 54.0 dB(μ V)/m (Average)
------------	---	---

Note: (1)The emission limits shown in the above table are based on measurements employing a CISPR QP detector except for the frequency bands 9-90KHz, 110-490KHz and above 1000MHz. Radiated emissions limits in these three bands are based on measurements employing an average detector.

(2) At frequencies below 30MHz, measurement may be performed at a distance closer then that specified, and the limit at closer measurement distance can be extrapolated by below formula:

$$\text{Limit}_{3m}(\text{dBuV/m}) = \text{Limit}_{30m}(\text{dBuV/m}) + 40\text{Log}(30\text{m}/3\text{m})$$

9.2.3 Limit for this EUT

All the emissions appearing within 15.205 restricted frequency bands shall not exceed the limits shown in 15.209, all the other emissions shall be at least 20dB below the fundamental emissions, or comply with 15.209 limits.

9.3. Test Procedure

- (1) EUT was placed on a non-metallic table, 150 cm above the ground plane inside a semi-anechoic chamber.
- (2) Test antenna was located 3m from the EUT on an adjustable mast, and the antenna used as below table.

Test frequency range	Test antenna used
9KHz-30MHz	Active Loop antenna
30MHz-1GHz	Trilog Broadband Antenna
1GHz-18GHz	Double Ridged Horn Antenna(1GHz-18GHz)
18GHz-40GHz	Horn Antenna(18GHz-40GHz)

According ANSI C63.10:2013 clause 6.4.4.2 and 6,5.3, for measurements below 30 MHz, the loop antenna was positioned with its plane vertical from the EUT and rotated about its vertical axis for maximum response at each azimuth position around the EUT. And the loop antenna also be positioned with its plane horizontal at the specified distance from the EUT. The center of the loop is 1 m above the ground. for measurement above 30MHz, the Trilog Broadband Antenna or Horn Antenna was located 3m from EUT, Measurements were made with the antenna positioned in both the horizontal and vertical planes of Polarization, and the measurement antenna was varied from 1 m to 4 m. in height above the reference ground plane to obtain the maximum signal strength.

(3) Below pre-scan procedure was first performed in order to find prominent frequency spectrum radiated emissions from 9KHz to 25GHz:

- (a) Scanning the peak frequency spectrum with the antenna specified in step (3), and the EUT was rotated 360 degree, the antenna height was varied from 1m to 4m(Except loop antenna, it's fixed 1m above ground.)
- (b) Change work frequency or channel of device if practicable.
- (c) Change modulation type of device if practicable.
- (d) Change power supply range from 85% to 115% of the rated supply voltage
- (e) Rotated EUT though three orthogonal axes to determine the attitude of EUT arrangement produces

highest emissions.

Spectrum frequency from 9KHz to 25GHz (tenth harmonic of fundamental frequency) was investigated, and no any obvious emission were detected from 18GHz to 25GHz, so below final test was performed with frequency range from 9KHz to 18GHz.

- (4) For final emissions measurements at each frequency of interest, the EUT was rotated and the antenna height was varied between 1m and 4m in order to maximize the emission. Measurements in both horizontal and vertical polarities were made and the data was recorded. In order to find the maximum emission, the relative positions of equipments and all of the interface cables were changed according to ANSI C63.10 2013 on Radiated Emission test.
- (5) The emissions from 9KHz to 1GHz were measured based on CISPR QP detector except for the frequency bands 9-90KHz, 110-490KHz, for emissions from 9KHz-90KHz,110KHz-490KHz and above 1GHz were measured based on average detector, for emissions above 1GHz, peak emissions also be measured and need comply with Peak limit.
- (6) The emissions from 9KHz to 1GHz, QP or average values were measured with EMI receiver with below RBW.

Frequency band	RBW
9KHz-150KHz	200Hz
150KHz-30MHz	9KHz
30MHz-1GHz	120KHz

- (7) For emissions above 1GHz, both Peak and Average level were measured with Spectrum Analyzer, and the RBW is set at 1MHz, VBW is set at 3MHz for Peak measure; RMS detector RBW 1MHz VBW 3MHz for Average measure(according ANSI C63.10:2013 clause 4.2.3.2.3 procedure for average measure).
- (8) X axis, Y axis, Z axis are tested, and worse setup X axis is reported.

9.4. Test result

PASS. (See below detailed test result)

All the emissions except fundamental emission from 9 KHz to 25GHz were comply with 15.209 limits.

Note1: According exploratory test no any obvious emission were detected from 9KHz to 30MHz and 18GHz to 25GHz, so the final test was performed with frequency range from 30MHz to 18GHz and recorded in below.

Note2: For emissions below 1GHz, according exploratory explorer test, when change Tx mode and channel, have no distinct influence on emissions level, so for emissions below 1GHz, the final test was only performed with EUT working in GFSK, Tx 2441MHz mode.

Note3: For emissions above 1GHz. If peak results comply with AV limit, AV Result is deemed to comply with AV limit.

Radiated Emission test (below 1GHz)

TR-4-E-009 Radiated Emission Test Result

Test Site	: DDT 3m Chamber	D:\2016 Report Data\16Q1114-2\RE.EM6
Test Date	: 2016-11-16	Tested By : Toby
EUT	: Bluetooth Headset	Model Number : HA-FX39BT
Power Supply	: AC 120V/60Hz	Test Mode : Tx mode
Condition	: Temp:24.5°C,Humi:55%, Press:100.1kPa	Antenna/Distance : 2016 VULB9163 1#/3m/VERTICAL
Memo	:	

Data: 9

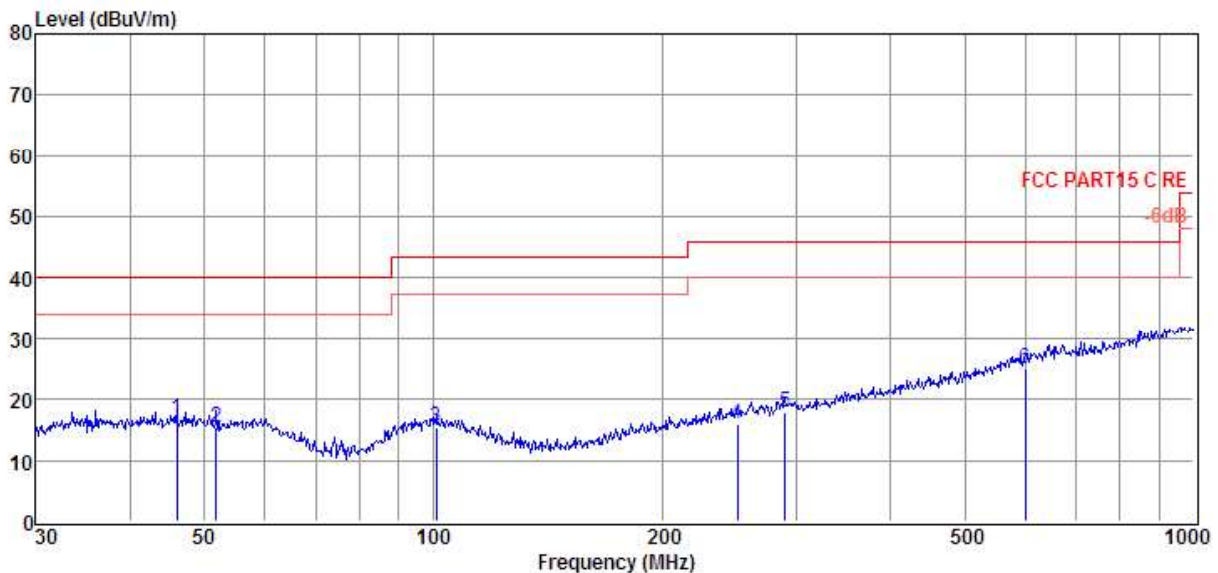

Item (Mark)	Freq. (MHz)	Read Level (dBμV)	Antenna Factor (dB/m)	Cable Loss (dB)	Result Level (dBUV/m)	Limit Line (dBUV/m)	Over Limit (dB)	Detector	Polarization
1	46.02	3.72	12.20	0.78	16.70	40.00	-23.30	QP	VERTICAL
2	51.84	2.76	11.72	0.78	15.26	40.00	-24.74	QP	VERTICAL
3	100.93	2.38	11.92	1.13	15.43	43.50	-28.07	QP	VERTICAL
4	251.18	1.84	12.30	1.82	15.96	46.00	-30.04	QP	VERTICAL
5	290.02	2.50	13.50	1.95	17.95	46.00	-28.05	QP	VERTICAL
6	601.43	2.96	19.27	2.91	25.14	46.00	-20.86	QP	VERTICAL

- Note: 1. Result Level = Read Level + Antenna Factor + Cable loss.
 2. If Peak Result complies with QP limit, QP Result is deemed to comply with QP limit.
 3. Test setup: RBW: 120 kHz, VBW: 300 kHz, Sweep time: auto.

TR-4-E-009 Radiated Emission Test Result

Test Site	: DDT 3m Chamber	D:\2016 Report Data\16Q1114-2\RE.EM6
Test Date	: 2016-11-16	Tested By : Toby
EUT	: Bluetooth Headset	Model Number : HA-FX39BT
Power Supply	: AC 120V/60Hz	Test Mode : Tx mode
Condition	: Temp:24.5°C,Humi:55%, Press:100.1kPa	Antenna/Distance : 2016 VULB9163 1#/3m/HORIZONTAL
Memo	:	

Data: 10

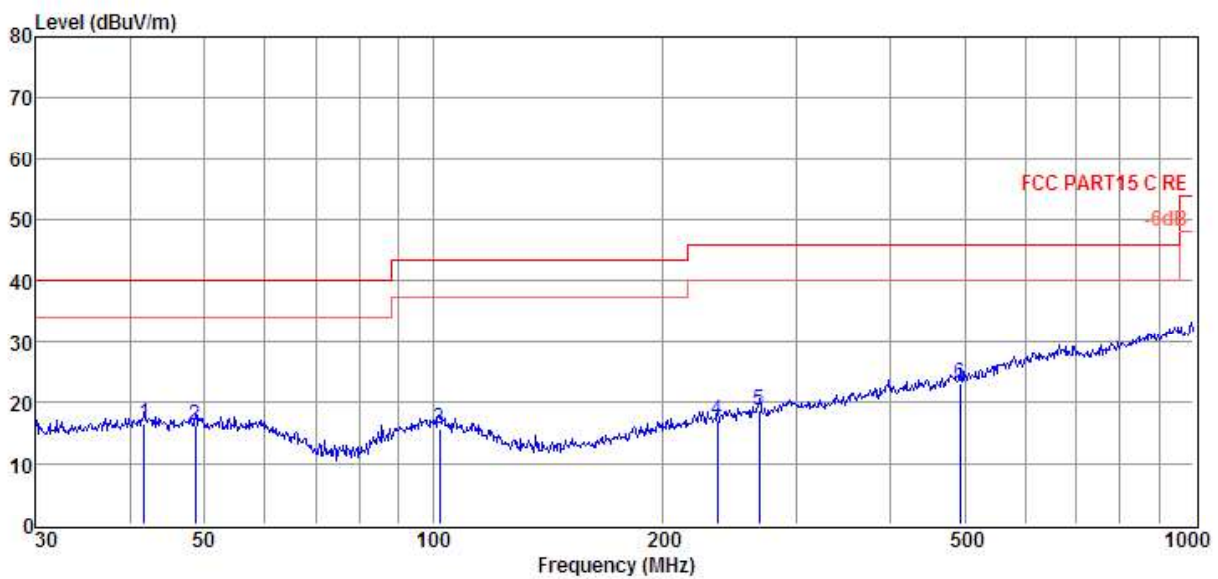

Item (Mark)	Freq. (MHz)	Read Level (dBμV)	Antenna Factor (dB/m)	Cable Loss dB	Result Level (dBμV/m)	Limit Line (dBμV/m)	Over Limit (dB)	Detector	Polarization
1	41.71	3.26	12.44	0.78	16.48	40.00	-23.52	QP	HORIZONTAL
2	48.67	3.13	12.20	0.78	16.11	40.00	-23.89	QP	HORIZONTAL
3	102.00	2.83	11.84	1.13	15.80	43.50	-27.70	QP	HORIZONTAL
4	236.65	3.47	11.77	1.75	16.99	46.00	-29.01	QP	HORIZONTAL
5	268.49	3.88	12.81	1.89	18.58	46.00	-27.42	QP	HORIZONTAL
6	492.47	3.30	17.20	2.68	23.18	46.00	-22.82	QP	HORIZONTAL

- Note: 1. Result Level = Read Level + Antenna Factor + Cable loss.
 2. If Peak Result complies with QP limit, QP Result is deemed to comply with QP limit.
 3. Test setup: RBW: 120 kHz, VBW: 300 kHz, Sweep time: auto.

Radiated Emission test (above 1GHz)

Freq (MHz)	Read level (dB μ V)	Antenna Factor (dB/m)	PRM Factor (dB)	Cable Loss (dB)	Result Level (dB μ V/m)	Limit (dB μ V/m)	Margin (dB)	Detector type	Polarization
GFSK Tx mode 2402MHz									
3471.000	37.14	31.89	29.59	7.26	46.70	74.00	-27.30	Peak	VERTICAL
4017.000	35.84	33.41	29.04	7.63	47.84	74.00	-26.16	Peak	VERTICAL
4804.000	37.95	33.74	29.32	8.48	50.85	54.00	-3.15	Average	VERTICAL
4804.000	49.54	33.74	29.32	8.48	62.44	74.00	-11.56	Peak	VERTICAL
6054.000	34.72	35.09	29.23	9.71	50.29	74.00	-23.71	Peak	VERTICAL
3247.000	38.78	31.80	30.01	7.03	47.60	74.00	-26.40	Peak	HORIZONTAL
3940.000	36.75	33.23	29.07	7.58	48.49	74.00	-25.51	Peak	HORIZONTAL
4804.000	37.26	33.74	29.32	8.48	50.16	54.00	-3.84	Average	HORIZONTAL
4804.000	47.16	33.74	29.32	8.48	60.06	74.00	-13.94	Peak	HORIZONTAL
6054.000	34.71	35.09	29.23	9.71	50.28	74.00	-23.72	Peak	HORIZONTAL
GFSK Tx mode 2441MHz									
4882.000	37.36	33.72	29.33	8.56	50.31	54.00	-3.69	Average	VERTICAL
4882.000	44.97	33.72	29.33	8.56	57.92	74.00	-16.08	Peak	VERTICAL
5739.000	33.89	34.85	29.21	9.43	48.96	74.00	-25.04	Peak	VERTICAL
5963.000	35.03	34.98	29.19	9.64	50.46	74.00	-23.54	Peak	VERTICAL
6782.000	34.44	36.03	30.22	10.23	50.48	74.00	-23.52	Peak	VERTICAL
3940.000	36.42	33.23	29.07	7.58	48.16	74.00	-25.84	Peak	HORIZONTAL
4882.000	37.36	33.72	29.33	8.56	50.31	54.00	-3.69	Average	HORIZONTAL
4882.000	44.61	33.72	29.33	8.56	57.56	74.00	-16.44	Peak	HORIZONTAL
5963.000	34.50	34.98	29.19	9.64	49.93	74.00	-24.07	Peak	HORIZONTAL
6670.000	35.04	35.94	30.12	10.12	50.98	74.00	-23.02	Peak	HORIZONTAL
7321.000	34.22	36.46	30.59	10.71	50.80	74.00	-23.20	Peak	HORIZONTAL
GFSK Tx mode 2480MHz									
3408.000	37.35	31.87	29.77	7.21	46.66	74.00	-27.34	Peak	HORIZONTAL
4024.000	36.52	33.42	29.04	7.63	48.53	74.00	-25.47	Peak	HORIZONTAL
4960.000	37.68	33.71	29.34	8.63	50.68	54.00	-3.32	Average	HORIZONTAL
4960.000	42.53	33.71	29.34	8.63	55.53	74.00	-18.47	Peak	HORIZONTAL
6187.000	34.18	35.31	29.36	9.78	49.91	74.00	-24.09	Peak	HORIZONTAL
6922.000	34.81	36.14	30.33	10.37	50.99	74.00	-23.01	Peak	HORIZONTAL
4003.000	37.09	33.40	29.04	7.61	49.06	74.00	-24.94	Peak	VERTICAL
4960.000	37.47	33.71	29.34	8.63	50.47	54.00	-3.53	Average	VERTICAL
4960.000	44.84	33.71	29.34	8.63	57.84	74.00	-16.16	Peak	VERTICAL
5991.000	35.90	34.99	29.19	9.68	51.38	74.00	-22.62	Peak	VERTICAL
6313.000	33.62	35.51	29.49	9.85	49.49	74.00	-24.51	Peak	VERTICAL
Result: Pass									
Test Date : Nov. 24, 2016					Test Engineer : Toby Ren				

Note: 1.30MHz~18GHz: (Scan with GFSK, $\pi/4$ QPSK, 8-DPSK, the worst case is GFSK Mode)

2. Result Level = Read Level + Antenna Factor + Cable loss - PRM Factor.

10. Band Edge Compliance (radiated method)

10.1. Block diagram of test setup

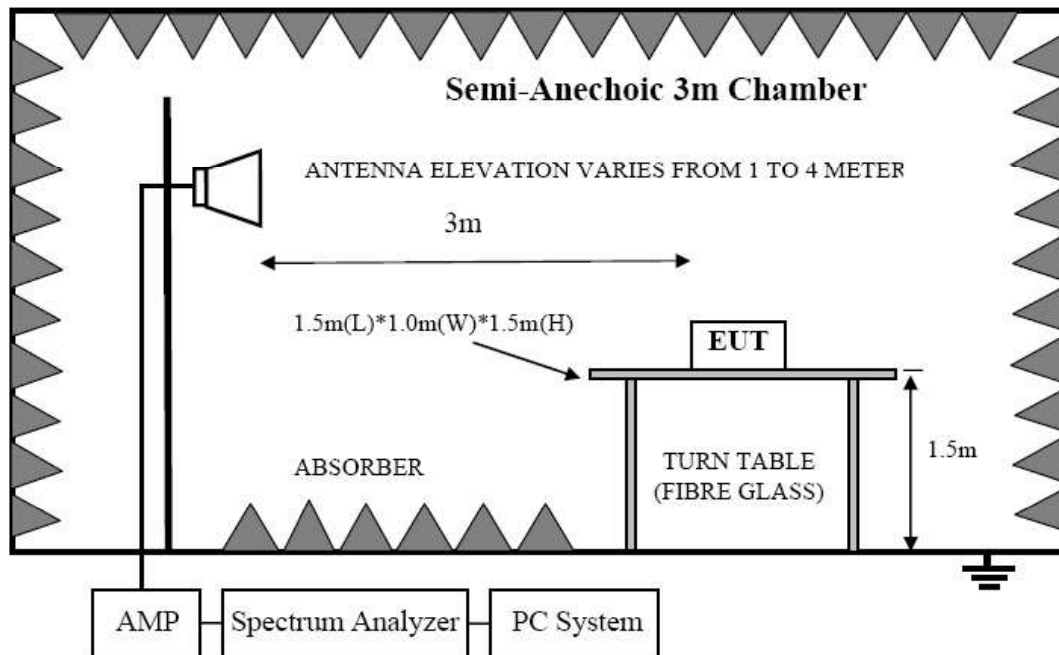

10.2. Limit

All restriction band should comply with 15.209, other emission should be at least 20dB below the fundamental.

10.3. Test Procedure

Same with clause 9.3 except change investigated frequency range from 2310MHz to 2415MHz and 2475MHz to 2500MHz.

Remark: All restriction band have been tested, and only the worse case is shown in report.

10.4. Test result

PASS. (See below detailed test result)

Remark: hopping on and hopping off mode all have been test, hopping off mode is worse and reported only.

TR-4-E-009 Radiated Emission Test Result

Test Site	: DDT 3m Chamber	D:\2016 Report Data\16Q1114-2\RF.EM6
Test Date	: 2016-11-24	Tested By : Toby
EUT	: Bluetooth Headset	Model Number : HA-FX39BT
Power Supply	: AC 120V/60Hz	Test Mode : Tx mode GSKF CH0
Condition	: Temp:24.5°C,Humi:55%, Press:100.1kPa	Antenna/Distance : 2016 HF907/3m/HORIZONTAL
Memo	:	

Data: 21

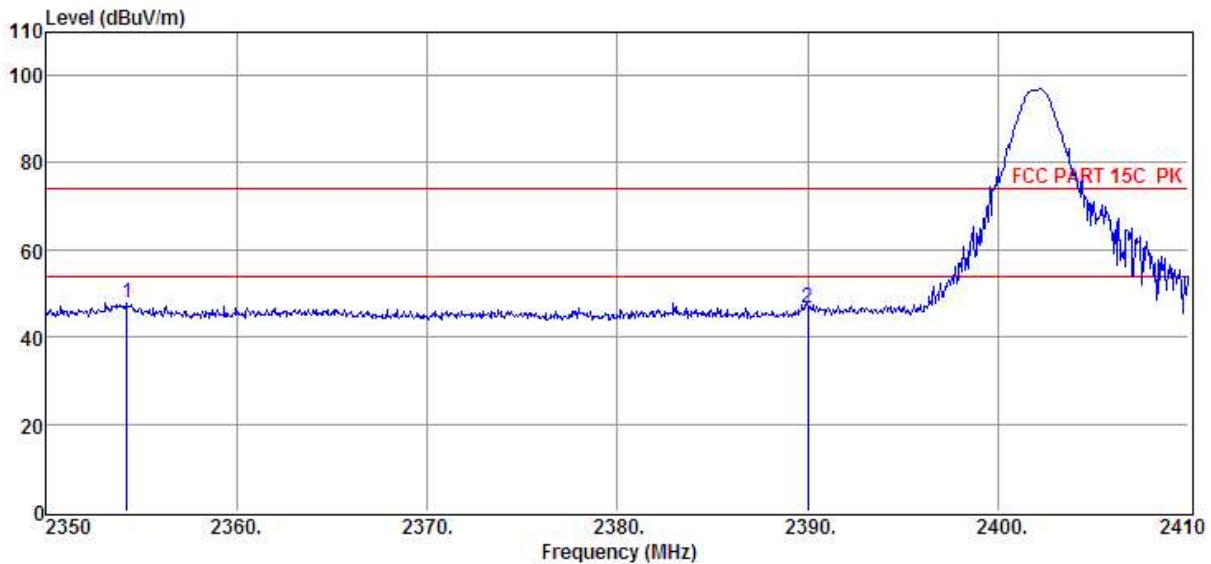

Item (Mark)	Freq. (MHz)	Read Level (dBμV)	Antenna Factor (dB/m)	PRM Factor dB	Cable Loss dB	Result Level (dBμV/m)	Limit Line (dBμV/m)	Over Limit (dB)	Detector	Polarization
1	2354.260	41.92	29.63	29.34	5.96	48.17	74.00	-25.83	Peak	HORIZONTAL
2	2390.000	40.61	29.78	29.41	6.01	46.99	74.00	-27.01	Peak	HORIZONTAL

- Note: 1. Result Level = Read Level + Antenna Factor + Cable loss - PRM Factor.
 2. If Peak Result complies with AV limit, AV Result is deemed to comply with AV limit.
 3. Test setup: RBW: 1 MHz, VBW: 3 MHz, Sweep time: auto.

TR-4-E-009 Radiated Emission Test Result

Test Site : DDT 3m Chamber D:\2016 Report Data\16Q1114-2\RF.EM6
Test Date : 2016-11-24 **Tested By** : Toby
EUT : Bluetooth Headset **Model Number** : HA-FX39BT
Power Supply : AC 120V/60Hz **Test Mode** : Tx mode GSKF CH0
Condition : Temp:24.5°C,Humi:55%,
 Press:100.1kPa **Antenna/Distance** : 2016 HF907/3m/VERTICAL
Memo :

Data: 22

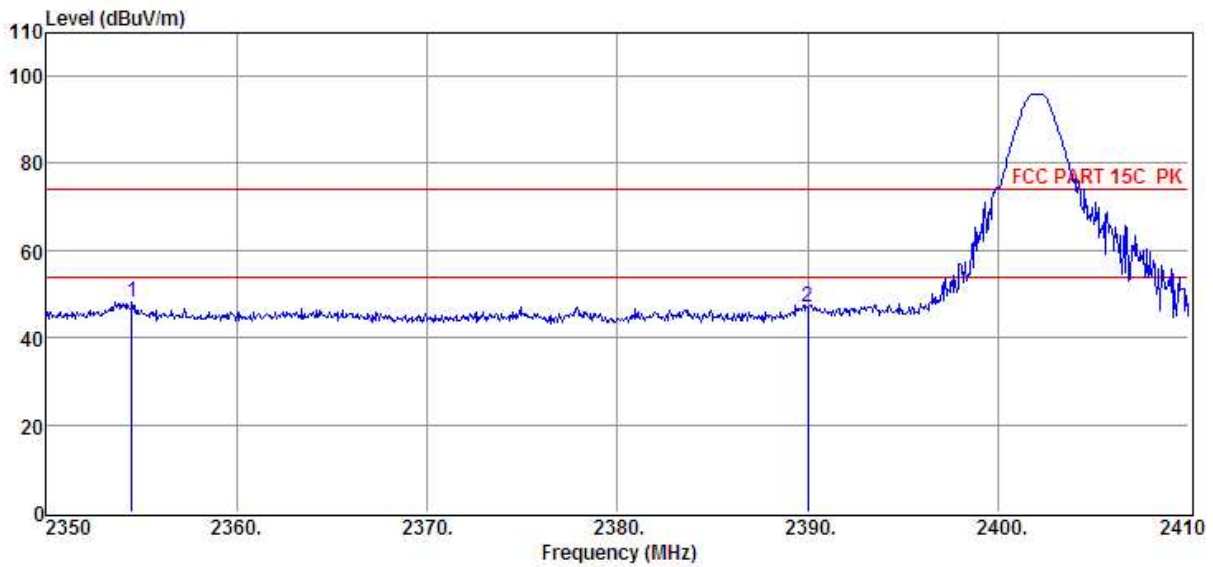

Item (Mark)	Freq. (MHz)	Read Level (dBμV)	Antenna Factor (dB/m)	PRM Factor (dB)	Cable Loss (dB)	Result Level (dBμV/m)	Limit Line (dBμV/m)	Over Limit (dB)	Detector	Polarization
1	2354.500	42.27	29.64	29.34	5.96	48.53	74.00	-25.47	Peak	VERTICAL
2	2390.000	40.72	29.78	29.41	6.01	47.10	74.00	-26.90	Peak	VERTICAL

- Note: 1. Result Level = Read Level + Antenna Factor + Cable loss - PRM Factor.
 2. If Peak Result complies with AV limit, AV Result is deemed to comply with AV limit.
 3. Test setup: RBW: 1 MHz, VBW: 3 MHz, Sweep time: auto.

TR-4-E-009 Radiated Emission Test Result

Test Site : DDT 3m Chamber	D:\2016 Report Data\16Q1114-2\RF.EM6
Test Date : 2016-11-24	Tested By : Toby
EUT : Bluetooth Headset	Model Number : HA-FX39BT
Power Supply : AC 120V/60Hz	Test Mode : Tx mode GSKF CH78
Condition : Temp:24.5°C,Humi:55%, Press:100.1kPa	Antenna/Distance : 2016 HF907/3m/VERTICAL
Memo :	

Data: 27

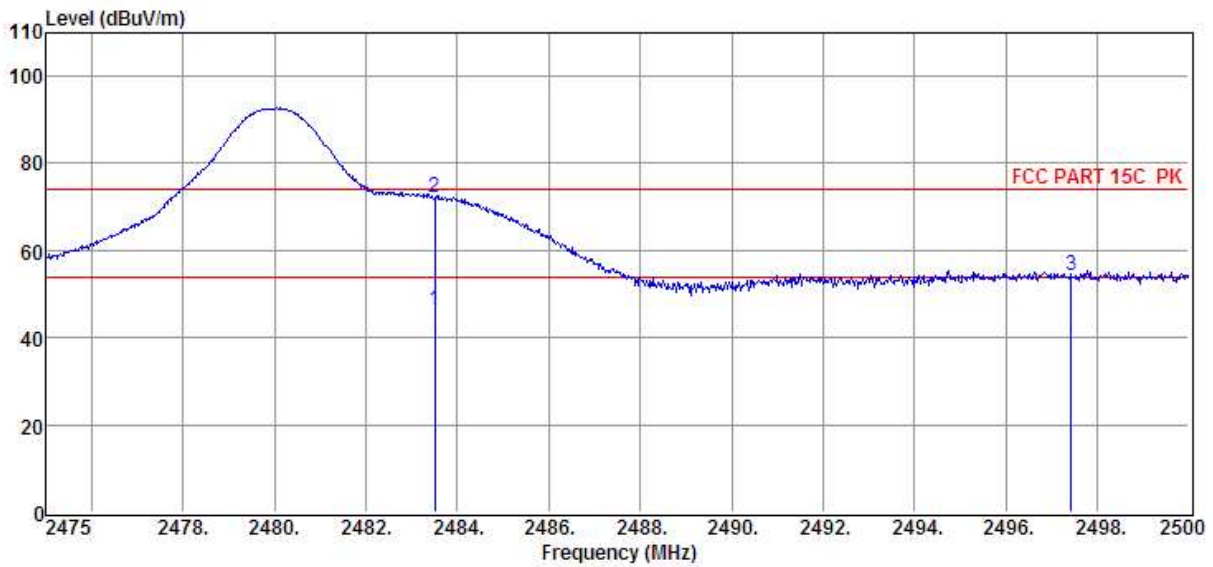

Item (Mark)	Freq. (MHz)	Read Level (dBμV)	Antenna Factor (dB/m)	PRM Factor dB	Cable Loss dB	Result Level (dBμV/m)	Limit Line (dBμV/m)	Over Limit (dB)	Detector	Polarization
1	2483.500	39.79	30.14	29.71	6.15	46.37	54.00	-7.63	Average	VERTICAL
2	2483.500	65.58	30.14	29.71	6.15	72.16	74.00	-1.84	Peak	VERTICAL

Note: 1. Result Level = Read Level + Antenna Factor + Cable loss - PRM Factor.
 2. If Peak Result complies with AV limit, AV Result is deemed to comply with AV limit.
 3. Test setup: RBW: 1 MHz, VBW: 3 MHz, Sweep time: auto.

TR-4-E-009 Radiated Emission Test Result

Test Site : DDT 3m Chamber D:\2016 Report Data\16Q1114-2\RF.EM6
Test Date : 2016-11-24 **Tested By** : Toby
EUT : Bluetooth Headset **Model Number** : HA-FX39BT
Power Supply : AC 120V/60Hz **Test Mode** : Tx mode GSKF CH78
Condition : Temp:24.5°C,Humi:55%,
 Press:100.1kPa **Antenna/Distance** : 2016 HF907/3m/HORIZONTAL
Memo :

Data: 28

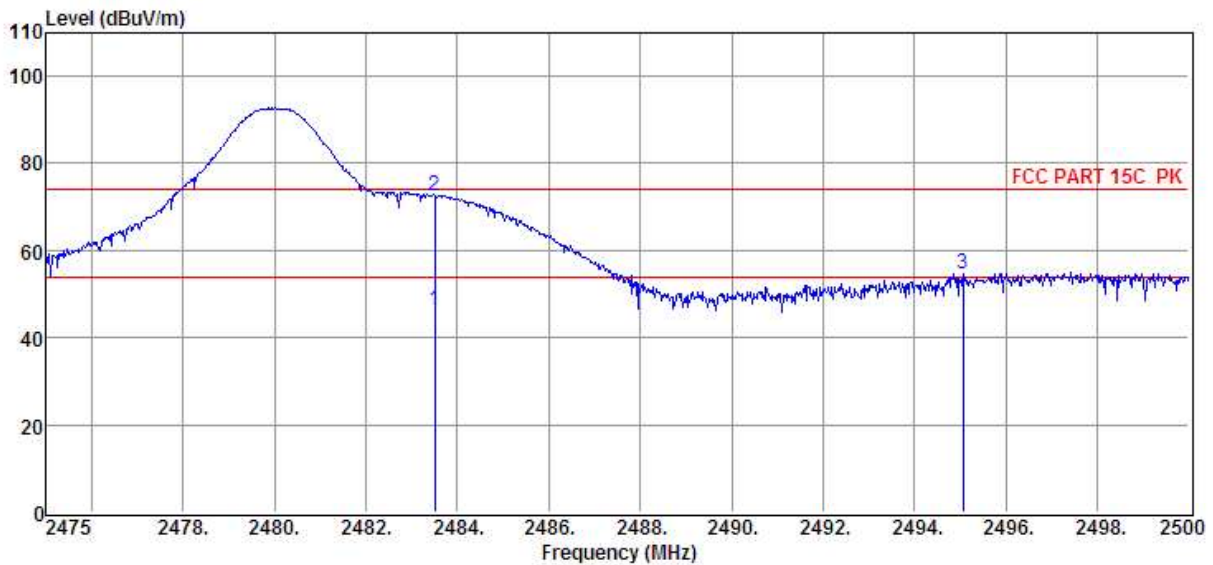

Item (Mark)	Freq. (MHz)	Read Level (dBμV)	Antenna Factor (dB/m)	PRM Factor (dB)	Cable Loss (dB)	Result Level (dBμV/m)	Limit Line (dBμV/m)	Over Limit (dB)	Detector	Polarization
1	2483.500	39.85	30.14	29.71	6.15	46.43	54.00	-7.57	Average	HORIZONTAL
2	2483.500	65.98	30.14	29.71	6.15	72.56	74.00	-1.44	Peak	HORIZONTAL

Note: 1. Result Level = Read Level + Antenna Factor + Cable loss - PRM Factor.
 2. If Peak Result complies with AV limit, AV Result is deemed to comply with AV limit.
 3. Test setup: RBW: 1 MHz, VBW: 3 MHz, Sweep time: auto.

TR-4-E-009 Radiated Emission Test Result

Test Site	: DDT 3m Chamber	Tested By	: Toby
Test Date	: 2016-11-24	Model Number	: HA-FX39BT
EUT	: Bluetooth Headset	Test Mode	: Tx mode 8-DPSK CH78
Power Supply	: AC 120V/60Hz	Antenna/Distance	: 2016 HF907/3m/HORIZONTAL
Condition	: Temp:24.5°C,Humi:55%, Press:100.1kPa		
Memo	:		

Data: 29

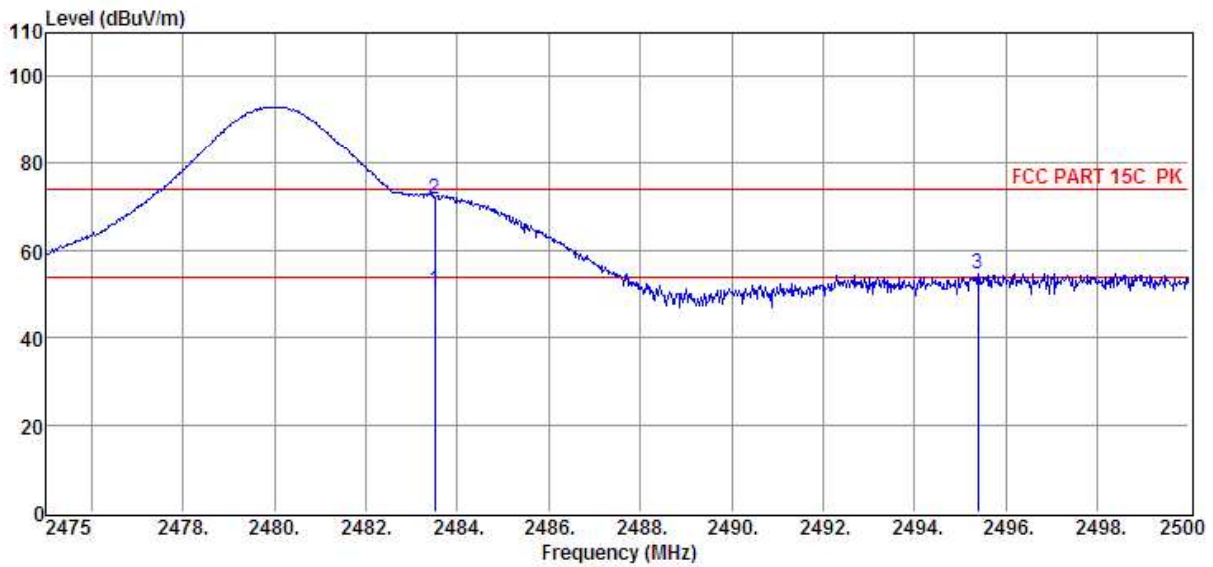

Item (Mark)	Freq. (MHz)	Read Level (dBμV)	Antenna Factor (dB/m)	PRM Factor dB	Cable Loss dB	Result Level (dBμV/m)	Limit Line (dBμV/m)	Over Limit (dB)	Detector	Polarization
1	2483.500	44.35	30.14	29.71	6.15	50.93	54.00	-3.07	Average	HORIZONTAL
2	2483.500	65.36	30.14	29.71	6.15	71.94	74.00	-2.06	Peak	HORIZONTAL

Note: 1. Result Level = Read Level + Antenna Factor + Cable loss - PRM Factor.
 2. If Peak Result complies with AV limit, AV Result is deemed to comply with AV limit.
 3. Test setup: RBW: 1 MHz, VBW: 3 MHz, Sweep time: auto.

TR-4-E-009 Radiated Emission Test Result

Test Site : DDT 3m Chamber D:\2016 Report Data\16Q1114-2\RF.EM6
Test Date : 2016-11-24 **Tested By** : Toby
EUT : Bluetooth Headset **Model Number** : HA-FX39BT
Power Supply : AC 120V/60Hz **Test Mode** : Tx mode 8-DPSK CH78
Condition : Temp:24.5°C,Humi:55%,
 Press:100.1kPa **Antenna/Distance** : 2016 HF907/3m/VERTICAL
Memo :

Data: 30

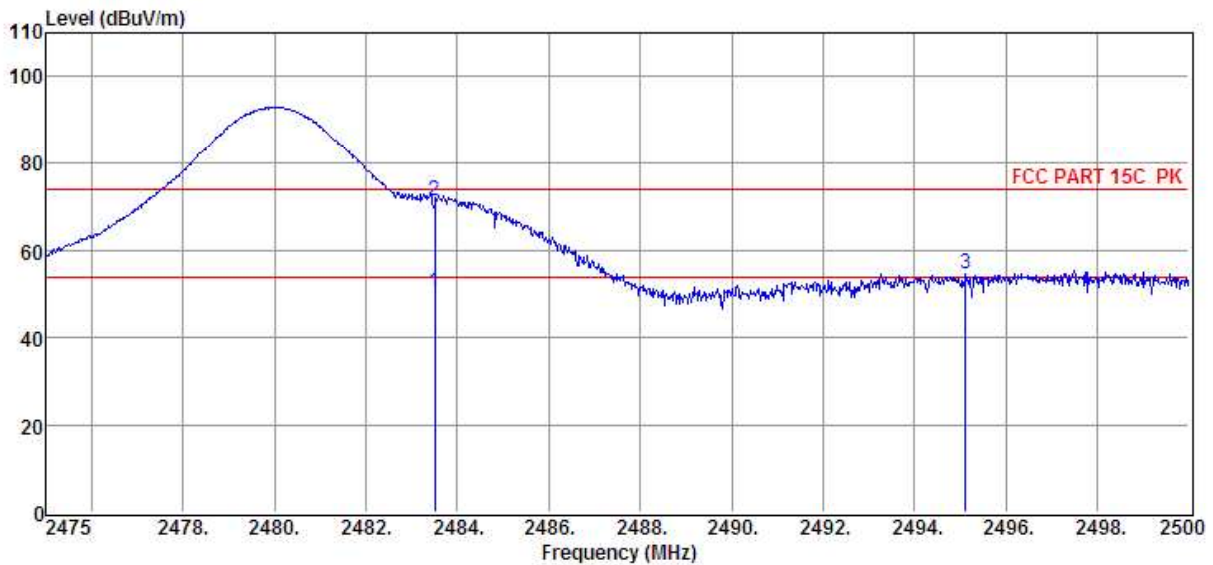

Item (Mark)	Freq. (MHz)	Read Level (dBμV)	Antenna Factor (dB/m)	PRM Factor (dB)	Cable Loss (dB)	Result Level (dBμV/m)	Limit Line (dBμV/m)	Over Limit (dB)	Detector	Polarization
1	2483.500	44.24	30.14	29.71	6.15	50.82	54.00	-3.18	Average	VERTICAL
2	2483.500	64.89	30.14	29.71	6.15	71.47	74.00	-2.53	Peak	VERTICAL

Note: 1. Result Level = Read Level + Antenna Factor + Cable loss - PRM Factor.
 2. If Peak Result complies with AV limit, AV Result is deemed to comply with AV limit.
 3. Test setup: RBW: 1 MHz, VBW: 3 MHz, Sweep time: auto.

TR-4-E-009 Radiated Emission Test Result

Test Site	: DDT 3m Chamber	Tested By	: Toby
Test Date	: 2016-11-24	Model Number	: HA-FX39BT
EUT	: Bluetooth Headset	Test Mode	: Tx mode 8-DPSK CH0
Power Supply	: AC 120V/60Hz	Antenna/Distance	: 2016 HF907/3m/VERTICAL
Condition	: Temp:24.5°C,Humi:55%, Press:100.1kPa		
Memo	:		

Data: 31

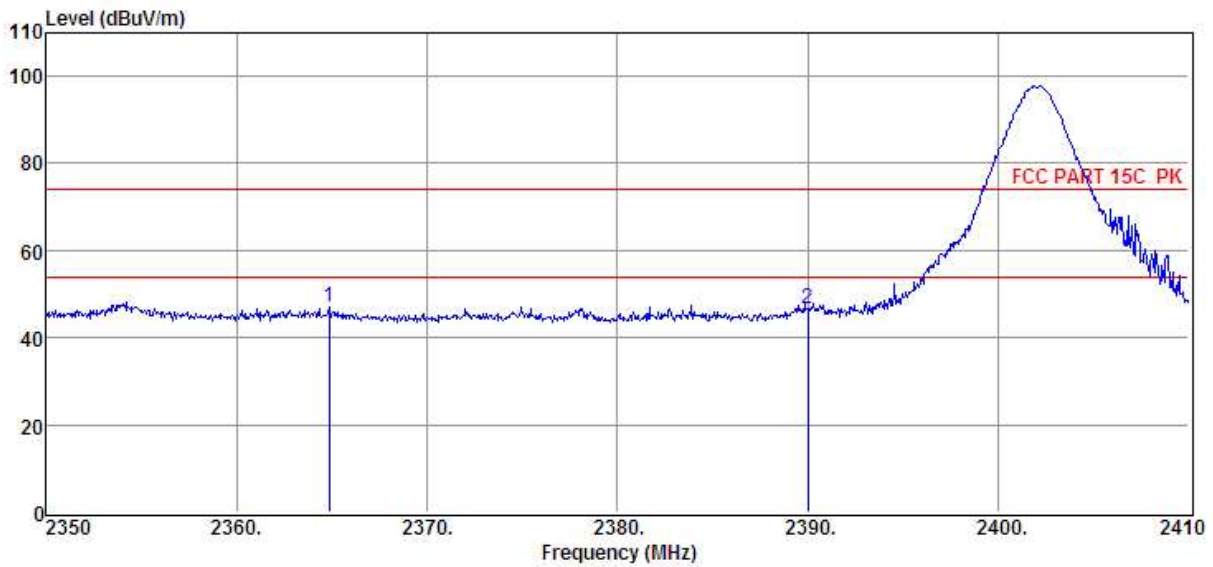

Item (Mark)	Freq. (MHz)	Read Level (dBμV)	Antenna Factor (dB/m)	PRM Factor dB	Cable Loss dB	Result Level (dBμV/m)	Limit Line (dBμV/m)	Over Limit (dB)	Detector	Polarization
1	2364.880	40.85	29.68	29.37	5.98	47.14	74.00	-26.86	Peak	VERTICAL
2	2390.020	40.49	29.78	29.41	6.01	46.87	74.00	-27.13	Peak	VERTICAL

- Note: 1. Result Level = Read Level + Antenna Factor + Cable loss - PRM Factor.
 2. If Peak Result complies with AV limit, AV Result is deemed to comply with AV limit.
 3. Test setup: RBW: 1 MHz, VBW: 3 MHz, Sweep time: auto.

TR-4-E-009 Radiated Emission Test Result

Test Site : DDT 3m Chamber **D:\2016 Report Data\16Q1114-2\RF.EM6**
Test Date : 2016-11-24 **Tested By** : Toby
EUT : Bluetooth Headset **Model Number** : HA-FX39BT
Power Supply : AC 120V/60Hz **Test Mode** : Tx mode 8-DPSK CH0
Condition : Temp:24.5°C,Humi:55%,
 Press:100.1kPa **Antenna/Distance** : 2016 HF907/3m/HORIZONTAL
Memo :

Data: 32

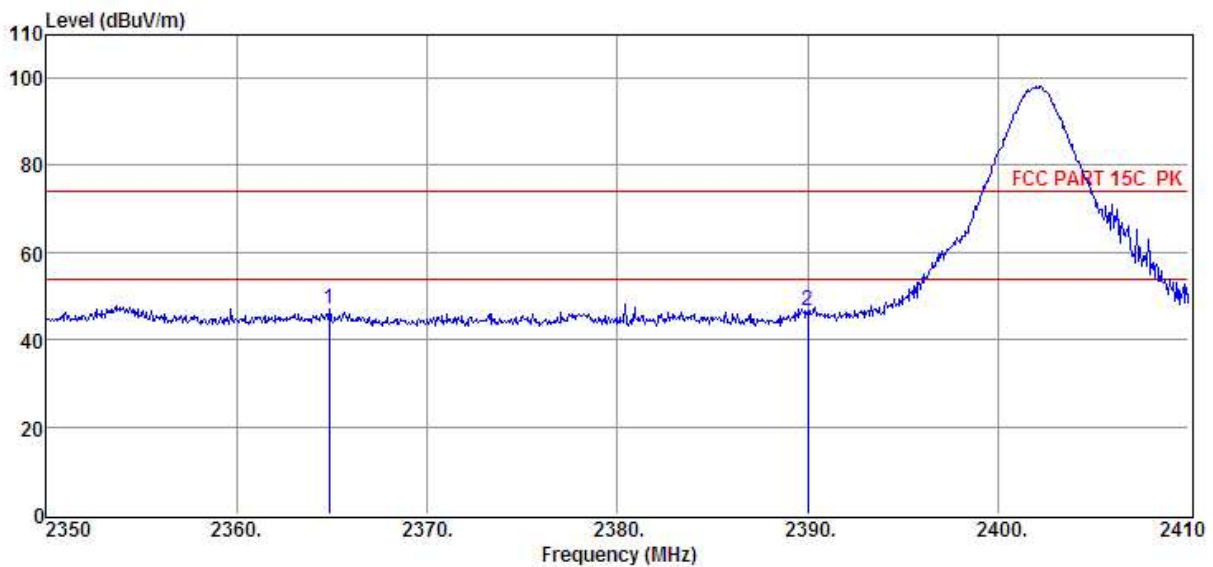

Item (Mark)	Freq. (MHz)	Read Level (dBμV)	Antenna Factor (dB/m)	PRM Factor (dB)	Cable Loss (dB)	Result Level (dBμV/m)	Limit Line (dBμV/m)	Over Limit (dB)	Detector	Polarization
1	2364.880	41.10	29.68	29.37	5.98	47.39	74.00	-26.61	Peak	HORIZONTAL
2	2390.020	40.44	29.78	29.41	6.01	46.82	74.00	-27.18	Peak	HORIZONTAL

- Note: 1. Result Level = Read Level + Antenna Factor + Cable loss - PRM Factor.
 2. If Peak Result complies with AV limit, AV Result is deemed to comply with AV limit.
 3. Test setup: RBW: 1 MHz, VBW: 3 MHz, Sweep time: auto.

11. Band Edge Compliance (conducted method)

11.1. Block diagram of test setup

Same as section 4.1

11.2. Limit

All restriction band should comply with 15.209, other emission should be at least 20dB below the fundamental.

11.3. Test result

Mode	Freq (MHz)	Conclusion
GFSK	Hopping off 2402	PASS
	Hopping off 2480	PASS
	Hopping on	PASS
8-DPSK	Hopping off 2402	PASS
	Hopping off 2480	PASS
	Hopping on	PASS

Test Date : Nov. 16, 2016 Test Engineer : Toby Ren

11.4. Original test data

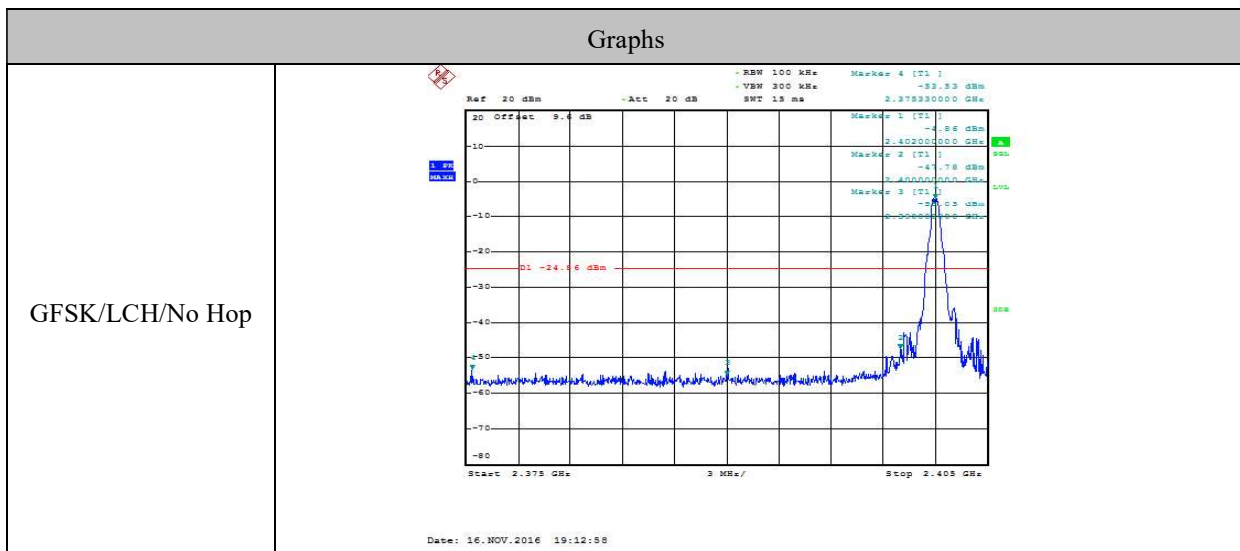

<p>GFSK/LCH/Hop</p>	<p>Date: 16.NOV.2016 19:28:57</p>
<p>GFSK/HCH/No Hop</p>	<p>Date: 16.NOV.2016 19:17:53</p>
<p>GFSK/HCH/Hop</p>	<p>Date: 16.NOV.2016 19:25:52</p>

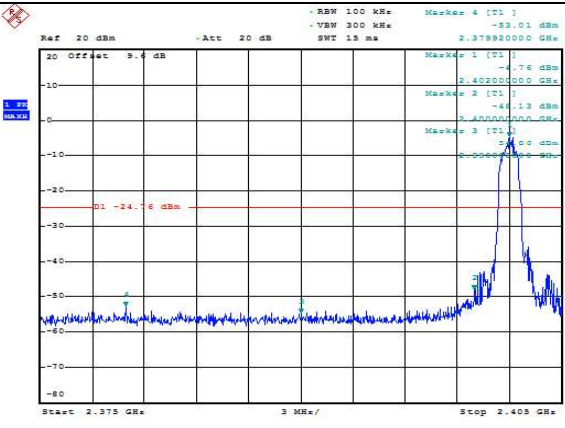
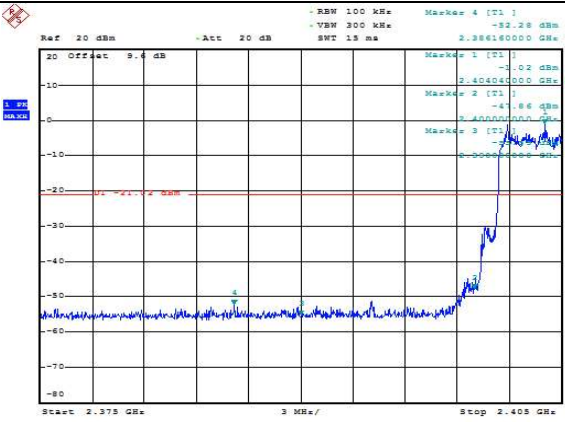
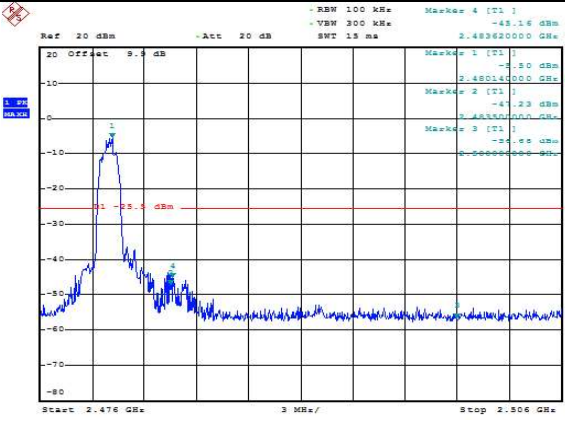
<p>8DPSK/LCH/No Hop</p>	 <p>Ref 20 dBm Offset 9.4 dB Att 20 dB RBW 100 kHz VBW 300 kHz SWT 13 ms</p> <p>Marker 4 [T1] -33.01 dBm 2.37892000 GHz</p> <p>Marker 1 [T1] -4.76 dBm 2.40200000 GHz</p> <p>Marker 2 [T1] -48.13 dBm 2.40200000 GHz</p> <p>Marker 3 [T1] -25.00 dBm 2.40000000 GHz</p> <p>Start 2.375 GHz 3 MHz/ Stop 2.405 GHz</p> <p>Date: 16.NOV.2016 19:19:26</p>
<p>8DPSK/LCH/Hop</p>	 <p>Ref 20 dBm Offset 9.4 dB Att 20 dB RBW 100 kHz VBW 300 kHz SWT 13 ms</p> <p>Marker 4 [T1] -32.28 dBm 2.38614000 GHz</p> <p>Marker 1 [T1] -1.02 dBm 2.40404000 GHz</p> <p>Marker 2 [T1] -47.86 dBm 2.40404000 GHz</p> <p>Marker 3 [T1] -25.00 dBm 2.40000000 GHz</p> <p>Start 2.375 GHz 3 MHz/ Stop 2.405 GHz</p> <p>Date: 16.NOV.2016 19:30:29</p>
<p>8DPSK/HCH/No Hop</p>	 <p>Ref 20 dBm Offset 9.4 dB Att 20 dB RBW 100 kHz VBW 300 kHz SWT 13 ms</p> <p>Marker 4 [T1] -43.16 dBm 2.48362000 GHz</p> <p>Marker 1 [T1] -1.50 dBm 2.48014000 GHz</p> <p>Marker 2 [T1] -41.23 dBm 2.48014000 GHz</p> <p>Marker 3 [T1] -36.88 dBm 2.48000000 GHz</p> <p>Start 2.476 GHz 3 MHz/ Stop 2.506 GHz</p> <p>Date: 16.NOV.2016 19:21:20</p>

8DPSK/HCH/Hop

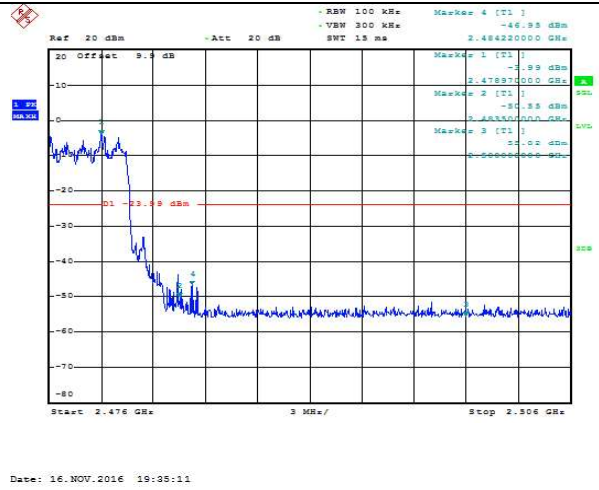

12. Power Line Conducted Emission

12.1. Block diagram of test setup

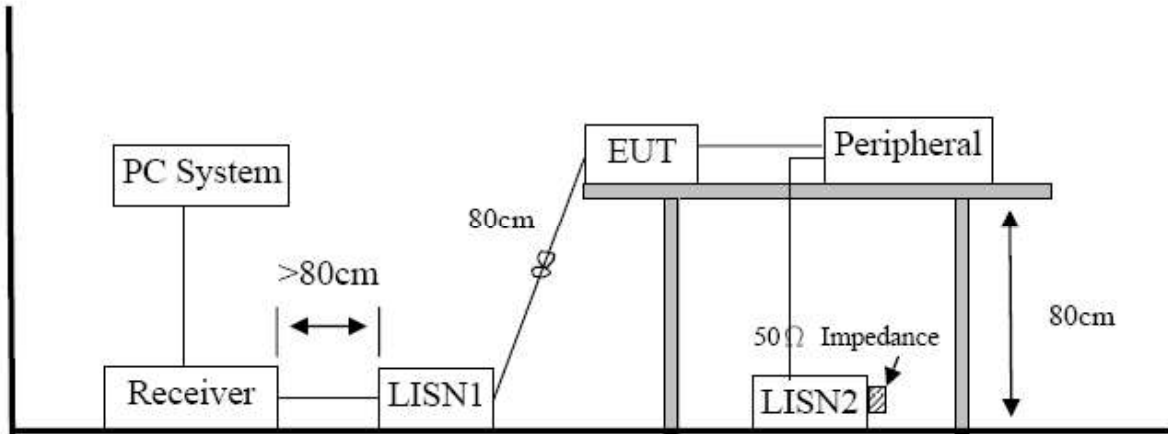

12.2. Power Line Conducted Emission Limits(Class B)

Frequency	Quasi-Peak Level dB(μ V)	Average Level dB(μ V)
150kHz ~ 500kHz	66 ~ 56*	56 ~ 46*
500kHz ~ 5MHz	56	46
5MHz ~ 30MHz	60	50

Note 1: * Decreasing linearly with logarithm of frequency.

Note 2: The lower limit shall apply at the transition frequencies.

12.3. Test Procedure

The EUT and Support equipment, if needed, were put placed on a non-metallic table, 80cm above the ground plane.

Configuration EUT to simulate typical usage as described in clause 2.4 and test equipment as described in clause 10.2 of this report.

All I/O cables were positioned to simulate typical actual usage as per ANSI C63.4.

All support equipment power received from a second LISN.

Emissions were measured on each current carrying line of the EUT using an EMI Test Receiver connected to the LISN powering the EUT.

The Receiver scanned from 150 kHz to 30MHz for emissions in each of the test modes.

During the above scans, the emissions were maximized by cable manipulation.

The test mode(s) described in clause 2.4 were scanned during the preliminary test.

After the preliminary scan, we found the test mode producing the highest emission level.

The EUT configuration and worse cable configuration of the above highest emission levels were recorded for reference of the final test.

EUT and support equipment were set up on the test bench as per the configuration with highest emission level in the preliminary test.

A scan was taken on both power lines, Neutral and Line, recording at least the six highest emissions.

Emission frequency and amplitude were recorded into a computer in which correction factors were used to calculate the emission level and compare reading to the applicable limit.

The test data of the worst-case condition(s) was recorded.

The bandwidth of test receiver is set at 9 KHz.

12.4. Test Result

PASS. (See below detailed test result)

Note1: All emissions not reported below are too low against the prescribed limits.

Note2: “-----” means Peak detection; “-----” mans Average detection

TR-4-E-010 Conducted Emission Test Result

Test Site	: DDT 1# Shield Room	E:\2016 report data\16Q1114-2\CE.EM6
Test Date	: 2016-11-16	Tested By : Jerry
EUT	: Bluetooth Headset	Model Number : HA-FX39BT
Power Supply	: AC 120V/60Hz	Test Mode : Charging +TX mode
Condition	: Temp:24.5°C,Humi:55%, Press:100.1kPa	LISN : 2016 ENV216/LINE

Data: 14

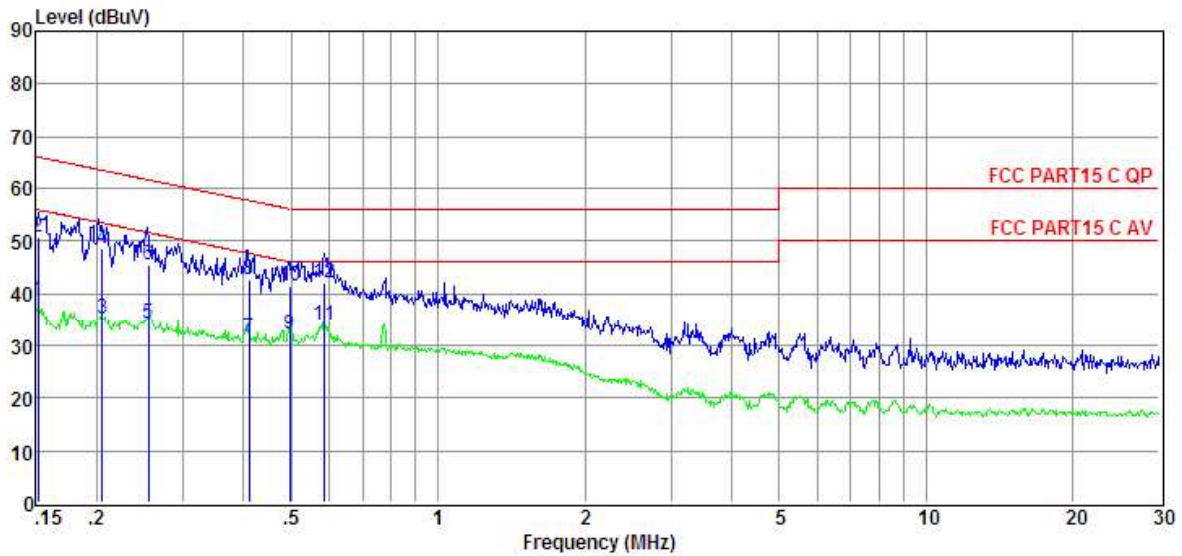

Item (Mark)	Freq. (MHz)	Read Level (dBμV)	LISN Factor (dB)	Cable Loss (dB)	Pulse Limiter Factor (dB)	Result Level (dBμV)	Limit Line (dBμV)	Over Limit (dB)	Detector	Phase
1	0.152	19.12	9.61	0.02	9.86	38.61	55.91	-17.30	Average	LINE
2	0.152	31.26	9.61	0.02	9.86	50.75	65.91	-15.16	QP	LINE
3	0.205	15.91	9.61	0.02	9.86	35.40	53.40	-18.00	Average	LINE
4	0.205	29.02	9.61	0.02	9.86	48.51	63.40	-14.89	QP	LINE
5	0.255	14.74	9.61	0.02	9.86	34.23	51.60	-17.37	Average	LINE
6	0.255	25.82	9.61	0.02	9.86	45.31	61.60	-16.29	QP	LINE
7	0.410	12.11	9.61	0.02	9.86	31.60	47.64	-16.04	Average	LINE
8	0.410	23.30	9.61	0.02	9.86	42.79	57.64	-14.85	QP	LINE
9	0.497	12.74	9.61	0.02	9.86	32.23	46.05	-13.82	Average	LINE
10	0.497	21.82	9.61	0.02	9.86	41.31	56.05	-14.74	QP	LINE
11	0.585	14.64	9.61	0.03	9.86	34.14	46.00	-11.86	Average	LINE
12	0.585	22.50	9.61	0.03	9.86	42.00	56.00	-14.00	QP	LINE

- Note: 1. Result Level = Read Level + LISN Factor + Pulse Limiter Factor + Cable loss.
 2. If QP Result complies with AV limit, AV Result is deemed to comply with AV limit.
 3. Test setup: RBW: 200 Hz (9 kHz—150 kHz), 9 kHz (150 kHz—30 MHz).
 4. Step size: 80Hz (0.009MHz-0.15MHz), 4 kHz (0.15MHz-30MHz), Scan time: auto.

TR-4-E-010 Conducted Emission Test Result

Test Site	: DDT 1# Shield Room	E:\2016 report data\16Q1114-2\CE.EM6
Test Date	: 2016-11-16	Tested By : Jerry
EUT	: Bluetooth Headset	Model Number : HA-FX39BT
Power Supply	: AC 120V/60Hz	Test Mode : Charging +TX mode
Condition	: Temp:24.5°C,Humi:55%, Press:100.1kPa	LISN : 2016 ENV216/NEUTRAL

Data: 16

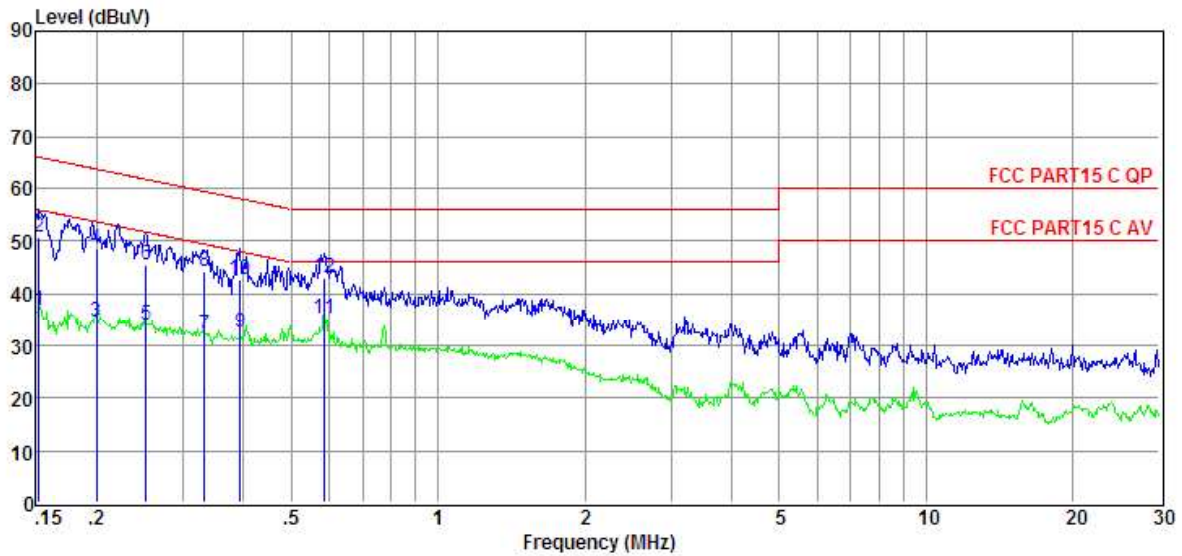

Item (Mark)	Freq. (MHz)	Read Level (dBμV)	LISN Factor (dB)	Cable Loss (dB)	Pulse Limiter Factor (dB)	Result Level (dBμV)	Limit Line (dBμV)	Over Limit (dB)	Detector	Phase
1	0.152	17.19	9.61	0.02	9.86	36.68	55.87	-19.19	Average	NEUTRAL
2	0.152	31.13	9.61	0.02	9.86	50.62	65.87	-15.25	QP	NEUTRAL
3	0.200	15.06	9.61	0.02	9.86	34.55	53.62	-19.07	Average	NEUTRAL
4	0.200	29.07	9.61	0.02	9.86	48.56	63.62	-15.06	QP	NEUTRAL
5	0.252	14.62	9.61	0.02	9.86	34.11	51.69	-17.58	Average	NEUTRAL
6	0.252	25.96	9.61	0.02	9.86	45.45	61.69	-16.24	QP	NEUTRAL
7	0.332	12.65	9.61	0.02	9.86	32.14	49.40	-17.26	Average	NEUTRAL
8	0.332	24.74	9.61	0.02	9.86	44.23	59.40	-15.17	QP	NEUTRAL
9	0.393	13.09	9.61	0.02	9.86	32.58	47.99	-15.41	Average	NEUTRAL
10	0.393	23.34	9.61	0.02	9.86	42.83	57.99	-15.16	QP	NEUTRAL
11	0.585	15.78	9.61	0.03	9.86	35.28	46.00	-10.72	Average	NEUTRAL
12	0.585	23.40	9.61	0.03	9.86	42.90	56.00	-13.10	QP	NEUTRAL

- Note: 1. Result Level = Read Level + LISN Factor + Pulse Limiter Factor + Cable loss.
 2. If QP Result complies with AV limit, AV Result is deemed to comply with AV limit.
 3. Test setup: RBW: 200 Hz (9 kHz—150 kHz), 9 kHz (150 kHz—30 MHz).
 4. Step size: 80Hz (0.009MHz-0.15MHz), 4 kHz (0.15MHz-30MHz), Scan time: auto.

13. Antenna Requirements

13.1. Limit

For intentional device, according to FCC 47 CFR Section 15.203, an intentional radiator shall be designed to ensure that no antenna other than that furnished by the responsible party shall be used with the device. And according to FCC 47 CFR Section 15.247 (b), if transmitting antennas of directional gain greater than 6dBi are used, the power shall be reduced by the amount in dB that the directional gain of the antenna exceeds 6dBi.

13.2. Result

The antennas used for this product are integrated antenna and that no antenna other than that furnished by the responsible party shall be used with the device, the maximum peak gain of the transmit antenna is only 3.09 dBi.

14. Test setup photograph

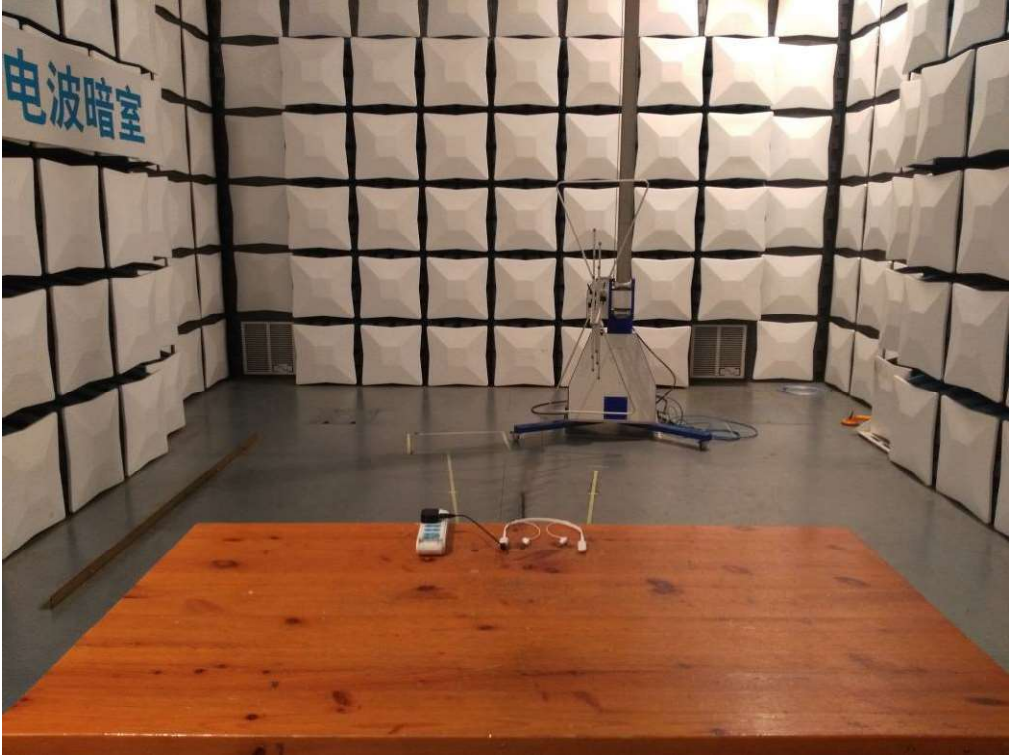

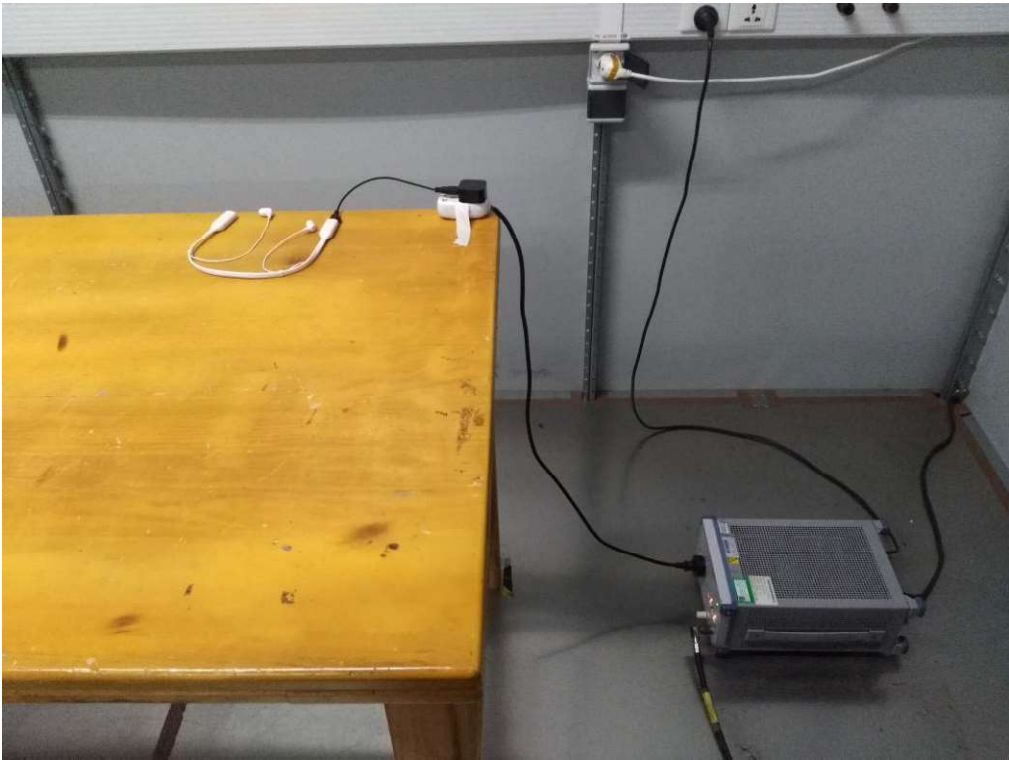

15. Photos of the EUT



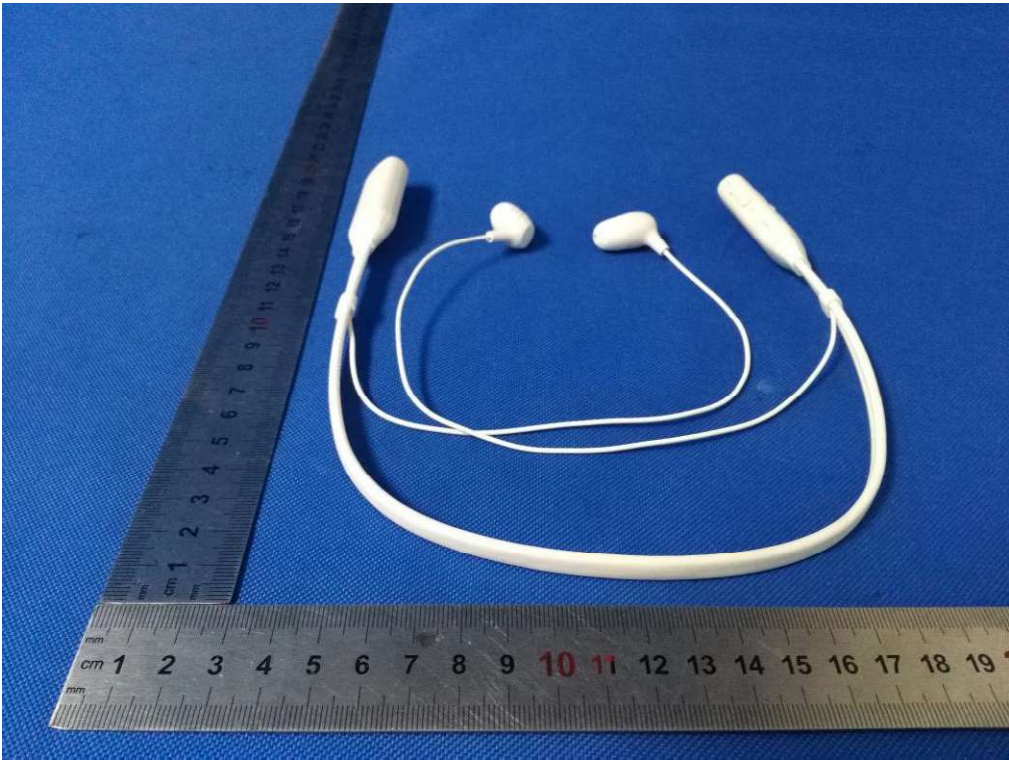
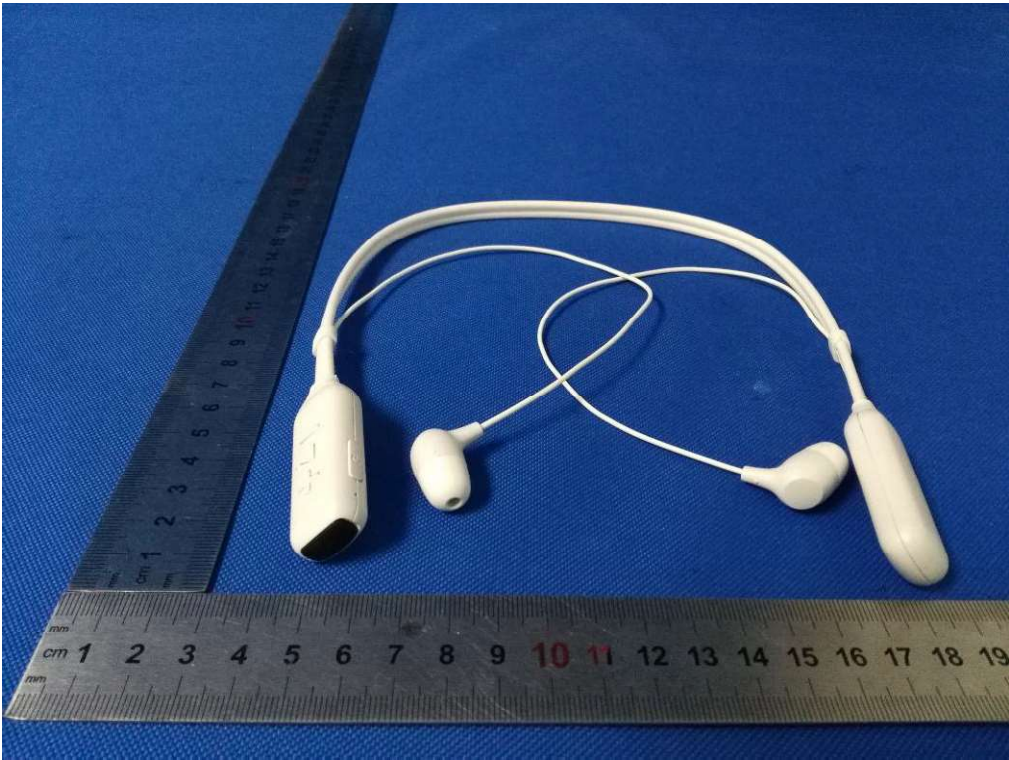



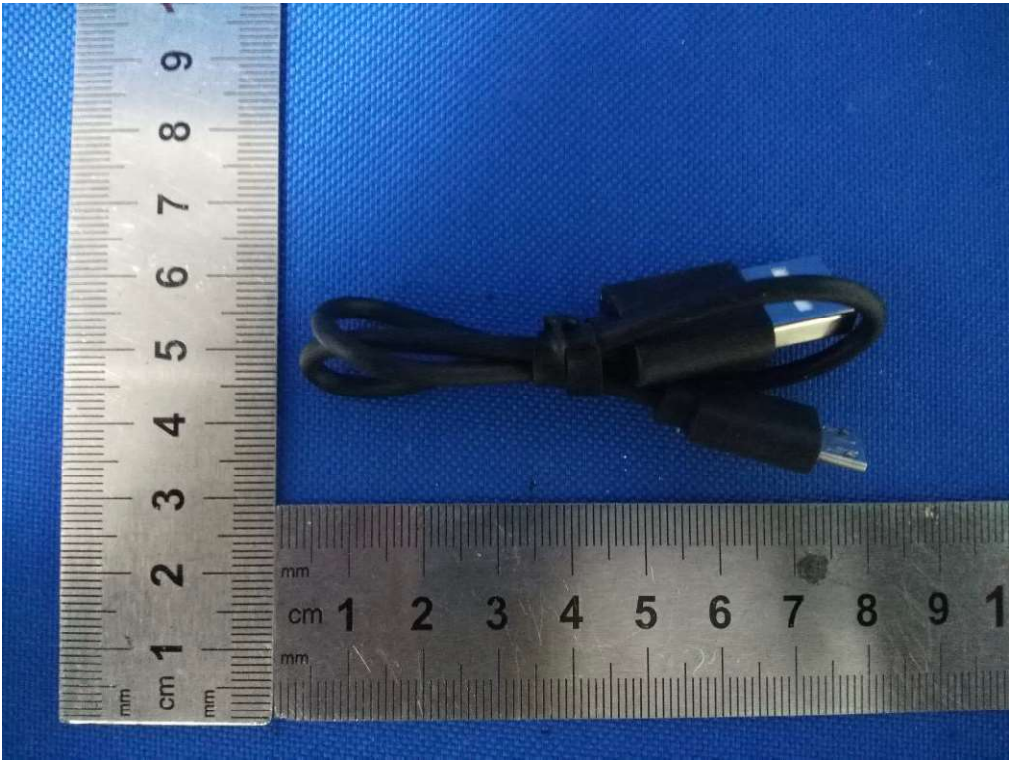



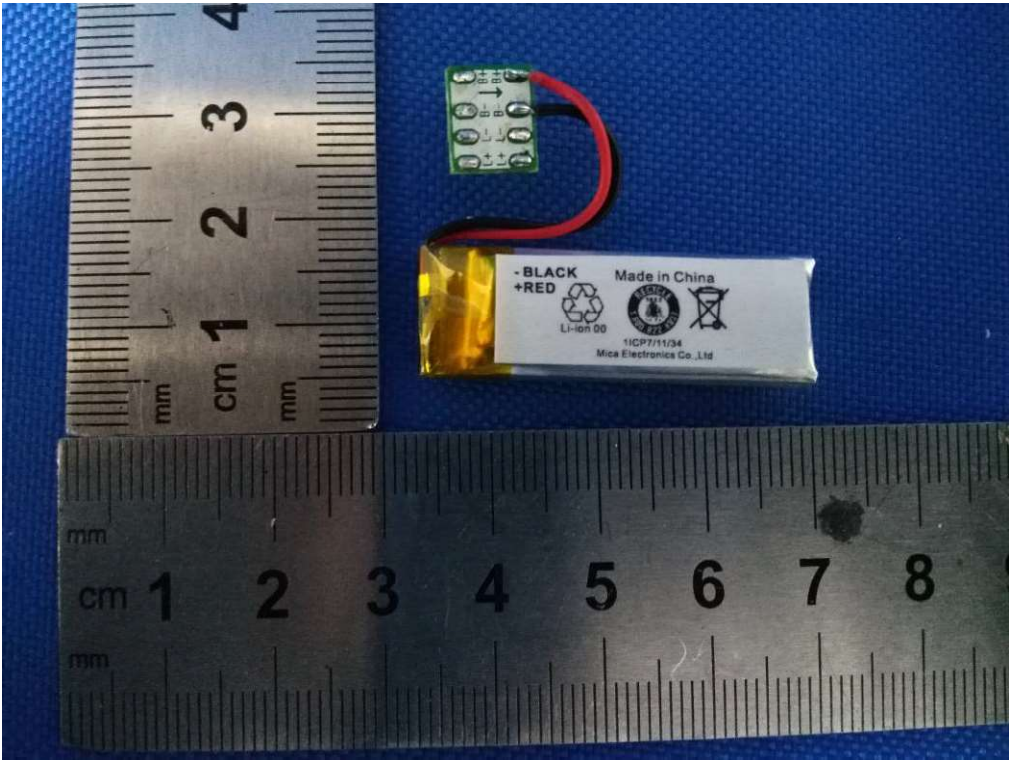
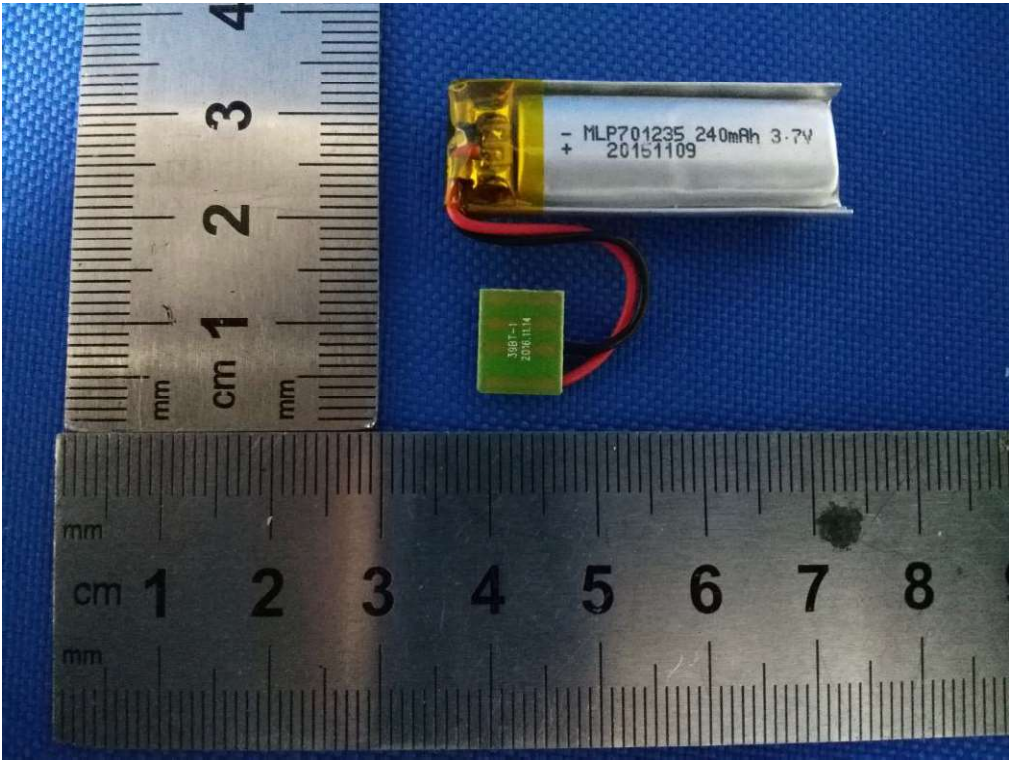

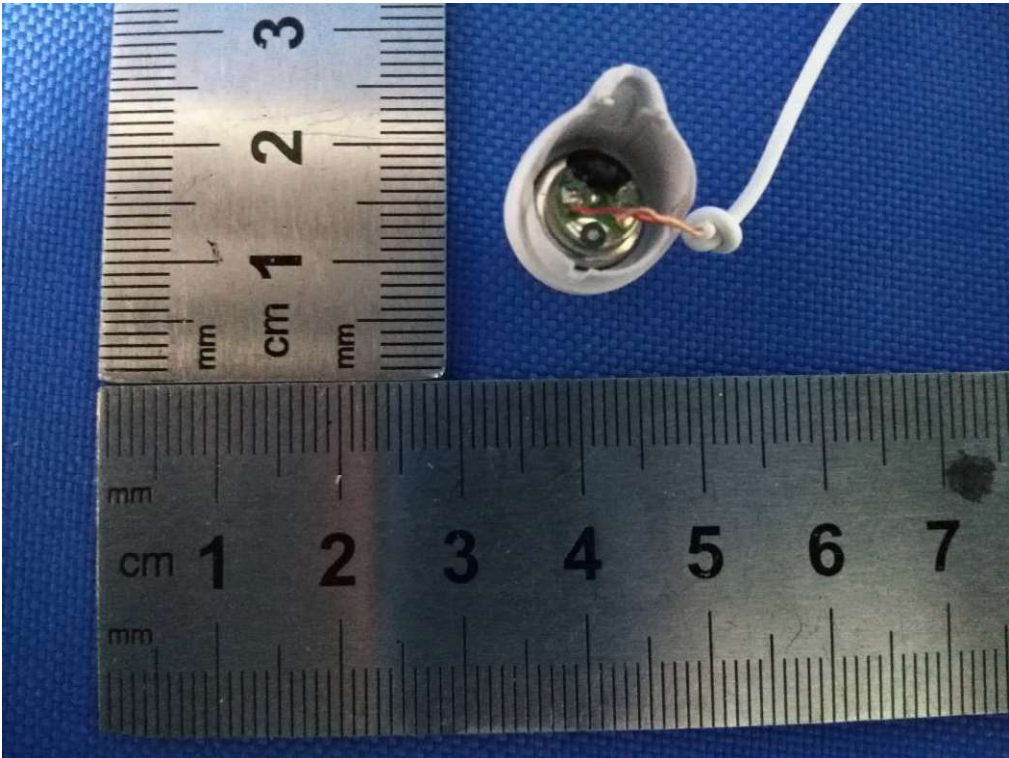

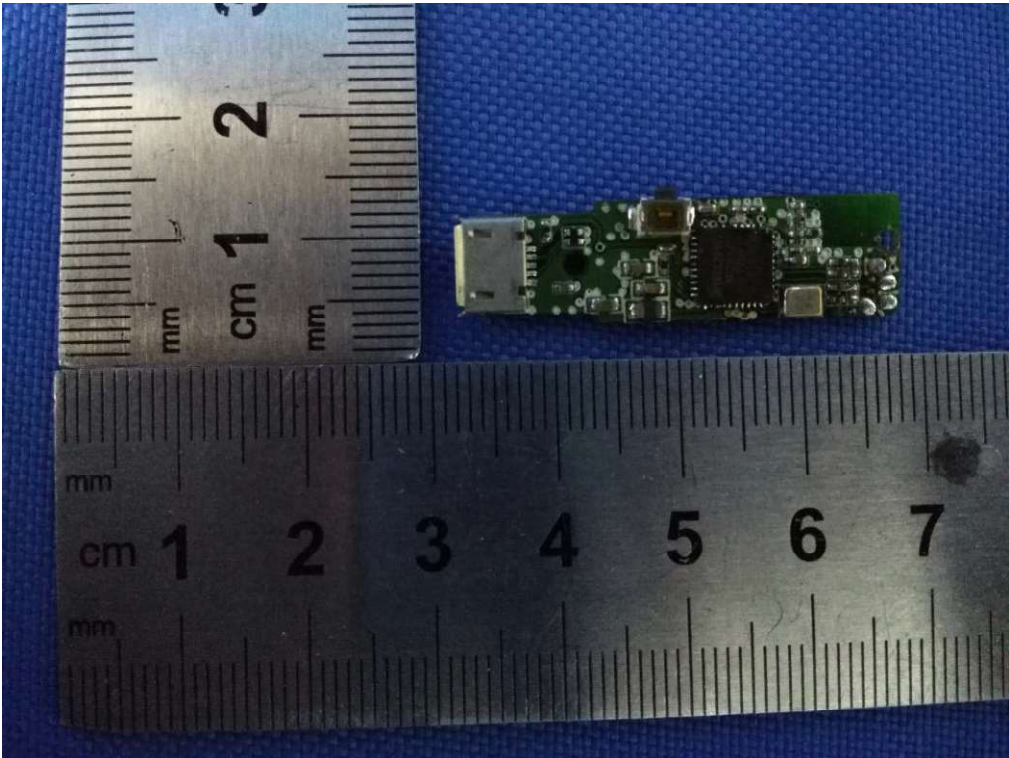
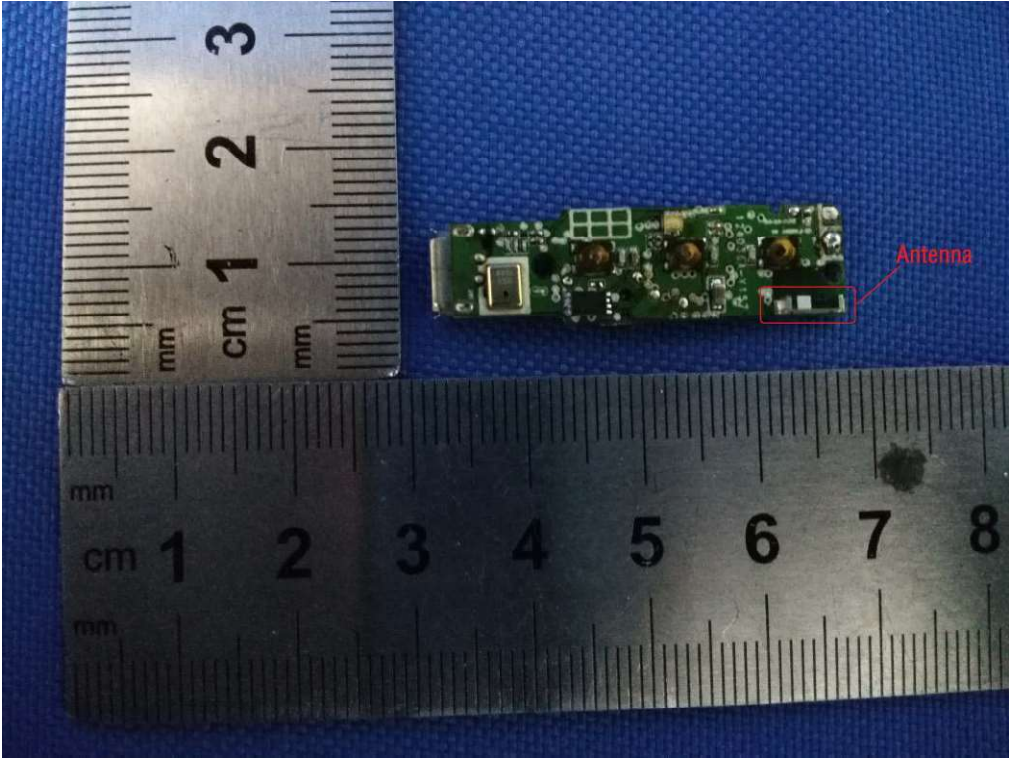

END OF REPORT