

# FCC Part 15B TEST REPORT

Report No: STS1703190E01

Issued for

TOOCAN ELECTRONICS S.A.S

Calle 45 # 53-50 oficina 0911 CC gran plaza, medellin,  
Colombia

<b>Product Name:</b>	Smart phone
<b>Brand Name:</b>	Blackview
<b>Model Name:</b>	E7S
<b>Series Model:</b>	N/A
<b>FCC ID:</b>	2AKLPE7S
<b>Test Standard:</b>	FCC Part 15B

Any reproduction of this document must be done in full. No single part of this document may be reproduced without permission from BZT, All Test Data Presented in this report is only applicable to presented Test sample.

BZT Testing Technology Co., Ltd  
Add. : Buliding 17,Xinghua Road Xingwei industrial Park Fuyong,Baoan District,Shenzhen,Guangdong,China

**TEST RESULT CERTIFICATION****Applicant's name** .....: TOOCAN ELECTRONICS S.A.S

Address .....: Calle 45 # 53-50 oficina 0911 CC gran plaza, medellin, Colombia

**Manufacture's Name** .....: Shenzhen JEKO Communication Co.,LtdAddress .....: 13th Floor, Weidonglong commercial building B, Meilong avenue,  
Longhua New District, Shenzhen, China.**Product description**

Product name .....: Smart phone

Brand name .....: Blackview

Model and/or type reference...: E7S

**Standards** .....: FCC Part 15B

Test procedure ..... ANSI C63.4-2014

This device described above has been tested by BZT, and the test results show that the equipment under test (EUT) is in compliance with the FCC requirements. And it is applicable only to the tested sample identified in the report.

This report shall not be reproduced except in full, without the written approval of BZT, this document may be altered or revised by BZT, personal only, and shall be noted in the revision of the document.

Date of Test .....

Date of performance of teBZT ... 31 Mar. 2017~13 Apr. 2017

Date of Issue ..... 14 Apr. 2017

Test Result ..... **Pass**

Testing Engineer :

*Barry Li*\_\_\_\_\_  
(Barry Li)

Technical Manager :

*Chopin Xiao*\_\_\_\_\_  
(Chopin Xiao)

Authorized Signatory :

*Vita Li*\_\_\_\_\_  
(Vita Li)

## Table of Contents

<b>1. SUMMARY OF TEST RESULTS</b>	<b>5</b>
1.1 TEST FACTORY	5
1.2 MEASUREMENT UNCERTAINTY	5
<b>2. GENERAL INFORMATION</b>	<b>6</b>
2.1 GENERAL DESCRIPTION OF EUT	6
2.2 DESCRIPTION OF TEST MODES	7
2.3 BLOCK DIGRAM SHOWING THE CONFIGURATION OF SYSTEM TESTED	8
2.4 DESCRIPTION OF SUPPORT UNITS	9
2.5 EQUIPMENTS LIST FOR ALL TEST ITEMS	10
<b>3. EMC EMISSION TEST</b>	<b>11</b>
3.1 CONDUCTED EMISSION MEASUREMENT	11
3.2 RADIATED EMISSION MEASUREMENT	15
<b>4. PHOTOS OF TEST SETUP</b>	<b>21</b>

**Revision History**

Rev.	Issue Date	Report NO.	Effect Page	Contents
00	14 Apr, 2017	STS1703190E01	ALL	Initial Issue

## 1. SUMMARY OF TEST RESULTS

Test procedures according to the technical standards:

EMISSION			
Standard	Item	Result	Remarks
FCC 47 CFR Part 15 Subpart B (10-1-05 Edition)	Conducted Emission	PASS	Meet Class B limit
	Radiated Emission	PASS	Meet Class B limit

NOTE:

(1) " N/A" denotes test is not applicable in this Test Report

### 1.1 TEST FACTORY

BZT Testing Technology Co., Ltd  
 Add. : Buliding 17,Xinghua Road Xingwei industrial Park Fuyong,Baoan District,  
 Shenzhen,Guangdong,China

FCC Registration No.: 701733

### 1.2 MEASUREMENT UNCERTAINTY

The reported uncertainty of measurement  $y \pm U$  , where expended uncertainty U is based on a standard uncertainty multiplied by a coverage factor of  $k=2$  , providing a level of confidence of approximately 95 %.

No.	Item	Uncertainty
1	Conducted Emission (9KHz-150KHz)	$\pm 2.88\text{dB}$
2	Conducted Emission (150KHz-30MHz)	$\pm 2.67\text{dB}$
3	RF power,conducted	$\pm 0.70\text{dB}$
4	Spurious emissions,conducted	$\pm 1.19\text{dB}$
5	All emissions,radiated(<30M) (9KHz-30MHz)	$\pm 2.45\text{dB}$
6	All emissions,radiated(<1G) 30MHz-200MHz	$\pm 2.83\text{dB}$
7	All emissions,radiated(<1G) 200MHz-1000MHz	$\pm 2.94\text{dB}$
8	All emissions,radiated(>1G)	$\pm 3.03\text{dB}$
9	Temperature	$\pm 0.5^{\circ}\text{C}$
10	Humidity	$\pm 2\%$

## 2. GENERAL INFORMATION

### 2.1 GENERAL DESCRIPTION OF EUT

Equipment	Smart phone
Trade Name	Blackview
Model Name	E7S
Series Model	N/A
Model Difference	N/A
MCU Operating frequency	2.48GHz
Adapter	Input: AC100-240V, 200mA, 50/60Hz Output: DC5V, 1000mA
Battery	Rated Voltage: 3.8V Capacity: 2700mAh Charge Limit: 4.35V
Hardware version number	HCT-G631-BOM11
Software version number	E7S_ Blackview_20161121
Connecting I/O Port(s)	Please refer to the User's Manual

*Note: For a more detailed features description, please refer to the manufacturer's specifications or the User's Manual.*

## 2.2 DESCRIPTION OF TEST MODES

To investigate the maximum EMI emission characteristics generates from EUT, the test system was pre-scanning tested base on the consideration of following EUT operation mode or test configuration mode which possible have effect on EMI emission level. Each of these EUT operation mode(s) or test configuration mode(s) mentioned above was evaluated respectively.

Pretest Mode	Description
Mode 1	USB port communication with PC
Mode 2	Camera Mode
Mode 3	GSM Mode
Mode 4	WCDMA Mode
Mode 5	Video Mode
Mode 6	Audio Mode
Mode 7	Play Music Mode
Mode 8	WIFI Mode
Mode 9	BT Mode
Mode 10	Charge Mode

For Conducted Test	
Final Test Mode	Description
Mode 1	USB port communication with PC

For Radiated Test	
Final Test Mode	Description
Mode 1	USB port communication with PC

### NOTE:

1. Due to the different configuration and test, in this list only some worse mode. The worst test data of the worse mode is reported by this report.
2. We have be tested for all available U.S. voltage and frequencies (For 120V, 50/60Hz and 240V, 50/60Hz) for which the device is capable of operation.

2.3 BLOCK DIGRAM SHOWING THE CONFIGURATION OF SYSTEM TESTED

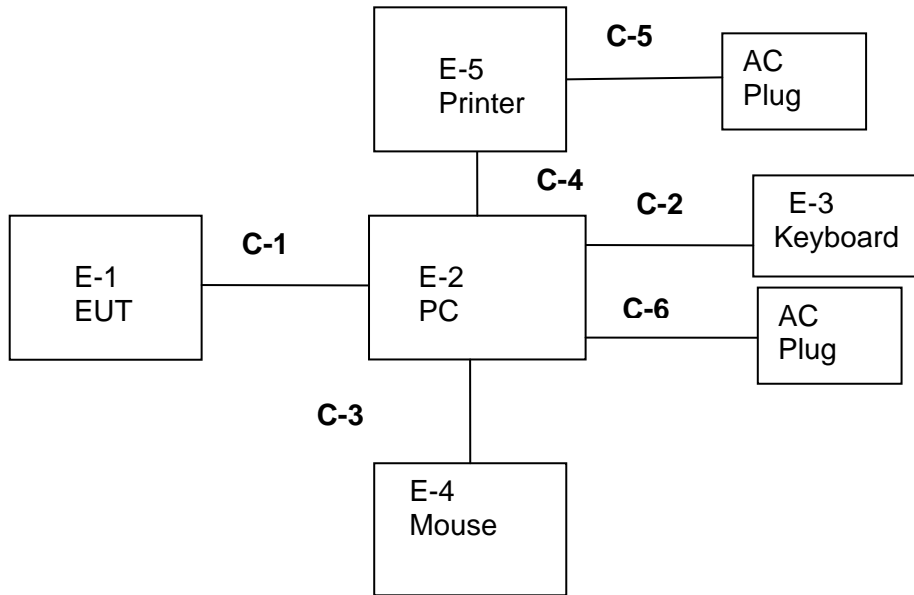



## 2.4 DESCRIPTION OF SUPPORT UNITS

The EUT has been tested as an independent unit together with other necessary accessories or support units. The following support units or accessories were used to form a representative test configuration during the tests.

Item	Equipment	Mfr/Brand	Model/Type No.	Serial No.	Note
E-1	Smart phone	Blackview	E7S	N/A	EUT
E-2	PC	4CV428DQXR	500-320cx	4CV428DQYN	N/A
E-3	Keyboard	HP	PR1101U	DKUSB1B06Q42209FBK800	N/A
E-4	Mouse	MOTOSPEED	F66	697738-001	N/A
E-5	Printer	HP	HP1020	CNBB102765	N/A
C-6	AC (PC Adapter)	LITEON	PA-1650-86	3X06399004	N/A

Item	Shielded Type	Ferrite Core	Length	Note
C-1	USB Cable (FTP)	NO	90cm	N/A
C-2	USB Cable (FTP)	NO	100cm	N/A
C-3	USB Cable (FTP)	NO	100cm	N/A
C-4	USB Cable (FTP)	NO	110cm	N/A
C-5	AC (Printer Cable) (FTP)	NO	100cm	N/A
C-6	AC (PC Cable) (FTP)	NO	120cm	N/A

### Note:

- (1) The support equipment was authorized by Declaration of Confirmation.
- (2) For detachable type I/O cable should be specified the length in cm in 『Length』 column.
- (3) “YES” is means “shielded” “with core”; “NO” is means “unshielded” “without core”.
- (4) PC is the FCC DOC is approved.

## 2.5 EQUIPMENTS LIST FOR ALL TEST ITEMS

The EUT has been tested as an independent unit together with other necessary accessories or support units. The following support units or accessories were used to form a representative test configuration during the tests.

### Radiation Test equipment

Kind of Equipment	Manufacturer	Type No.	Serial No.	Last Calibration	Calibrated Until
EMI Test Receiver	R&S	ESCI	101427	2016.10.23	2017.10.22
Loop Antenna	EMCO	6502	9003-2485	2016.03.06	2019.03.03
Bilog Antenna	TESEQ	CBL6111D	34678	2014.11.24	2017.11.23
Horn Antenna	Schwarzbeck	BBHA 9120D(1201)	9120D-1343	2015.03.05	2018.03.04
PreAmplifier	Agilent	8449B	60538	2016.10.23	2017.10.22
Temperature & Humidity	Mieo	HH660	N/A	2016.10.23	2017.10.22
Unversal radio communication tester	R&S	CMU200	111764	2016.10.23	2017.10.22
Spectrum Analyzer	Agilent	E4407B	MY50140340	2016.10.23	2017.10.22
Low frequency cable	EM	R01	N/A	NCR	NCR
High frequency cable	SCHWARZBECK	AK9515H	SN-96286/96287	NCR	NCR
Semi-anechoic chamber	Changling	966	N/A	2016.10.23	2017.10.22

### Conduction Test equipment

Kind of Equipment	Manufacturer	Type No.	Serial No.	Last Calibration	Calibrated Until
EMI Test Receiver	R&S	ESPI	102086	2016.10.23	2017.10.22
LISN	R&S	ENV216	101242	2016.10.23	2017.10.22
LISN	EMCO	3810/2NM	000-23625	2016.10.23	2017.10.22
Conduction Cable	EM	C01	N/A	NCR	NCR
Shielding Room	Changling	854	N/A	2016.10.23	2017.10.22

### 3. EMC EMISSION TEST

#### 3.1 CONDUCTED EMISSION MEASUREMENT

##### 3.1.1 POWER LINE CONDUCTED EMISSION Limits

FREQUENCY (MHz)	Conducted Emission Limits (dBuV)			
	Class A		Class B	
	Quasi-peak	Average	Quasi-peak	Average
0.15 -0.5	79.00	66.00	66 - 56 *	56 - 46 *
0.50 -5.0	73.00	60.00	56.00	46.00
5.0 -30.0	73.00	60.00	60.00	50.00

Note:

- (1) The tighter limit applies at the band edges.
- (2) The limit of " \* " marked band means the limitation decreases linearly with the logarithm of the frequency in the range.

The following table is the setting of the receiver

Receiver Parameters	Setting
Attenuation	10 dB
Start Frequency	0.15 MHz
Stop Frequency	30 MHz
IF Bandwidth	9 kHz

### 3.1.2 TEST PROCEDURE

- The EUT was 0.8 meters from the horizontal ground plane and 0.4 meters from the vertical ground plane with EUT being connected to the power mains through a line impedance stabilization network (LISN). All other support equipments powered from additional LISN(s). The LISN provide 50 Ohm/ 50uH of coupling impedance for the measuring instrument.
- Interconnecting cables that hang closer than 40 cm to the ground plane shall be folded back and forth in the center forming a bundle 30 to 40 cm long.
  - I/O cables that are not connected to a peripheral shall be bundled in the center. The end of the cable may be terminated, if required, using the correct terminating impedance. The overall length shall not exceed 1 m.
  - LISN at least 80 cm from nearest part of EUT chassis.
  - For the actual test configuration, please refer to the related Item –EUT Test Photos.

### 3.1.3 DEVIATION FROM TEST STANDARD

No deviation

### 3.1.4 TEST SETUP

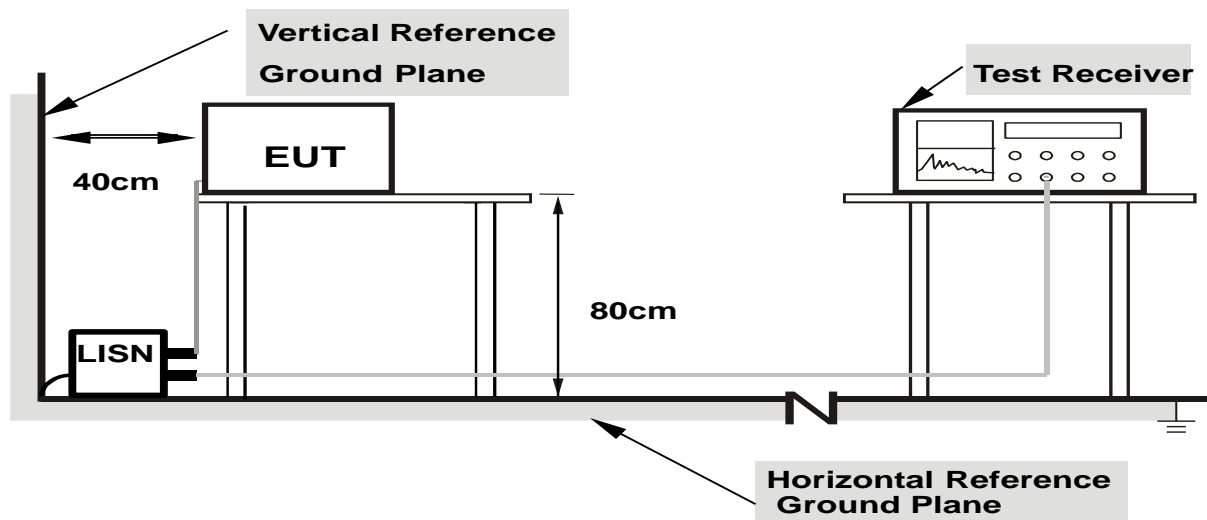

- Note: 1.Support units were connected to second LISN.  
2.Both of LISNs (AMN) are 80 cm from EUT and at least 80 cm from other units and other metal planes**

### 3.1.5 EUT OPERATING CONDITIONS

The EUT was configured for testing in a typical fashion (as a customer would normally use it). The EUT has been programmed to continuously transmit during test. This operating condition was tested and used to collect the included data.

## 3.1.6 TEST RESULTS

Temperature:	23.1 °C	Relative Humidity:	61%
Pressure:	1010hPa	Phase:	L
Test Voltage:	AC 120V/60Hz	Test Mode:	Mode 1

No.	Frequency (MHz)	Reading (dBuV)	Factor (dB)	Result (dBuV)	Limit (dBuV)	Margin (dB)	Detector
1	0.1900	40.74	9.23	49.97	64.04	-14.07	QP
2	0.1900	22.89	9.23	32.12	54.04	-21.92	AVG
3	0.3780	31.39	9.37	40.76	58.32	-17.56	QP
4	0.3780	18.33	9.37	27.70	48.32	-20.62	AVG
5	0.7580	28.09	9.22	37.31	56.00	-18.69	QP
6	0.7580	16.25	9.22	25.47	46.00	-20.53	AVG
7	1.7220	30.66	9.22	39.88	56.00	-16.12	QP
8	1.7220	16.98	9.22	26.20	46.00	-19.80	AVG
9	4.6780	26.38	9.27	35.65	56.00	-20.35	QP
10	4.6780	15.91	9.27	25.18	46.00	-20.82	AVG
11	16.4740	28.44	9.60	38.04	60.00	-21.96	QP
12	16.4740	19.06	9.60	28.66	50.00	-21.34	AVG

## Remark:

- All readings are Quasi-Peak and Average values.
- Margin = Result (Result = Reading + Factor) – Limit

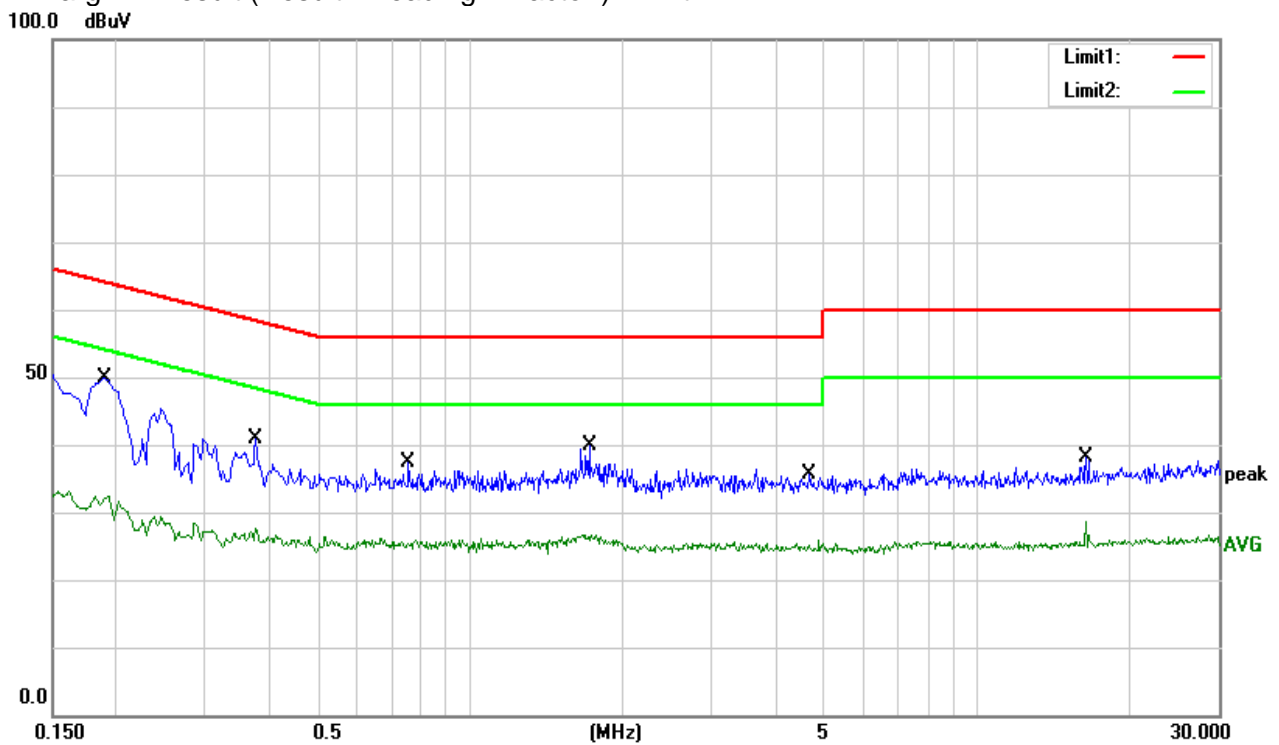

Temperature:	23.1°C	Relative Humidity:	61%
Pressure:	1010hPa	Phase:	N
Test Voltage:	AC 120V/60Hz	Test Mode:	Mode 1

No.	Frequency (MHz)	Reading (dBuV)	Factor (dB)	Result (dBuV)	Limit (dBuV)	Margin (dB)	Detector
1	0.1940	41.26	9.23	50.49	63.86	-13.37	QP
2	0.1940	23.36	9.23	32.59	53.86	-21.27	AVG
3	0.3020	34.11	9.14	43.25	60.19	-16.94	QP
4	0.3020	18.69	9.14	27.83	50.19	-22.36	AVG
5	0.6820	27.06	9.23	36.29	56.00	-19.71	QP
6	0.6820	15.95	9.23	25.18	46.00	-20.82	AVG
7	1.7140	28.43	9.22	37.65	56.00	-18.35	QP
8	1.7140	16.60	9.22	25.82	46.00	-20.18	AVG
9	4.6020	27.48	9.27	36.75	56.00	-19.25	QP
10	4.6020	15.50	9.27	24.77	46.00	-21.23	AVG
11	16.4700	28.35	9.60	37.95	60.00	-22.05	QP
12	16.4700	19.57	9.60	29.17	50.00	-20.83	AVG

Remark:

- All readings are Quasi-Peak and Average values.
- Margin = Result (Result = Reading + Factor) – Limit

100.0 dBuV

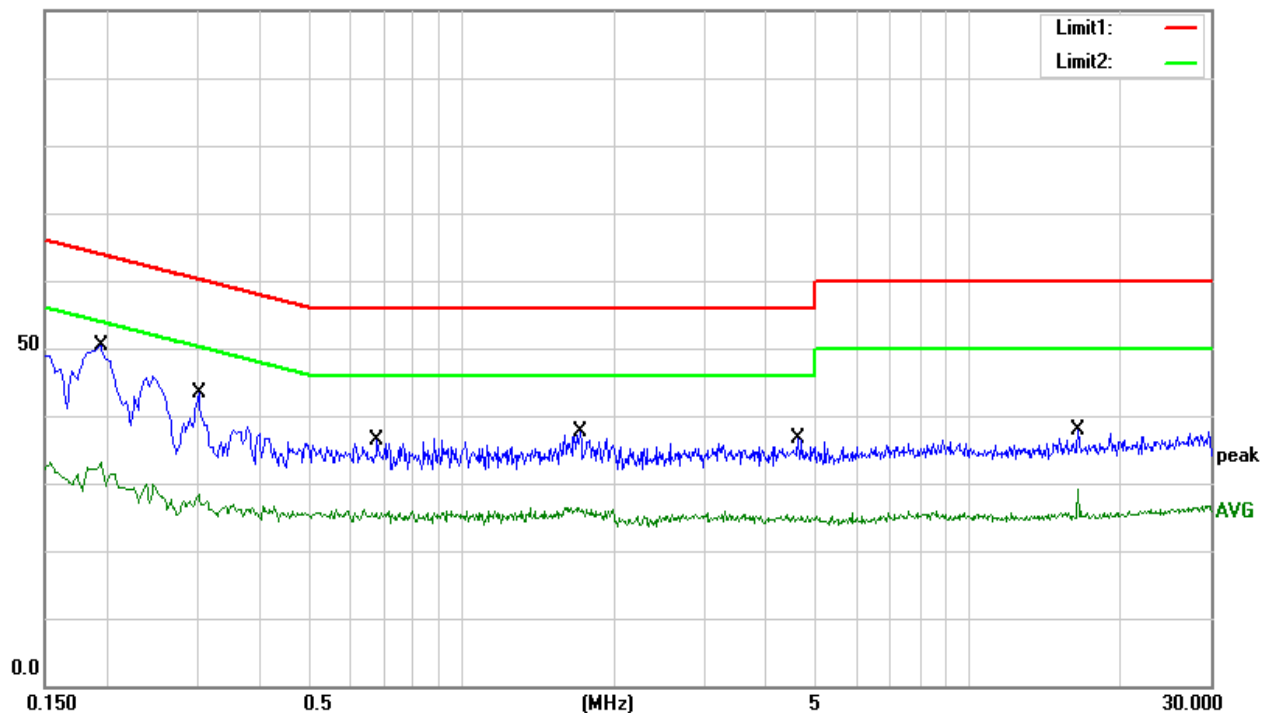

### 3.2 RADIATED EMISSION MEASUREMENT

#### 3.2.1 Radiated Emission Limits

In case the emission fall within the restricted band specified on 15.105(a)&109(a) limit in the table below has to be followed.

Frequencies (MHz)	Field Strength (micorvolts/meter)	Measurement Distance (meters)
30~88	100	3
88~216	150	3
216~960	200	3
Above 960	500	3

#### LIMITS OF RADIATED EMISSION MEASUREMENT

FREQUENCY (MHz)	Class A (dBuV/m) (at 3M)		Class B (dBuV/m) (at 3M)	
	PEAK	AVERAGE	PEAK	AVERAGE
Above 1000	80	60	74	54

Note:

- (1) The limit for radiated test was performed according to FCC PART 15B.
- (2) The tighter limit applies at the band edges.
- (3) Emission level (dBuV/m)=20log Emission level (uV/m).

#### FREQUENCY RANGE OF RADIATED MEASUREMENT (For unintentional radiators)

Highest frequency generated or Upper frequency of measurement used in the device or on which the device operates or tunes (MHz)	Range (MHz)
Below 1.705	30
1.705 – 108	1000
108 – 500	2000
500 – 1000	5000
Above 1000	5th harmonic of the highest frequency or 40 GHz, whichever is lower

Spectrum Parameter	Setting
Attenuation	Auto
Detector	Peak
Start Frequency	1000 MHz(Peak/AV)
Stop Frequency	5th harmonic (Peak/AV)
RB / VB (emission in restricted band)	30MHz to 1000MHz: 100 KHz / 300 KHz Above 1000MHz: 1 MHz / 3 MHz

Receiver Parameter	Setting
Attenuation	Auto
Start ~ Stop Frequency	30MHz to 1000MHz: 100 KHz / 300 KHz Above 1000MHz: 1 MHz / 3 MHz

### 3.2.2 TEST PROCEDURE

- a. The measuring distance of at 3 m shall be used for measurements at frequency up to 1GHz and above 1GHz.

The EUT was placed on the top of a rotating table 0.8 meters above the ground at a 3 meter anechoic chamber. The table was rotated 360 degrees to determine the position of the highest radiation.

- c. the height of the antenna shall vary between 1m to 4 m. Both horizontal and vertical polarizations of the antenna are set to make the measurement.

The initial step in collecting conducted emission data is a spectrum analyzer peak detector mode pre-scanning the measurement frequency range. Significant peaks are then marked and then Quasi Peak detector mode re-measured.

If the Peak Mode measured value compliance with and lower than Quasi Peak Mode Limit, the EUT shall be deemed to meet QP Limits and then no additional QP Mode measurement performed.

- f. For the actual test configuration, please refer to the related Item –EUT Test Photos.

Note: Both horizontal and vertical antenna polarities were tested and performed pretest to three orthogonal axis. The worst case emissions were reported

### 3.2.3 DEVIATION FROM TEST STANDARD

No deviation



### 3.2.4 TEST SETUP

#### (A) Radiated Emission Test-Up Frequency 30MHz~1GHz

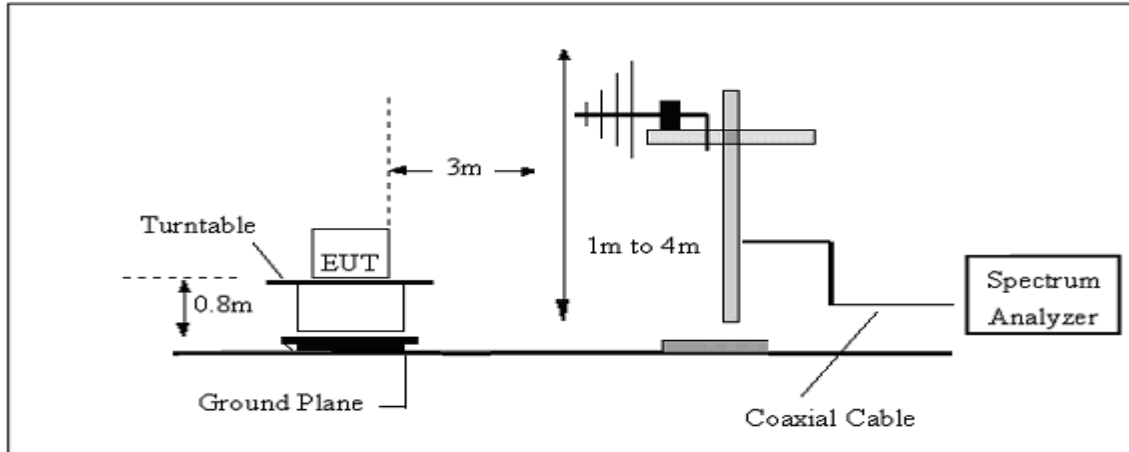

#### (B) Radiated Emission Test-Up Frequency Above 1GHz

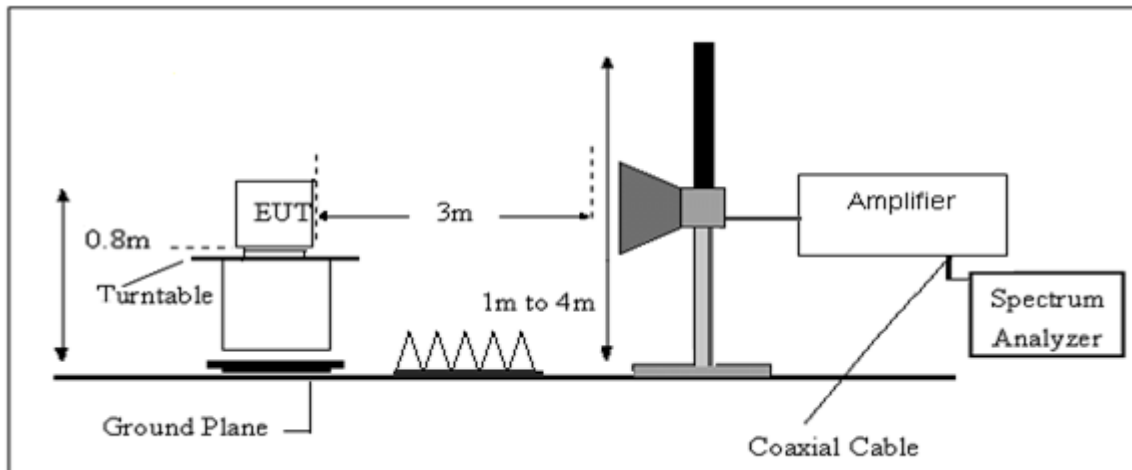

### 3.2.5 EUT OPERATING CONDITIONS

The EUT tested system was configured as the statements of 2.4 Unless otherwise a special operating condition is specified in the follows during the testing.

## 3.2.6 TEST RESULTS

30MHz -1000MHz

Temperature:	26 °C	Relative Humidity:	60%
Pressure:	1010hPa	Phase:	Horizontal
Test Voltage:	AC 120V/60Hz	Test Mode:	Mode 1

No.	Frequency (MHz)	Reading (dBuV)	Factor (dB)	Results (dBuV/m)	Limit (dBuV/m)	Margin (dB)	Detector
1	47.6586	42.26	-20.27	21.99	40.00	-18.01	QP
2	66.4990	51.89	-24.19	27.70	40.00	-12.30	QP
3	165.4866	42.95	-18.95	24.00	43.50	-19.50	QP
4	291.0360	45.09	-15.36	29.73	46.00	-16.27	QP
5	480.5276	43.87	-9.38	34.49	46.00	-11.51	QP
6	962.1623	32.56	-0.12	32.44	54.00	-21.56	QP

Remark:

1. Margin = Result (Result =Reading + Factor )–Limit

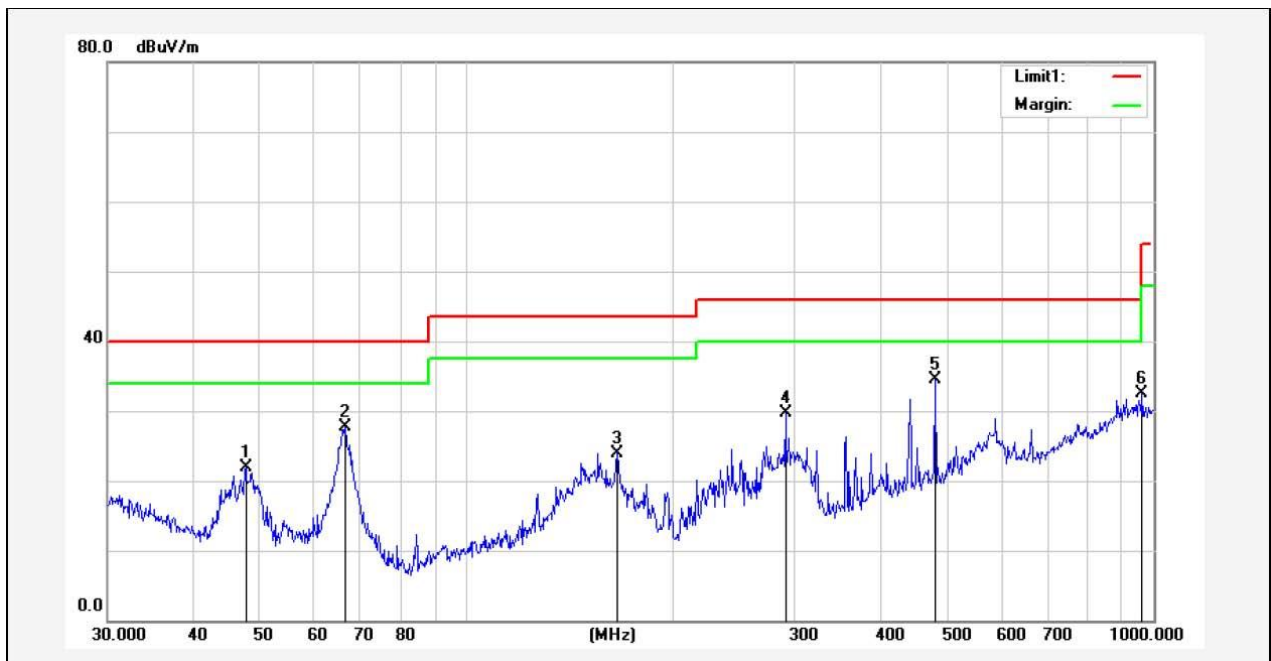

Temperature:	26 °C	Relative Humidity:	60%
Pressure:	1010hPa	Phase:	Vertical
Test Voltage:	AC 120V/60Hz	Test Mode:	Mode 1

No.	Frequency (MHz)	Reading (dBuV)	Factor (dB)	Results (dBuV/m)	Limit (dBuV/m)	Margin (dB)	Detector
1	33.2112	30.91	-12.84	18.07	40.00	-21.93	QP
2	66.0342	37.55	-24.20	13.35	40.00	-26.65	QP
3	291.0360	37.38	-15.36	22.02	46.00	-23.98	QP
4	441.7426	49.79	-10.82	38.97	46.00	-7.03	QP
5	515.4374	41.46	-8.86	32.60	46.00	-13.40	QP
6	919.2866	34.04	-1.61	32.43	46.00	-13.57	QP

Remark:

1. Margin = Result (Result = Reading + Factor) – Limit

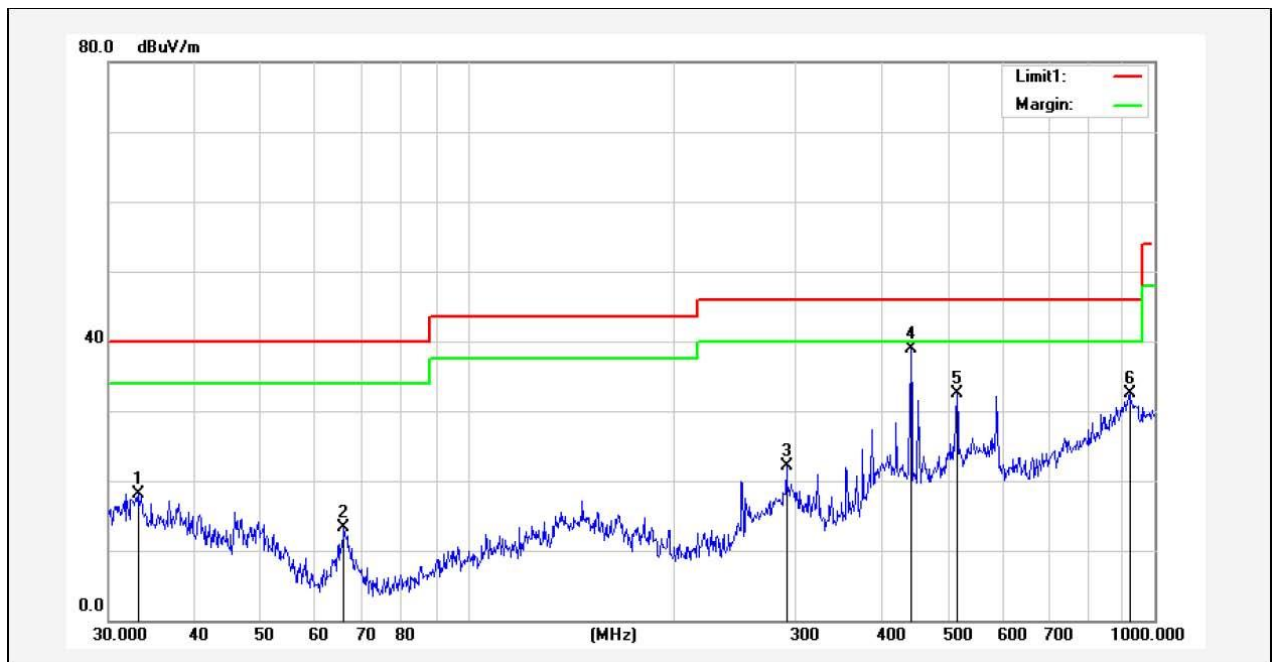

( 1 GHz to 25GHz.)

Temperature:	26 °C	Relative Humidity:	60%
Pressure:	1010hPa	Phase:	Vertical/Horizontal
Test Voltage:	AC 120V/60Hz	Test Mode:	Mode 1

**PK**

Freq.	Ant. Pol	Peak	Amplifier	Loss	Antenna Factor	Orrected Factor	Actual Fs	Peak	Peak
(MHz)	H/V	Reading (dBuV)	(dB)	(dB)	(dB/m)	(dB)	Peak (dBuV/m)	Limit (dBuV/m)	margin (dBuV/m)
1403.24	H	67.76	45.1	4.0	25.1	-16.0	51.76	74.00	-22.24
3000.75	H	56.72	44.7	6.7	28.2	-9.8	46.92	74.00	-27.08
4002.44	H	62.45	44.2	7.9	29.7	-6.6	55.85	74.00	-18.15
5506.87	H	52.14	44.2	9.7	32.0	-2.5	49.64	74.00	-24.36
1403.24	V	53.94	45.1	4.0	25.1	-16.0	37.94	74.00	-36.06
3000.75	V	54.17	44.7	6.7	28.2	-9.8	44.37	74.00	-29.63
4002.44	V	63.86	44.2	7.9	29.7	-6.6	57.26	74.00	-16.74
5506.87	V	57.67	44.2	9.7	32.0	-2.5	55.17	74.00	-18.83

**AV**

Freq.	Ant. Pol	AV	Amplifier	Loss	Antenna Factor	Orrected Factor	AV	AV	AV
(MHz)	H/V	Reading (dBuV)	(dB)	(dB)	(dB/m)	(dB)	AV (dBuV/m)	Limit (dBuV/m)	margin (dBuV/m)
1403.24	H	49.76	45.1	4.0	25.1	-16.0	33.76	54.00	-20.24
3000.75	H	46.18	44.7	6.7	28.2	-9.8	36.38	54.00	-17.62
4002.44	H	52.09	44.2	7.9	29.7	-6.6	45.49	54.00	-8.51
5506.87	H	50.11	44.2	9.7	32.0	-2.5	47.61	54.00	-6.39
1403.24	V	37.69	45.1	4.0	25.1	-16.0	21.69	54.00	-32.31
3000.75	V	41.55	44.7	6.7	28.2	-9.8	31.75	54.00	-22.25
4002.44	V	33.56	44.2	7.9	29.7	-6.6	26.96	54.00	-27.04
5506.87	V	30.27	44.2	9.7	32.0	-2.5	27.77	54.00	-26.23

Notes:

1. Measuring frequencies from 1 GHz to 25GHz.
2. Radiated emissions measured in frequency above 1000MHz were made with an instrument using Peak detector mode of the emission shown in Actual FS column.
3. The frequency that above 5.5GHz is mainly from the environment noise.

#### 4. PHOTOS OF TEST SETUP

##### Radiated Measurement Photos

30MHz- 1GHz



Above 1GHz

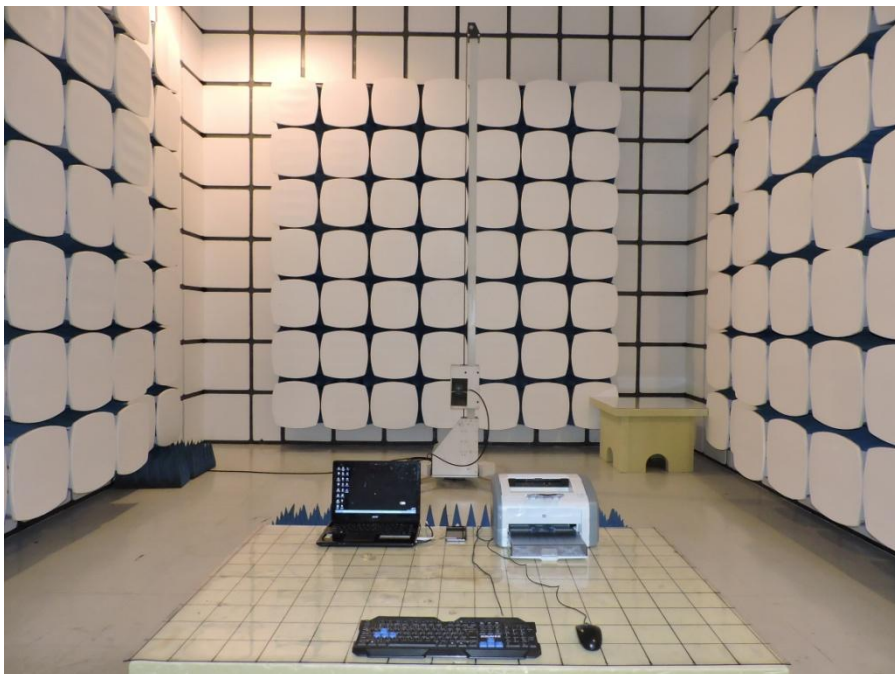

Conducted Measurement Photos



\*\*\*\*\*END OF THE REPORT\*\*\*\*\*