

FCC Test Report

(PART 27)

Report No.: RF180425C07A-2

FCC ID: N7NHL78M

Test Model: HL7800-M

Received Date: Jun. 14, 2018

Test Date: Jun. 30, 2018 ~ Jul. 09, 2018

Issued Date: Jul. 18, 2018

Applicant: Sierra Wireless Inc.

Address: 13811 Wireless Way, Richmond, BC, Canada V6V3A4

Issued By: Bureau Veritas Consumer Products Services (H.K.) Ltd., Taoyuan Branch

Lab Address: No. 47-2, 14th Ling, Chia Pau Vil., Lin Kou Dist., New Taipei City, Taiwan
(R.O.C)

Test Location: No. 19, Hwa Ya 2nd Rd, Wen Hwa Vil, Kwei Shan Dist., Taoyuan City
33383, Taiwan (R.O.C)

**FCC Registration /
Designation Number:** 788550 / TW0003



This report is for your exclusive use. Any copying or replication of this report to or for any other person or entity, or use of our name or trademark, is permitted only with our prior written permission. This report sets forth our findings solely with respect to the test samples identified herein. The results set forth in this report are not indicative or representative of the quality or characteristics of the lot from which a test sample was taken or any similar or identical product unless specifically and expressly noted. Our report includes all of the tests requested by you and the results thereof based upon the information that you provided to us. You have 60 days from date of issuance of this report to notify us of any material error or omission caused by our negligence, provided, however, that such notice shall be in writing and shall specifically address the issue you wish to raise. A failure to raise such issue within the prescribed time shall constitute your unqualified acceptance of the completeness of this report, the tests conducted and the correctness of the report contents. Unless specific mention, the uncertainty of measurement has been explicitly taken into account to declare the compliance or non-compliance to the specification. The report must not be used by the client to claim product certification, approval, or endorsement by TAF or any government agencies

Table of Contents

Release Control Record	4
1 Certificate of Conformity	5
2 Summary of Test Results	6
2.1 Measurement Uncertainty	8
2.2 Test Site and Instruments	9
3 General Information	10
3.1 General Description of EUT	10
3.2 Configuration of System under Test	12
3.2.1 Description of Support Units	12
3.3 Test Mode Applicability and Tested Channel Detail	13
3.4 EUT Operating Conditions	20
3.5 General Description of Applied Standards	20
4 Test Types and Results	21
4.1 Output Power Measurement	21
4.1.1 Limits of Output Power Measurement	21
4.1.2 Test Procedures	21
4.1.3 Test Setup	22
4.1.4 Test Results	23
4.2 Modulation characteristics Measurement	60
4.2.1 Limits of Modulation characteristics	60
4.2.2 Test Procedure	60
4.2.3 Test Setup	60
4.2.4 Test Results	61
4.3 Frequency Stability Measurement	66
4.3.1 Limits of Frequency Stability Measurement	66
4.3.2 Test Procedure	66
4.3.3 Test Setup	66
4.3.4 Test Results	67
4.4 Occupied Bandwidth Measurement	87
4.4.1 Limits of Occupied Bandwidth Measurement	87
4.4.2 Test Procedure	87
4.4.3 Test Setup	87
4.4.4 Test Result	88
4.5 Band Edge Measurement	98
4.5.1 Limits of Band Edge Measurement	98
4.5.2 Test Setup	98
4.5.3 Test Procedures	98
4.5.4 Test Results	99
4.6 Peak to Average Ratio	121
4.6.1 Limits of Peak to Average Ratio Measurement	121
4.6.2 Test Setup	121
4.6.3 Test Procedures	121
4.6.4 Test Results	122
4.7 Conducted Spurious Emissions	132
4.7.1 Limits of Conducted Spurious Emissions Measurement	132
4.7.2 Test Setup	132
4.7.3 Test Procedure	132
4.7.4 Test Results	133
4.8 Radiated Emission Measurement	177
4.8.1 Limits of Radiated Emission Measurement	177
4.8.2 Test Procedure	177
4.8.3 Deviation from Test Standard	177
4.8.4 Test Setup	178

4.8.5 Test Results	179
5 Pictures of Test Arrangements.....	261
Appendix – Information on the Testing Laboratories	262



Release Control Record

Issue No.	Description	Date Issued
RF180425C07A-2	Original Release	Jul. 18, 2018

1 Certificate of Conformity

Product: Embedded Module
Brand: AirPrime
Test Model: HL7800-M
Sample Status: ENGINEERING SAMPLE
Applicant: Sierra Wireless Inc.
Test Date: Jun. 30, 2018 ~ Jul. 09, 2018
Standards: FCC Part 27, Subpart C, H, F, L

The above equipment has been tested by **Bureau Veritas Consumer Products Services (H.K.) Ltd., Taoyuan Branch**, and found compliance with the requirement of the above standards. The test record, data evaluation & Equipment Under Test (EUT) configurations represented herein are true and accurate accounts of the measurements of the sample's RF characteristics under the conditions specified in this report.

Prepared by : Gina Liu , **Date:** Jul. 18, 2018
Gina Liu / Specialist

Approved by : Dylan Chiou , **Date:** Jul. 18, 2018
Dylan Chiou / Project Engineer

2 Summary of Test Results

Applied Standard: FCC Part 27 & Part 2 (LTE 4)			
FCC Clause	Test Item	Result	Remarks
2.1046 27.50(d)(4)	Maximum Peak Output Power	Pass	Meet the requirement of limit.
2.1047	Modulation characteristics	Pass	Meet the requirement
2.1055 27.54	Frequency Stability	Pass	Meet the requirement of limit.
2.1049 27.53(h)	Occupied Bandwidth	Pass	Meet the requirement of limit.
27.50(d)(5)	Peak to Average Ratio	Pass	Meet the requirement of limit.
27.53(h)	Band Edge Measurements	Pass	Meet the requirement of limit.
2.1051 27.53(h)	Conducted Spurious Emissions	Pass	Meet the requirement of limit.
2.1053 27.53(h)	Radiated Spurious Emissions	Pass	Meet the requirement of limit. Minimum passing margin is -17.33 dB at 3490.00 MHz.

Applied Standard: FCC Part 27 & Part 2 (LTE 12)			
FCC Clause	Test Item	Result	Remarks
2.1046 27.50(c)(10)	Maximum Peak Output Power	Pass	Meet the requirement of limit.
2.1047	Modulation characteristics	Pass	Meet the requirement
2.1055 27.54	Frequency Stability	Pass	Meet the requirement of limit.
2.1049 27.53(g)	Occupied Bandwidth	Pass	Meet the requirement of limit.
27.50(d)(5)	Peak to Average Ratio	Pass	Meet the requirement of limit.
27.53(g)	Band Edge Measurements	Pass	Meet the requirement of limit.
2.1051 27.53(g)	Conducted Spurious Emissions	Pass	Meet the requirement of limit.
2.1053 27.53(g)	Radiated Spurious Emissions	Pass	Meet the requirement of limit. Minimum passing margin is -30.13 dB at 1415.00 MHz.

Applied Standard: FCC Part 27 & Part 2 (LTE 13)			
FCC Clause	Test Item	Result	Remarks
2.1046 27.50(b)(10)	Maximum Peak Output Power	Pass	Meet the requirement of limit.
2.1047	Modulation characteristics	Pass	Meet the requirement
2.1055 27.54	Frequency Stability	Pass	Meet the requirement of limit.
2.1049 27.53(g)	Occupied Bandwidth	Pass	Meet the requirement of limit.
27.50(d)(5)	Peak to Average Ratio	Pass	Meet the requirement of limit.
27.53(g)	Band Edge Measurements	Pass	Meet the requirement of limit.
2.1051 27.53(g)	Conducted Spurious Emissions	Pass	Meet the requirement of limit.
2.1053 27.53(g)(f)	Radiated Spurious Emissions	Pass	Meet the requirement of limit. Minimum passing margin is -13.24 dB at 1564.00 MHz.

Applied Standard: FCC Part 27 & Part 2 (LTE 17)			
FCC Clause	Test Item	Result	Remarks
2.1046 27.50(c)(10)	Maximum Peak Output Power	Pass	Meet the requirement of limit.
2.1047	Modulation characteristics	Pass	Meet the requirement
2.1055 27.54	Frequency Stability	Pass	Meet the requirement of limit.
2.1049 27.53(g)	Occupied Bandwidth	Pass	Meet the requirement of limit.
27.50(d)(5)	Peak to Average Ratio	Pass	Meet the requirement of limit.
27.53(g)	Band Edge Measurements	Pass	Meet the requirement of limit.
2.1051 27.53(g)	Conducted Spurious Emissions	Pass	Meet the requirement of limit.
2.1053 27.53(g)	Radiated Spurious Emissions	Pass	Meet the requirement of limit. Minimum passing margin is -28.40 dB at 2130.00 MHz.

Applied Standard: FCC Part 27 & Part 2 (LTE 66)			
FCC Clause	Test Item	Result	Remarks
2.1046 27.50(d)(4)	Maximum Peak Output Power	Pass	Meet the requirement of limit.
2.1047	Modulation characteristics	Pass	Meet the requirement
2.1055 27.54	Frequency Stability	Pass	Meet the requirement of limit.
2.1049 27.53(h)	Occupied Bandwidth	Pass	Meet the requirement of limit.
27.50(d)(5)	Peak to Average Ratio	Pass	Meet the requirement of limit.
27.53(h)	Band Edge Measurements	Pass	Meet the requirement of limit.
2.1051 27.53(h)	Conducted Spurious Emissions	Pass	Meet the requirement of limit.
2.1053 27.53(h)	Radiated Spurious Emissions	Pass	Meet the requirement of limit. Minimum passing margin is -37.01 dB at 3490.00 MHz.

2.1 Measurement Uncertainty

Where relevant, the following measurement uncertainty levels have been estimated for tests performed on the EUT as specified in CISPR 16-4-2:

Measurement	Frequency	Expanded Uncertainty (k=2) (±)
Conducted Emissions at mains ports	150 kHz ~ 30 MHz	2.44 dB
Radiated Emissions up to 1 GHz	30 MHz ~ 200 MHz	2.93 dB
	200 MHz ~ 1000 MHz	2.95 dB
Radiated Emissions above 1 GHz	1 GHz ~ 18 GHz	2.26 dB
	18 GHz ~ 40 GHz	1.94 dB

2.2 Test Site and Instruments

Description & Manufacturer	Model No.	Serial No.	Date of Calibration	Due Date of Calibration
Test Receiver Agilent	N9038A	MY51210203	Mar. 16, 2018	Mar. 15, 2019
Spectrum Analyzer Agilent	N9010A	MY52220314	Nov. 24, 2017	Nov. 23, 2018
Spectrum Analyzer ROHDE & SCHWARZ	FSU43	101261	Jan. 11, 2018	Jan. 10, 2019
Double Ridge Guide Horn Antenna EMCO	3115	5619	Nov. 30, 2017	Nov. 29, 2018
BILOG Antenna SCHWARZBECK	VULB 9168	9168-153	Dec. 06, 2017	Dec. 05, 2018
Radio Communication Analyzer Anritsu	MT8820C	6201300640	Aug. 16, 2017	Aug. 15, 2019
Preamplifier EMCI	EMC 012645	980115	Oct. 20, 2017	Oct. 19, 2018
Preamplifier EMCI	EMC 184045	980116	Oct. 20, 2017	Oct. 19, 2018
Preamplifier EMCI	EMC 330H	980112	Oct. 13, 2017	Oct. 12, 2018
Power Meter Anritsu	ML2495A	1012010	Aug. 15, 2017	Aug. 14, 2018
Power Sensor Anritsu	MA2411B	1315050	Aug. 15, 2017	Aug. 14, 2018
RF Coaxial Cable HUBER+SUHNNER	EMC104-SM-SM-8000 &3000	140811+170717	Oct. 20, 2017	Oct. 19, 2018
RF Coaxial Cable HUBER+SUHNNER	SUCOFLEX 104	EMC104-SM-SM-10 00(140807)	Oct. 20, 2017	Oct. 19, 2018
RF Coaxial Cable Worken	8D-FB	Cable-Ch10-01	Oct. 20, 2017	Oct. 19, 2018
Software BV ADT	E3 6.120103	NA	NA	NA
Antenna Tower MF	MFA-440H	NA	NA	NA
Turn Table MF	MFT-201SS	NA	NA	NA
Antenna Tower & Turn Table Controller MF	MF-7802	NA	NA	NA
DC Power Supply Topward	33010D	807748	Oct. 25, 2016	Oct. 24, 2018
STANDARD TEMPERATURE & HUMIDITY CHAMBER TERCHY	MHU-225AU	920842	Jun. 01, 2018	May 30, 2019

- Note: 1. The calibration interval of the above test instruments is 12 / 24 months and the calibrations are traceable to NML/ROC and NIST/USA.
2. The test was performed in HwaYa Chamber 10.
3. The horn antenna and preamplifier (model: EMC 184045) are used only for the measurement of emission frequency above 1 GHz if tested.
4. The IC Site Registration No. is IC7450F-10.

3 General Information

3.1 General Description of EUT

Product	Embedded Module	
Brand	AirPrime	
Test Model	HL7800-M	
Status of EUT	ENGINEERING SAMPLE	
Power Supply Rating	5.0 Vdc (host equipment) 12.0 Vdc (adapter)	
Modulation Type	LTE	QPSK, 16QAM
Frequency Range	LTE Band 4 (Channel Bandwidth: 1.4 MHz)	1710.7 ~ 1754.3 MHz
	LTE Band 4 (Channel Bandwidth: 3 MHz)	1711.5 ~ 1753.5 MHz
	LTE Band 4 (Channel Bandwidth: 5 MHz)	1712.5 ~ 1752.5 MHz
	LTE Band 4 (Channel Bandwidth: 10 MHz)	1715.0 ~ 1750.0 MHz
	LTE Band 4 (Channel Bandwidth: 15 MHz)	1717.5 ~ 1747.5 MHz
	LTE Band 4 (Channel Bandwidth: 20 MHz)	1720.0 ~ 1745.0 MHz
	LTE Band 12 (Channel Bandwidth: 1.4 MHz)	699.7 ~ 715.3 MHz
	LTE Band 12 (Channel Bandwidth: 3 MHz)	700.5 ~ 714.5 MHz
	LTE Band 12 (Channel Bandwidth: 5 MHz)	701.5 ~ 713.5 MHz
	LTE Band 12 (Channel Bandwidth: 10 MHz)	704.0 ~ 711.0 MHz
	LTE Band 13 (Channel Bandwidth: 5 MHz)	779.5 ~ 784.5 MHz
	LTE Band 13 (Channel Bandwidth: 10 MHz)	782.0 MHz
	LTE Band 17 (Channel Bandwidth: 5 MHz)	706.5 ~ 713.5 MHz
	LTE Band 17 (Channel Bandwidth: 10 MHz)	709.0 ~ 711.0 MHz
	LTE Band 66 (Channel Bandwidth: 1.4 MHz)	1710.7 ~ 1779.3 MHz
	LTE Band 66 (Channel Bandwidth: 3 MHz)	1711.5 ~ 1778.5 MHz
	LTE Band 66 (Channel Bandwidth: 5 MHz)	1712.5 ~ 1777.5 MHz
	LTE Band 66 (Channel Bandwidth: 10 MHz)	1715.0 ~ 1775.0 MHz
LTE Band 66 (Channel Bandwidth: 15 MHz)	1717.5 ~ 1772.5 MHz	
LTE Band 66 (Channel Bandwidth: 20 MHz)	1720.0 ~ 1770.0 MHz	
Emission Designator	LTE Band 4 (Channel Bandwidth: 1.4 MHz)	1M09G7D
	LTE Band 4 (Channel Bandwidth: 3 MHz)	1M09G7D
	LTE Band 4 (Channel Bandwidth: 5 MHz)	1M09G7D
	LTE Band 4 (Channel Bandwidth: 10 MHz)	1M09G7D
	LTE Band 4 (Channel Bandwidth: 15 MHz)	1M10G7D
	LTE Band 4 (Channel Bandwidth: 20 MHz)	1M09G7D
	LTE Band 12 (Channel Bandwidth: 1.4 MHz)	1M09G7D
	LTE Band 12 (Channel Bandwidth: 3 MHz)	1M09G7D
	LTE Band 12 (Channel Bandwidth: 5 MHz)	1M08G7D
	LTE Band 12 (Channel Bandwidth: 10 MHz)	1M09G7D
	LTE Band 13 (Channel Bandwidth: 5 MHz)	1M09G7D
	LTE Band 13 (Channel Bandwidth: 10 MHz)	1M09G7D
	LTE Band 17 (Channel Bandwidth: 5 MHz)	1M09G7D
	LTE Band 17 (Channel Bandwidth: 10 MHz)	1M09G7D
LTE Band 66 (Channel Bandwidth: 1.4 MHz)	1M09G7D	

	LTE Band 66 (Channel Bandwidth: 3 MHz)	1M08G7D
	LTE Band 66 (Channel Bandwidth: 5 MHz)	1M09G7D
	LTE Band 66 (Channel Bandwidth: 10 MHz)	1M09G7D
	LTE Band 66 (Channel Bandwidth: 15 MHz)	1M10G7D
	LTE Band 66 (Channel Bandwidth: 20 MHz)	1M09G7D
Max. ERP Power	LTE Band 12 (Channel Bandwidth: 1.4 MHz)	329.61 mW
	LTE Band 12 (Channel Bandwidth: 3 MHz)	314.05 mW
	LTE Band 12 (Channel Bandwidth: 5 MHz)	292.42 mW
	LTE Band 12 (Channel Bandwidth: 10 MHz)	277.97 mW
	LTE Band 13 (Channel Bandwidth: 5 MHz)	283.79 mW
	LTE Band 13 (Channel Bandwidth: 10 MHz)	264.85 mW
	LTE Band 17 (Channel Bandwidth: 5 MHz)	285.76 mW
Max. EIRP Power	LTE Band 4 (Channel Bandwidth: 1.4 MHz)	314.77 mW
	LTE Band 4 (Channel Bandwidth: 3 MHz)	297.17 mW
	LTE Band 4 (Channel Bandwidth: 5 MHz)	276.69 mW
	LTE Band 4 (Channel Bandwidth: 10 MHz)	263.63 mW
	LTE Band 4 (Channel Bandwidth: 15 MHz)	247.74 mW
	LTE Band 4 (Channel Bandwidth: 20 MHz)	234.42 mW
	LTE Band 66 (Channel Bandwidth: 1.4 MHz)	289.07 mW
	LTE Band 66 (Channel Bandwidth: 3 MHz)	269.77 mW
	LTE Band 66 (Channel Bandwidth: 5 MHz)	254.68 mW
	LTE Band 66 (Channel Bandwidth: 10 MHz)	239.88 mW
	LTE Band 66 (Channel Bandwidth: 15 MHz)	223.36 mW
	LTE Band 66 (Channel Bandwidth: 20 MHz)	209.89 mW
Antenna Type	Dipole Antenna with 2 dBi gain	
Accessory Device	N/A	
Data Cable Supplied	N/A	

Note:

1. The above EUT information is declared by manufacturer and for more detailed features description, please refers to the manufacturer's specifications or user's manual.

3.2 Configuration of System under Test

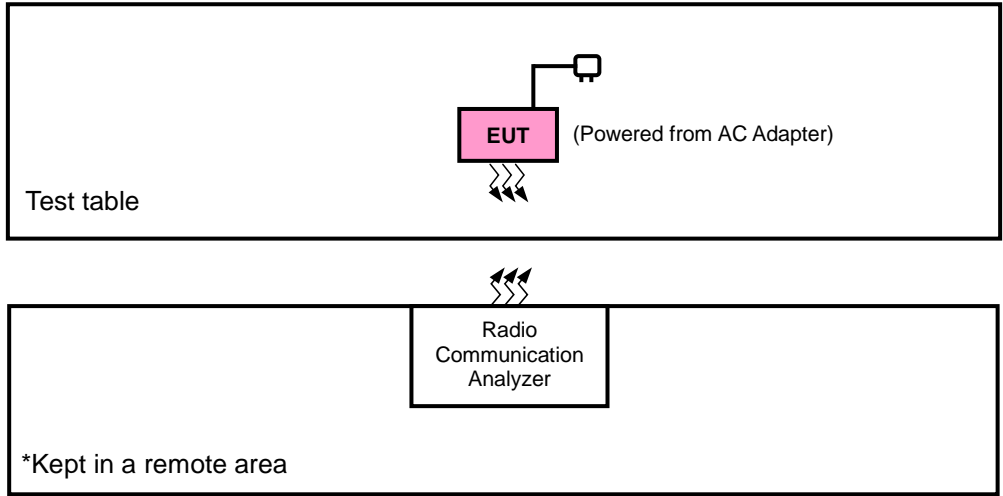

3.2.1 Description of Support Units

The EUT has been tested as an independent unit together with other necessary accessories or support units. The following support units or accessories were used to form a representative test configuration during the tests.

No.	Product	Brand	Model No.	Serial No.	FCC ID
1.	Adapter	N/A	N/A	N/A	N/A
2.	Radio Communication Analyzer	Anritsu	MT8820C	6201300640	NA

No.	Signal Cable Description Of The Above Support Units
1.	N/A
2.	N/A

Note:

1. All power cords of the above support units are non-shielded (1.8m).
2. Item 1 was provided by client.
3. Item 2 acted as communication partners to transfer data.

3.3 Test Mode Applicability and Tested Channel Detail

Pre-Scan has been conducted to determine the worst-case mode from all possible combinations between available modulations, data rates, XYZ axis, and antenna ports

The worst case was found when positioned as the table below. Following channel(s) was (were) selected for the final test as listed below:

Band	ERP / EIRP	Radiated Emission
LTE Band 4	X-plane	Z-axis
LTE Band 12	X-plane	Z-axis
LTE Band 13	X-plane	Z-axis
LTE Band 17	X-plane	Z-axis
LTE Band 66	X-plane	Z-axis

LTE Band 4

EUT Configure Mode	Test Item	Available Channel	Tested Channel	Channel Bandwidth	Modulation	Mode
-	EIRP	19957 to 20393	19957, 20175, 20393	1.4 MHz	QPSK, 16QAM	1 RB / 5 RB Offset
		19965 to 20385	19965, 20175, 20385	3 MHz	QPSK, 16QAM	1 RB / 14 RB Offset
		19975 to 20375	19975, 20175, 20375	5 MHz	QPSK, 16QAM	1 RB / 24 RB Offset
		20000 to 20350	20000, 20175, 20350	10 MHz	QPSK, 16QAM	1 RB / 49 RB Offset
		20025 to 20325	20025, 20175, 20325	15 MHz	QPSK, 16QAM	1 RB / 74 RB Offset
		20050 to 20300	20050, 20175, 20300	20 MHz	QPSK, 16QAM	1 RB / 99 RB Offset
-	Modulation characteristics	19975 to 20375	20175	5 MHz	QPSK, 16QAM	5 RB / 0 RB Offset
-	Frequency Stability	19957 to 20393	19957, 20393	1.4 MHz	QPSK	1 RB / 5 RB Offset
		19965 to 20385	19965, 20385	3 MHz	QPSK	1 RB / 14 RB Offset
		19975 to 20375	19975, 20375	5 MHz	QPSK	1 RB / 24 RB Offset
		20000 to 20350	20000, 20350	10 MHz	QPSK	1 RB / 49 RB Offset
		20025 to 20325	20025, 20325	15 MHz	QPSK	1 RB / 74 RB Offset
		20050 to 20300	20050, 20300	20 MHz	QPSK	1 RB / 99 RB Offset
-	Occupied Bandwidth	19957 to 20393	19957, 20175, 20393	1.4 MHz	QPSK, 16QAM	6 RB / 0 RB Offset
		19965 to 20385	19965, 20175, 20385	3 MHz	QPSK, 16QAM	15 RB / 0 RB Offset
		19975 to 20375	19975, 20175, 20375	5 MHz	QPSK, 16QAM	25 RB / 0 RB Offset
		20000 to 20350	20000, 20175, 20350	10 MHz	QPSK, 16QAM	50 RB / 0 RB Offset
		20025 to 20325	20025, 20175, 20325	15 MHz	QPSK, 16QAM	75 RB / 0 RB Offset
		20050 to 20300	20050, 20175, 20300	20 MHz	QPSK, 16QAM	100 RB / 0 RB Offset
-	Peak to Average Ratio	19957 to 20393	19957, 20175, 20393	1.4 MHz	QPSK, 16QAM	1 RB / 2 RB Offset
		19965 to 20385	19965, 20175, 20385	3 MHz	QPSK, 16QAM	1 RB / 7 RB Offset
		19975 to 20375	19975, 20175, 20375	5 MHz	QPSK, 16QAM	12 RB / 0 RB Offset
		20000 to 20350	20000, 20175, 20350	10 MHz	QPSK, 16QAM	1 RB / 24 RB Offset
		20025 to 20325	20025, 20175, 20325	15 MHz	QPSK, 16QAM	36 RB / 0 RB Offset
		20050 to 20300	20050, 20175, 20300	20 MHz	QPSK, 16QAM	50 RB / 0 RB Offset

EUT Configure Mode	Test Item	Available Channel	Tested Channel	Channel Bandwidth	Modulation	Mode		
-	Band Edge	19957 to 20393	19957	1.4 MHz	QPSK	1 RB / 0 RB Offset 6 RB / 0 RB Offset		
			20393	1.4 MHz	QPSK	1 RB / 5 RB Offset 6 RB / 0 RB Offset		
		19965 to 20385	19965	3 MHz	QPSK	1 RB / 0 RB Offset 15 RB / 0 RB Offset		
			20385	3 MHz	QPSK	1 RB / 14 RB Offset 15 RB / 0 RB Offset		
		19975 to 20375	19975	5 MHz	QPSK	1 RB / 0 RB Offset 25 RB / 0 RB Offset		
				20375	5 MHz	QPSK	1 RB / 24 RB Offset 25 RB / 0 RB Offset	
			20000 to 20350	20000	10 MHz	QPSK	1 RB / 0 RB Offset 50 RB / 0 RB Offset	
		20350		10 MHz	QPSK	1 RB / 49 RB Offset 50 RB / 0 RB Offset		
		20025 to 20325	20025	15 MHz	QPSK	1 RB / 0 RB Offset 75 RB / 0 RB Offset		
			20325	15 MHz	QPSK	1 RB / 74 RB Offset 75 RB / 0 RB Offset		
		20050 to 20300	20050	20 MHz	QPSK	1 RB / 0 RB Offset 100 RB / 0 RB Offset		
			20300	20 MHz	QPSK	1 RB / 99 RB Offset 100 RB / 0 RB Offset		
		-	Conducted Emission	19957 to 20393	19957, 20175, 20393	1.4 MHz	QPSK	1 RB / 2 RB Offset
				19965 to 20385	19965, 20175, 20385	3 MHz	QPSK	1 RB / 7 RB Offset
				19975 to 20375	19975, 20175, 20375	5 MHz	QPSK	12 RB / 0 RB Offset
				20000 to 20350	20000, 20175, 20350	10 MHz	QPSK	50 RB / 0 RB Offset
				20025 to 20325	20025, 20175, 20325	15 MHz	QPSK	36 RB / 0 RB Offset
				20050 to 20300	20050, 20175, 20300	20 MHz	QPSK	50 RB / 0 RB Offset
-	Radiated Emission	19957 to 20393	19957, 20175, 20393	1.4 MHz	QPSK	1 RB / 2 RB Offset		
		19975 to 20375	19975, 20175, 20375	5 MHz	QPSK	12 RB / 0 RB Offset		
		20050 to 20300	20050, 20175, 20300	20 MHz	QPSK	50 RB / 0 RB Offset		

Note: This device was tested under all bandwidths, RB configurations and modulations. The worst case was found in QPSK modulation.

LTE Band 12

EUT Configure Mode	Test Item	Available Channel	Tested Channel	Channel Bandwidth	Modulation	Mode		
-	ERP	23017 to 23173	23017, 23095, 23173	1.4 MHz	QPSK, 16QAM	1 RB / 2 RB Offset		
		23025 to 23165	23025, 23095, 23165	3 MHz	QPSK, 16QAM	1 RB / 7 RB Offset		
		23035 to 23155	23035, 23095, 23155	5 MHz	QPSK, 16QAM	1 RB / 12 RB Offset		
		23060 to 23130	23060, 23095, 23130	10 MHz	QPSK, 16QAM	1 RB / 24 RB Offset		
-	Modulation characteristics	23035 to 23155	23095	5 MHz	QPSK, 16QAM	5 RB / 0 RB Offset		
-	Frequency Stability	23017 to 23173	23017, 23173	1.4 MHz	QPSK	1 RB / 2 RB Offset		
		23025 to 23165	23025, 23165	3 MHz	QPSK	1 RB / 7 RB Offset		
		23035 to 23155	23035, 23155	5 MHz	QPSK	1 RB / 12 RB Offset		
		23060 to 23130	23060, 23130	10 MHz	QPSK	1 RB / 24 RB Offset		
-	Occupied Bandwidth	23017 to 23173	23017, 23095, 23173	1.4 MHz	QPSK, 16QAM	6 RB / 0 RB Offset		
		23025 to 23165	23025, 23095, 23165	3 MHz	QPSK, 16QAM	15 RB / 0 RB Offset		
		23035 to 23155	23035, 23095, 23155	5 MHz	QPSK, 16QAM	25 RB / 0 RB Offset		
		23060 to 23130	23060, 23095, 23130	10 MHz	QPSK, 16QAM	50 RB / 0 RB Offset		
-	Peak to Average Ratio	23017 to 23173	23017, 23095, 23173	1.4 MHz	QPSK, 16QAM	1 RB / 0 RB Offset		
		23025 to 23165	23025, 23095, 23165	3 MHz	QPSK, 16QAM	1 RB / 0 RB Offset		
		23035 to 23155	23035, 23095, 23155	5 MHz	QPSK, 16QAM	1 RB / 0 RB Offset		
		23060 to 23130	23060, 23095, 23130	10 MHz	QPSK, 16QAM	1 RB / 0 RB Offset		
-	Band Edge	23017 to 23173	23017	1.4 MHz	QPSK	1 RB / 0 RB Offset 6 RB / 0 RB Offset		
			23173	1.4 MHz	QPSK	1 RB / 5 RB Offset 6 RB / 0 RB Offset		
			23025 to 23165	23025	3 MHz	QPSK	1 RB / 0 RB Offset 15 RB / 0 RB Offset	
				23165	3 MHz	QPSK	1 RB / 14 RB Offset 15 RB / 0 RB Offset	
		23035 to 23155	23035	5 MHz	QPSK	1 RB / 0 RB Offset 25 RB / 0 RB Offset		
			23155	5 MHz	QPSK	1 RB / 24 RB Offset 25 RB / 0 RB Offset		
		23060 to 23130	23060	10 MHz	QPSK	1 RB / 0 RB Offset 50 RB / 0 RB Offset		
			23130	10 MHz	QPSK	1 RB / 49 RB Offset 50 RB / 0 RB Offset		
		-	Conducted Emission	23017 to 23173	23017, 23095, 23173	1.4 MHz	QPSK	1 RB / 0 RB Offset
				23025 to 23165	23025, 23095, 23165	3 MHz	QPSK	1 RB / 0 RB Offset
				23035 to 23155	23035, 23095, 23155	5 MHz	QPSK	1 RB / 0 RB Offset
				23060 to 23130	23060, 23095, 23130	10 MHz	QPSK	1 RB / 0 RB Offset
-	Radiated Emission	23017 to 23173	23017, 23095, 23173	1.4 MHz	QPSK	1 RB / 0 RB Offset		
		23035 to 23155	23035, 23095, 23155	5 MHz	QPSK	1 RB / 0 RB Offset		
		23060 to 23130	23060, 23095, 23130	10 MHz	QPSK	1 RB / 0 RB Offset		

Note: This device was tested under all bandwidths, RB configurations and modulations. The worst case was found in QPSK modulation.

LTE Band 13

EUT Configure Mode	Test Item	Available Channel	Tested Channel	Channel Bandwidth	Modulation	Mode
-	ERP	23205 to 23255	23205, 23230, 23255	5 MHz	QPSK, 16QAM	1 RB / 0 RB Offset
		23230	23230	10 MHz	QPSK, 16QAM	1 RB / 24 RB Offset
-	Modulation characteristics	23205 to 23255	23230	5 MHz	QPSK, 16QAM	5 RB / 0 RB Offset
-	Frequency Stability	23205 to 23255	23205, 23255	5 MHz	QPSK	1 RB / 0 RB Offset
		23230	23230	10 MHz	QPSK	1 RB / 24 RB Offset
-	Occupied Bandwidth	23205 to 23255	23205, 23230, 23255	5 MHz	QPSK, 16QAM	25 RB / 0 RB Offset
		23230	23230	10 MHz	QPSK, 16QAM	50 RB / 0 RB Offset
-	Peak to Average Ratio	23205 to 23255	23205, 23230, 23255	5 MHz	QPSK, 16QAM	1 RB / 0 RB Offset
		23230	23230	10 MHz	QPSK, 16QAM	1 RB / 0 RB Offset
-	Band Edge	23205 to 23255	23205	5 MHz	QPSK	1 RB / 0 RB Offset
			23255	5 MHz	QPSK	25 RB / 0 RB Offset
		23230	23230	10 MHz	QPSK	1 RB / 24 RB Offset
			23230	10 MHz	QPSK	25 RB / 0 RB Offset
			23230	10 MHz	QPSK	1 RB / 0 RB Offset
			23230	10 MHz	QPSK	50 RB / 0 RB Offset
-	Conducted Emission	23205 to 23255	23205, 23230, 23255	5 MHz	QPSK	1 RB / 0 RB Offset
		23230	23230	10 MHz	QPSK	1 RB / 0 RB Offset
-	Radiated Emission	23205 to 23255	23205, 23230, 23255	5 MHz	QPSK	1 RB / 0 RB Offset
		23230	23230	10 MHz	QPSK	1 RB / 0 RB Offset

Note: This device was tested under all bandwidths, RB configurations and modulations. The worst case was found in QPSK modulation.

LTE Band 17

EUT Configure Mode	Test Item	Available Channel	Tested Channel	Channel Bandwidth	Modulation	Mode		
-	ERP	23755 to 23825	23755, 23790, 23825	5 MHz	QPSK, 16QAM	1 RB / 12 RB Offset		
		23780 to 23800	23780, 23790, 23800	10 MHz	QPSK, 16QAM	1 RB / 24 RB Offset		
-	Modulation characteristics	23755 to 23825	23790	5 MHz	QPSK, 16QAM	5 RB / 0 RB Offset		
-	Frequency Stability	23755 to 23825	23755, 23825	5 MHz	QPSK	1 RB / 12 RB Offset		
		23780 to 23800	23780, 23800	10 MHz	QPSK	1 RB / 24 RB Offset		
-	Occupied Bandwidth	23755 to 23825	23755, 23790, 23825	5 MHz	QPSK, 16QAM	25 RB / 0 RB Offset		
		23780 to 23800	23780, 23790, 23800	10 MHz	QPSK, 16QAM	50 RB / 0 RB Offset		
-	Peak to Average Ratio	23755 to 23825	23755, 23790, 23825	5 MHz	QPSK, 16QAM	1 RB / 12 RB Offset		
		23780 to 23800	23780, 23790, 23800	10 MHz	QPSK, 16QAM	1 RB / 24 RB Offset		
-	Band Edge	23755 to 23825	23755	5 MHz	QPSK	1 RB / 0 RB Offset 25 RB / 0 RB Offset		
			23825	5 MHz	QPSK	1 RB / 24 RB Offset 25 RB / 0 RB Offset		
		23780 to 23800	23780	10 MHz	QPSK	1 RB / 0 RB Offset 50 RB / 0 RB Offset		
			23800	10 MHz	QPSK	1 RB / 49 RB Offset 50 RB / 0 RB Offset		
		-	Conducted Emission	23755 to 23825	23755, 23790, 23825	5 MHz	QPSK	1 RB / 12 RB Offset
				23780 to 23800	23780, 23790, 23800	10 MHz	QPSK	1 RB / 24 RB Offset
-	Radiated Emission	23755 to 23825	23755, 23790, 23825	5 MHz	QPSK	1 RB / 12 RB Offset		
		23780 to 23800	23780, 23790, 23800	10 MHz	QPSK	1 RB / 24 RB Offset		

Note: This device was tested under all bandwidths, RB configurations and modulations. The worst case was found in QPSK modulation.

LTE Band 66

EUT Configure Mode	Test Item	Available Channel	Tested Channel	Channel Bandwidth	Modulation	Mode
-	EIRP	131979 to 132665	131979, 132322, 132665	1.4 MHz	QPSK, 16QAM	1 RB / 5 RB Offset
		131987 to 132657	131987, 132322, 132657	3 MHz	QPSK, 16QAM	1 RB / 14 RB Offset
		131997 to 132647	131997, 132322, 132647	5 MHz	QPSK, 16QAM	1 RB / 24 RB Offset
		132022 to 132622	132022, 132322, 132622	10 MHz	QPSK, 16QAM	1 RB / 49 RB Offset
		132047 to 132597	132047, 132322, 132597	15 MHz	QPSK, 16QAM	1 RB / 74 RB Offset
		132072 to 132572	132072, 132322, 132572	20 MHz	QPSK, 16QAM	1 RB / 99 RB Offset
-	Modulation characteristics	131997 to 132647	132322	5 MHz	QPSK, 16QAM	5 RB / 0 RB Offset
-	Frequency Stability	131979 to 132665	131979, 132665	1.4 MHz	QPSK	1 RB / 5 RB Offset
		131987 to 132657	131987, 132657	3 MHz	QPSK	1 RB / 14 RB Offset
		131997 to 132647	131997, 132647	5 MHz	QPSK	1 RB / 24 RB Offset
		132022 to 132622	132022, 132622	10 MHz	QPSK	1 RB / 49 RB Offset
		132047 to 132597	132047, 132597	15 MHz	QPSK	1 RB / 74 RB Offset
		132072 to 132572	132072, 132572	20 MHz	QPSK	1 RB / 99 RB Offset
-	Occupied Bandwidth	131979 to 132665	131979, 132322, 132665	1.4 MHz	QPSK, 16QAM	6 RB / 0 RB Offset
		131987 to 132657	131987, 132322, 132657	3 MHz	QPSK, 16QAM	15 RB / 0 RB Offset
		131997 to 132647	131997, 132322, 132647	5 MHz	QPSK, 16QAM	25 RB / 0 RB Offset
		132022 to 132622	132022, 132322, 132622	10 MHz	QPSK, 16QAM	50 RB / 0 RB Offset
		132047 to 132597	132047, 132322, 132597	15 MHz	QPSK, 16QAM	75 RB / 0 RB Offset
		132072 to 132572	132072, 132322, 132572	20 MHz	QPSK, 16QAM	100 RB / 0 RB Offset
-	Peak to Average Ratio	131979 to 132665	131979, 132322, 132665	1.4 MHz	QPSK, 16QAM	1 RB / 2 RB Offset
		131987 to 132657	131987, 132322, 132657	3 MHz	QPSK, 16QAM	1 RB / 7 RB Offset
		131997 to 132647	131997, 132322, 132647	5 MHz	QPSK, 16QAM	12 RB / 0 RB Offset
		132022 to 132622	132022, 132322, 132622	10 MHz	QPSK, 16QAM	1 RB / 24 RB Offset
		132047 to 132597	132047, 132322, 132597	15 MHz	QPSK, 16QAM	36 RB / 0 RB Offset
		132072 to 132572	132072, 132322, 132572	20 MHz	QPSK, 16QAM	50 RB / 0 RB Offset

EUT Configure Mode	Test Item	Available Channel	Tested Channel	Channel Bandwidth	Modulation	Mode		
-	Band Edge	131979 to 132665	131979	1.4 MHz	QPSK	1 RB / 0 RB Offset 6 RB / 0 RB Offset		
			132665	1.4 MHz	QPSK	1 RB / 5 RB Offset 6 RB / 0 RB Offset		
		131987 to 132657	131987	3 MHz	QPSK	1 RB / 0 RB Offset 15 RB / 0 RB Offset		
			132657	3 MHz	QPSK	1 RB / 14 RB Offset 15 RB / 0 RB Offset		
		131997 to 132647	131997	5 MHz	QPSK	1 RB / 0 RB Offset 25 RB / 0 RB Offset		
			132647	5 MHz	QPSK	1 RB / 24 RB Offset 25 RB / 0 RB Offset		
		132022 to 132622	132022	10 MHz	QPSK	1 RB / 0 RB Offset 50 RB / 0 RB Offset		
			132622	10 MHz	QPSK	1 RB / 49 RB Offset 50 RB / 0 RB Offset		
		132047 to 132597	132047	15 MHz	QPSK	1 RB / 0 RB Offset 75 RB / 0 RB Offset		
			132597	15 MHz	QPSK	1 RB / 74 RB Offset 75 RB / 0 RB Offset		
		132072 to 132572	132072	20 MHz	QPSK	1 RB / 0 RB Offset 100 RB / 0 RB Offset		
			132572	20 MHz	QPSK	1 RB / 99 RB Offset 100 RB / 0 RB Offset		
		-	Conducted Emission	131979 to 132665	131979, 132322, 132665	1.4 MHz	QPSK	1 RB / 2 RB Offset
				131987 to 132657	131987, 132322, 132657	3 MHz	QPSK	1 RB / 7 RB Offset
				131997 to 132647	131997, 132322, 132647	5 MHz	QPSK	12 RB / 0 RB Offset
				132022 to 132622	132022, 132322, 132622	10 MHz	QPSK	50 RB / 0 RB Offset
				132047 to 132597	132047, 132322, 132597	15 MHz	QPSK	36 RB / 0 RB Offset
				132072 to 132572	132072, 132322, 132572	20 MHz	QPSK	50 RB / 0 RB Offset
-	Radiated Emission	131979 to 132665	131979, 132322, 132665	1.4 MHz	QPSK	1 RB / 2 RB Offset		
		131997 to 132647	131997, 132322, 132647	5 MHz	QPSK	12 RB / 0 RB Offset		
		132072 to 132572	132072, 132322, 132572	20 MHz	QPSK	50 RB / 0 RB Offset		

Test Condition:

Test Item	Environmental Conditions	Input Power	Tested By
ERP / EIRP	25 deg. C, 65 % RH	12 Vdc	Thomas Wei
Modulation characteristics	25 deg. C, 65 % RH	12 Vdc	Getaz Yang
Frequency Stability	25 deg. C, 65 % RH	12 Vdc	Getaz Yang
Occupied Bandwidth	25 deg. C, 65 % RH	12 Vdc	Getaz Yang
Band Edge	25 deg. C, 65 % RH	12 Vdc	Getaz Yang
Peak to Average Ratio	25 deg. C, 65 % RH	12 Vdc	Getaz Yang
Conducted Emission	25 deg. C, 65 % RH	12 Vdc	Getaz Yang
Radiated Emission	25 deg. C, 65 % RH	120 Vac, 60 Hz	Thomas Wei

3.4 EUT Operating Conditions

The EUT makes a call to the communication simulator. The communication simulator station system controlled a EUT to export maximum output power under transmission mode and specific channel frequency

3.5 General Description of Applied Standards

The EUT is a RF Product. According to the specifications of the manufacturer, it must comply with the requirements of the following standards:

FCC 47 CFR Part 2

FCC 47 CFR Part 27

KDB 971168 D01 Power Meas License Digital Systems v03r01

ANSI/TIA/EIA-603-E 2016

ANSI 63.26-2015

Note: All test items have been performed and recorded as per the above standards.

4 Test Types and Results

4.1 Output Power Measurement

4.1.1 Limits of Output Power Measurement

Fixed, mobile, and portable (hand-held) stations operating in the 1710–1755 MHz band are limited to 1 watt EIRP.

Portable stations (hand-held devices) operating in the 704-716 MHz band are limited to 3 watts ERP

4.1.2 Test Procedures

EIRP / ERP Measurement:

- a. All measurements were done at low, middle and high operational frequency range. RBW and VBW is 5 MHz for WCDMA and 10 MHz for LTE mode.
- b. Substitution method is used for E.I.R.P measurement. In the semi-anechoic chamber, EUT placed on the 0.8 m (below or equal 1 GHz) and/or 1.5 m (above 1 GHz) height of Turn Table, rotated the table around 360 degrees to search the maximum radiation power and receiver antenna shall be rotated vertical and horizontal polarization and moved height from 1 m to 4 m to find the maximum polar radiated power. The “Read Value” is the spectrum reading the maximum power value.
- c. The substitution horn antenna is substituted for EUT at the same position and signals generator export the CW signal to the substitution antenna via a tx cable. Rotated the Turn Table and moved receiving antenna to find the maximum radiation power. Adjust output power level of S.G to get a Value of spectrum reading equal to “Read Value” of step b. Record the power level of S.G.
- d. $EIRP = \text{Output power level of S.G} - \text{TX cable loss} + \text{Antenna gain of substitution horn}$. E.R.P power can be calculated form E.I.R.P power by subtracting the gain of dipole, $E.R.P \text{ power} = E.I.R.P \text{ power} - 2.15 \text{ dB}$.

Conducted Power Measurement:

- a. The EUT was set up for the maximum power with LTE link data modulation and link up with simulator.
- b. Set the EUT to transmit under low, middle and high channel and record the power level shown on simulator.

4.1.3 Test Setup

EIRP / ERP Measurement:

<Radiated Emission below or equal 1 GHz>

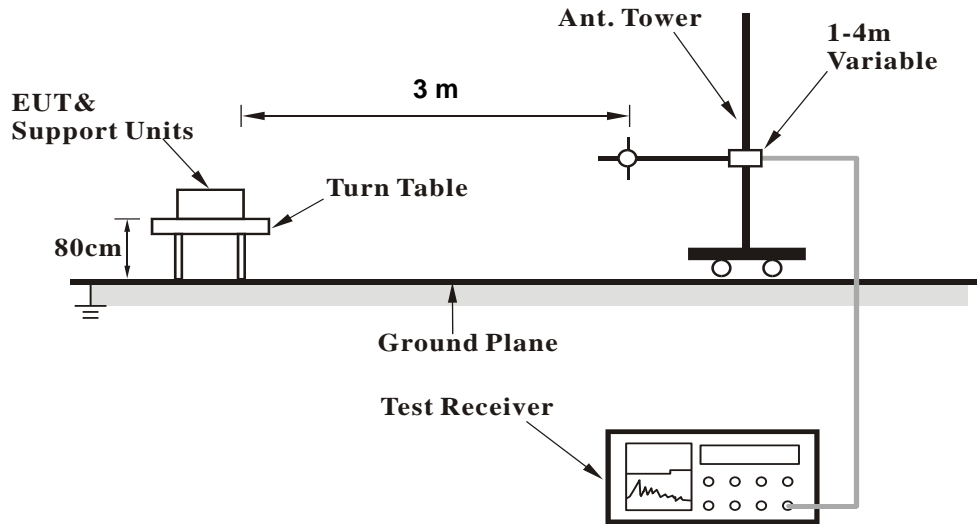

<Radiated Emission above 1 GHz>

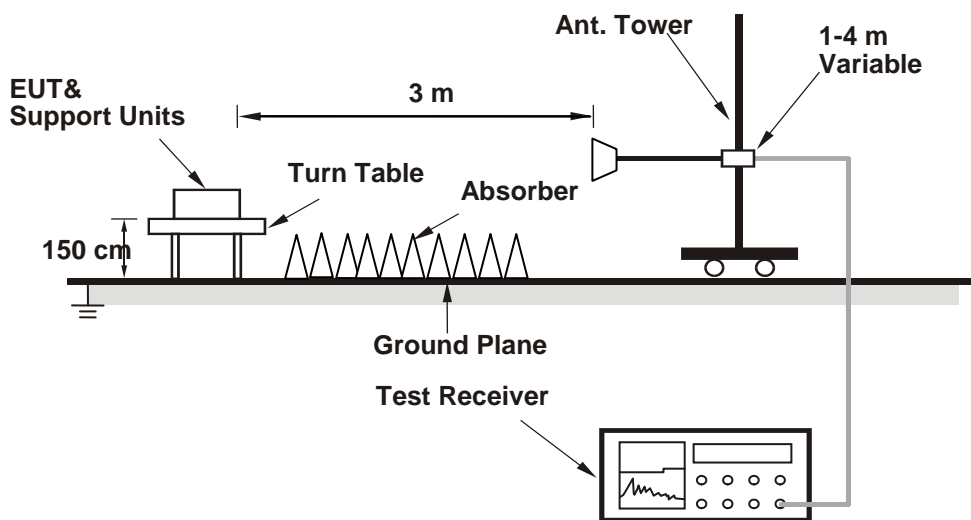

For the actual test configuration, please refer to the attached file (Test Setup Photo).

Conducted Power Measurement:

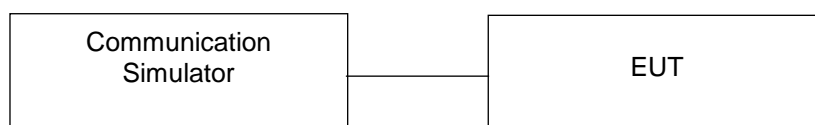

4.1.4 Test Results

Conducted Output Power (dBm)

LTE Band 4

BW(MHz):		1.4								
Test Frequency ID	N _{UL}	Frequency of Uplink [MHz]	N _{DL}	Frequency of Downlink [MHz]	Test Configuration Initial of Power				EUT	
					Modulation	RB Size	RB Offset	Narrowband Index	Cell power (dBm/15kHz)	power (dBm)
Low Range	19957	1710.7	1957	2110.7	QPSK	1	0	0	-85	24.08
					QPSK	1	5	0	-85	23.69
					QPSK	3	3	0	-85	21.96
					QPSK	6	0	0	-85	21.12
					16QAM	1	0	0	-85	21.57
					16QAM	1	5	0	-85	21.64
					16QAM	3	0	0	-85	20.77
Mid Range	20175	1732.5	2175	2132.5	QPSK	1	0	0	-85	24.04
					QPSK	1	5	0	-85	23.62
					QPSK	3	3	0	-85	21.99
					QPSK	6	0	0	-85	21.14
					16QAM	1	0	0	-85	21.56
					16QAM	1	5	0	-85	21.64
					16QAM	3	0	0	-85	20.81
High Range	20393	1754.3	2393	2154.3	QPSK	1	0	0	-85	23.85
					QPSK	1	5	0	-85	23.47
					QPSK	3	3	0	-85	21.88
					QPSK	6	0	0	-85	20.97
					16QAM	1	0	0	-85	21.37
					16QAM	1	5	0	-85	21.51
					16QAM	3	0	0	-85	20.68
					16QAM	5	0	0	-85	20.37

BW(MHz):		3								
Test Frequency ID	N _{UL}	Frequency of Uplink [MHz]	N _{DL}	Frequency of Downlink [MHz]	Test Configuration Initial of Power			EUT		
					Modulation	RB Size	RB Offset	Narrowband Index	Cell power (dBm/15kHz)	power (dBm)
Low Range	19965	1711.5	1965	2111.5	QPSK	1	0	0	-85	22.92
					QPSK	1	5	0	-85	22.91
					QPSK	1	0	1	-85	22.84
					QPSK	1	5	1	-85	22.92
					QPSK	3	3	0	-85	21.93
					QPSK	3	3	1	-85	21.81
					QPSK	6	0	0	-85	21.01
					QPSK	6	0	1	-85	20.94
					16QAM	1	0	0	-85	21.11
					16QAM	1	5	0	-85	21.12
					16QAM	1	0	1	-85	22.87
					16QAM	1	5	1	-85	22.86
					16QAM	3	0	0	-85	20.58
					16QAM	3	3	1	-85	20.55
Mid Range	20175	1732.5	2175	2132.5	QPSK	1	0	0	-85	22.81
					QPSK	1	5	0	-85	22.78
					QPSK	1	0	1	-85	22.82
					QPSK	1	5	1	-85	22.84
					QPSK	3	3	0	-85	21.84
					QPSK	3	3	1	-85	21.82
					QPSK	6	0	0	-85	20.94
					QPSK	6	0	1	-85	20.96
					16QAM	1	0	0	-85	20.99
					16QAM	1	5	0	-85	20.98
					16QAM	1	0	1	-85	21.02
					16QAM	1	5	1	-85	20.84
					16QAM	3	0	0	-85	20.47
					16QAM	3	3	1	-85	20.44
High Range	20385	1753.5	2385	2153.5	QPSK	1	0	0	-85	22.59
					QPSK	1	5	0	-85	22.58
					QPSK	1	0	1	-85	22.68
					QPSK	1	5	1	-85	22.71
					QPSK	3	3	0	-85	21.61
					QPSK	3	3	1	-85	21.77
					QPSK	6	0	0	-85	20.76
					QPSK	6	0	1	-85	20.89
					16QAM	1	0	0	-85	20.85
					16QAM	1	5	0	-85	20.87
					16QAM	1	0	1	-85	20.95
					16QAM	1	5	1	-85	20.99
					16QAM	3	0	0	-85	20.43
					16QAM	3	3	1	-85	20.75
16QAM	5	0	0	-85	20.3					
16QAM	5	0	1	-85	20.31					

BW(MHz):		5								
Test Frequency ID	NUL	Frequency of Uplink [MHz]	N _{DL}	Frequency of Downlink [MHz]	Test Configuration Initial of Power			EUT		
					Modulation	RB Size	RB Offset	Narrowband Index	Cell power (dBm/15kHz)	power (dBm)
Low Range	19975	1712.5	1975	2112.5	QPSK	1	0	0	-85	22.77
					QPSK	1	5	0	-85	22.75
					QPSK	1	0	1	-85	22.67
					QPSK	1	5	1	-85	22.69
					QPSK	1	0	3	-85	22.76
					QPSK	1	5	3	-85	22.81
					QPSK	3	0	0	-85	21.74
					QPSK	3	3	3	-85	21.97
					QPSK	6	0	0	-85	21.92
					QPSK	6	0	1	-85	21.79
					QPSK	6	0	3	-85	21.96
					16QAM	1	0	0	-85	23.12
					16QAM	1	5	0	-85	23.18
					16QAM	1	0	1	-85	22.35
					16QAM	1	5	1	-85	22.84
					16QAM	1	0	3	-85	22.89
					16QAM	1	5	3	-85	22.23
					16QAM	3	0	0	-85	21.72
					16QAM	3	3	3	-85	21.84
					16QAM	5	0	0	-85	20.86
16QAM	5	0	1	-85	20.48					
16QAM	5	0	3	-85	20.58					
Mid Range	20175	1732.5	2175	2132.5	QPSK	1	0	0	-85	22.79
					QPSK	1	5	0	-85	22.84
					QPSK	1	0	1	-85	22.86
					QPSK	1	5	1	-85	22.81
					QPSK	1	0	3	-85	22.98
					QPSK	1	5	3	-85	22.94
					QPSK	3	0	0	-85	21.79
					QPSK	3	3	3	-85	21.91
					QPSK	6	0	0	-85	21.68
					QPSK	6	0	1	-85	21.76
					QPSK	6	0	3	-85	21.87
					16QAM	1	0	0	-85	23.01
					16QAM	1	5	0	-85	22.99
					16QAM	1	0	1	-85	22.98
					16QAM	1	5	1	-85	22.17
					16QAM	1	0	3	-85	22.96
					16QAM	1	5	3	-85	22.23
					16QAM	3	0	0	-85	21.76
					16QAM	3	3	3	-85	21.86
					16QAM	5	0	0	-85	20.47
16QAM	5	0	1	-85	20.42					
16QAM	5	0	3	-85	20.44					

Test Frequency ID	N _{UL}	Frequency of Uplink [MHz]	N _{DL}	Frequency of Downlink [MHz]	Test Configuration Initial of Power				EUT	
					Modulation	RB Size	RB Offset	Narrowband Index	Cell power (dBm/15kHz)	power (dBm)
High Range	20375	1752.5	2375	2152.5	QPSK	1	0	0	-85	22.67
					QPSK	1	5	0	-85	22.97
					QPSK	1	0	1	-85	22.89
					QPSK	1	5	1	-85	22.71
					QPSK	1	0	3	-85	22.91
					QPSK	1	5	3	-85	22.67
					QPSK	3	0	0	-85	21.77
					QPSK	3	3	3	-85	21.94
					QPSK	6	0	0	-85	21.81
					QPSK	6	0	1	-85	21.78
					QPSK	6	0	3	-85	22.01
					16QAM	1	0	0	-85	22.17
					16QAM	1	5	0	-85	22.83
					16QAM	1	0	1	-85	22.14
					16QAM	1	5	1	-85	22.13
					16QAM	1	0	3	-85	22.13
					16QAM	1	5	3	-85	22.23
					16QAM	3	0	0	-85	21.56
16QAM	3	3	3	-85	21.96					
16QAM	5	0	0	-85	20.42					
16QAM	5	0	1	-85	20.44					
16QAM	5	0	3	-85	20.44					

BW(MHz): 10

Test Frequency ID	N _{UL}	Frequency of Uplink [MHz]	N _{DL}	Frequency of Downlink [MHz]	Test Configuration Initial of Power				EUT	
					Modulation	RB Size	RB Offset	Narrowband Index	Cell power (dBm/15kHz)	power (dBm)
Low Range	20000	1715	2000	2115	QPSK	1	0	0	-85	22.76
					QPSK	1	5	0	-85	22.96
					QPSK	1	0	3	-85	22.99
					QPSK	1	5	3	-85	22.87
					QPSK	1	0	7	-85	22.81
					QPSK	1	5	7	-85	22.85
					QPSK	4	0	0	-85	22.86
					QPSK	4	2	7	-85	22.83
					QPSK	6	0	0	-85	21.81
					QPSK	6	0	7	-85	21.92
					16QAM	1	0	0	-85	23.05
					16QAM	1	5	0	-85	22.99
					16QAM	1	0	3	-85	23.01
					16QAM	1	5	3	-85	23.01
					16QAM	1	0	7	-85	22.98
					16QAM	1	5	7	-85	22.93
					16QAM	4	2	0	-85	22.16
					16QAM	4	2	7	-85	22.23
16QAM	5	0	0	-85	21.59					
16QAM	5	0	7	-85	21.68					

Test Frequency ID	N _{UL}	Frequency of Uplink [MHz]	N _{DL}	Frequency of Downlink [MHz]	Test Configuration Initial of Power				EUT	
					Modulation	RB Size	RB Offset	Narrowband Index	Cell power (dBm/15kHz)	power (dBm)
Mid Range	20175	1732.5	2175	2132.5	QPSK	1	0	0	-85	22.91
					QPSK	1	5	0	-85	22.96
					QPSK	1	0	3	-85	22.89
					QPSK	1	5	3	-85	22.83
					QPSK	1	0	7	-85	22.86
					QPSK	1	5	7	-85	22.78
					QPSK	4	0	0	-85	22.87
					QPSK	4	2	7	-85	22.88
					QPSK	6	0	0	-85	21.94
					QPSK	6	0	7	-85	21.92
					16QAM	1	0	0	-85	22.97
					16QAM	1	5	0	-85	22.43
					16QAM	1	0	3	-85	23.06
					16QAM	1	5	3	-85	23.02
					16QAM	1	0	7	-85	22.04
					16QAM	1	5	7	-85	22.97
					16QAM	4	2	0	-85	22.17
					16QAM	4	2	7	-85	22.1
16QAM	5	0	0	-85	21.56					
16QAM	5	0	7	-85	21.72					
High Range	20350	1750	2350	2150	QPSK	1	0	0	-85	22.71
					QPSK	1	5	0	-85	22.76
					QPSK	1	5	7	-85	22.77
					QPSK	1	0	3	-85	22.72
					QPSK	1	5	3	-85	22.76
					QPSK	1	0	7	-85	22.73
					QPSK	4	0	0	-85	22.68
					QPSK	4	2	7	-85	22.78
					QPSK	6	0	0	-85	21.87
					QPSK	6	0	7	-85	21.87
					16QAM	1	0	0	-85	22.91
					16QAM	1	5	0	-85	22.96
					16QAM	1	0	3	-85	22.13
					16QAM	1	5	3	-85	21.97
					16QAM	1	0	7	-85	21.97
					16QAM	1	5	7	-85	21.96
					16QAM	4	2	0	-85	22.08
					16QAM	4	2	7	-85	22.98
16QAM	5	0	0	-85	21.65					
16QAM	5	0	7	-85	21.54					

BW(MHz):		15								
Test Frequency ID	N _{UL}	Frequency of Uplink [MHz]	N _{DL}	Frequency of Downlink [MHz]	Test Configuration Initial of Power			EUT		
					Modulation	RB Size	RB Offset	Narrowband Index	Cell power (dBm/15kHz)	power (dBm)
Low Range	20025	1717.5	2025	2117.5	QPSK	1	0	0	-85	22.96
					QPSK	1	5	0	-85	22.91
					QPSK	1	0	5	-85	22.93
					QPSK	1	5	5	-85	22.92
					QPSK	1	0	11	-85	22.92
					QPSK	1	5	11	-85	22.93
					QPSK	3	0	0	-85	23.01
					QPSK	3	3	11	-85	22.94
					QPSK	6	0	0	-85	23.05
					QPSK	6	0	11	-85	22.95
					16QAM	1	0	0	-85	23.01
					16QAM	1	5	0	-85	23.02
					16QAM	1	0	5	-85	23.04
					16QAM	1	5	5	-85	23
					16QAM	1	0	11	-85	22.99
					16QAM	1	5	11	-85	23
					16QAM	3	0	0	-85	22.69
					16QAM	3	3	11	-85	22.9
16QAM	5	0	0	-85	22.56					
16QAM	5	0	11	-85	22.84					
Mid Range	20175	1732.5	2175	2132.5	QPSK	1	0	0	-85	22.82
					QPSK	1	5	0	-85	22.93
					QPSK	1	0	5	-85	22.87
					QPSK	1	5	5	-85	22.91
					QPSK	1	0	11	-85	22.93
					QPSK	1	5	11	-85	22.87
					QPSK	3	0	0	-85	22.98
					QPSK	3	3	11	-85	22.94
					QPSK	6	0	0	-85	22.91
					QPSK	6	0	11	-85	22.98
					16QAM	1	0	0	-85	22.87
					16QAM	1	5	0	-85	23.02
					16QAM	1	0	5	-85	23.01
					16QAM	1	5	5	-85	22.99
					16QAM	1	0	11	-85	23.01
					16QAM	1	5	11	-85	23.02
					16QAM	3	0	0	-85	22.97
					16QAM	3	3	11	-85	22.91
16QAM	5	0	0	-85	22.76					
16QAM	5	0	11	-85	22.82					

Test Frequency ID	N _{UL}	Frequency of Uplink [MHz]	N _{DL}	Frequency of Downlink [MHz]	Test Configuration Initial of Power				EUT	
					Modulation	RB Size	RB Offset	Narrowband Index	Cell power (dBm/15kHz)	power (dBm)
High Range	20325	1747.5	2325	2147.5	QPSK	1	0	0	-85	22.76
					QPSK	1	5	11	-85	22.72
					QPSK	1	0	5	-85	22.71
					QPSK	1	5	5	-85	22.77
					QPSK	1	0	11	-85	22.76
					QPSK	3	0	0	-85	22.91
					QPSK	3	3	11	-85	22.75
					QPSK	6	0	0	-85	22.84
					QPSK	6	0	11	-85	22.85
					16QAM	1	0	0	-85	23.03
					16QAM	1	5	0	-85	23.01
					16QAM	1	0	5	-85	22.45
					16QAM	1	5	5	-85	22.47
					16QAM	1	0	11	-85	22.33
					16QAM	1	5	11	-85	21.84
					16QAM	3	0	0	-85	22.89
					16QAM	3	3	11	-85	22.65
16QAM	5	0	0	-85	22.52					
16QAM	5	0	11	-85	22.65					

BW(MHz): 20

Test Frequency ID	N _{UL}	Frequency of Uplink [MHz]	N _{DL}	Frequency of Downlink [MHz]	Test Configuration Initial of Power				EUT	
					Modulation	RB Size	RB Offset	Narrowband Index	Cell power (dBm/15kHz)	power (dBm)
Low Range	20050	1720	2050	2120	QPSK	1	0	0	-85	23.01
					QPSK	1	5	0	-85	22.84
					QPSK	1	0	7	-85	22.91
					QPSK	1	5	7	-85	22.96
					QPSK	1	0	15	-85	22.85
					QPSK	1	5	15	-85	22.88
					QPSK	3	0	0	-85	23.01
					QPSK	3	3	15	-85	22.86
					QPSK	6	0	0	-85	22.97
					QPSK	6	0	15	-85	22.89
					16QAM	1	0	0	-85	22.99
					16QAM	1	5	0	-85	22.87
					16QAM	1	0	7	-85	22.93
					16QAM	1	5	7	-85	22.9
					16QAM	1	0	15	-85	23.03
					16QAM	1	5	15	-85	23.02
					16QAM	3	0	0	-85	22.91
16QAM	3	3	15	-85	22.93					
16QAM	5	0	0	-85	22.78					
16QAM	5	0	15	-85	22.88					

Test Frequency ID	N _{UL}	Frequency of Uplink [MHz]	N _{DL}	Frequency of Downlink [MHz]	Test Configuration Initial of Power				EUT	
					Modulation	RB Size	RB Offset	Narrowband Index	Cell power (dBm/15kHz)	power (dBm)
Mid Range	20175	1732.5	2175	2132.5	QPSK	1	0	0	-85	22.97
					QPSK	1	5	0	-85	22.88
					QPSK	1	0	7	-85	22.86
					QPSK	1	5	7	-85	22.74
					QPSK	1	0	15	-85	22.71
					QPSK	1	5	15	-85	22.74
					QPSK	3	0	0	-85	22.99
					QPSK	3	3	15	-85	22.76
					QPSK	6	0	0	-85	22.91
					QPSK	6	0	15	-85	22.93
					16QAM	1	0	0	-85	22.89
					16QAM	1	5	0	-85	22.96
					16QAM	1	0	7	-85	22.93
					16QAM	1	5	7	-85	22.97
					16QAM	1	0	15	-85	23.01
					16QAM	1	5	15	-85	22.93
					16QAM	3	0	0	-85	22.87
					16QAM	3	3	15	-85	22.94
16QAM	5	0	0	-85	22.68					
16QAM	5	0	15	-85	22.75					
High Range	20300	1745	2300	2145	QPSK	1	0	0	-85	22.85
					QPSK	1	5	0	-85	22.87
					QPSK	1	0	7	-85	22.77
					QPSK	1	5	7	-85	22.87
					QPSK	1	0	15	-85	22.81
					QPSK	1	5	15	-85	22.77
					QPSK	3	0	0	-85	22.95
					QPSK	3	3	15	-85	22.69
					QPSK	6	0	0	-85	22.87
					QPSK	6	0	15	-85	22.78
					16QAM	1	0	0	-85	23.02
					16QAM	1	5	0	-85	23.05
					16QAM	1	0	7	-85	22.98
					16QAM	1	5	7	-85	22.97
					16QAM	1	0	15	-85	22.57
					16QAM	1	5	15	-85	22.21
					16QAM	3	0	0	-85	22.77
					16QAM	3	3	15	-85	22.72
16QAM	5	0	0	-85	22.68					
16QAM	5	0	15	-85	22.69					

LTE Band 12

BW(MHz):		1.4								
Test Frequency ID	N _{UL}	Frequency of Uplink [MHz]	N _{DL}	Frequency of Downlink [MHz]	Test Configuration Initial of Power				EUT	
					Modulation	RB Size	RB Offset	Narrowband Index	Cell power (dBm/15kHz)	power (dBm)
Low Range	23017	699.7	5017	729.7	QPSK	1	0	0	-85	24.21
					QPSK	1	5	0	-85	23.77
					QPSK	3	3	0	-85	22.17
					QPSK	6	0	0	-85	21.26
					16QAM	1	0	0	-85	23.57
					16QAM	1	5	0	-85	22.82
					16QAM	3	0	0	-85	22.11
Mid Range	23095	707.5	5095	737.5	QPSK	1	0	0	-85	23.91
					QPSK	1	5	0	-85	23.77
					QPSK	3	3	0	-85	22.16
					QPSK	6	0	0	-85	21.25
					16QAM	1	0	0	-85	23.57
					16QAM	1	5	0	-85	23.81
					16QAM	3	0	0	-85	22.06
High Range	23173	715.3	5173	745.3	QPSK	1	0	0	-85	24.13
					QPSK	1	5	0	-85	23.67
					QPSK	3	3	0	-85	22.06
					QPSK	6	0	0	-85	21.13
					16QAM	1	0	0	-85	23.49
					16QAM	1	5	0	-85	23.72
					16QAM	3	0	0	-85	21.99
					16QAM	5	0	0	-85	21.87

BW(MHz):		3								
Test Frequency ID	N _{UL}	Frequency of Uplink [MHz]	N _{DL}	Frequency of Downlink [MHz]	Test Configuration Initial of Power				EUT	
					Modulation	RB Size	RB Offset	Narrowband Index	Cell power (dBm/15kHz)	power (dBm)
Low Range	23025	700.5	5025	730.5	QPSK	1	0	0	-85	23.65
					QPSK	1	5	0	-85	23.82
					QPSK	1	0	1	-85	23.77
					QPSK	1	5	1	-85	23.81
					QPSK	3	3	0	-85	23.51
					QPSK	3	3	1	-85	23.61
					QPSK	6	0	0	-85	23.52
					QPSK	6	0	1	-85	22.99
					16QAM	1	0	0	-85	22.64
					16QAM	1	5	0	-85	22.76
					16QAM	1	0	1	-85	22.88
					16QAM	1	5	1	-85	22.67
					16QAM	3	0	0	-85	21.84
					16QAM	3	3	1	-85	21.81
16QAM	5	0	0	-85	21.43					
					16QAM	5	0	1	-85	21.44

Test Frequency ID	N _{UL}	Frequency of Uplink [MHz]	N _{DL}	Frequency of Downlink [MHz]	Test Configuration Initial of Power				EUT	
					Modulation	RB Size	RB Offset	Narrowband Index	Cell power (dBm/15kHz)	power (dBm)
Mid Range	23095	707.5	5095	737.5	QPSK	1	0	0	-85	23.67
					QPSK	1	5	0	-85	23.66
					QPSK	1	0	1	-85	23.81
					QPSK	1	5	1	-85	23.79
					QPSK	3	3	0	-85	23.49
					QPSK	3	3	1	-85	23.52
					QPSK	6	0	0	-85	23.24
					QPSK	6	0	1	-85	22.96
					16QAM	1	0	0	-85	22.56
					16QAM	1	5	0	-85	22.66
					16QAM	1	0	1	-85	22.57
					16QAM	1	5	1	-85	22.78
					16QAM	3	0	0	-85	21.79
					16QAM	3	3	1	-85	21.8
					16QAM	5	0	0	-85	21.53
16QAM	5	0	1	-85	21.44					
High Range	23165	714.5	5165	744.5	QPSK	1	0	0	-85	23.79
					QPSK	1	5	0	-85	23.83
					QPSK	1	0	1	-85	23.85
					QPSK	1	5	1	-85	23.72
					QPSK	3	3	0	-85	23.56
					QPSK	3	3	1	-85	23.61
					QPSK	6	0	0	-85	23.26
					QPSK	6	0	1	-85	23.31
					16QAM	1	0	0	-85	22.88
					16QAM	1	5	0	-85	22.78
					16QAM	1	0	1	-85	22.68
					16QAM	1	5	1	-85	22.74
					16QAM	3	0	0	-85	21.81
					16QAM	3	3	1	-85	21.67
					16QAM	6	0	0	-85	21.54
16QAM	6	0	1	-85	21.63					

BW(MHz):		5								
Test Frequency ID	N _{UL}	Frequency of Uplink [MHz]	N _{DL}	Frequency of Downlink [MHz]	Test Configuration Initial of Power			EUT		
					Modulation	RB Size	RB Offset	Narrowband Index	Cell power (dBm/15kHz)	power (dBm)
Low Range	23035	701.5	5035	731.5	QPSK	1	0	0	-85	23.01
					QPSK	1	5	0	-85	22.95
					QPSK	1	0	1	-85	22.95
					QPSK	1	5	1	-85	22.89
					QPSK	1	0	3	-85	22.86
					QPSK	1	5	3	-85	22.91
					QPSK	3	0	0	-85	21.01
					QPSK	3	3	3	-85	21.93
					QPSK	6	0	0	-85	21.99
					QPSK	6	0	1	-85	21.02
					QPSK	6	0	3	-85	21.98
					16QAM	1	0	0	-85	23.17
					16QAM	1	5	0	-85	23.02
					16QAM	1	0	1	-85	22.91
					16QAM	1	5	1	-85	22.94
					16QAM	1	0	3	-85	22.98
					16QAM	1	5	3	-85	22.94
					16QAM	3	0	0	-85	22.04
					16QAM	3	3	3	-85	22.02
					16QAM	5	0	0	-85	22.02
16QAM	5	0	1	-85	22.03					
16QAM	5	0	3	-85	22.01					
Mid Range	23095	707.5	5095	737.5	QPSK	1	0	0	-85	22.89
					QPSK	1	5	0	-85	22.77
					QPSK	1	0	1	-85	22.98
					QPSK	1	5	1	-85	22.94
					QPSK	1	0	3	-85	22.97
					QPSK	1	5	3	-85	22.9
					QPSK	3	0	0	-85	21.95
					QPSK	3	3	3	-85	21.89
					QPSK	6	0	0	-85	21.92
					QPSK	6	0	1	-85	21.89
					QPSK	6	0	3	-85	21.76
					16QAM	1	0	0	-85	22.97
					16QAM	1	5	0	-85	22.91
					16QAM	1	0	1	-85	22.94
					16QAM	1	5	1	-85	22.88
					16QAM	1	0	3	-85	22.88
					16QAM	1	5	3	-85	22.79
					16QAM	3	0	0	-85	21.96
					16QAM	3	3	3	-85	21.87
					16QAM	5	0	0	-85	21.98
16QAM	5	0	1	-85	21.76					
16QAM	5	0	3	-85	21.79					

Test Frequency ID	N _{UL}	Frequency of Uplink [MHz]	N _{DL}	Frequency of Downlink [MHz]	Test Configuration Initial of Power				EUT	
					Modulation	RB Size	RB Offset	Narrowband Index	Cell power (dBm/15kHz)	power (dBm)
High Range	23155	713.5	5155	743.5	QPSK	1	0	0	-85	22.98
					QPSK	1	5	0	-85	22.98
					QPSK	1	0	1	-85	22.96
					QPSK	1	5	1	-85	22.93
					QPSK	1	0	3	-85	22.94
					QPSK	1	5	3	-85	22.89
					QPSK	3	0	0	-85	21.94
					QPSK	3	3	3	-85	21.99
					QPSK	6	0	0	-85	21.87
					QPSK	6	0	1	-85	21.85
					QPSK	6	0	3	-85	21.84
					16QAM	1	0	0	-85	23.01
					16QAM	1	5	0	-85	22.99
					16QAM	1	0	1	-85	22.96
					16QAM	1	5	1	-85	22.97
					16QAM	1	0	3	-85	22.87
					16QAM	1	5	3	-85	22.89
					16QAM	3	0	0	-85	21.94
16QAM	3	3	3	-85	21.85					
16QAM	6	0	0	-85	21.67					
16QAM	6	0	1	-85	21.74					
16QAM	6	0	3	-85	21.59					

BW(MHz): 10

Test Frequency ID	N _{UL}	Frequency of Uplink [MHz]	N _{DL}	Frequency of Downlink [MHz]	Test Configuration Initial of Power				EUT	
					Modulation	RB Size	RB Offset	Narrowband Index	Cell power (dBm/15kHz)	power (dBm)
Low Range	23060	704	5060	734	QPSK	1	0	0	-85	23.02
					QPSK	1	5	0	-85	23.01
					QPSK	1	0	3	-85	23.04
					QPSK	1	5	3	-85	23.03
					QPSK	1	0	7	-85	23.02
					QPSK	1	5	7	-85	23.01
					QPSK	4	0	0	-85	22.91
					QPSK	4	2	7	-85	23.05
					QPSK	6	0	0	-85	21.89
					QPSK	6	0	7	-85	21.76
					16QAM	1	0	0	-85	23.01
					16QAM	1	5	0	-85	22.99
					16QAM	1	0	3	-85	22.91
					16QAM	1	5	3	-85	22.96
					16QAM	1	0	7	-85	23.04
					16QAM	1	5	7	-85	22.98
					16QAM	4	2	0	-85	23.02
					16QAM	4	2	7	-85	23.01
16QAM	6	0	0	-85	21.97					
16QAM	6	0	7	-85	21.88					

Test Frequency ID	N _{UL}	Frequency of Uplink [MHz]	N _{DL}	Frequency of Downlink [MHz]	Test Configuration Initial of Power				EUT	
					Modulation	RB Size	RB Offset	Narrowband Index	Cell power (dBm/15kHz)	power (dBm)
Mid Range	23095	707.5	5095	737.5	QPSK	1	0	0	-85	23.07
					QPSK	1	5	0	-85	23.04
					QPSK	1	0	3	-85	23.02
					QPSK	1	5	3	-85	23.01
					QPSK	1	0	7	-85	23.05
					QPSK	1	5	7	-85	22.99
					QPSK	4	0	0	-85	22.98
					QPSK	4	2	7	-85	23.01
					QPSK	6	0	0	-85	21.88
					QPSK	6	0	7	-85	21.78
					16QAM	1	0	0	-85	22.99
					16QAM	1	5	0	-85	22.94
					16QAM	1	0	3	-85	22.91
					16QAM	1	5	3	-85	23.01
					16QAM	1	0	7	-85	22.95
					16QAM	1	5	7	-85	23.02
					16QAM	4	2	0	-85	22.96
					16QAM	4	2	7	-85	21.67
16QAM	6	0	0	-85	21.87					
16QAM	6	0	7	-85	21.89					
High Range	23130	711	5130	741	QPSK	1	0	0	-85	23.12
					QPSK	1	5	0	-85	23.11
					QPSK	1	5	7	-85	23.05
					QPSK	1	0	3	-85	23.07
					QPSK	1	5	3	-85	23.09
					QPSK	1	0	7	-85	22.98
					QPSK	4	0	0	-85	22.95
					QPSK	4	2	7	-85	22.97
					QPSK	6	0	0	-85	21.87
					QPSK	6	0	7	-85	21.99
					16QAM	1	0	0	-85	23.04
					16QAM	1	5	0	-85	23.12
					16QAM	1	0	3	-85	23.09
					16QAM	1	5	3	-85	22.98
					16QAM	1	0	7	-85	22.95
					16QAM	1	5	7	-85	22.94
					16QAM	4	2	0	-85	22.94
					16QAM	4	2	7	-85	22.99
16QAM	6	0	0	-85	21.87					
16QAM	6	0	7	-85	21.78					

LTE Band 13

BW(MHz):										
5										
Test Frequency ID	N _{UL}	Frequency of Uplink [MHz]	N _{DL}	Frequency of Downlink [MHz]	Test Configuration Initial of Power				EUT	
					Modulation	RB Size	RB Offset	Narrowband Index	Cell power (dBm/15kHz)	power (dBm)
Low Range	23205	779.5	5205	748.5	QPSK	1	0	0	-85	23.21
					QPSK	1	5	0	-85	23.24
					QPSK	1	0	1	-85	23.42
					QPSK	1	5	1	-85	23.38
					QPSK	1	0	3	-85	22.41
					QPSK	1	5	3	-85	23.38
					QPSK	3	0	0	-85	22.52
					QPSK	3	3	3	-85	22.54
					QPSK	6	0	0	-85	22.57
					QPSK	6	0	1	-85	22.59
					QPSK	6	0	3	-85	22.78
					16QAM	1	0	0	-85	22.59
					16QAM	1	5	0	-85	22.56
					16QAM	1	0	1	-85	22.58
					16QAM	1	5	1	-85	22.58
					16QAM	1	0	3	-85	22.77
					16QAM	1	5	3	-85	22.73
					16QAM	3	0	0	-85	22.34
					16QAM	3	3	3	-85	22.46
					16QAM	5	0	0	-85	20.94
16QAM	5	0	1	-85	21.17					
16QAM	5	0	3	-85	21.18					
Mid Range	23230	782	5230	751	QPSK	1	0	0	-85	23.32
					QPSK	1	5	0	-85	23.36
					QPSK	1	0	1	-85	23.39
					QPSK	1	5	1	-85	23.33
					QPSK	1	0	3	-85	23.49
					QPSK	1	5	3	-85	23.67
					QPSK	3	0	0	-85	22.64
					QPSK	3	3	3	-85	22.63
					QPSK	6	0	0	-85	22.62
					QPSK	6	0	1	-85	22.67
					QPSK	6	0	3	-85	22.88
					16QAM	1	0	0	-85	22.75
					16QAM	1	5	0	-85	22.61
					16QAM	1	0	1	-85	22.71
					16QAM	1	5	1	-85	22.69
					16QAM	1	0	3	-85	22.83
					16QAM	1	5	3	-85	22.83
					16QAM	3	0	0	-85	22.22
					16QAM	3	3	3	-85	22.45
					16QAM	5	0	0	-85	20.97
16QAM	5	0	1	-85	21.05					
16QAM	5	0	3	-85	21.27					

Test Frequency ID	N _{UL}	Frequency of Uplink [MHz]	N _{DL}	Frequency of Downlink [MHz]	Test Configuration Initial of Power				EUT	
					Modulation	RB Size	RB Offset	Narrowband Index	Cell power (dBm/15kHz)	power (dBm)
High Range	23255	784.5	5255	753.5	QPSK	1	0	0	-85	23.41
					QPSK	1	5	0	-85	23.42
					QPSK	1	0	1	-85	23.47
					QPSK	1	5	1	-85	23.49
					QPSK	1	0	3	-85	23.66
					QPSK	1	5	3	-85	23.54
					QPSK	3	0	0	-85	22.79
					QPSK	3	3	3	-85	22.6
					QPSK	6	0	0	-85	22.78
					QPSK	6	0	1	-85	22.77
					QPSK	6	0	3	-85	22.93
					16QAM	1	0	0	-85	22.77
					16QAM	1	5	0	-85	22.77
					16QAM	1	0	1	-85	22.83
					16QAM	1	5	1	-85	22.76
					16QAM	1	0	3	-85	22.94
					16QAM	1	5	3	-85	22.88
					16QAM	3	0	0	-85	22.43
16QAM	3	3	3	-85	22.59					
16QAM	5	0	0	-85	21.15					
16QAM	5	0	1	-85	21.22					
16QAM	5	0	3	-85	21.48					

BW(MHz): 10

Test Frequency ID	N _{UL}	Frequency of Uplink [MHz]	N _{DL}	Frequency of Downlink [MHz]	Test Configuration Initial of Power				EUT	
					Modulation	RB Size	RB Offset	Narrowband Index	Cell power (dBm/15kHz)	power (dBm)
Mid Range	23230	782	5230	751	QPSK	1	0	0	-85	23.02
					QPSK	1	5	0	-85	23.01
					QPSK	1	0	3	-85	23.17
					QPSK	1	5	3	-85	23.24
					QPSK	1	0	7	-85	23.27
					QPSK	1	5	7	-85	23.24
					QPSK	4	0	0	-85	23.15
					QPSK	4	2	7	-85	23.17
					QPSK	6	0	0	-85	22.55
					QPSK	6	0	7	-85	22.84
					16QAM	1	0	0	-85	22.49
					16QAM	1	5	0	-85	23.01
					16QAM	1	0	3	-85	23.19
					16QAM	1	5	3	-85	23.12
					16QAM	1	0	7	-85	22.77
					16QAM	1	5	7	-85	22.89
					16QAM	4	2	0	-85	22.15
					16QAM	4	2	7	-85	22.81
16QAM	5	0	0	-85	22.02					
16QAM	5	0	7	-85	22.78					

LTE Band 17

BW(MHz):										
5										
Test Frequency ID	N _{UL}	Frequency of Uplink [MHz]	N _{DL}	Frequency of Downlink [MHz]	Test Configuration Initial of Power				EUT	
					Modulation	RB Size	RB Offset	Narrowband Index	Cell power (dBm/15kHz)	power (dBm)
Low Range	23755	706.5	5755	736.5	QPSK	1	0	0	-85	23.62
					QPSK	1	5	0	-85	23.71
					QPSK	1	0	1	-85	23.61
					QPSK	1	5	1	-85	23.69
					QPSK	1	0	3	-85	23.79
					QPSK	1	5	3	-85	23.71
					QPSK	3	0	0	-85	22.94
					QPSK	3	3	3	-85	22.82
					QPSK	6	0	0	-85	22.94
					QPSK	6	0	1	-85	22.94
					QPSK	6	0	3	-85	22.98
					16QAM	1	0	0	-85	23.01
					16QAM	1	5	0	-85	22.93
					16QAM	1	0	1	-85	22.96
					16QAM	1	5	1	-85	22.93
					16QAM	1	0	3	-85	23.01
					16QAM	1	5	3	-85	22.97
					16QAM	3	0	0	-85	22.56
					16QAM	3	3	3	-85	22.61
					16QAM	5	0	0	-85	21.34
16QAM	5	0	1	-85	21.31					
16QAM	5	0	3	-85	21.37					
Mid Range	23790	710	5790	740	QPSK	1	0	0	-85	23.67
					QPSK	1	5	0	-85	23.68
					QPSK	1	0	1	-85	23.45
					QPSK	1	5	1	-85	23.64
					QPSK	1	0	3	-85	23.71
					QPSK	1	5	3	-85	23.66
					QPSK	3	0	0	-85	22.98
					QPSK	3	3	3	-85	22.82
					QPSK	6	0	0	-85	22.94
					QPSK	6	0	1	-85	22.93
					QPSK	6	0	3	-85	22.91
					16QAM	1	0	0	-85	23
					16QAM	1	5	0	-85	22.94
					16QAM	1	0	1	-85	22.89
					16QAM	1	5	1	-85	22.94
					16QAM	1	0	3	-85	23.03
					16QAM	1	5	3	-85	22.99
					16QAM	3	0	0	-85	22.59
					16QAM	3	3	3	-85	22.56
					16QAM	5	0	0	-85	21.31
16QAM	5	0	1	-85	21.34					
16QAM	5	0	3	-85	21.29					

Test Frequency ID	N _{UL}	Frequency of Uplink [MHz]	N _{DL}	Frequency of Downlink [MHz]	Test Configuration Initial of Power				EUT	
					Modulation	RB Size	RB Offset	Narrowband Index	Cell power (dBm/15kHz)	power (dBm)
High Range	23825	713.5	5825	743.5	QPSK	1	0	0	-85	23.61
					QPSK	1	5	0	-85	23.67
					QPSK	1	0	1	-85	23.76
					QPSK	1	5	1	-85	23.68
					QPSK	1	0	3	-85	23.64
					QPSK	1	5	3	-85	23.61
					QPSK	3	0	0	-85	22.92
					QPSK	3	3	3	-85	22.79
					QPSK	6	0	0	-85	22.94
					QPSK	6	0	1	-85	22.97
					QPSK	6	0	3	-85	22.93
					16QAM	1	0	0	-85	22.97
					16QAM	1	5	0	-85	22.98
					16QAM	1	0	1	-85	23.04
					16QAM	1	5	1	-85	22.97
					16QAM	1	0	3	-85	22.94
					16QAM	1	5	3	-85	22.96
					16QAM	3	0	0	-85	22.56
16QAM	3	3	3	-85	22.97					
16QAM	5	0	0	-85	21.33					
16QAM	5	0	1	-85	21.34					
16QAM	5	0	3	-85	21.45					

BW(MHz): 10

Test Frequency ID	N _{UL}	Frequency of Uplink [MHz]	N _{DL}	Frequency of Downlink [MHz]	Test Configuration Initial of Power				EUT	
					Modulation	RB Size	RB Offset	Narrowband Index	Cell power (dBm/15kHz)	power (dBm)
Low Range	23780	709	5780	739	QPSK	1	0	0	-85	23.73
					QPSK	1	5	0	-85	23.42
					QPSK	1	0	3	-85	23.68
					QPSK	1	5	3	-85	23.73
					QPSK	1	0	7	-85	23.41
					QPSK	1	5	7	-85	23.39
					QPSK	4	0	0	-85	23.71
					QPSK	4	2	7	-85	23.52
					QPSK	6	0	0	-85	22.91
					QPSK	6	0	7	-85	22.85
					16QAM	1	0	0	-85	23.34
					16QAM	1	5	0	-85	23.12
					16QAM	1	0	3	-85	23.44
					16QAM	1	5	3	-85	23.26
					16QAM	1	0	7	-85	23.16
					16QAM	1	5	7	-85	22.98
					16QAM	4	2	0	-85	23.12
					16QAM	4	2	7	-85	23.02
16QAM	5	0	0	-85	22.71					
16QAM	5	0	7	-85	22.52					

Test Frequency ID	N _{UL}	Frequency of Uplink [MHz]	N _{DL}	Frequency of Downlink [MHz]	Test Configuration Initial of Power				EUT	
					Modulation	RB Size	RB Offset	Narrowband Index	Cell power (dBm/15kHz)	power (dBm)
Mid Range	23790	710	5790	740	QPSK	1	0	0	-85	23.71
					QPSK	1	5	0	-85	23.44
					QPSK	1	0	3	-85	23.64
					QPSK	1	5	3	-85	23.18
					QPSK	1	0	7	-85	23.44
					QPSK	1	5	7	-85	23.34
					QPSK	4	0	0	-85	23.67
					QPSK	4	2	7	-85	23.69
					QPSK	6	0	0	-85	22.91
					QPSK	6	0	7	-85	22.88
					16QAM	1	0	0	-85	23.38
					16QAM	1	5	0	-85	23.02
					16QAM	1	0	3	-85	23.41
					16QAM	1	5	3	-85	23.25
					16QAM	1	0	7	-85	23.22
					16QAM	1	5	7	-85	23.46
					16QAM	4	2	0	-85	22.69
					High Range	23800	711	5800	741	QPSK
QPSK	1	5	0	-85						23.59
QPSK	1	5	7	-85						23.57
QPSK	1	0	3	-85						23.57
QPSK	1	5	3	-85						23.61
QPSK	1	0	7	-85						23.32
QPSK	4	0	0	-85						23.64
QPSK	4	2	7	-85						23.67
QPSK	6	0	0	-85						22.87
QPSK	6	0	7	-85						22.75
16QAM	1	0	0	-85						23.03
16QAM	1	5	0	-85						23.07
16QAM	1	0	3	-85						23.16
16QAM	1	5	3	-85						23.12
16QAM	1	0	7	-85						23.27
16QAM	1	5	7	-85						23.36
16QAM	4	2	0	-85						23.01
16QAM	4	2	7	-85						22.97
16QAM	5	0	0	-85	22.76					
16QAM	5	0	7	-85	22.75					

LTE Band 66

BW(MHz):		1.4								
Test Frequency ID	N _{UL}	Frequency of Uplink [MHz]	N _{DL}	Frequency of Downlink [MHz]	Test Configuration Initial of Power				EUT	
					Modulation	RB Size	RB Offset	Narrowband Index	Cell power (dBm/15kHz)	power (dBm)
Low Range	131979	1710.7	66443	2110.7	QPSK	1	0	0	-85	23.58
					QPSK	1	5	0	-85	23.53
					QPSK	3	3	0	-85	22.31
					QPSK	6	0	0	-85	21.18
					16QAM	1	0	0	-85	21.99
					16QAM	1	5	0	-85	22.02
					16QAM	3	0	0	-85	21.69
Mid Range	132322	1745	66786	2145	QPSK	1	0	0	-85	23.63
					QPSK	1	5	0	-85	23.54
					QPSK	3	3	0	-85	22.43
					QPSK	6	0	0	-85	21.24
					16QAM	1	0	0	-85	23.42
					16QAM	1	5	0	-85	23.37
					16QAM	3	0	0	-85	22.36
High Range	132665	1779.3	67129	2179.3	QPSK	1	0	0	-85	23.17
					QPSK	1	5	0	-85	23.19
					QPSK	3	3	0	-85	22.02
					QPSK	6	0	0	-85	20.66
					16QAM	1	0	0	-85	21.71
					16QAM	1	5	0	-85	21.88
					16QAM	3	0	0	-85	21.32
16QAM	5	0	0	-85	20.97					

BW(MHz):		3								
Test Frequency ID	N _{UL}	Frequency of Uplink [MHz]	N _{DL}	Frequency of Downlink [MHz]	Test Configuration Initial of Power				EUT	
					Modulation	RB Size	RB Offset	Narrowband Index	Cell power (dBm/15kHz)	power (dBm)
Low Range	131987	1711.5	66451	2111.5	QPSK	1	0	0	-85	23.02
					QPSK	1	5	0	-85	22.97
					QPSK	1	0	1	-85	23.12
					QPSK	1	5	1	-85	22.94
					QPSK	3	3	0	-85	21.99
					QPSK	3	3	1	-85	21.86
					QPSK	6	0	0	-85	20.83
					QPSK	6	0	1	-85	20.81
					16QAM	1	0	0	-85	22.02
					16QAM	1	5	0	-85	22.12
					16QAM	1	0	1	-85	22.02
					16QAM	1	5	1	-85	22.11
					16QAM	3	0	0	-85	21.67
					16QAM	3	3	1	-85	21.39
					16QAM	5	0	0	-85	20.76
16QAM	5	0	1	-85	20.82					

Test Frequency ID	N _{UL}	Frequency of Uplink [MHz]	N _{DL}	Frequency of Downlink [MHz]	Test Configuration Initial of Power				EUT	
					Modulation	RB Size	RB Offset	Narrowband Index	Cell power (dBm/15kHz)	power (dBm)
Mid Range	132322	1745	66786	2145	QPSK	1	0	0	-85	23.12
					QPSK	1	5	0	-85	23.02
					QPSK	1	0	1	-85	23.32
					QPSK	1	5	1	-85	23.33
					QPSK	3	3	0	-85	21.99
					QPSK	3	3	1	-85	21.97
					QPSK	6	0	0	-85	20.91
					QPSK	6	0	1	-85	20.83
					16QAM	1	0	0	-85	23.03
					16QAM	1	5	0	-85	23.05
					16QAM	1	0	1	-85	23.14
					16QAM	1	5	1	-85	23.03
					16QAM	3	0	0	-85	22.18
					16QAM	3	3	1	-85	22.08
					16QAM	5	0	0	-85	21.97
16QAM	5	0	1	-85	22.12					
High Range	132657	1778.5	67121	2178.5	QPSK	1	0	0	-85	22.91
					QPSK	1	5	0	-85	22.95
					QPSK	1	0	1	-85	22.94
					QPSK	1	5	1	-85	22.89
					QPSK	3	3	0	-85	21.58
					QPSK	3	3	1	-85	21.54
					QPSK	6	0	0	-85	20.59
					QPSK	6	0	1	-85	20.43
					16QAM	1	0	0	-85	21.77
					16QAM	1	5	0	-85	21.78
					16QAM	1	0	1	-85	21.76
					16QAM	1	5	1	-85	21.33
					16QAM	3	0	0	-85	21.26
					16QAM	3	3	1	-85	21.56
					16QAM	5	0	0	-85	20.58
16QAM	5	0	1	-85	20.44					

BW(MHz):		5								
Test Frequency ID	NUL	Frequency of Uplink [MHz]	N _{DL}	Frequency of Downlink [MHz]	Test Configuration Initial of Power			EUT		
					Modulation	RB Size	RB Offset	Narrowband Index	Cell power (dBm/15kHz)	power (dBm)
Low Range	131997	1712.5	66461	2112.5	QPSK	1	0	0	-85	22.97
					QPSK	1	5	0	-85	22.91
					QPSK	1	0	1	-85	22.94
					QPSK	1	5	1	-85	22.89
					QPSK	1	0	3	-85	21.89
					QPSK	1	5	3	-85	21.88
					QPSK	3	0	0	-85	21.77
					QPSK	3	3	3	-85	21.92
					QPSK	6	0	0	-85	21.84
					QPSK	6	0	1	-85	21.65
					QPSK	6	0	3	-85	21.55
					16QAM	1	0	0	-85	22.17
					16QAM	1	5	0	-85	23.06
					16QAM	1	0	1	-85	23.02
					16QAM	1	5	1	-85	23.01
					16QAM	1	0	3	-85	23.14
					16QAM	1	5	3	-85	23.12
					16QAM	3	0	0	-85	22.72
					16QAM	3	3	3	-85	22.87
					16QAM	5	0	0	-85	21.11
16QAM	5	0	1	-85	21.32					
16QAM	5	0	3	-85	21.23					
Mid Range	132322	1745	66786	2145	QPSK	1	0	0	-85	23.07
					QPSK	1	5	0	-85	23.01
					QPSK	1	0	1	-85	23.13
					QPSK	1	5	1	-85	23.09
					QPSK	1	0	3	-85	23.13
					QPSK	1	5	3	-85	23.01
					QPSK	3	0	0	-85	22.37
					QPSK	3	3	3	-85	21.97
					QPSK	6	0	0	-85	21.83
					QPSK	6	0	1	-85	22.17
					QPSK	6	0	3	-85	22.25
					16QAM	1	0	0	-85	23.16
					16QAM	1	5	0	-85	23.14
					16QAM	1	0	1	-85	23.21
					16QAM	1	5	1	-85	23.04
					16QAM	1	0	3	-85	23.12
					16QAM	1	5	3	-85	23.12
					16QAM	3	0	0	-85	22.03
					16QAM	3	3	3	-85	22.02
					16QAM	5	0	0	-85	22.07
16QAM	5	0	1	-85	22.14					
16QAM	5	0	3	-85	22.14					

Test Frequency ID	N _{UL}	Frequency of Uplink [MHz]	N _{DL}	Frequency of Downlink [MHz]	Test Configuration Initial of Power				EUT	
					Modulation	RB Size	RB Offset	Narrowband Index	Cell power (dBm/15kHz)	power (dBm)
High Range	132647	1777.5	67111	2177.5	QPSK	1	0	0	-85	22.93
					QPSK	1	5	0	-85	22.69
					QPSK	1	0	1	-85	22.73
					QPSK	1	5	1	-85	22.78
					QPSK	1	0	3	-85	22.67
					QPSK	1	5	3	-85	22.88
					QPSK	3	0	0	-85	21.84
					QPSK	3	3	3	-85	21.78
					QPSK	6	0	0	-85	21.79
					QPSK	6	0	1	-85	21.62
					QPSK	6	0	3	-85	21.68
					16QAM	1	0	0	-85	22.56
					16QAM	1	5	0	-85	23.02
					16QAM	1	0	1	-85	23.01
					16QAM	1	5	1	-85	23.07
					16QAM	1	0	3	-85	22.99
					16QAM	1	5	3	-85	22.91
					16QAM	3	0	0	-85	22.24
16QAM	3	3	3	-85	22.21					
16QAM	5	0	0	-85	20.72					
16QAM	5	0	1	-85	20.66					
16QAM	5	0	3	-85	20.73					

BW(MHz): 10

Test Frequency ID	N _{UL}	Frequency of Uplink [MHz]	N _{DL}	Frequency of Downlink [MHz]	Test Configuration Initial of Power				EUT	
					Modulation	RB Size	RB Offset	Narrowband Index	Cell power (dBm/15kHz)	power (dBm)
Low Range	132022	1715	66486	2115	QPSK	1	0	0	-85	23.01
					QPSK	1	5	0	-85	22.94
					QPSK	1	0	3	-85	23.02
					QPSK	1	5	3	-85	22.98
					QPSK	1	0	7	-85	23.04
					QPSK	1	5	7	-85	22.95
					QPSK	4	0	0	-85	23.01
					QPSK	4	2	7	-85	22.96
					QPSK	6	0	0	-85	22.04
					QPSK	6	0	7	-85	21.95
					16QAM	1	0	0	-85	23.18
					16QAM	1	5	0	-85	23.02
					16QAM	1	0	3	-85	23.01
					16QAM	1	5	3	-85	22.99
					16QAM	1	0	7	-85	22.94
					16QAM	1	5	7	-85	22.93
					16QAM	4	2	0	-85	21.95
					16QAM	4	2	7	-85	21.89
16QAM	6	0	0	-85	21.82					
16QAM	6	0	7	-85	21.8					

Test Frequency ID	N _{UL}	Frequency of Uplink [MHz]	N _{DL}	Frequency of Downlink [MHz]	Test Configuration Initial of Power				EUT	
					Modulation	RB Size	RB Offset	Narrowband Index	Cell power (dBm/15kHz)	power (dBm)
Mid Range	132322	1745	66786	2145	QPSK	1	0	0	-85	23.01
					QPSK	1	5	0	-85	22.96
					QPSK	1	0	3	-85	23.01
					QPSK	1	5	3	-85	23.04
					QPSK	1	0	7	-85	23.01
					QPSK	1	5	7	-85	23.04
					QPSK	4	0	0	-85	23.15
					QPSK	4	2	7	-85	23.02
					QPSK	6	0	0	-85	21.91
					QPSK	6	0	7	-85	21.93
					16QAM	1	0	0	-85	23.12
					16QAM	1	5	0	-85	23.22
					16QAM	1	0	3	-85	23.32
					16QAM	1	5	3	-85	23.06
					16QAM	1	0	7	-85	23.04
					16QAM	1	5	7	-85	23.01
					16QAM	4	2	0	-85	23.01
					16QAM	4	2	7	-85	23.14
16QAM	5	0	0	-85	22.11					
16QAM	5	0	7	-85	22.03					
High Range	132622	1775	67086	2175	QPSK	1	0	0	-85	22.67
					QPSK	1	5	0	-85	22.65
					QPSK	1	5	7	-85	22.72
					QPSK	1	0	3	-85	22.7
					QPSK	1	5	3	-85	22.68
					QPSK	1	0	7	-85	22.71
					QPSK	4	0	0	-85	22.98
					QPSK	4	2	7	-85	22.88
					QPSK	6	0	0	-85	21.23
					QPSK	6	0	7	-85	21.18
					16QAM	1	0	0	-85	22.75
					16QAM	1	5	0	-85	22.88
					16QAM	1	0	3	-85	22.67
					16QAM	1	5	3	-85	22.75
					16QAM	1	0	7	-85	22.81
					16QAM	1	5	7	-85	22.69
					16QAM	4	2	0	-85	21.02
					16QAM	4	2	7	-85	21.33
16QAM	6	0	0	-85	21.14					
16QAM	6	0	7	-85	20.87					

BW(MHz):		15								
Test Frequency ID	N _{UL}	Frequency of Uplink [MHz]	N _{DL}	Frequency of Downlink [MHz]	Test Configuration Initial of Power			EUT		
					Modulation	RB Size	RB Offset	Narrowband Index	Cell power (dBm/15kHz)	power (dBm)
Low Range	132047	1717.5	66511	2117.5	QPSK	1	0	0	-85	22.96
					QPSK	1	5	0	-85	23.03
					QPSK	1	0	5	-85	22.97
					QPSK	1	5	5	-85	23.04
					QPSK	1	0	11	-85	23.11
					QPSK	1	5	11	-85	23.05
					QPSK	3	0	0	-85	23.13
					QPSK	3	3	11	-85	22.88
					QPSK	6	0	0	-85	22.77
					QPSK	6	0	11	-85	22.54
					16QAM	1	0	0	-85	22.44
					16QAM	1	5	0	-85	22.17
					16QAM	1	0	5	-85	22.39
					16QAM	1	5	5	-85	22.56
					16QAM	1	0	11	-85	22.53
					16QAM	1	5	11	-85	22.47
					16QAM	3	0	0	-85	23.44
					16QAM	3	3	11	-85	22.61
16QAM	5	0	0	-85	22.97					
16QAM	5	0	11	-85	22.45					
Mid Range	132322	1745	66786	2145	QPSK	1	0	0	-85	23.14
					QPSK	1	5	0	-85	23.1
					QPSK	1	0	5	-85	22.93
					QPSK	1	5	5	-85	22.92
					QPSK	1	0	11	-85	22.93
					QPSK	1	5	11	-85	22.91
					QPSK	3	0	0	-85	23.13
					QPSK	3	3	11	-85	22.94
					QPSK	6	0	0	-85	22.87
					QPSK	6	0	11	-85	23.02
					16QAM	1	0	0	-85	23.23
					16QAM	1	5	0	-85	23.19
					16QAM	1	0	5	-85	23.02
					16QAM	1	5	5	-85	23.16
					16QAM	1	0	11	-85	23.01
					16QAM	1	5	11	-85	23.12
					16QAM	3	0	0	-85	23.04
					16QAM	3	3	11	-85	23.11
16QAM	5	0	0	-85	23.12					
16QAM	5	0	11	-85	22.67					

Test Frequency ID	N _{UL}	Frequency of Uplink [MHz]	N _{DL}	Frequency of Downlink [MHz]	Test Configuration Initial of Power				EUT	
					Modulation	RB Size	RB Offset	Narrowband Index	Cell power (dBm/15kHz)	power (dBm)
High Range	132597	1772.5	67061	2172.5	QPSK	1	0	0	-85	22.78
					QPSK	1	5	11	-85	22.89
					QPSK	1	0	5	-85	22.91
					QPSK	1	5	5	-85	22.93
					QPSK	1	0	11	-85	22.87
					QPSK	1	5	11	-85	22.95
					QPSK	3	0	0	-85	23.04
					QPSK	3	3	11	-85	23.01
					QPSK	6	0	0	-85	22.84
					QPSK	6	0	11	-85	21.87
					16QAM	1	0	0	-85	22.96
					16QAM	1	5	0	-85	22.96
					16QAM	1	0	5	-85	22.95
					16QAM	1	5	5	-85	22.91
					16QAM	1	0	11	-85	22.89
					16QAM	1	5	11	-85	22.76
					16QAM	3	0	0	-85	23.01
					16QAM	3	3	11	-85	23.03
16QAM	5	0	0	-85	22.84					
16QAM	5	0	11	-85	21.56					

BW(MHz): 20

Test Frequency ID	N _{UL}	Frequency of Uplink [MHz]	N _{DL}	Frequency of Downlink [MHz]	Test Configuration Initial of Power				EUT	
					Modulation	RB Size	RB Offset	Narrowband Index	Cell power (dBm/15kHz)	power (dBm)
Low Range	132072	1720	66536	2120	QPSK	1	0	0	-85	23.11
					QPSK	1	5	0	-85	23.02
					QPSK	1	0	7	-85	23.02
					QPSK	1	5	7	-85	23.01
					QPSK	1	0	15	-85	23.02
					QPSK	1	5	15	-85	22.99
					QPSK	3	0	0	-85	23.14
					QPSK	3	3	15	-85	22.66
					QPSK	6	0	0	-85	22.76
					QPSK	6	0	15	-85	22.95
					16QAM	1	0	0	-85	22.67
					16QAM	1	5	0	-85	22.87
					16QAM	1	0	7	-85	23.01
					16QAM	1	5	7	-85	22.87
					16QAM	1	0	15	-85	22.84
					16QAM	1	5	15	-85	22.76
					16QAM	3	0	0	-85	23.09
					16QAM	3	3	15	-85	23.23
16QAM	5	0	0	-85	23.07					
16QAM	5	0	15	-85	22.95					

Test Frequency ID	N _{UL}	Frequency of Uplink [MHz]	N _{DL}	Frequency of Downlink [MHz]	Test Configuration Initial of Power				EUT	
					Modulation	RB Size	RB Offset	Narrowband Index	Cell power (dBm/15kHz)	power (dBm)
Mid Range	132322	1745	66786	2145	QPSK	1	0	0	-85	22.97
					QPSK	1	5	0	-85	23.21
					QPSK	1	0	7	-85	22.95
					QPSK	1	5	7	-85	22.97
					QPSK	1	0	15	-85	22.91
					QPSK	1	5	15	-85	22.91
					QPSK	3	0	0	-85	23.19
					QPSK	3	3	15	-85	22.82
					QPSK	6	0	0	-85	23.01
					QPSK	6	0	15	-85	22.78
					16QAM	1	0	0	-85	23.03
					16QAM	1	5	0	-85	23.12
					16QAM	1	0	7	-85	22.87
					16QAM	1	5	7	-85	22.93
					16QAM	1	0	15	-85	23.13
					16QAM	1	5	15	-85	23.12
					16QAM	3	0	0	-85	22.87
					16QAM	3	3	15	-85	22.94
16QAM	5	0	0	-85	22.84					
16QAM	5	0	15	-85	22.88					
High Range	132572	1770	67036	2170	QPSK	1	0	0	-85	22.86
					QPSK	1	5	0	-85	22.79
					QPSK	1	0	7	-85	22.84
					QPSK	1	5	7	-85	22.87
					QPSK	1	0	15	-85	22.79
					QPSK	1	5	15	-85	22.81
					QPSK	3	0	0	-85	22.87
					QPSK	3	3	15	-85	22.75
					QPSK	6	0	0	-85	22.72
					QPSK	6	0	15	-85	22.65
					16QAM	1	0	0	-85	22.81
					16QAM	1	5	0	-85	22.88
					16QAM	1	0	7	-85	22.91
					16QAM	1	5	7	-85	23.02
					16QAM	1	0	15	-85	22.98
					16QAM	1	5	15	-85	22.99
					16QAM	3	0	0	-85	23.05
					16QAM	3	3	15	-85	23.01
16QAM	5	0	0	-85	22.67					
16QAM	5	0	15	-85	22.5					

ERP Power (dBm)

LTE Band 12							
Channel Bandwidth: 1.4 MHz / QPSK							
Plane	Channel	Frequency (MHz)	Reading (dBm)	Correction Factor (dB)	ERP (dBm)	ERP (mW)	Polarization (H/V)
X	23017	699.7	-3.03	30.36	25.18	329.61	H
	23095	707.5	-3.01	30.17	25.01	316.96	
	23173	715.3	-2.95	30.17	25.07	321.37	
	23017	699.7	-10.56	32.03	19.32	85.51	V
	23095	707.5	-10.84	31.98	18.99	79.25	
	23173	715.3	-10.74	32.06	19.17	82.60	
Channel Bandwidth: 1.4 MHz / 16QAM							
X	23017	699.7	-4.02	30.36	24.19	262.42	H
	23095	707.5	-4.00	30.17	24.02	252.35	
	23173	715.3	-3.94	30.17	24.08	255.86	
	23017	699.7	-11.55	32.03	18.33	68.08	V
	23095	707.5	-11.83	31.98	18.00	63.10	
	23173	715.3	-11.73	32.06	18.18	65.77	

Note: ERP (dBm) = Reading (dBm) + Correction Factor (dB) – 2.15

LTE Band 12							
Channel Bandwidth: 3 MHz / QPSK							
Plane	Channel	Frequency (MHz)	Reading (dBm)	Correction Factor (dB)	ERP (dBm)	ERP (mW)	Polarization (H/V)
X	23025	700.5	-3.05	30.17	24.97	314.05	H
	23095	707.5	-3.22	30.17	24.80	302.00	
	23165	714.5	-3.17	30.18	24.86	306.20	
	23025	700.5	-10.70	31.96	19.11	81.47	V
	23095	707.5	-11.05	31.98	18.78	75.51	
	23165	714.5	-10.92	32.03	18.96	78.70	
Channel Bandwidth: 3 MHz / 16QAM							
X	23025	700.5	-4.08	30.17	23.94	247.74	H
	23095	707.5	-4.25	30.17	23.77	238.23	
	23165	714.5	-4.20	30.18	23.83	241.55	
	23025	700.5	-11.73	31.96	18.08	64.27	V
	23095	707.5	-12.08	31.98	17.75	59.57	
	23165	714.5	-11.95	32.03	17.93	62.09	

Note: ERP (dBm) = Reading (dBm) + Correction Factor (dB) – 2.15

LTE Band 12							
Channel Bandwidth: 5 MHz / QPSK							
Plane	Channel	Frequency (MHz)	Reading (dBm)	Correction Factor (dB)	ERP (dBm)	ERP (mW)	Polarization (H/V)
X	23035	701.5	-3.36	30.17	24.66	292.42	H
	23095	707.5	-3.53	30.17	24.49	281.19	
	23155	713.5	-3.48	30.18	24.55	285.10	
	23035	701.5	-11.01	31.96	18.80	75.86	V
	23095	707.5	-11.36	31.98	18.47	70.31	
	23155	713.5	-11.23	32.03	18.65	73.28	
Channel Bandwidth: 5 MHz / 16QAM							
X	23035	701.5	-4.39	30.17	23.63	230.67	H
	23095	707.5	-4.56	30.17	23.46	221.82	
	23155	713.5	-4.51	30.18	23.52	224.91	
	23035	701.5	-12.04	31.96	17.77	59.84	V
	23095	707.5	-12.39	31.98	17.44	55.46	
	23155	713.5	-12.26	32.03	17.62	57.81	

Note: ERP (dBm) = Reading (dBm) + Correction Factor (dB) – 2.15

LTE Band 12							
Channel Bandwidth: 10 MHz / QPSK							
Plane	Channel	Frequency (MHz)	Reading (dBm)	Correction Factor (dB)	ERP (dBm)	ERP (mW)	Polarization (H/V)
X	23060	704.0	-3.58	30.17	24.44	277.97	H
	23095	707.5	-3.75	30.17	24.27	267.30	
	23130	711.0	-3.70	30.18	24.33	271.02	
	23060	704.0	-11.23	31.96	18.58	72.11	V
	23095	707.5	-11.58	31.98	18.25	66.83	
	23130	711.0	-11.45	32.03	18.43	69.66	
Channel Bandwidth: 10 MHz / 16QAM							
X	23060	704.0	-4.69	30.17	23.33	215.28	H
	23095	707.5	-4.86	30.17	23.16	207.01	
	23130	711.0	-4.81	30.18	23.22	209.89	
	23060	704.0	-12.34	31.96	17.47	55.85	V
	23095	707.5	-12.69	31.98	17.14	51.76	
	23130	711.0	-12.56	32.03	17.32	53.95	

Note: ERP (dBm) = Reading (dBm) + Correction Factor (dB) – 2.15

LTE Band 13							
Channel Bandwidth: 5 MHz / QPSK							
Plane	Channel	Frequency (MHz)	Reading (dBm)	Correction Factor (dB)	ERP (dBm)	ERP (mW)	Polarization (H/V)
X	23205	779.5	-5.70	32.24	24.39	274.79	H
	23230	782.0	-5.49	32.17	24.53	283.79	
	23255	784.5	-5.46	32.11	24.50	281.84	
	23205	779.5	-11.89	32.43	18.39	69.02	V
	23230	782.0	-11.50	32.42	18.77	75.34	
	23255	784.5	-11.72	32.46	18.59	72.28	
Channel Bandwidth: 5 MHz / 16QAM							
X	23205	779.5	-6.71	32.24	23.38	217.77	H
	23230	782.0	-6.50	32.17	23.52	224.91	
	23255	784.5	-6.47	32.11	23.49	223.36	
	23205	779.5	-12.90	32.43	17.38	54.70	V
	23230	782.0	-12.51	32.42	17.76	59.70	
	23255	784.5	-12.73	32.46	17.58	57.28	

Note: ERP (dBm) = Reading (dBm) + Correction Factor (dB) – 2.15

LTE Band 13							
Channel Bandwidth: 10 MHz / QPSK							
Plane	Channel	Frequency (MHz)	Reading (dBm)	Correction Factor (dB)	ERP (dBm)	ERP (mW)	Polarization (H/V)
X	23230	782.0	-5.79	32.17	24.23	264.85	H
	23230	782.0	-11.80	32.42	18.47	70.31	V
Channel Bandwidth: 10 MHz / 16QAM							
X	23230	782.0	-6.78	32.17	23.24	210.86	H
	23230	782.0	-12.79	32.42	17.48	55.98	V

Note: ERP (dBm) = Reading (dBm) + Correction Factor (dB) – 2.15

LTE Band 17							
Channel Bandwidth: 5 MHz / QPSK							
Plane	Channel	Frequency (MHz)	Reading (dBm)	Correction Factor (dB)	ERP (dBm)	ERP (mW)	Polarization (H/V)
X	23755	706.5	-3.65	30.36	24.56	285.76	H
	23790	710.0	-3.57	30.17	24.45	278.61	
	23825	713.5	-3.54	30.17	24.48	280.54	
	23755	706.5	-11.35	32.03	18.53	71.29	V
	23790	710.0	-11.58	31.98	18.25	66.83	
	23825	713.5	-11.52	32.06	18.39	69.02	
Channel Bandwidth: 5 MHz / 16QAM							
X	23755	706.5	-4.67	30.36	23.54	225.94	H
	23790	710.0	-4.59	30.17	23.43	220.29	
	23825	713.5	-4.56	30.17	23.46	221.82	
	23755	706.5	-12.37	32.03	17.51	56.36	V
	23790	710.0	-12.60	31.98	17.23	52.84	
	23825	713.5	-12.54	32.06	17.37	54.58	

Note: ERP (dBm) = Reading (dBm) + Correction Factor (dB) – 2.15

LTE Band 17							
Channel Bandwidth: 10 MHz / QPSK							
Plane	Channel	Frequency (MHz)	Reading (dBm)	Correction Factor (dB)	ERP (dBm)	ERP (mW)	Polarization (H/V)
X	23780	709.0	-3.78	30.17	24.24	265.46	H
	23790	710.0	-3.89	30.17	24.13	258.82	
	23800	711.0	-3.87	30.18	24.16	260.62	
	23780	709.0	-11.60	31.96	18.21	66.22	V
	23790	710.0	-11.90	31.98	17.93	62.09	
	23800	711.0	-11.81	32.03	18.07	64.12	
Channel Bandwidth: 10 MHz / 16QAM							
X	23780	709.0	-4.77	30.17	23.25	211.35	H
	23790	710.0	-4.88	30.17	23.14	206.06	
	23800	711.0	-4.86	30.18	23.17	207.49	
	23780	709.0	-12.59	31.96	17.22	52.72	V
	23790	710.0	-12.89	31.98	16.94	49.43	
	23800	711.0	-12.80	32.03	17.08	51.05	

Note: ERP (dBm) = Reading (dBm) + Correction Factor (dB) – 2.15

EIRP Power (dBm)

LTE Band 4							
Channel Bandwidth: 1.4 MHz / QPSK							
Plane	Channel	Frequency (MHz)	Reading (dBm)	Correction Factor (dB)	EIRP (dBm)	EIRP (mW)	Polarization (H/V)
X	19957	1710.7	-11.47	36.45	24.98	314.77	H
	20175	1732.5	-11.91	36.80	24.89	308.32	
	20393	1754.3	-12.19	36.94	24.75	298.54	
	19957	1710.7	-18.49	37.28	18.79	75.68	V
	20175	1732.5	-19.10	37.63	18.53	71.29	
	20393	1754.3	-19.40	37.64	18.24	66.68	
Channel Bandwidth: 1.4 MHz / 16QAM							
X	19957	1710.7	-12.48	36.45	23.97	249.46	H
	20175	1732.5	-12.92	36.80	23.88	244.34	
	20393	1754.3	-13.20	36.94	23.74	236.59	
	19957	1710.7	-19.50	37.28	17.78	59.98	V
	20175	1732.5	-20.11	37.63	17.52	56.49	
	20393	1754.3	-20.41	37.64	17.23	52.84	

Note: EIRP (dBm) = Reading (dBm) + Correction Factor (dB)

LTE Band 4							
Channel Bandwidth: 3 MHz / QPSK							
Plane	Channel	Frequency (MHz)	Reading (dBm)	Correction Factor (dB)	EIRP (dBm)	EIRP (mW)	Polarization (H/V)
X	19965	1711.5	-11.72	36.45	24.73	297.17	H
	20175	1732.5	-12.16	36.80	24.64	291.07	
	20385	1753.5	-12.44	36.94	24.50	281.84	
	19965	1711.5	-18.74	37.28	18.54	71.45	V
	20175	1732.5	-19.35	37.63	18.28	67.30	
	20385	1753.5	-19.65	37.64	17.99	62.95	
Channel Bandwidth: 3 MHz / 16QAM							
X	19965	1711.5	-12.71	36.45	23.74	236.59	H
	20175	1732.5	-13.15	36.80	23.65	231.74	
	20385	1753.5	-13.43	36.94	23.51	224.39	
	19965	1711.5	-19.73	37.28	17.55	56.89	V
	20175	1732.5	-20.34	37.63	17.29	53.58	
	20385	1753.5	-20.64	37.64	17.00	50.12	

Note: EIRP (dBm) = Reading (dBm) + Correction Factor (dB)

LTE Band 4							
Channel Bandwidth: 5 MHz / QPSK							
Plane	Channel	Frequency (MHz)	Reading (dBm)	Correction Factor (dB)	EIRP (dBm)	EIRP (mW)	Polarization (H/V)
X	19975	1712.5	-12.03	36.45	24.42	276.69	H
	20175	1732.5	-12.47	36.80	24.33	271.02	
	20375	1752.5	-12.75	36.94	24.19	262.42	
	19975	1712.5	-19.05	37.28	18.23	66.53	V
	20175	1732.5	-19.66	37.63	17.97	62.66	
	20375	1752.5	-19.96	37.64	17.68	58.61	
Channel Bandwidth: 5 MHz / 16QAM							
X	19975	1712.5	-13.05	36.45	23.40	218.78	H
	20175	1732.5	-13.49	36.80	23.31	214.29	
	20375	1752.5	-13.77	36.94	23.17	207.49	
	19975	1712.5	-20.07	37.28	17.21	52.60	V
	20175	1732.5	-20.68	37.63	16.95	49.55	
	20375	1752.5	-20.98	37.64	16.66	46.34	

Note: EIRP (dBm) = Reading (dBm) + Correction Factor (dB)

LTE Band 4							
Channel Bandwidth: 10 MHz / QPSK							
Plane	Channel	Frequency (MHz)	Reading (dBm)	Correction Factor (dB)	EIRP (dBm)	EIRP (mW)	Polarization (H/V)
X	20000	1715.0	-12.43	36.64	24.21	263.63	H
	20175	1732.5	-12.68	36.80	24.12	258.23	
	20350	1750.0	-12.82	36.80	23.98	250.03	
	20000	1715.0	-19.42	37.44	18.02	63.39	V
	20175	1732.5	-19.87	37.63	17.76	59.70	
	20350	1750.0	-20.17	37.64	17.47	55.85	
Channel Bandwidth: 10 MHz / 16QAM							
X	20000	1715.0	-13.44	36.64	23.20	208.93	H
	20175	1732.5	-13.69	36.80	23.11	204.64	
	20350	1750.0	-13.83	36.80	22.97	198.15	
	20000	1715.0	-20.43	37.44	17.01	50.23	V
	20175	1732.5	-20.88	37.63	16.75	47.32	
	20350	1750.0	-21.18	37.64	16.46	44.26	

Note: EIRP (dBm) = Reading (dBm) + Correction Factor (dB)

LTE Band 4							
Channel Bandwidth: 15 MHz / QPSK							
Plane	Channel	Frequency (MHz)	Reading (dBm)	Correction Factor (dB)	EIRP (dBm)	EIRP (mW)	Polarization (H/V)
X	20025	1717.5	-12.51	36.45	23.94	247.74	H
	20175	1732.5	-12.95	36.80	23.85	242.66	
	20325	1747.5	-13.23	36.94	23.71	234.96	
	20025	1717.5	-19.53	37.28	17.75	59.57	V
	20175	1732.5	-20.14	37.63	17.49	56.10	
	20325	1747.5	-20.44	37.64	17.20	52.48	
Channel Bandwidth: 15 MHz / 16QAM							
X	20025	1717.5	-13.53	36.45	22.92	195.88	H
	20175	1732.5	-13.97	36.80	22.83	191.87	
	20325	1747.5	-14.25	36.94	22.69	185.78	
	20025	1717.5	-20.55	37.28	16.73	47.10	V
	20175	1732.5	-21.16	37.63	16.47	44.36	
	20325	1747.5	-21.46	37.64	16.18	41.50	

Note: EIRP (dBm) = Reading (dBm) + Correction Factor (dB)

LTE Band 4							
Channel Bandwidth: 20 MHz / QPSK							
Plane	Channel	Frequency (MHz)	Reading (dBm)	Correction Factor (dB)	EIRP (dBm)	EIRP (mW)	Polarization (H/V)
X	20050	1720.0	-12.75	36.45	23.70	234.42	H
	20175	1732.5	-13.19	36.80	23.61	229.61	
	20300	1745.0	-13.47	36.94	23.47	222.33	
	20050	1720.0	-19.77	37.28	17.51	56.36	V
	20175	1732.5	-20.38	37.63	17.25	53.09	
	20300	1745.0	-20.68	37.64	16.96	49.66	
Channel Bandwidth: 20 MHz / 16QAM							
X	20050	1720.0	-13.77	36.45	22.68	185.35	H
	20175	1732.5	-14.21	36.80	22.59	181.55	
	20300	1745.0	-14.49	36.94	22.45	175.79	
	20050	1720.0	-20.79	37.28	16.49	44.57	V
	20175	1732.5	-21.40	37.63	16.23	41.98	
	20300	1745.0	-21.70	37.64	15.94	39.26	

Note: EIRP (dBm) = Reading (dBm) + Correction Factor (dB)

LTE Band 66							
Channel Bandwidth: 1.4 MHz / QPSK							
Plane	Channel	Frequency (MHz)	Reading (dBm)	Correction Factor (dB)	EIRP (dBm)	EIRP (mW)	Polarization (H/V)
X	131979	1710.7	-11.88	36.45	24.57	286.42	H
	132322	1745.0	-12.19	36.80	24.61	289.07	
	132665	1779.3	-12.74	36.94	24.20	263.03	
	131979	1710.7	-18.86	37.28	18.42	69.50	V
	132322	1745.0	-19.05	37.63	18.58	72.11	
	132665	1779.3	-19.37	37.64	18.27	67.14	
Channel Bandwidth: 1.4 MHz / 16QAM							
X	131979	1710.7	-12.90	36.45	23.55	226.46	H
	132322	1745.0	-13.21	36.80	23.59	228.56	
	132665	1779.3	-13.76	36.94	23.18	207.97	
	131979	1710.7	-19.88	37.28	17.40	54.95	V
	132322	1745.0	-20.07	37.63	17.56	57.02	
	132665	1779.3	-20.39	37.64	17.25	53.09	

Note: EIRP (dBm) = Reading (dBm) + Correction Factor (dB)

LTE Band 66							
Channel Bandwidth: 3 MHz / QPSK							
Plane	Channel	Frequency (MHz)	Reading (dBm)	Correction Factor (dB)	EIRP (dBm)	EIRP (mW)	Polarization (H/V)
X	131987	1711.5	-12.18	36.45	24.27	267.30	H
	132322	1745.0	-12.49	36.80	24.31	269.77	
	132657	1778.5	-13.04	36.94	23.90	245.47	
	131987	1711.5	-19.16	37.28	18.12	64.86	V
	132322	1745.0	-19.35	37.63	18.28	67.30	
	132657	1778.5	-19.67	37.64	17.97	62.66	
Channel Bandwidth: 3 MHz / 16QAM							
X	131987	1711.5	-13.16	36.45	23.29	213.30	H
	132322	1745.0	-13.47	36.80	23.33	215.28	
	132657	1778.5	-14.02	36.94	22.92	195.88	
	131987	1711.5	-20.14	37.28	17.14	51.76	V
	132322	1745.0	-20.33	37.63	17.30	53.70	
	132657	1778.5	-20.65	37.64	16.99	50.00	

Note: EIRP (dBm) = Reading (dBm) + Correction Factor (dB)

LTE Band 66							
Channel Bandwidth: 5 MHz / QPSK							
Plane	Channel	Frequency (MHz)	Reading (dBm)	Correction Factor (dB)	EIRP (dBm)	EIRP (mW)	Polarization (H/V)
X	131997	1712.5	-12.43	36.45	24.02	252.35	H
	132322	1745.0	-12.74	36.80	24.06	254.68	
	132647	1777.5	-13.29	36.94	23.65	231.74	
	131997	1712.5	-19.41	37.28	17.87	61.24	V
	132322	1745.0	-19.60	37.63	18.03	63.53	
	132647	1777.5	-19.92	37.64	17.72	59.16	
Channel Bandwidth: 5 MHz / 16QAM							
X	131997	1712.5	-13.46	36.45	22.99	199.07	H
	132322	1745.0	-13.77	36.80	23.03	200.91	
	132647	1777.5	-14.32	36.94	22.62	182.81	
	131997	1712.5	-20.44	37.28	16.84	48.31	V
	132322	1745.0	-20.63	37.63	17.00	50.12	
	132647	1777.5	-20.95	37.64	16.69	46.67	

Note: EIRP (dBm) = Reading (dBm) + Correction Factor (dB)

LTE Band 66							
Channel Bandwidth: 10 MHz / QPSK							
Plane	Channel	Frequency (MHz)	Reading (dBm)	Correction Factor (dB)	EIRP (dBm)	EIRP (mW)	Polarization (H/V)
X	132022	1715.0	-12.88	36.64	23.76	237.68	H
	132322	1745.0	-13.00	36.80	23.80	239.88	
	132622	1775.0	-13.41	36.80	23.39	218.27	
	132022	1715.0	-19.83	37.44	17.61	57.68	V
	132322	1745.0	-19.86	37.63	17.77	59.84	
	132622	1775.0	-20.18	37.64	17.46	55.72	
Channel Bandwidth: 10 MHz / 16QAM							
X	132022	1715.0	-13.87	36.64	22.77	189.23	H
	132322	1745.0	-13.99	36.80	22.81	190.99	
	132622	1775.0	-14.40	36.80	22.40	173.78	
	132022	1715.0	-20.82	37.44	16.62	45.92	V
	132322	1745.0	-20.85	37.63	16.78	47.64	
	132622	1775.0	-21.17	37.64	16.47	44.36	

Note: EIRP (dBm) = Reading (dBm) + Correction Factor (dB)

LTE Band 66							
Channel Bandwidth: 15 MHz / QPSK							
Plane	Channel	Frequency (MHz)	Reading (dBm)	Correction Factor (dB)	EIRP (dBm)	EIRP (mW)	Polarization (H/V)
X	132047	1717.5	-13.00	36.45	23.45	221.31	H
	132322	1745.0	-13.31	36.80	23.49	223.36	
	132597	1772.5	-13.86	36.94	23.08	203.24	
	132047	1717.5	-19.98	37.28	17.30	53.70	V
	132322	1745.0	-20.17	37.63	17.46	55.72	
	132597	1772.5	-20.49	37.64	17.15	51.88	
Channel Bandwidth: 15 MHz / 16QAM							
X	132047	1717.5	-14.02	36.45	22.43	174.98	H
	132322	1745.0	-14.33	36.80	22.47	176.60	
	132597	1772.5	-14.88	36.94	22.06	160.69	
	132047	1717.5	-21.00	37.28	16.28	42.46	V
	132322	1745.0	-21.19	37.63	16.44	44.06	
	132597	1772.5	-21.51	37.64	16.13	41.02	

Note: EIRP (dBm) = Reading (dBm) + Correction Factor (dB)

LTE Band 66							
Channel Bandwidth: 20 MHz / QPSK							
Plane	Channel	Frequency (MHz)	Reading (dBm)	Correction Factor (dB)	EIRP (dBm)	EIRP (mW)	Polarization (H/V)
X	132072	1720.0	-13.27	36.45	23.18	207.97	H
	132322	1745.0	-13.58	36.80	23.22	209.89	
	132572	1770.0	-14.13	36.94	22.81	190.99	
	132072	1720.0	-20.25	37.28	17.03	50.47	V
	132322	1745.0	-20.44	37.63	17.19	52.36	
	132572	1770.0	-20.76	37.64	16.88	48.75	
Channel Bandwidth: 20 MHz / 16QAM							
X	132072	1720.0	-14.26	36.45	22.19	165.58	H
	132322	1745.0	-14.57	36.80	22.23	167.11	
	132572	1770.0	-15.12	36.94	21.82	152.05	
	132072	1720.0	-21.24	37.28	16.04	40.18	V
	132322	1745.0	-21.43	37.63	16.20	41.69	
	132572	1770.0	-21.75	37.64	15.89	38.82	

Note: EIRP (dBm) = Reading (dBm) + Correction Factor (dB)

4.2 Modulation characteristics Measurement

4.2.1 Limits of Modulation characteristics

N/A

4.2.2 Test Procedure

Connect the EUT to Communication Simulator via the antenna connector, The frequency band is set as EUT supported Modulation and Channels, the EUT output is matched with 50 ohm load, the waveform quality and constellation of the EUT was tested.

4.2.3 Test Setup



4.2.4 Test Results

LTE Band 4

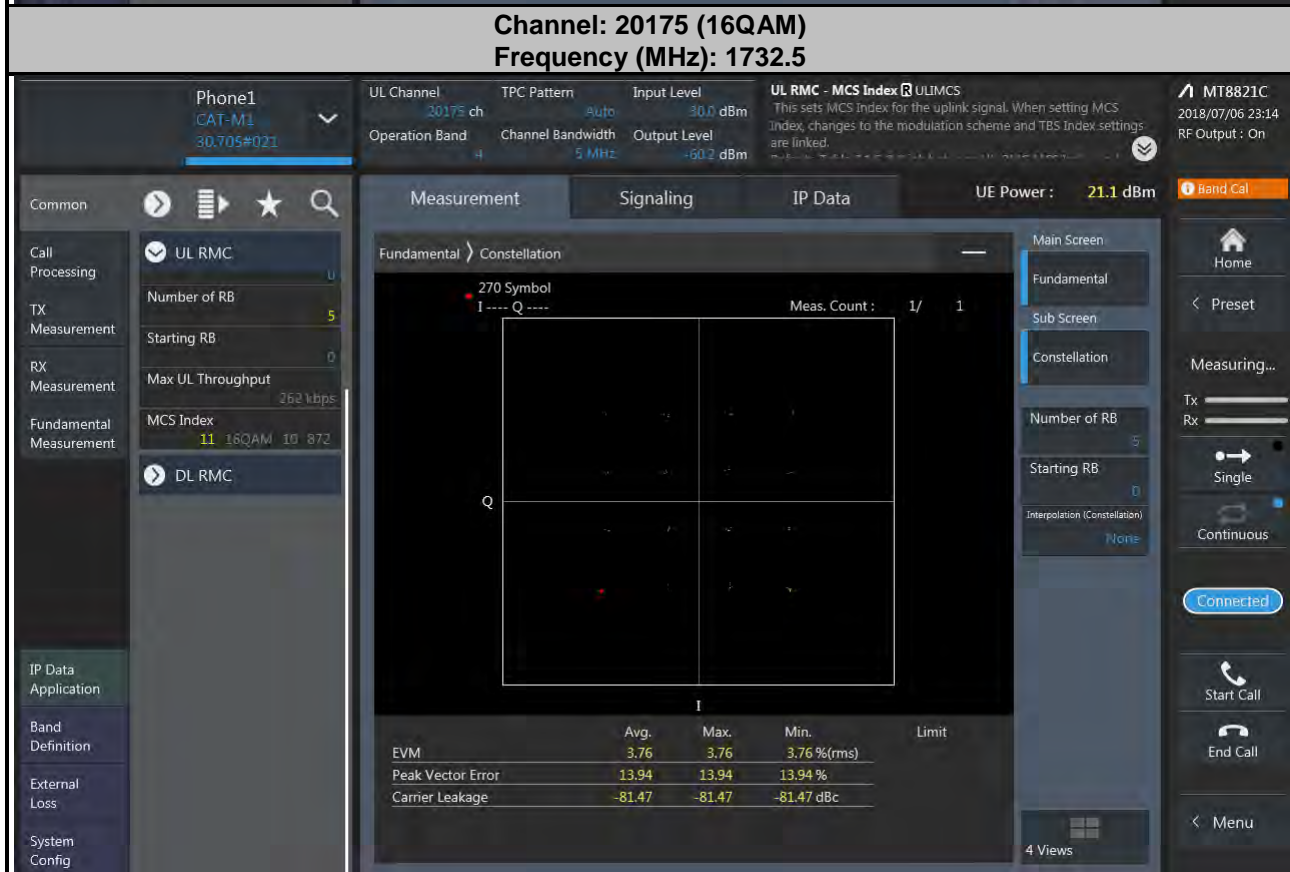
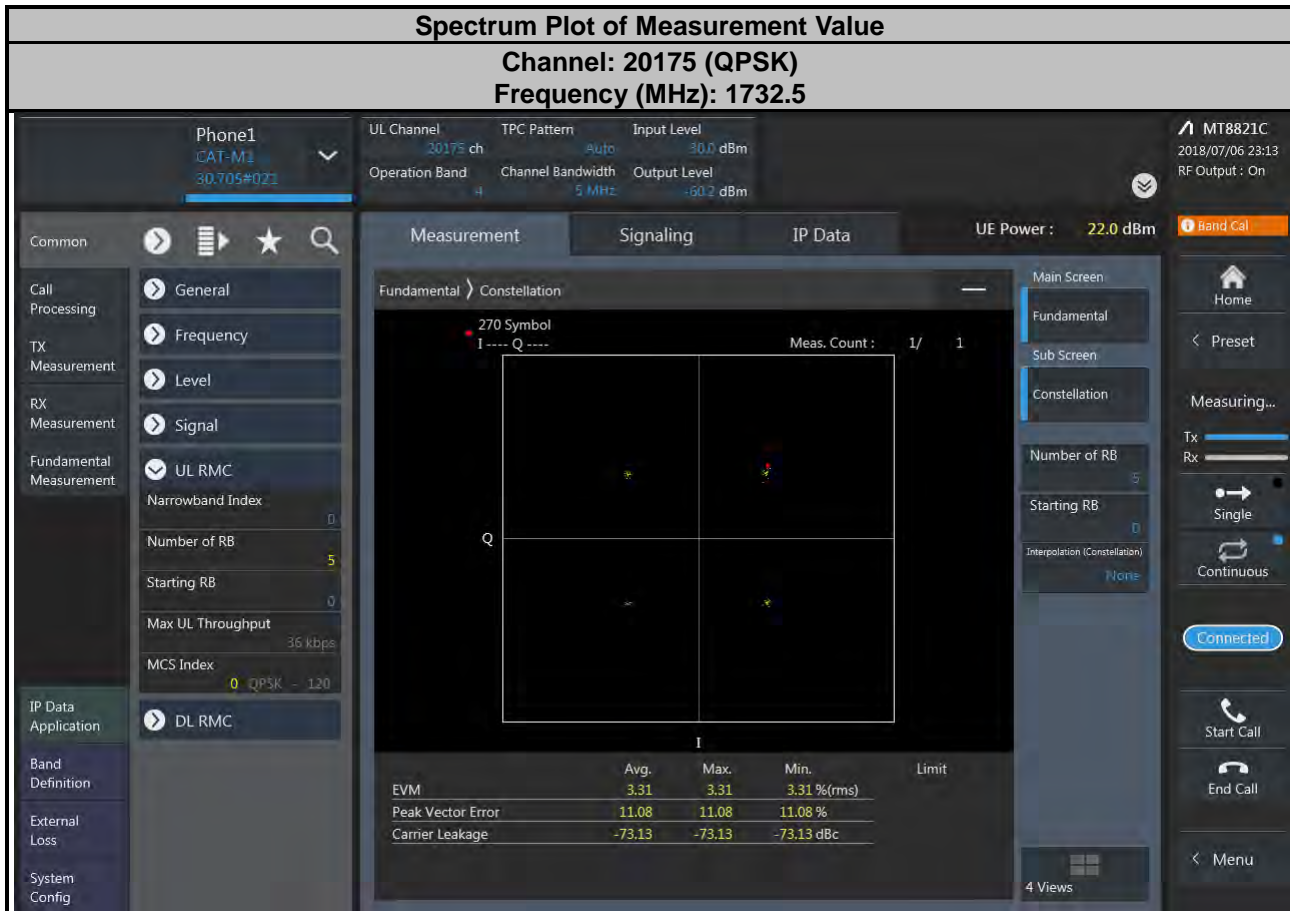

LTE Band 12

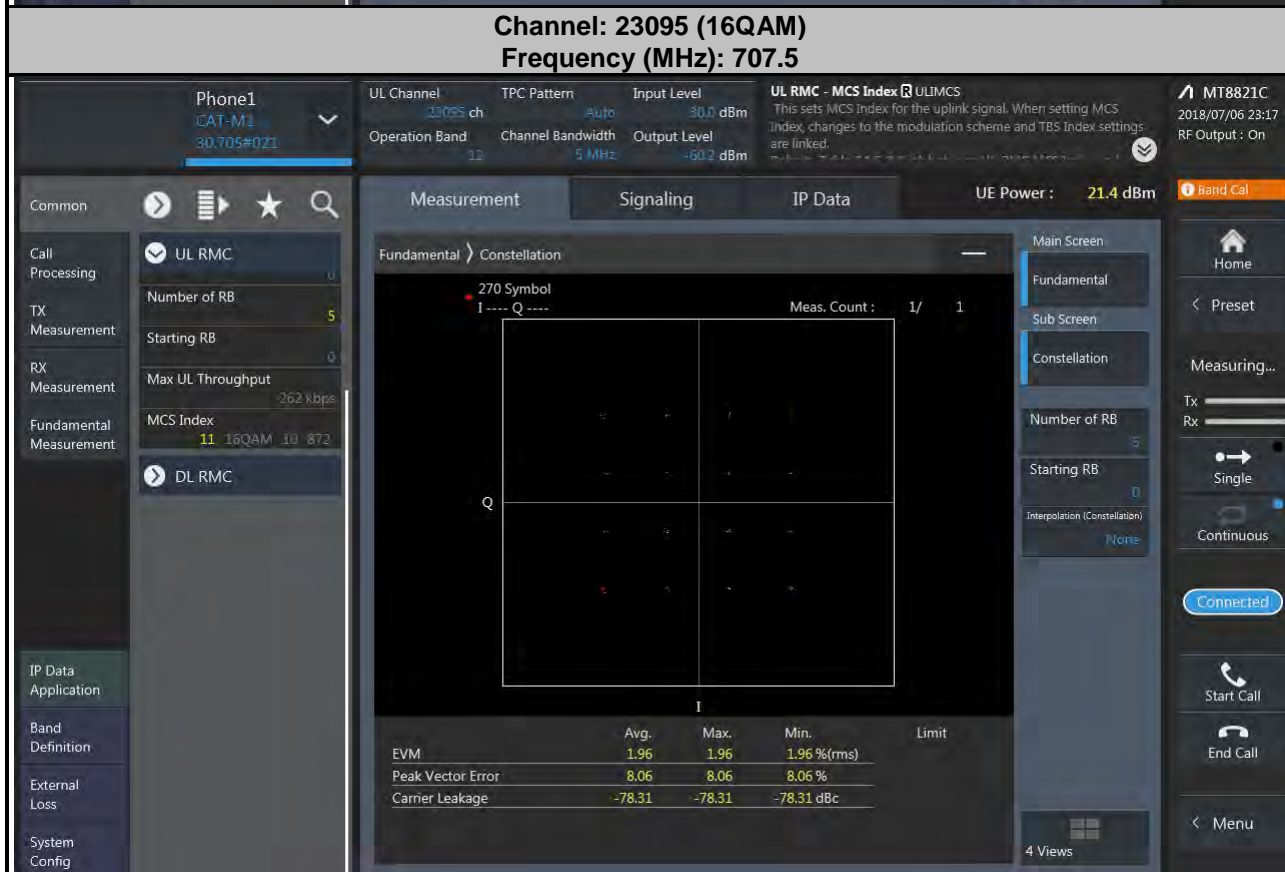
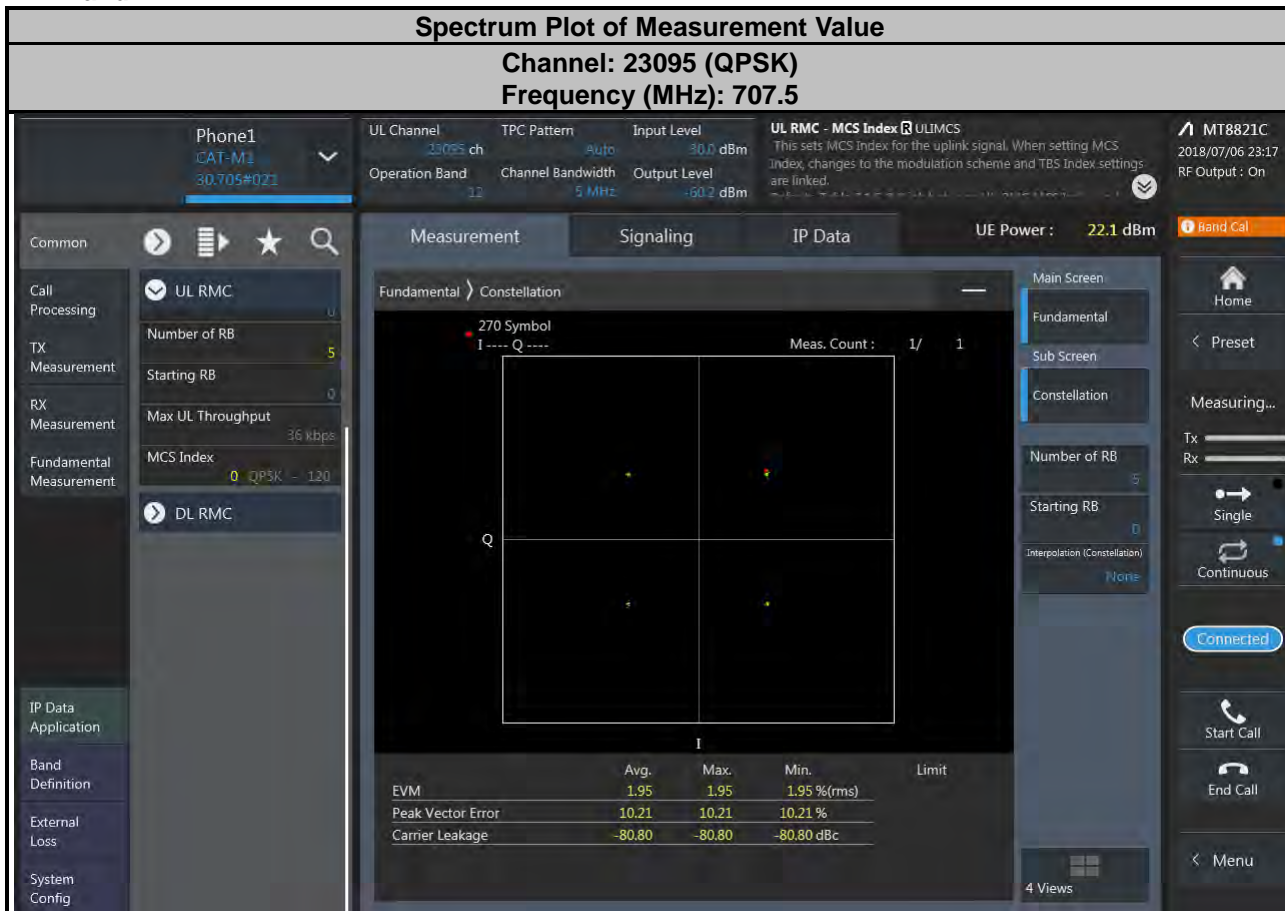

LTE Band 13

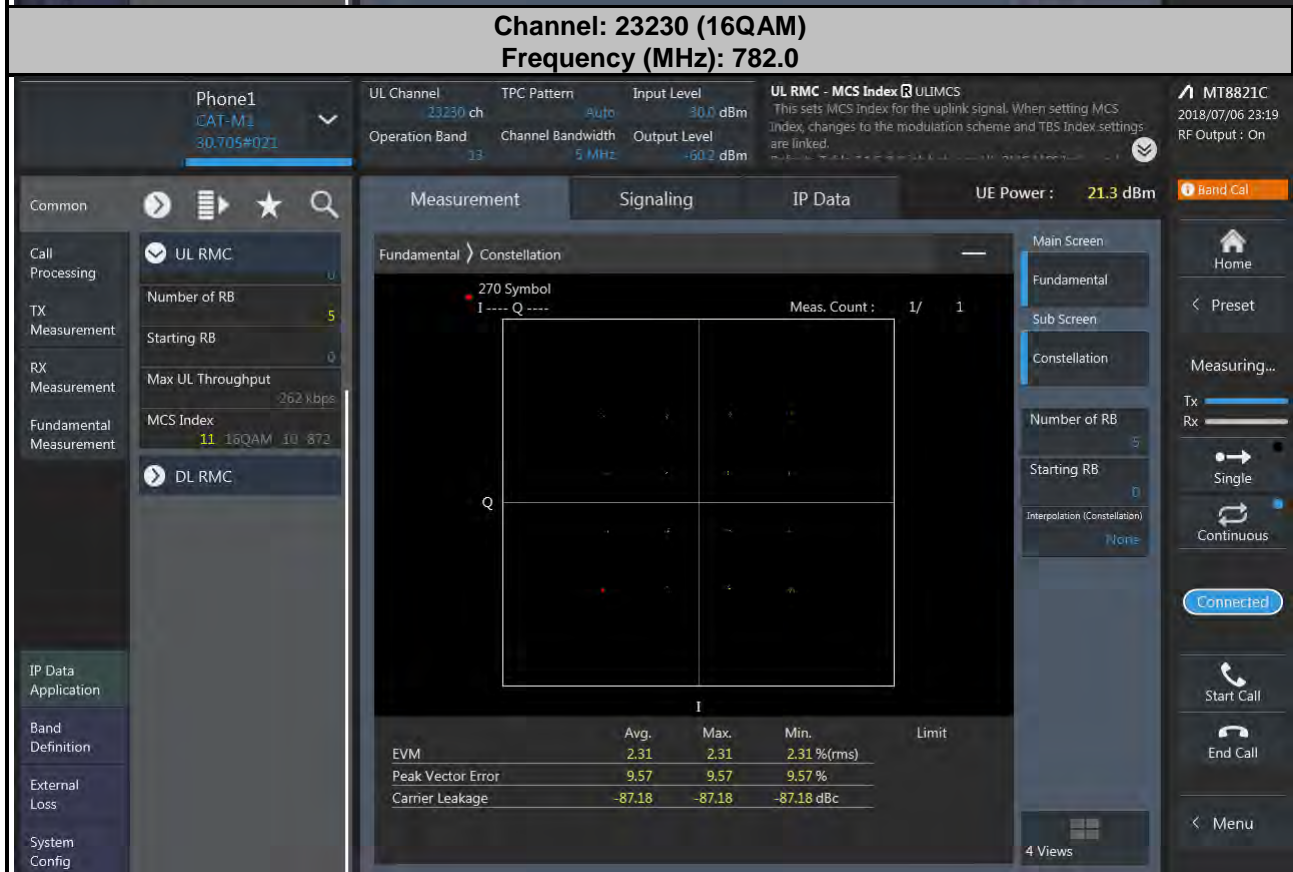
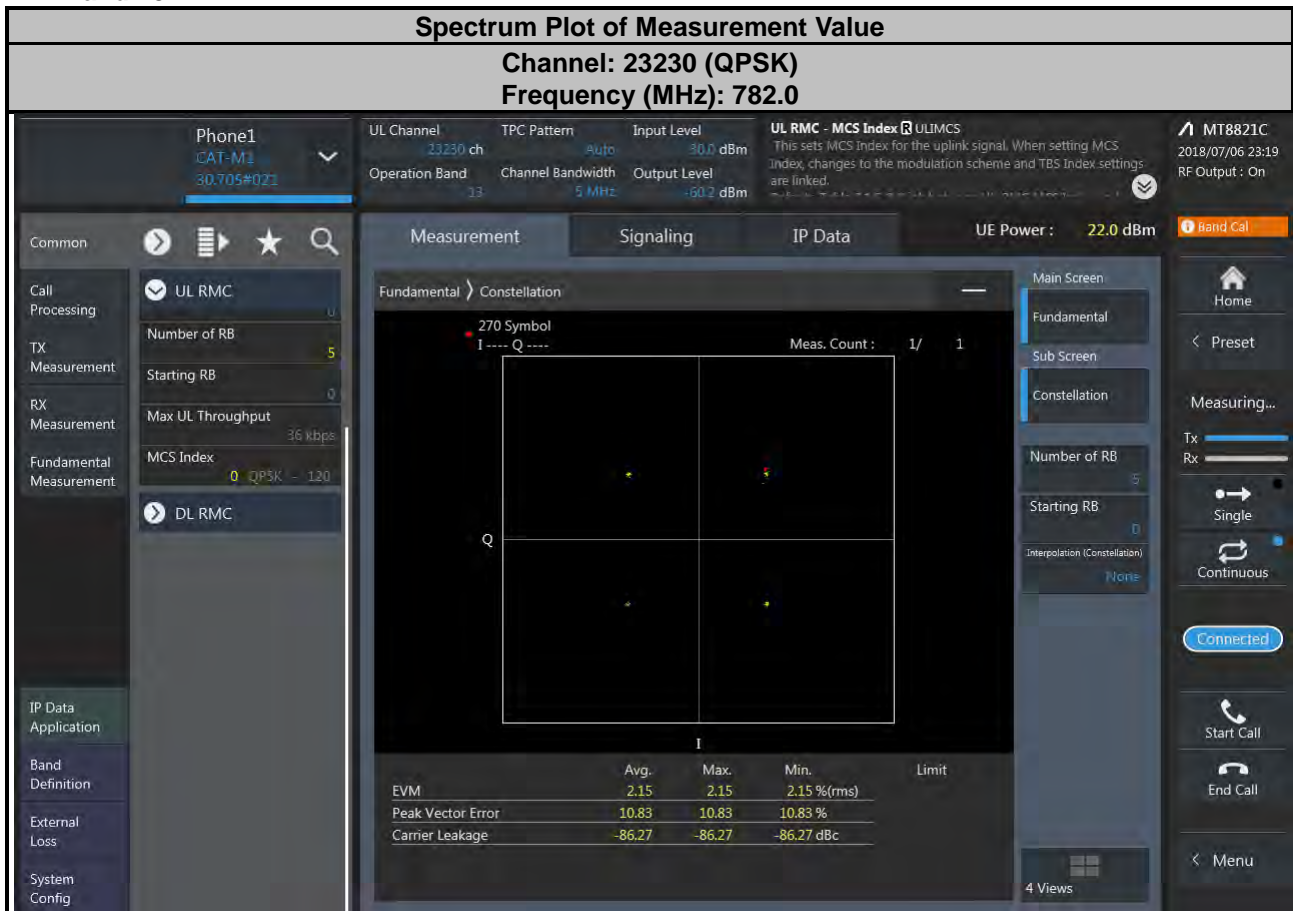

LTE Band 17

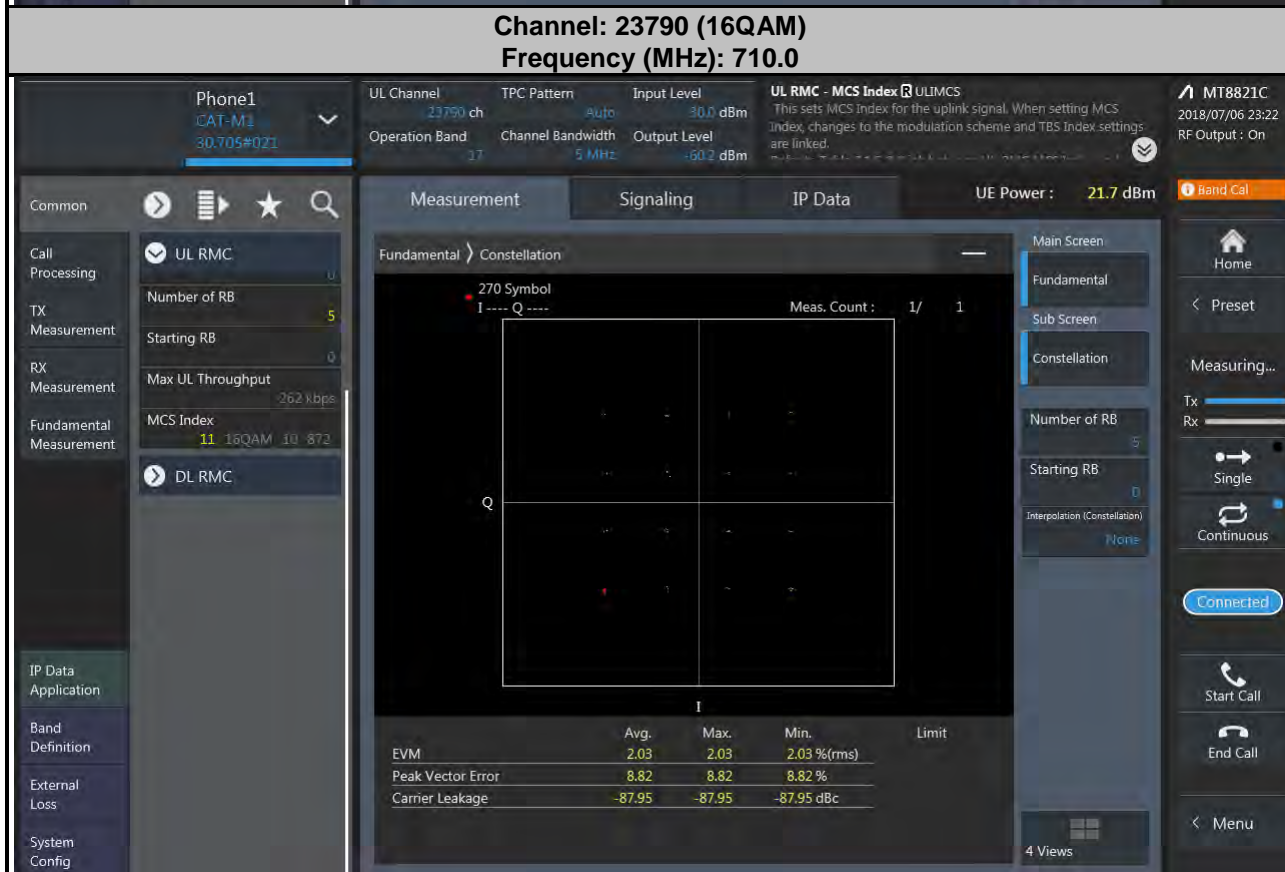
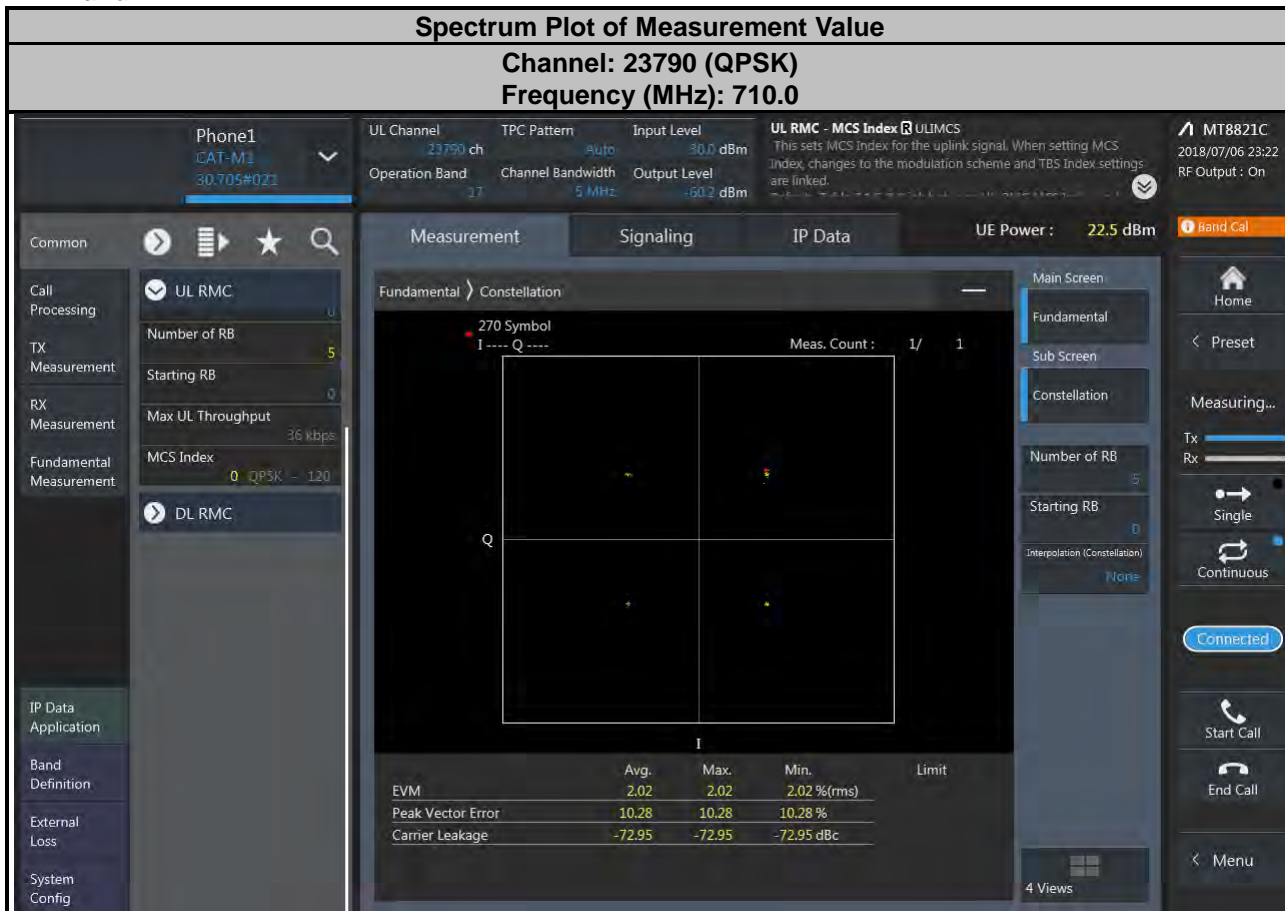

LTE Band 66

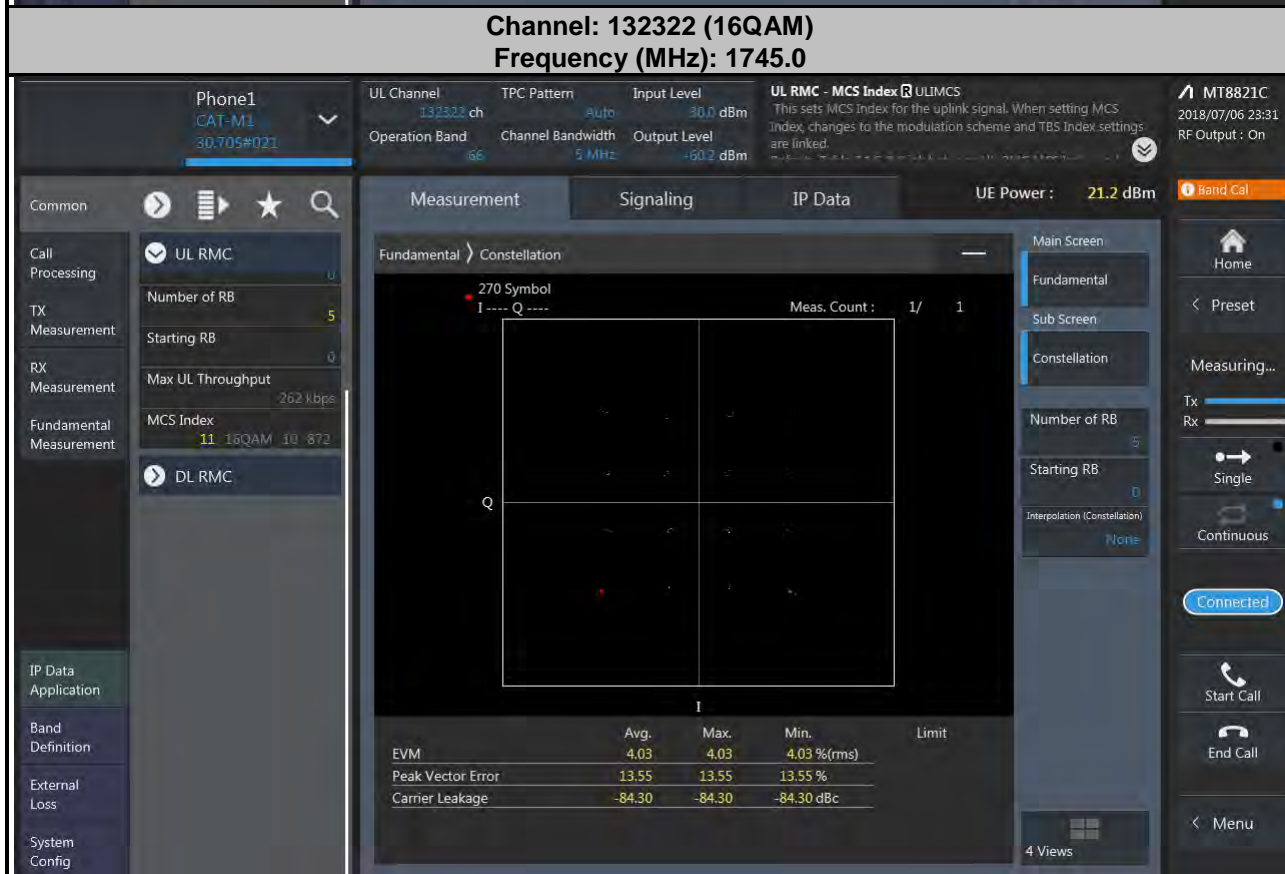
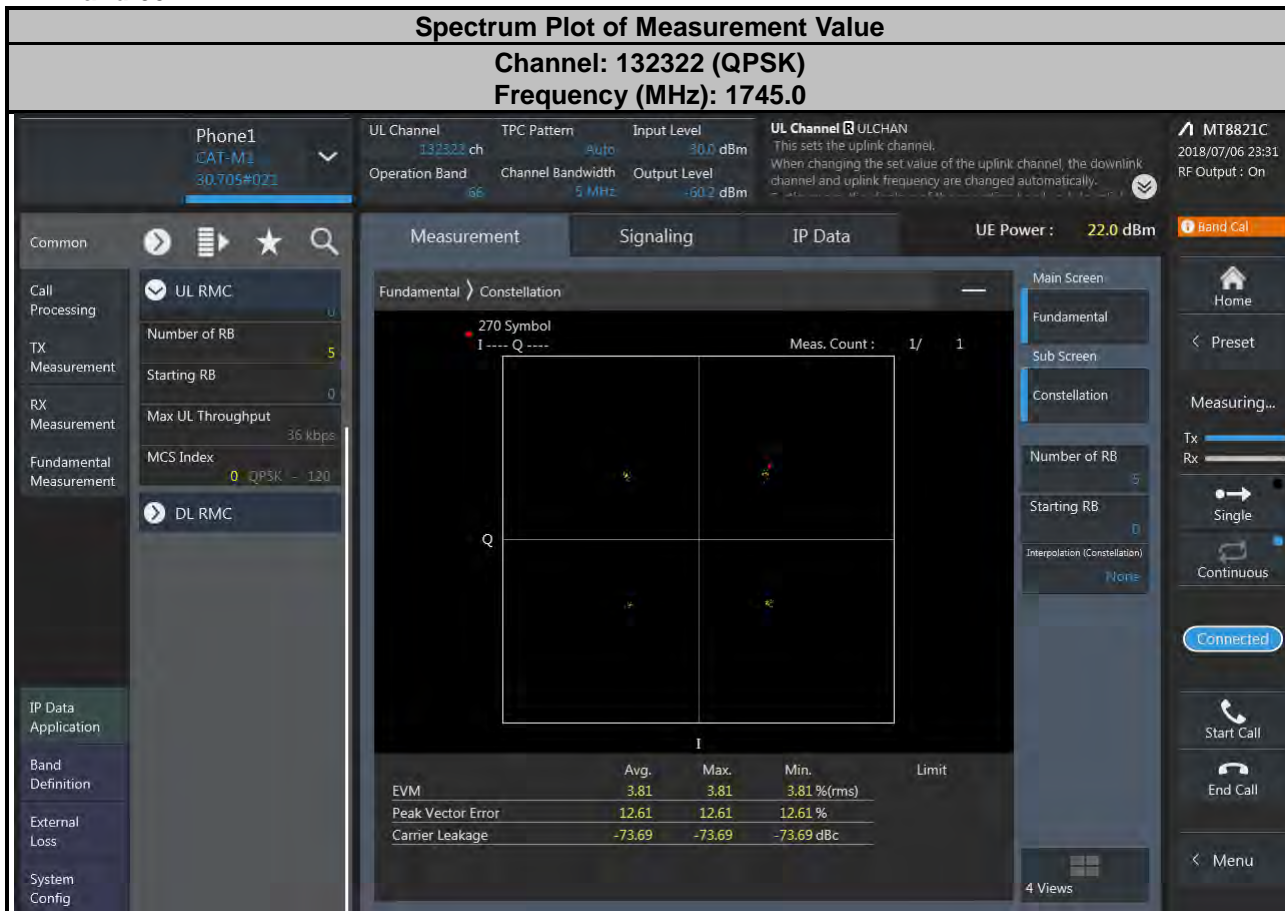

4.3 Frequency Stability Measurement

4.3.1 Limits of Frequency Stability Measurement

The frequency stability shall be sufficient to ensure that the fundamental emissions stay within the authorized bands of operation.

4.3.2 Test Procedure

- Device is placed at the oven room. The oven room could control the temperatures and humidity. Power warm up is at least 15 min and power applied should perform before recording frequency error.
- EUT is connected the external power supply to control the DC input power. The test voltage range is from minimum to maximum working voltage. Each step shall be record the frequency error rate.
- The temperature range step is 10 degrees in this test items. All temperature levels shall be hold the ± 0.5 °C during the measurement testing. The each temperature step shall be at least 0.5 hours, consider the EUT could be test under the stability condition.

Note: The frequency error was recorded frequency error from the communication simulator.

4.3.3 Test Setup

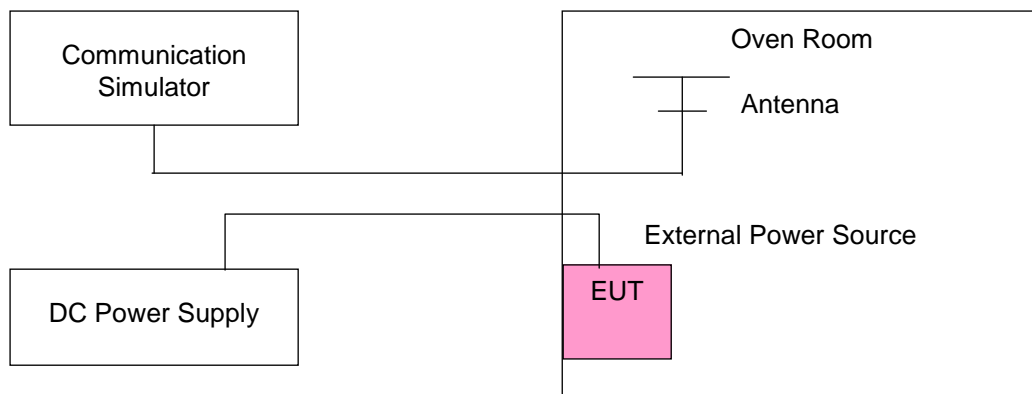

4.3.4 Test Results

Frequency Error vs. Voltage

Voltage (Volts)	LTE Band 4				Limit (ppm)
	Channel Bandwidth: 1.4 MHz				
	Low Channel		High Channel		
	Frequency (MHz)	Frequency Error (ppm)	Frequency (MHz)	Frequency Error (ppm)	
108	1710.700002	0.001	1754.300002	0.001	2.5
120	1710.700002	0.001	1754.300001	0.001	2.5
132	1710.700004	0.002	1754.300002	0.001	2.5

Note: The applicant defined the normal working voltage of the adapter is from 108 Vdc to 132 Vdc.

Frequency Error vs. Temperature

Temp. (°C)	LTE Band 4				Limit (ppm)
	Channel Bandwidth: 1.4 MHz				
	Low Channel		High Channel		
	Frequency (MHz)	Frequency Error (ppm)	Frequency (MHz)	Frequency Error (ppm)	
-30	1710.700002	0.001	1754.300002	0.001	2.5
-20	1710.700003	0.002	1754.300002	0.001	2.5
-10	1710.700001	0.001	1754.300004	0.002	2.5
0	1710.700002	0.001	1754.300003	0.002	2.5
10	1710.700003	0.002	1754.300003	0.002	2.5
20	1710.700002	0.001	1754.300002	0.001	2.5
30	1710.699997	-0.002	1754.299997	-0.002	2.5
40	1710.699997	-0.002	1754.299997	-0.002	2.5
50	1710.699996	-0.002	1754.299997	-0.002	2.5
60	1710.699997	-0.002	1754.299998	-0.001	2.5
70	1710.699996	-0.002	1754.299997	-0.002	2.5
80	1710.699996	-0.002	1754.299997	-0.002	2.5
85	1710.699998	-0.001	1754.299998	-0.001	2.5

Frequency Error vs. Voltage

Voltage (Volts)	LTE Band 4				Limit (ppm)
	Channel Bandwidth: 3 MHz				
	Low Channel		High Channel		
	Frequency (MHz)	Frequency Error (ppm)	Frequency (MHz)	Frequency Error (ppm)	
120	1711.500002	0.001	1753.500004	0.002	2.5
108	1711.500002	0.001	1753.500002	0.001	2.5
132	1711.500002	0.001	1753.500002	0.001	2.5

Note: The applicant defined the normal working voltage of the adapter is from 108 Vac to 132 Vac.

Frequency Error vs. Temperature

Temp. (°C)	LTE Band 4				Limit (ppm)
	Channel Bandwidth: 3 MHz				
	Low Channel		High Channel		
	Frequency (MHz)	Frequency Error (ppm)	Frequency (MHz)	Frequency Error (ppm)	
-30	1711.500002	0.001	1753.500003	0.001	2.5
-20	1711.500002	0.001	1753.500003	0.002	2.5
-10	1711.500003	0.002	1753.500004	0.002	2.5
0	1711.500003	0.002	1753.500001	0.001	2.5
10	1711.500001	0.001	1753.500003	0.002	2.5
20	1711.500001	0.001	1753.500004	0.002	2.5
30	1711.499998	-0.001	1753.499998	-0.001	2.5
40	1711.499997	-0.002	1753.499998	-0.001	2.5
50	1711.499996	-0.002	1753.499999	-0.001	2.5
60	1711.499996	-0.002	1753.499999	-0.001	2.5
70	1711.499996	-0.002	1753.499998	-0.001	2.5
50	1711.499999	-0.001	1753.499997	-0.002	2.5
85	1711.499996	-0.002	1753.499996	-0.002	2.5

Frequency Error vs. Voltage

Voltage (Volts)	LTE Band 4				Limit (ppm)
	Channel Bandwidth: 5 MHz				
	Low Channel		High Channel		
	Frequency (MHz)	Frequency Error (ppm)	Frequency (MHz)	Frequency Error (ppm)	
120	1712.500003	0.002	1752.500003	0.002	2.5
108	1712.500002	0.001	1752.500004	0.002	2.5
132	1712.500003	0.002	1752.500003	0.002	2.5

Note: The applicant defined the normal working voltage of the adapter is from 108 Vac to 132 Vac.

Frequency Error vs. Temperature

Temp. (°C)	LTE Band 4				Limit (ppm)
	Channel Bandwidth: 5 MHz				
	Low Channel		High Channel		
	Frequency (MHz)	Frequency Error (ppm)	Frequency (MHz)	Frequency Error (ppm)	
-30	1712.500004	0.002	1752.500002	0.001	2.5
-20	1712.500004	0.002	1752.500004	0.002	2.5
-10	1712.500004	0.002	1752.500004	0.002	2.5
0	1712.500003	0.002	1752.500003	0.002	2.5
10	1712.500003	0.002	1752.500002	0.001	2.5
20	1712.500002	0.001	1752.500003	0.001	2.5
30	1712.499998	-0.001	1752.499997	-0.002	2.5
40	1712.499996	-0.002	1752.499999	-0.001	2.5
50	1712.499997	-0.002	1752.499998	-0.001	2.5
60	1712.499997	-0.002	1752.499996	-0.002	2.5
70	1712.499999	-0.001	1752.499999	-0.001	2.5
50	1712.499999	-0.001	1752.499999	-0.001	2.5
85	1712.499997	-0.002	1752.499997	-0.002	2.5

Frequency Error vs. Voltage

Voltage (Volts)	LTE Band 4				Limit (ppm)
	Channel Bandwidth: 10 MHz				
	Low Channel		High Channel		
	Frequency (MHz)	Frequency Error (ppm)	Frequency (MHz)	Frequency Error (ppm)	
120	1715.000002	0.001	1750.000003	0.002	2.5
108	1715.000002	0.001	1750.000003	0.002	2.5
132	1715.000003	0.002	1750.000003	0.001	2.5

Note: The applicant defined the normal working voltage of the adapter is from 108 Vac to 132 Vac.

Frequency Error vs. Temperature

Temp. (°C)	LTE Band 4				Limit (ppm)
	Channel Bandwidth: 10 MHz				
	Low Channel		High Channel		
	Frequency (MHz)	Frequency Error (ppm)	Frequency (MHz)	Frequency Error (ppm)	
-30	1715.000002	0.001	1750.000003	0.002	2.5
-20	1715.000003	0.002	1750.000001	0.001	2.5
-10	1715.000002	0.001	1750.000002	0.001	2.5
0	1715.000003	0.002	1750.000002	0.001	2.5
10	1715.000002	0.001	1750.000002	0.001	2.5
20	1715.000003	0.002	1750.000004	0.002	2.5
30	1714.999998	-0.001	1749.999996	-0.002	2.5
40	1714.999997	-0.002	1749.999999	-0.001	2.5
50	1714.999996	-0.002	1749.999999	-0.001	2.5
60	1714.999996	-0.002	1749.999996	-0.002	2.5
70	1714.999998	-0.001	1749.999997	-0.002	2.5
50	1714.999997	-0.002	1749.999997	-0.002	2.5
85	1714.999996	-0.002	1749.999996	-0.002	2.5

Frequency Error vs. Voltage

Voltage (Volts)	LTE Band 4				Limit (ppm)
	Channel Bandwidth: 15 MHz				
	Low Channel		High Channel		
	Frequency (MHz)	Frequency Error (ppm)	Frequency (MHz)	Frequency Error (ppm)	
120	1717.500002	0.001	1747.500002	0.001	2.5
108	1717.500002	0.001	1747.500003	0.002	2.5
132	1717.500004	0.002	1747.500002	0.001	2.5

Note: The applicant defined the normal working voltage of the adapter is from 108 Vac to 132 Vac.

Frequency Error vs. Temperature

Temp. (°C)	LTE Band 4				Limit (ppm)
	Channel Bandwidth: 15 MHz				
	Low Channel		High Channel		
	Frequency (MHz)	Frequency Error (ppm)	Frequency (MHz)	Frequency Error (ppm)	
-30	1717.500003	0.002	1747.500001	0.001	2.5
-20	1717.500002	0.001	1747.500003	0.002	2.5
-10	1717.500004	0.002	1747.500003	0.002	2.5
0	1717.500002	0.001	1747.500003	0.002	2.5
10	1717.500004	0.002	1747.500004	0.002	2.5
20	1717.500004	0.002	1747.500003	0.002	2.5
30	1717.499999	-0.001	1747.499997	-0.002	2.5
40	1717.499999	-0.001	1747.499997	-0.002	2.5
50	1717.499998	-0.001	1747.499996	-0.002	2.5
60	1717.499997	-0.002	1747.499996	-0.002	2.5
70	1717.499999	-0.001	1747.499997	-0.002	2.5
50	1717.499997	-0.002	1747.499999	-0.001	2.5
85	1717.499999	-0.001	1747.499997	-0.002	2.5

Frequency Error vs. Voltage

Voltage (Volts)	LTE Band 4				Limit (ppm)
	Channel Bandwidth: 20 MHz				
	Low Channel		High Channel		
	Frequency (MHz)	Frequency Error (ppm)	Frequency (MHz)	Frequency Error (ppm)	
120	1720.000003	0.002	1745.000004	0.002	2.5
108	1720.000004	0.002	1745.000003	0.002	2.5
132	1720.000001	0.001	1745.000002	0.001	2.5

Note: The applicant defined the normal working voltage of the adapter is from 108 Vac to 132 Vac.

Frequency Error vs. Temperature

Temp. (°C)	LTE Band 4				Limit (ppm)
	Channel Bandwidth: 20 MHz				
	Low Channel		High Channel		
	Frequency (MHz)	Frequency Error (ppm)	Frequency (MHz)	Frequency Error (ppm)	
-30	1720.000001	0.001	1745.000004	0.002	2.5
-20	1720.000004	0.002	1745.000002	0.001	2.5
-10	1720.000002	0.001	1745.000002	0.001	2.5
0	1720.000004	0.002	1745.000003	0.002	2.5
10	1720.000003	0.002	1745.000001	0.001	2.5
20	1720.000001	0.001	1745.000004	0.002	2.5
30	1719.999998	-0.001	1744.999999	-0.001	2.5
40	1719.999998	-0.001	1744.999999	-0.001	2.5
50	1719.999998	-0.001	1744.999999	-0.001	2.5
60	1719.999996	-0.002	1744.999998	-0.001	2.5
70	1719.999999	-0.001	1744.999996	-0.002	2.5
50	1719.999999	-0.001	1744.999997	-0.002	2.5
85	1719.999998	-0.001	1744.999998	-0.001	2.5

Frequency Error vs. Voltage

Voltage (Volts)	LTE Band 12				Limit (ppm)
	Channel Bandwidth: 1.4 MHz				
	Low Channel		High Channel		
	Frequency (MHz)	Frequency Error (ppm)	Frequency (MHz)	Frequency Error (ppm)	
120	699.700002	0.002	715.300003	0.004	2.5
108	699.700002	0.003	715.300003	0.004	2.5
132	699.700001	0.001	715.300004	0.006	2.5

Note: The applicant defined the normal working voltage of the adapter is from 108 Vac to 132 Vac.

Frequency Error vs. Temperature

Temp. (°C)	LTE Band 12				Limit (ppm)
	Channel Bandwidth: 1.4 MHz				
	Low Channel		High Channel		
	Frequency (MHz)	Frequency Error (ppm)	Frequency (MHz)	Frequency Error (ppm)	
-30	699.700002	0.002	715.300002	0.002	2.5
-20	699.700004	0.006	715.300003	0.004	2.5
-10	699.700002	0.003	715.300004	0.005	2.5
0	699.700001	0.002	715.300002	0.003	2.5
10	699.700003	0.004	715.300002	0.003	2.5
20	699.700002	0.003	715.300003	0.004	2.5
30	699.699998	-0.003	715.299998	-0.003	2.5
40	699.699998	-0.003	715.299998	-0.003	2.5
50	699.699999	-0.002	715.299999	-0.001	2.5
60	699.699997	-0.005	715.299996	-0.005	2.5
70	699.699997	-0.005	715.299998	-0.003	2.5
80	699.699996	-0.005	715.299998	-0.002	2.5
85	699.699997	-0.004	715.299999	-0.002	2.5

Frequency Error vs. Voltage

Voltage (Volts)	LTE Band 12				Limit (ppm)
	Channel Bandwidth: 3 MHz				
	Low Channel		High Channel		
	Frequency (MHz)	Frequency Error (ppm)	Frequency (MHz)	Frequency Error (ppm)	
120	700.500003	0.004	714.500004	0.005	2.5
108	700.500004	0.006	714.500003	0.004	2.5
132	700.500003	0.004	714.500003	0.004	2.5

Note: The applicant defined the normal working voltage of the adapter is from 108 Vac to 132 Vac.

Frequency Error vs. Temperature

Temp. (°C)	LTE Band 12				Limit (ppm)
	Channel Bandwidth: 3 MHz				
	Low Channel		High Channel		
	Frequency (MHz)	Frequency Error (ppm)	Frequency (MHz)	Frequency Error (ppm)	
-30	700.500002	0.003	714.500002	0.003	2.5
-20	700.500004	0.005	714.500002	0.003	2.5
-10	700.500002	0.003	714.500003	0.005	2.5
0	700.500002	0.003	714.500002	0.002	2.5
10	700.500001	0.002	714.500002	0.003	2.5
20	700.500003	0.005	714.500002	0.003	2.5
30	700.499996	-0.005	714.499997	-0.004	2.5
40	700.499998	-0.003	714.499998	-0.002	2.5
50	700.499998	-0.003	714.499998	-0.003	2.5
60	700.499997	-0.004	714.499996	-0.005	2.5
70	700.499999	-0.002	714.499998	-0.003	2.5
50	700.499998	-0.003	714.499998	-0.003	2.5
85	700.499997	-0.005	714.499998	-0.002	2.5

Frequency Error vs. Voltage

Voltage (Volts)	LTE Band 12				Limit (ppm)
	Channel Bandwidth: 5 MHz				
	Low Channel		High Channel		
	Frequency (MHz)	Frequency Error (ppm)	Frequency (MHz)	Frequency Error (ppm)	
120	701.500003	0.005	713.500001	0.002	2.5
108	701.500001	0.002	713.500001	0.002	2.5
132	701.500003	0.004	713.500002	0.003	2.5

Note: The applicant defined the normal working voltage of the adapter is from 108 Vac to 132 Vac.

Frequency Error vs. Temperature

Temp. (°C)	LTE Band 12				Limit (ppm)
	Channel Bandwidth: 5 MHz				
	Low Channel		High Channel		
	Frequency (MHz)	Frequency Error (ppm)	Frequency (MHz)	Frequency Error (ppm)	
-30	701.500001	0.002	713.500001	0.002	2.5
-20	701.500004	0.005	713.500001	0.001	2.5
-10	701.500004	0.005	713.500002	0.002	2.5
0	701.500004	0.005	713.500002	0.002	2.5
10	701.500003	0.005	713.500003	0.004	2.5
20	701.500004	0.006	713.500002	0.003	2.5
30	701.499999	-0.002	713.499997	-0.005	2.5
40	701.499998	-0.003	713.499996	-0.005	2.5
50	701.499996	-0.005	713.499998	-0.003	2.5
60	701.499998	-0.003	713.499997	-0.004	2.5
70	701.499999	-0.002	713.499998	-0.003	2.5
50	701.499996	-0.005	713.499996	-0.005	2.5
85	701.499997	-0.005	713.499998	-0.003	2.5

Frequency Error vs. Voltage

Voltage (Volts)	LTE Band 12				Limit (ppm)
	Channel Bandwidth: 10 MHz				
	Low Channel		High Channel		
	Frequency (MHz)	Frequency Error (ppm)	Frequency (MHz)	Frequency Error (ppm)	
120	704.000001	0.002	711.000002	0.002	2.5
108	704.000001	0.001	711.000004	0.005	2.5
132	704.000004	0.005	711.000002	0.003	2.5

Note: The applicant defined the normal working voltage of the adapter is from 108 Vac to 132 Vac.

Frequency Error vs. Temperature

Temp. (°C)	LTE Band 12				Limit (ppm)
	Channel Bandwidth: 10 MHz				
	Low Channel		High Channel		
	Frequency (MHz)	Frequency Error (ppm)	Frequency (MHz)	Frequency Error (ppm)	
-30	704.000003	0.005	711.000003	0.004	2.5
-20	704.000004	0.006	711.000003	0.005	2.5
-10	704.000003	0.004	711.000004	0.005	2.5
0	704.000001	0.001	711.000003	0.004	2.5
10	704.000002	0.003	711.000004	0.006	2.5
20	704.000003	0.004	711.000004	0.005	2.5
30	703.999998	-0.002	710.999998	-0.003	2.5
40	703.999998	-0.003	710.999996	-0.006	2.5
50	703.999998	-0.003	710.999997	-0.005	2.5
60	703.999998	-0.003	710.999997	-0.005	2.5
70	703.999999	-0.002	710.999997	-0.004	2.5
50	703.999997	-0.005	710.999997	-0.004	2.5
85	703.999997	-0.004	710.999999	-0.001	2.5

Frequency Error vs. Voltage

Voltage (Volts)	LTE Band 13				Limit (ppm)
	Channel Bandwidth: 5 MHz				
	Low Channel		High Channel		
	Frequency (MHz)	Frequency Error (ppm)	Frequency (MHz)	Frequency Error (ppm)	
120	779.500001	0.001	784.500003	0.004	2.5
108	779.500004	0.005	784.500003	0.003	2.5
132	779.500003	0.004	784.500003	0.003	2.5

Note: The applicant defined the normal working voltage of the adapter is from 108 Vac to 132 Vac.

Frequency Error vs. Temperature

Temp. (°C)	LTE Band 13				Limit (ppm)
	Channel Bandwidth: 5 MHz				
	Low Channel		High Channel		
	Frequency (MHz)	Frequency Error (ppm)	Frequency (MHz)	Frequency Error (ppm)	
-30	779.500001	0.001	784.500002	0.002	2.5
-20	779.500002	0.003	784.500004	0.005	2.5
-10	779.500002	0.002	784.500003	0.004	2.5
0	779.500002	0.002	784.500004	0.005	2.5
10	779.500004	0.005	784.500002	0.002	2.5
20	779.500001	0.002	784.500003	0.003	2.5
30	779.499996	-0.005	784.499996	-0.005	2.5
40	779.499997	-0.004	784.499997	-0.004	2.5
50	779.499997	-0.004	784.499996	-0.005	2.5
60	779.499999	-0.002	784.499999	-0.001	2.5
70	779.499998	-0.002	784.499998	-0.003	2.5
80	779.499998	-0.003	784.499997	-0.003	2.5
85	779.499998	-0.003	784.499997	-0.004	2.5

Frequency Error vs. Voltage

Voltage (Volts)	LTE Band 13		Limit (ppm)
	Channel Bandwidth: 10 MHz		
	Frequency (MHz)	Frequency Error (ppm)	
120	782.000002	0.003	2.5
108	782.000004	0.005	2.5
132	782.000002	0.003	2.5

Note: The applicant defined the normal working voltage of the adapter is from 108 Vac to 132 Vac.

Frequency Error vs. Temperature

Temp. (°C)	LTE Band 13		Limit (ppm)
	Channel Bandwidth: 10 MHz		
	Frequency (MHz)	Frequency Error (ppm)	
-30	782.000002	0.003	2.5
-20	782.000001	0.001	2.5
-10	782.000003	0.004	2.5
0	782.000004	0.005	2.5
10	782.000002	0.002	2.5
20	782.000004	0.005	2.5
30	781.999998	-0.003	2.5
40	781.999997	-0.004	2.5
50	781.999999	-0.002	2.5
60	781.999999	-0.002	2.5
70	781.999996	-0.005	2.5
50	781.999998	-0.003	2.5
85	781.999999	-0.001	2.5

Frequency Error vs. Voltage

Voltage (Volts)	LTE Band 17				Limit (ppm)
	Channel Bandwidth: 5 MHz				
	Low Channel		High Channel		
	Frequency (MHz)	Frequency Error (ppm)	Frequency (MHz)	Frequency Error (ppm)	
120	706.500002	0.002	713.500003	0.004	2.5
108	706.500001	0.002	713.500002	0.002	2.5
132	706.500003	0.005	713.500004	0.005	2.5

Note: The applicant defined the normal working voltage of the adapter is from 108 Vac to 132 Vac.

Frequency Error vs. Temperature

Temp. (°C)	LTE Band 17				Limit (ppm)
	Channel Bandwidth: 5 MHz				
	Low Channel		High Channel		
	Frequency (MHz)	Frequency Error (ppm)	Frequency (MHz)	Frequency Error (ppm)	
-30	706.500003	0.004	713.500001	0.002	2.5
-20	706.500002	0.003	713.500001	0.002	2.5
-10	706.500004	0.005	713.500002	0.002	2.5
0	706.500004	0.005	713.500002	0.003	2.5
10	706.500003	0.005	713.500003	0.004	2.5
20	706.500003	0.005	713.500003	0.004	2.5
30	706.499999	-0.002	713.499997	-0.004	2.5
40	706.499997	-0.005	713.499997	-0.004	2.5
50	706.499997	-0.005	713.499998	-0.002	2.5
60	706.499998	-0.003	713.499997	-0.005	2.5
70	706.499998	-0.004	713.499997	-0.004	2.5
80	706.499998	-0.004	713.499999	-0.001	2.5
85	706.499996	-0.005	713.499999	-0.001	2.5

Frequency Error vs. Voltage

Voltage (Volts)	LTE Band 17				Limit (ppm)
	Channel Bandwidth: 10 MHz				
	Low Channel		High Channel		
	Frequency (MHz)	Frequency Error (ppm)	Frequency (MHz)	Frequency Error (ppm)	
120	709.000003	0.004	711.000001	0.001	2.5
108	709.000003	0.004	711.000001	0.002	2.5
132	709.000002	0.002	711.000001	0.002	2.5

Note: The applicant defined the normal working voltage of the adapter is from 108 Vac to 132 Vac.

Frequency Error vs. Temperature

Temp. (°C)	LTE Band 17				Limit (ppm)
	Channel Bandwidth: 10 MHz				
	Low Channel		High Channel		
	Frequency (MHz)	Frequency Error (ppm)	Frequency (MHz)	Frequency Error (ppm)	
-30	709.000004	0.005	711.000004	0.005	2.5
-20	709.000001	0.002	711.000002	0.002	2.5
-10	709.000003	0.004	711.000001	0.002	2.5
0	709.000003	0.004	711.000002	0.002	2.5
10	709.000002	0.003	711.000002	0.002	2.5
20	709.000003	0.004	711.000003	0.005	2.5
30	708.999996	-0.005	710.999999	-0.002	2.5
40	708.999998	-0.003	710.999997	-0.005	2.5
50	708.999999	-0.002	710.999999	-0.002	2.5
60	708.999998	-0.003	710.999999	-0.002	2.5
70	708.999998	-0.004	710.999998	-0.003	2.5
50	708.999998	-0.003	710.999997	-0.004	2.5
85	708.999997	-0.005	710.999997	-0.004	2.5

Frequency Error vs. Voltage

Voltage (Volts)	LTE Band 66				Limit (ppm)
	Channel Bandwidth: 1.4 MHz				
	Low Channel		High Channel		
	Frequency (MHz)	Frequency Error (ppm)	Frequency (MHz)	Frequency Error (ppm)	
120	1710.700004	0.002	1779.300004	0.002	2.5
108	1710.700004	0.002	1779.300002	0.001	2.5
132	1710.700004	0.002	1779.300004	0.002	2.5

Note: The applicant defined the normal working voltage of the adapter is from 108 Vac to 132 Vac.

Frequency Error vs. Temperature

Temp. (°C)	LTE Band 66				Limit (ppm)
	Channel Bandwidth: 1.4 MHz				
	Low Channel		High Channel		
	Frequency (MHz)	Frequency Error (ppm)	Frequency (MHz)	Frequency Error (ppm)	
-30	1710.700002	0.001	1779.300003	0.002	2.5
-20	1710.700002	0.001	1779.300001	0.001	2.5
-10	1710.700004	0.002	1779.300001	0.001	2.5
0	1710.700001	0.001	1779.300003	0.001	2.5
10	1710.700001	0.001	1779.300001	0.001	2.5
20	1710.700004	0.002	1779.300001	0.001	2.5
30	1710.699998	-0.001	1779.299996	-0.002	2.5
40	1710.699998	-0.001	1779.299997	-0.001	2.5
50	1710.699997	-0.002	1779.299996	-0.002	2.5
60	1710.699999	-0.001	1779.299999	-0.001	2.5
70	1710.699998	-0.001	1779.299997	-0.002	2.5
80	1710.699996	-0.002	1779.299996	-0.002	2.5
85	1710.699997	-0.002	1779.299999	-0.001	2.5

Frequency Error vs. Voltage

Voltage (Volts)	LTE Band 66				Limit (ppm)
	Channel Bandwidth: 3 MHz				
	Low Channel		High Channel		
	Frequency (MHz)	Frequency Error (ppm)	Frequency (MHz)	Frequency Error (ppm)	
120	1711.500003	0.002	1778.500004	0.002	2.5
108	1711.500001	0.001	1778.500003	0.002	2.5
132	1711.500001	0.001	1778.500004	0.002	2.5

Note: The applicant defined the normal working voltage of the adapter is from 108 Vac to 132 Vac.

Frequency Error vs. Temperature

Temp. (°C)	LTE Band 66				Limit (ppm)
	Channel Bandwidth: 3 MHz				
	Low Channel		High Channel		
	Frequency (MHz)	Frequency Error (ppm)	Frequency (MHz)	Frequency Error (ppm)	
-30	1711.500002	0.001	1778.500002	0.001	2.5
-20	1711.500001	0.001	1778.500003	0.002	2.5
-10	1711.500002	0.001	1778.500002	0.001	2.5
0	1711.500003	0.002	1778.500002	0.001	2.5
10	1711.500003	0.002	1778.500003	0.002	2.5
20	1711.500003	0.002	1778.500002	0.001	2.5
30	1711.499997	-0.002	1778.499996	-0.002	2.5
40	1711.499997	-0.002	1778.499998	-0.001	2.5
50	1711.499999	-0.001	1778.499999	-0.001	2.5
60	1711.499997	-0.002	1778.499999	-0.001	2.5
70	1711.499999	-0.001	1778.499997	-0.002	2.5
50	1711.499997	-0.002	1778.499999	-0.001	2.5
85	1711.499998	-0.001	1778.499996	-0.002	2.5

Frequency Error vs. Voltage

Voltage (Volts)	LTE Band 66				Limit (ppm)
	Channel Bandwidth: 5 MHz				
	Low Channel		High Channel		
	Frequency (MHz)	Frequency Error (ppm)	Frequency (MHz)	Frequency Error (ppm)	
120	1712.500001	0.001	1777.500003	0.002	2.5
108	1712.500002	0.001	1777.500001	0.001	2.5
132	1712.500002	0.001	1777.500002	0.001	2.5

Note: The applicant defined the normal working voltage of the adapter is from 108 Vac to 132 Vac.

Frequency Error vs. Temperature

Temp. (°C)	LTE Band 66				Limit (ppm)
	Channel Bandwidth: 5 MHz				
	Low Channel		High Channel		
	Frequency (MHz)	Frequency Error (ppm)	Frequency (MHz)	Frequency Error (ppm)	
-30	1712.500002	0.001	1777.500003	0.002	2.5
-20	1712.500003	0.002	1777.500002	0.001	2.5
-10	1712.500004	0.002	1777.500003	0.001	2.5
0	1712.500002	0.001	1777.500002	0.001	2.5
10	1712.500001	0.001	1777.500002	0.001	2.5
20	1712.500003	0.002	1777.500002	0.001	2.5
30	1712.499998	-0.001	1777.499999	-0.001	2.5
40	1712.499997	-0.002	1777.499999	-0.001	2.5
50	1712.499997	-0.002	1777.499997	-0.002	2.5
60	1712.499996	-0.002	1777.499998	-0.001	2.5
70	1712.499999	-0.001	1777.499996	-0.002	2.5
50	1712.499997	-0.002	1777.499998	-0.001	2.5
85	1712.499999	-0.001	1777.499999	-0.001	2.5

Frequency Error vs. Voltage

Voltage (Volts)	LTE Band 66				Limit (ppm)
	Channel Bandwidth: 10 MHz				
	Low Channel		High Channel		
	Frequency (MHz)	Frequency Error (ppm)	Frequency (MHz)	Frequency Error (ppm)	
120	1715.000004	0.002	1775.000004	0.002	2.5
108	1715.000001	0.001	1775.000002	0.001	2.5
132	1715.000003	0.002	1775.000002	0.001	2.5

Note: The applicant defined the normal working voltage of the adapter is from 108 Vac to 132 Vac.

Frequency Error vs. Temperature

Temp. (°C)	LTE Band 66				Limit (ppm)
	Channel Bandwidth: 10 MHz				
	Low Channel		High Channel		
	Frequency (MHz)	Frequency Error (ppm)	Frequency (MHz)	Frequency Error (ppm)	
-30	3.30	1715.000003	1775.000003	0.002	2.5
-20	2.80	1715.000003	1775.000003	0.002	2.5
-10	1.00	1715.000001	1775.000002	0.001	2.5
0	1.20	1715.000001	1775.000003	0.002	2.5
10	3.70	1715.000004	1775.000002	0.001	2.5
20	1.80	1715.000002	1775.000004	0.002	2.5
30	-1.60	1714.999998	1774.999997	-0.002	2.5
40	-3.90	1714.999996	1774.999997	-0.002	2.5
50	-3.40	1714.999997	1774.999997	-0.002	2.5
60	-1.40	1714.999999	1774.999997	-0.002	2.5
70	-3.10	1714.999997	1774.999998	-0.001	2.5
50	-2.60	1714.999997	1774.999996	-0.002	2.5
85	-2.20	1714.999998	1774.999998	-0.001	2.5

Frequency Error vs. Voltage

Voltage (Volts)	LTE Band 66				Limit (ppm)
	Channel Bandwidth: 15 MHz				
	Low Channel		High Channel		
	Frequency (MHz)	Frequency Error (ppm)	Frequency (MHz)	Frequency Error (ppm)	
120	1717.500002	0.001	1772.500001	0.001	2.5
108	1717.500002	0.001	1772.500004	0.002	2.5
132	1717.500001	0.001	1772.500004	0.002	2.5

Note: The applicant defined the normal working voltage of the adapter is from 108 Vac to 132 Vac.

Frequency Error vs. Temperature

Temp. (°C)	LTE Band 66				Limit (ppm)
	Channel Bandwidth: 15 MHz				
	Low Channel		High Channel		
	Frequency (MHz)	Frequency Error (ppm)	Frequency (MHz)	Frequency Error (ppm)	
-30	1717.500004	0.002	1772.500004	0.002	2.5
-20	1717.500004	0.002	1772.500004	0.002	2.5
-10	1717.500003	0.002	1772.500003	0.002	2.5
0	1717.500002	0.001	1772.500002	0.001	2.5
10	1717.500002	0.001	1772.500002	0.001	2.5
20	1717.500002	0.001	1772.500002	0.001	2.5
30	1717.499997	-0.002	1772.499997	-0.002	2.5
40	1717.499999	-0.001	1772.499997	-0.001	2.5
50	1717.499998	-0.001	1772.499999	-0.001	2.5
60	1717.499999	-0.001	1772.499996	-0.002	2.5
70	1717.499997	-0.002	1772.499997	-0.002	2.5
50	1717.499997	-0.002	1772.499997	-0.001	2.5
85	1717.499997	-0.002	1772.499999	-0.001	2.5

Frequency Error vs. Voltage

Voltage (Volts)	LTE Band 66				Limit (ppm)
	Channel Bandwidth: 20 MHz				
	Low Channel		High Channel		
	Frequency (MHz)	Frequency Error (ppm)	Frequency (MHz)	Frequency Error (ppm)	
120	1720.000002	0.001	1770.000002	0.001	2.5
108	1720.000002	0.001	1770.000002	0.001	2.5
132	1720.000003	0.002	1770.000003	0.002	2.5

Note: The applicant defined the normal working voltage of the adapter is from 108 Vac to 132 Vac.

Frequency Error vs. Temperature

Temp. (°C)	LTE Band 66				Limit (ppm)
	Channel Bandwidth: 20 MHz				
	Low Channel		High Channel		
	Frequency (MHz)	Frequency Error (ppm)	Frequency (MHz)	Frequency Error (ppm)	
-30	1720.000003	0.002	1770.000003	0.002	2.5
-20	1720.000003	0.002	1770.000003	0.001	2.5
-10	1720.000004	0.002	1770.000002	0.001	2.5
0	1720.000002	0.001	1770.000002	0.001	2.5
10	1720.000004	0.002	1770.000003	0.002	2.5
20	1720.000004	0.002	1770.000001	0.001	2.5
30	1719.999997	-0.002	1769.999997	-0.002	2.5
40	1719.999998	-0.001	1769.999998	-0.001	2.5
50	1719.999997	-0.002	1769.999996	-0.002	2.5
60	1719.999996	-0.002	1769.999997	-0.002	2.5
70	1719.999996	-0.002	1769.999998	-0.001	2.5
50	1719.999996	-0.002	1769.999998	-0.001	2.5
85	1719.999996	-0.002	1769.999999	-0.001	2.5

4.4 Occupied Bandwidth Measurement

4.4.1 Limits of Occupied Bandwidth Measurement

The width of a frequency band such that, below the lower and above the upper frequency limits, the mean powers emitted are each equal to a specified percentage 0.5 % of the total mean power of a given emission.

4.4.2 Test Procedure

- The conducted occupied bandwidth used the power splitter via EUT RF power connector between simulation base station and spectrum analyzer.
- Use OBW measurement function of Spectrum analyzer to measure 99 % occupied bandwidth.

4.4.3 Test Setup

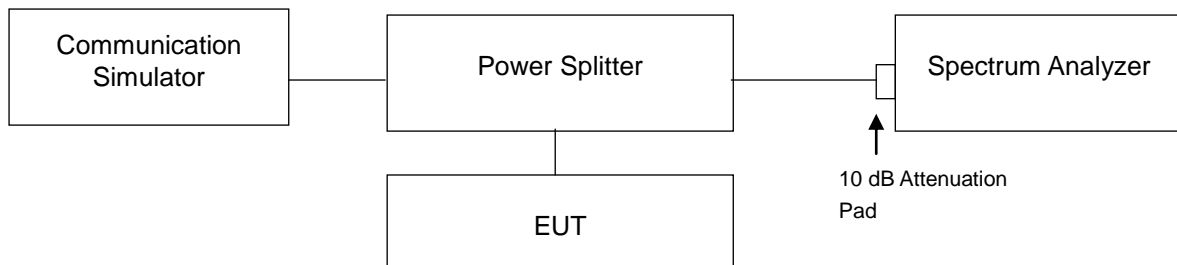

4.4.4 Test Result

LTE Band 4							
Channel Bandwidth: 1.4 MHz				Channel Bandwidth: 3 MHz			
Channel	Frequency (MHz)	99 % Occupied Bandwidth (MHz)		Channel	Frequency (MHz)	99 % Occupied Bandwidth (MHz)	
		QPSK	16QAM			QPSK	16QAM
19957	1710.7	1.086	0.915	19965	1711.5	1.080	0.916
20175	1732.5	1.090	0.913	20175	1732.5	1.086	0.920
20393	1754.3	1.091	0.914	20385	1753.5	1.087	0.922

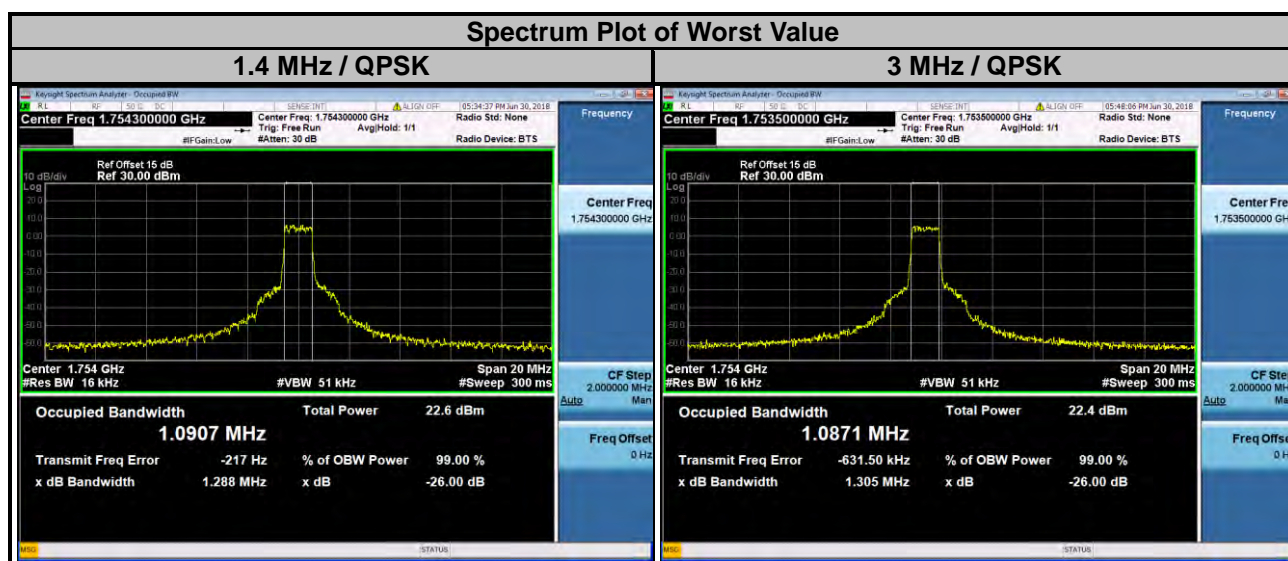

LTE Band 4							
Channel Bandwidth: 5 MHz				Channel Bandwidth: 10 MHz			
Channel	Frequency (MHz)	99 % Occupied Bandwidth (MHz)		Channel	Frequency (MHz)	99 % Occupied Bandwidth (MHz)	
		QPSK	16QAM			QPSK	16QAM
19975	1712.5	1.082	0.921	20000	1715.0	1.089	0.916
20175	1732.5	1.088	0.915	20175	1732.5	1.091	0.916
20375	1752.5	1.082	0.920	20350	1750.0	1.090	0.921

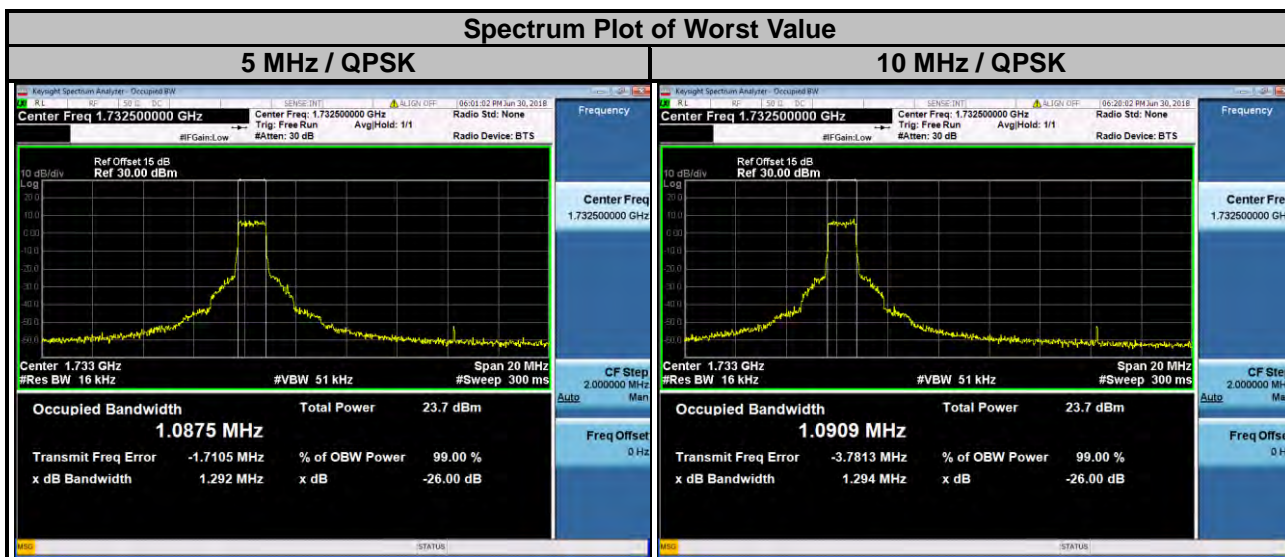

LTE Band 4							
Channel Bandwidth: 15 MHz				Channel Bandwidth: 20 MHz			
Channel	Frequency (MHz)	99 % Occupied Bandwidth (MHz)		Channel	Frequency (MHz)	99 % Occupied Bandwidth (MHz)	
		QPSK	16QAM			QPSK	16QAM
20025	1717.5	1.097	0.918	20050	1720.0	1.087	0.916
20175	1732.5	1.084	0.918	20175	1732.5	1.090	0.916
20325	1747.5	1.084	0.912	20300	1745.0	1.088	0.916

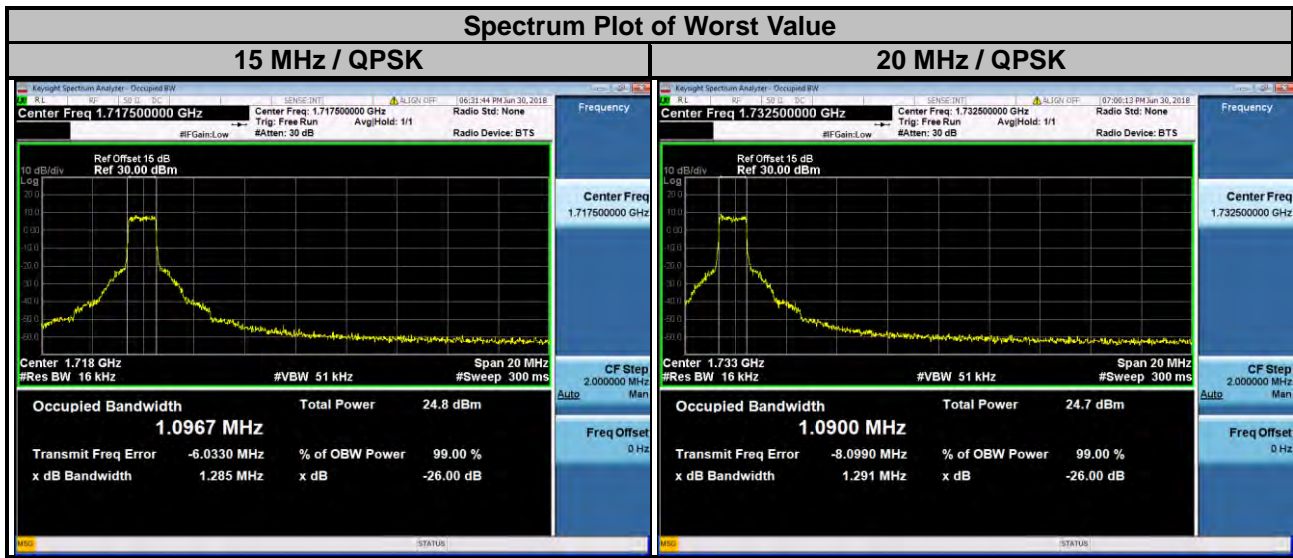

LTE Band 12							
Channel Bandwidth: 1.4 MHz				Channel Bandwidth: 3 MHz			
Channel	Frequency (MHz)	99 % Occupied Bandwidth (MHz)		Channel	Frequency (MHz)	99 % Occupied Bandwidth (MHz)	
		QPSK	16QAM			QPSK	16QAM
23017	699.7	1.086	0.911	23025	700.5	1.089	0.918
23095	707.5	1.086	0.913	23095	707.5	1.079	0.915
23173	715.3	1.088	0.912	23165	714.5	1.081	0.915

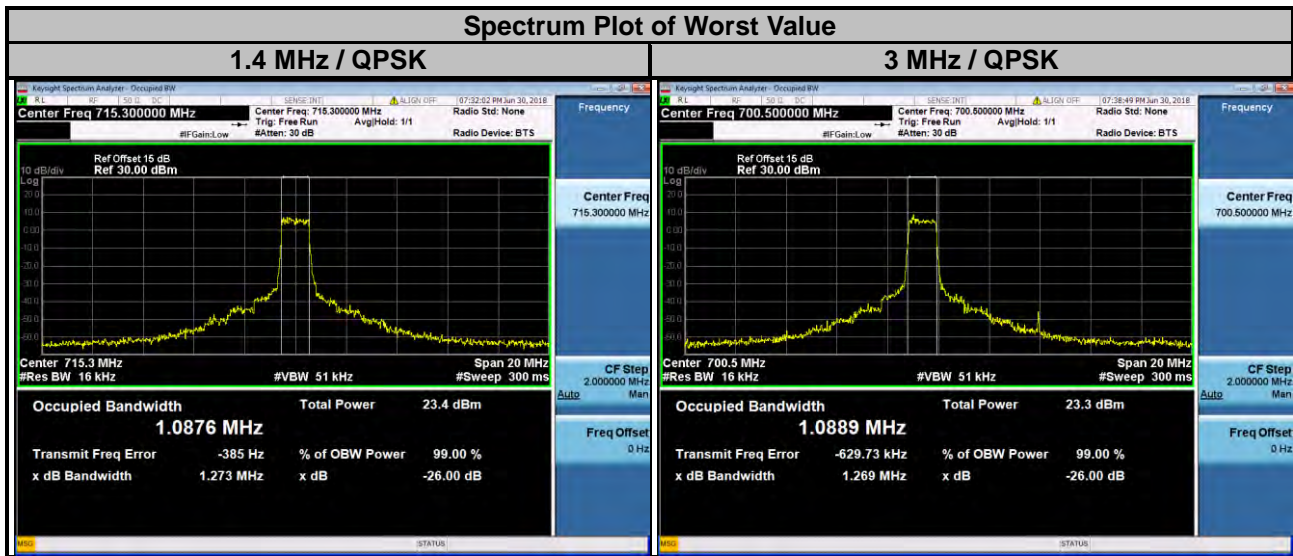

LTE Band 12							
Channel Bandwidth: 5 MHz				Channel Bandwidth: 10 MHz			
Channel	Frequency (MHz)	99 % Occupied Bandwidth (MHz)		Channel	Frequency (MHz)	99 % Occupied Bandwidth (MHz)	
		QPSK	16QAM			QPSK	16QAM
23035	701.5	1.083	0.918	23060	704.0	1.087	0.915
23095	707.5	1.079	0.919	23095	707.5	1.086	0.913
23155	713.5	1.083	0.910	23130	711.0	1.087	0.915

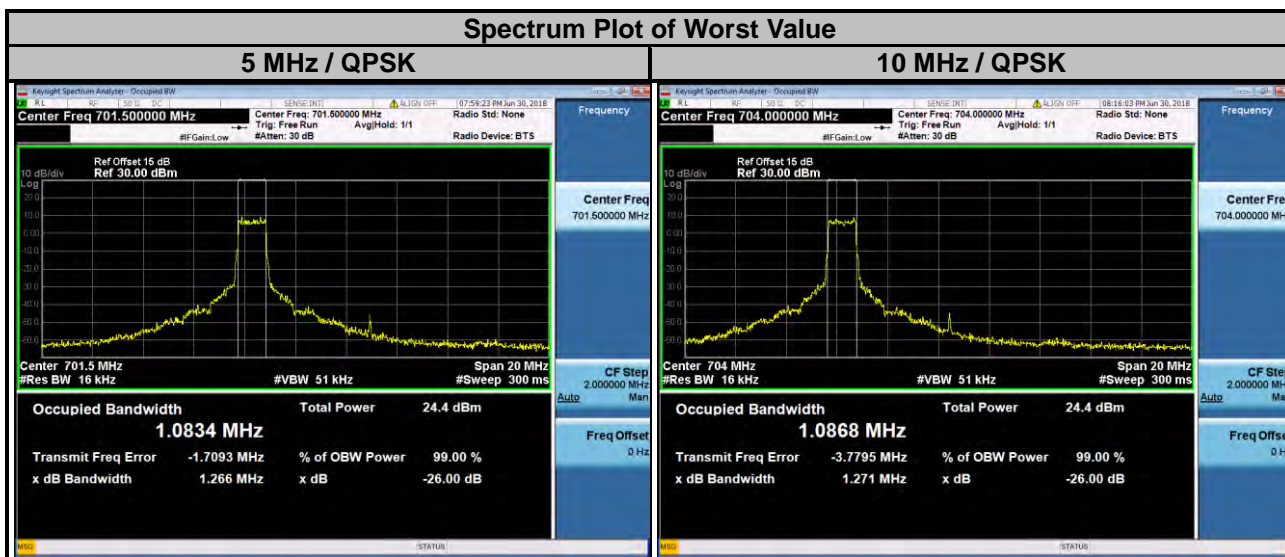

LTE Band 13

Channel Bandwidth: 5 MHz				Channel Bandwidth: 10 MHz			
Channel	Frequency (MHz)	99 % Occupied Bandwidth (MHz)		Channel	Frequency (MHz)	99 % Occupied Bandwidth (MHz)	
		QPSK	16QAM			QPSK	16QAM
23205	779.5	1.091	0.914	23230	782.0	1.087	0.912
23230	782.0	1.087	0.909				
23255	784.5	1.078	0.917				

Spectrum Plot of Worst Value

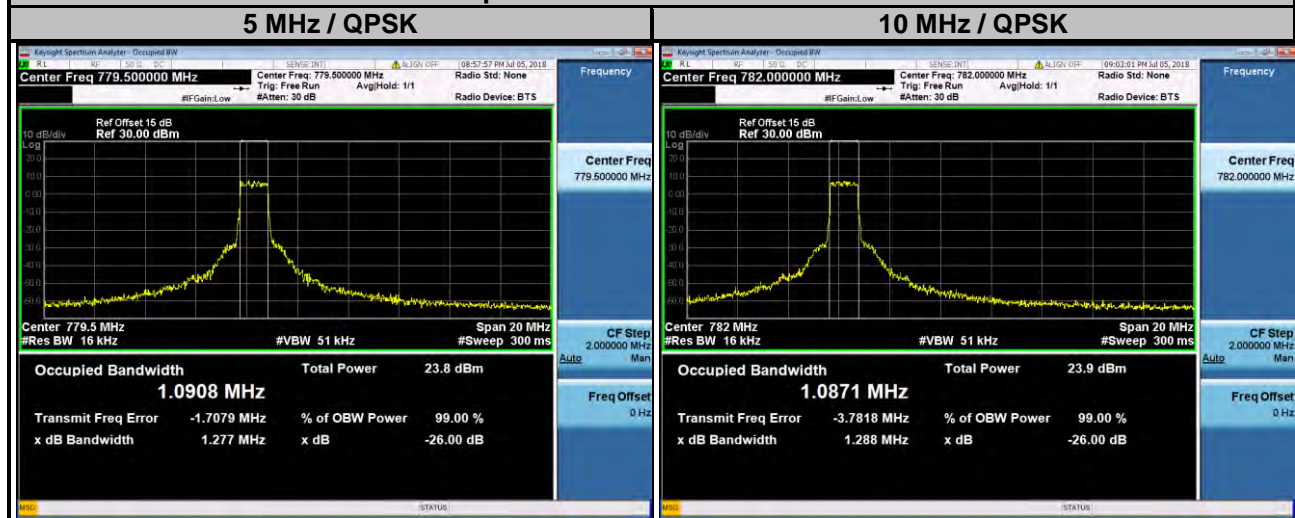

LTE Band 17

Channel Bandwidth: 5 MHz				Channel Bandwidth: 10 MHz			
Channel	Frequency (MHz)	99 % Occupied Bandwidth (MHz)		Channel	Frequency (MHz)	99 % Occupied Bandwidth (MHz)	
		QPSK	16QAM			QPSK	16QAM
23755	706.5	1.089	0.924	23780	709.0	1.085	0.916
23790	710.0	1.085	0.913	23790	710.0	1.089	0.913
23825	713.5	1.094	0.917	23800	711.0	1.090	0.915

Spectrum Plot of Worst Value

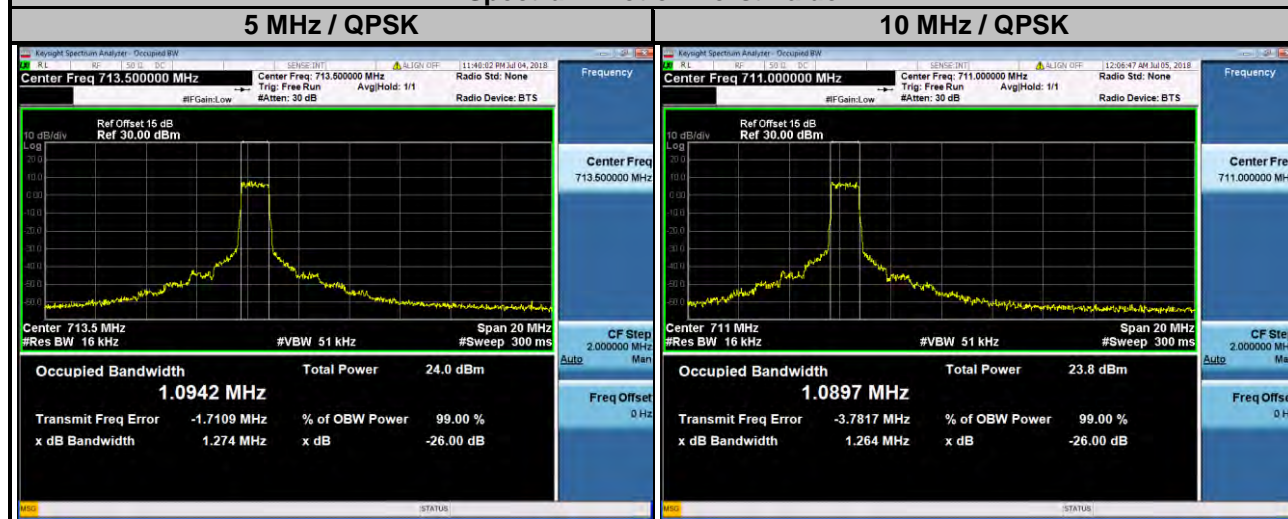

LTE Band 66

Channel Bandwidth: 1.4 MHz				Channel Bandwidth: 3 MHz			
Channel	Frequency (MHz)	99 % Occupied Bandwidth (MHz)		Channel	Frequency (MHz)	99 % Occupied Bandwidth (MHz)	
		QPSK	16QAM			QPSK	16QAM
131979	1710.7	1.088	0.916	131987	1711.5	1.082	0.925
132322	1745.0	1.089	0.917	132322	1745.0	1.079	0.911
132665	1779.3	1.087	0.915	132657	1778.5	1.081	0.911

Spectrum Plot of Worst Value

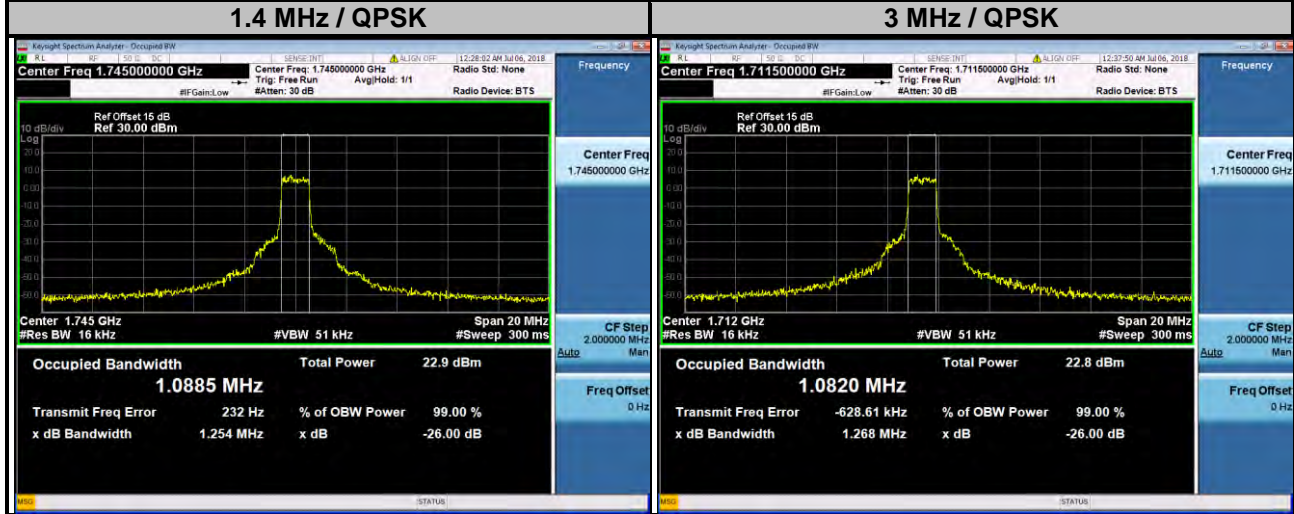

LTE Band 66

Channel Bandwidth: 5 MHz				Channel Bandwidth: 10 MHz			
Channel	Frequency (MHz)	99 % Occupied Bandwidth (MHz)		Channel	Frequency (MHz)	99 % Occupied Bandwidth (MHz)	
		QPSK	16QAM			QPSK	16QAM
131997	1712.5	1.093	0.915	132022	1715.0	1.092	0.917
132322	1745.0	1.091	0.913	132322	1745.0	1.090	0.916
132647	1777.5	1.087	0.914	132622	1775.0	1.086	0.912

Spectrum Plot of Worst Value

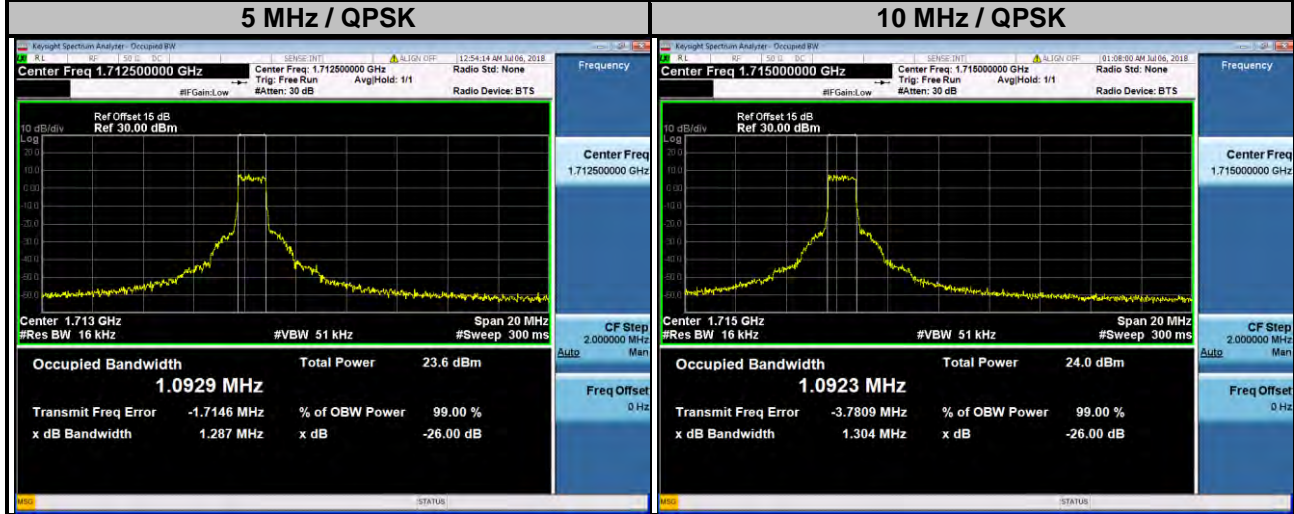

LTE Band 66

Channel Bandwidth: 15 MHz				Channel Bandwidth: 20 MHz			
Channel	Frequency (MHz)	99 % Occupied Bandwidth (MHz)		Channel	Frequency (MHz)	99 % Occupied Bandwidth (MHz)	
		QPSK	16QAM			QPSK	16QAM
132047	1717.5	1.096	0.926	132072	1720.0	1.090	0.916
132322	1745.0	1.094	0.918	132322	1745.0	1.090	0.920
132597	1772.5	1.083	0.910	132572	1770.0	1.092	0.918

Spectrum Plot of Worst Value

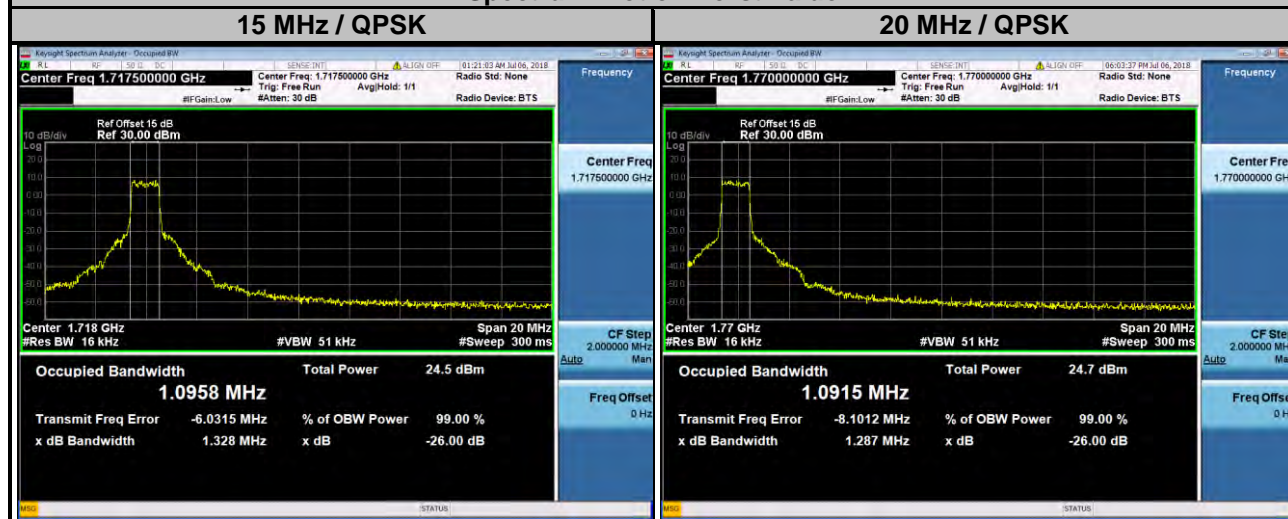

4.5 Band Edge Measurement

4.5.1 Limits of Band Edge Measurement

For operations in the 704-716 MHz band, the power of any emission outside a licensee's frequency band(s) of operation shall be attenuated below the transmitter power (P) within the licensed band(s) of operation, measured in watts, by at least $43 + 10 \log (P)$ dB. Compliance with this provision is based on the use of measurement instrumentation employing a resolution bandwidth of 100 kilohertz or greater.

However, in the 100 kilohertz bands immediately outside and adjacent to a licensee's frequency block, a resolution bandwidth of at least 30 kHz may be employed.

For operations in the 1710–1755 MHz bands, the power of any emission outside a licensee's frequency block shall be attenuated below the transmitter power (P) by at least $43 + 10 \log (P)$ dB.

4.5.2 Test Setup

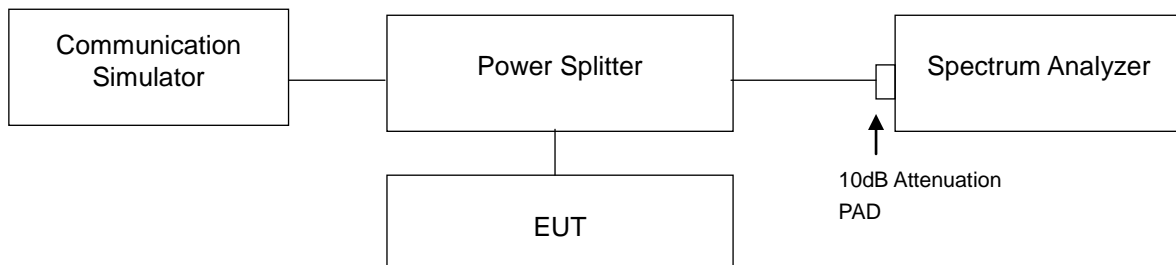

4.5.3 Test Procedures

- a. All measurements were done at low and high operational frequency range.
- b. The center frequency of spectrum is the band edge frequency and span is 1 MHz. RB of the spectrum is 30 kHz and VB of the spectrum is 100 kHz (LTE Bandwidth 1.4 MHz).
- c. The center frequency of spectrum is the band edge frequency and span is 1 MHz. RB of the spectrum is 62 kHz and VB of the spectrum is 200 kHz (LTE Bandwidth 3 MHz).
- d. The center frequency of spectrum is the band edge frequency and span is 1 MHz. RB of the spectrum is 100 kHz and VB of the spectrum is 300 kHz (LTE Bandwidth 5 MHz).
- e. The center frequency of spectrum is the band edge frequency and span is 1 MHz. RB of the spectrum is 200 kHz and VB of the spectrum is 1 MHz (LTE Bandwidth 10 MHz).
- f. The center frequency of spectrum is the band edge frequency and span is 1MHz. RB of the spectrum is 300 kHz and VB of the spectrum is 1 MHz (LTE Bandwidth 15 MHz).
- g. The center frequency of spectrum is the band edge frequency and span is 1MHz. RB of the spectrum is 300 kHz and VB of the spectrum is 1 MHz (LTE Bandwidth 20 MHz).
- h. Record the max. trace plot into the test report.

4.5.4 Test Results

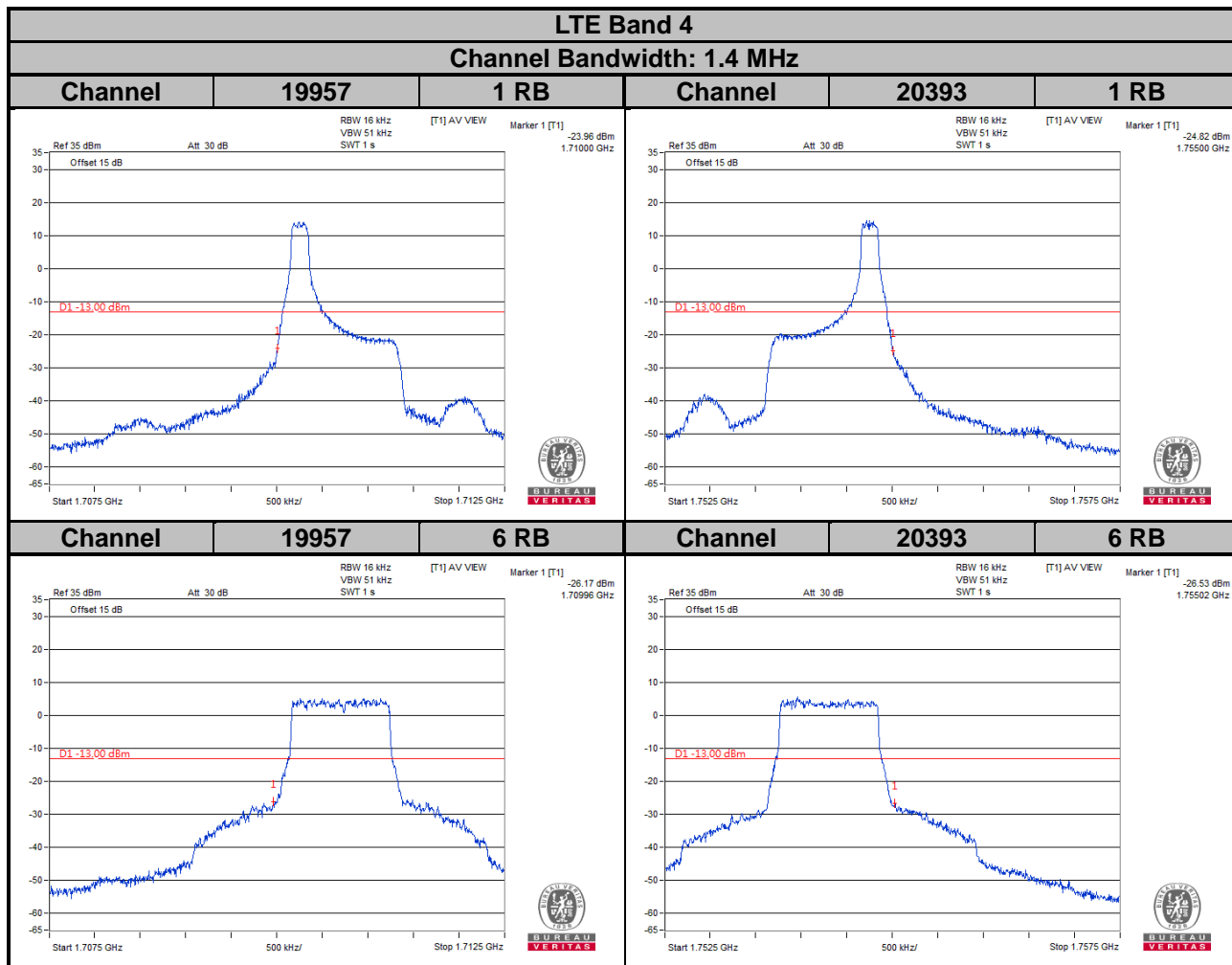

LTE Band 4
Channel Bandwidth: 3 MHz

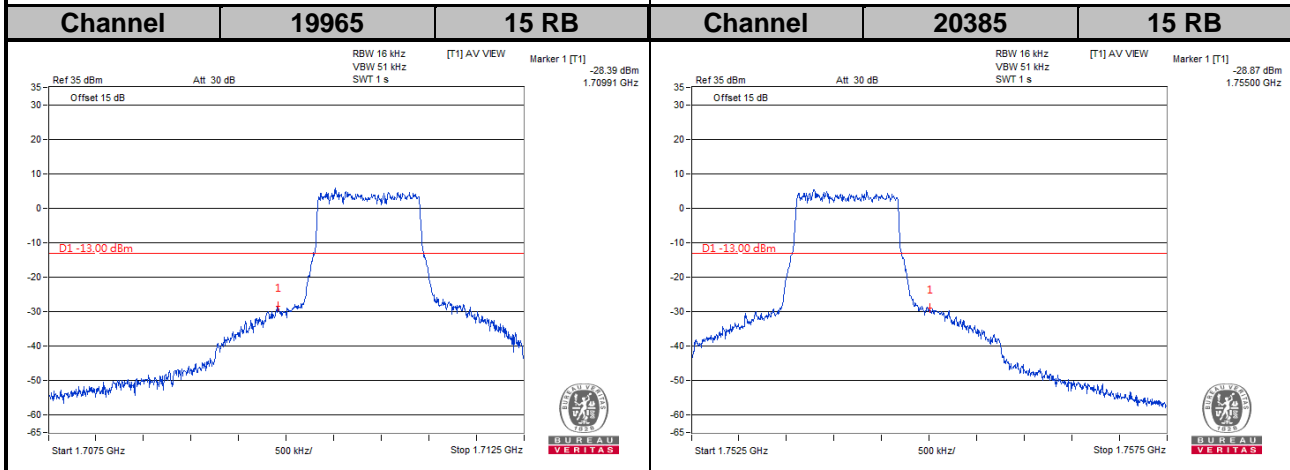
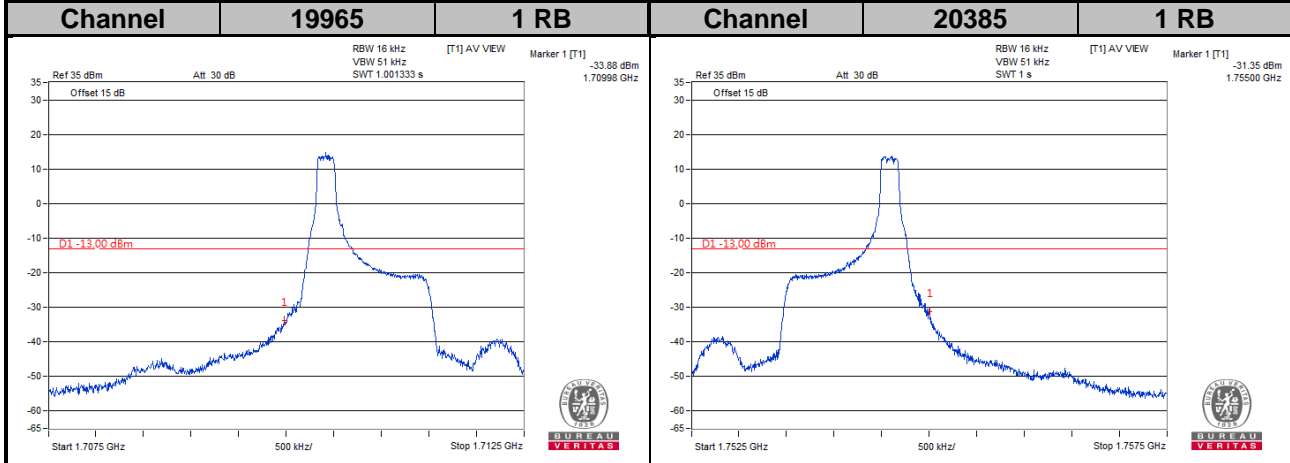

LTE Band 4

Channel Bandwidth: 5 MHz

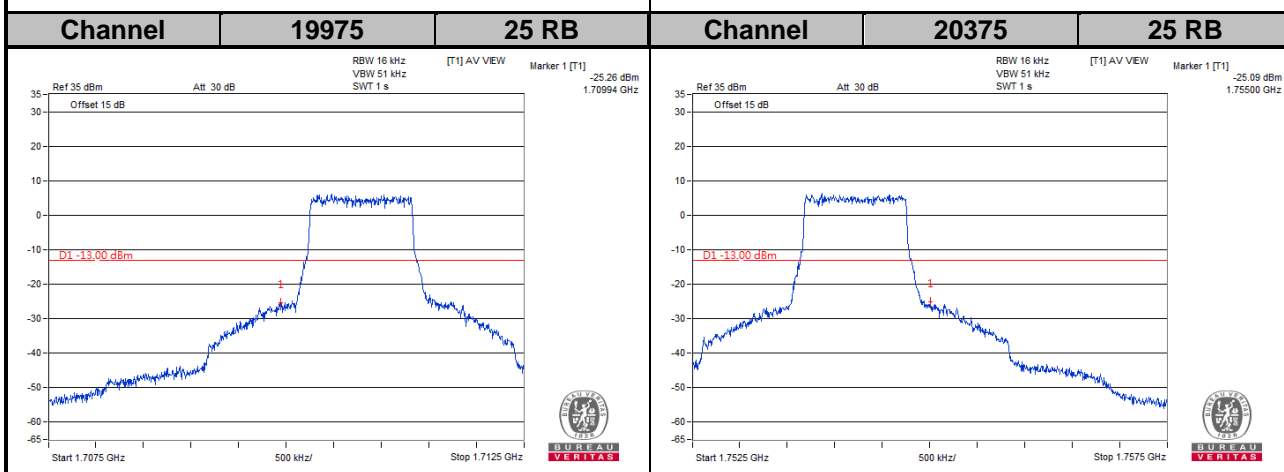
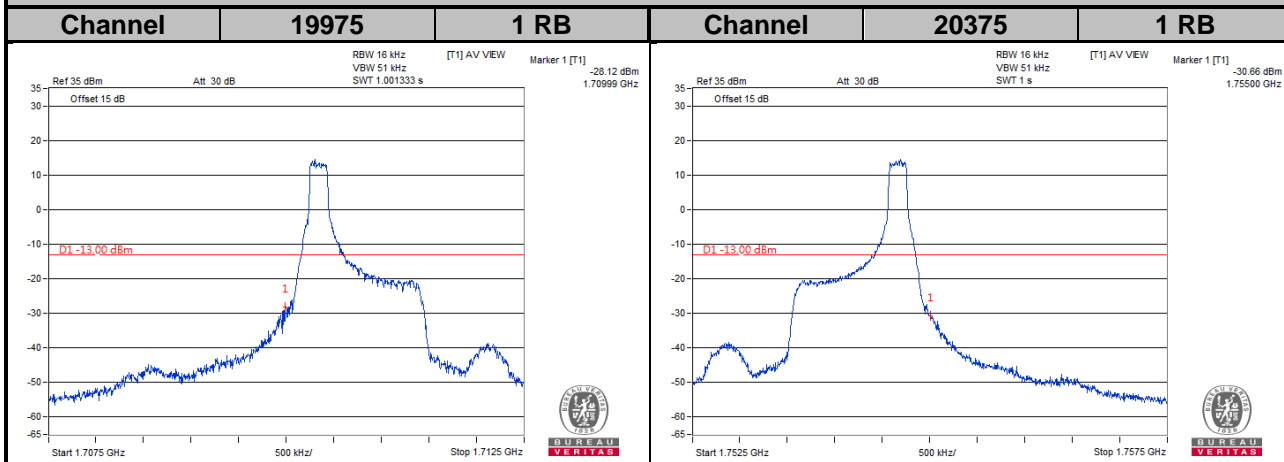

LTE Band 4
Channel Bandwidth: 10 MHz

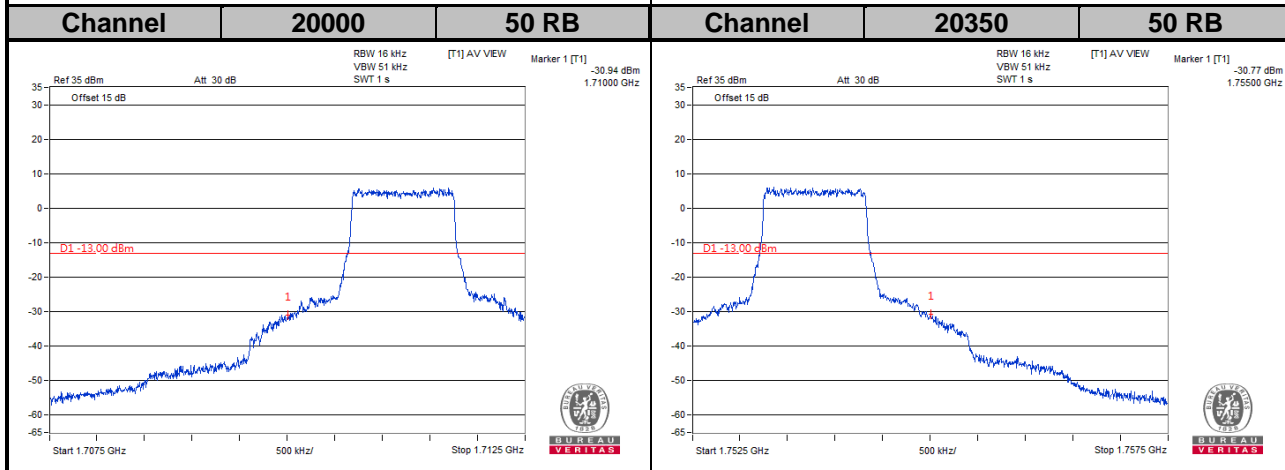
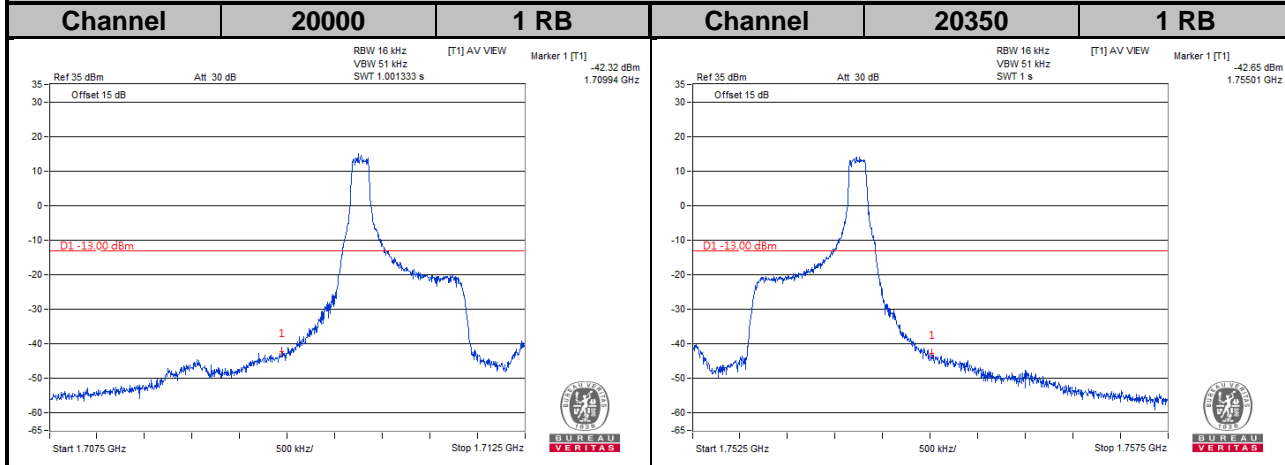

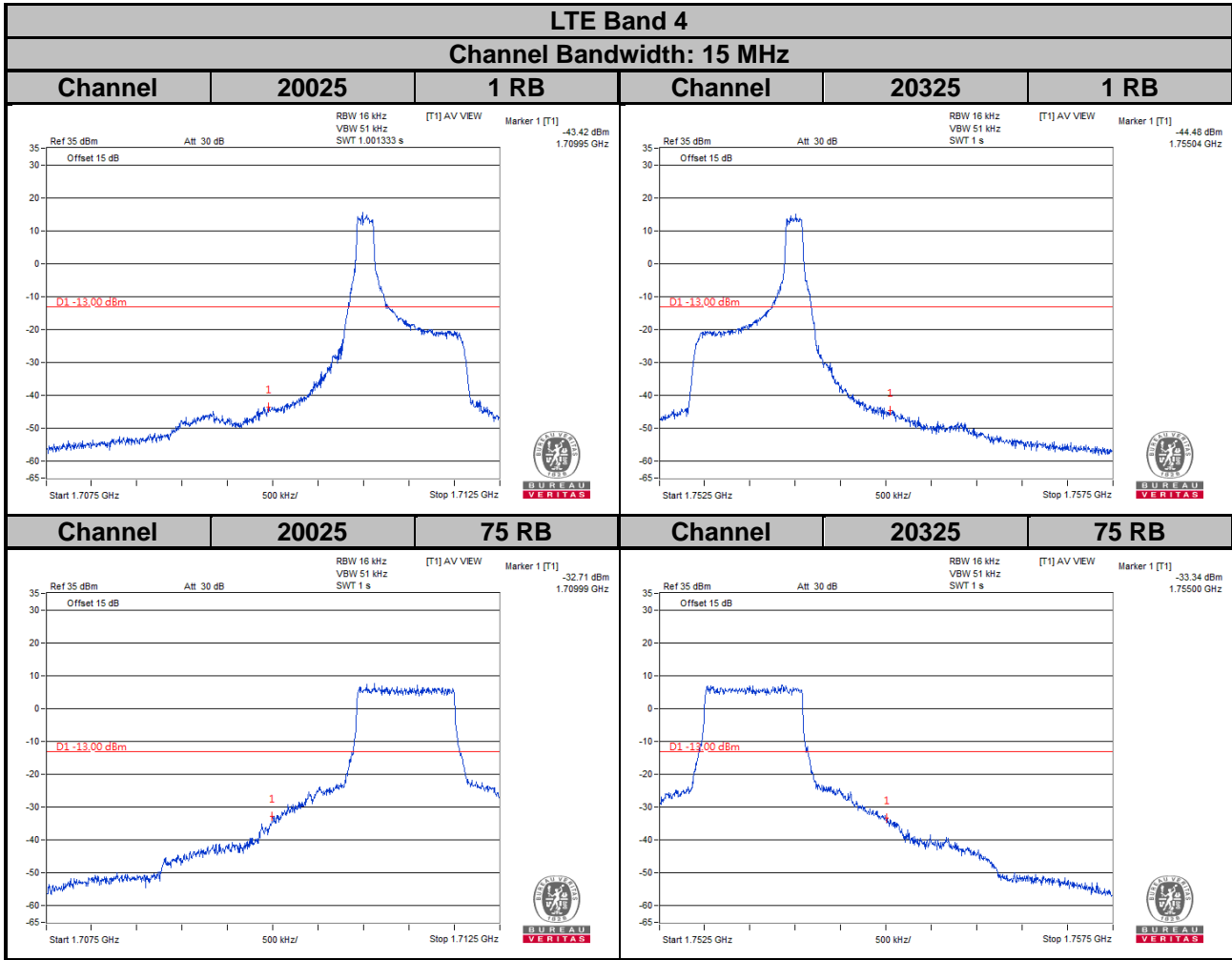

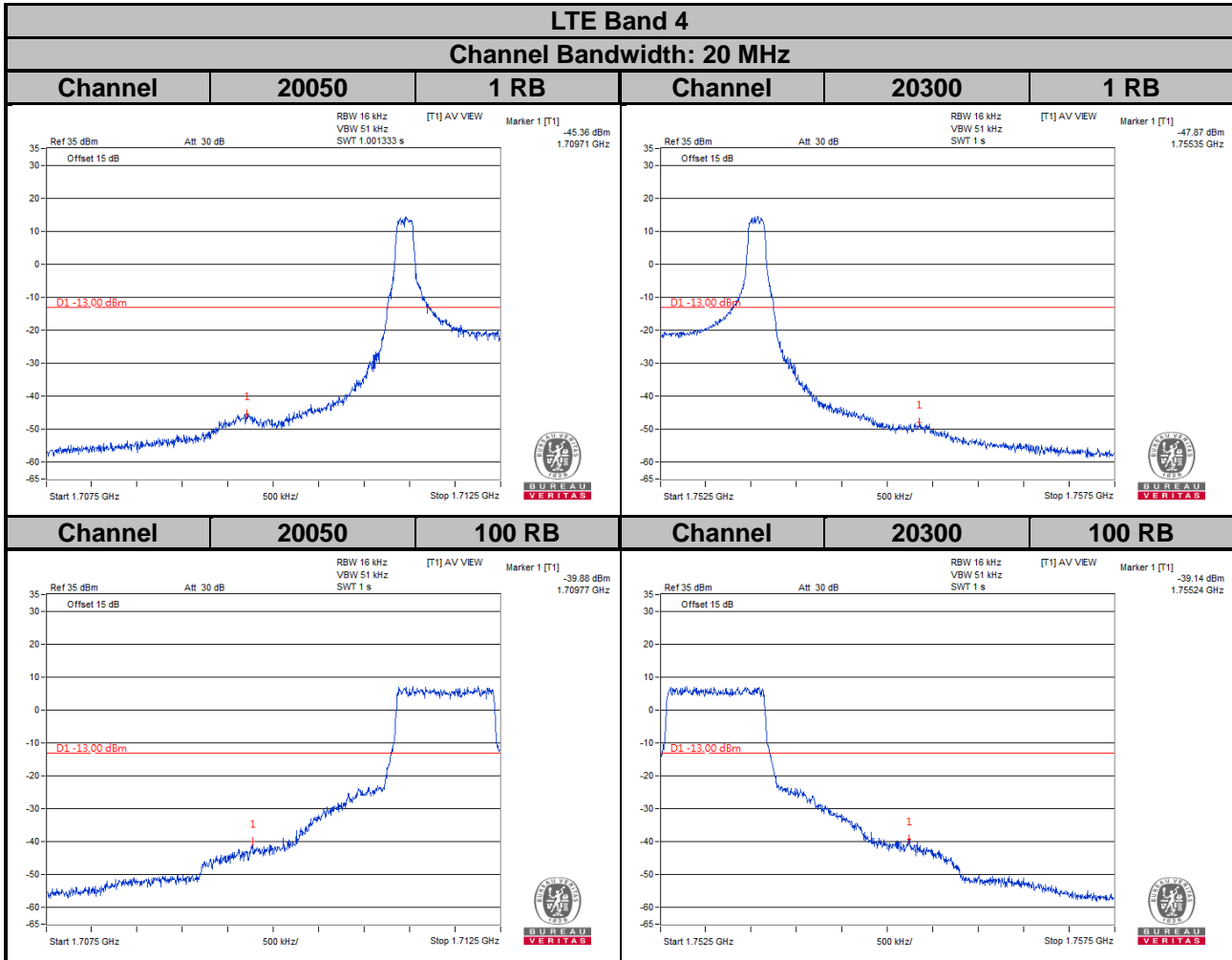

LTE Band 12
Channel Bandwidth: 1.4 MHz

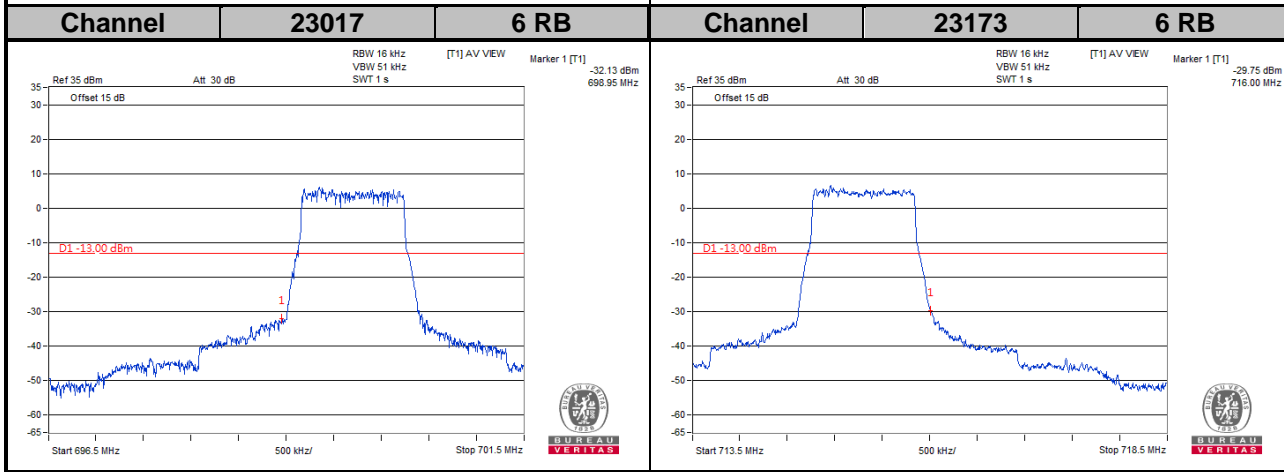
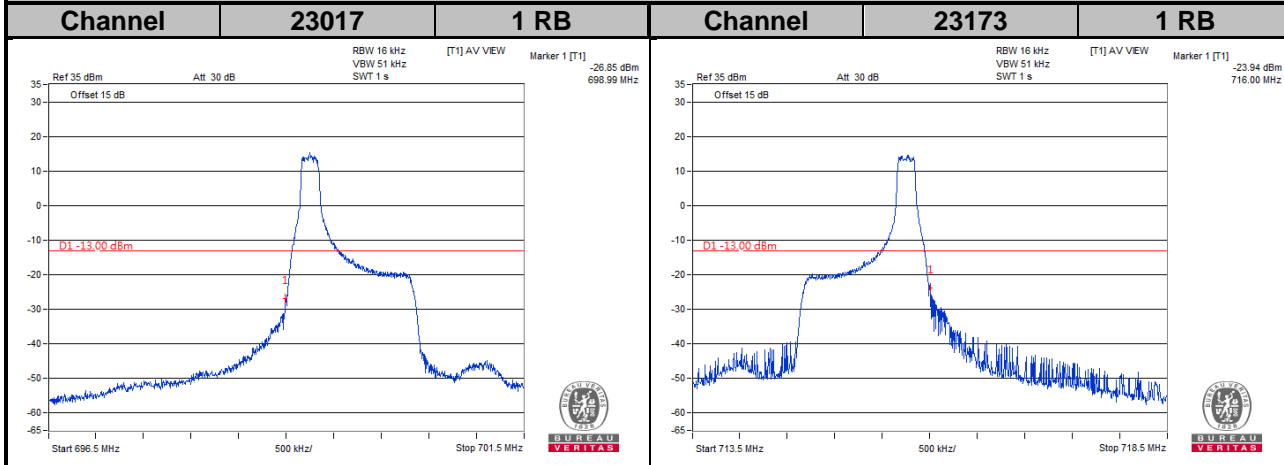

LTE Band 12
Channel Bandwidth: 3 MHz

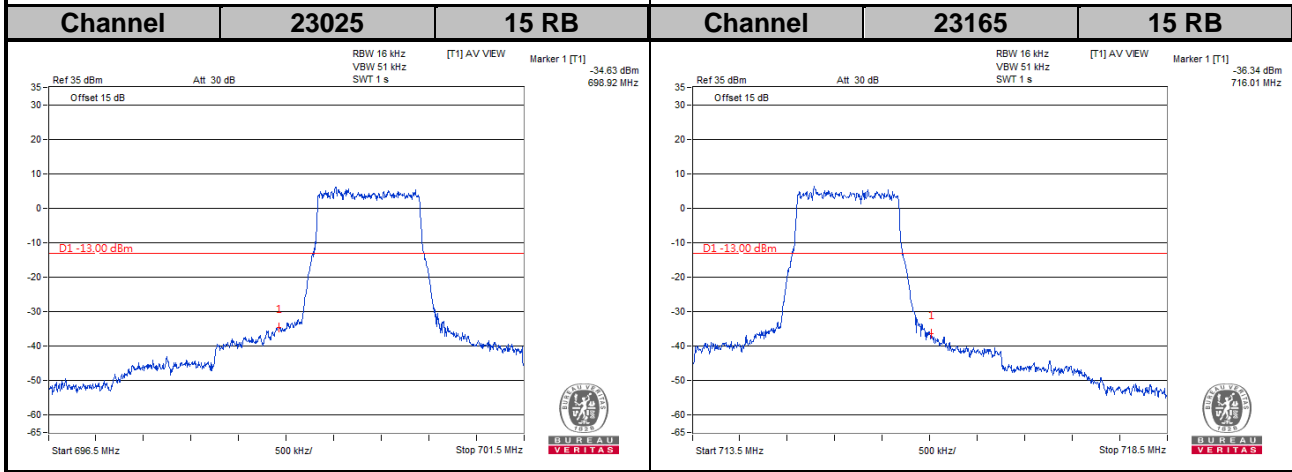
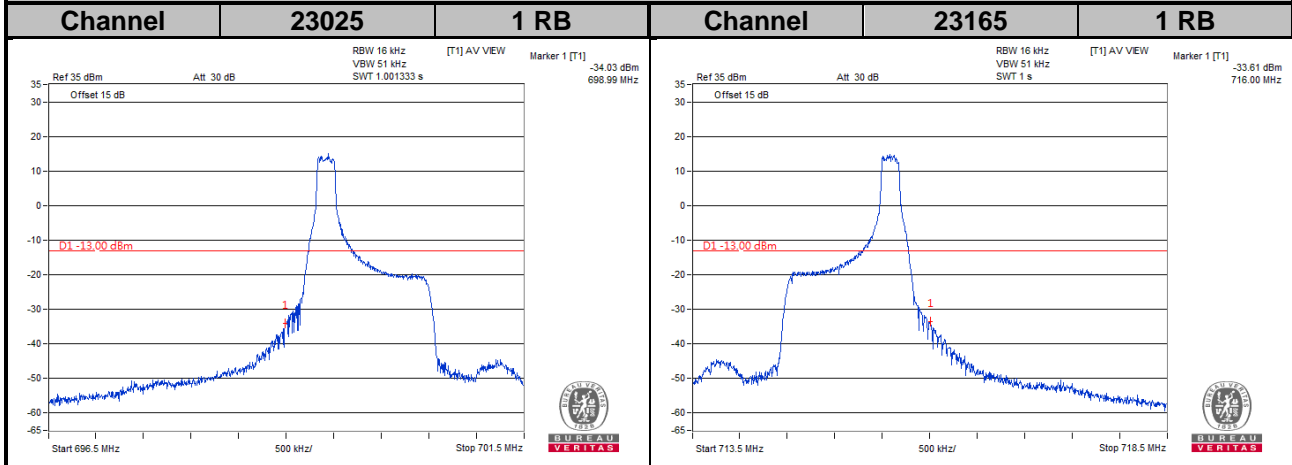

LTE Band 12
Channel Bandwidth: 5 MHz

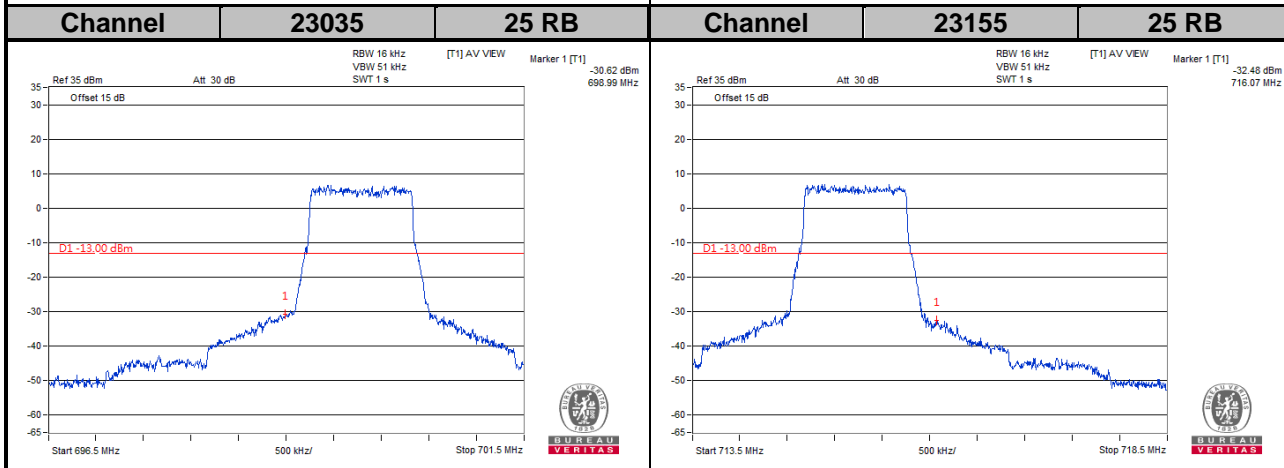
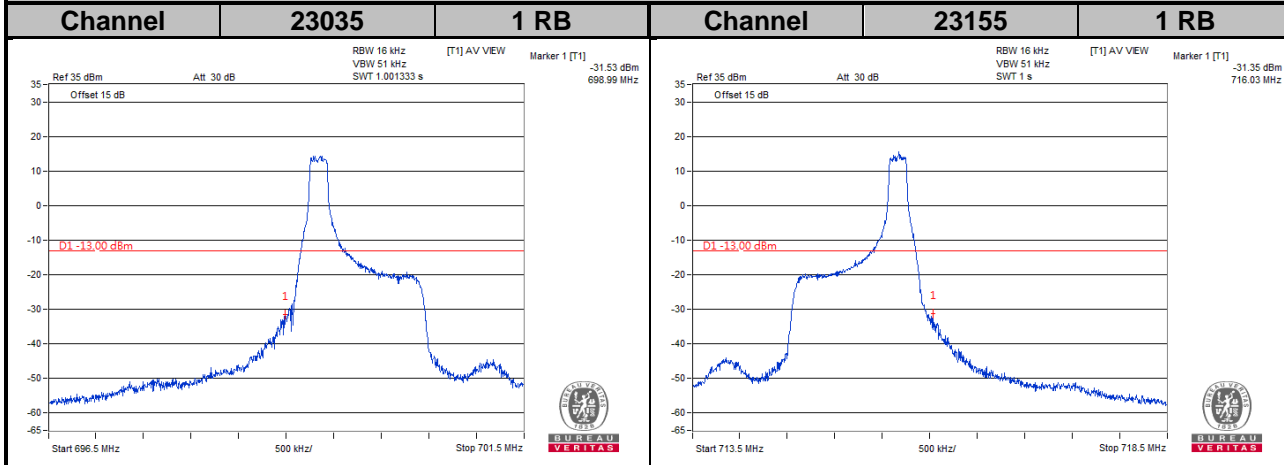

LTE Band 12
Channel Bandwidth: 10 MHz

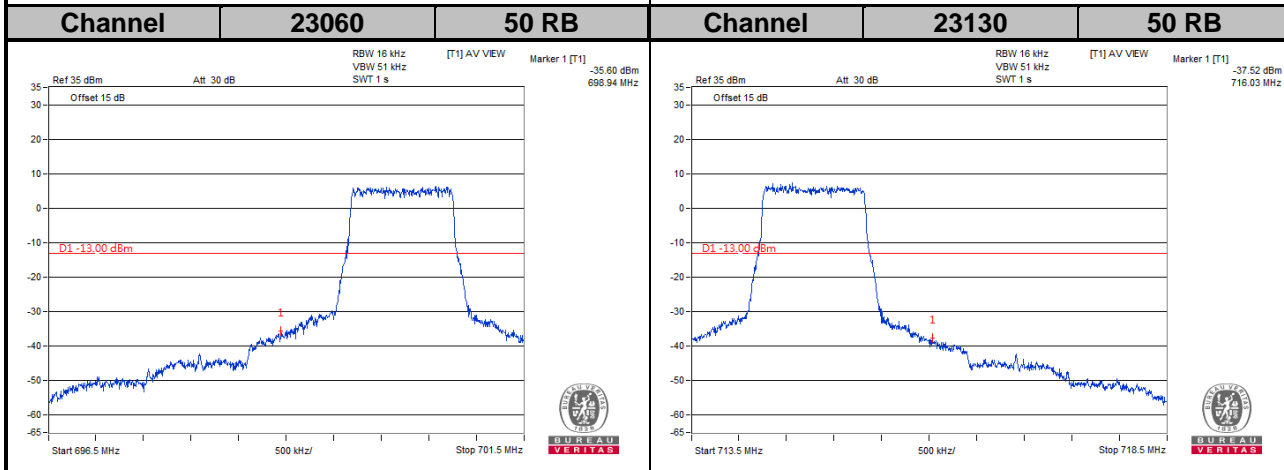
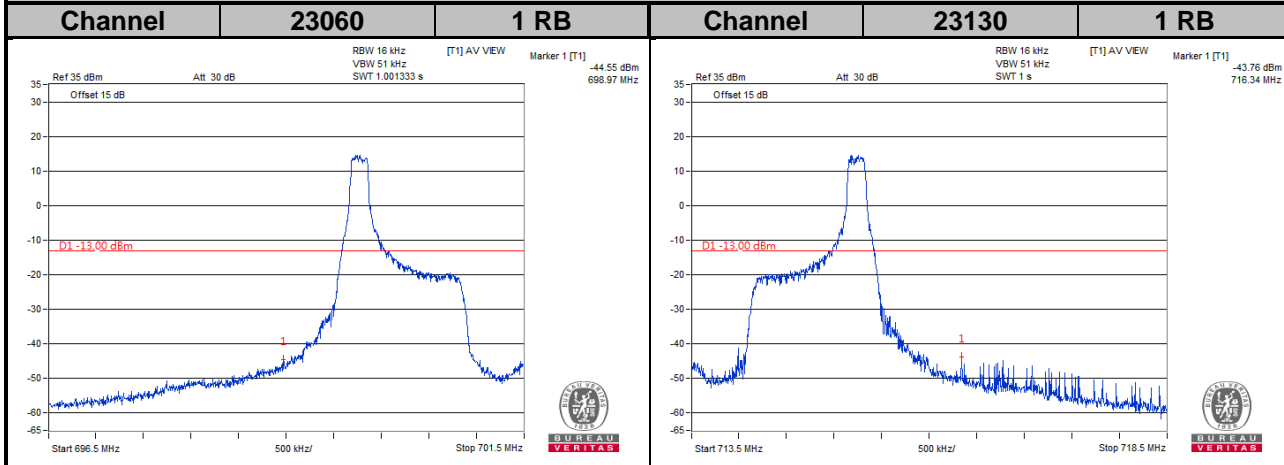

LTE Band 13
Channel Bandwidth: 5 MHz

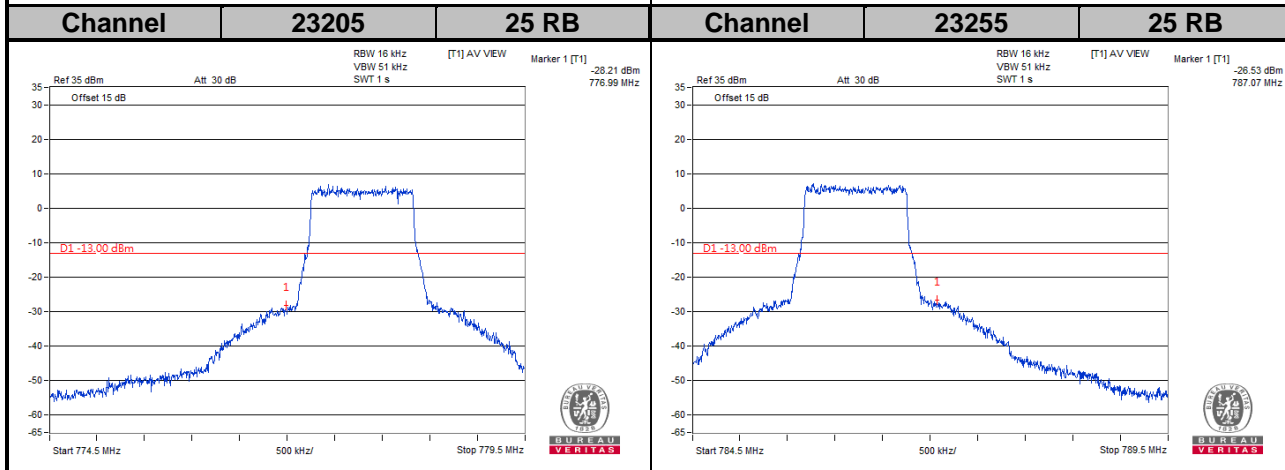
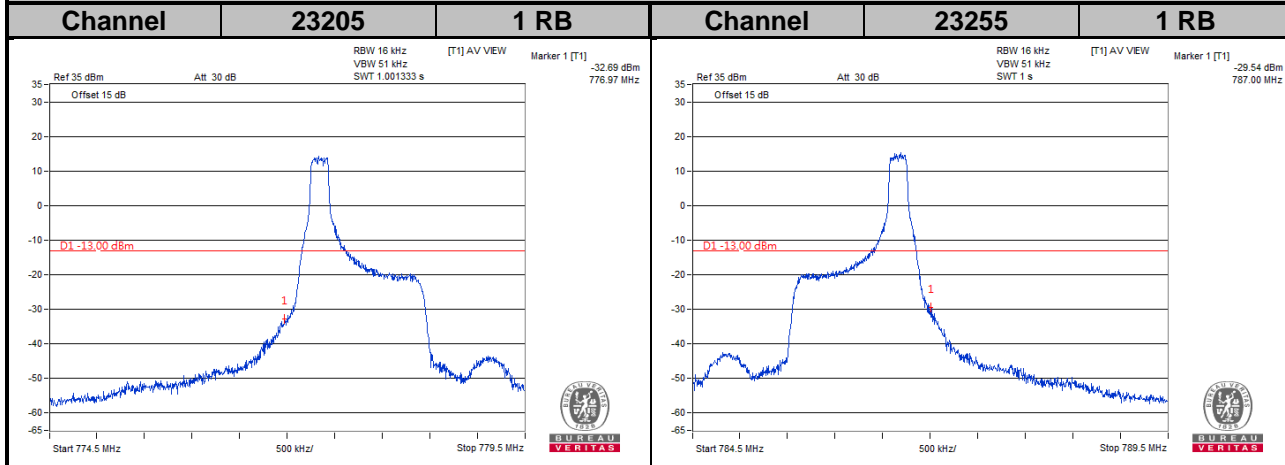

LTE Band 13
Channel Bandwidth: 10 MHz

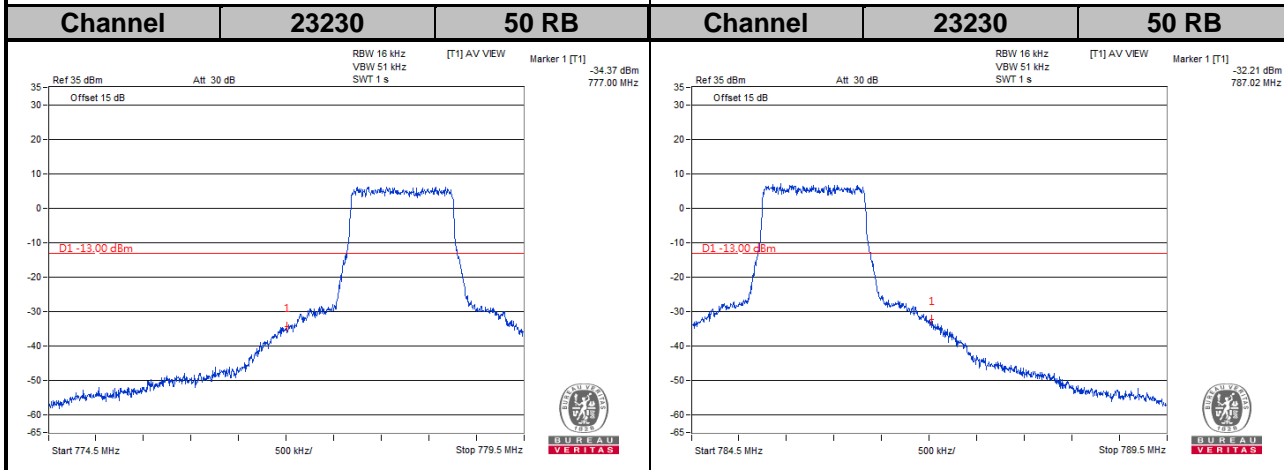
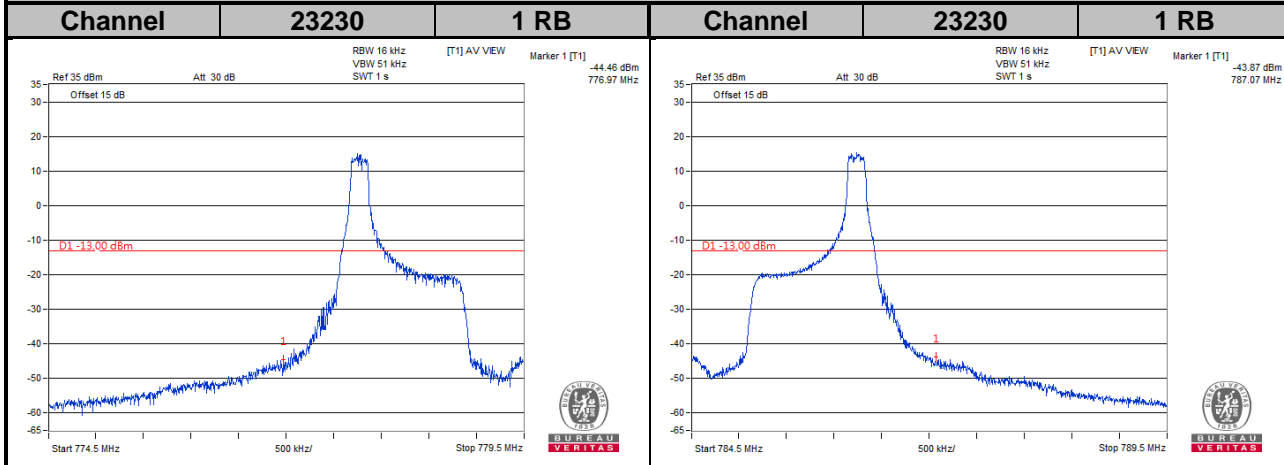

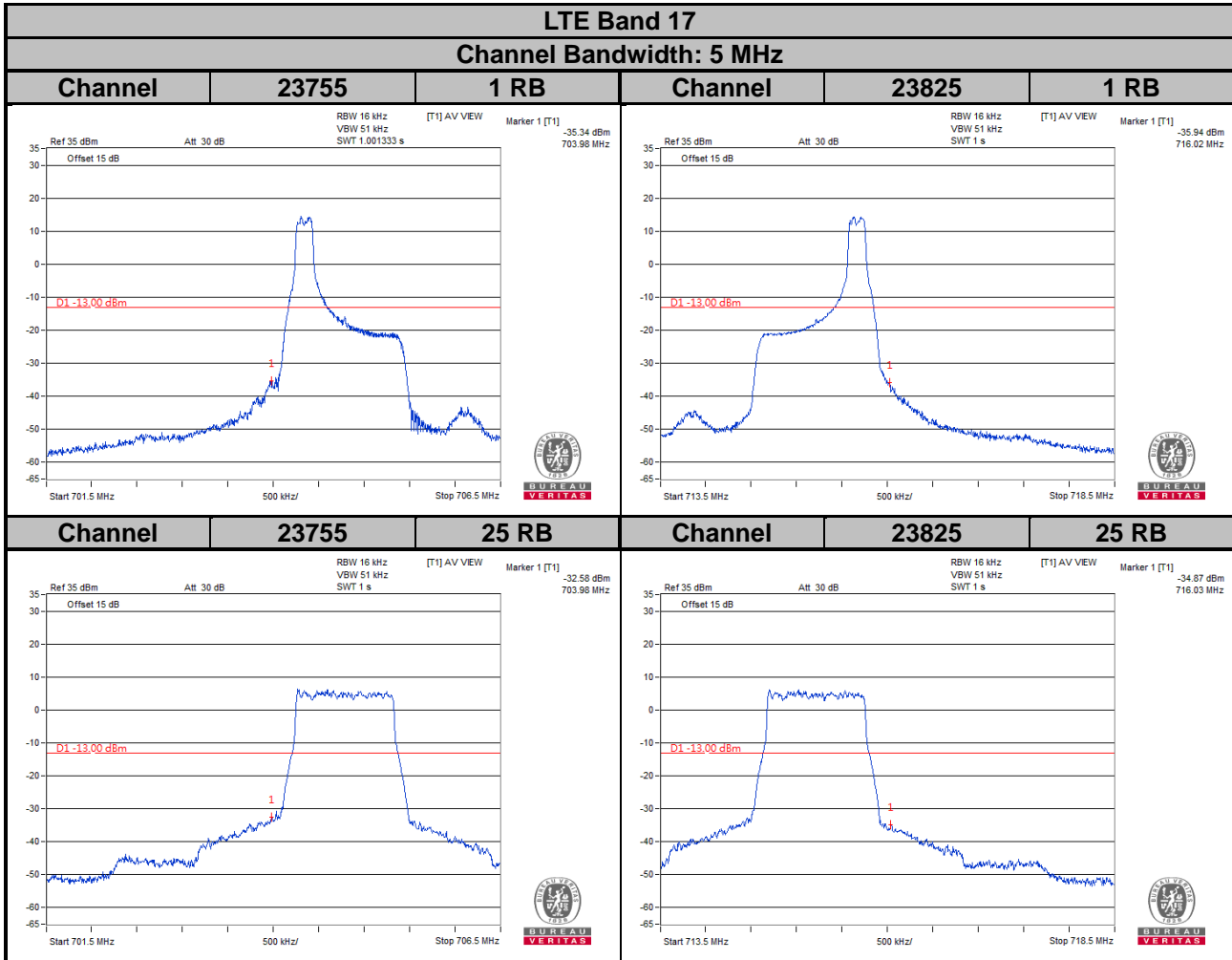

LTE Band 17
Channel Bandwidth: 10 MHz

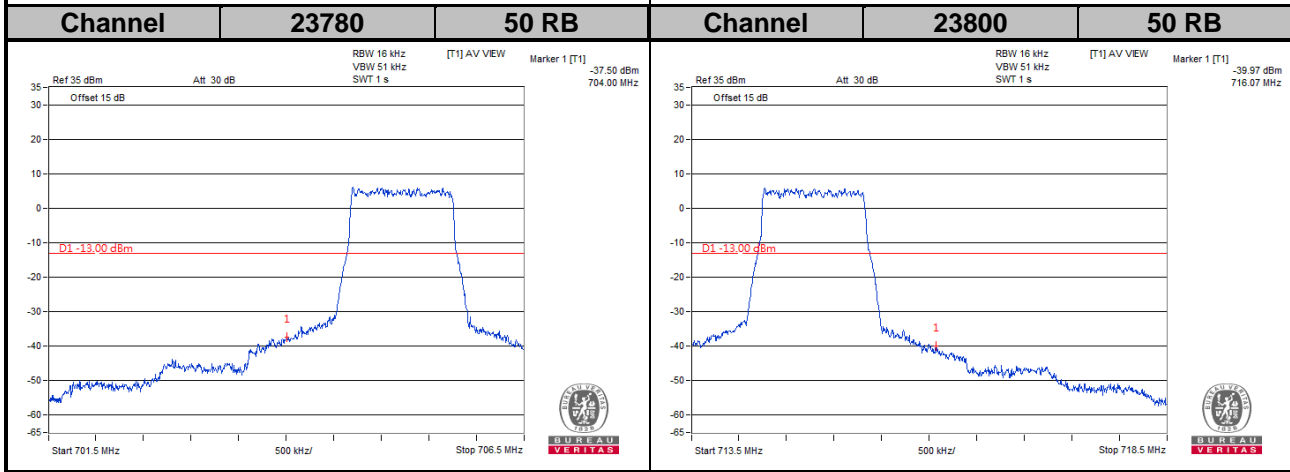
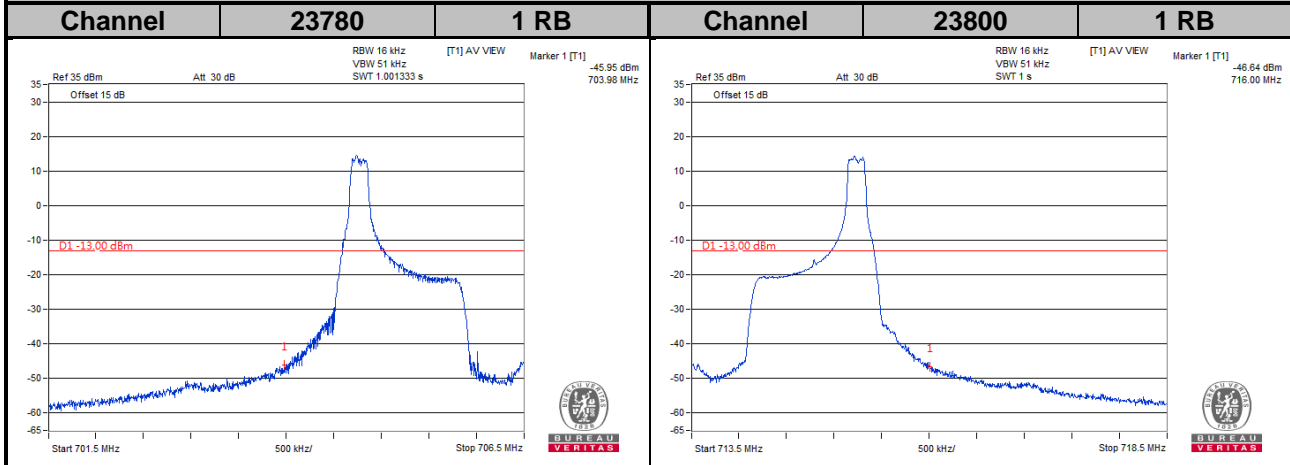

LTE Band 66
Channel Bandwidth: 1.4 MHz

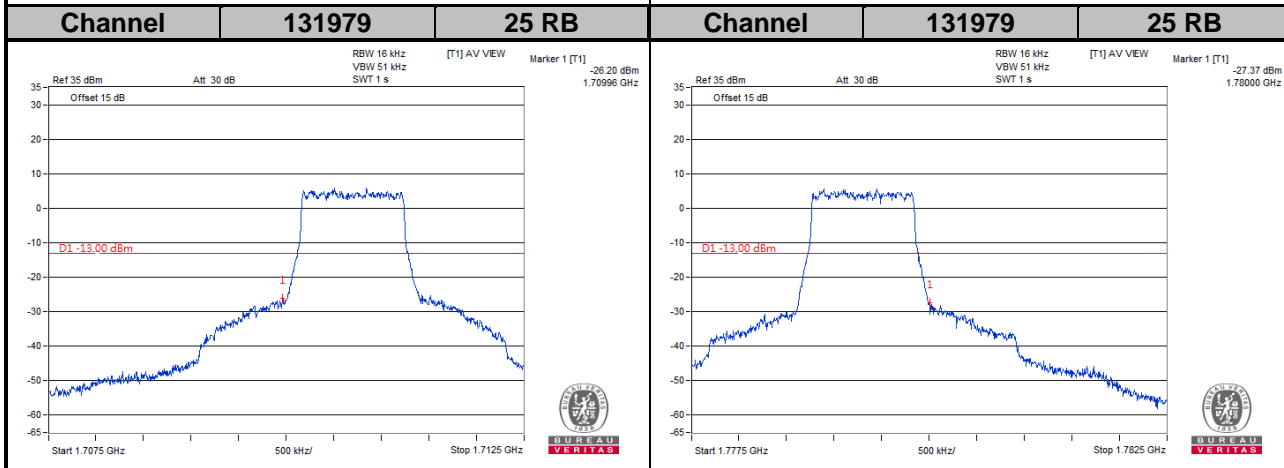
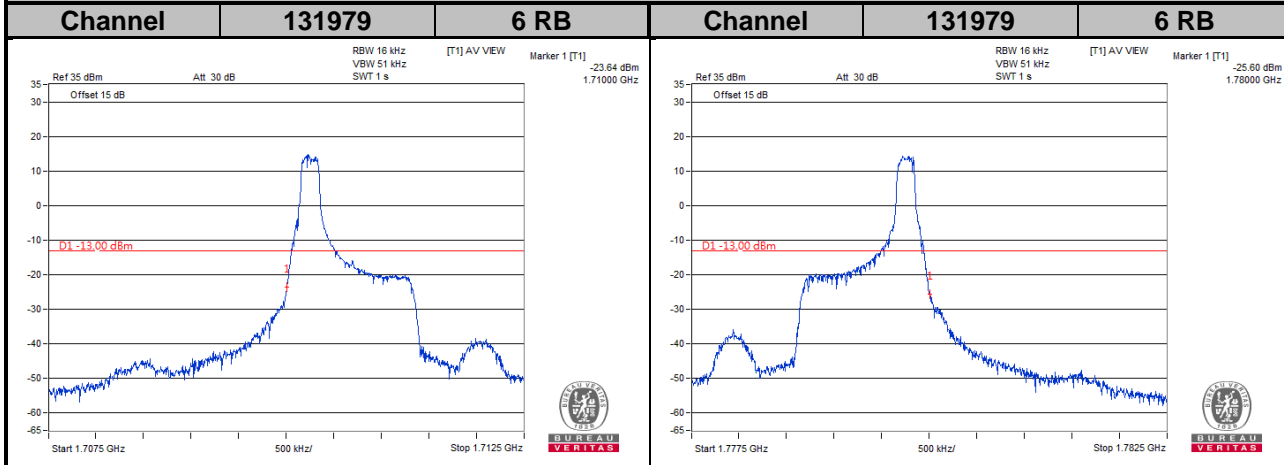

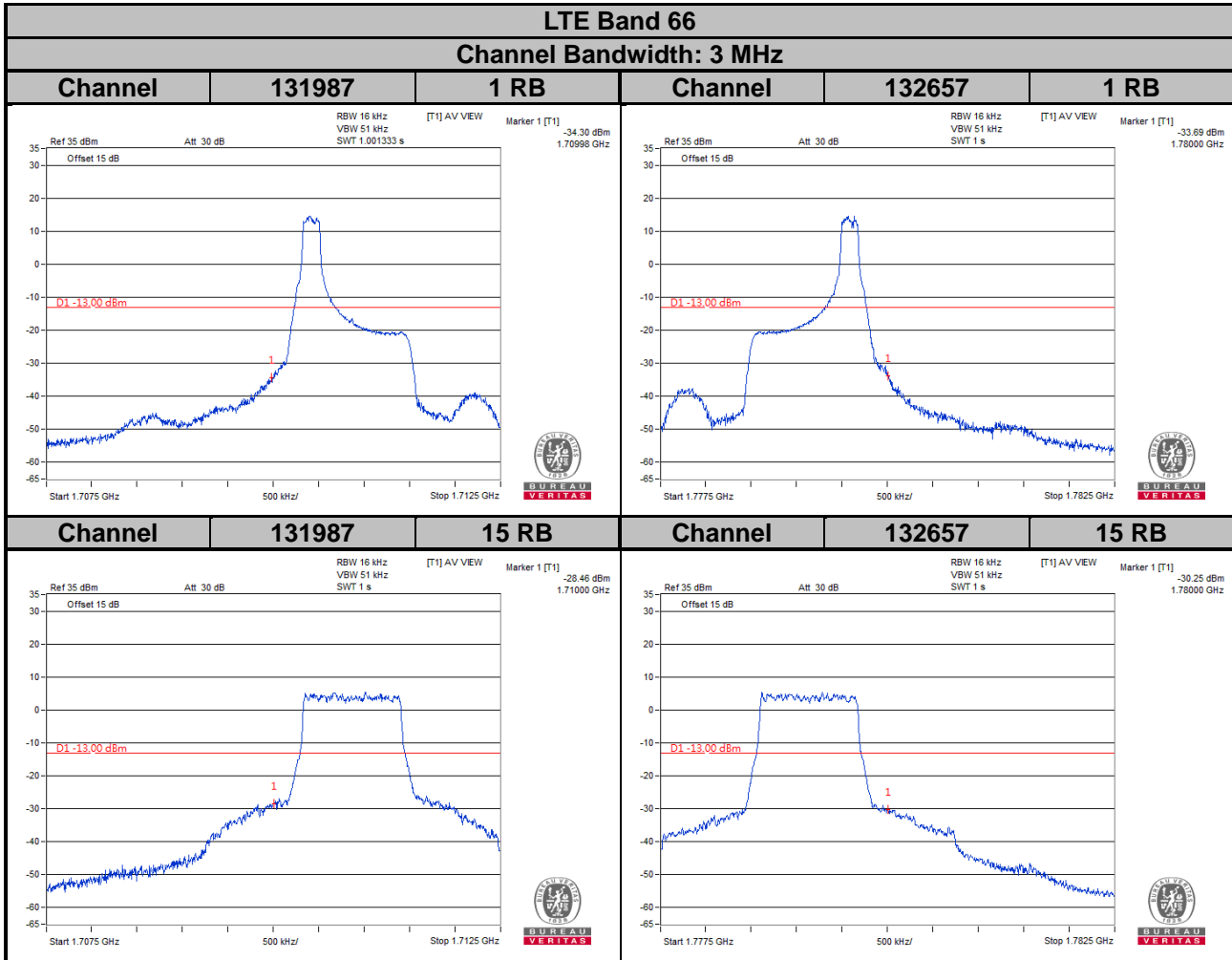

LTE Band 66
Channel Bandwidth: 5 MHz

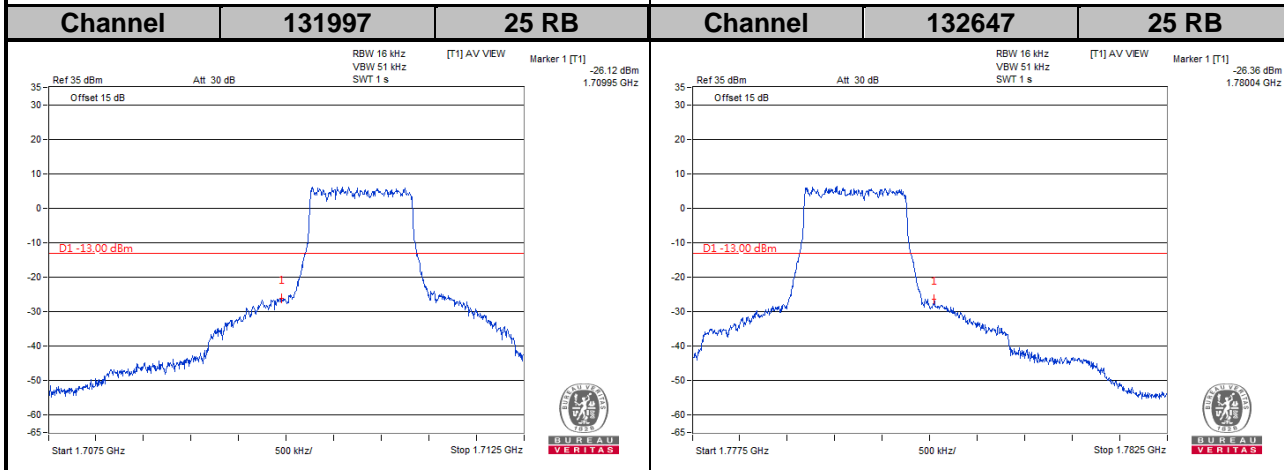
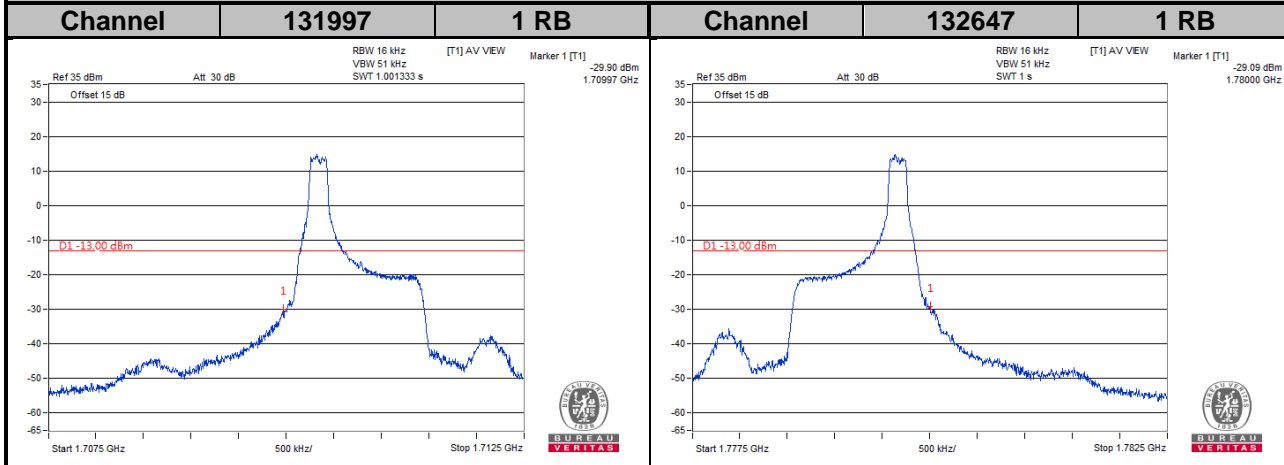

LTE Band 66
Channel Bandwidth: 10 MHz

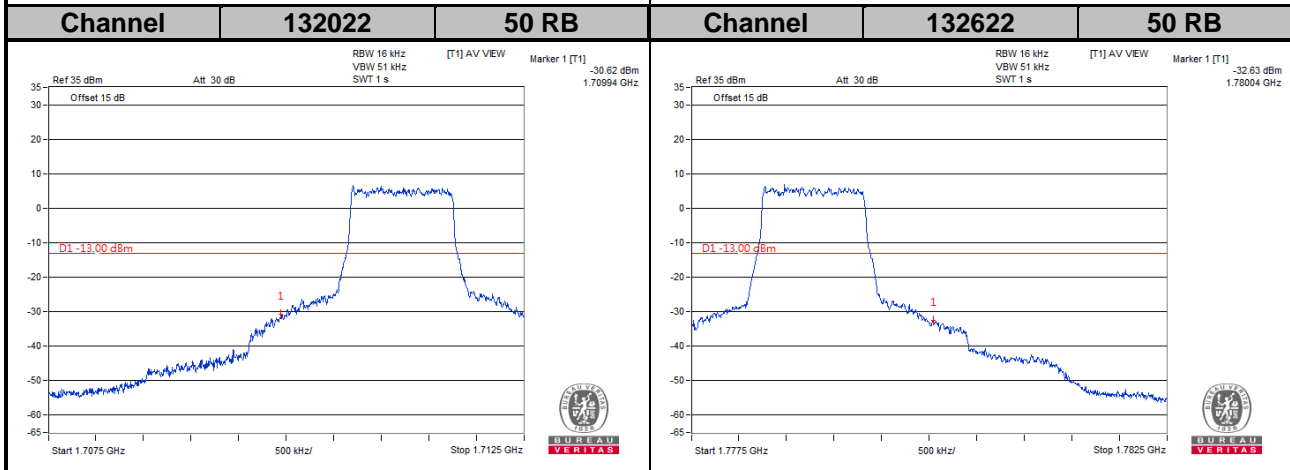
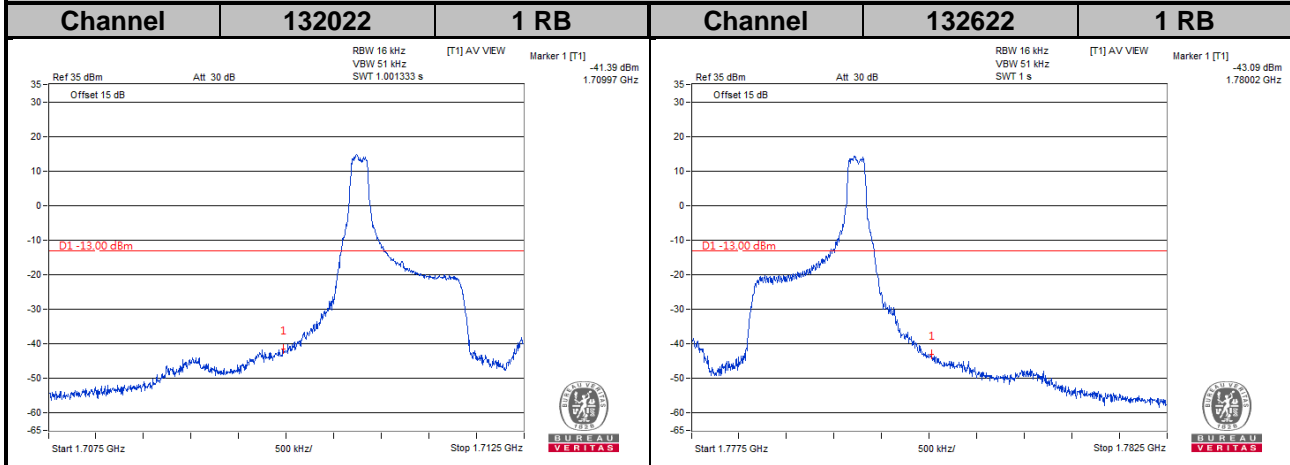

LTE Band 66
Channel Bandwidth: 15 MHz

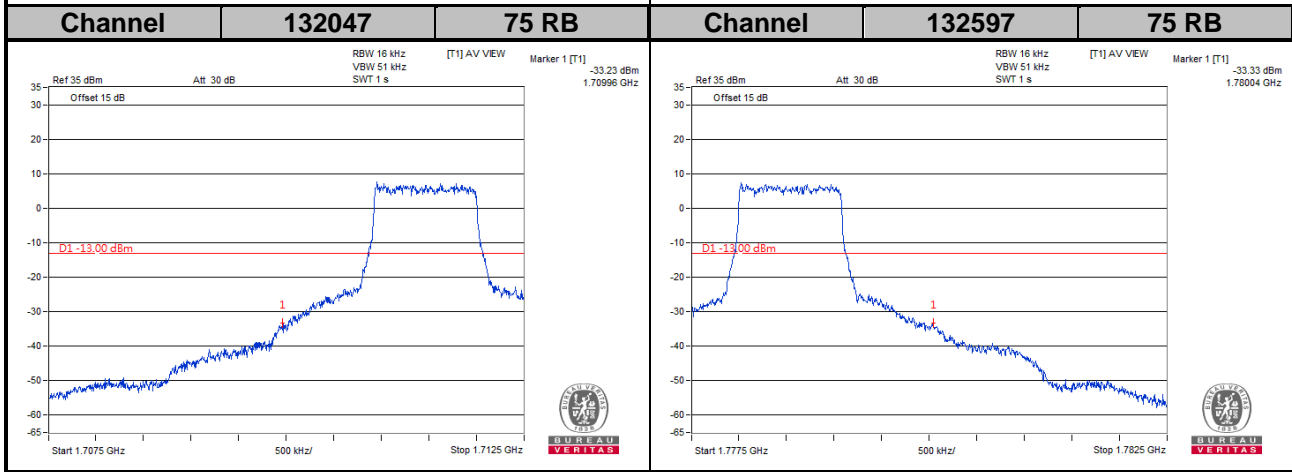
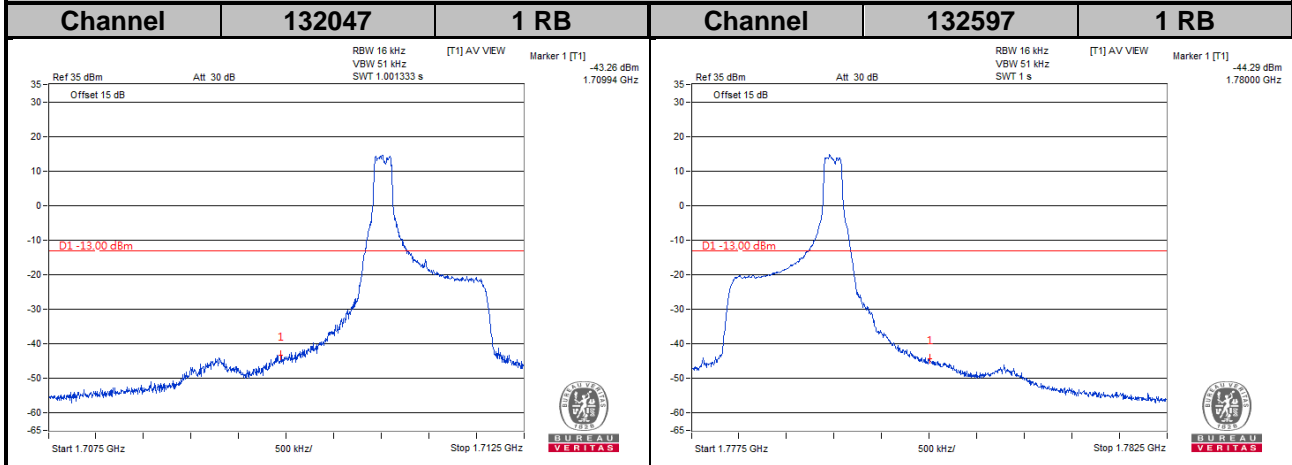

LTE Band 66
Channel Bandwidth: 20 MHz

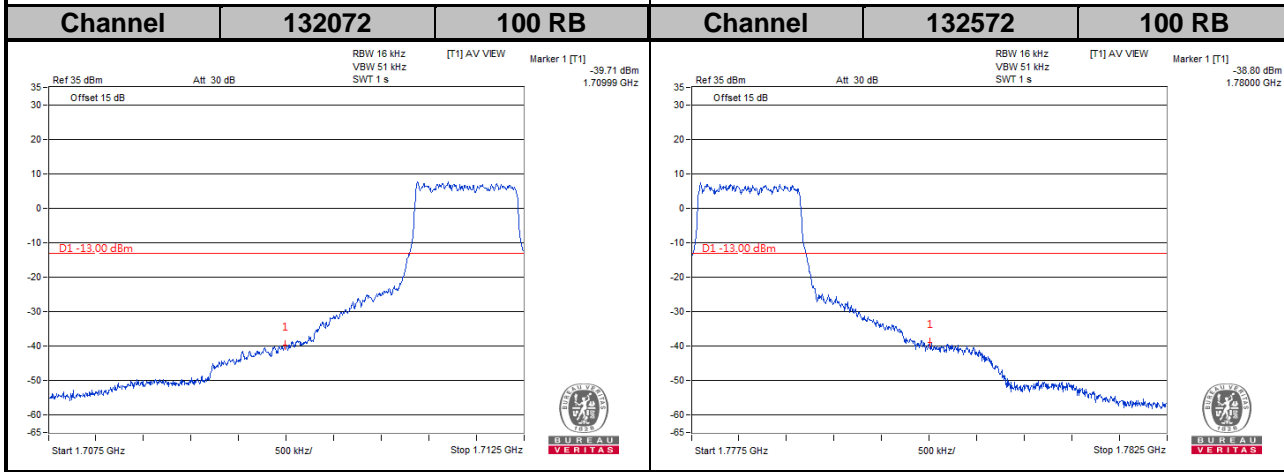
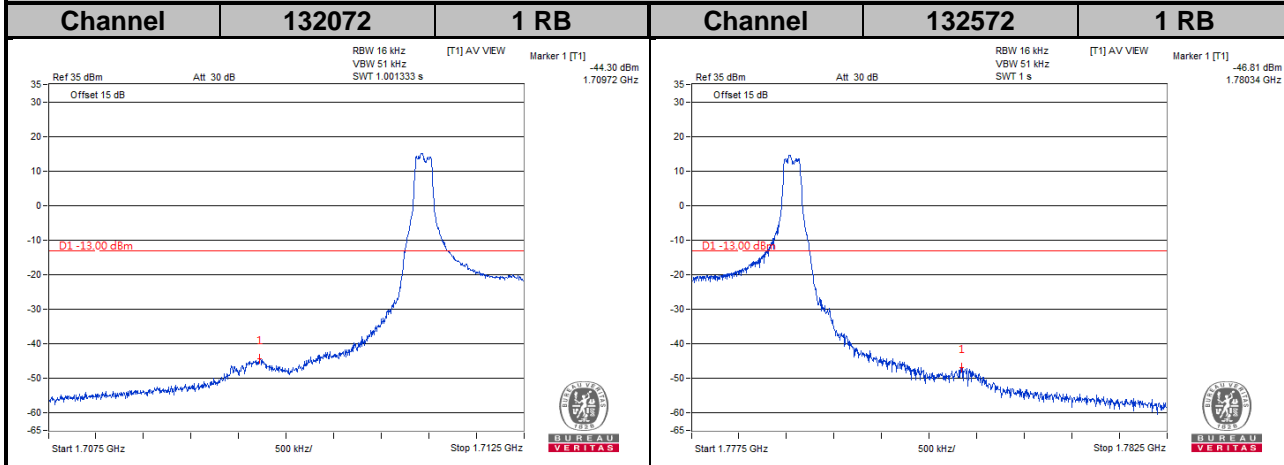

Emission Mask

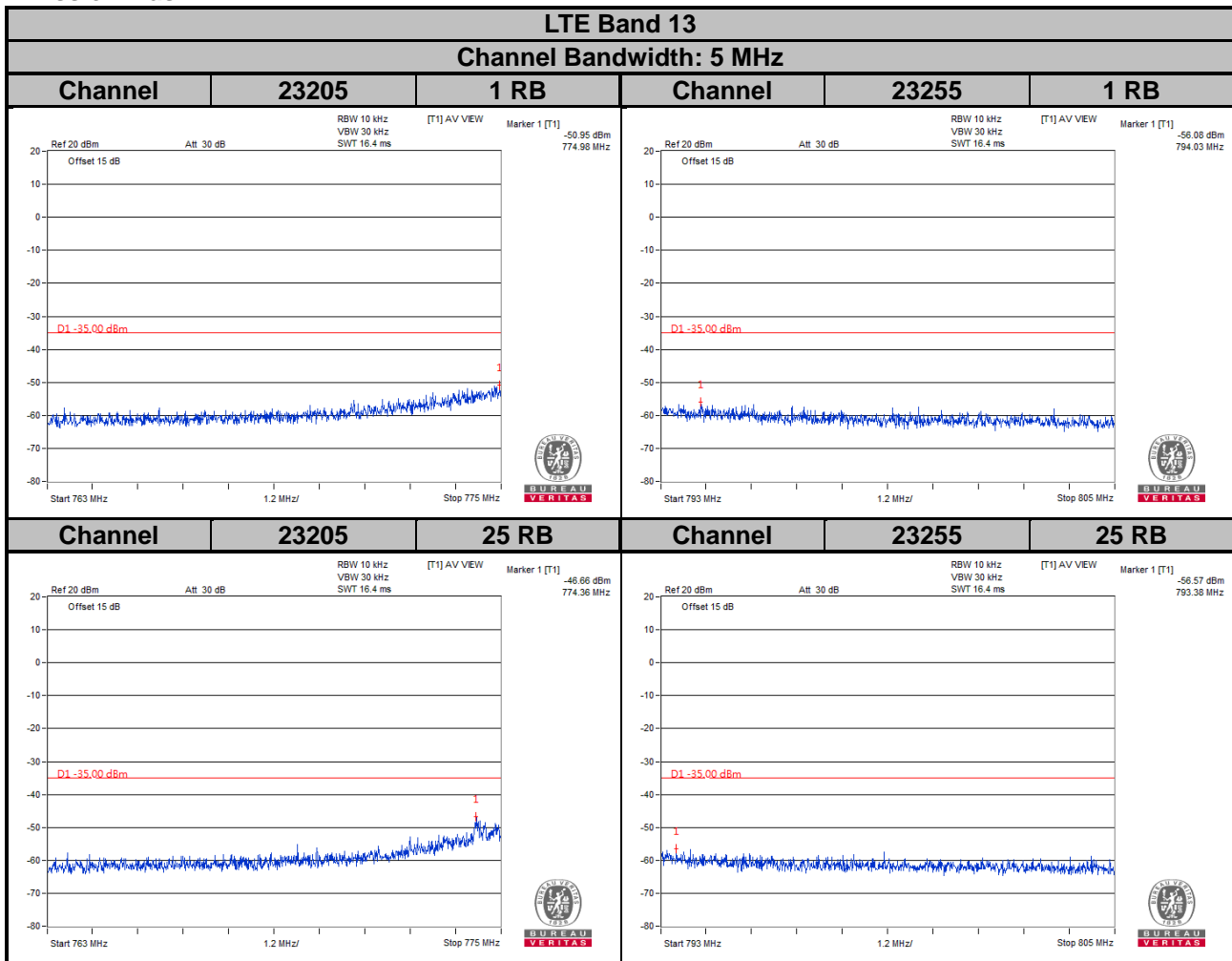

For the 763 - 775 MHz and 793 - 805 MHz band, the FCC limit is $65 + 10\log(P[\text{watt}])$ in a 6.25 kHz bandwidth. Since it was not possible to set the resolution bandwidth to 6.25 kHz with the available equipment, a bandwidth of 10 kHz was used instead to show compliance. By using a 10 kHz bandwidth on the spectrum analyzer.

$$10\log(10\text{kHz}/6.25\text{kHz}) = 2.04 \text{ dB}$$

$$\text{Limit line} = -35 \text{ dBm} + 2.04 \text{ dB} = -32.96 \text{ dBm}$$

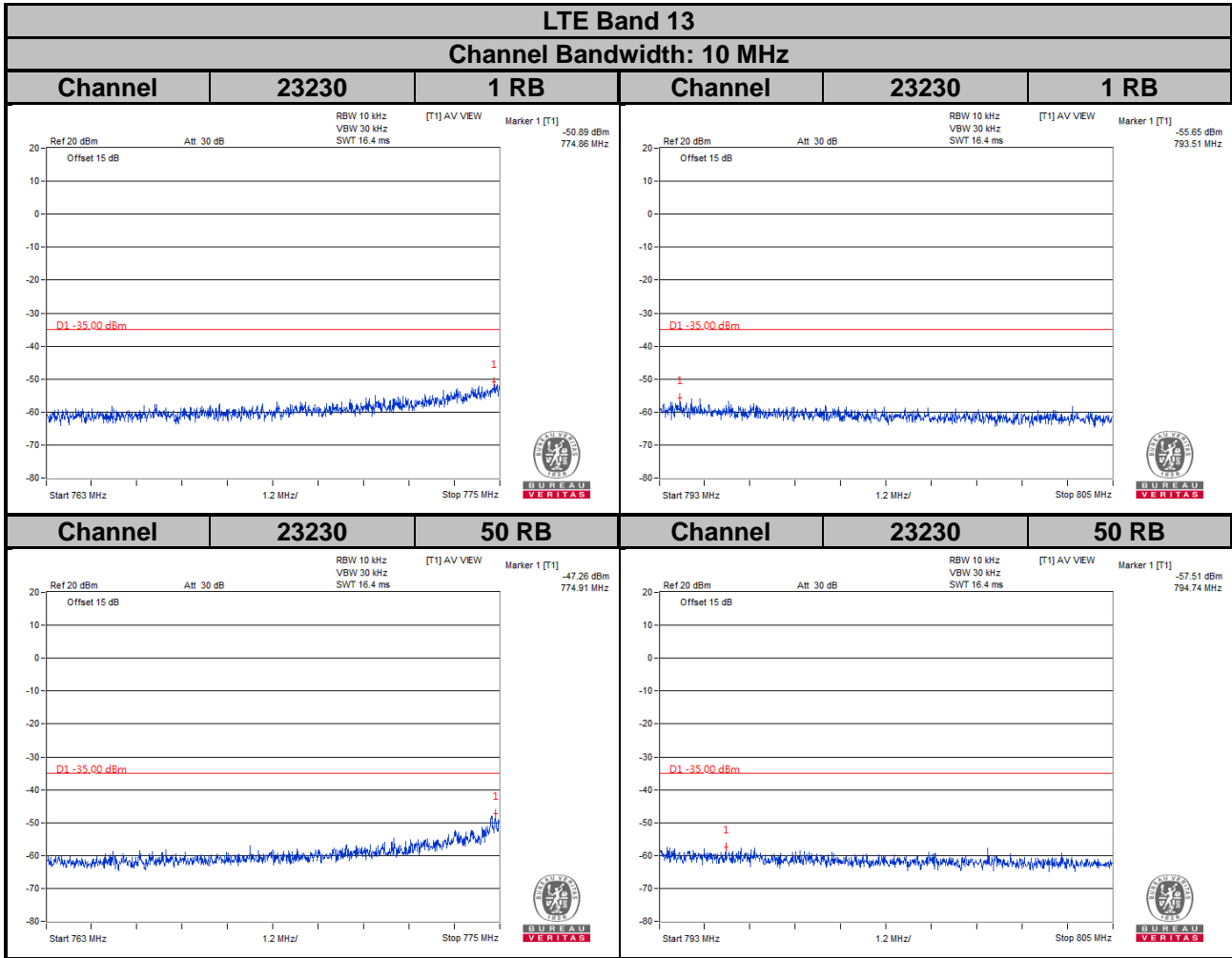

For the 763 - 775 MHz and 793 - 805 MHz band, the FCC limit is $65+10\log(P[\text{watt}])$ in a 6.25 kHz bandwidth. Since it was not possible to set the resolution bandwidth to 6.25 kHz with the available equipment, a bandwidth of 10 kHz was used instead to show compliance. By using a 10 kHz bandwidth on the spectrum analyzer.

$$10\log(10\text{kHz}/6.25\text{kHz}) = 2.04 \text{ dB}$$

$$\text{Limit line} = -35 \text{ dBm} + 2.04 \text{ dB} = -32.96 \text{ dBm}$$

4.6 Peak to Average Ratio

4.6.1 Limits of Peak to Average Ratio Measurement

In measuring transmissions in this band using an average power technique, the peak to-average ratio (PAR) of the transmission may not exceed 13 dB.

4.6.2 Test Setup

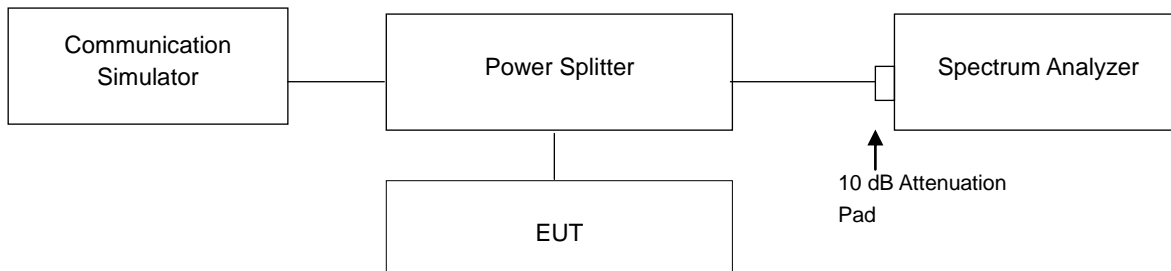

4.6.3 Test Procedures

1. Set resolution/measurement bandwidth \geq signal's occupied bandwidth;
2. Set the number of counts to a value that stabilizes the measured CCDF curve;
3. Record the maximum PAPR level associated with a probability of 0.1 %.

4.6.4 Test Results

LTE Band 4							
Channel Bandwidth: 1.4 MHz				Channel Bandwidth: 3 MHz			
Channel	Frequency (MHz)	Peak to Average Ratio (dB)		Channel	Frequency (MHz)	Peak to Average Ratio (dB)	
		QPSK	16QAM			QPSK	16QAM
19957	1710.7	6.25	6.62	19965	1711.5	6.75	6.69
20175	1732.5	6.66	6.58	20175	1732.5	6.75	6.63
20393	1754.3	6.50	6.49	20385	1753.5	6.63	6.59

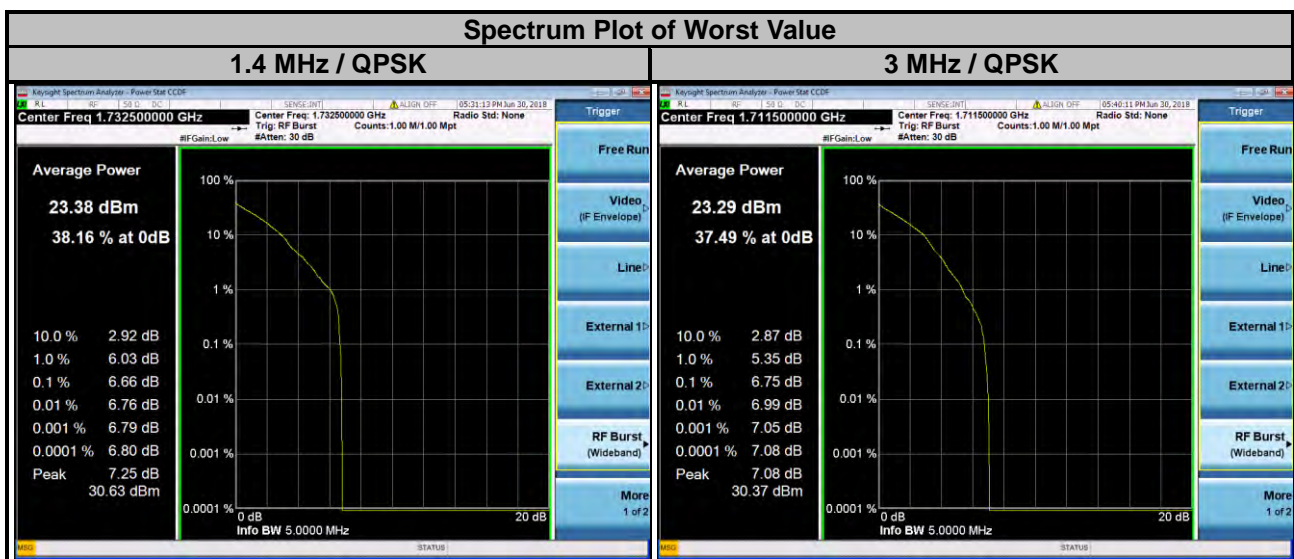

LTE Band 4

Channel Bandwidth: 5 MHz				Channel Bandwidth: 10 MHz			
Channel	Frequency (MHz)	Peak to Average Ratio (dB)		Channel	Frequency (MHz)	Peak to Average Ratio (dB)	
		QPSK	16QAM			QPSK	16QAM
19975	1712.5	7.10	6.98	20000	1715.0	7.42	7.37
20175	1732.5	6.69	6.88	20175	1732.5	7.12	6.74
20375	1752.5	6.74	6.54	20350	1750.0	7.05	6.94

Spectrum Plot of Worst Value

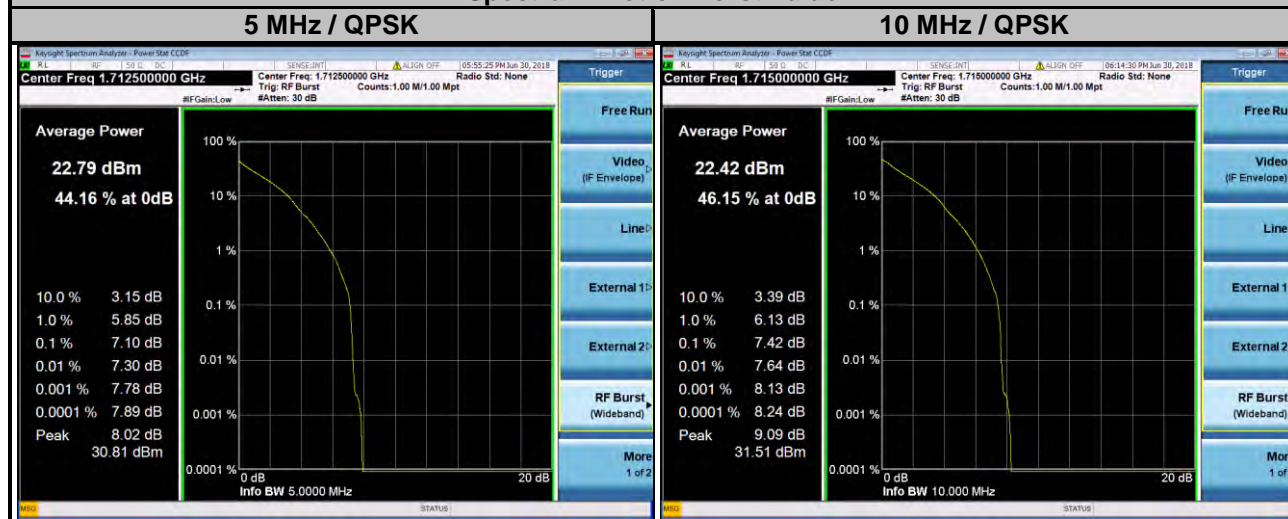

LTE Band 4

Channel Bandwidth: 15 MHz				Channel Bandwidth: 20 MHz			
Channel	Frequency (MHz)	Peak to Average Ratio (dB)		Channel	Frequency (MHz)	Peak to Average Ratio (dB)	
		QPSK	16QAM			QPSK	16QAM
20025	1717.5	7.37	7.09	20050	1720.0	7.26	6.85
20175	1732.5	7.16	7.10	20175	1732.5	7.60	7.44
20325	1747.5	7.71	7.42	20300	1745.0	6.97	7.02

Spectrum Plot of Worst Value

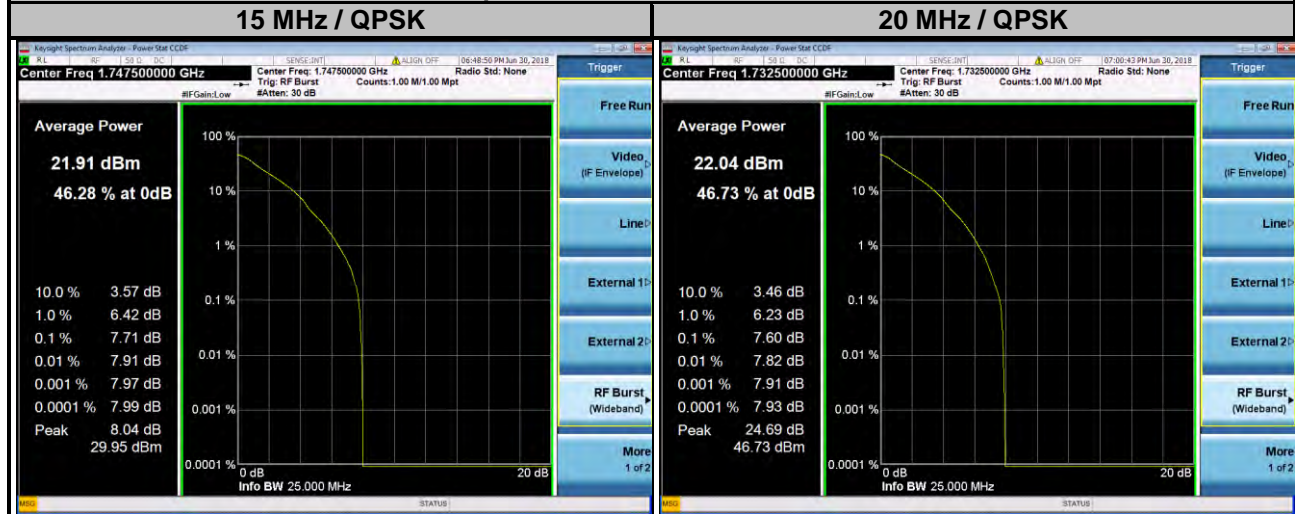

LTE Band 12

Channel Bandwidth: 1.4 MHz				Channel Bandwidth: 3 MHz			
Channel	Frequency (MHz)	Peak to Average Ratio (dB)		Channel	Frequency (MHz)	Peak to Average Ratio (dB)	
		QPSK	16QAM			QPSK	16QAM
23017	699.7	7.02	6.30	23025	700.5	6.91	6.33
23095	707.5	6.77	6.30	23095	707.5	6.70	6.32
23173	715.3	6.72	6.26	23165	714.5	6.84	6.28

Spectrum Plot of Worst Value

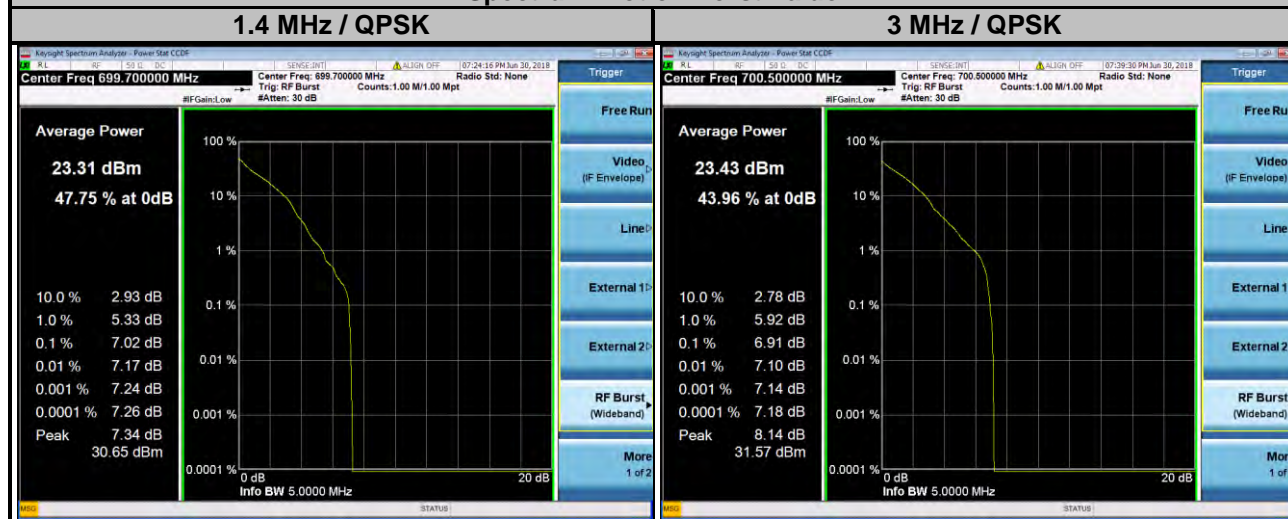

LTE Band 12

Channel Bandwidth: 5 MHz				Channel Bandwidth: 10 MHz			
Channel	Frequency (MHz)	Peak to Average Ratio (dB)		Channel	Frequency (MHz)	Peak to Average Ratio (dB)	
		QPSK	16QAM			QPSK	16QAM
23035	701.5	7.27	7.07	23060	704.0	7.59	7.21
23095	707.5	7.05	7.05	23095	707.5	7.09	7.31
23155	713.5	6.47	7.06	23130	711.0	7.94	7.09

Spectrum Plot of Worst Value



LTE Band 13

Channel Bandwidth: 5 MHz				Channel Bandwidth: 10 MHz			
Channel	Frequency (MHz)	Peak to Average Ratio (dB)		Channel	Frequency (MHz)	Peak to Average Ratio (dB)	
		QPSK	16QAM			QPSK	16QAM
23205	779.5	6.29	6.46	23230	782.0	6.39	6.32
23230	782.0	6.27	6.33				
23255	784.5	6.10	6.41				

Spectrum Plot of Worst Value

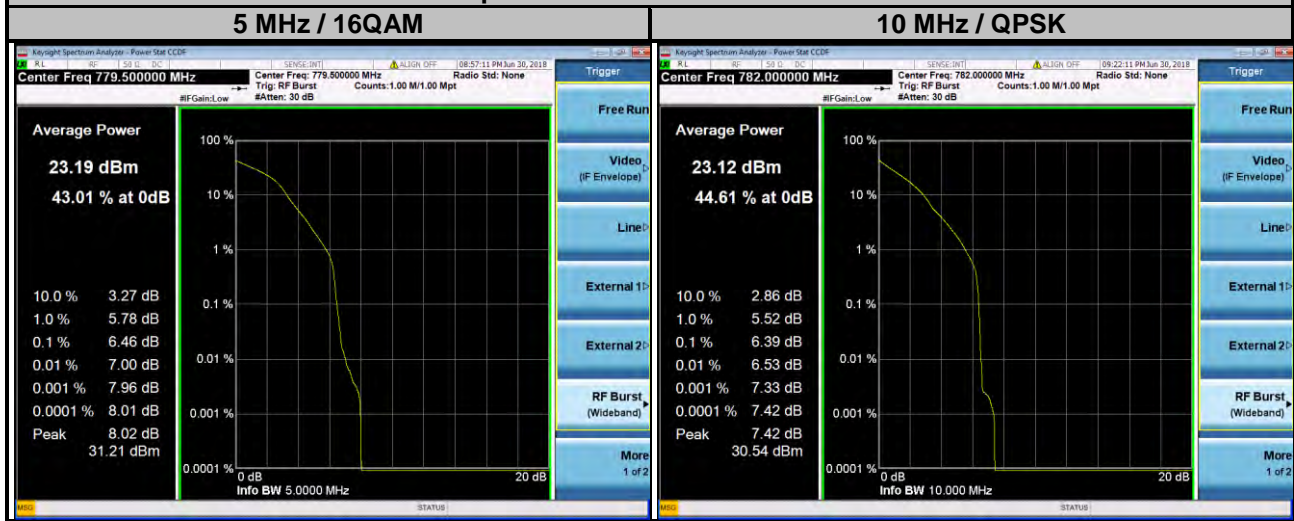

LTE Band 17

Channel Bandwidth: 5 MHz				Channel Bandwidth: 10 MHz			
Channel	Frequency (MHz)	Peak to Average Ratio (dB)		Channel	Frequency (MHz)	Peak to Average Ratio (dB)	
		QPSK	16QAM			QPSK	16QAM
23755	706.5	6.82	7.21	23780	709.0	6.68	7.18
23790	710.0	6.43	7.14	23790	710.0	6.81	7.87
23825	713.5	6.73	7.12	23800	711.0	6.47	7.12

Spectrum Plot of Worst Value

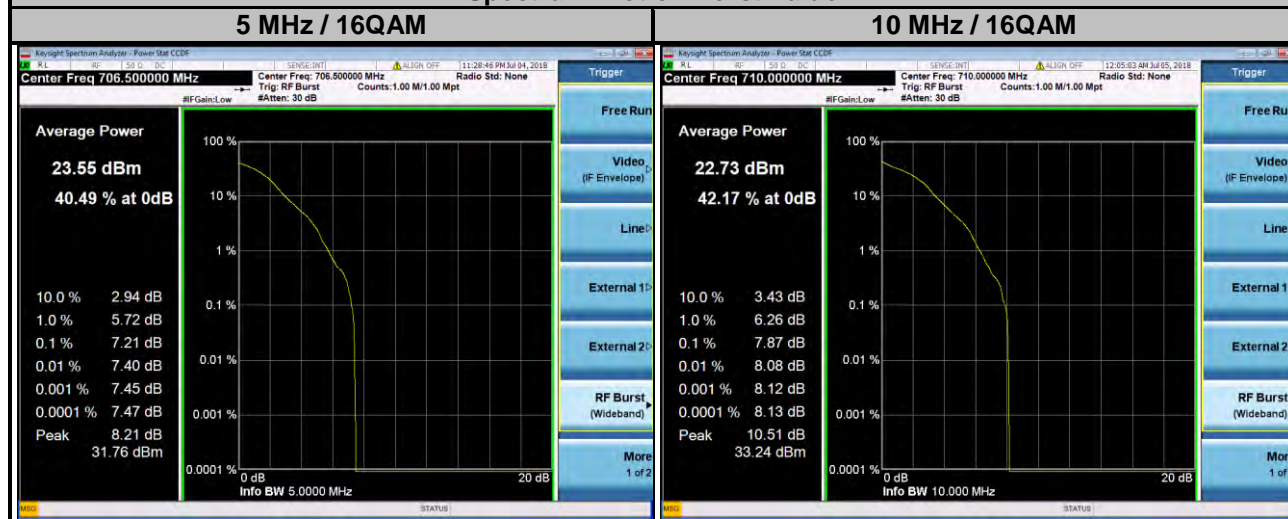

LTE Band 66

Channel Bandwidth: 1.4 MHz				Channel Bandwidth: 3 MHz			
Channel	Frequency (MHz)	Peak to Average Ratio (dB)		Channel	Frequency (MHz)	Peak to Average Ratio (dB)	
		QPSK	16QAM			QPSK	16QAM
131979	1710.7	6.20	7.22	131987	1711.5	6.28	7.31
132322	1745.0	6.01	7.00	132322	1745.0	6.09	7.17
132665	1779.3	5.80	6.78	132657	1778.5	5.87	7.08

Spectrum Plot of Worst Value

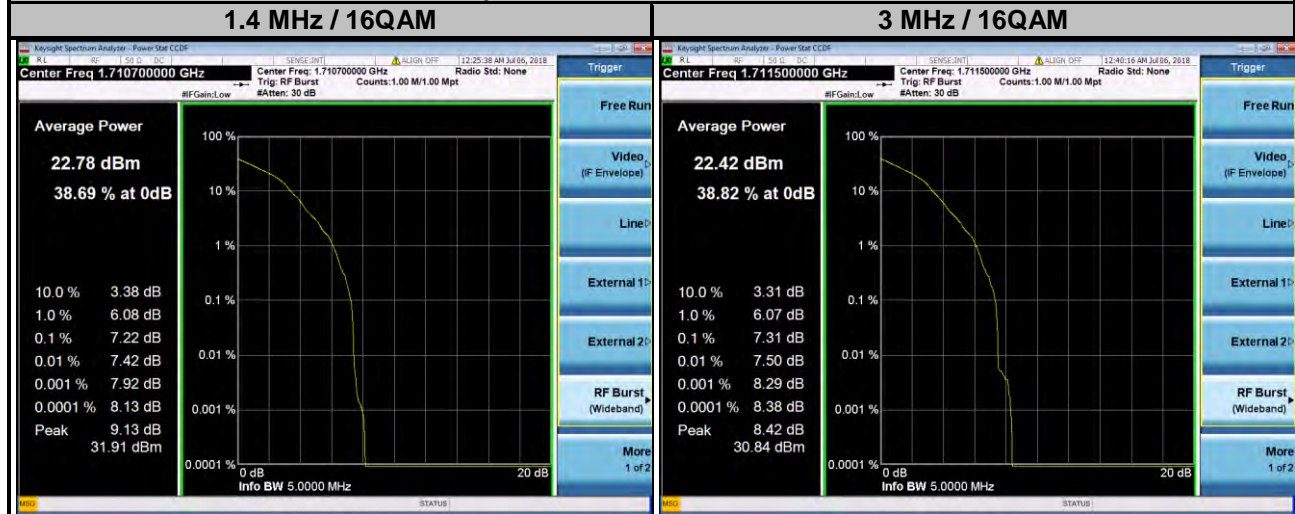

LTE Band 66

Channel Bandwidth: 5 MHz				Channel Bandwidth: 10 MHz			
Channel	Frequency (MHz)	Peak to Average Ratio (dB)		Channel	Frequency (MHz)	Peak to Average Ratio (dB)	
		QPSK	16QAM			QPSK	16QAM
131997	1712.5	6.69	6.95	132022	1715.0	6.57	7.01
132322	1745.0	6.84	7.02	132322	1745.0	6.55	6.46
132647	1777.5	6.16	6.60	132622	1775.0	6.25	6.70

Spectrum Plot of Worst Value

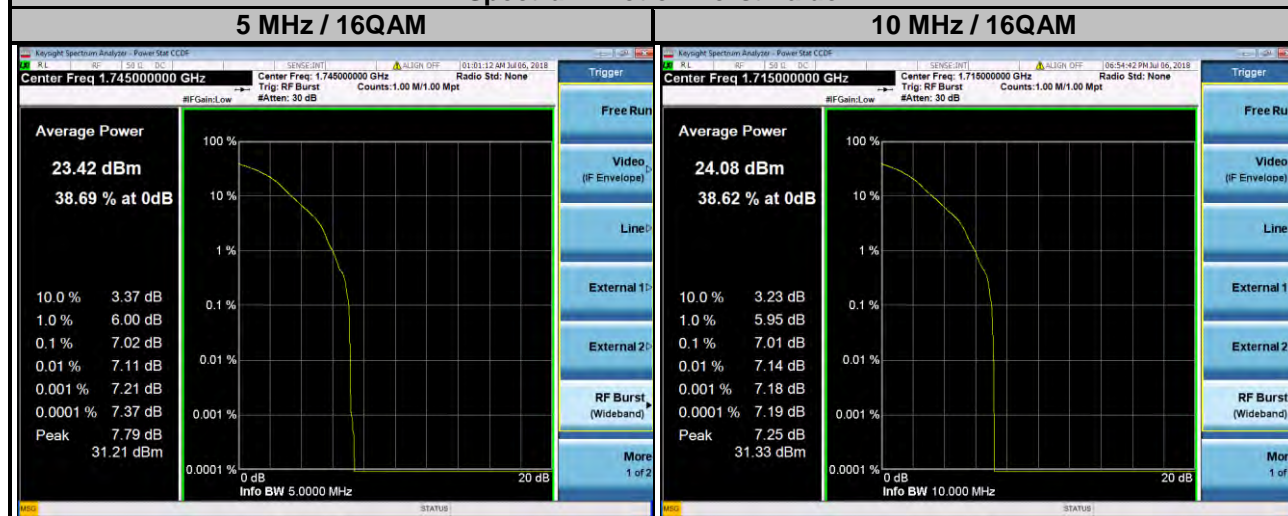

LTE Band 66

Channel Bandwidth: 15 MHz				Channel Bandwidth: 20 MHz			
Channel	Frequency (MHz)	Peak to Average Ratio (dB)		Channel	Frequency (MHz)	Peak to Average Ratio (dB)	
		QPSK	16QAM			QPSK	16QAM
132047	1717.5	7.37	7.47	132072	1720.0	6.50	7.16
132322	1745.0	6.49	7.12	132322	1745.0	6.39	6.80
132597	1772.5	6.29	6.62	132572	1770.0	6.27	6.45

Spectrum Plot of Worst Value

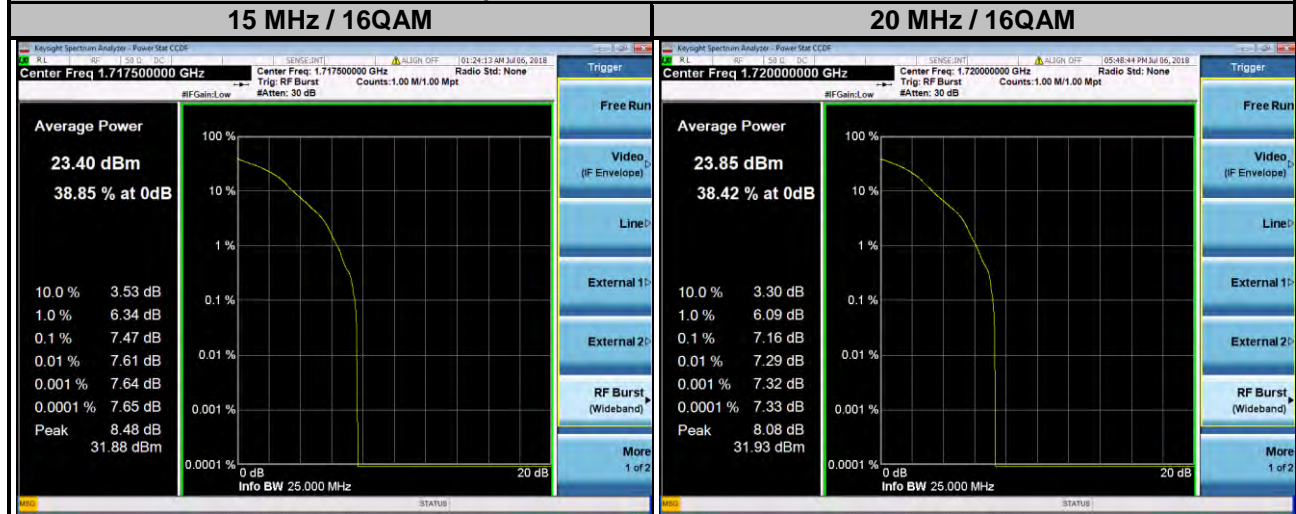

4.7 Conducted Spurious Emissions

4.7.1 Limits of Conducted Spurious Emissions Measurement

The power of any emission outside a licensee's frequency block shall be attenuated below the transmitter power (P) by at least $43 + 10 \log (P)$ dB. The limit of emission is equal to -13 dBm.

4.7.2 Test Setup

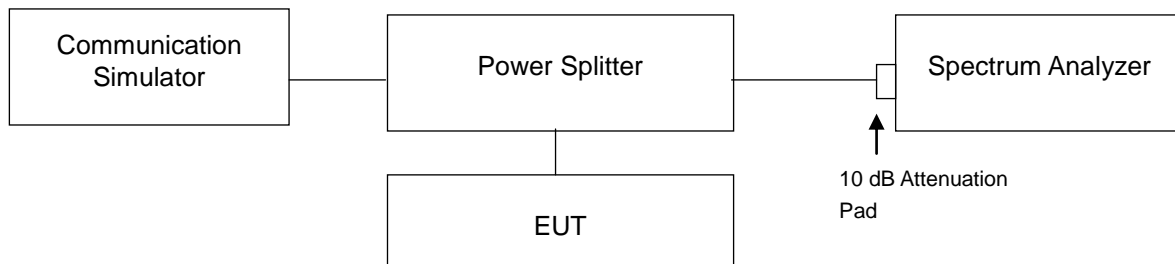

4.7.3 Test Procedure

- The EUT makes a phone call to the communication simulator. All measurements were done at low, middle and high operational frequency range.
- Measuring frequency range is from 30 MHz to 10 GHz for LTE Band 12, 13, 17 and from 30 MHz to 27 GHz for LTE Band 4, 66. 10 dB attenuation pad is connected with spectrum. RBW = 1 MHz and VBW = 3 MHz are used for conducted emission measurement.

4.7.4 Test Results

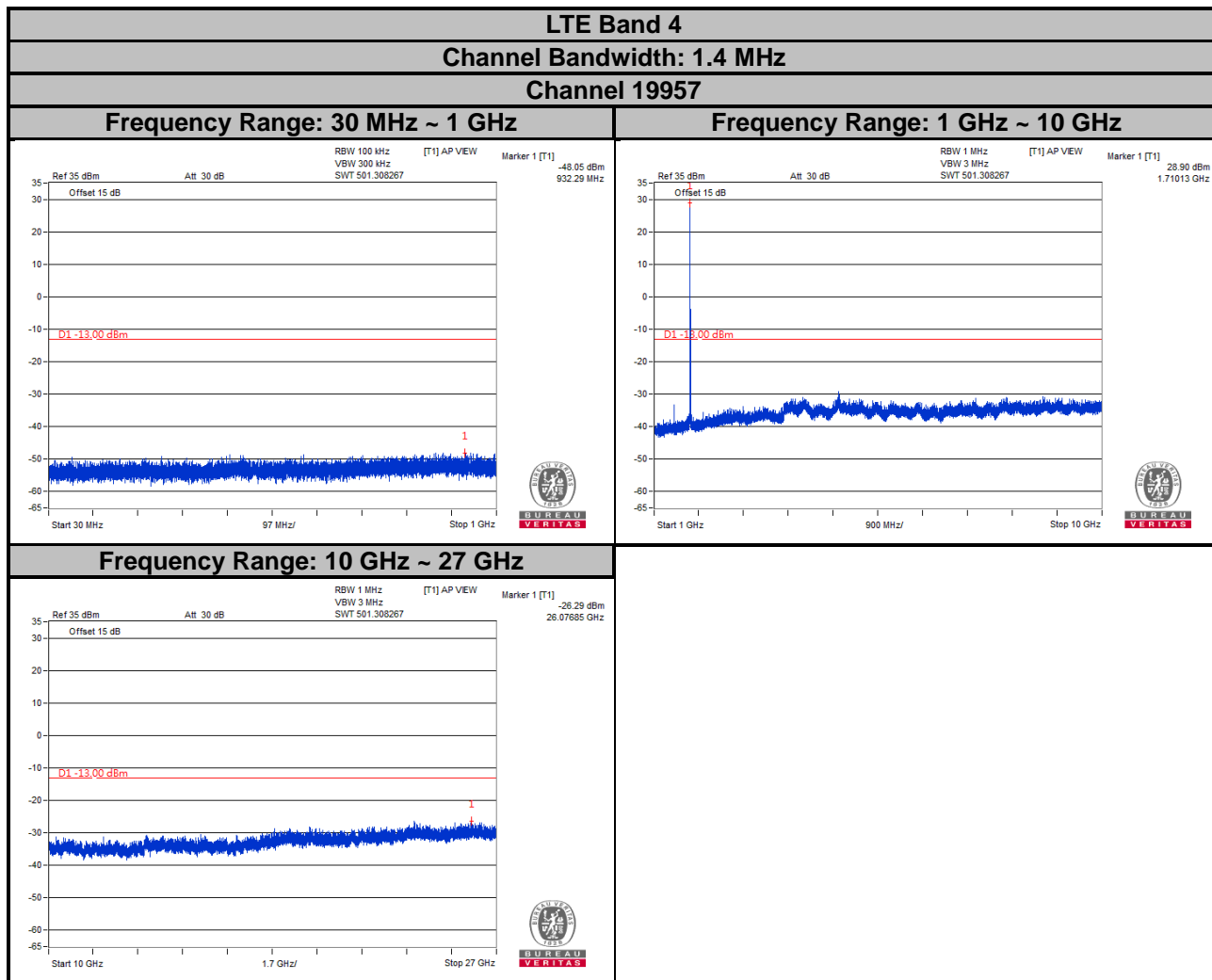

LTE Band 4

Channel Bandwidth: 1.4 MHz

Channel 20175

Frequency Range: 30 MHz ~ 1 GHz

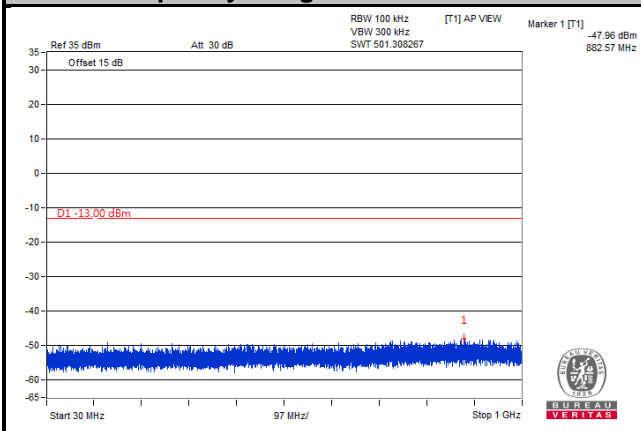

Frequency Range: 1 GHz ~ 10 GHz

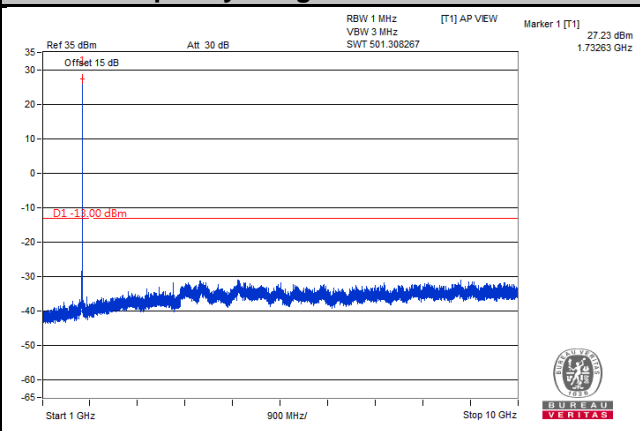

Frequency Range: 10 GHz ~ 27 GHz

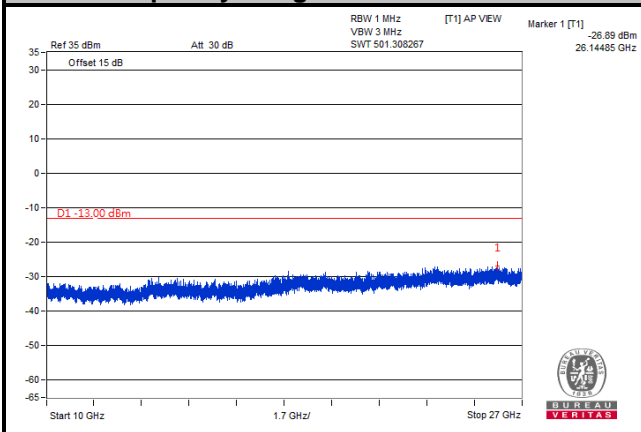

LTE Band 4
Channel Bandwidth: 1.4 MHz
Channel 20393

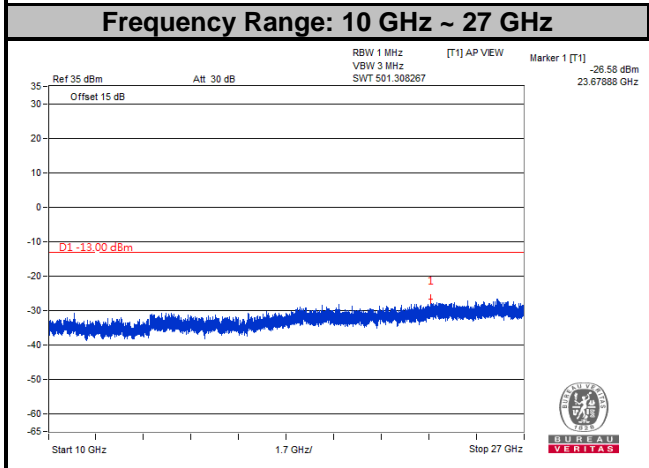
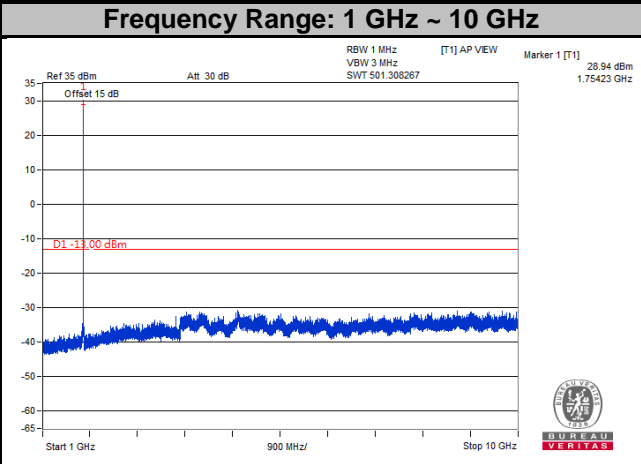
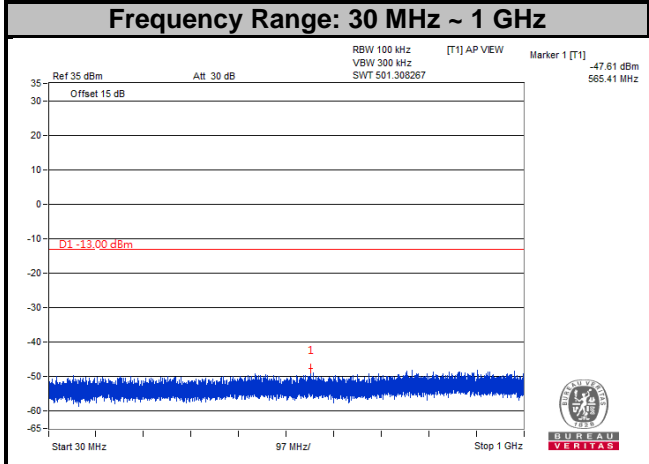

LTE Band 4
Channel Bandwidth: 3 MHz
Channel 19965

Frequency Range: 30 MHz ~ 1 GHz **Frequency Range: 1 GHz ~ 10 GHz**

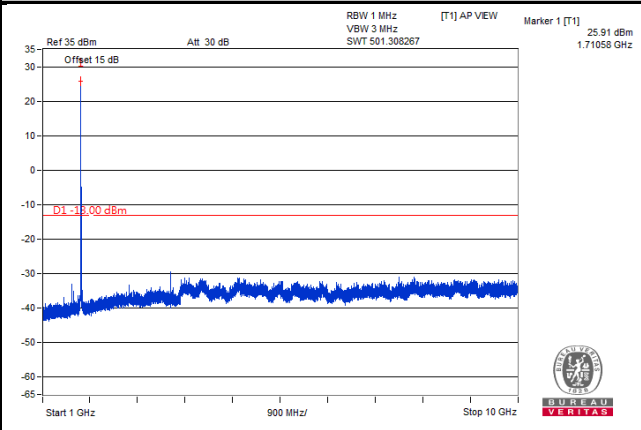
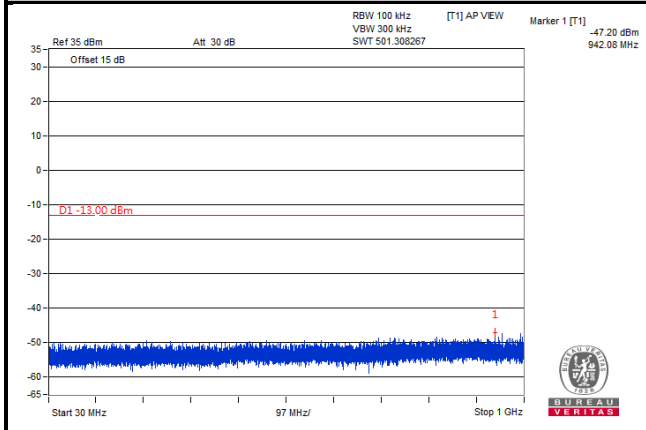

Frequency Range: 10 GHz ~ 27 GHz

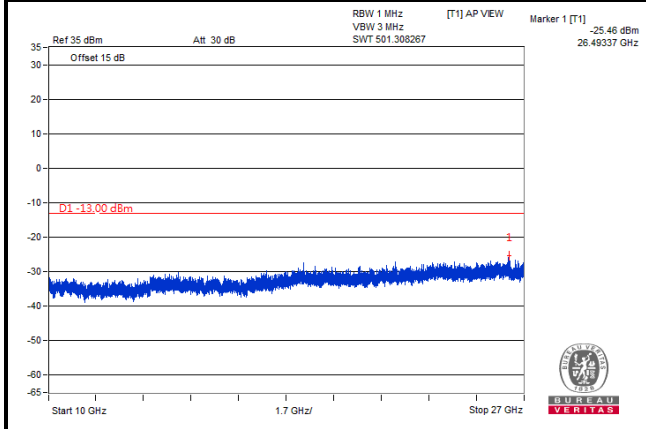

LTE Band 4
Channel Bandwidth: 3 MHz
Channel 20175

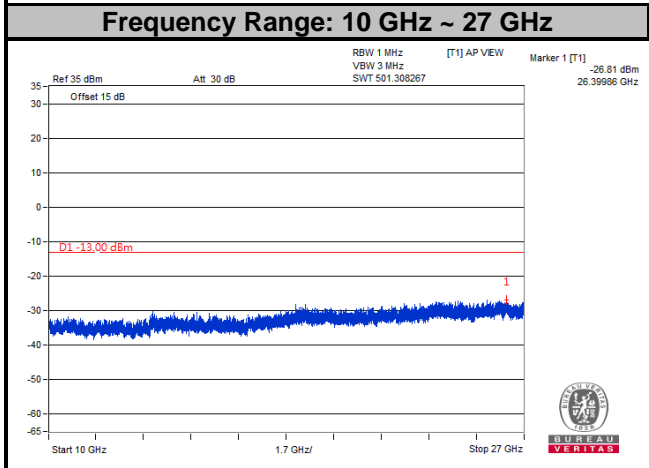
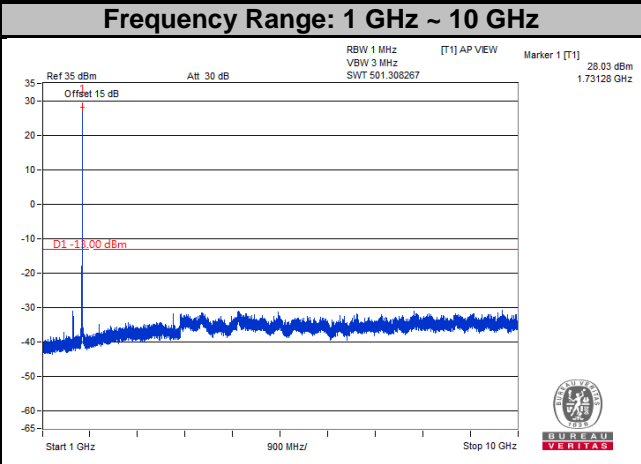
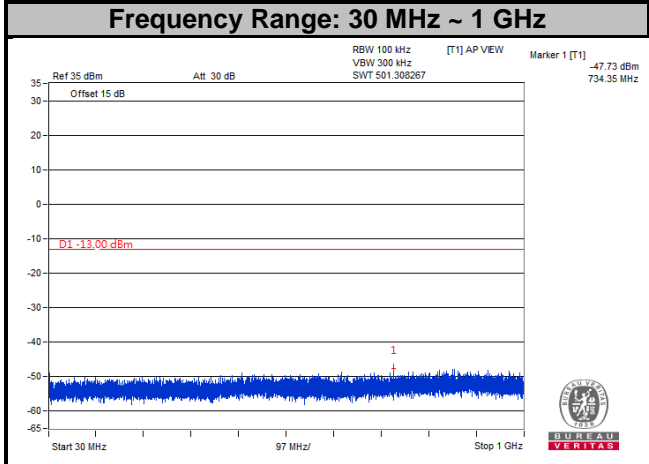

LTE Band 4
Channel Bandwidth: 3 MHz
Channel 20385

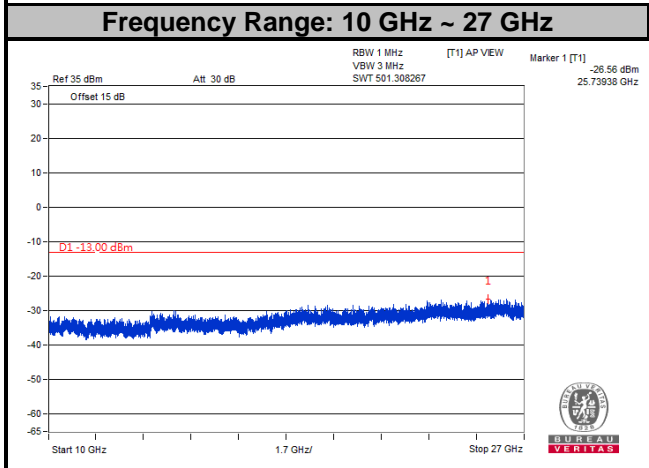
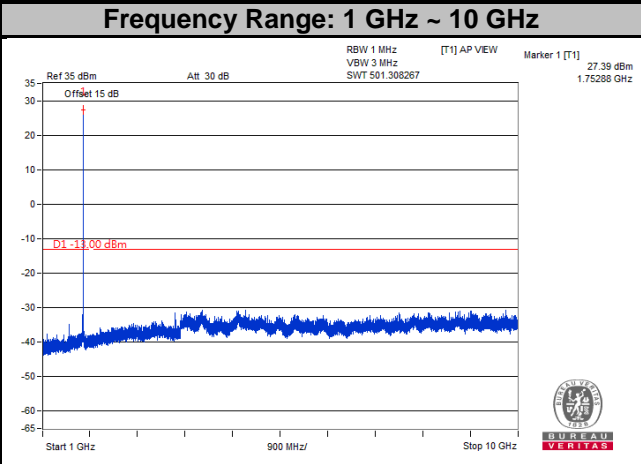
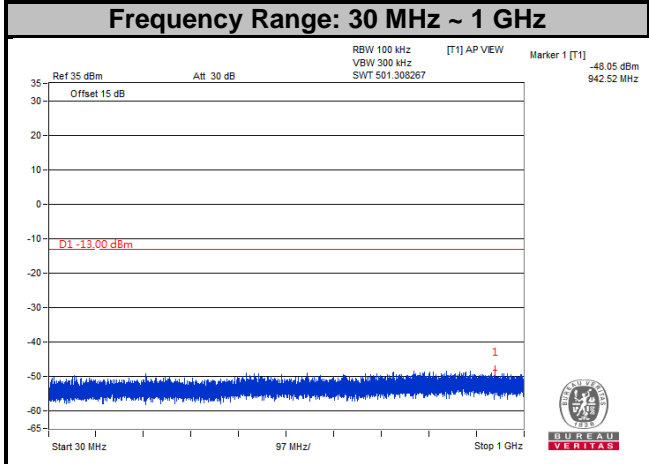

LTE Band 4
Channel Bandwidth: 5 MHz
Channel 19975

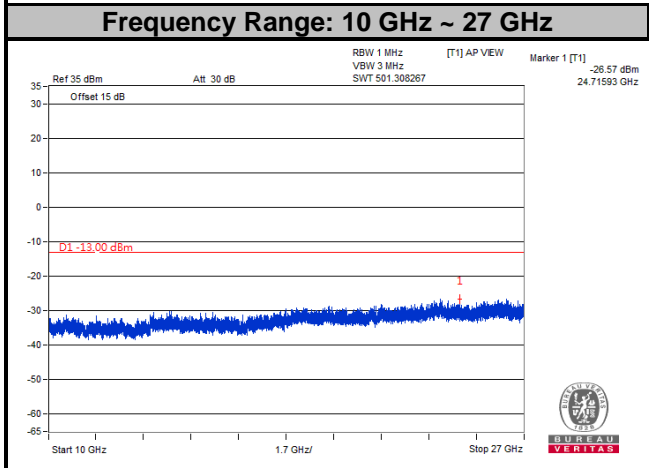
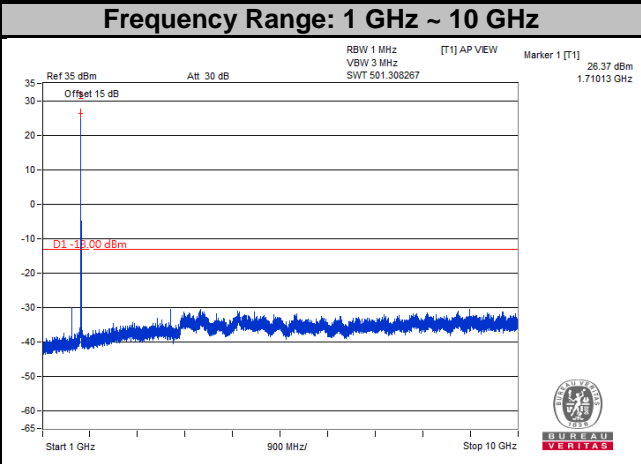
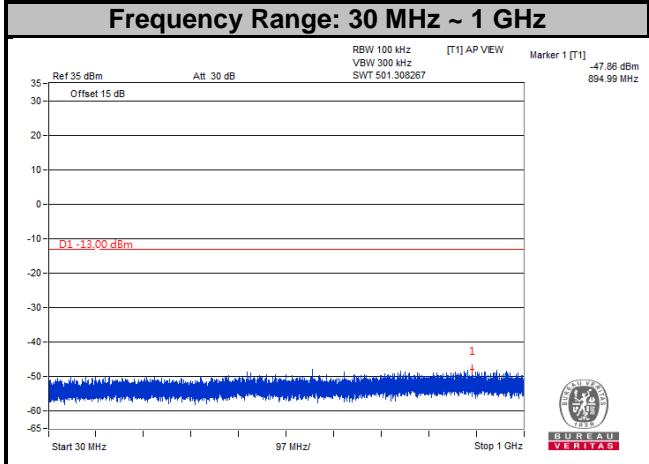

LTE Band 4
Channel Bandwidth: 5 MHz
Channel 20175

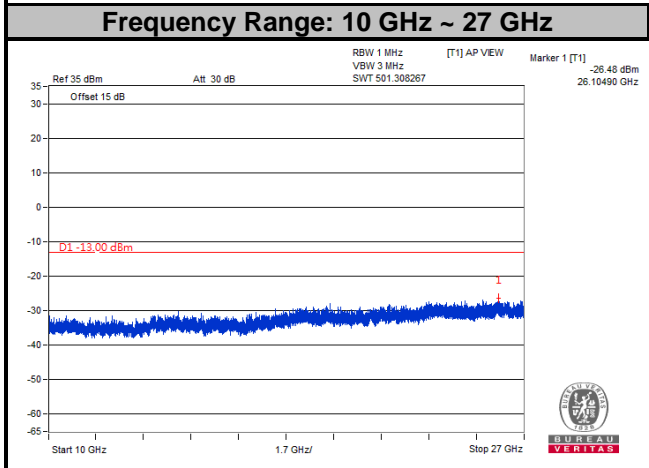
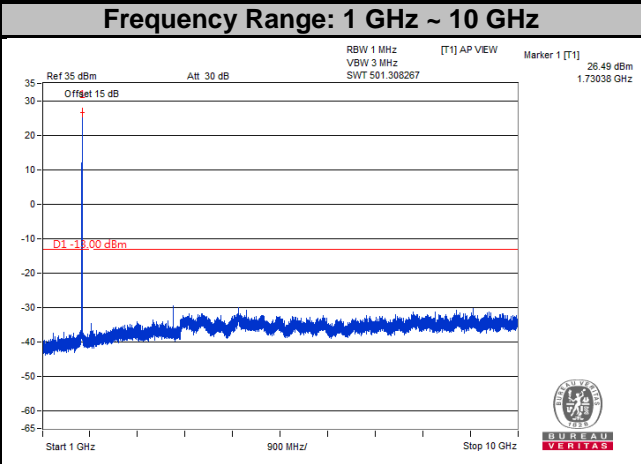
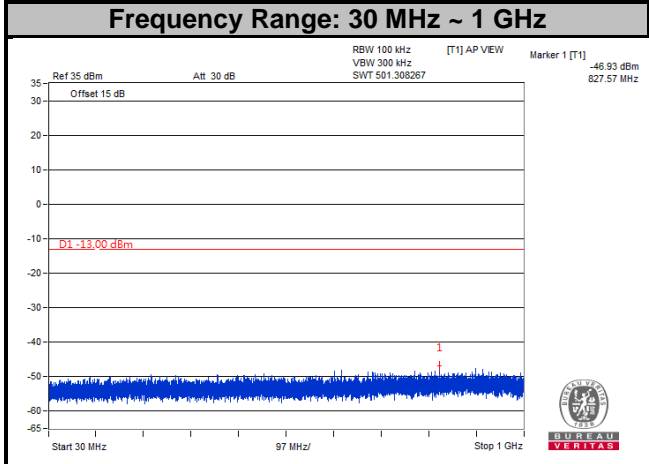

LTE Band 4
Channel Bandwidth: 5 MHz
Channel 20375

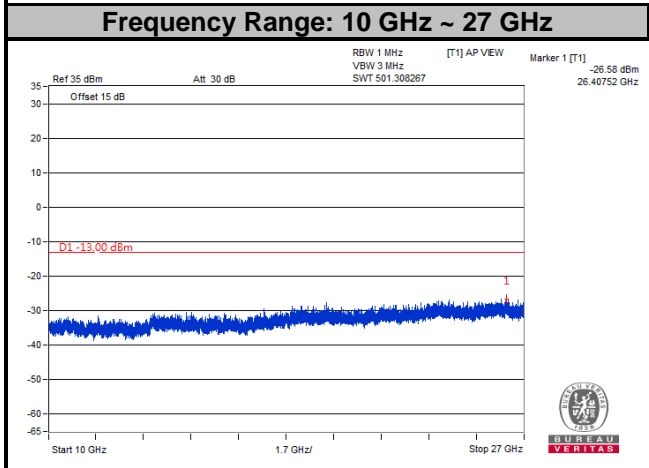
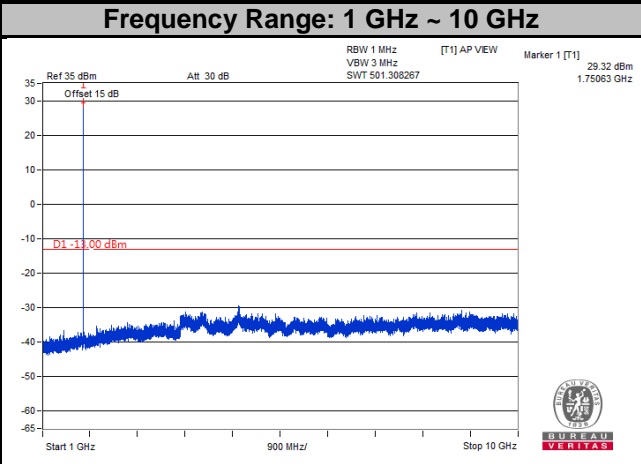
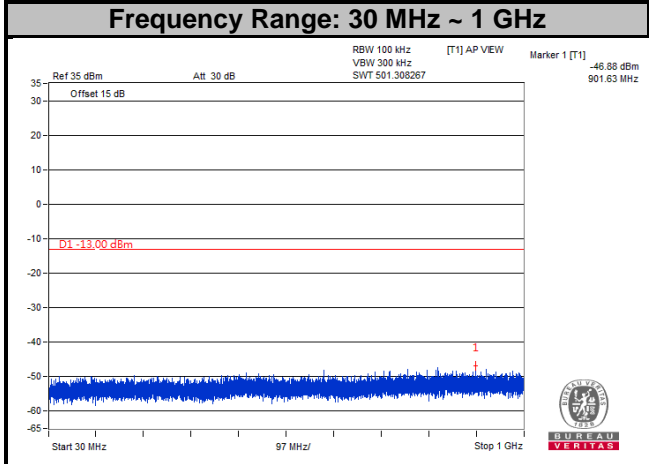

LTE Band 4
Channel Bandwidth: 10 MHz
Channel 20000

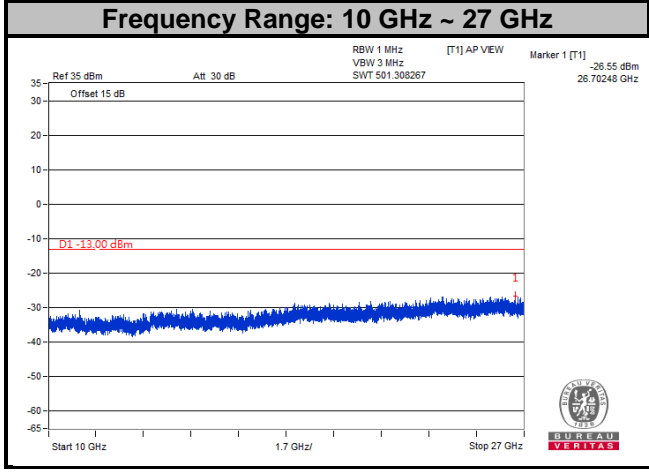
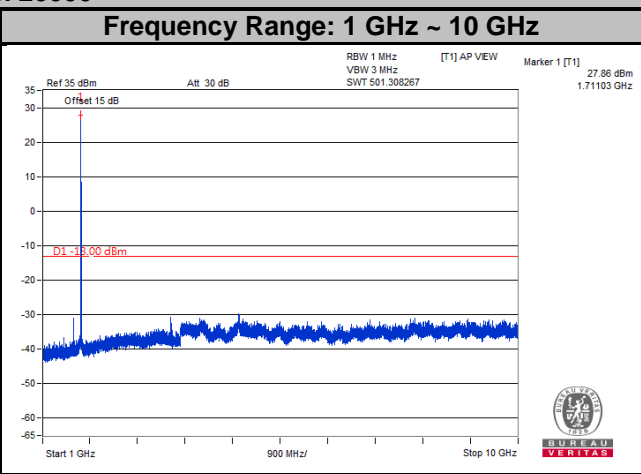
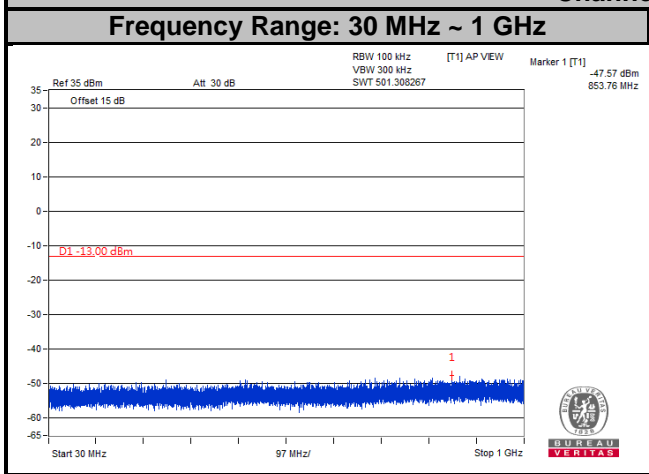

LTE Band 4
Channel Bandwidth: 10 MHz
Channel 20175

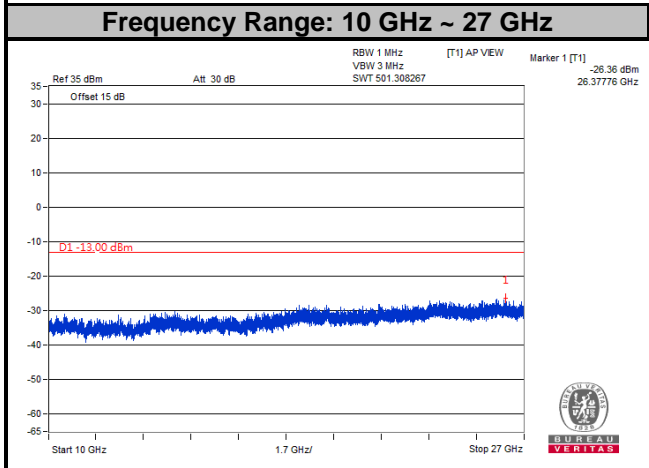
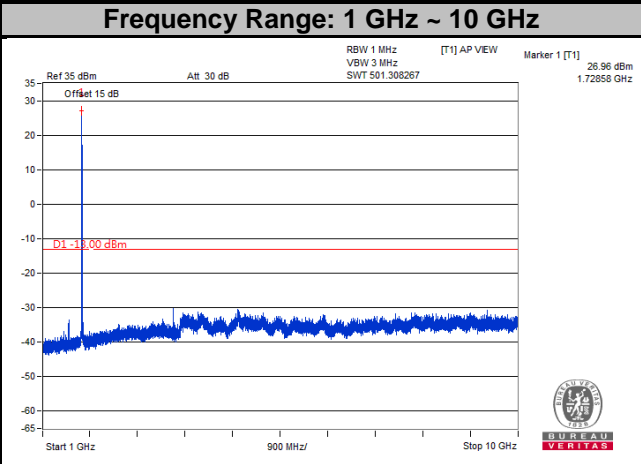
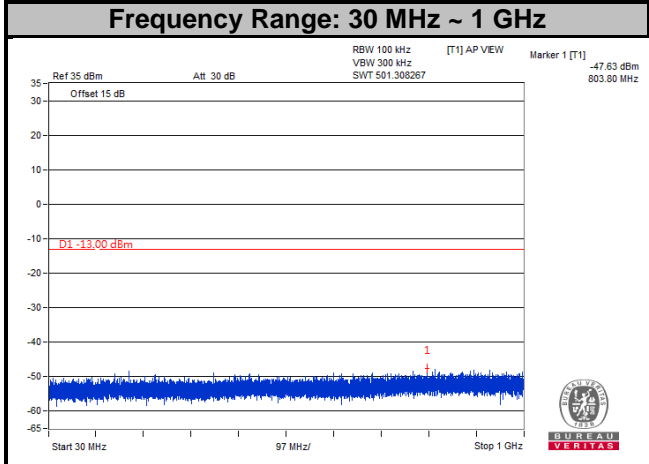

LTE Band 4
Channel Bandwidth: 10 MHz

Channel 20350

Frequency Range: 30 MHz ~ 1 GHz

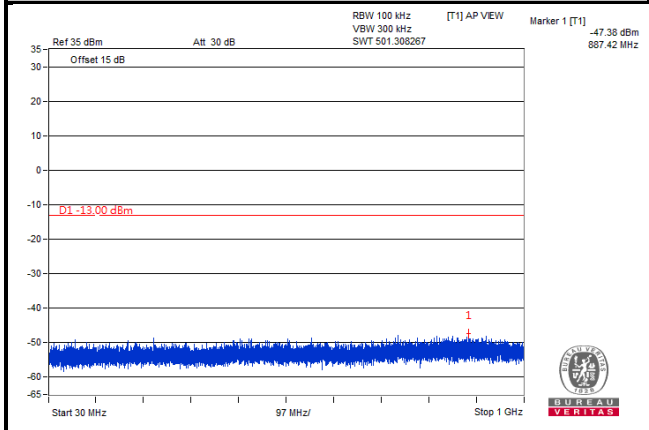

Frequency Range: 1 GHz ~ 10 GHz

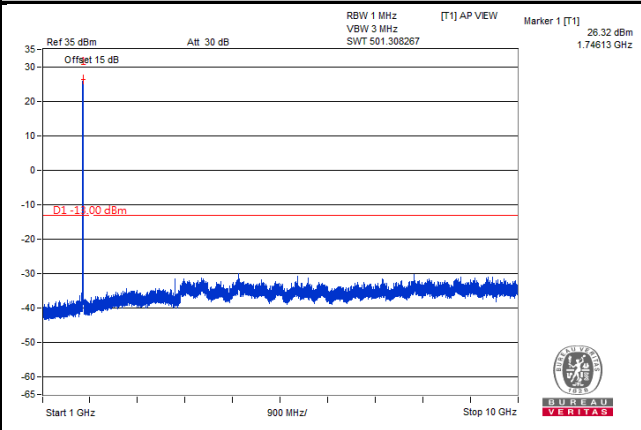

Frequency Range: 10 GHz ~ 27 GHz

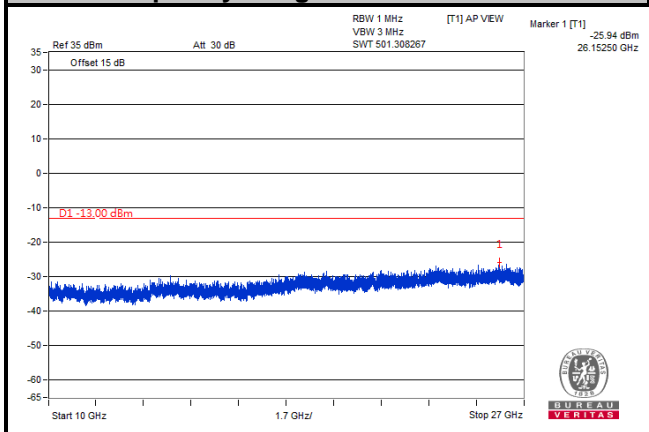

LTE Band 4
Channel Bandwidth: 15 MHz
Channel 20025

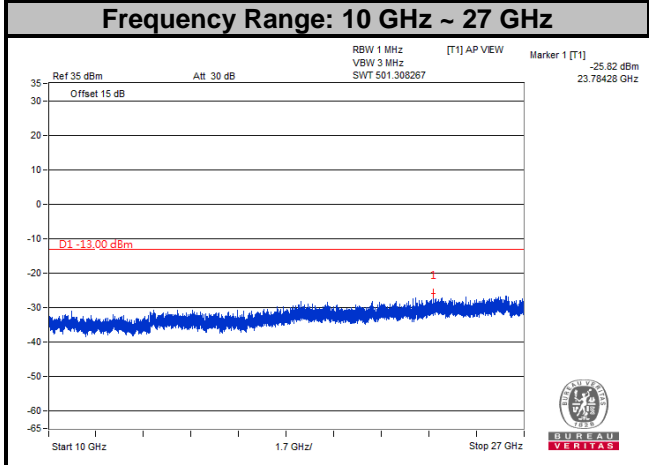
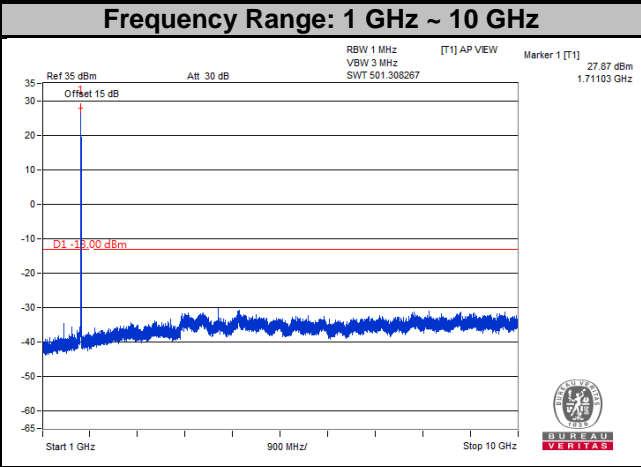
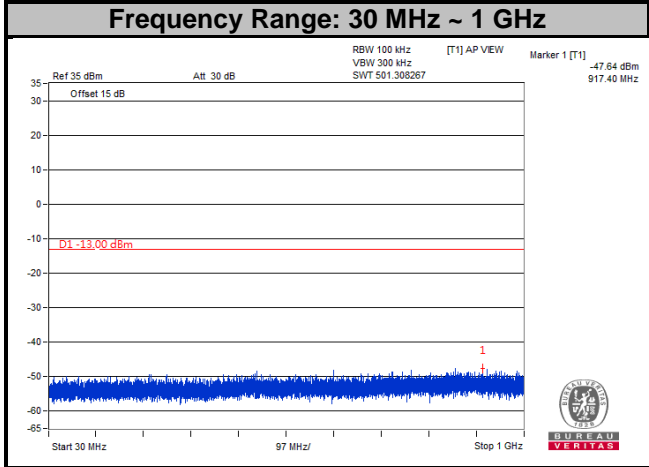

LTE Band 4
Channel Bandwidth: 15 MHz
Channel 20175

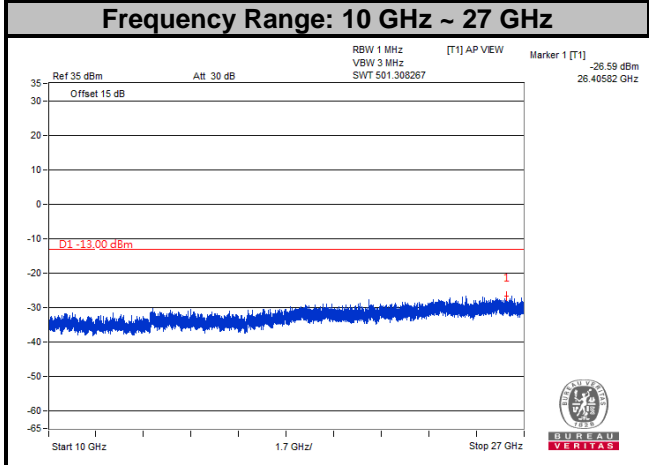
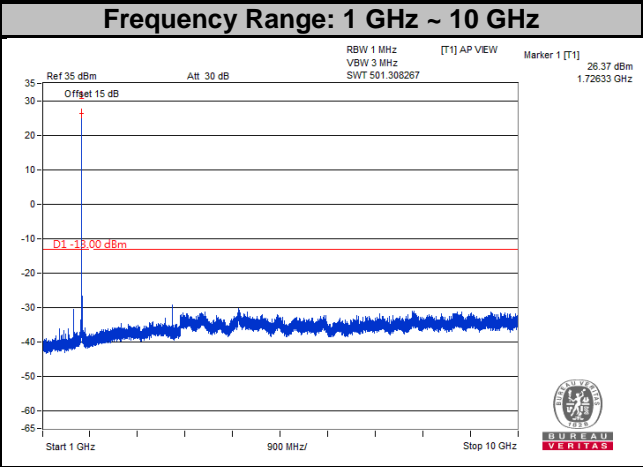
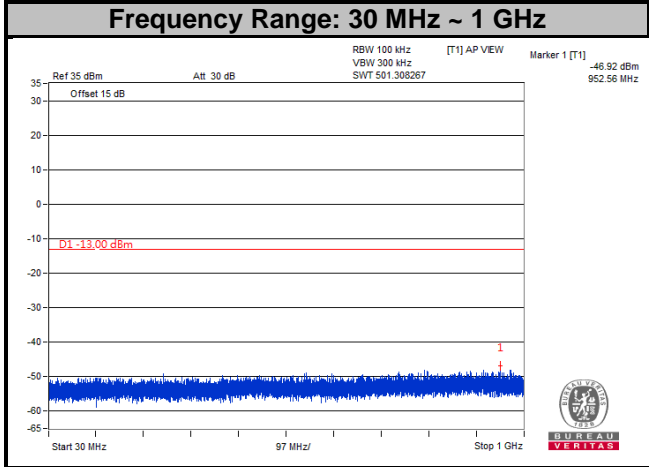

LTE Band 4
Channel Bandwidth: 15 MHz
Channel 20325

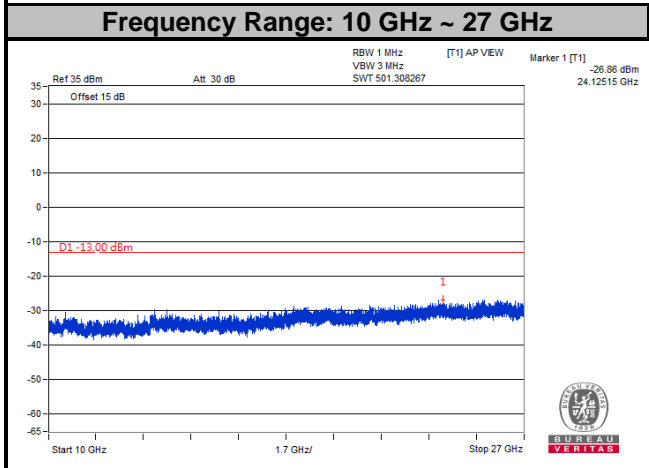
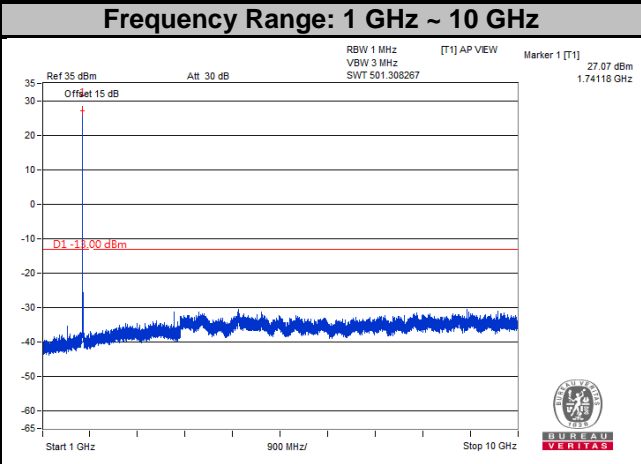
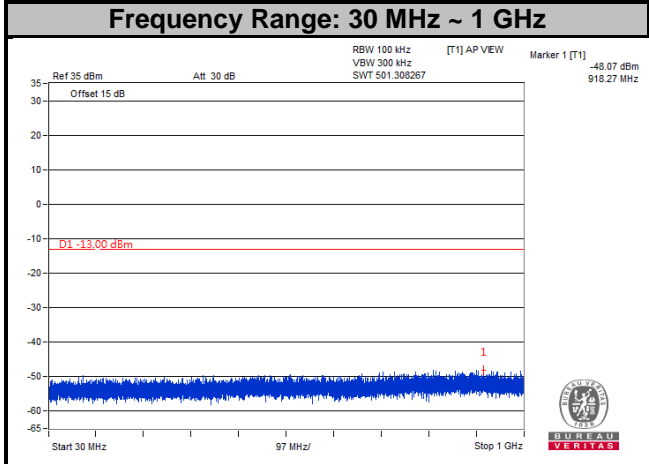

LTE Band 4
Channel Bandwidth: 20 MHz
Channel 20050

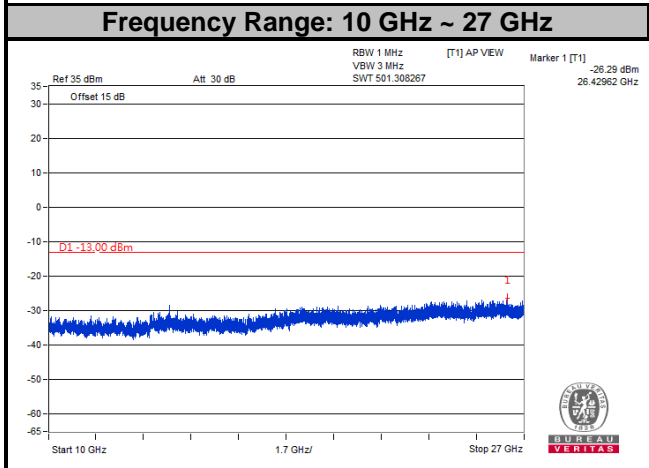
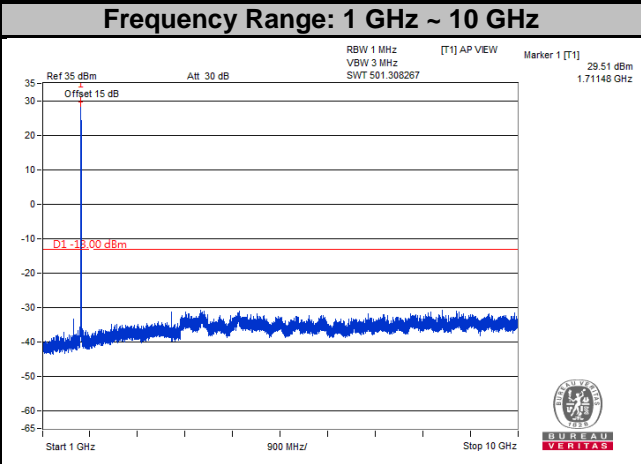
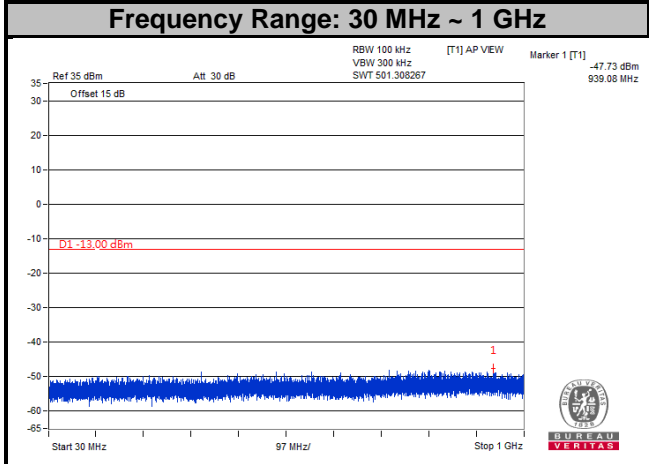

LTE Band 4
Channel Bandwidth: 20 MHz

Channel 20175

Frequency Range: 30 MHz ~ 1 GHz

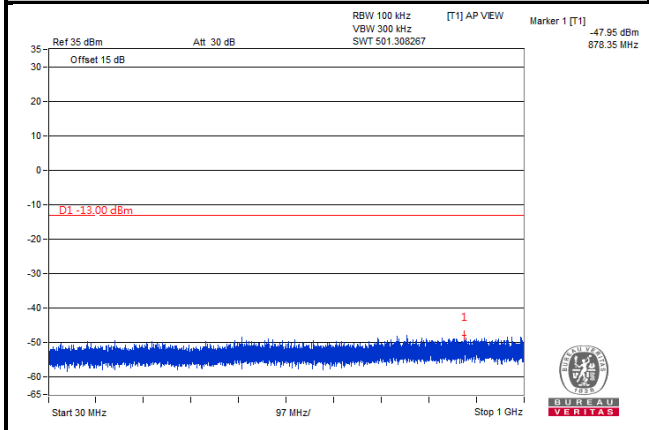

Frequency Range: 1 GHz ~ 10 GHz

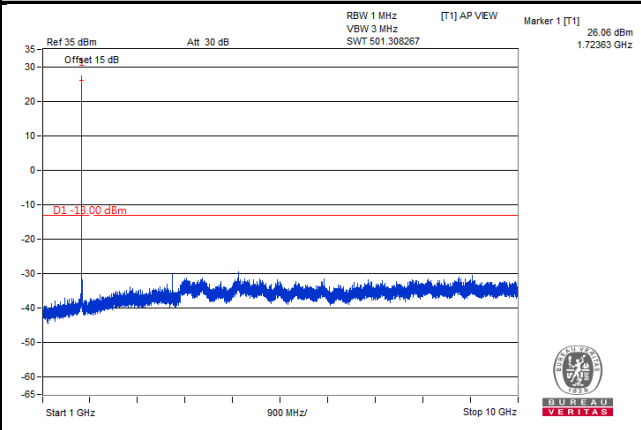

Frequency Range: 10 GHz ~ 27 GHz

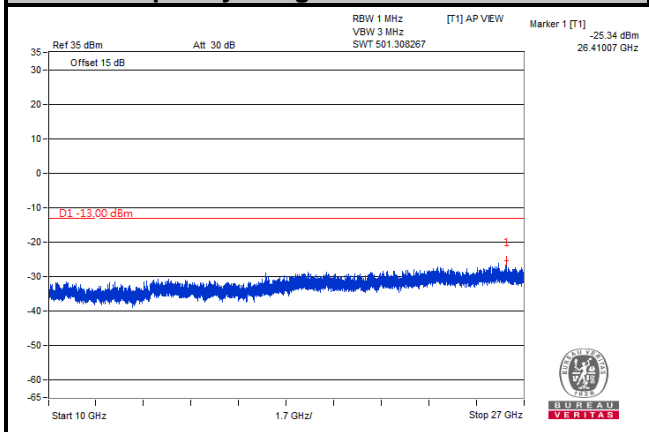

LTE Band 4
Channel Bandwidth: 20 MHz
Channel 20300

Frequency Range: 30 MHz ~ 1 GHz

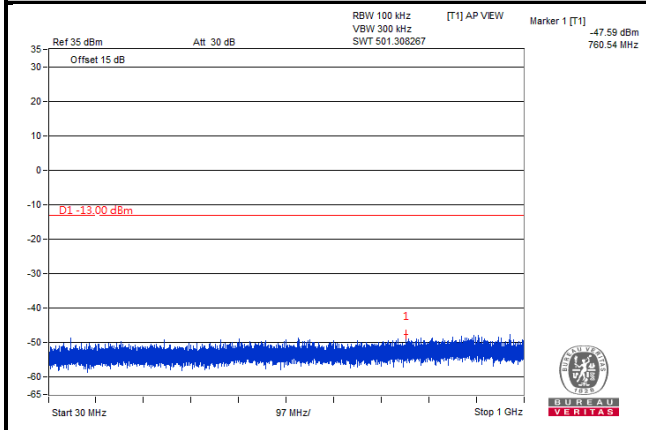

Frequency Range: 1 GHz ~ 10 GHz

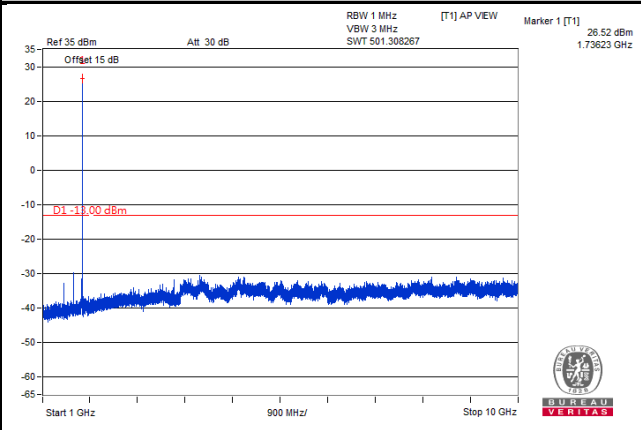

Frequency Range: 10 GHz ~ 27 GHz

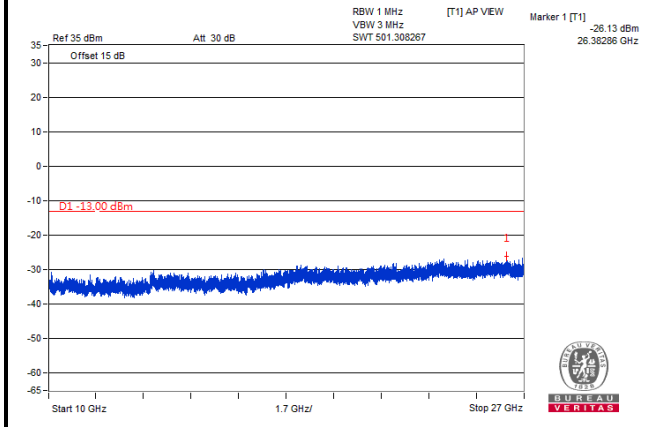

LTE Band 12
Channel Bandwidth: 1.4 MHz

Channel 23017

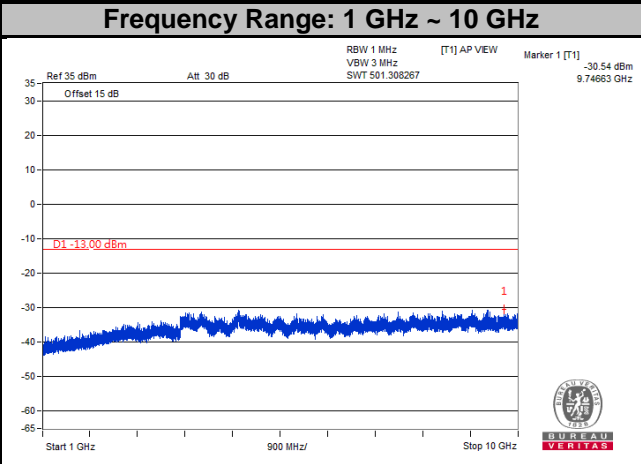
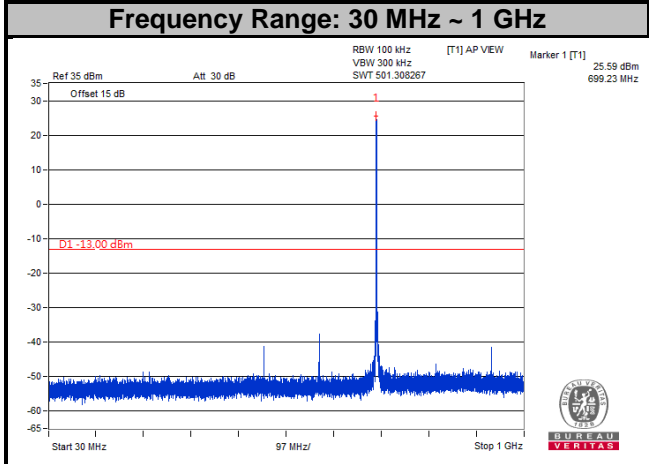

Channel 23095

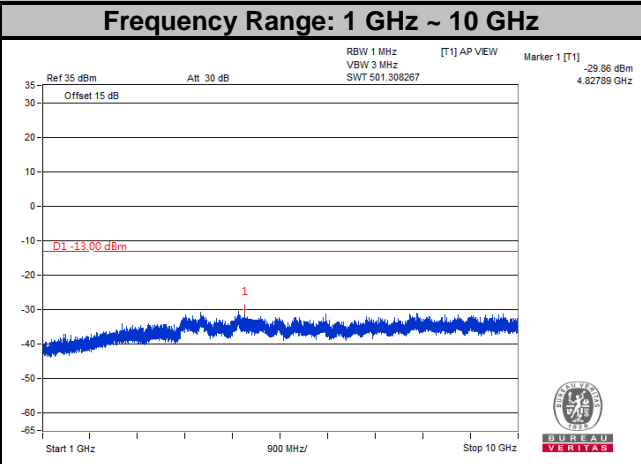
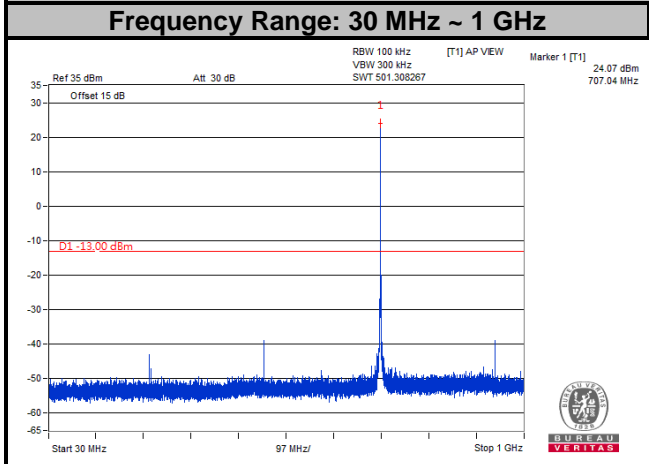

Channel 23173

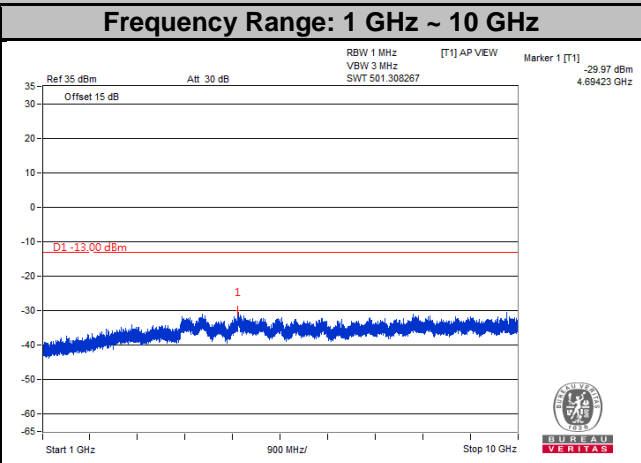
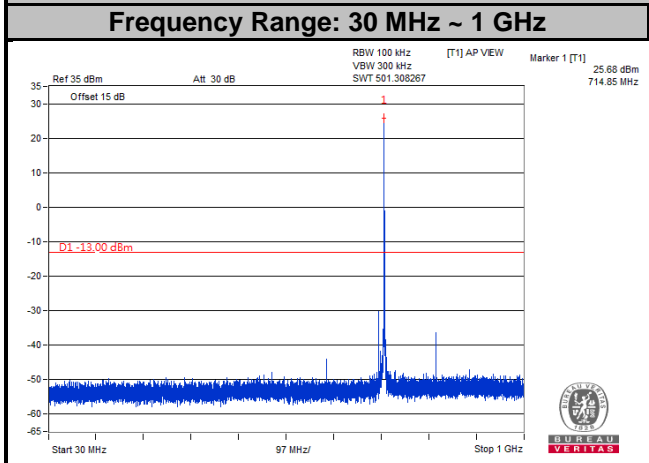

LTE Band 12
Channel Bandwidth: 3 MHz
Channel 23025

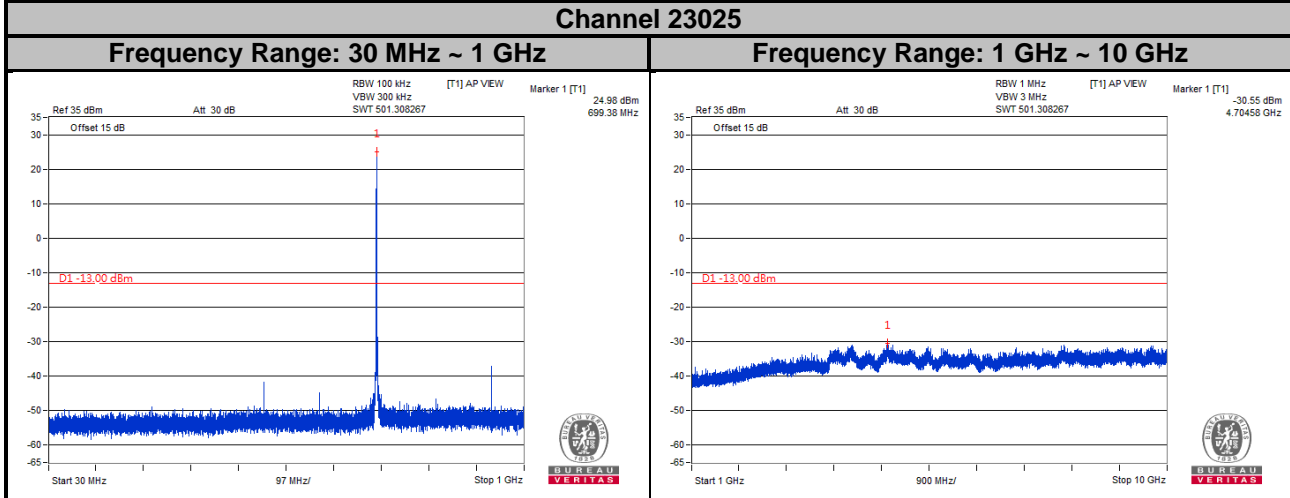

Channel 23095

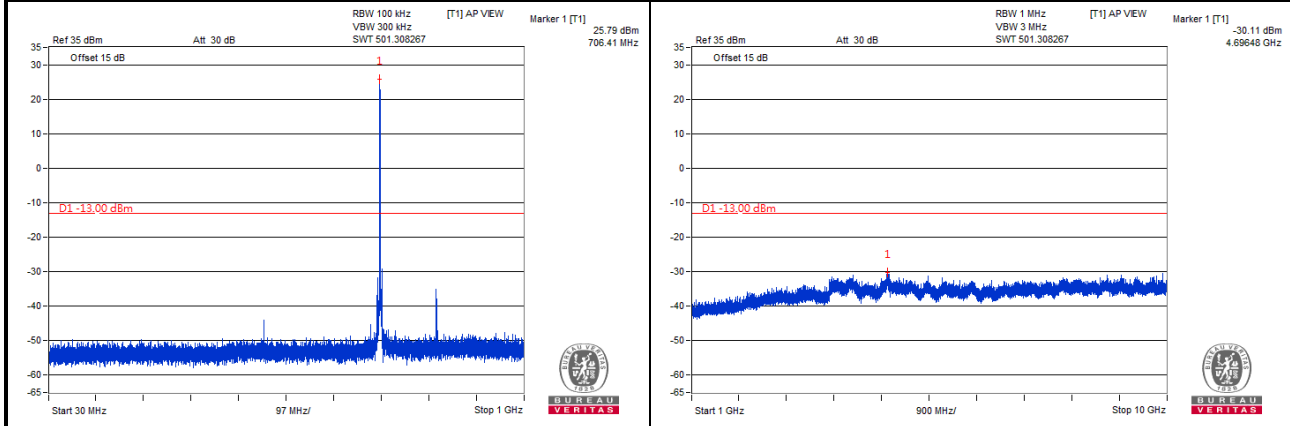

Channel 23165

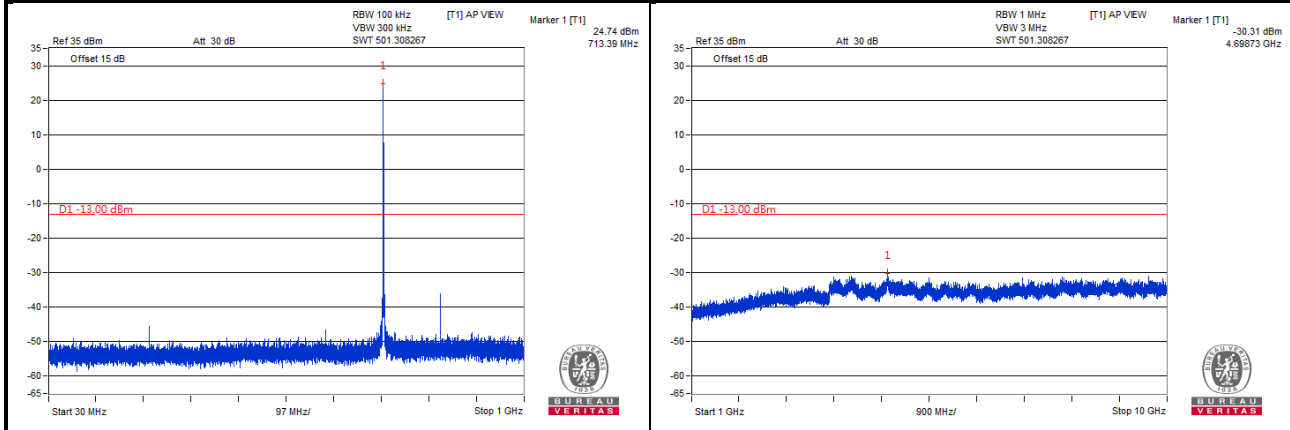

LTE Band 12
Channel Bandwidth: 5 MHz
Channel 23035

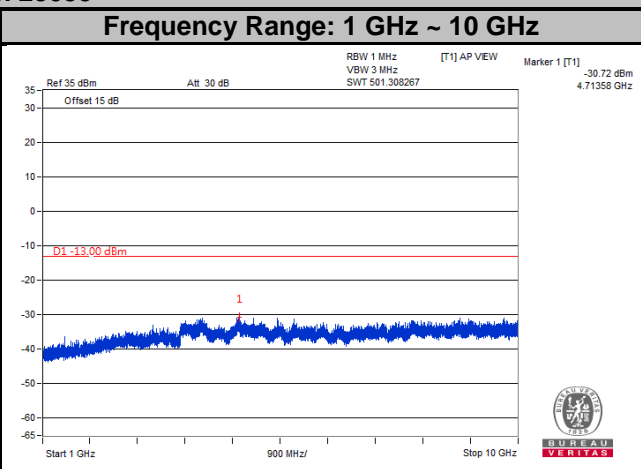
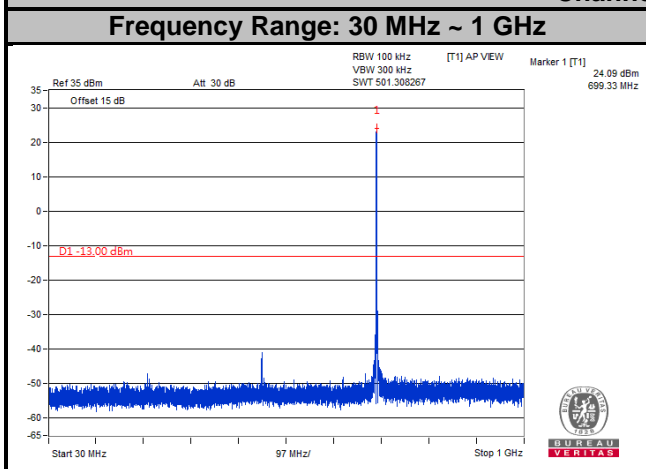

Channel 23095

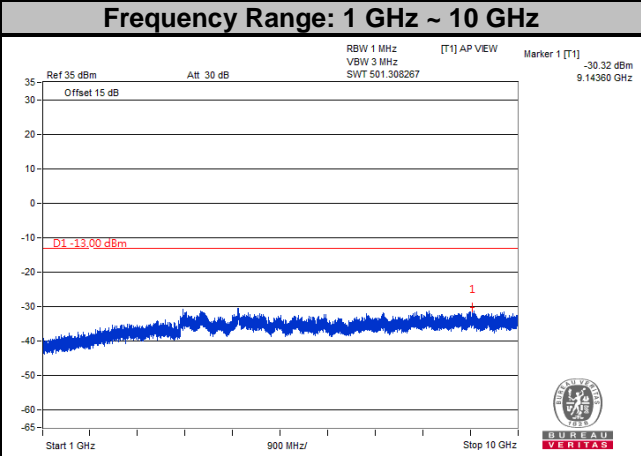
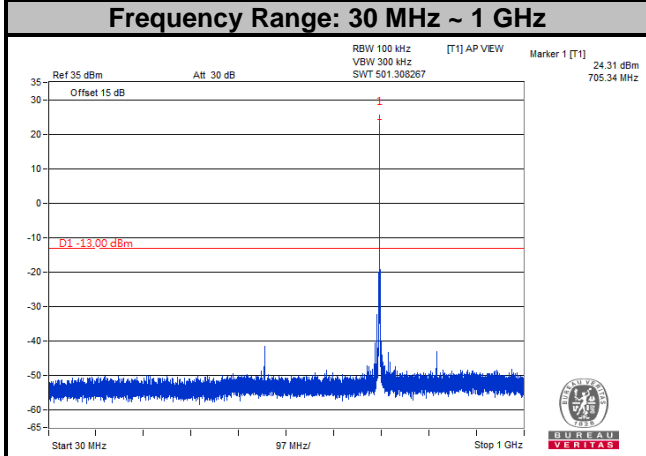

Channel 23155

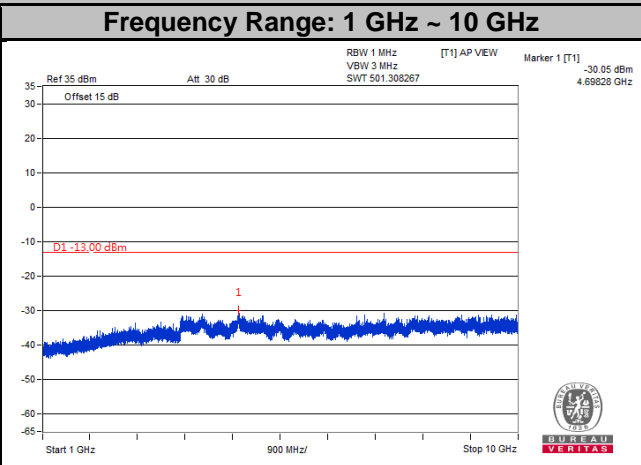
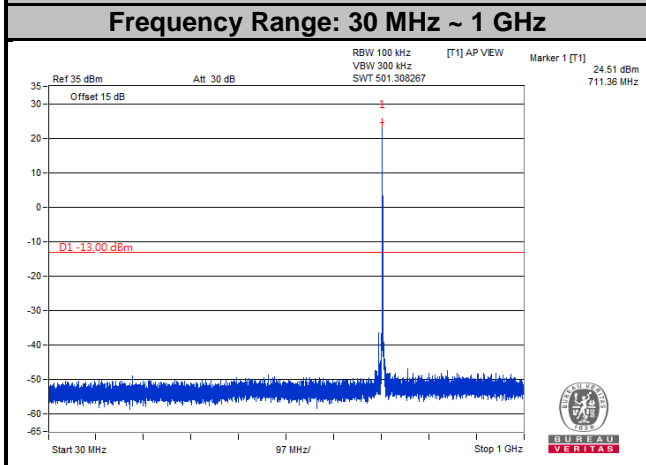

LTE Band 12
Channel Bandwidth: 10 MHz
Channel 23060

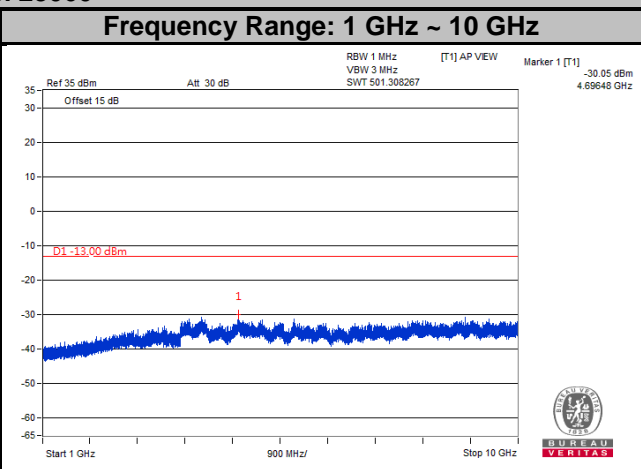
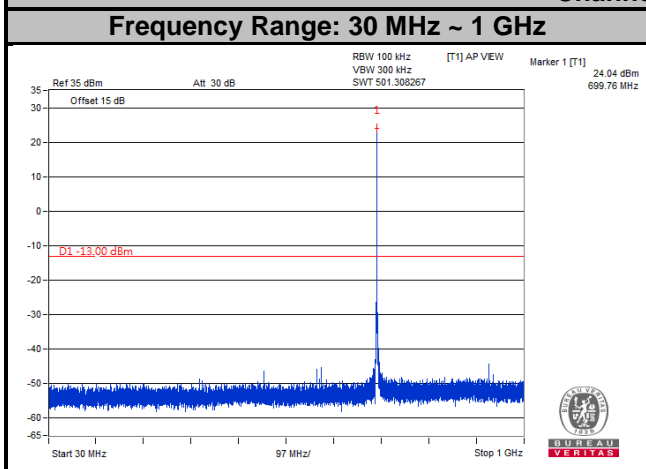

Channel 23095

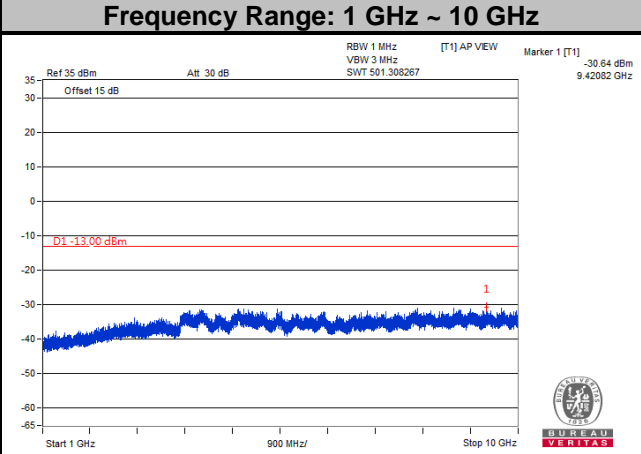
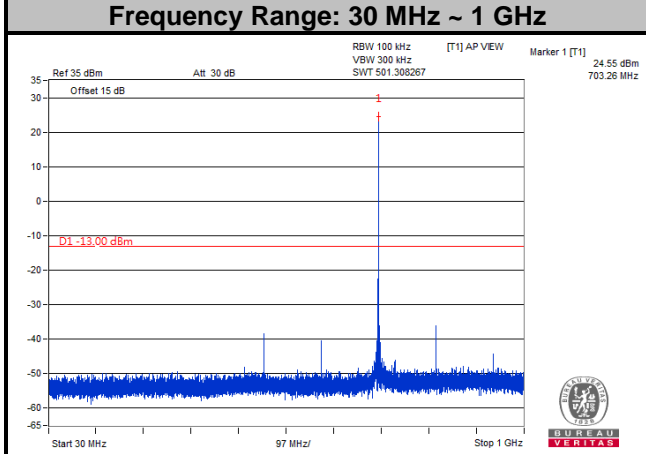

Channel 23130

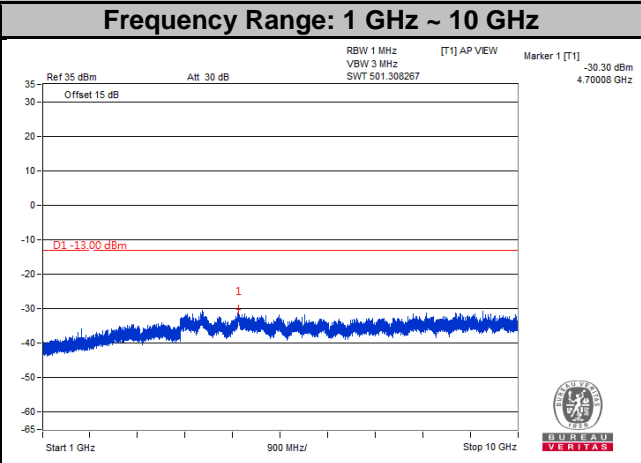
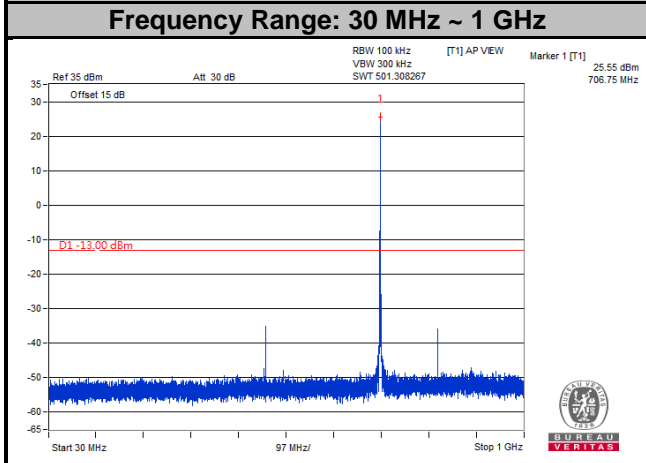

LTE Band 13
Channel Bandwidth: 5 MHz
Channel 23205

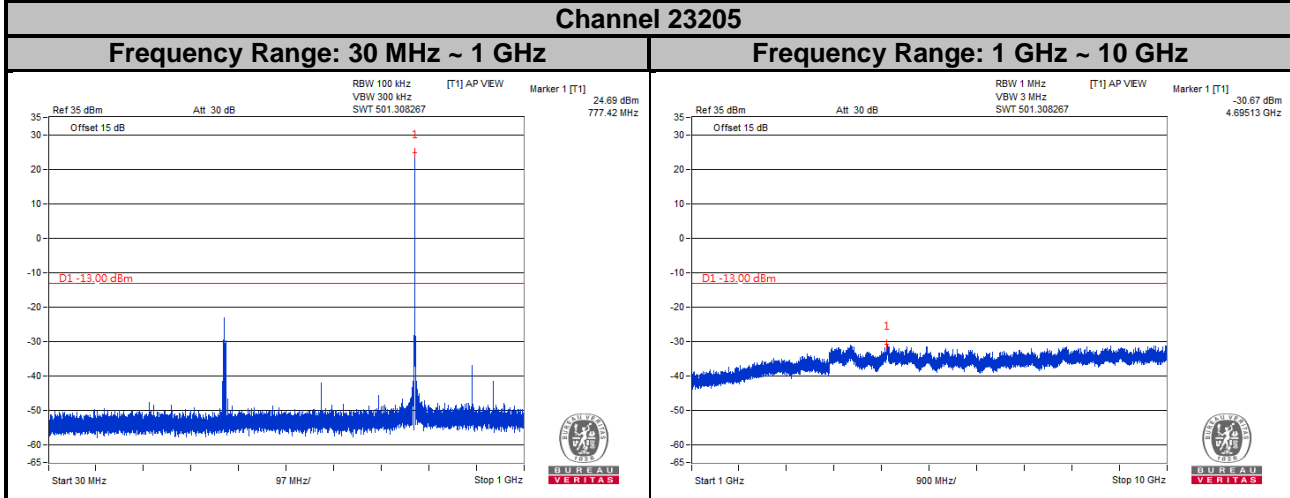

Channel 23230

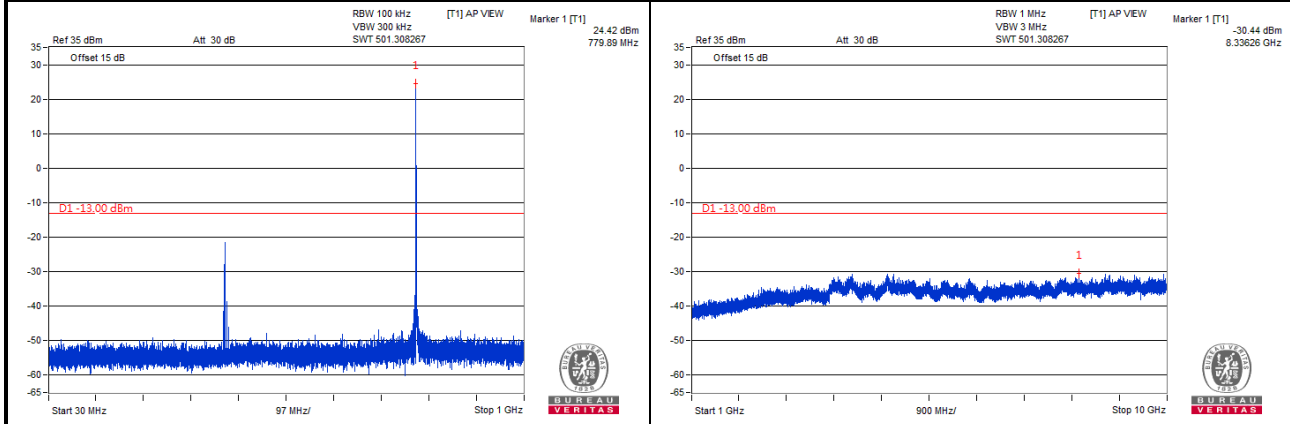

Channel 23255

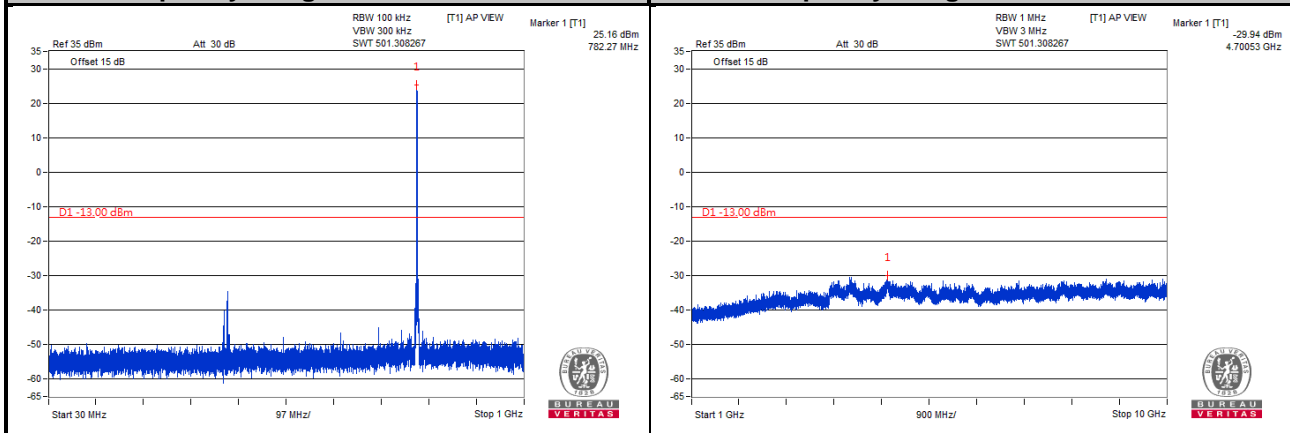

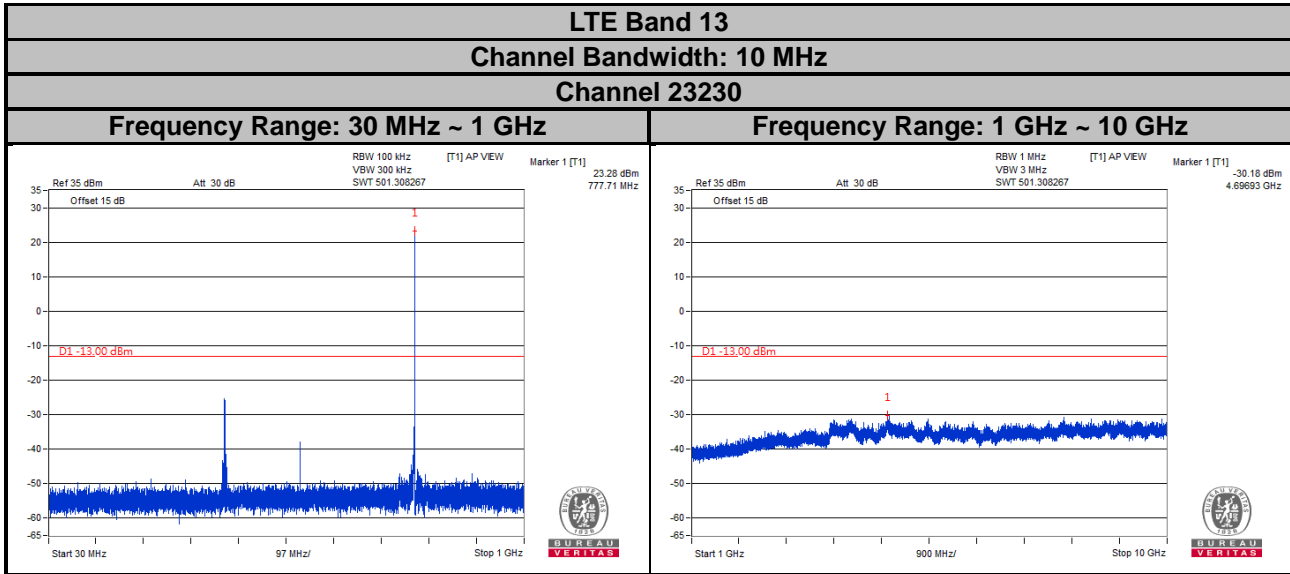

LTE Band 17
Channel Bandwidth: 5 MHz

Channel 23755

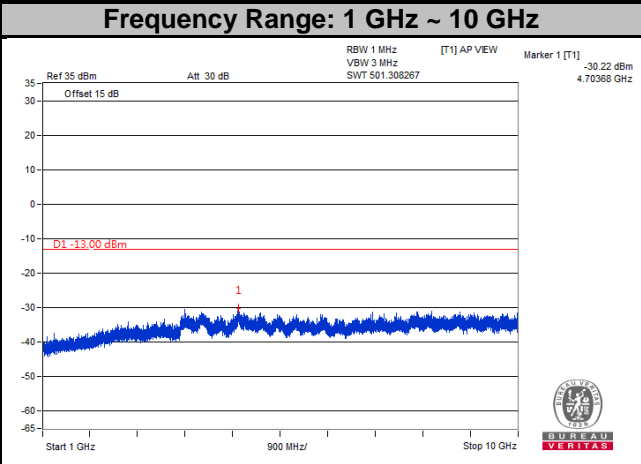
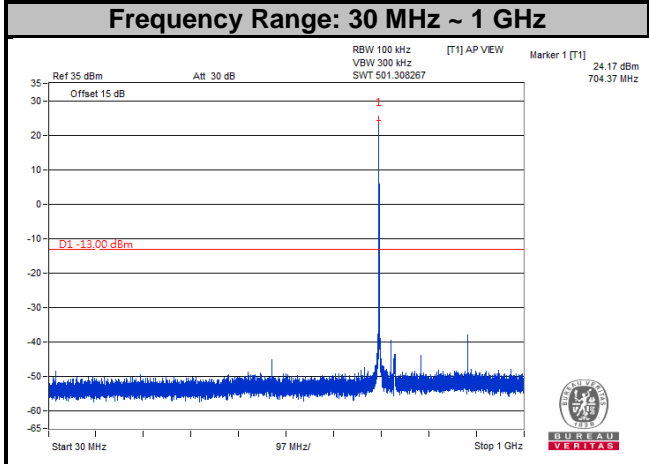

Channel 23790

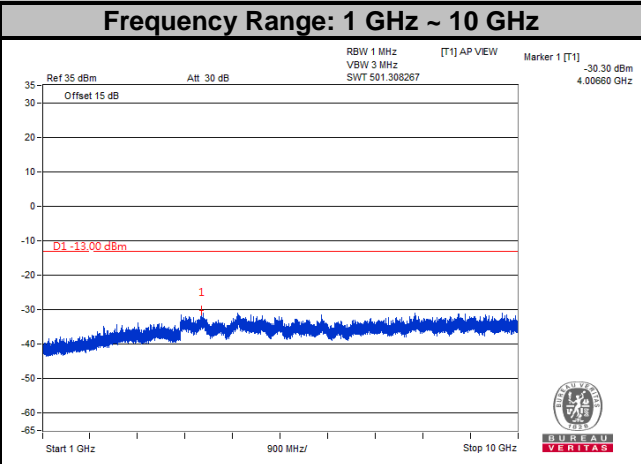
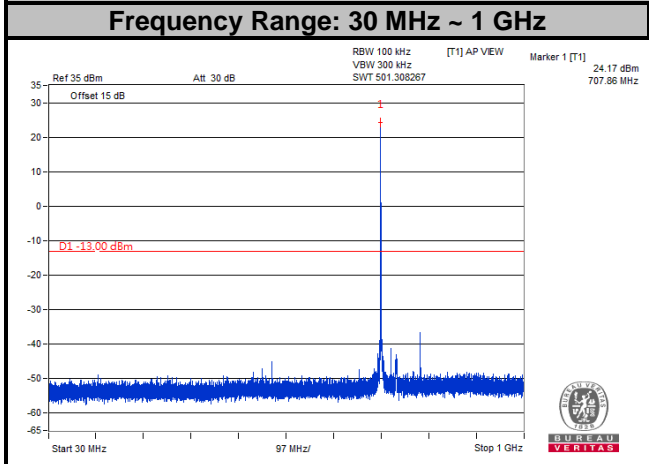

Channel 23825

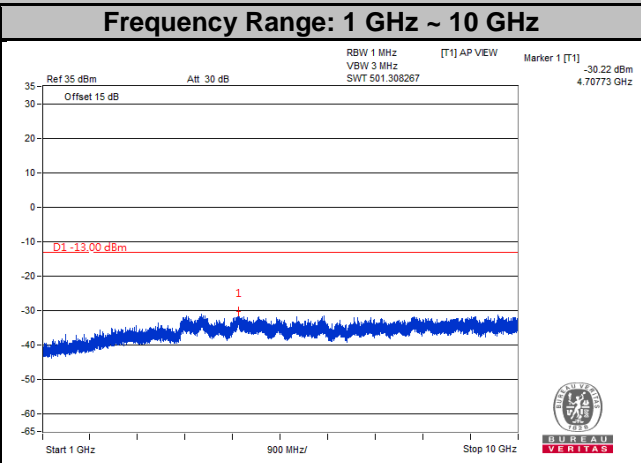
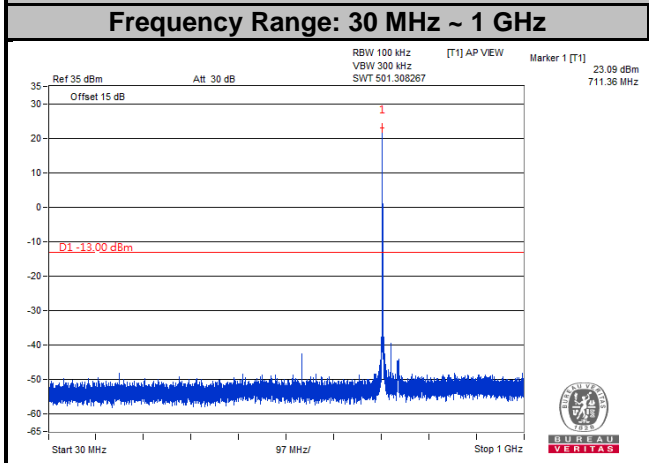

LTE Band 17
Channel Bandwidth: 10 MHz

Channel 23780

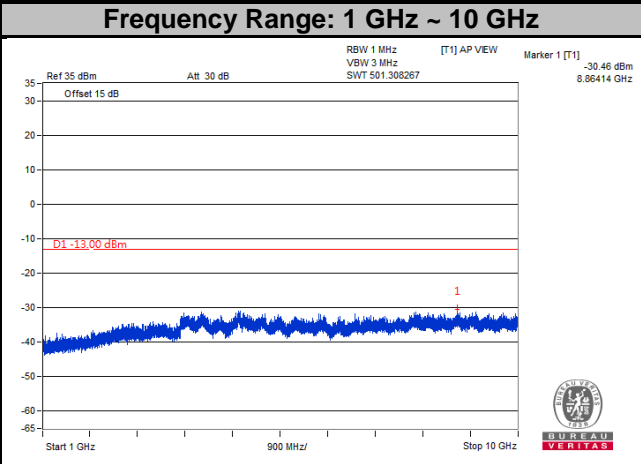
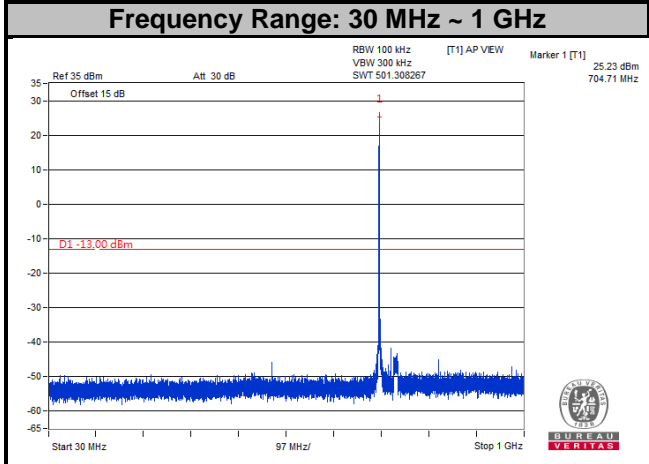

Channel 23790

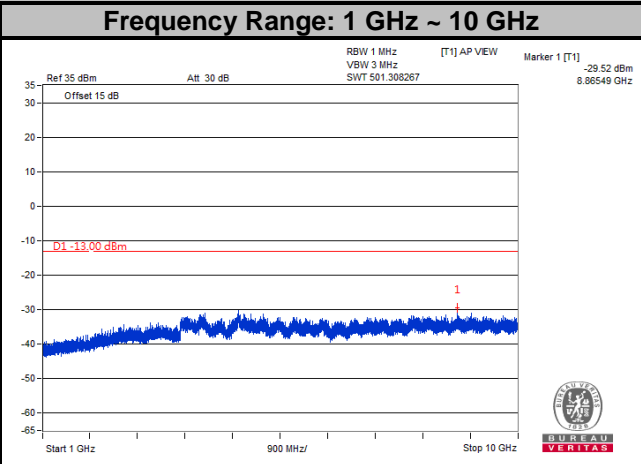
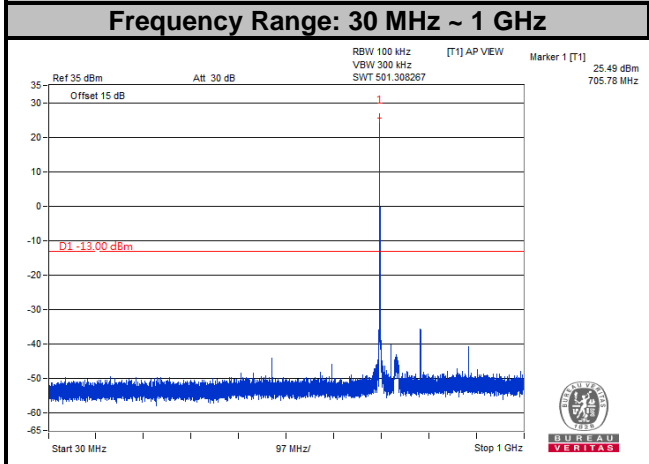

Channel 23800

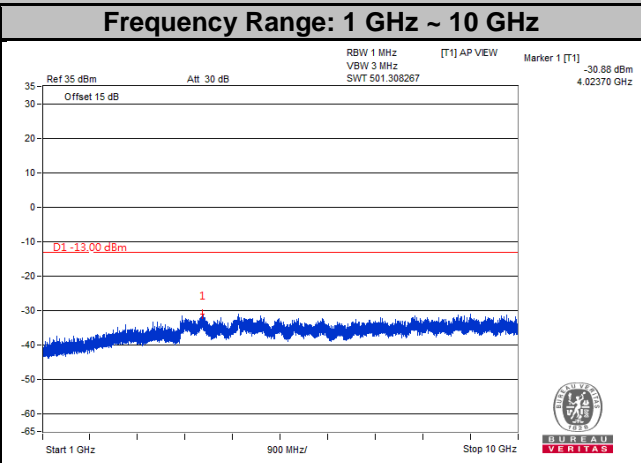
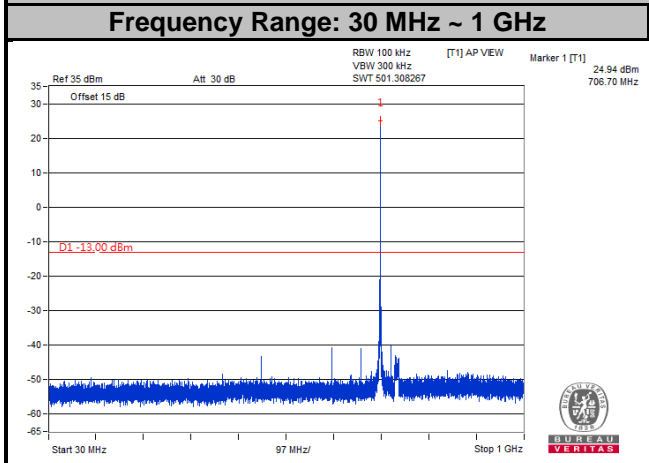

LTE Band 66
Channel Bandwidth: 1.4 MHz
Channel 131979

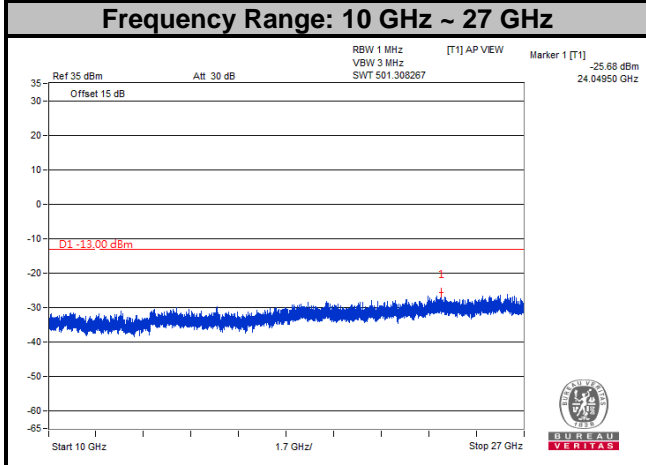
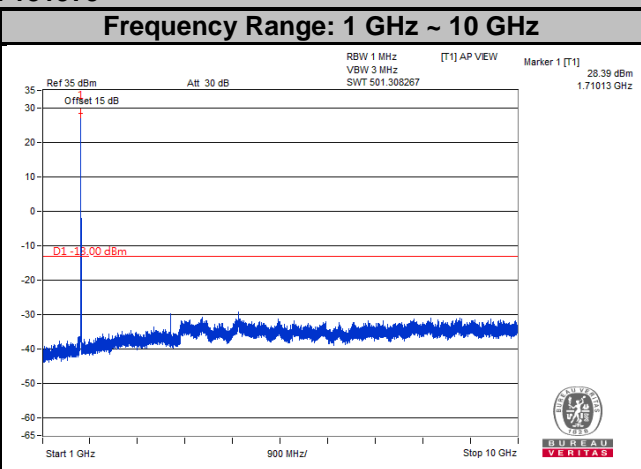
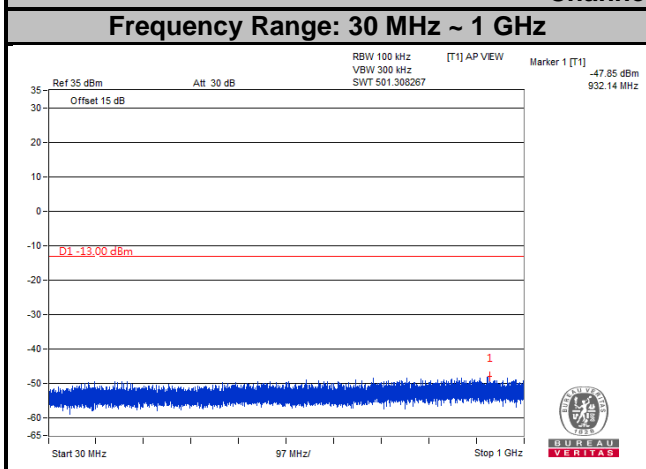

LTE Band 66
Channel Bandwidth: 1.4 MHz
Channel 132322

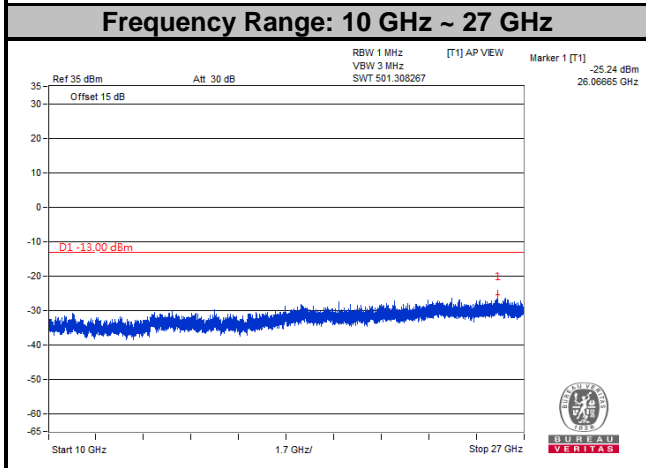
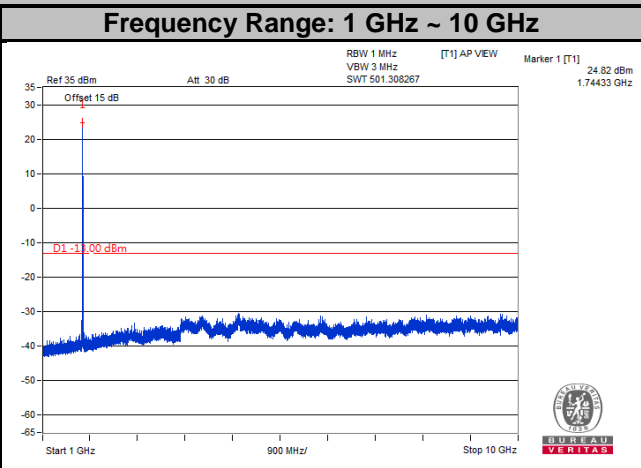
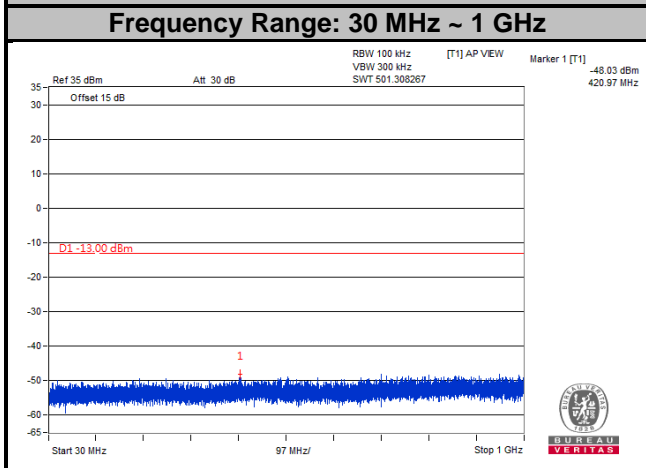

LTE Band 66
Channel Bandwidth: 1.4 MHz
Channel 132655

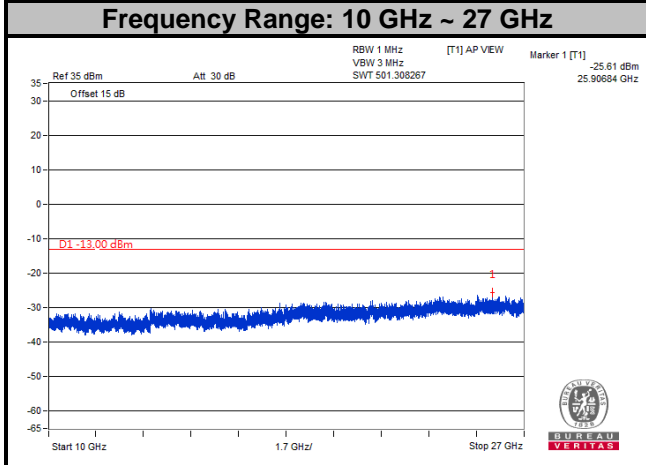
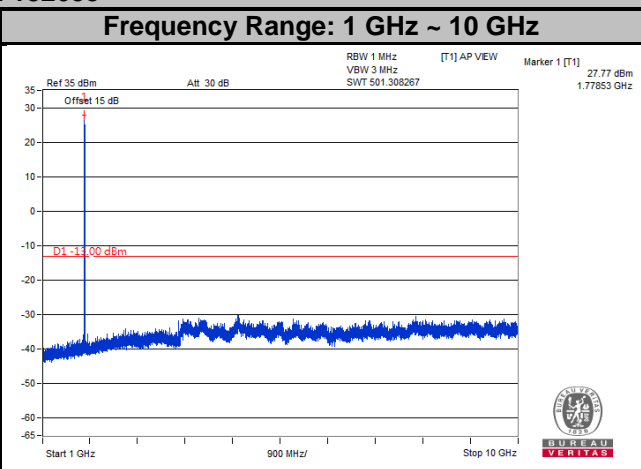
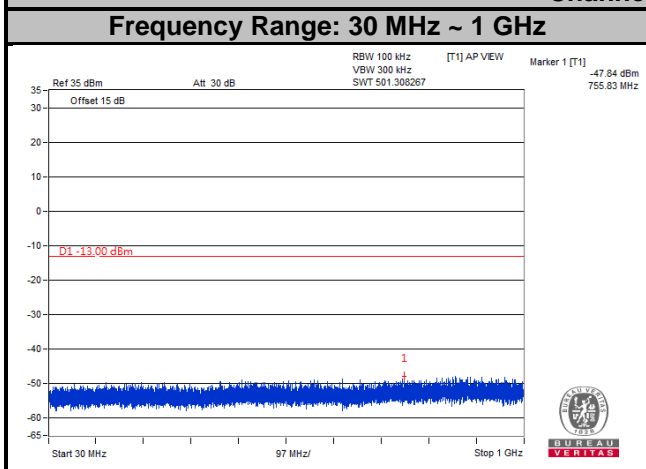

LTE Band 66
Channel Bandwidth: 3 MHz
Channel 131987

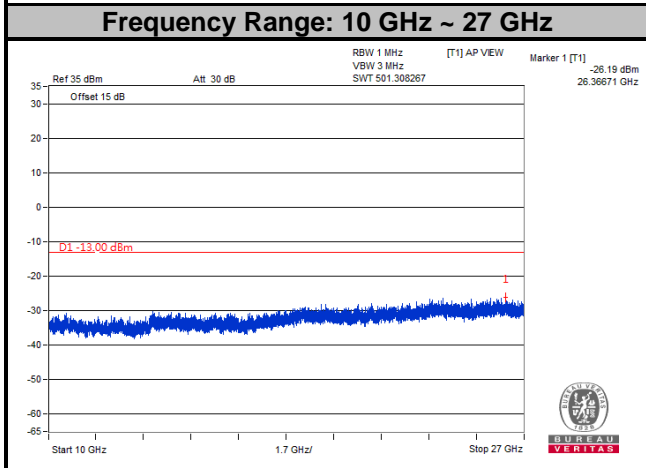
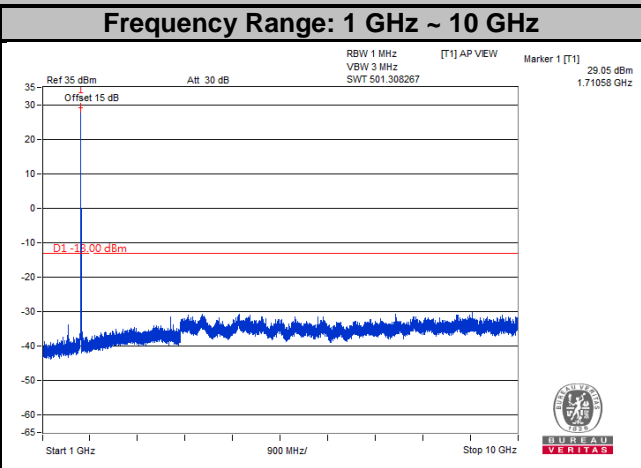
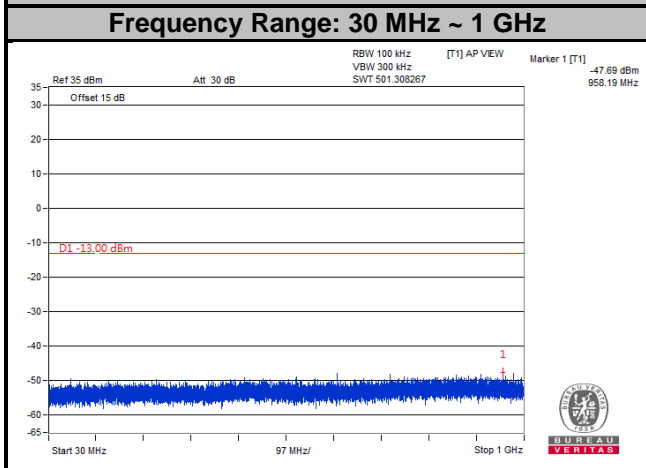

LTE Band 66
Channel Bandwidth: 3 MHz
Channel 132322

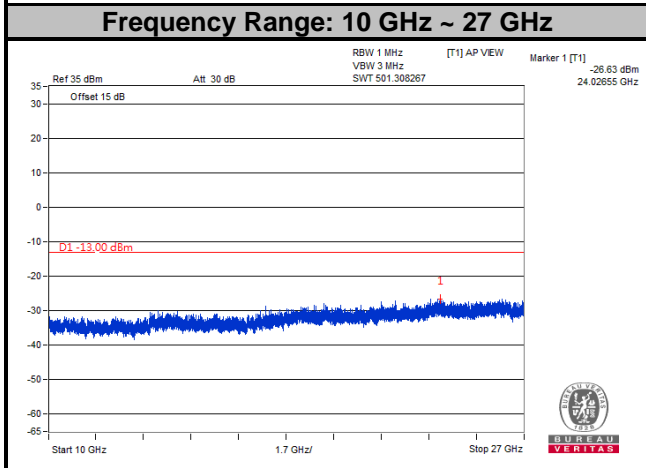
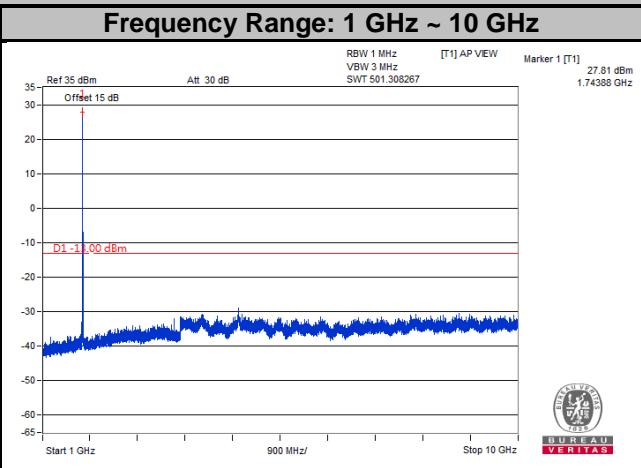
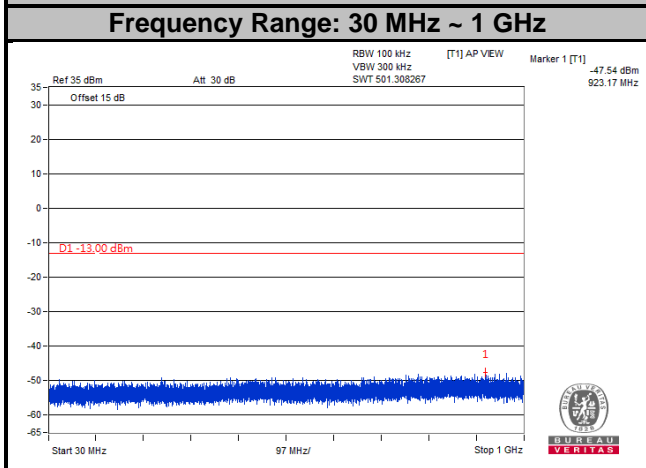

LTE Band 66
Channel Bandwidth: 3 MHz
Channel 132657

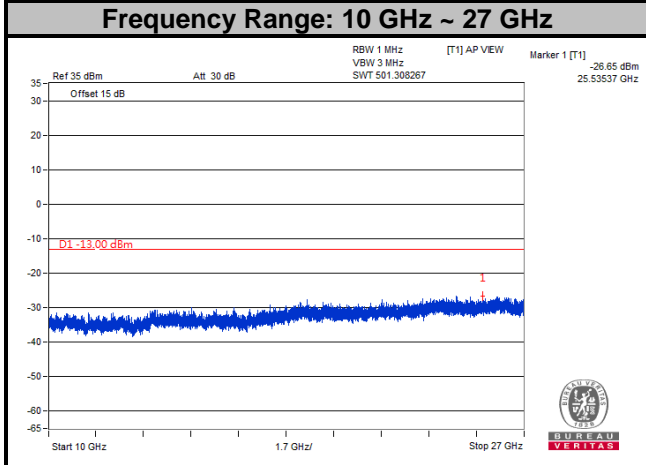
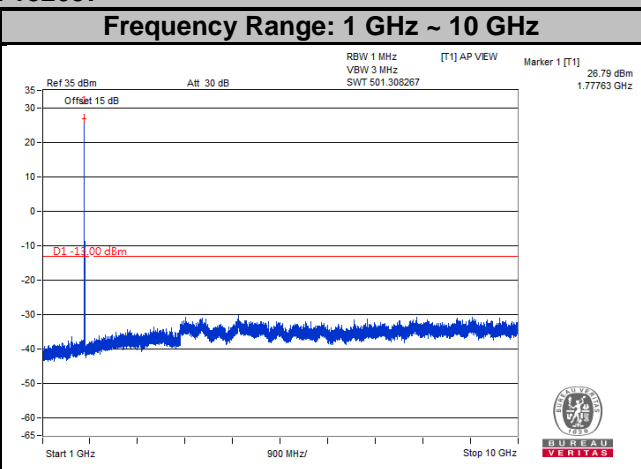
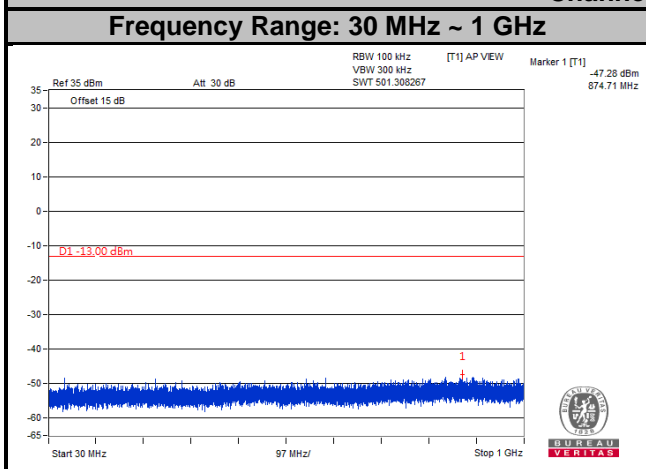

LTE Band 66
Channel Bandwidth: 5 MHz
Channel 131997

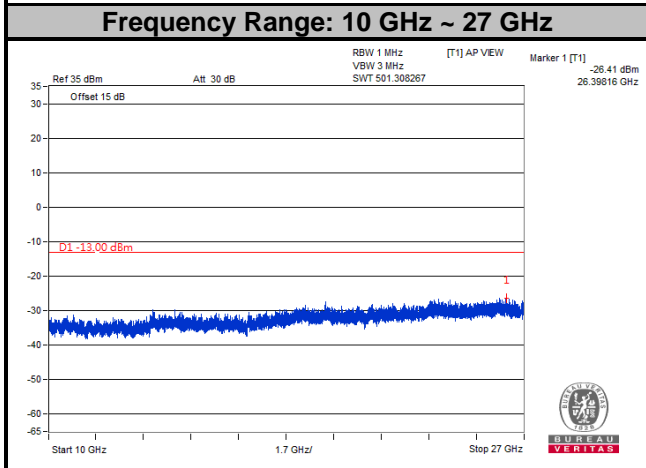
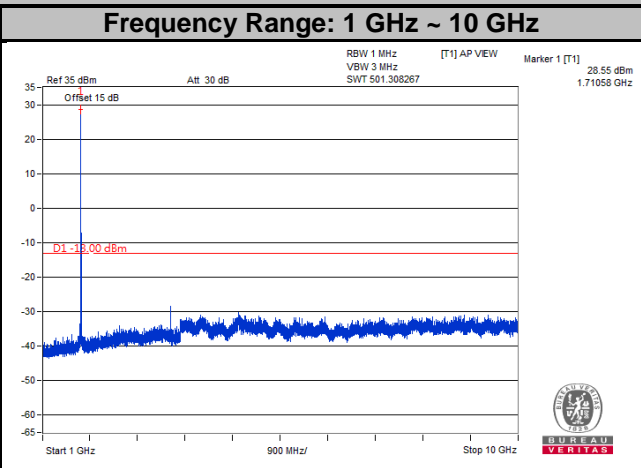
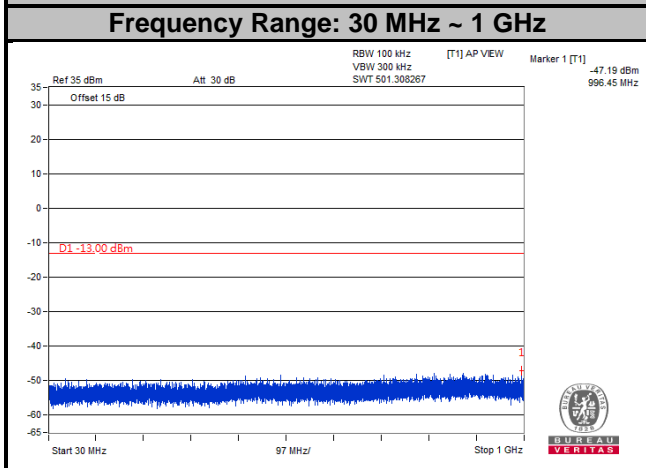

LTE Band 66
Channel Bandwidth: 5 MHz
Channel 132322

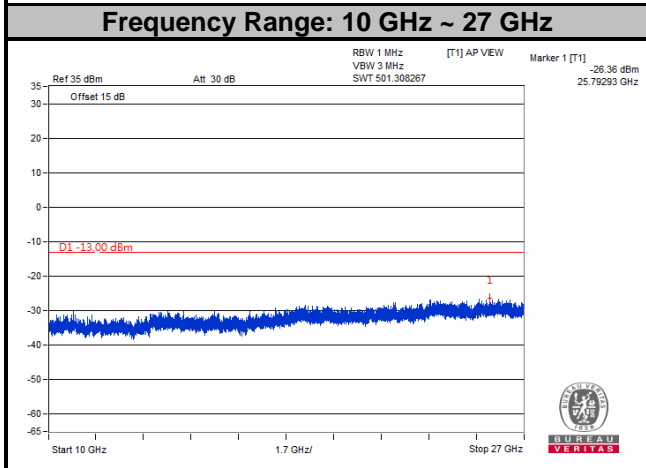
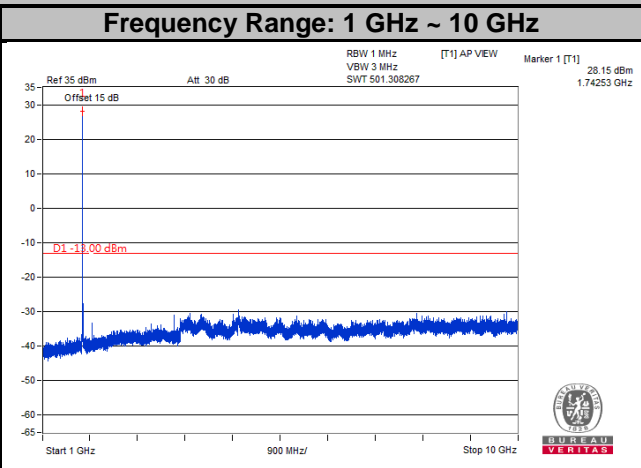
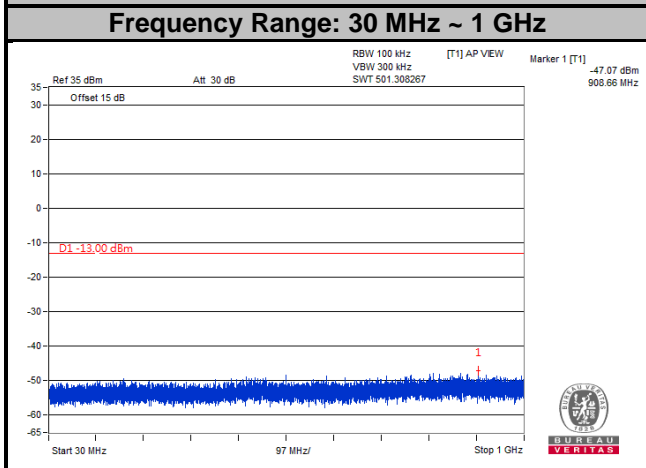

LTE Band 66
Channel Bandwidth: 5 MHz
Channel 132647

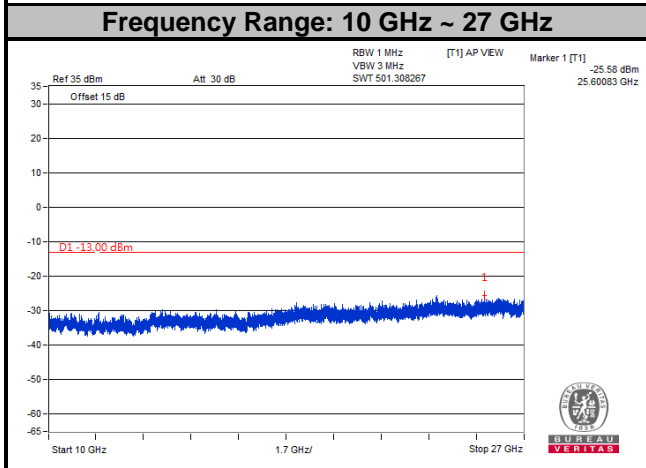
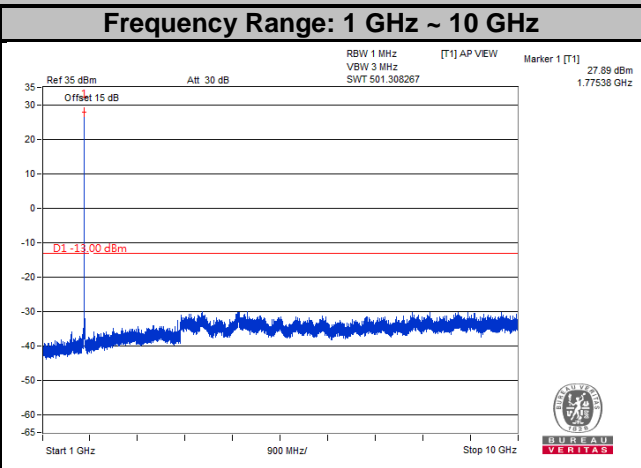
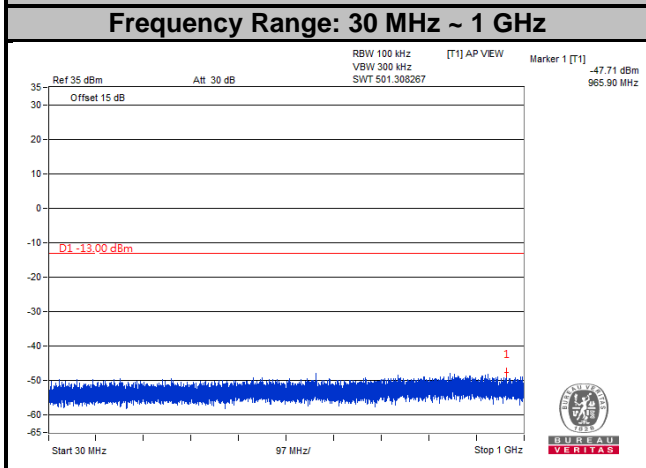

LTE Band 66
Channel Bandwidth: 10 MHz
Channel 132022

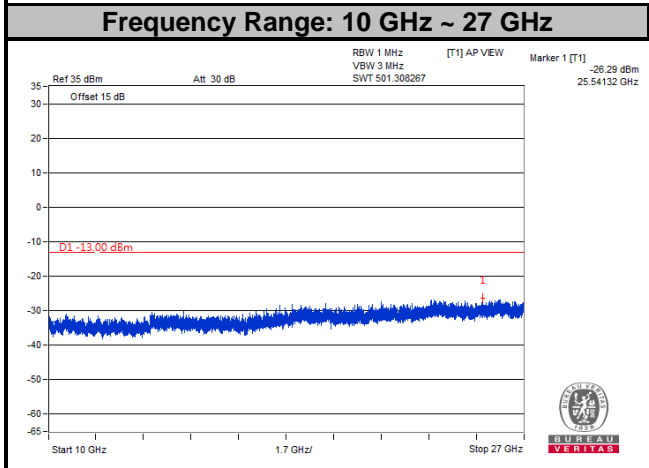
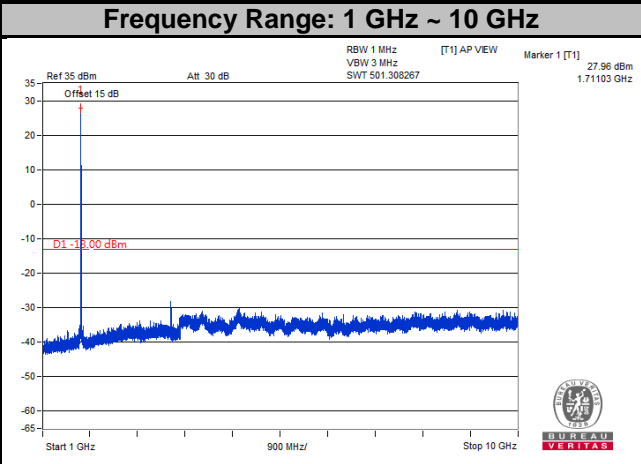
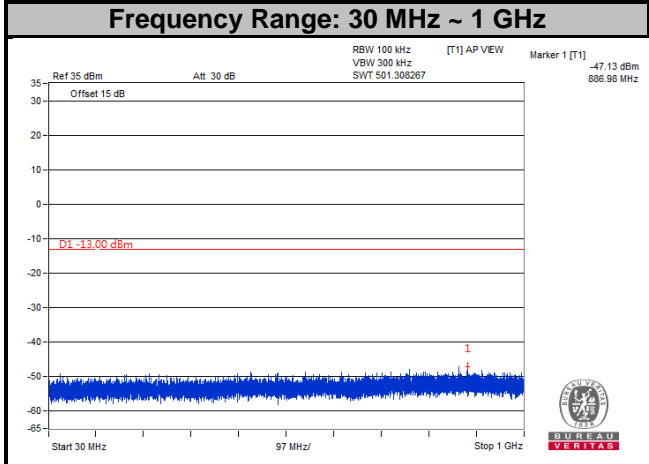

LTE Band 66
Channel Bandwidth: 10 MHz
Channel 132322

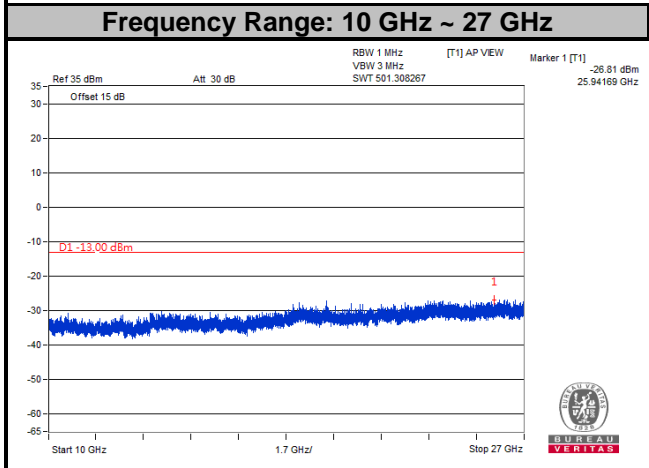
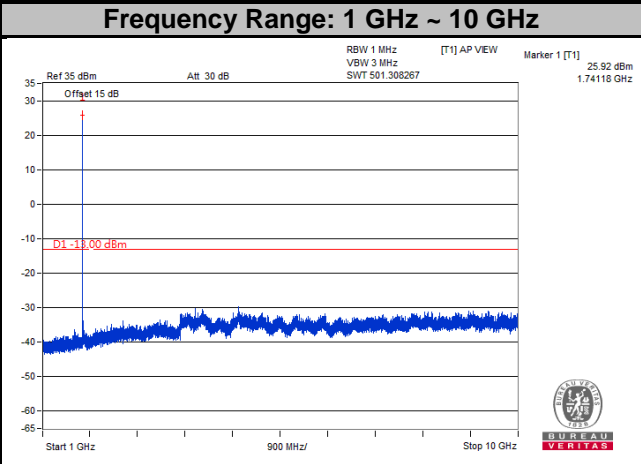
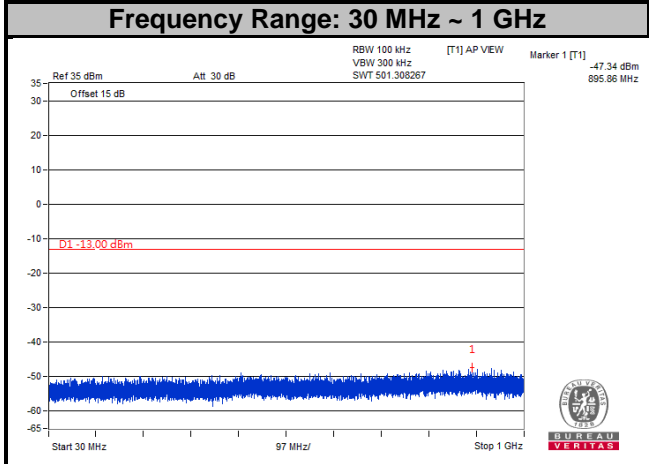

LTE Band 66
Channel Bandwidth: 10 MHz
Channel 132622

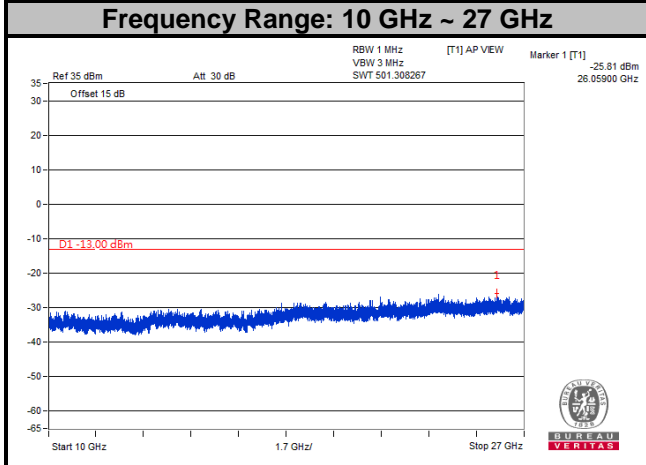
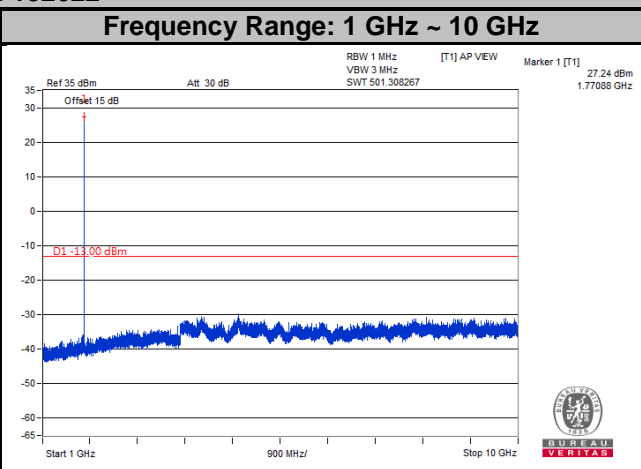
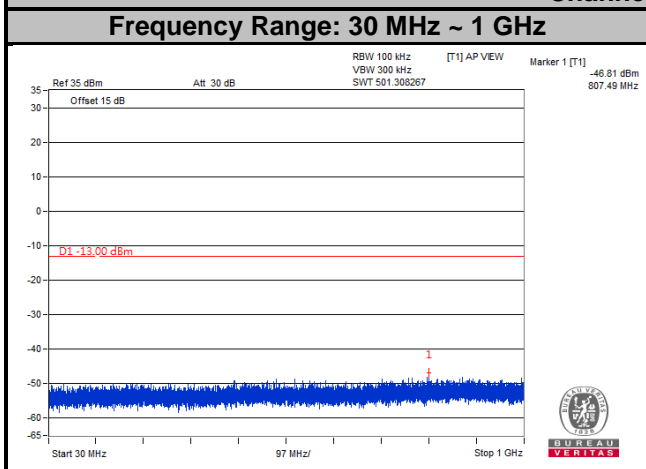

LTE Band 66
Channel Bandwidth: 15 MHz
Channel 132047

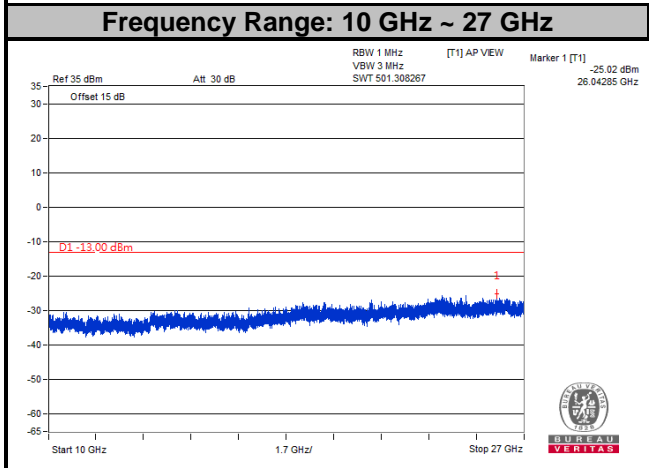
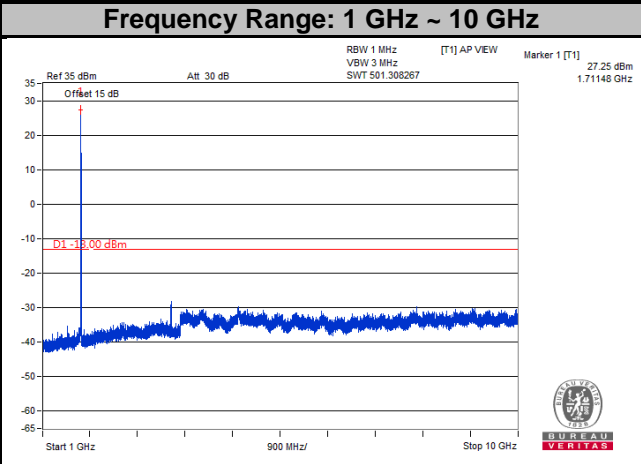
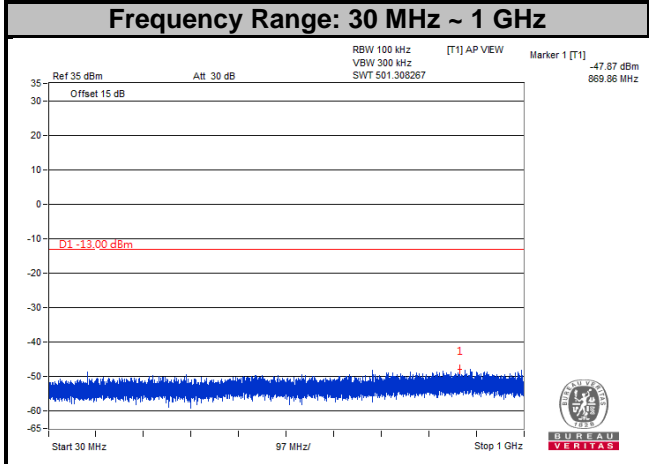

LTE Band 66
Channel Bandwidth: 15 MHz
Channel 132322

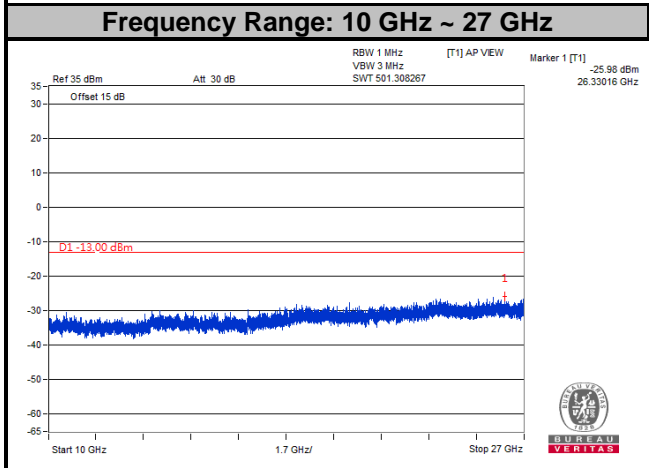
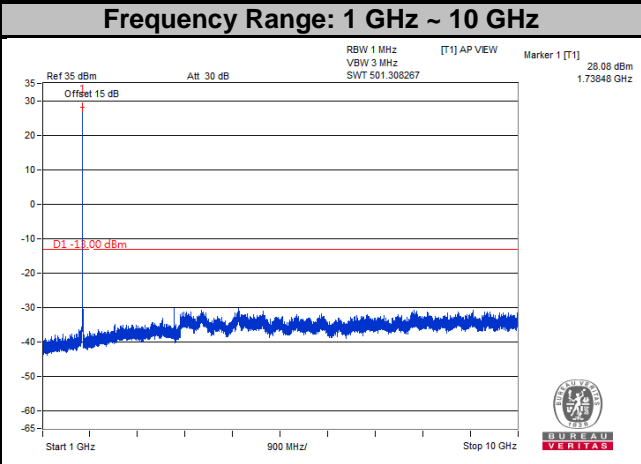
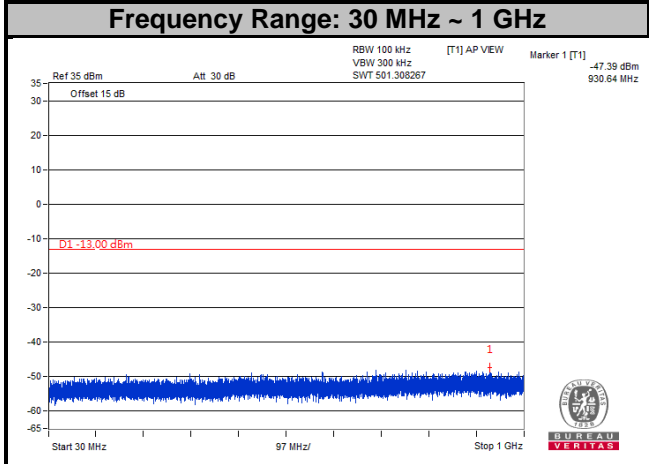

LTE Band 66
Channel Bandwidth: 15 MHz
Channel 132597

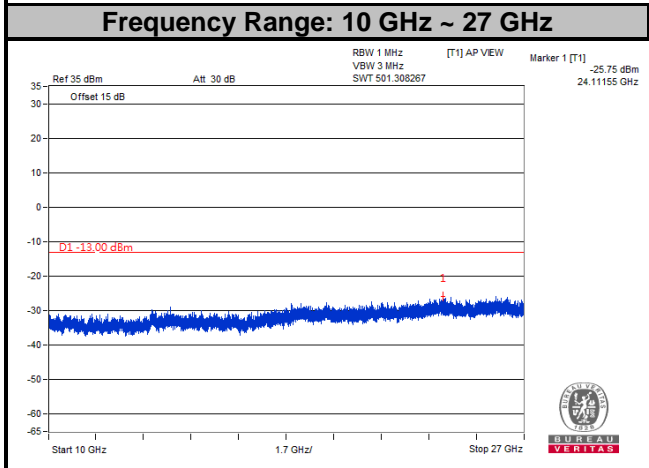
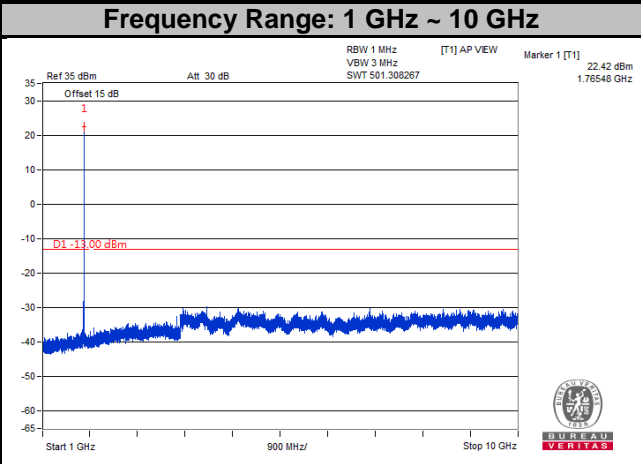
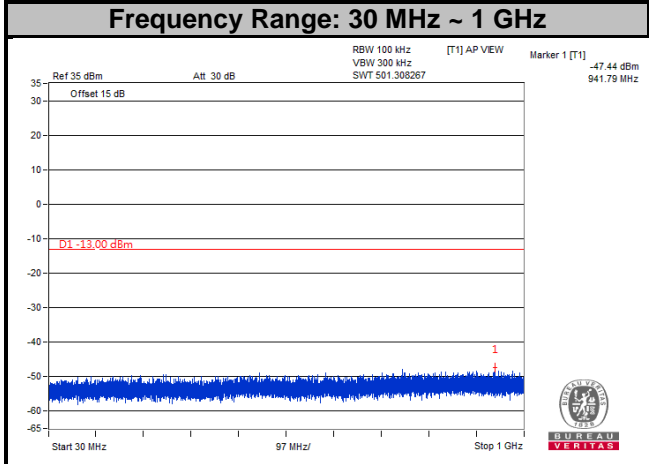

LTE Band 66

Channel Bandwidth: 20 MHz

Channel 132072

Frequency Range: 30 MHz ~ 1 GHz

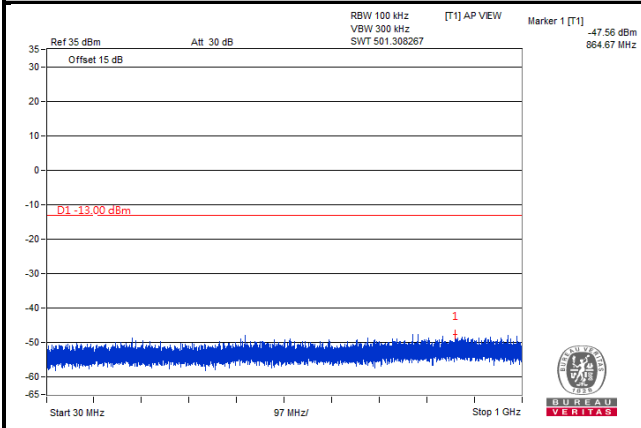

Frequency Range: 1 GHz ~ 10 GHz

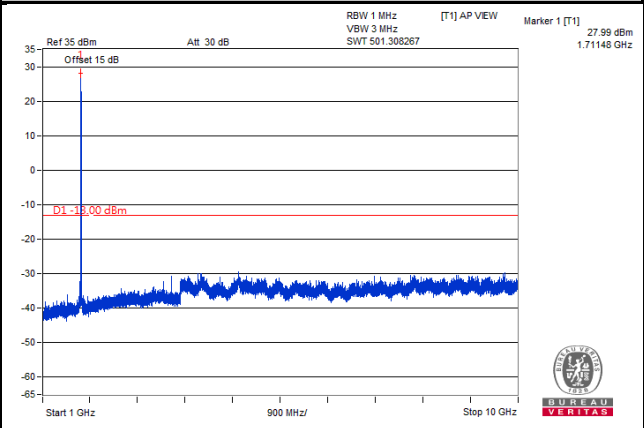

Frequency Range: 10 GHz ~ 27 GHz

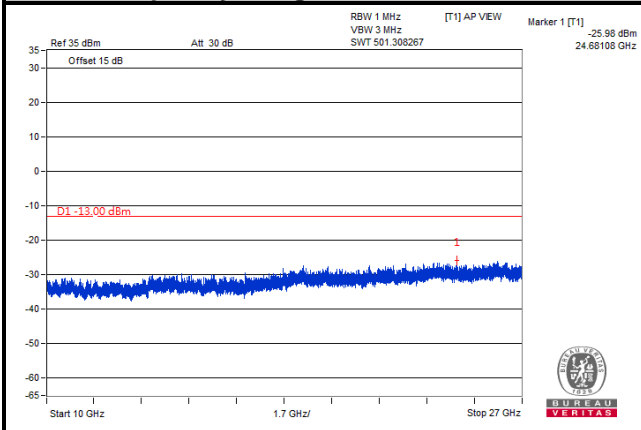

LTE Band 66
Channel Bandwidth: 20 MHz
Channel 132322

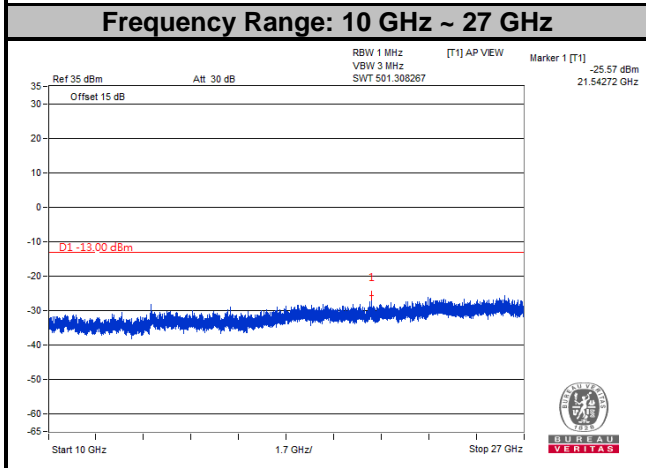
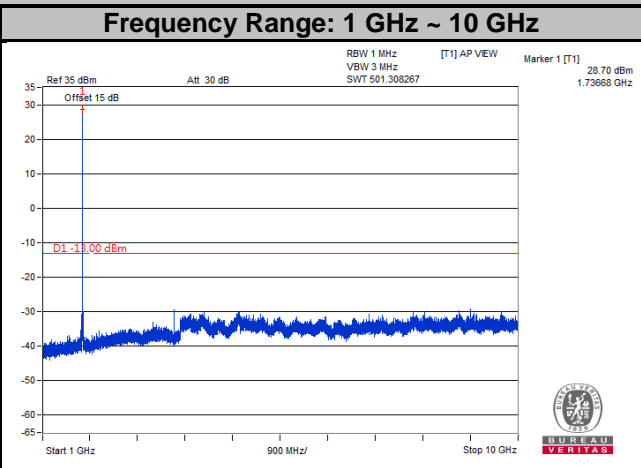
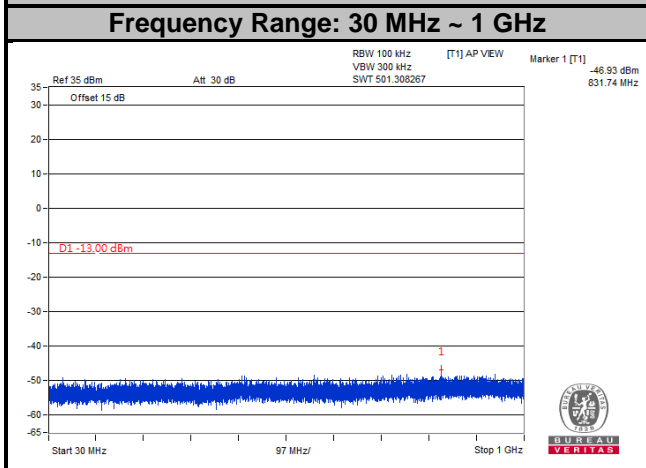

LTE Band 66
Channel Bandwidth: 20 MHz
Channel 132572

