

# FCC TEST REPORT

**Test report**  
**On Behalf of**  
**Shenzhen Kean Digital Co., Ltd.**  
**For**  
**Network HD camera**  
**Model No.: I21AD (Series models see page 6)**

**FCC ID: 2AKL2K33IPC**

**Prepared for :** Shenzhen Kean Digital Co., Ltd.  
Rujun Building, Floor 4, No.105, the Center Road, Bantian Street, Longgang Zone,  
Shenzhen, China

**Prepared By :** Laboratory of Shenzhen United Testing Technology Co., Ltd  
Room 316-319, Block B, Honghualing Industrial Park of the Fifth Zone, Taoyuan  
Street, Nanshan District, Shenzhen, Guangdong, China

**Date of Test:** May 02, 2017 ~ May 09, 2017

**Date of Report:** May 09, 2017

**Report Number:** UNI170502008-E

### TEST RESULT CERTIFICATION

**Applicant's name** ..... : Shenzhen Kean Digital Co., Ltd.  
 Address ..... : Rujun Building, Floor 4, No.105, the Center Road, Bantian Street, Longgang Zone, Shenzhen, China  
**Manufacture's Name** ..... : Shenzhen Kean Digital Co., Ltd.  
 Address ..... : Rujun Building, Floor 4, No.105, the Center Road, Bantian Street, Longgang Zone, Shenzhen, China

**Product description**

Trade Mark: /  
 Product name ..... : Network HD camera  
 Model and/or type reference : I21AD, (Series models see page 6)

**Standards** ..... : FCC Rules and Regulations Part 15 Subpart C Section 15.247  
 ANSI C63.10: 2013

This publication may be reproduced in whole or in part for non-commercial purposes as long as the **Shenzhen United Testing Technology Co., Ltd.** is acknowledged as copyright owner and source of the material. **Shenzhen United Testing Technology Co., Ltd.** takes no responsibility for and will not assume liability for damages resulting from the reader's interpretation of the reproduced material due to its placement and context.

**Date of Test** ..... :  
 Date (s) of performance of tests ..... : **May 02, 2017 ~ May 09, 2017**  
 Date of Issue ..... : **May 09, 2017**  
 Test Result ..... : **Pass**

Testing Engineer :   
 \_\_\_\_\_  
 (Eric Xie)

Technical Manager :   
 \_\_\_\_\_  
 (Dora Qin)

Authorized Signatory :   
 \_\_\_\_\_  
 (Kait Chen)

<b>Table of Contents</b>	<b>Page</b>
1 . TEST SUMMARY	5
2 . GENERAL INFORMATION	6
2.1 GENERAL DESCRIPTION OF EUT	6
Operation of EUT during testing	7
2.2 DESCRIPTION OF TEST SETUP	7
2.3 MEASUREMENT INSTRUMENTS LIST	8
3 . CONDUCTED EMISSIONS TEST	9
3.1 Conducted Power Line Emission Limit	9
3.2 Test Setup	9
3.3 Test Procedure	9
3.4 Test Result	9
4 RADIATED EMISSION TEST	12
4.1 Radiation Limit	12
4.2 Test Setup	12
4.3 Test Procedure	13
4.4 Test Result	13
5 BAND EDGE	28
5.1 Limits	28
5.2 Test Procedure	28
5.3 Test Result	28
6 OCCUPIED BANDWIDTH MEASUREMENT	36
6.1 Test Limit	36
6.2 Test Procedure	36
6.3 Measurement Equipment Used	36
6.4 Test Result	36
7 POWER SPECTRAL DENSITY TEST	45
7.1 Test Limit	45
7.2 Test Procedure	45
7.3 Measurement Equipment Used	45
7.4 Test Result	45
8 PEAK OUTPUT POWER TEST	54
8.1 Test Limit	54
8.2 Test Procedure	54
8.3 Measurement Equipment Used	54

<b>Table of Contents</b>	<b>Page</b>
8.4 Test Result	54
9 OUT OF BAND EMISSIONS TEST	55
9.1 Test Limit	55
9.2 Test Procedure	55
9.3 Test Setup	55
7.4 Test Result	55
10 ANTENNA REQUIREMENT	62
11 PHOTOGRAPH OF TEST	63
11.1 Radiated Emission	63
11.2 Conducted Emission	64

## 1. TEST SUMMARY

### 1.1 TEST PROCEDURES AND RESULTS

DESCRIPTION OF TEST	RESULT
CONDUCTED EMISSIONS TEST	COMPLIANT
RADIATED EMISSION TEST	COMPLIANT
BAND EDGE	COMPLIANT
OCCUPIED BANDWIDTH MEASUREMENT	COMPLIANT
POWER SPECTRAL DENSITY	COMPLIANT
PEAK OUTPUT POWER <sub>Peak</sub>	COMPLIANT
OUT OF BAND EMISSIONS	COMPLIANT
ANTENNA REQUIREMENT	COMPLIANT

### 1.2 TEST FACILITY

Test Firm : QTC Certification & Testing Co., Ltd.  
 Certificated by FCC, Registration No.: 588523

Address : 2nd Floor,B1 Building,Fengyeyuan Industrial Plant, Liuxian 2st. Road,  
 Xin'an Street, Bao'an District, Shenzhen, China

### 1.3 MEASUREMENT UNCERTAINTY

Measurement Uncertainty	
Conducted Emission Expanded Uncertainty	= 2.23dB, k=2
Radiated emission expanded uncertainty(9kHz-30MHz)	= 3.08dB, k=2
Radiated emission expanded uncertainty(30MHz-1000MHz)	= 4.42dB, k=2
Radiated emission expanded uncertainty(Above 1GHz)	= 4.06dB, k=2

## 2. GENERAL INFORMATION

### 2.1 GENERAL DESCRIPTION OF EUT

Equipment	Network HD camera
Model Name	I21AD
Serial Model	I21FB,I21FC,I21FD,I21FE,I21FF,I21FG,I21FH,I21FJ,I21FK,I21FL, I21FM,I21FN,I21FP,I21FQ,I21FR,I21FS,I21FT,I21FU,I21FV,I21FW, I21FX,I21FY,I21FZ,I21HB,I21HC,I21HD,I21HE,I21HF,I21HG,I21HH, I21HJ,I21HK,I21HL,I21HM,I21HN,I21HP,I21HQ,I21HR,I21HS,I21HT, I21HU,I21HV,I21HW,I21HX,I21HY,I21HZ,I21GC,I21GD,I21GH,I41HD, I41HE,I41HF,I41HG,I41HH,I41HJ,I41HK,I41HL,I41HM,I41HN,I41HP, I41HQ,I41HR,I41HS,I41HT,I41HU,I41HV,I41HW,I41HX,I41HY,I41HZ, I41JB,I41JC,I41JD,I41JE,I41JF,I41JG,I41JH,I41JK,I41JL,I41JM,I41JN ,I41JP,I41JQ,I41JR,I41JS,I41JT,I41JU,I41JV,I41JW,I41JX,I41JY,I41JZ ,I51BB,I51BC,I51BD,I51BE,I51BF,I51BG,I51BH,I51BJ,I51BK,I51BL, I51BM,I51BN,I51BP,I51BQ,I51BR,I51BS,I51BT,I51BU,I51BV,I51BW, I51BX,I51BY,I51BZ,I71EB,I71EC,I71ED,I71EE,I71EF,I71EG,I71EH, I71EJ,I71EK,I71EL,I71EM,I71EN,I71EP,I71EQ,I71ER,I71ES,I71ET, I71EU,I71EV,I71EW,I71EX,I71EY,I71EZ,I71GB,I71DB,I71DC,I71DD, I71DE,I71DF,I71DG,I71DH,I71DJ,I71DK,I71DL,I71DM,I71DN,I71DP, I71DQ,I71DR,I71DS,I71DT,I71DU,I71DV,I71DW,I71DX,I71DY,I71DZ
Model Difference	All model's the function, software and electric circuit are the same, only with a product color and model named different. Test sample model: I21AD.
FCC ID	2AKL2K33IPC
Antenna Type	Internal antenna
Antenna Gain	1 dBi
Operation frequency	802.11b/g/n 20:2412~2462 MHz 802.11n 40: 2422~2452MHz
Number of Channels	802.11b/g/n20: 11CH 802.11n 40: 7CH
Modulation Type	CCK/OFDM/DBPSK/DAPSK
Power Source	DC5V form Adapter with AC 120V/60Hz
Power Rating	DC5V form Adapter with AC 120V/60Hz

## 2.1.1 Carrier Frequency of Channels

Channel List for 802.11b/g/n(20MHz)							
Channel	Frequency (MHz)	Channel	Frequency (MHz)	Channel	Frequency (MHz)	Channel	Frequency (MHz)
01	2412	04	2427	07	2442	10	2457
02	2417	05	2432	08	2447	11	2462
03	2422	06	2437	09	2452		

Channel List for 802.11n(40MHz)							
Channel	Frequency (MHz)	Channel	Frequency (MHz)	Channel	Frequency (MHz)	Channel	Frequency (MHz)
03	2422	06	2437	09	2452		
04	2427	07	2442				
05	2432	08	2447				

## Operation of EUT during testing

## Operating Mode

The mode is used: **Transmitting mode for 802.11b/g/n(20MHz)**

Low Channel: 2412MHz

Middle Channel: 2437MHz

High Channel: 2462MHz

**Transmitting mode for 802.11n(40MHz)**

Low Channel: 2422MHz

Middle Channel: 2437MHz

High Channel: 2452MHz

## 2.2 DESCRIPTION OF TEST SETUP

Operation of EUT during conducted and Radiation testing:



## 2.3 MEASUREMENT INSTRUMENTS LIST

Item	Equipment	Manufacturer	Model No.	Serial No.	Cal Date	Due Date
1.	EMI Receiver	Rohde & Schwarz	ESCI	100627	Feb. 18, 2017	Feb. 17, 2018
2.	LISN	SchwarzBeck	NSLK 8126	8126377	Feb. 18, 2017	Feb. 17, 2018
3.	RF Switching Unit	Compliance Direction	RSU-M2	38303	Feb. 18, 2017	1 Year
4.	EMI Test Software ES-K1	Rohde & Schwarz	N/A	N/A	N/A	N/A
5.	EMI Test Receiver	Rohde & Schwarz	ESCI	100627	Feb. 18, 2017	Feb. 17, 2018
6.	Trilog Broadband Antenna	Schwarzbeck	VULB9163	VULB 9163-289	Feb. 18, 2017	Feb. 17, 2018
7.	Pre-amplifier	Compliance Direction	PAP-0203	22008	Feb. 18, 2017	Feb. 17, 2018
8.	EMI Test Software EZ-EMC	SHURPLE	N/A	N/A	N/A	N/A
9.	EMI Receiver	Rohde & Schwarz	ESCI	100627	Feb. 18, 2017	Feb. 17, 2018
10.	LISN	SchwarzBeck	NSLK 8126	8126377	Feb. 18, 2017	Feb. 17, 2018
11.	RF Switching Unit	Compliance Direction	RSU-M2	38303	Feb. 18, 2017	Feb. 17, 2018
12.	EMI Test Software ES-K1	Rohde & Schwarz	N/A	N/A	N/A	N/A
13.	EMI Receiver	Rohde & Schwarz	ESCI	100627	Feb. 18, 2017	Feb. 17, 2018
14.	EMI Receiver	Rohde & Schwarz	ESCI	100627	Feb. 18, 2017	Feb. 17, 2018
15.	LISN	SchwarzBeck	NSLK 8126	8126377	Feb. 18, 2017	Feb. 17, 2018
16.	RF Switching Unit	Compliance Direction	RSU-M2	38303	Feb. 18, 2017	Feb. 17, 2018
17.	EMI Test Software ES-K1	Rohde & Schwarz	N/A	N/A	N/A	N/A
18.	Power Meter	R&S	NRVD	SEL0069	Feb. 18, 2017	Feb. 17, 2018
19.	Power Sensor	R&S	URV5-Z2	SEL0071	Feb. 18, 2017	Feb. 17, 2018
20.	Power Sensor	R&S	URV5-Z2	SEL0072	Feb. 18, 2017	Feb. 17, 2018
21.	Software EMC32	R&S	EMC32-S	SEL0082	N/A	N/A
22.	Log-periodic Antenna	Amplifier Reasearch	APT1.580	SEL0073	Feb. 18, 2017	Feb. 17, 2018
23.	Loop Antenna	Schwarz beck	FMZB 1516	9773	Feb. 18, 2017	Feb. 17, 2018
24.	Broadband Antenna	Schwarz beck	VULB9163	9163-333	Feb. 18, 2017	Feb. 17, 2018
25.	Horn Antenna	ETS	3117	00086197	Feb. 18, 2017	Feb. 17, 2018
26.	Horn Antenna	Schwarzbeck	BBHA9170	BBHA91705 82	Feb. 18, 2017	Feb. 17, 2018
27.	Antenna Tripod	Amplifier Reasearch	TP1000A	SEL0074	Feb. 18, 2017	Feb. 17, 2018
28.	High Gain Horn Antenna	Amplifier Reasearch	AT4002A	SEL0075	Feb. 18, 2017	Feb. 17, 2018
29.	Spectrum analyzer	Agilent	N9020A	MY49911004 8	Feb. 18, 2017	Feb. 17, 2018
30.	Spectrum analyzer	Agilent	E4407B	MY46184326	Feb. 18, 2017	Feb. 17, 2018
31.	Spectrum analyzer	R&S	FSP30	836079/035	Feb. 18, 2017	Feb. 17, 2018



### 3. CONDUCTED EMISSIONS TEST

#### 3.1 Conducted Power Line Emission Limit

For unintentional device, according to § 15.107(a) Line Conducted Emission Limits is as following

Frequency (MHz)	Maximum RF Line Voltage (dBµV)			
	CLASS A		CLASS B	
	Q.P.	Ave.	Q.P.	Ave.
0.15 - 0.50	79	66	66-56*	56-46*
0.50 - 5.00	73	60	56	46
5.00 - 30.0	73	60	60	50

\* Decreasing linearly with the logarithm of the frequency

For intentional device, according to §15.207(a) Line Conducted Emission Limit is same as above table.

#### 3.2 Test Setup

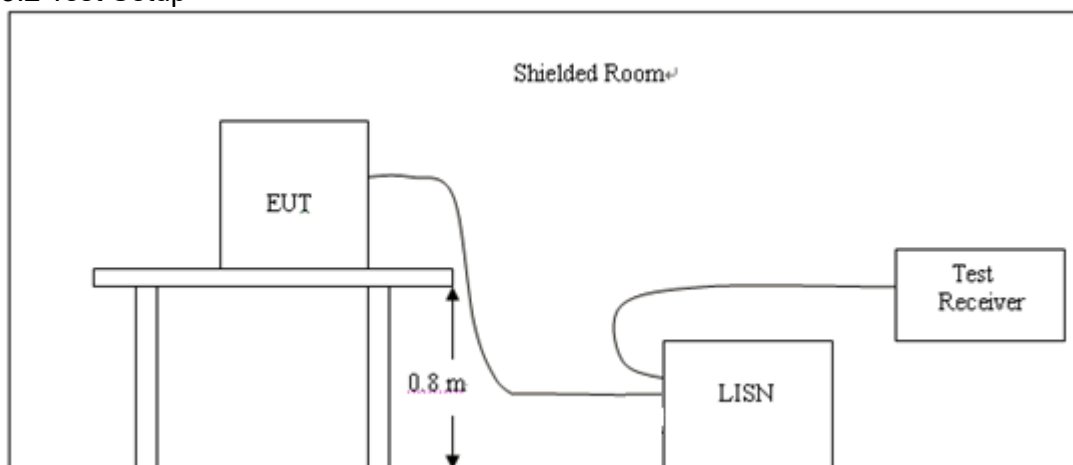

#### 3.3 Test Procedure

- 1, The equipment was set up as per the test configuration to simulate typical actual usage per the user's manual. The EUT is a tabletop system, a wooden table with a height of 0.8 meters is used and is placed on the ground plane as per ANSI C63.10.
- 2, Support equipment, if needed, was placed as per ANSI C63.10.
- 3, All I/O cables were positioned to simulate typical actual usage as per ANSI C63.10.
- 4, If a EUT received DC power from the USB Port of Notebook PC, the PC's adapter received AC120V/60Hz power through a Line Impedance Stabilization Network (LISN) which supplied power source and was grounded to the ground plane.
- 5, All support equipments received AC power from a second LISN, if any.
- 6, The EUT test program was started. Emissions were measured on each current carrying line of the EUT using a spectrum Analyzer / Receiver connected to the LISN powering the EUT. The LISN has two monitoring points: Line 1 (Hot Side) and Line 2 (Neutral Side). Two scans were taken: one with Line 1 connected to Analyzer / Receiver and Line 2 connected to a 50 ohm load; the second scan had Line 1 connected to a 50 ohm load and Line 2 connected to the Analyzer / Receiver.
- 7, Analyzer / Receiver scanned from 150 KHz to 30MHz for emissions in each of the test modes.

#### 3.4 Test Result

PASS

All the test modes completed for test.

Test Specification: Line

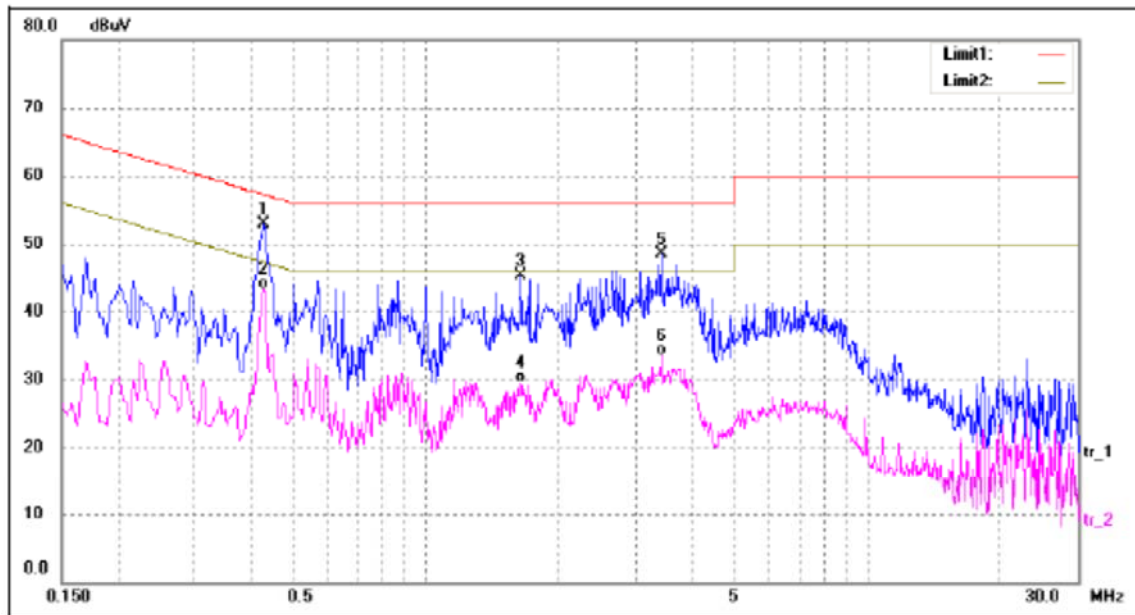

No.	Frequency (MHz)	Reading (dBuV)	Correct (dB/m)	Result (dBuV)	Limit (dBuV)	Margin (dB)	Detector
1	0.4300	43.08	9.80	52.88	57.25	-4.37	peak
2*	0.4300	33.55	9.80	43.35	47.25	-3.90	AVG
3	1.6420	35.51	9.74	45.25	56.00	-10.75	peak
4	1.6420	19.75	9.74	29.49	46.00	-16.51	AVG
5	3.4220	38.85	9.70	48.55	56.00	-7.45	peak
6	3.4220	23.79	9.70	33.49	46.00	-12.51	AVG

Test Specification: Neutral

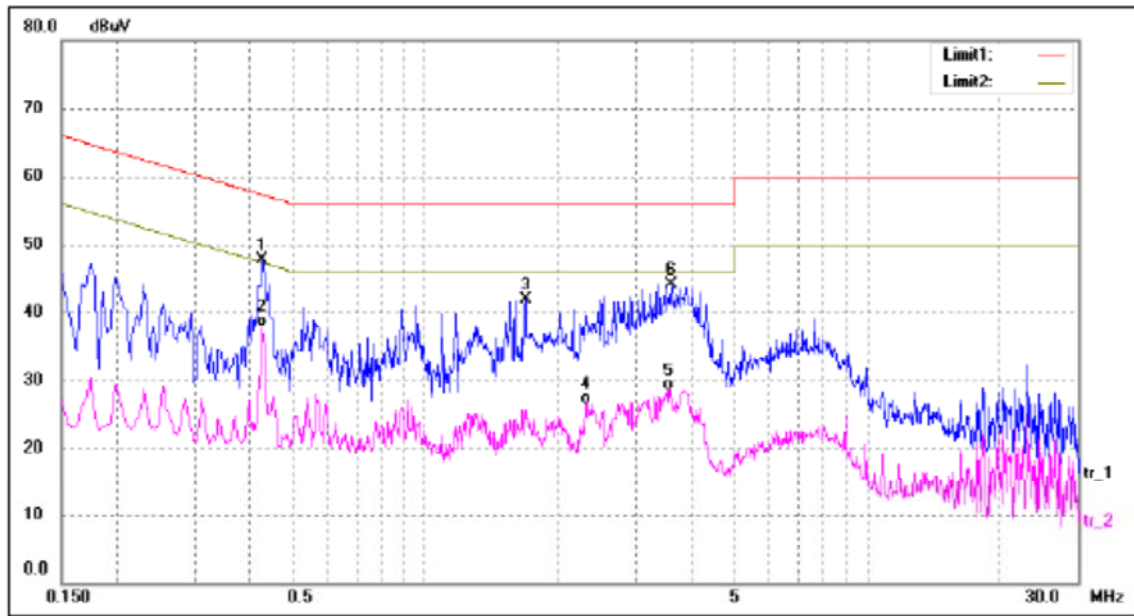

No.	Frequency (MHz)	Reading (dBuV)	Correct (dB/m)	Result (dBuV)	Limit (dBuV)	Margin (dB)	Detector
1	0.4260	37.98	9.80	47.78	57.33	-9.55	peak
2*	0.4260	28.12	9.80	37.92	47.33	-9.41	AVG
3	1.6860	32.15	9.74	41.89	56.00	-14.11	peak
4	2.2980	16.87	9.73	26.60	46.00	-19.40	AVG
5	3.5660	18.80	9.70	28.50	46.00	-17.50	AVG
6	3.6020	34.41	9.69	44.10	56.00	-11.90	peak

## 4 RADIATED EMISSION TEST

### 4.1 Radiation Limit

For unintentional device, according to § 15.109(a), except for Class A digital devices, the field strength of radiated emissions from unintentional radiators at a distance of 3 meters shall not exceed the following values:

Frequency (MHz)	Distance (Meters)	Radiated (dB $\mu$ V/m)	Radiated ( $\mu$ V/m)
30-88	3	40	100
88-216	3	43.5	150
216-960	3	46	200
Above 960	3	54	500

For intentional device, according to § 15.209(a), the general requirement of field strength of radiated emissions from intentional radiators at a distance of 3 meters shall not exceed the above table.

### 4.2 Test Setup

#### (1) Radiated Emission Test-Up Frequency Below 30MHz

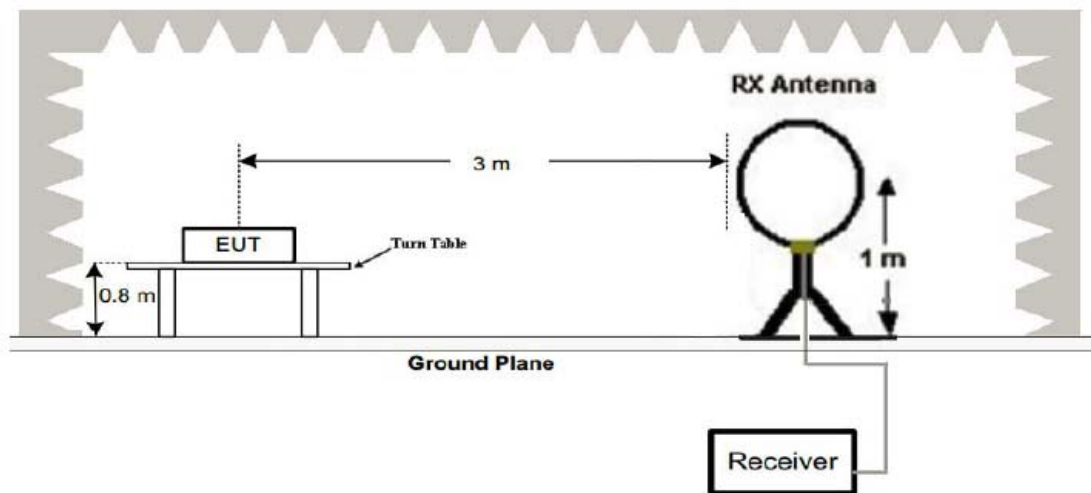

#### (2) Radiated Emission Test-Up Frequency 30MHz~1GHz

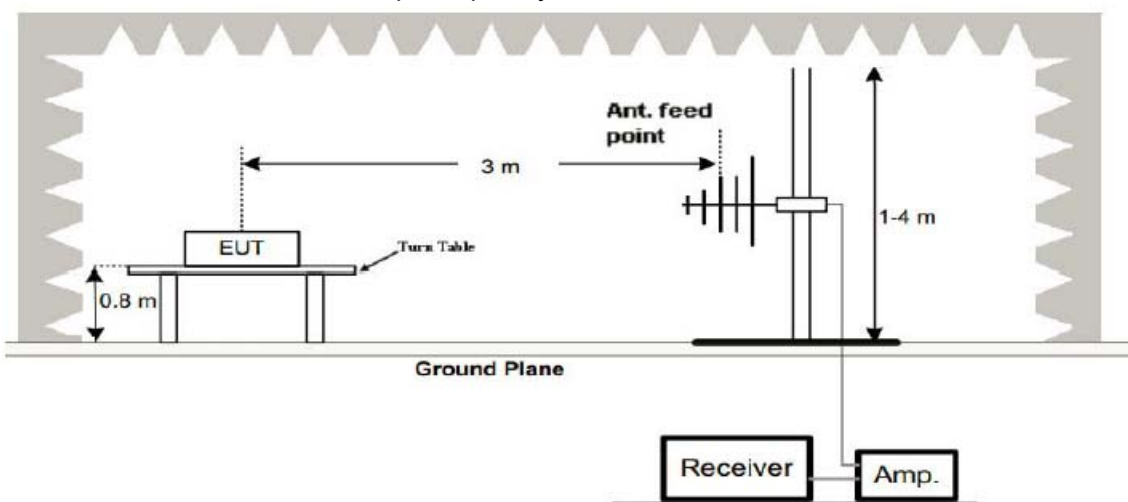

## (3) Radiated Emission Test-Up Frequency Above 1GHz

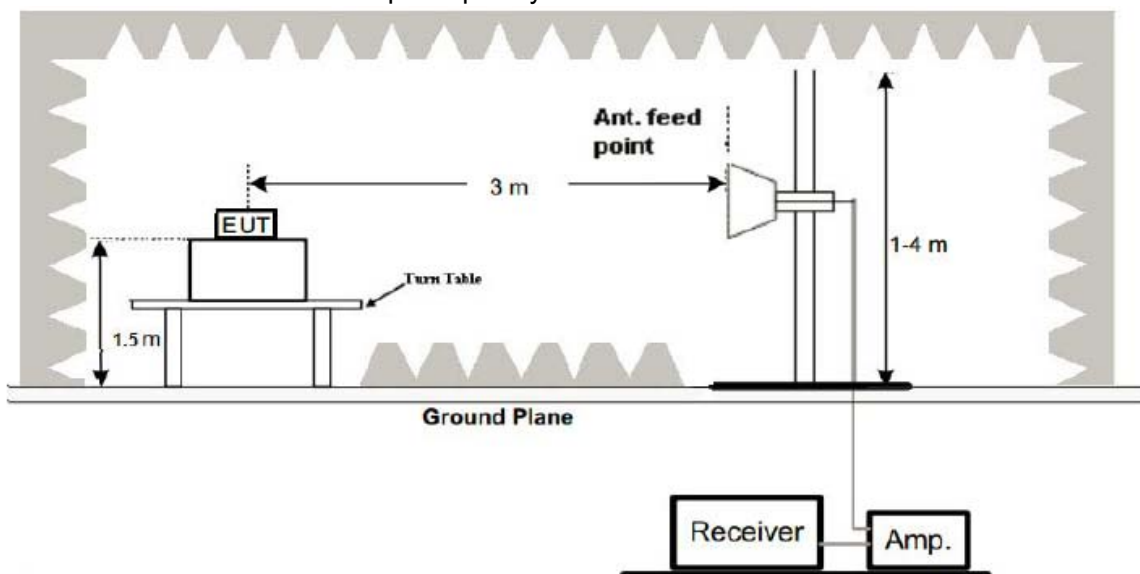

## 4.3 Test Procedure

1. Below 1GHz measurement the EUT is placed on turntable which is 0.8m above ground plane. And above 1GHz measurement EUT was placed on low permittivity and low tangent turn table which is 1.5m above ground plane.
2. The turntable shall be rotated for 360 degrees to determine the position of maximum emission level.
3. EUT is set 3m away from the receiving antenna, which is varied from 1m to 4m to find out the highest emissions.
4. Maximum procedure was performed on the six highest emissions to ensure EUT compliance.
5. And also, each emission was to be maximized by changing the polarization of receiving antenna both horizontal and vertical.
6. Repeat above procedures until the measurements for all frequencies are complete.
7. The test frequency range from 9KHz to 25GHz per FCC PART 15.33(a).

## Note:

For battery operated equipment, the equipment tests shall be performed using a new battery.

## 4.4 Test Result

## PASS

All the test modes completed for test. The worst case of Radiated Emission; the test data of this mode was reported.

Below 1GHz Test Results:  
Antenna polarity: H

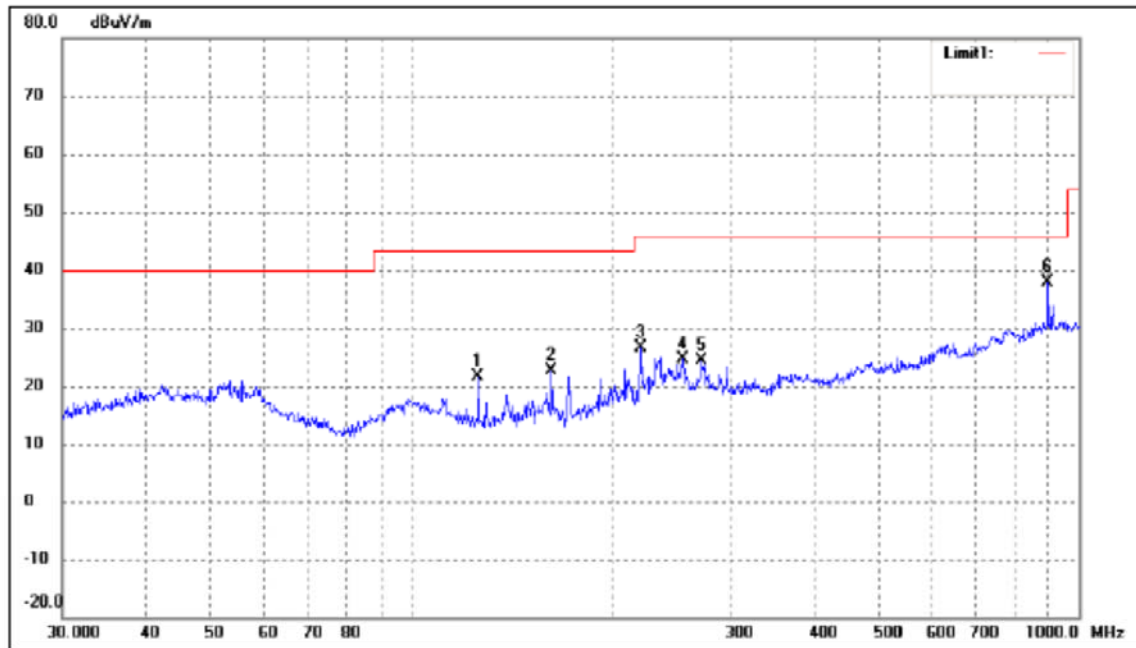

No.	Frequency (MHz)	Reading (dBuV/m)	Correct (dB/m)	Result (dBuV/m)	Limit (dBuV/m)	Margin (dB)	Degree ( )	Height (cm)	Remark
1	125.8864	35.56	-14.02	21.54	43.50	-21.96	165	100	peak
2	162.0414	37.63	-14.96	22.67	43.50	-20.83	277	100	peak
3	220.6171	39.04	-12.44	26.60	46.00	-19.40	77	100	peak
4	254.7284	35.03	-10.30	24.73	46.00	-21.27	132	100	peak
5	272.2776	34.07	-9.73	24.34	46.00	-21.66	279	100	peak
6	896.9965	36.42	1.41	37.83	46.00	-8.17	331	100	peak

Antenna polarity: V

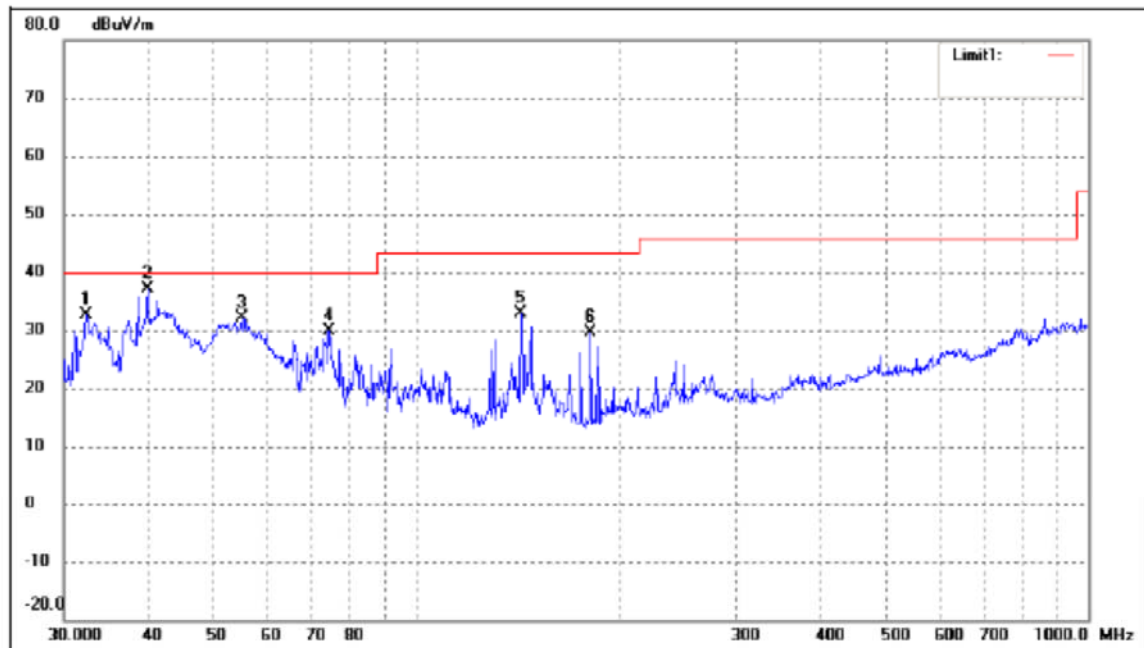

No.	Frequency (MHz)	Reading (dBuV/m)	Correct dB/m	Result (dBuV/m)	Limit (dBuV/m)	Margin (dB)	Degree ( )	Height (cm)	Remark
1	32.4059	44.82	-12.15	32.67	40.00	-7.33	54	100	peak
2	39.9942	47.51	-10.40	37.11	40.00	-2.89	178	100	peak
3	55.2207	44.13	-12.11	32.02	40.00	-7.98	122	100	peak
4	74.3955	46.92	-17.09	29.83	40.00	-10.17	94	100	peak
5	143.3261	47.69	-14.85	32.84	43.50	-10.66	285	100	peak
6	181.9202	43.50	-13.97	29.53	43.50	-13.97	182	100	peak

Remark:

- (1) Measuring frequencies from 9 KHz to the 1 GHz, Radiated emission test from 9KHz to 30MHz was verified, and no any emission was found except system noise floor.
- (2) \* denotes emission frequency which appearing within the Restricted Bands specified in provision of 15.205, then the general radiated emission limits in 15.209 apply.
- (3) The IF bandwidth of EMI Test Receiver between 30MHz to 1GHz was 120KHz, 1 MHz for measuring above 1 GHz, below 30MHz was 10KHz.

## Above 1 GHz Test Results:

LOW CH1 (802.11b Mode)/2412

Horizontal:

Frequency	Meter Reading	Factor	Emission Level	Limits	Margin	Detector Type
(MHz)	(dB $\mu$ V)	(dB)	(dB $\mu$ V/m)	(dB $\mu$ V/m)	(dB)	
4824	59.21	-3.64	55.57	74	-18.43	peak
4824	45.39	-3.64	41.75	54	-12.25	AVG
7236	55.52	-0.95	54.57	74	-19.43	peak
7236	41.79	-0.95	40.84	54	-13.16	AVG
---	---	---	---	---	---	---
---	---	---	---	---	---	---

Remark: Factor = Antenna Factor + Cable Loss – Pre-amplifier.

Vertical:

Frequency	Meter Reading	Factor	Emission Level	Limits	Margin	Detector Type
(MHz)	(dB $\mu$ V)	(dB)	(dB $\mu$ V/m)	(dB $\mu$ V/m)	(dB)	
4824	57.90	-3.64	54.26	74	-19.74	peak
4824	44.42	-3.64	40.78	54	-13.22	AVG
7236	53.60	-0.95	52.65	74	-21.35	peak
7236	40.14	-0.95	39.19	54	-14.81	AVG
---	---	---	---	---	---	---
---	---	---	---	---	---	---

Remark: Factor = Antenna Factor + Cable Loss – Pre-amplifier.



MID CH6 (802.11b Mode)/2437

Horizontal:

Frequency	Meter Reading	Factor	Emission Level	Limits	Margin	Detector Type
(MHz)	(dB $\mu$ V)	(dB)	(dB $\mu$ V/m)	(dB $\mu$ V/m)	(dB)	
4874	59.05	-3.51	55.54	74	-18.46	peak
4874	45.19	-3.51	41.68	54	-12.32	AVG
7311	55.24	-0.82	54.42	74	-19.58	peak
7311	41.66	-0.82	40.84	54	-13.16	AVG
---	---	---	---	---	---	---
---	---	---	---	---	---	---

Remark: Factor = Antenna Factor + Cable Loss – Pre-amplifier.

Vertical:

Frequency	Meter Reading	Factor	Emission Level	Limits	Margin	Detector Type
(MHz)	(dB $\mu$ V)	(dB)	(dB $\mu$ V/m)	(dB $\mu$ V/m)	(dB)	
4874	57.35	-3.51	53.84	74	-20.16	peak
4874	43.14	-3.51	39.63	54	-14.37	AVG
7311	52.29	-0.82	51.47	74	-22.53	peak
7311	39.34	-0.82	38.52	54	-15.48	AVG
---	---	---	---	---	---	---
---	---	---	---	---	---	---

Remark: Factor = Antenna Factor + Cable Loss – Pre-amplifier.

## HIGH CH11 (802.11b Mode)/2462

Horizontal:

Frequency	Meter Reading	Factor	Emission Level	Limits	Margin	Detector Type
(MHz)	(dB $\mu$ V)	(dB)	(dB $\mu$ V/m)	(dB $\mu$ V/m)	(dB)	
4924	58.86	-3.43	55.43	74	-18.57	peak
4924	45.49	-3.43	42.06	54	-11.94	AVG
7386	55.43	-0.75	54.68	74	-19.32	peak
7386	42.07	-0.75	41.32	54	-12.68	AVG
---	---	---	---	---	---	---
---	---	---	---	---	---	---

Remark: Factor = Antenna Factor + Cable Loss – Pre-amplifier.

Vertical:

Frequency	Meter Reading	Factor	Emission Level	Limits	Margin	Detector Type
(MHz)	(dB $\mu$ V)	(dB)	(dB $\mu$ V/m)	(dB $\mu$ V/m)	(dB)	
4924	57.70	-3.43	54.27	74	-19.73	peak
4924	43.92	-3.43	40.49	54	-13.51	AVG
7386	52.29	-0.75	51.54	74	-22.46	peak
7386	38.57	-0.75	37.82	54	-16.18	AVG
---	---	---	---	---	---	---
---	---	---	---	---	---	---

Remark: Factor = Antenna Factor + Cable Loss – Pre-amplifier.

Remark:

- (1) Measuring frequencies from 1 GHz to the 25 GHz.
- (2) "F" denotes fundamental frequency; "H" denotes spurious frequency. "E" denotes band edge frequency.
- (3) \* denotes emission frequency which appearing within the Restricted Bands specified in provision of 15.205, then the general radiated emission limits in 15.209 apply.
- (4) Data of measurement within this frequency range shown "---" in the table above means the reading of emissions are attenuated more than 20dB below the permissible limits or the field strength is too small to be measured.
- (5) The IF bandwidth of EMI Test Receiver between 30MHz to 1GHz was 120KHz, 1 MHz for measuring above 1 GHz, below 30MHz was 10KHz.
- (6) When the test results of Peak Detected below the limits of Average Detected, the Average Detected is not need completed. For example: Top Channel at Fundamental 73.16dBuV/m(PK Value) <93.98(AV Limit), at harmonic 53.20 dBuV/m(PK Value) <54 dBuV/m(AV Limit), the Average Detected not need to completed.

LOW CH1 (802.11g Mode)/2412

Horizontal:

Frequency	Meter Reading	Factor	Emission Level	Limits	Margin	Detector Type
(MHz)	(dB $\mu$ V)	(dB)	(dB $\mu$ V/m)	(dB $\mu$ V/m)	(dB)	
4824	58.17	-3.64	54.53	74	-19.47	peak
4824	44.79	-3.64	41.15	54	-12.85	AVG
7236	54.81	-0.95	53.86	74	-20.14	peak
7236	41.23	-0.95	40.28	54	-13.72	AVG
---	---	---	---	---	---	---
---	---	---	---	---	---	---

Remark: Factor = Antenna Factor + Cable Loss – Pre-amplifier.

Vertical:

Frequency	Meter Reading	Factor	Emission Level	Limits	Margin	Detector Type
(MHz)	(dB $\mu$ V)	(dB)	(dB $\mu$ V/m)	(dB $\mu$ V/m)	(dB)	
4824	58.18	-3.64	54.54	74	-19.46	peak
4824	44.80	-3.64	41.16	54	-12.84	AVG
7236	53.58	-0.95	52.63	74	-21.37	peak
7236	39.66	-0.95	38.71	54	-15.29	AVG
---	---	---	---	---	---	---
---	---	---	---	---	---	---

Remark: Factor = Antenna Factor + Cable Loss – Pre-amplifier.

MID CH6 (802.11g Mode)/2437

Horizontal:

Frequency	Meter Reading	Factor	Emission Level	Limits	Margin	Detector Type
(MHz)	(dB $\mu$ V)	(dB)	(dB $\mu$ V/m)	(dB $\mu$ V/m)	(dB)	
4874	57.79	-3.51	54.28	74	-19.72	peak
4874	43.66	-3.51	40.15	54	-13.85	AVG
7311	53.36	-0.82	52.54	74	-21.46	peak
7311	40.09	-0.82	39.27	54	-14.73	AVG
---	---	---	---	---	---	---
---	---	---	---	---	---	---

Remark: Factor = Antenna Factor + Cable Loss – Pre-amplifier.

Vertical:

Frequency	Meter Reading	Factor	Emission Level	Limits	Margin	Detector Type
(MHz)	(dB $\mu$ V)	(dB)	(dB $\mu$ V/m)	(dB $\mu$ V/m)	(dB)	
4874	59.25	-3.51	55.74	74	-18.26	peak
4874	45.10	-3.51	41.59	54	-12.41	AVG
7311	55.29	-0.82	54.47	74	-19.53	peak
7311	42.04	-0.82	41.22	54	-12.78	AVG
---	---	---	---	---	---	---
---	---	---	---	---	---	---

Remark: Factor = Antenna Factor + Cable Loss – Pre-amplifier.

HIGH CH11 (802.11g Mode)/2462

Horizontal:

Frequency	Meter Reading	Factor	Emission Level	Limits	Margin	Detector Type
(MHz)	(dB $\mu$ V)	(dB)	(dB $\mu$ V/m)	(dB $\mu$ V/m)	(dB)	
4924	58.77	-3.43	55.34	74	-18.66	peak
4924	45.02	-3.43	41.59	54	-12.41	AVG
7386	55.02	-0.75	54.27	74	-19.73	peak
7386	42.17	-0.75	41.42	54	-12.58	AVG
---	---	---	---	---	---	---
---	---	---	---	---	---	---

Remark: Factor = Antenna Factor + Cable Loss – Pre-amplifier.

Vertical:

Frequency	Meter Reading	Factor	Emission Level	Limits	Margin	Detector Type
(MHz)	(dB $\mu$ V)	(dB)	(dB $\mu$ V/m)	(dB $\mu$ V/m)	(dB)	
4924	57.59	-3.43	54.16	74	-19.84	peak
4924	45.29	-3.43	41.86	54	-12.14	AVG
7386	54.07	-0.75	53.32	74	-20.68	peak
7386	41.00	-0.75	40.25	54	-13.75	AVG
---	---	---	---	---	---	---
---	---	---	---	---	---	---

Remark: Factor = Antenna Factor + Cable Loss – Pre-amplifier.

Remark:

(1) Measuring frequencies from 1 GHz to the 25 GHz.

(2) "F" denotes fundamental frequency; "H" denotes spurious frequency. "E" denotes band edge frequency.

(3) \* denotes emission frequency which appearing within the Restricted Bands specified in provision of 15.205, then the general radiated emission limits in 15.209 apply.

(4) Data of measurement within this frequency range shown "---" in the table above means the reading of emissions are attenuated more than 20dB below the permissible limits or the field strength is too small to be measured.

(5) The IF bandwidth of EMI Test Receiver between 30MHz to 1GHz was 120KHz, 1 MHz for measuring above 1 GHz, below 30MHz was 10KHz.

(6) When the test results of Peak Detected below the limits of Average Detected, the Average Detected is not need completed. For example: Top Channel at Fundamental 73.16dBuV/m(PK Value) <93.98(AV Limit), at harmonic 53.20 dBuV/m(PK Value) <54 dBuV/m(AV Limit), the Average Detected not need to completed.

LOW CH1 (802.11n/H20 Mode)/2412  
Horizontal:

Frequency	Meter Reading	Factor	Emission Level	Limits	Margin	Detector Type
(MHz)	(dB $\mu$ V)	(dB)	(dB $\mu$ V/m)	(dB $\mu$ V/m)	(dB)	
4824	58.80	-3.64	55.16	74	-18.84	peak
4824	45.29	-3.64	41.65	54	-12.35	AVG
7236	54.23	-0.95	53.28	74	-20.72	peak
7236	41.46	-0.95	40.51	54	-13.49	AVG
---	---	---	---	---	---	---
---	---	---	---	---	---	---

Remark: Factor = Antenna Factor + Cable Loss – Pre-amplifier.

Vertical:

Frequency	Meter Reading	Factor	Emission Level	Limits	Margin	Detector Type
(MHz)	(dB $\mu$ V)	(dB)	(dB $\mu$ V/m)	(dB $\mu$ V/m)	(dB)	
4824	58.48	-3.64	54.84	74	-19.16	peak
4824	45.06	-3.64	41.42	54	-12.58	AVG
7236	54.23	-0.95	53.28	74	-20.72	peak
7236	41.06	-0.95	40.11	54	-13.89	AVG
---	---	---	---	---	---	---
---	---	---	---	---	---	---

Remark: Factor = Antenna Factor + Cable Loss – Pre-amplifier.

MID CH6 (802.11n/H20 Mode)/2437

Horizontal:

Frequency	Meter Reading	Factor	Emission Level	Limits	Margin	Detector Type
(MHz)	(dB $\mu$ V)	(dB)	(dB $\mu$ V/m)	(dB $\mu$ V/m)	(dB)	
4874	58.04	-3.51	54.53	74	-19.47	peak
4874	44.93	-3.51	41.42	54	-12.58	AVG
7311	54.36	-0.82	53.54	74	-20.46	peak
7311	41.05	-0.82	40.23	54	-13.77	AVG
---	---	---	---	---	---	---
---	---	---	---	---	---	---

Remark: Factor = Antenna Factor + Cable Loss – Pre-amplifier.

Vertical:

Frequency	Meter Reading	Factor	Emission Level	Limits	Margin	Detector Type
(MHz)	(dB $\mu$ V)	(dB)	(dB $\mu$ V/m)	(dB $\mu$ V/m)	(dB)	
4874	58.57	-3.51	55.06	74	-18.94	peak
4874	45.92	-3.51	42.41	54	-11.59	AVG
7311	54.20	-0.82	53.38	74	-20.62	peak
7311	41.47	-0.82	40.65	54	-13.35	AVG
---	---	---	---	---	---	---
---	---	---	---	---	---	---

Remark: Factor = Antenna Factor + Cable Loss – Pre-amplifier.

HIGH CH11 (802.11n/H20 Mode)/2462

Horizontal:

Frequency	Meter Reading	Factor	Emission Level	Limits	Margin	Detector Type
(MHz)	(dB $\mu$ V)	(dB)	(dB $\mu$ V/m)	(dB $\mu$ V/m)	(dB)	
4924	58.69	-3.43	55.26	74	-18.74	peak
4924	45.27	-3.43	41.84	54	-12.16	AVG
7386	54.17	-0.75	53.42	74	-20.58	peak
7386	40.96	-0.75	40.21	54	-13.79	AVG
---	---	---	---	---	---	---
---	---	---	---	---	---	---

Remark: Factor = Antenna Factor + Cable Loss – Pre-amplifier.

Vertical:

Frequency	Meter Reading	Factor	Emission Level	Limits	Margin	Detector Type
(MHz)	(dB $\mu$ V)	(dB)	(dB $\mu$ V/m)	(dB $\mu$ V/m)	(dB)	
4924	57.97	-3.43	54.54	74	-19.46	peak
4924	44.76	-3.43	41.33	54	-12.67	AVG
7386	53.33	-0.75	52.58	74	-21.42	peak
7386	40.28	-0.75	39.53	54	-14.47	AVG
---	---	---	---	---	---	---
---	---	---	---	---	---	---

Remark: Factor = Antenna Factor + Cable Loss – Pre-amplifier.

Remark:

(1) Measuring frequencies from 1 GHz to the 25 GHz.

(2) "F" denotes fundamental frequency; "H" denotes spurious frequency. "E" denotes band edge frequency.

(3) \* denotes emission frequency which appearing within the Restricted Bands specified in provision of 15.205, then the general radiated emission limits in 15.209 apply.

(4) Data of measurement within this frequency range shown "---" in the table above means the reading of emissions are attenuated more than 20dB below the permissible limits or the field strength is too small to be measured.

(5) The IF bandwidth of EMI Test Receiver between 30MHz to 1GHz was 120KHz, 1 MHz for measuring above 1 GHz, below 30MHz was 10KHz.

(6) When the test results of Peak Detected below the limits of Average Detected, the Average Detected is not need completed. For example: Top Channel at Fundamental 73.16dBuV/m(PK Value) <93.98(AV Limit), at harmonic 53.20 dBuV/m(PK Value) <54 dBuV/m(AV Limit), the Average Detected not need to completed.



LOW CH3 (802.11n/H40 Mode)/2422

Horizontal:

Frequency	Meter Reading	Factor	Emission Level	Limits	Margin	Detector Type
(MHz)	(dB $\mu$ V)	(dB)	(dB $\mu$ V/m)	(dB $\mu$ V/m)	(dB)	
4924	55.20	-3.63	51.57	74	-22.43	peak
4924	41.05	-3.63	37.42	54	-16.58	AVG
7386	51.22	-0.94	50.28	74	-23.72	peak
7386	37.26	-0.94	36.32	54	-17.68	AVG
---	---	---	---	---	---	---
---	---	---	---	---	---	---

Remark: Factor = Antenna Factor + Cable Loss – Pre-amplifier.

Vertical:

Frequency	Meter Reading	Factor	Emission Level	Limits	Margin	Detector Type
(MHz)	(dB $\mu$ V)	(dB)	(dB $\mu$ V/m)	(dB $\mu$ V/m)	(dB)	
4924	54.69	-3.63	51.06	74	-22.94	peak
4924	41.85	-3.63	38.22	54	-15.78	AVG
7386	51.58	-0.94	50.64	74	-23.36	peak
7386	38.76	-0.94	37.82	54	-16.18	AVG
---	---	---	---	---	---	---
---	---	---	---	---	---	---

Remark: Factor = Antenna Factor + Cable Loss – Pre-amplifier.

MID CH6 (802.11n/H40 Mode)/2437

Horizontal:

Frequency	Meter Reading	Factor	Emission Level	Limits	Margin	Detector Type
(MHz)	(dB $\mu$ V)	(dB)	(dB $\mu$ V/m)	(dB $\mu$ V/m)	(dB)	
4874	55.77	-3.51	52.26	74	-21.74	peak
4874	42.66	-3.51	39.15	54	-14.85	AVG
7311	52.09	-0.82	51.27	74	-22.73	peak
7311	39.15	-0.82	38.33	54	-15.67	AVG
---	---	---	---	---	---	---
---	---	---	---	---	---	---

Remark: Factor = Antenna Factor + Cable Loss – Pre-amplifier.

Vertical:

Frequency	Meter Reading	Factor	Emission Level	Limits	Margin	Detector Type
(MHz)	(dB $\mu$ V)	(dB)	(dB $\mu$ V/m)	(dB $\mu$ V/m)	(dB)	
4874	55.16	-3.51	51.65	74	-22.35	peak
4874	41.70	-3.51	38.19	54	-15.81	AVG
7311	51.11	-0.82	50.29	74	-23.71	peak
7311	38.18	-0.82	37.36	54	-16.64	AVG
---	---	---	---	---	---	---
---	---	---	---	---	---	---

Remark: Factor = Antenna Factor + Cable Loss – Pre-amplifier.

HIGH CH9 (802.11n/H40 Mode)/2452

Horizontal:

Frequency	Meter Reading	Factor	Emission Level	Limits	Margin	Detector Type
(MHz)	(dB $\mu$ V)	(dB)	(dB $\mu$ V/m)	(dB $\mu$ V/m)	(dB)	
4904	56.68	-3.43	53.25	74	-20.75	peak
4904	43.05	-3.43	39.62	54	-14.38	AVG
7356	51.99	-0.75	51.24	74	-22.76	peak
7356	38.58	-0.75	37.83	54	-16.17	AVG
---	---	---	---	---	---	---
---	---	---	---	---	---	---

Remark: Factor = Antenna Factor + Cable Loss – Pre-amplifier.

Vertical:

Frequency	Meter Reading	Factor	Emission Level	Limits	Margin	Detector Type
(MHz)	(dB $\mu$ V)	(dB)	(dB $\mu$ V/m)	(dB $\mu$ V/m)	(dB)	
4904	56.24	-3.43	52.81	74	-21.19	peak
4904	42.61	-3.43	39.18	54	-14.82	AVG
7356	51.69	-0.75	50.94	74	-23.06	peak
7356	38.26	-0.75	37.51	54	-16.49	AVG
---	---	---	---	---	---	---
---	---	---	---	---	---	---

Remark: Factor = Antenna Factor + Cable Loss – Pre-amplifier.

Remark:

- (1) Measuring frequencies from 1 GHz to the 25 GHz.
- (2) "F" denotes fundamental frequency; "H" denotes spurious frequency. "E" denotes band edge frequency.
- (3) \* denotes emission frequency which appearing within the Restricted Bands specified in provision of 15.205, then the general radiated emission limits in 15.209 apply.
- (4) Data of measurement within this frequency range shown "---" in the table above means the reading of emissions are attenuated more than 20dB below the permissible limits or the field strength is too small to be measured.
- (5) The IF bandwidth of EMI Test Receiver between 30MHz to 1GHz was 120KHz, 1 MHz for measuring above 1 GHz, below 30MHz was 10KHz.
- (6) When the test results of Peak Detected below the limits of Average Detected, the Average Detected is not need completed. For example: Top Channel at Fundamental 73.16dBuV/m(PK Value) <93.98(AV Limit), at harmonic 53.20 dBuV/m(PK Value) <54 dBuV/m(AV Limit), the Average Detected not need to completed.

## 5 BAND EDGE

### 5.1 Limits

Please refer section 15.247

All the lower and upper band-edges emissions appearing within 2310MHz to 2390MHz and 2483.5MHz to 2500MHz restricted frequency bands shall not exceed the limits shown in 15.209, all the other emissions outside operation frequency band 2400MHz to 2483.5MHz shall be at least 20dB below the fundamental emissions, or comply with 15.209 limits.

### 5.2 Test Procedure

The band edge compliance of RF radiated emission should be measured by following the guidance in ANSI C63.10 with respect to maximizing the emission by rotating the EUT, measuring the emission while the EUT is situated in three orthogonal planes (if appropriate), adjusting the measurement antenna height and polarization etc. Set RBW to 100KHz and VBM to 300KHz to measure the peak field strength and set RBW to 1MHz and VBW to 10Hz to measure the average radiated field strength. The conducted RF band edge was measured by using a spectrum analyzer. Set span wide enough to capture the highest in-band emission and the emission at the band edge. Set RBW to 100 KHz and VBW to 300 KHz, to measure the conducted peak band edge.

### 5.3 Test Result

**PASS**

Radiated Band Edge Test:  
802.11b-Lowest Bandedge  
Vertical (Worst case)

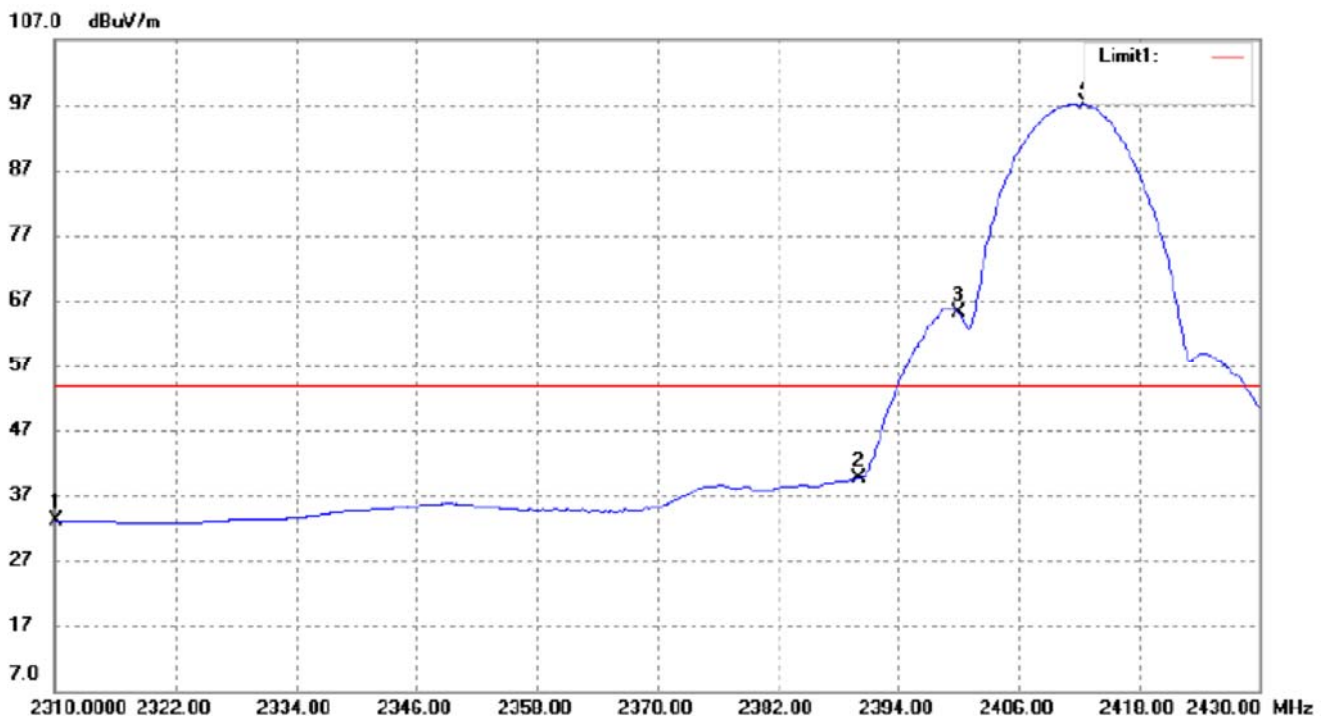

No.	Frequency (MHz)	Reading (dBuV/m)	Correct (dB/m)	Result (dBuV/m)	Limit (dBuV/m)	Margin (dB)	Remark
1	2310.000	36.74	-3.69	33.05	54.00	-20.95	Average Detector
	2310.000	49.49	-3.69	45.80	74.00	-28.20	Peak Detector
2	2390.000	43.15	-3.49	39.66	54.00	-14.34	Average Detector
	2390.000	57.65	-3.49	54.16	74.00	-19.84	Peak Detector
3	2400.000	68.65	-3.46	65.19	Delta =31.91dBc		Average Detector
4	2412.600	100.52	-3.42	97.10		Average Detector	

802.11b-Highest Bandedge  
Vertical (Worst case)

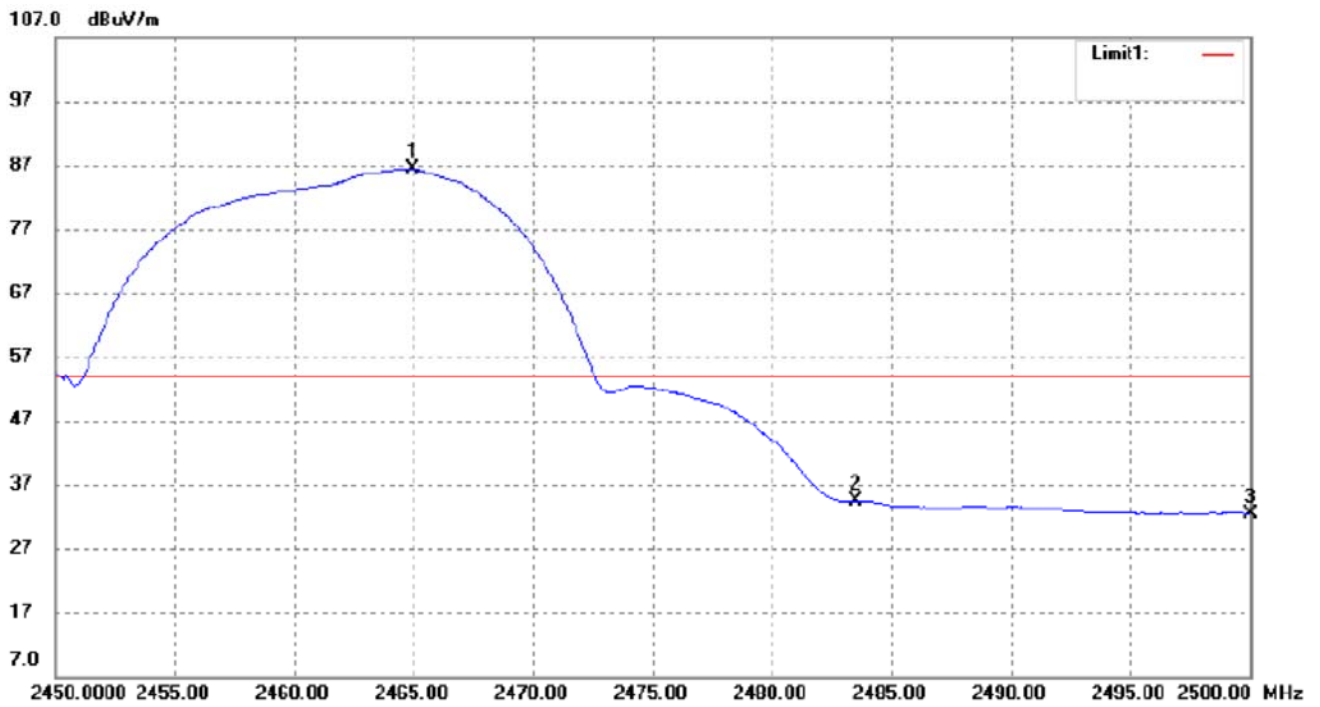

No.	Frequency (MHz)	Reading (dBuV/m)	Correct Factor(dB)	Result (dBuV/m)	Limit (dBuV/m)	Margin (dB)	Remark
1	2464.950	89.68	-3.29	86.39	/	/	Average Detector
	2463.650	97.45	-3.29	94.16	/	/	Peak Detector
2	2483.500	37.68	-3.25	34.43	54.00	-19.57	Average Detector
	2483.500	50.12	-3.25	46.87	74.00	-27.13	Peak Detector
3	2500.000	35.64	-3.20	32.44	54.00	-21.56	Average Detector
	2500.000	47.53	-3.20	44.33	74.00	-29.67	Peak Detector

802.11g-Lowest Bandedge

Vertical (Worst case)

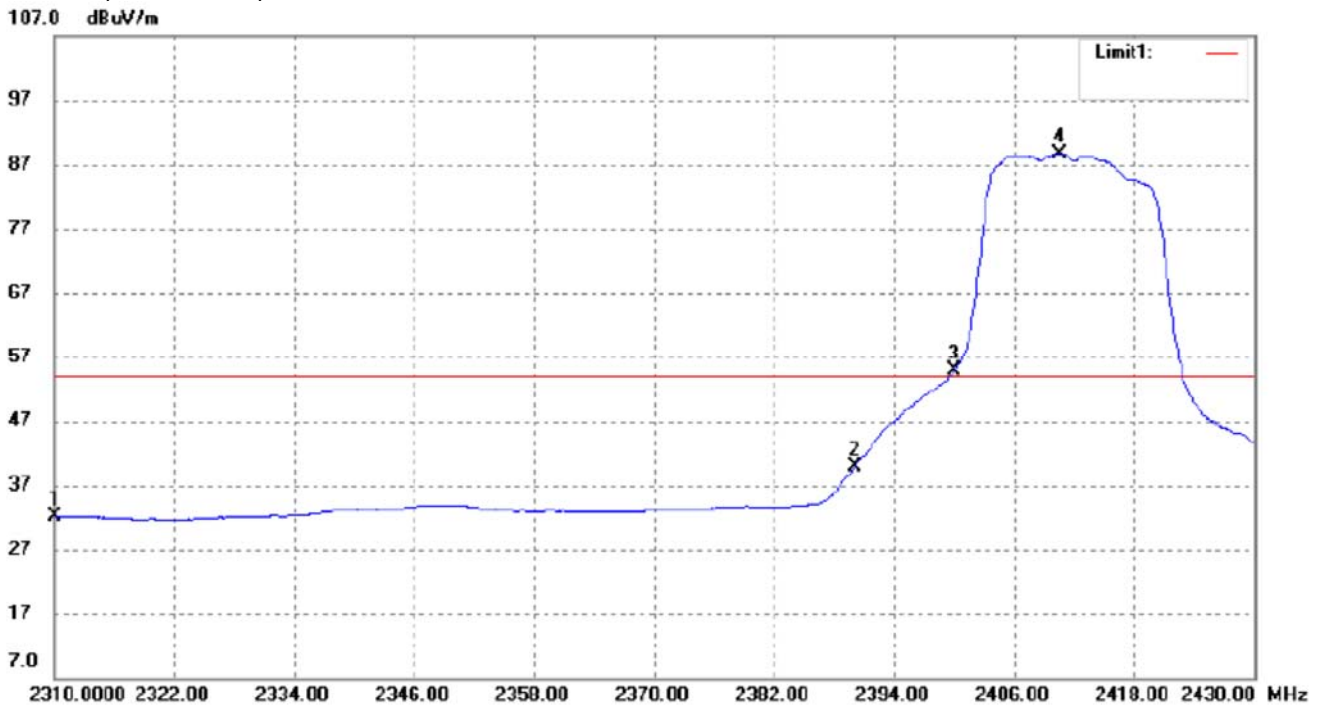

No.	Frequency (MHz)	Reading (dBuV/m)	Correct (dB/m)	Result (dBuV/m)	Limit (dBuV/m)	Margin (dB)	Remark
1	2310.000	35.79	-3.69	32.10	54.00	-21.90	Average Detector
	2310.000	47.17	-3.69	43.48	74.00	-30.52	Peak Detector
2	2390.000	43.37	-3.49	39.88	54.00	-14.12	Average Detector
	2390.000	62.75	-3.49	59.26	74.00	-14.74	Peak Detector
3	2400.000	58.29	-3.46	54.83	Delta =33.78dBc		Average Detector
4	2410.560	92.04	-3.43	88.61			Average Detector

802.11g-Highest Bandedge  
Vertical (Worst case)

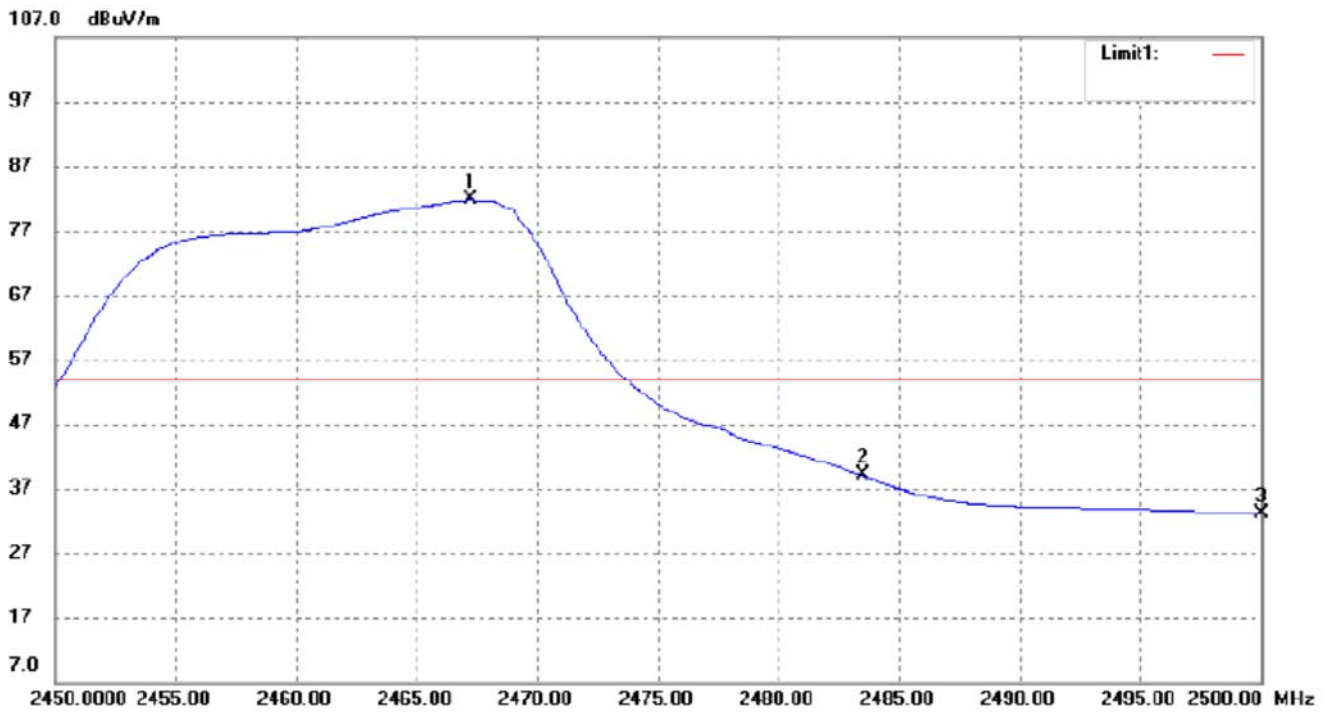

No.	Frequency (MHz)	Reading (dBuV/m)	Correct dB/m	Result (dBuV/m)	Limit (dBuV/m)	Margin (dB)	Remark
1	2467.250	85.08	-3.28	81.80	/	/	Average Detector
	2469.100	97.30	-3.28	94.02	/	/	Peak Detector
2	2483.500	42.28	-3.25	39.03	54.00	-14.97	Average Detector
	2483.500	56.90	-3.25	53.65	74.00	-20.35	Peak Detector
3	2500.000	36.43	-3.20	33.23	54.00	-20.77	Average Detector
	2500.000	49.68	-3.20	46.48	74.00	-27.52	Peak Detector

802.11n-HT20-Lowest Bandedge  
Vertical (Worst case)

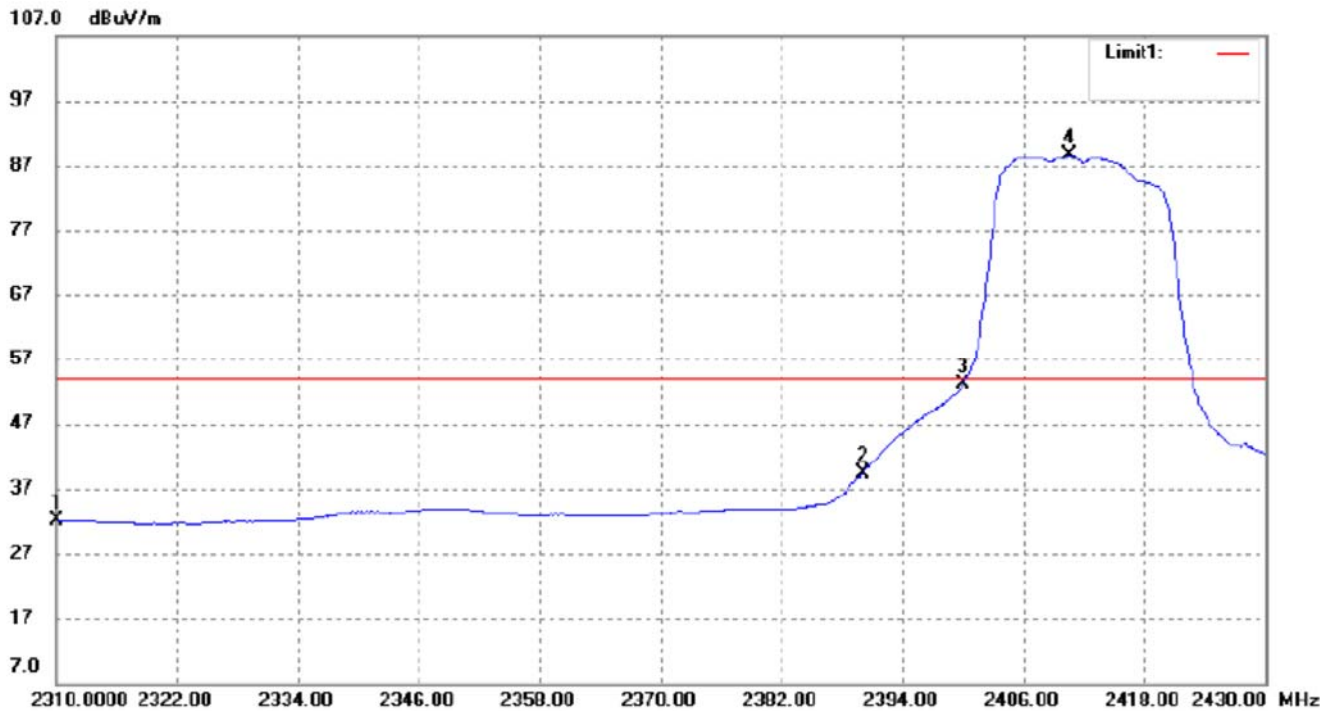

No.	Frequency (MHz)	Reading (dBuV/m)	Correct (dB/m)	Result (dBuV/m)	Limit (dBuV/m)	Margin (dB)	Remark
1	2310.000	35.73	-3.69	32.04	54.00	-21.96	Average Detector
		47.10	-3.69	43.41	74.00	-30.59	Peak Detector
2	2390.000	42.98	-3.49	39.49	54.00	-14.51	Average Detector
		62.93	-3.49	59.44	74.00	-14.56	Peak Detector
3	2400.000	56.69	-3.46	53.23	Delta =35.28dBc		Average Detector
4	2410.560	91.94	-3.43	88.51			Average Detector



802.11n-HT20-Highest Bandedge  
Vertical (Worst case)

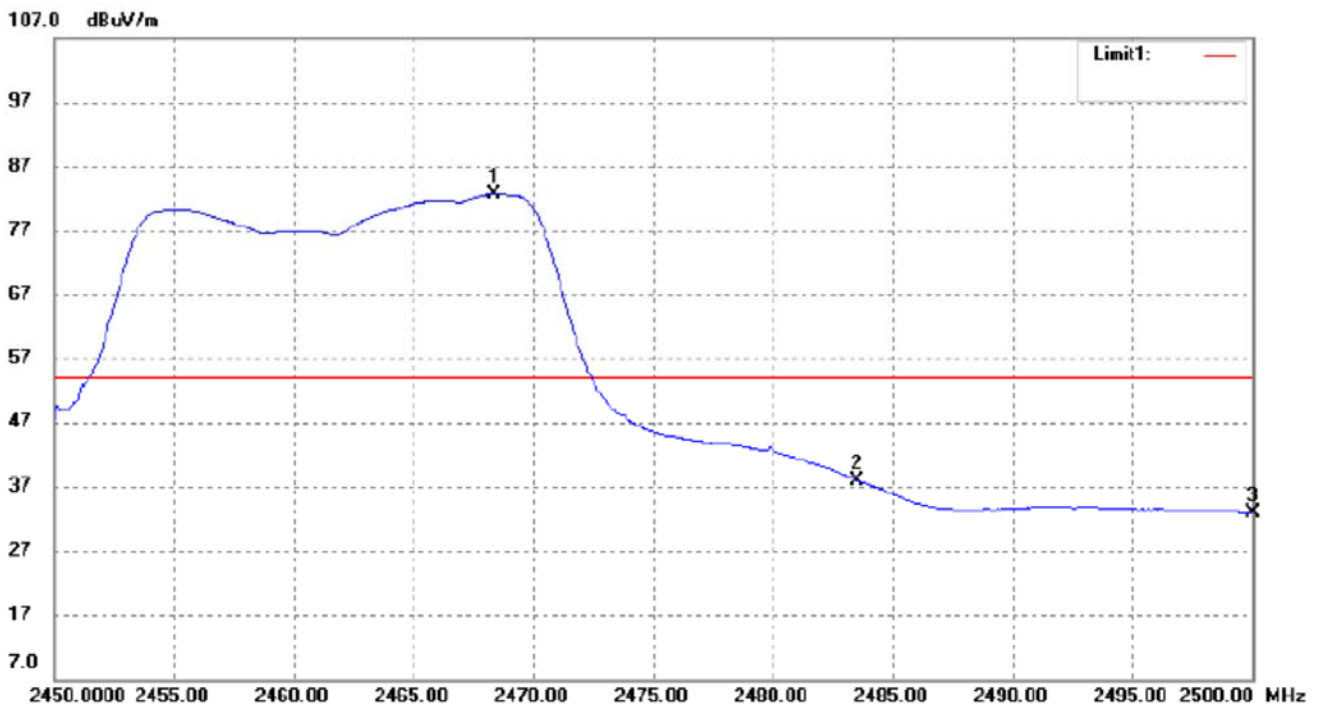

No.	Frequency (MHz)	Reading (dBuV/m)	Correct dB/m	Result (dBuV/m)	Limit (dBuV/m)	Margin (dB)	Remark
1	2468.350	85.88	-3.28	82.60	/	/	Average Detector
	2469.150	97.31	-3.28	94.03	/	/	Peak Detector
2	2483.500	41.23	-3.25	37.98	54.00	-16.02	Average Detector
	2483.500	57.50	-3.25	54.25	74.00	-19.75	Peak Detector
3	2500.000	36.13	-3.20	32.93	54.00	-21.07	Average Detector
	2500.000	51.05	-3.20	47.85	74.00	-26.15	Peak Detector

802.11n-HT40-Lowest Bandedge  
Vertical (Worst case)

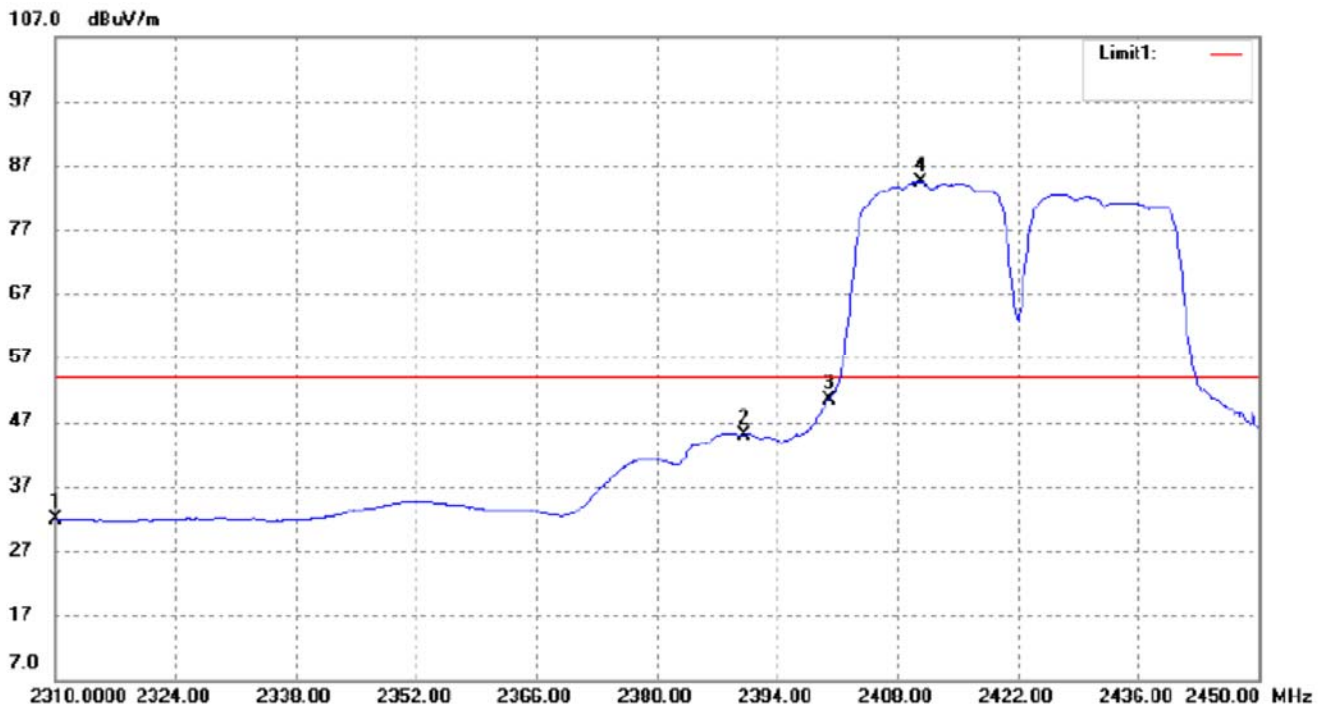

No.	Frequency (MHz)	Reading (dBuV/m)	Correct (dB/m)	Result (dBuV/m)	Limit (dBuV/m)	Margin (dB)	Remark
1	2310.000	35.68	-3.69	31.99	54.00	-22.01	Average Detector
	2310.000	49.43	-3.69	45.74	74.00	-28.26	Peak Detector
2	2390.000	48.40	-3.49	44.91	54.00	-9.09	Average Detector
	2390.000	69.39	-3.49	65.90	74.00	-8.10	Peak Detector
3	2400.000	53.90	-3.46	50.44	Delta =33.94dBc		Average Detector
4	2410.660	87.81	-3.43	84.38		Average Detector	

802.11n-HT40-Highest Bandedge  
Vertical (Worst case)

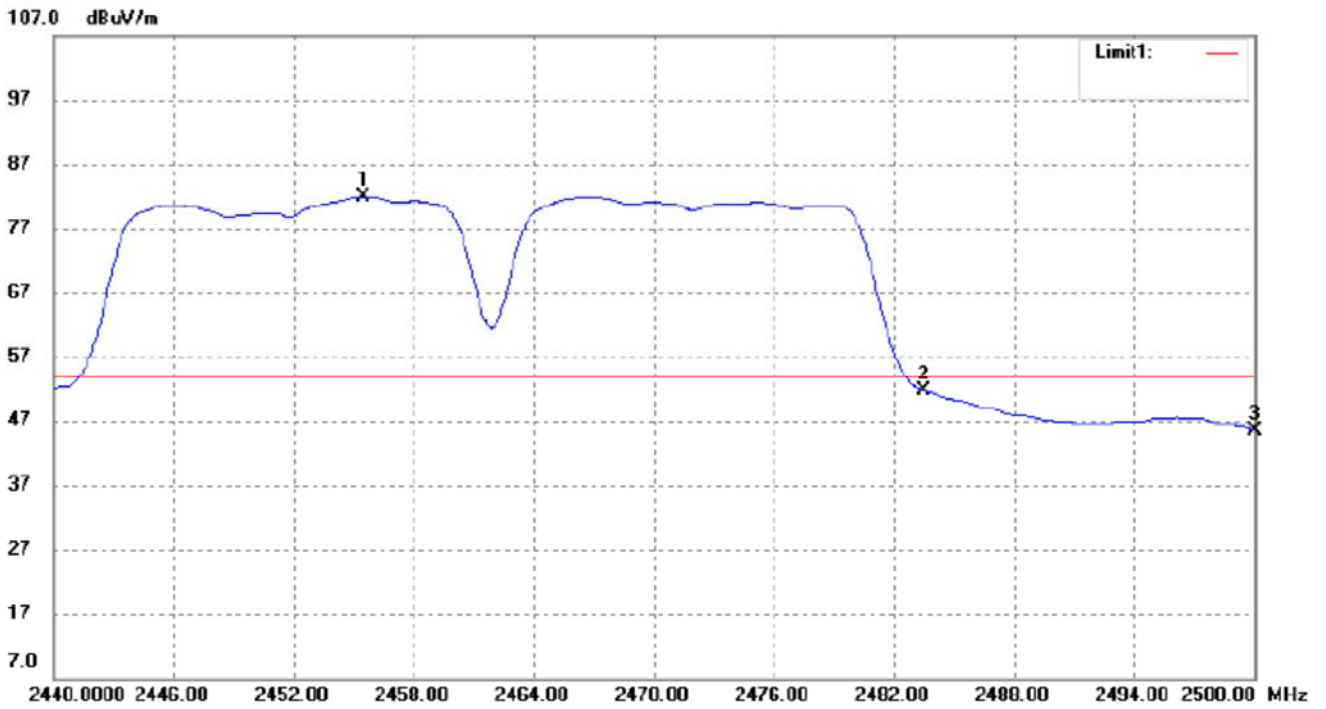

No.	Frequency (MHz)	Reading (dBuV/m)	Correct (dB/m)	Result (dBuV/m)	Limit (dBuV/m)	Margin (dB)	Remark
1	2455.480	85.27	-3.31	81.96	/	/	Average Detector
	2455.540	96.75	-3.31	93.44	/	/	Peak Detector
2	2483.500	54.86	-3.25	51.61	54.00	-2.39	Average Detector
	2483.500	74.81	-3.25	71.56	74.00	-2.44	Peak Detector
3	2500.000	48.67	-3.20	45.47	54.00	-8.53	Average Detector
	2500.000	64.82	-3.20	61.62	74.00	-12.38	Peak Detector

## 6 OCCUPIED BANDWIDTH MEASUREMENT

### 6.1 Test Limit

FCC Part15 (15.247) , Subpart C				
Section	Test Item	Limit	Frequency Range (MHz)	Result
15.247(a)(2)	Bandwidth	$\geq 500\text{KHz}$ (6dB bandwidth)	2400-2483.5	PASS

### 6.2 Test Procedure

1. The EUT was placed on a turn table which is 0.8m above ground plane.
2. Set EUT as normal operation.
3. Based on FCC Part15 C Section 15.247: RBW= 100KHz. VBW= 300 KHz.
4. The useful radiated emission from the EUT was detected by the spectrum analyser with peak detector.

### 6.3 Measurement Equipment Used

Same as Radiated Emission Measurement

### 6.4 Test Result

**PASS**

All the test modes completed for test.

TX 802.11b Mode			
Frequency	6dB Bandwidth (MHz)	Channel Separation (MHz)	Result
2412 MHz	9.065	>=500KHz	PASS
2437 MHz	9.141	>=500KHz	PASS
2462 MHz	9.615	>=500KHz	PASS

CH: 2412MHz

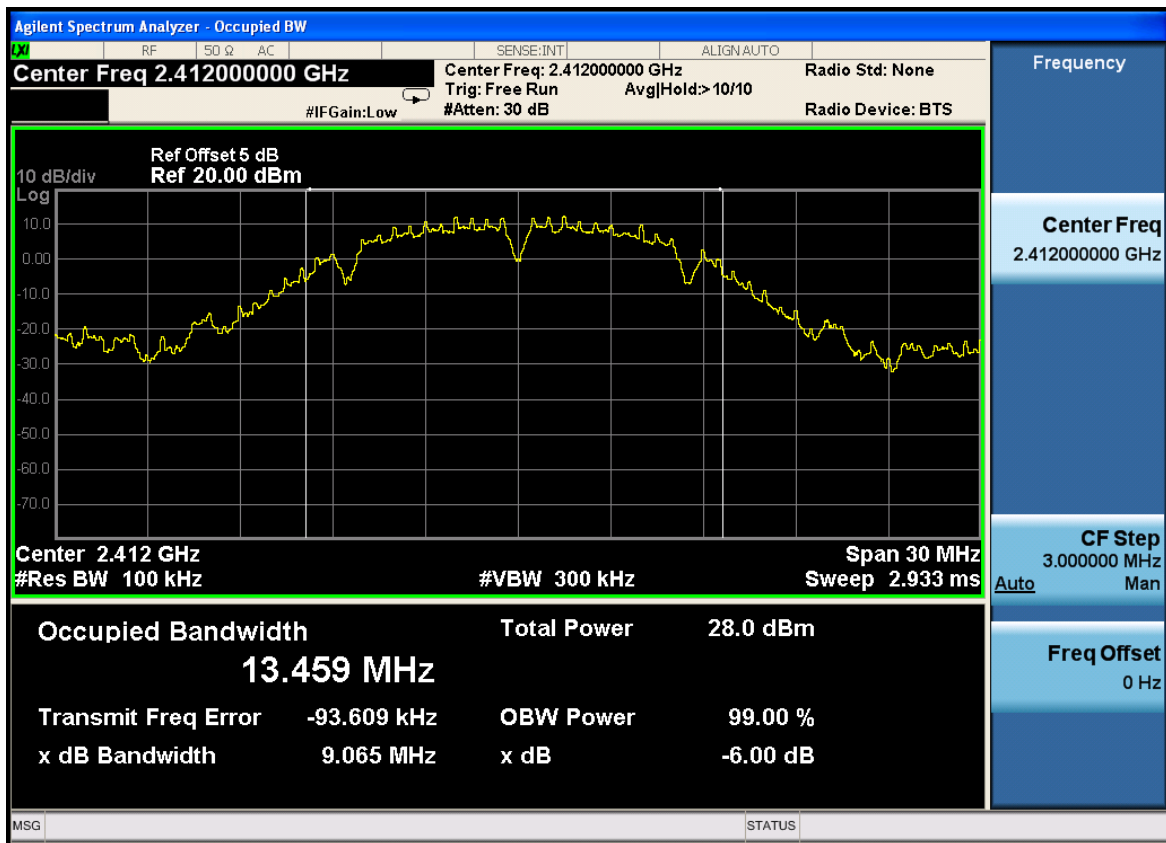

CH: 2437MHz

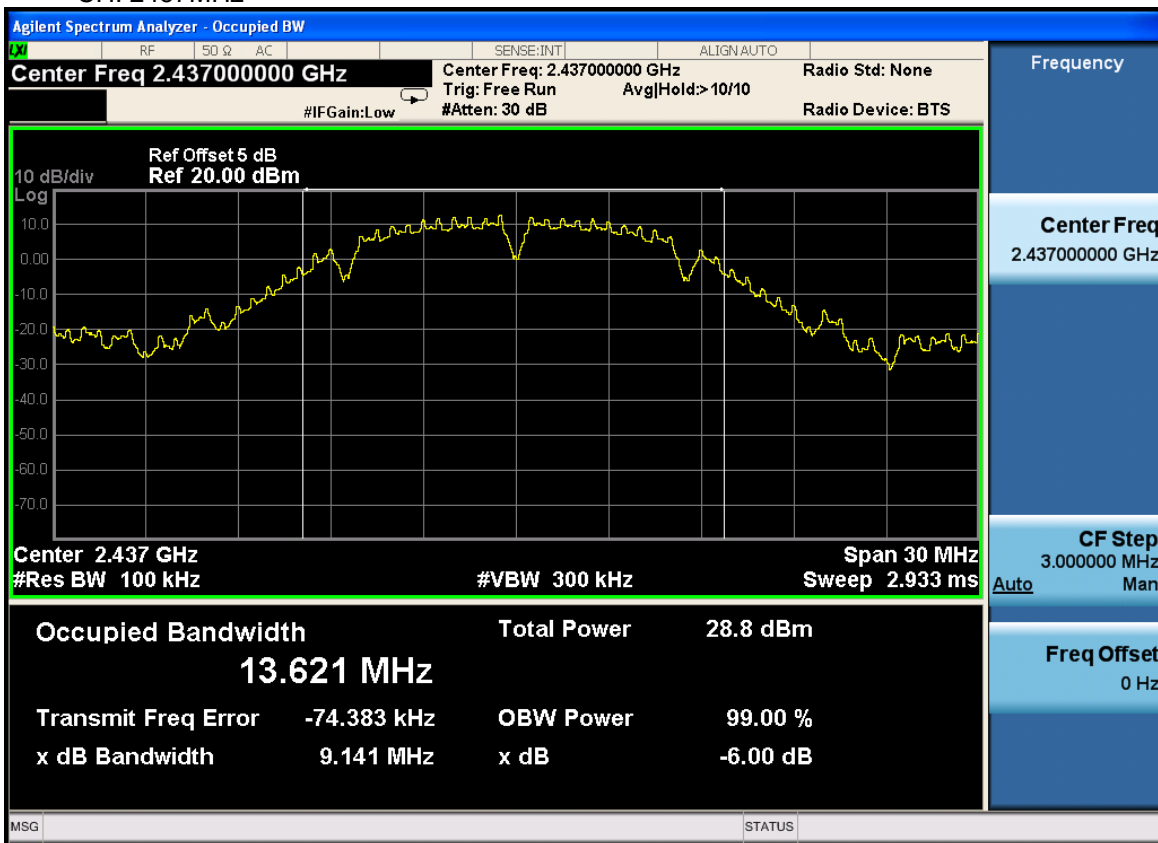

CH: 2462MHz

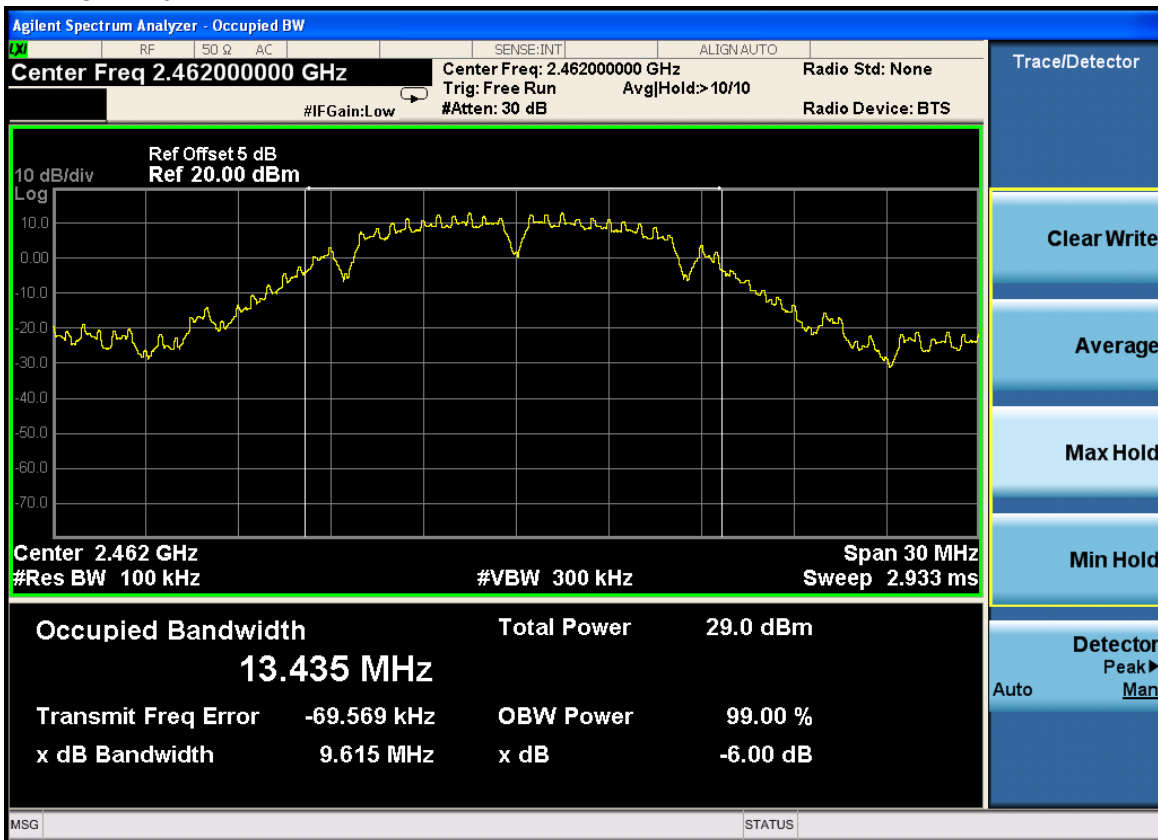

TX 802.11g Mode			
Frequency	6dB Bandwidth (MHz)	Channel Separation (MHz)	Result
2412 MHz	15.16	>=500KHz	PASS
2437 MHz	15.14	>=500KHz	PASS
2462 MHz	15.44	>=500KHz	PASS

CH: 2412MHz

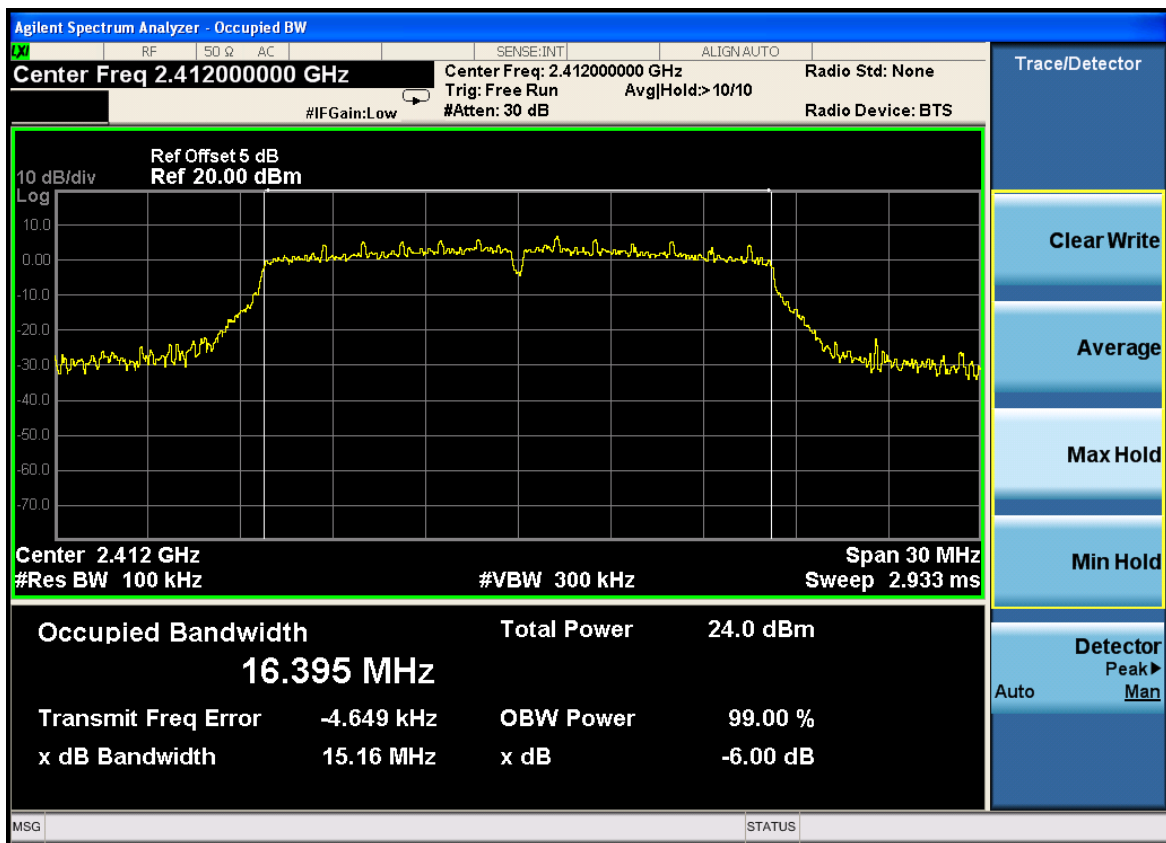

CH: 2437MHz

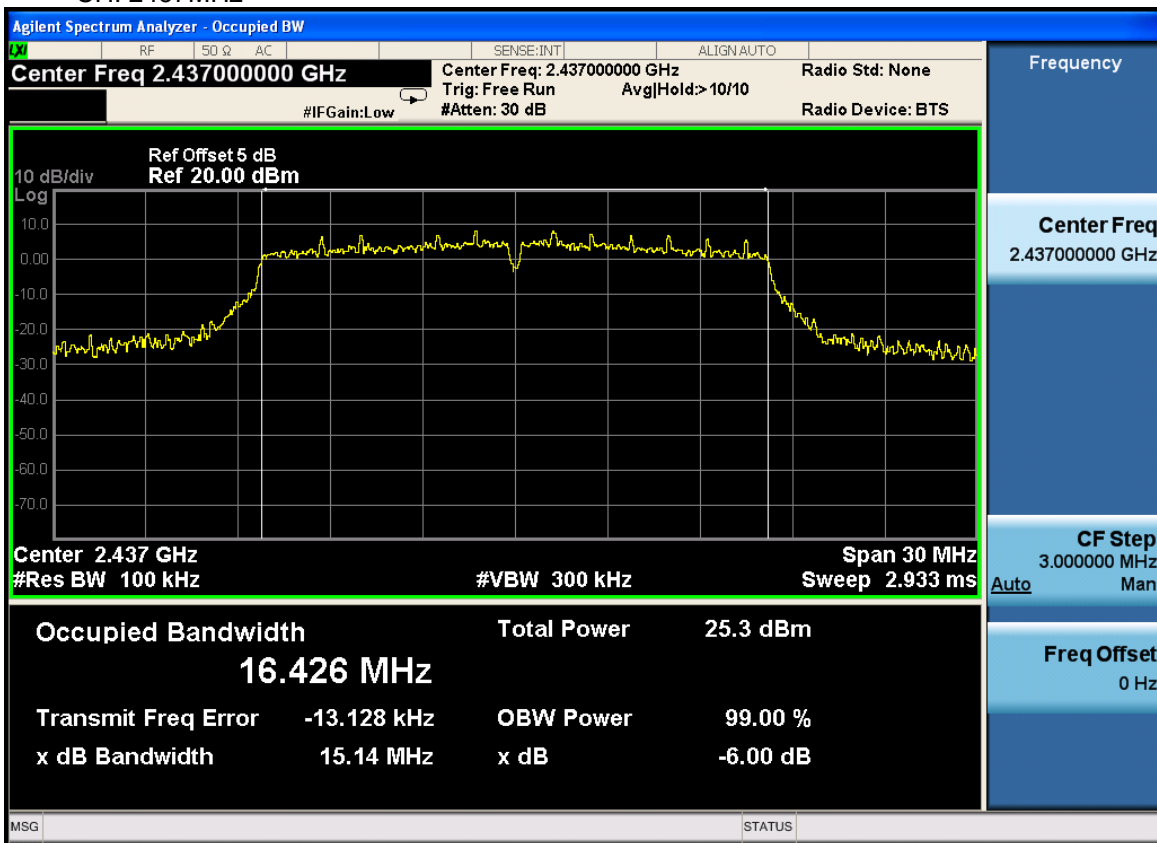

CH: 2462MHz

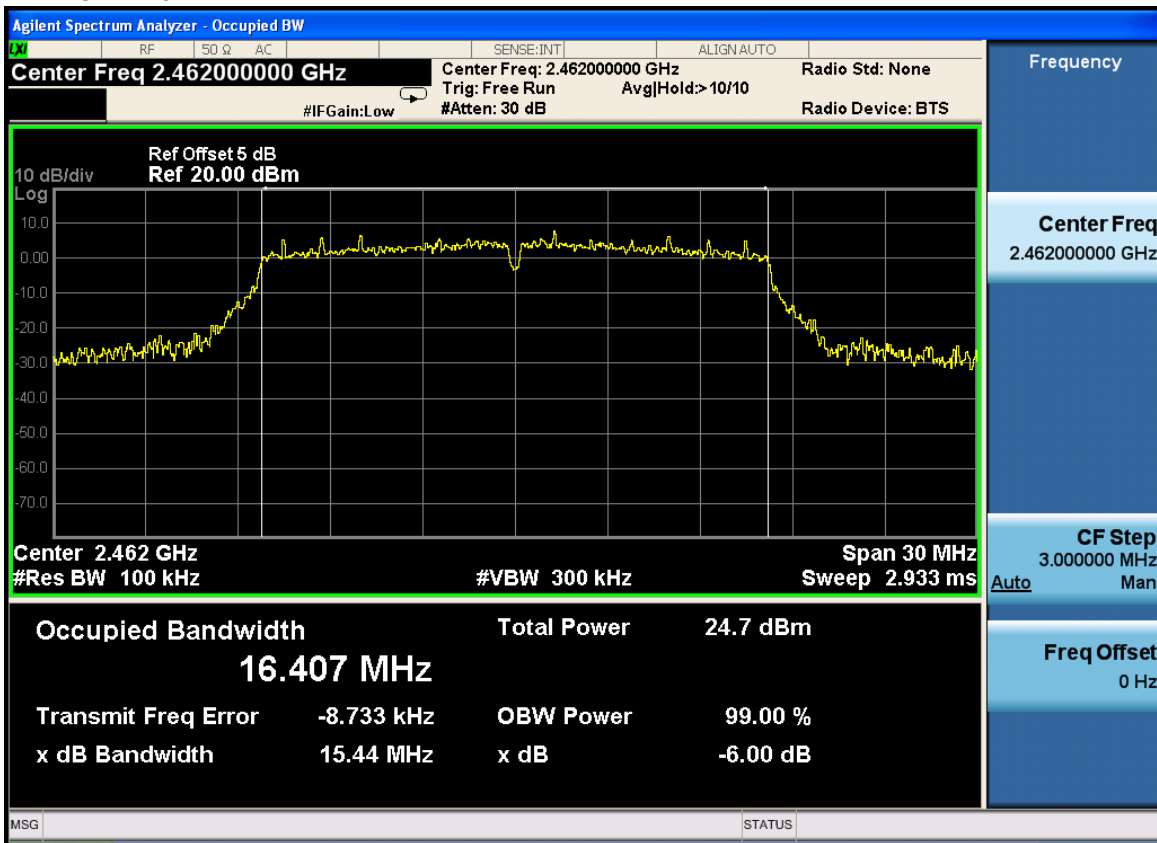



TX 802.11n/HT20 Mode			
Frequency	6dB Bandwidth (MHz)	Channel Separation (MHz)	Result
2412 MHz	17.19	>=500KHz	PASS
2437 MHz	15.46	>=500KHz	PASS
2462 MHz	15.15	>=500KHz	PASS

CH: 2412MHz

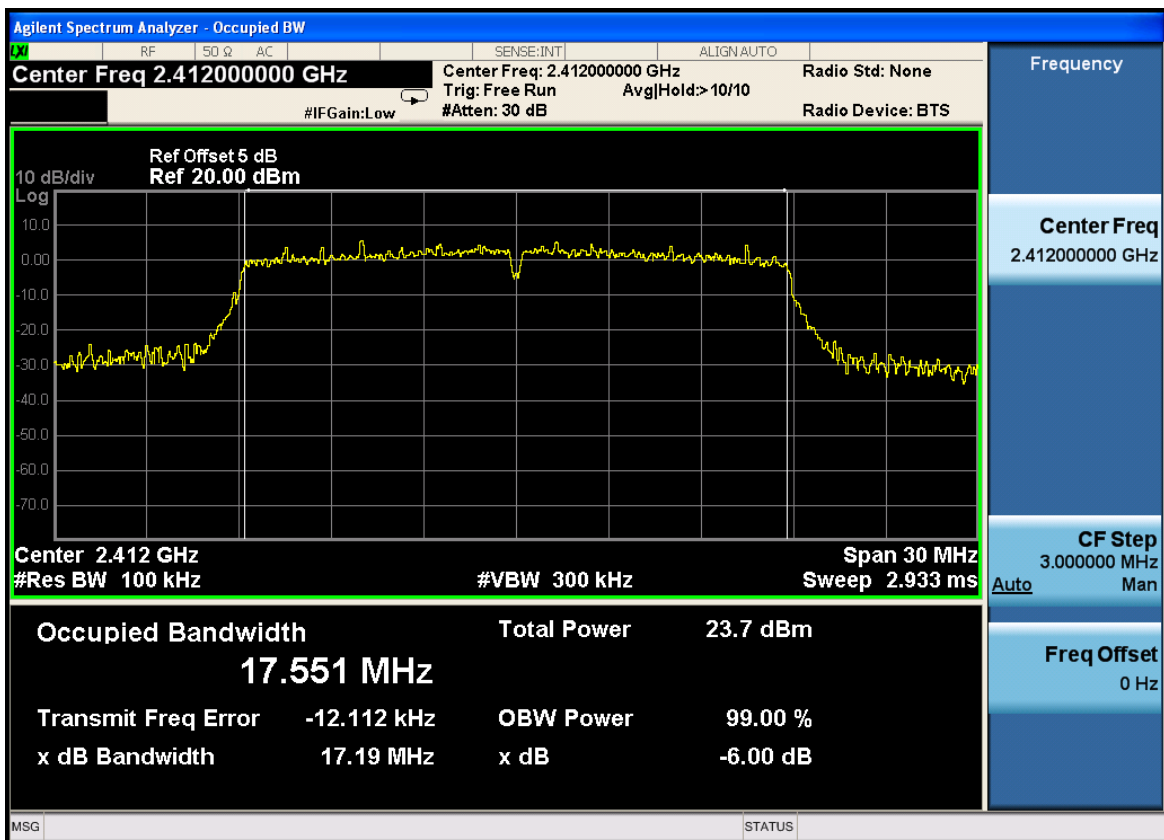

CH: 2437MHz

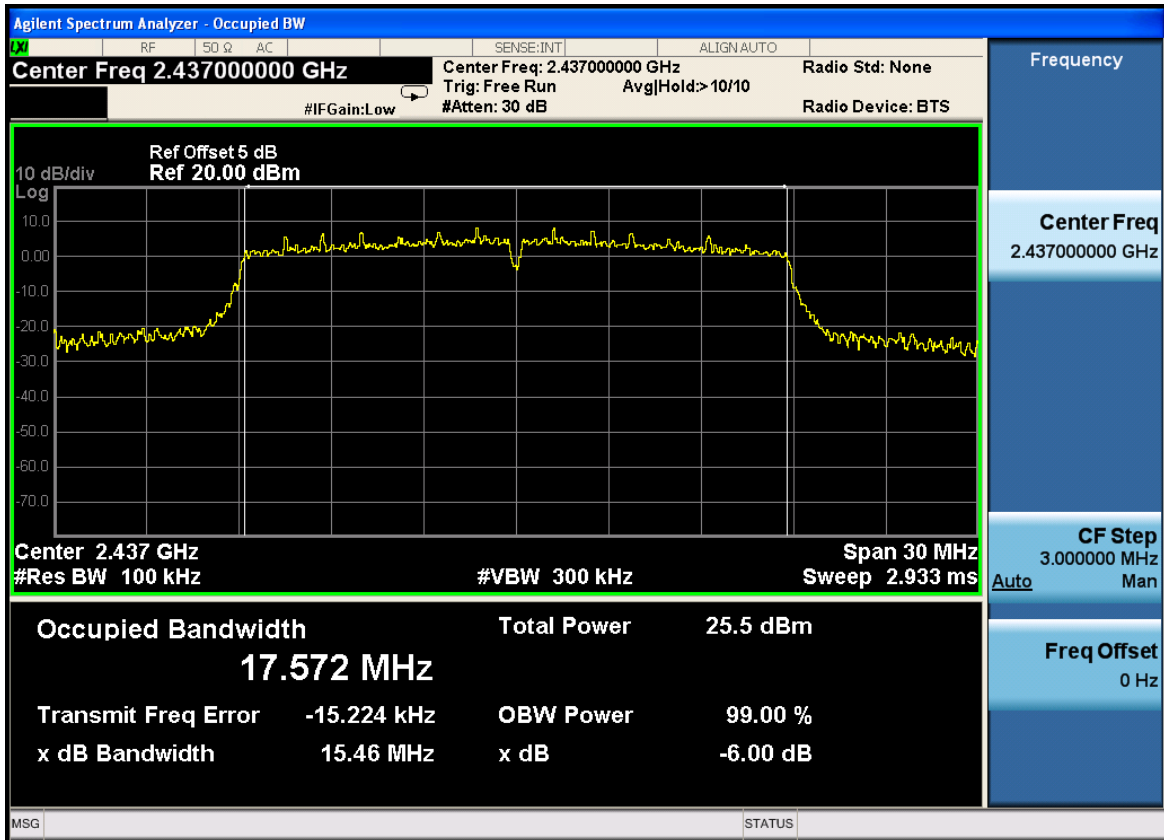

CH: 2462MHz

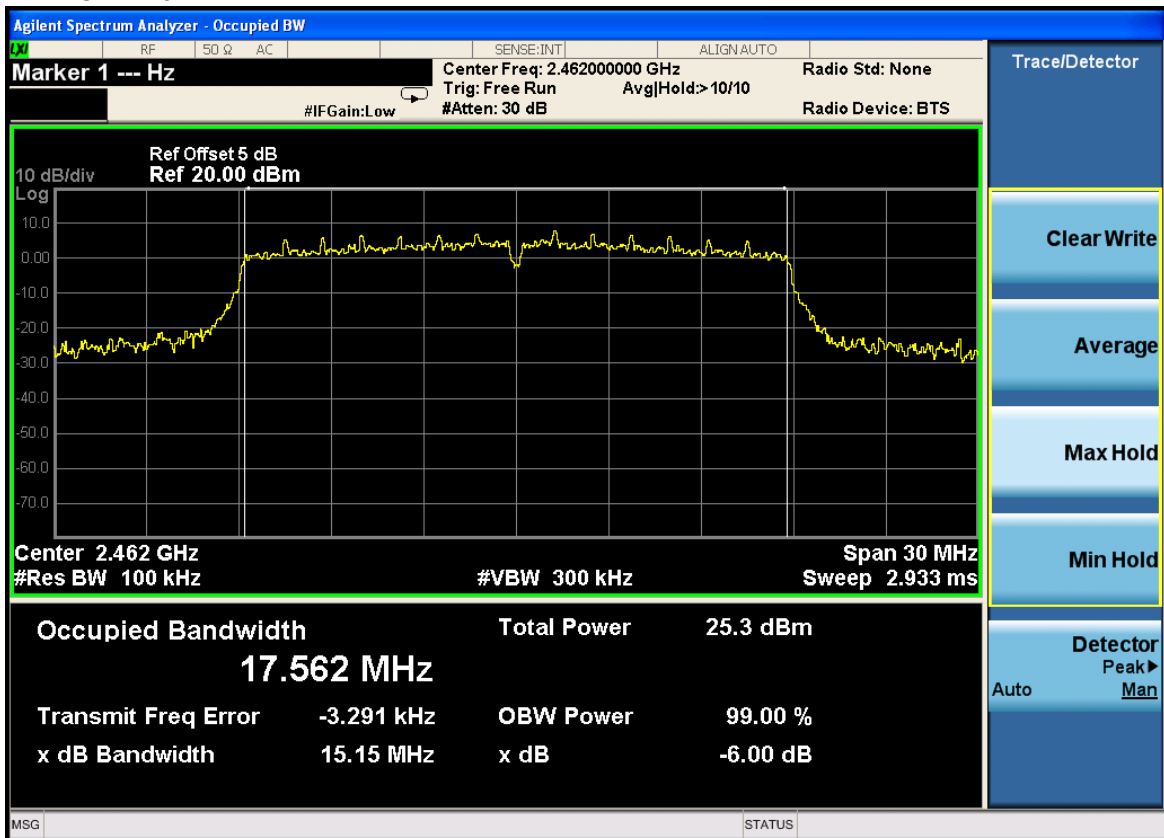

TX 802.11n/HT40 Mode			
Frequency	6dB Bandwidth (MHz)	Channel Separation (MHz)	Result
2422 MHz	35.16	>=500KHz	PASS
2437 MHz	35.10	>=500KHz	PASS
2452 MHz	35.13	>=500KHz	PASS

CH: 2422MHz

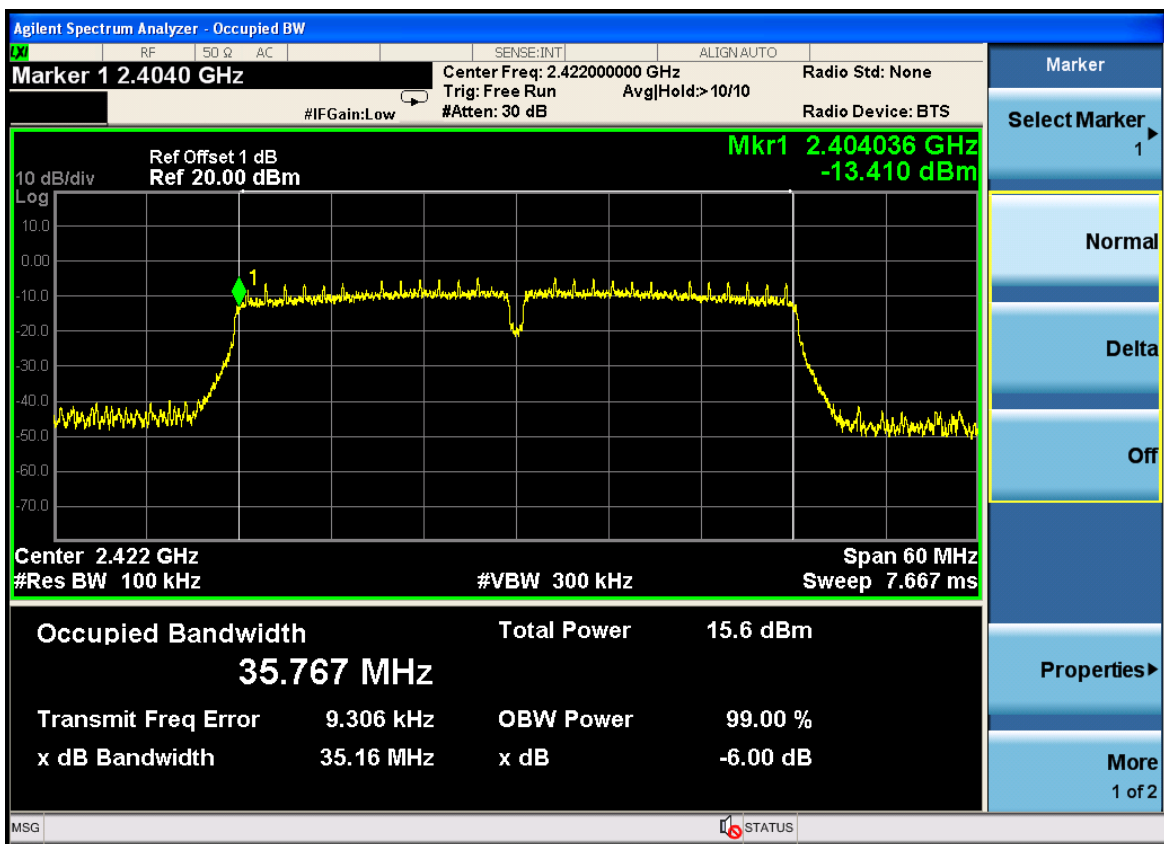

CH: 2437MHz

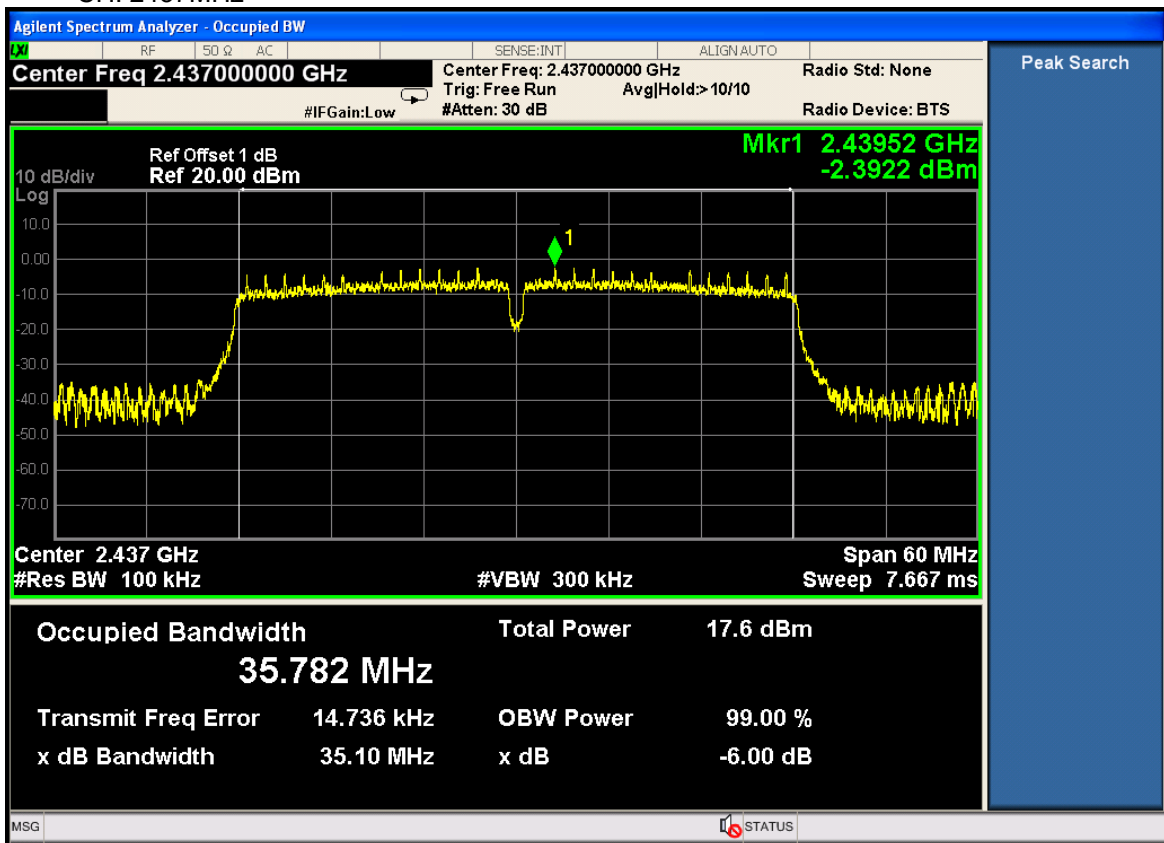

CH: 2452MHz

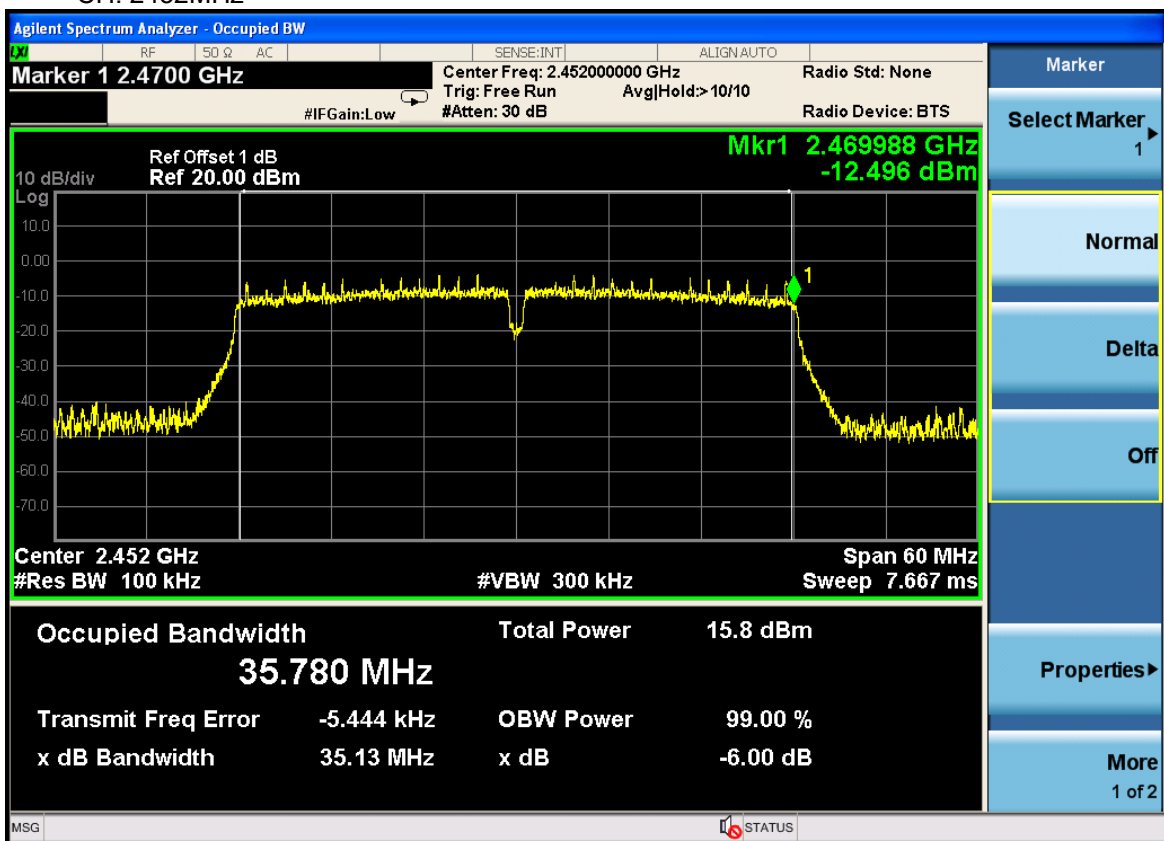

## 7 POWER SPECTRAL DENSITY TEST

### 7.1 Test Limit

FCC Part15 (15.247) , Subpart C				
Section	Test Item	Limit	Frequency Range (MHz)	Result
15.247	Power Spectral Density	8 dBm (in any 3KHz)	2400-2483.5	PASS

### 7.2 Test Procedure

1. The EUT was placed on a turn table which is 0.8m above ground plane.
2. Set EUT as normal operation.
3. Based on FCC Part15 C Section 15.247: RBW= 3KHz. VBW= 10 KHz, Span=3MHz.
4. The useful radiated emission from the EUT was detected by the spectrum analyser with peak detector.

### 7.3 Measurement Equipment Used

Same as Radiated Emission Measurement

### 7.4 Test Result

**PASS**

All the test modes completed for test.

TX 802.11b Mode			
Frequency	Power Density (dBm)	Limit (dBm)	Result
2412 MHz	-3.713	8	PASS
2437 MHz	-1.221	8	PASS
2462 MHz	-2.566	8	PASS

CH: 2412MHz



CH: 2437MHz



CH: 2462MHz



TX 802.11g Mode			
Frequency	Power Density (dBm)	Limit (dBm)	Result
2412 MHz	-7.872	8	PASS
2437 MHz	-6.686	8	PASS
2462 MHz	-2.455	8	PASS

CH: 2412MHz

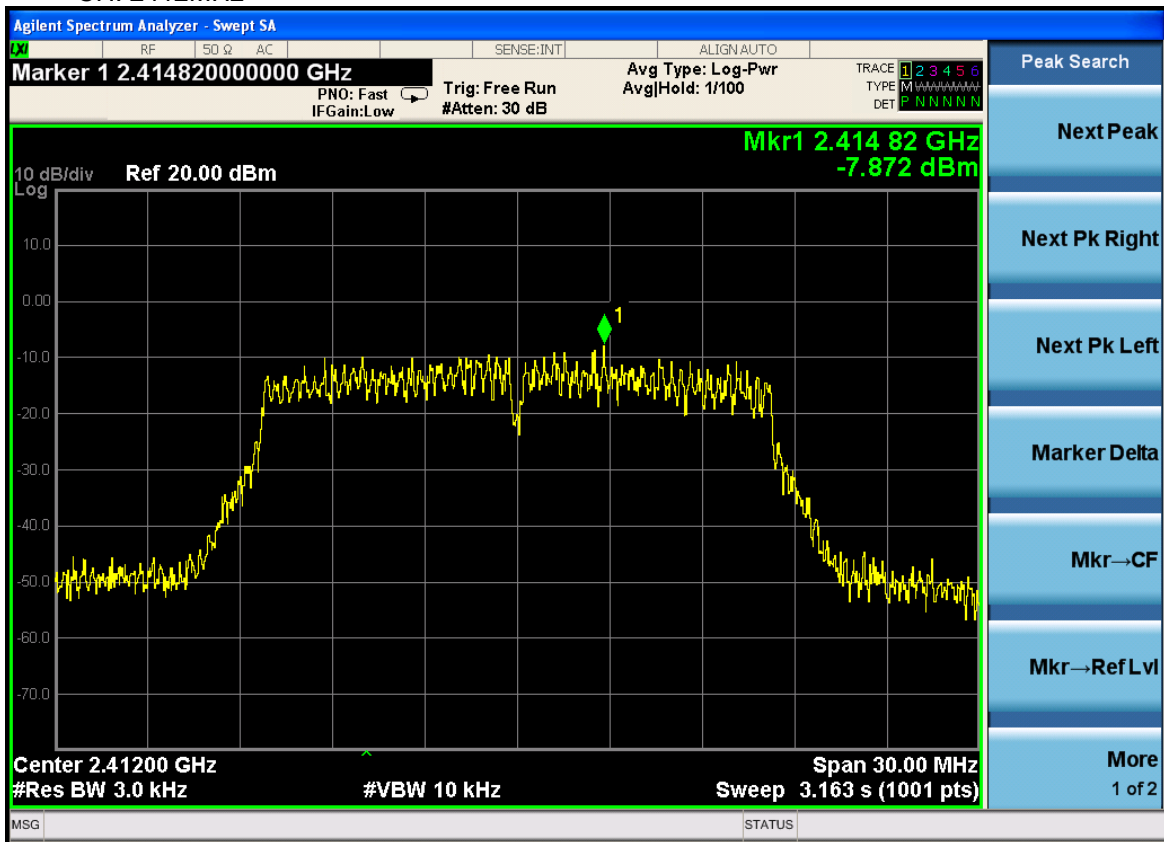



CH: 2437MHz

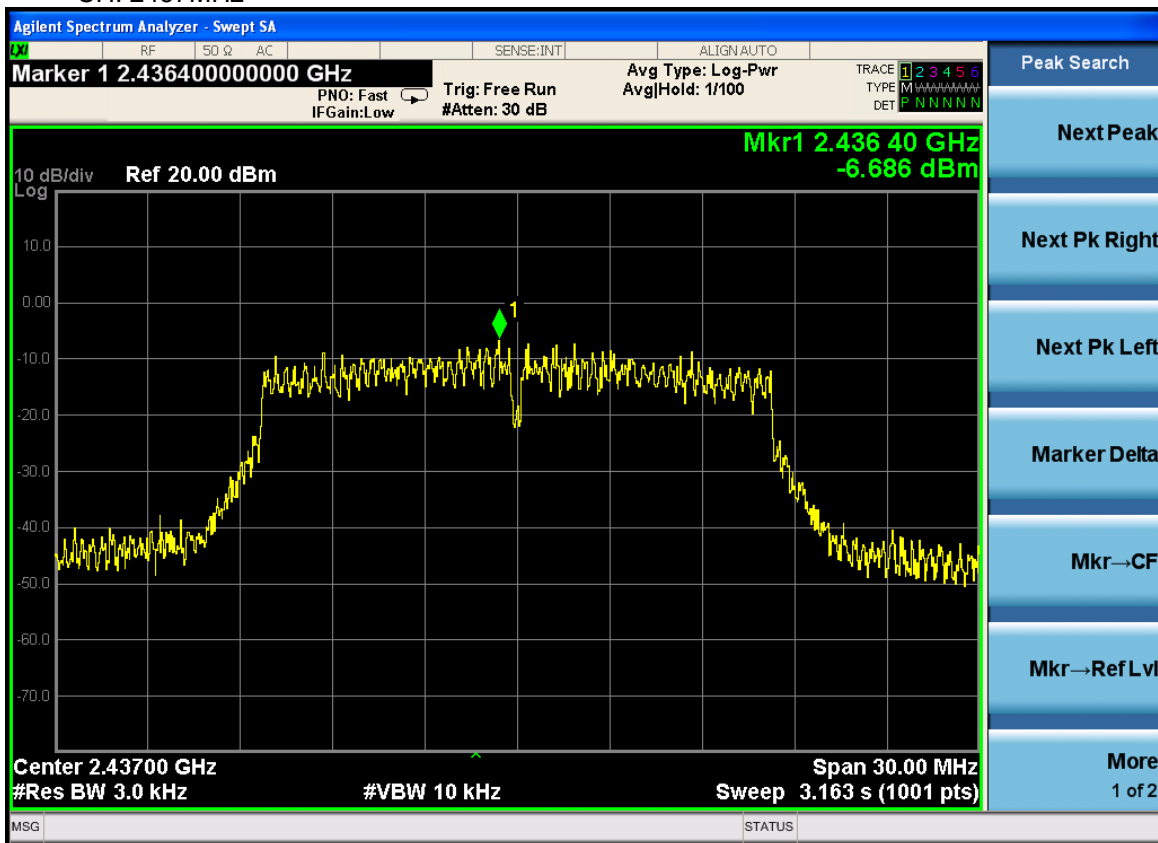

CH: 2462MHz



TX 802.11n/HT20 Mode			
Frequency	Power Density (dBm)	Limit (dBm)	Result
2412 MHz	-6.056	8	PASS
2437 MHz	-6.081	8	PASS
2462 MHz	-8.216	8	PASS

CH: 2412MHz

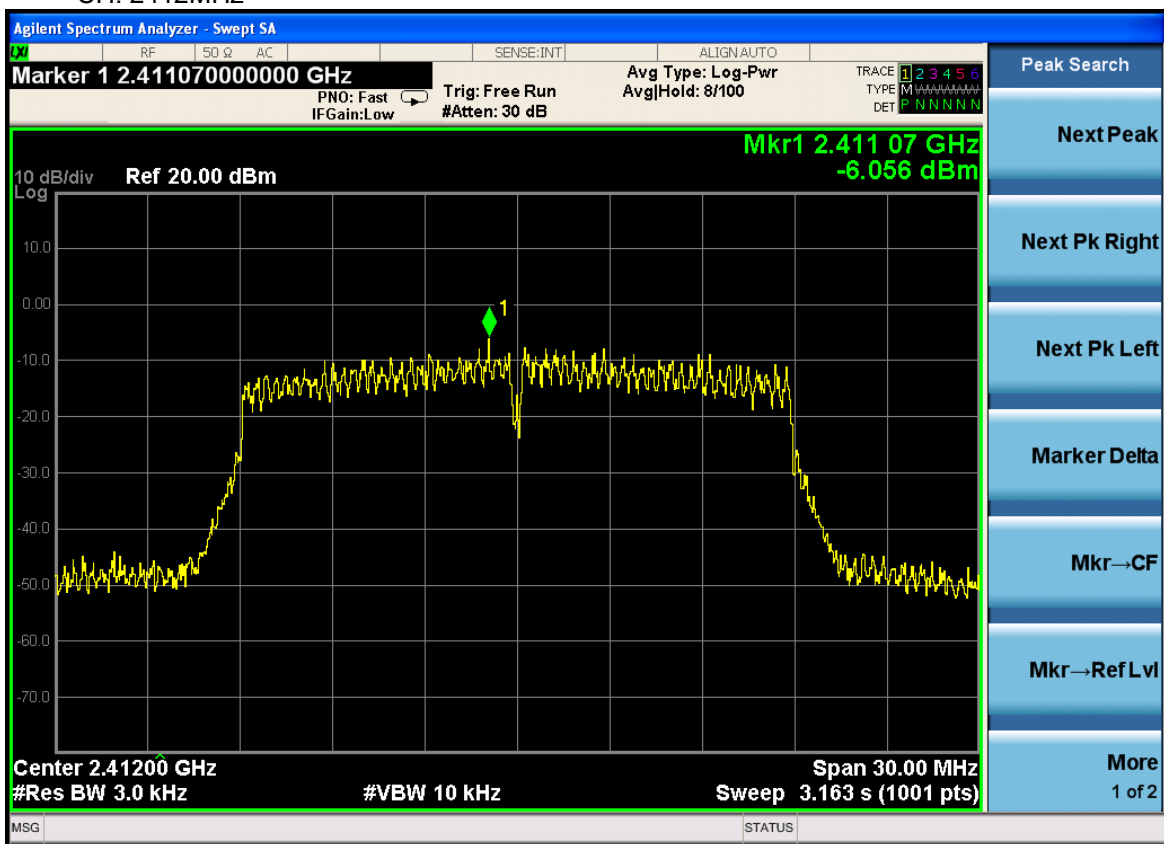

CH: 2437MHz

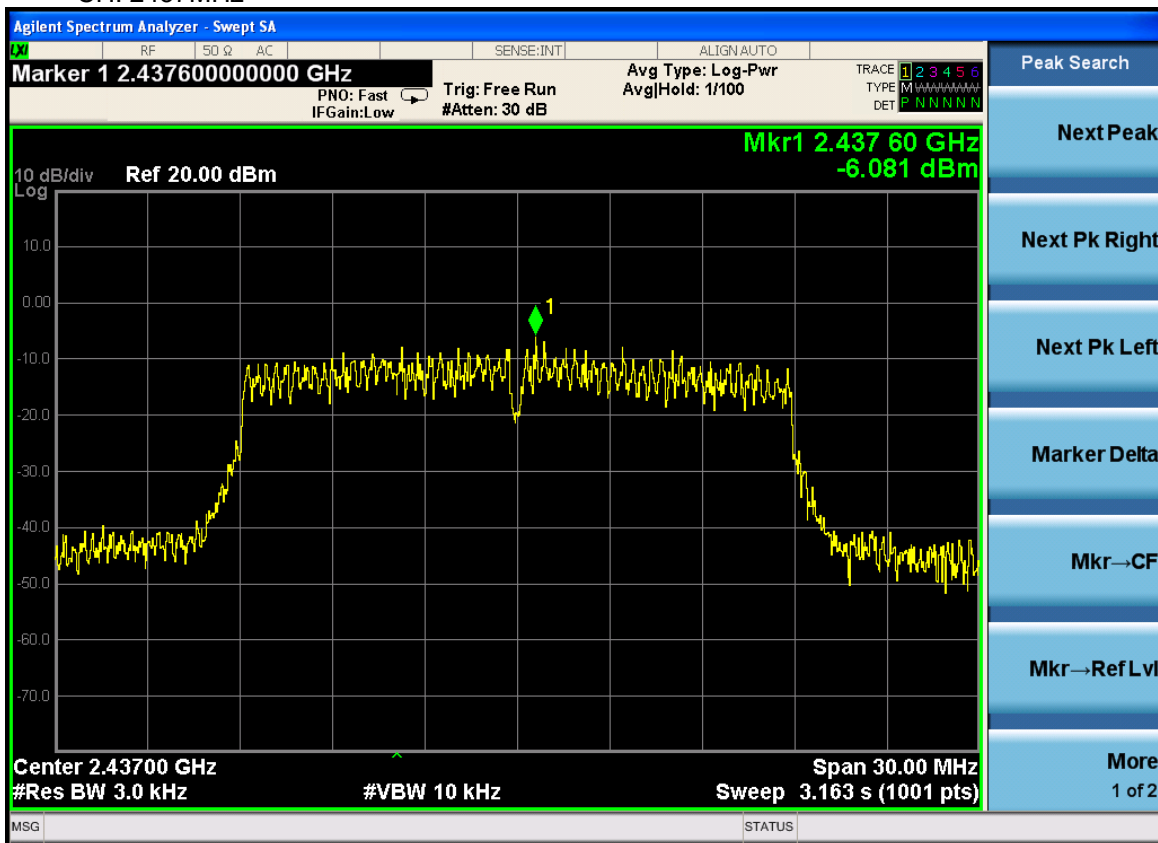

CH: 2462MHz

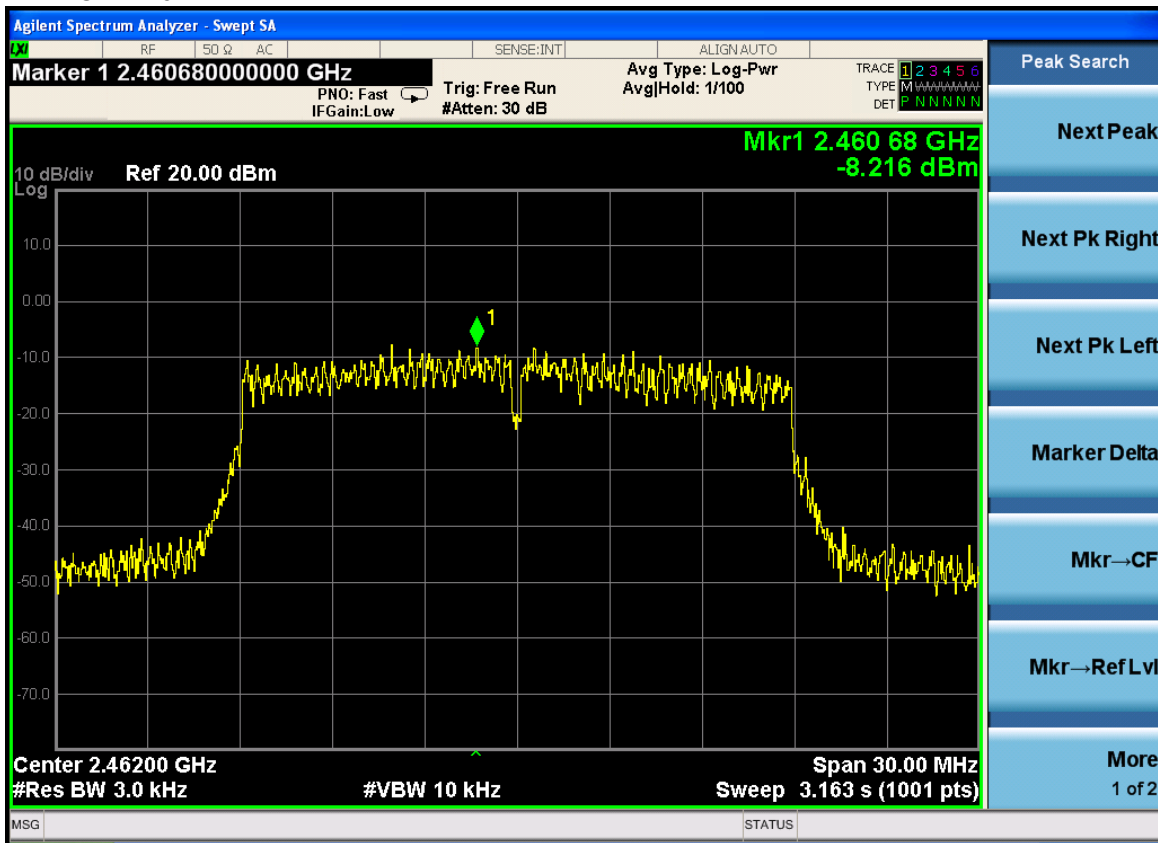

TX 802.11n/HT40 Mode			
Frequency	Power Density (dBm)	Limit (dBm)	Result
2422 MHz	-18.407	8	PASS
2437 MHz	-18.256	8	PASS
2452 MHz	-18.965	8	PASS

CH: 2422MHz

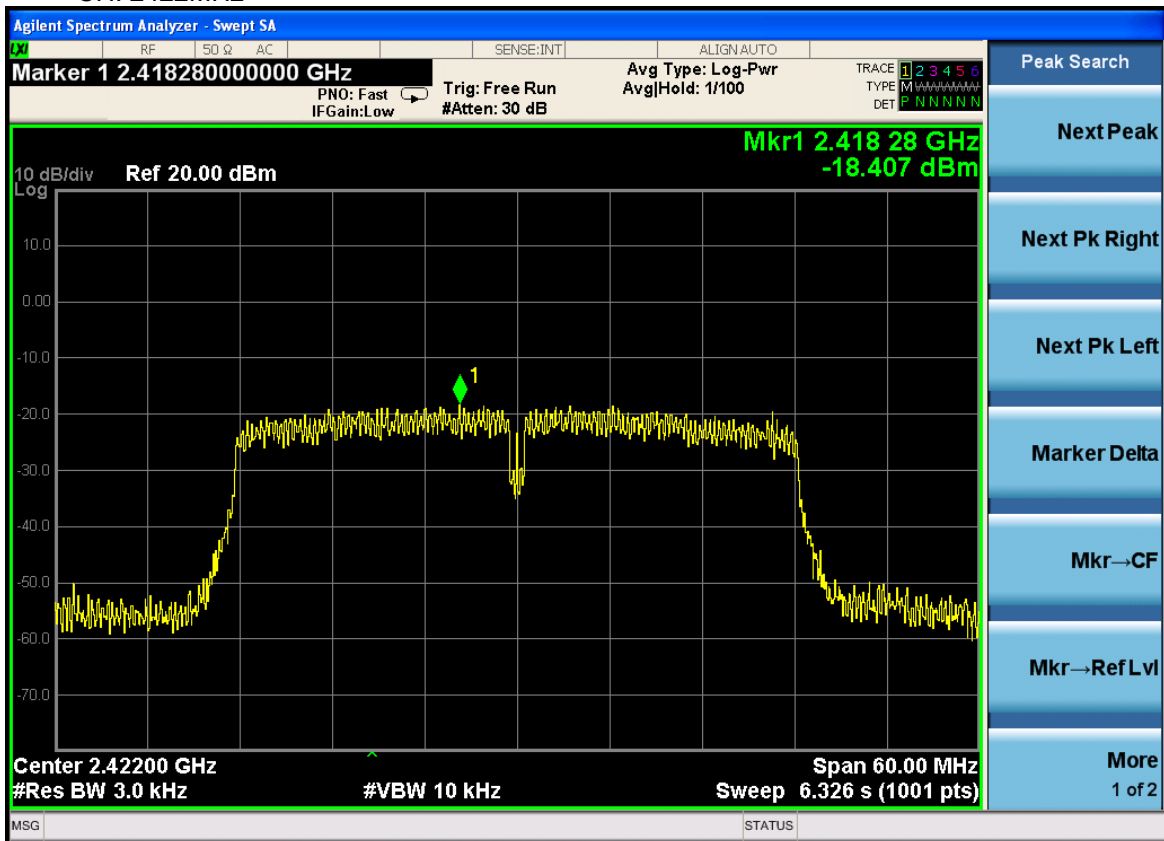

CH: 2437MHz

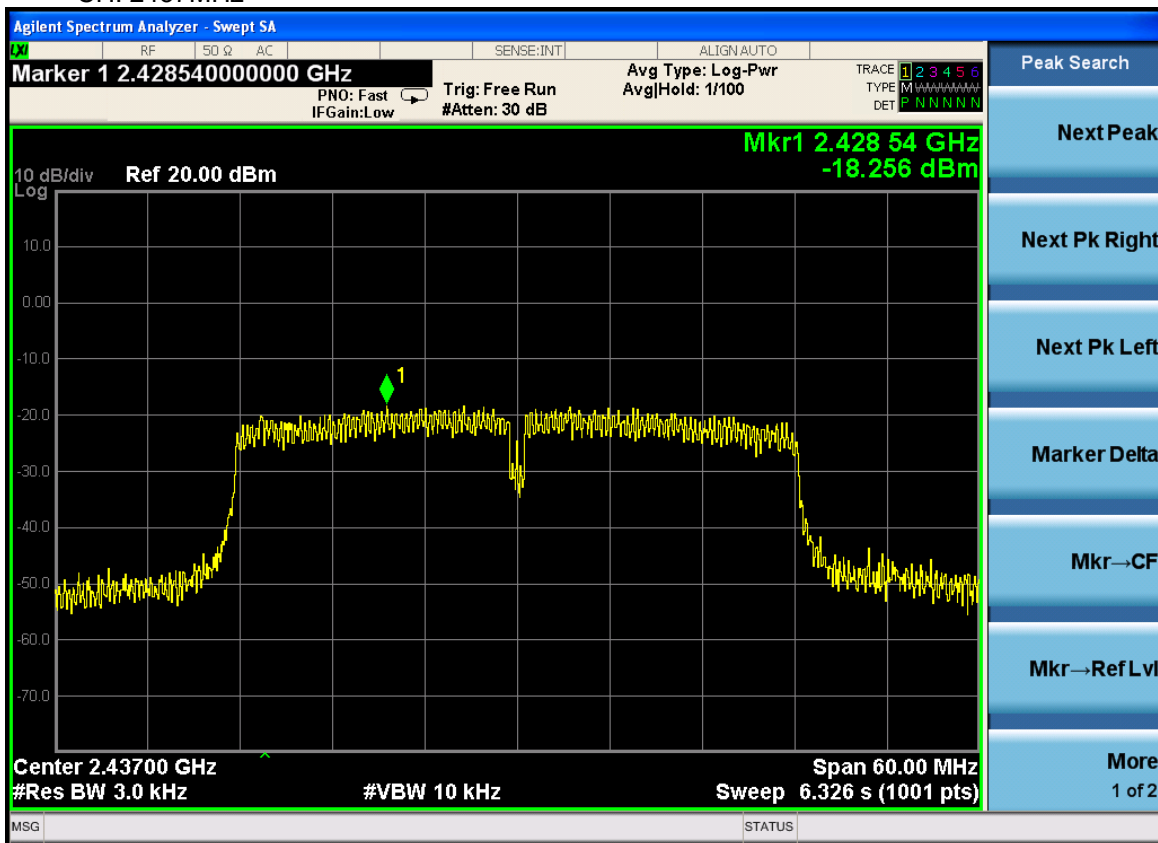

CH: 2452MHz

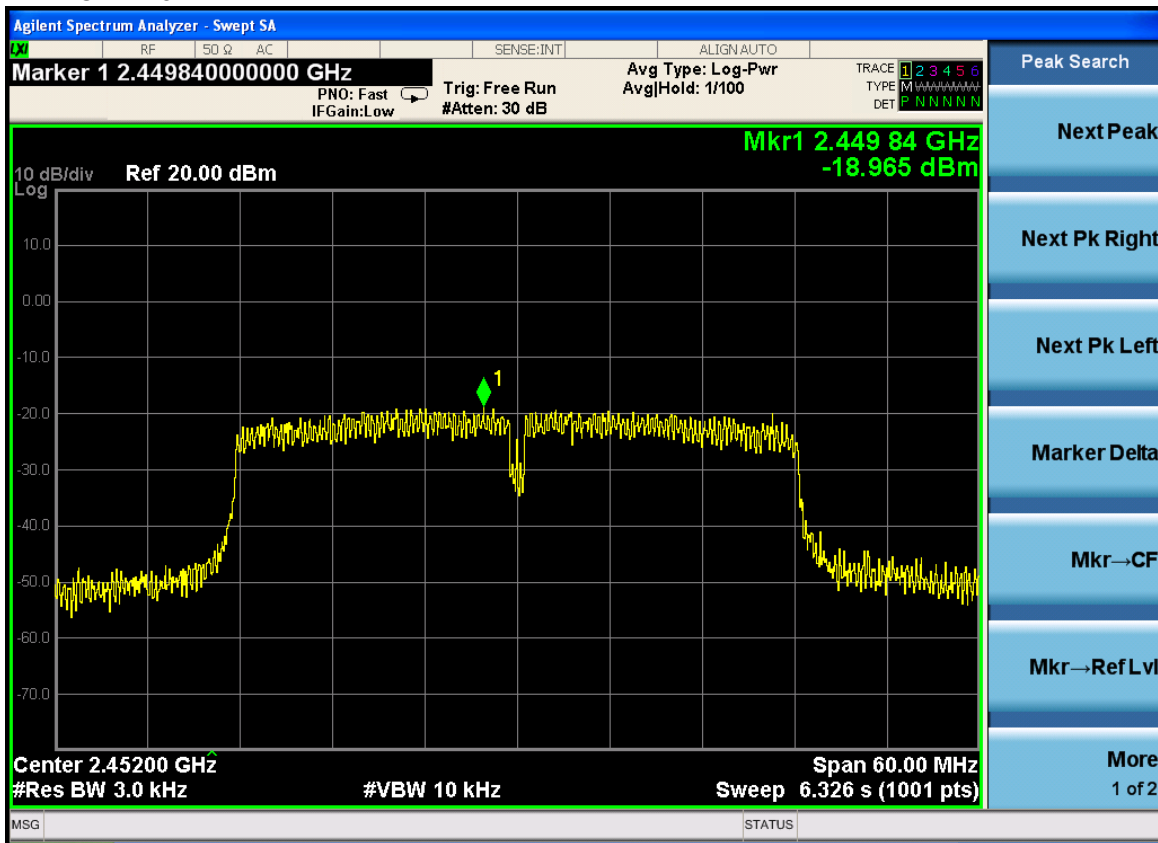

## 8 PEAK OUTPUT POWER TEST

### 8.1 Test Limit

FCC Part15 (15.247) , Subpart C				
Section	Test Item	Limit	Frequency Range (MHz)	Result
15.247(b)(3)	Peak Output Power	1 watt or 30dBm	2400-2483.5	PASS

### 8.2 Test Procedure

1. The EUT was placed on a turn table which is 0.8m above ground plane.
2. The EUT was directly connected to the Power meter.

### 8.3 Measurement Equipment Used

Same as Radiated Emission Measurement

### 8.4 Test Result

#### **PASS**

All the test modes completed for test.

TX 802.11b Mode			
Test	Frequency	Maximum Peak Conducted Output Power	LIMIT
Channe	(MHz)	(dBm)	dBm
CH01	2412	16.46	30
CH06	2437	16.32	30
CH11	2462	16.41	30
TX 802.11g Mode			
CH01	2412	15.93	30
CH06	2437	15.65	30
CH11	2462	15.81	30
TX 802.11n20 Mode			
CH01	2412	13.56	30
CH06	2437	13.31	30
CH11	2462	13.50	30
TX 802.11n40 Mode			
CH03	2422	12.88	30
CH06	2437	12.75	30
CH09	2452	12.62	30

## 9 OUT OF BAND EMISSIONS TEST

### 9.1 Test Limit

In any 100 kHz bandwidth outside the frequency band in which the spread spectrum or digitally modulated intentional radiator is operating, the radio frequency power that is produced by the intentional radiator shall be at least 20 dB below that in the 100 kHz bandwidth within the band that contains the highest level of the desired power, based on either an RF conducted or a radiated measurement, provided the transmitter demonstrates compliance with the peak conducted power limits. If the transmitter complies with the conducted power limits based on the use of RMS averaging over a time interval, as permitted under paragraph (b)(3) of this section, the attenuation required under this paragraph shall be 30 dB instead of 20 dB.

### 9.2 Test Procedure

1. The EUT was placed on a turn table which is 0.8m above ground plane.
2. Set EUT as TX operation and connect directly to the spectrum analyzer.
3. Set spectrum analyzer RBW= 100KHz. VBW= 100 KHz
4. Set detected by the spectrum analyser with peak detector.

### 9.3 Test Setup

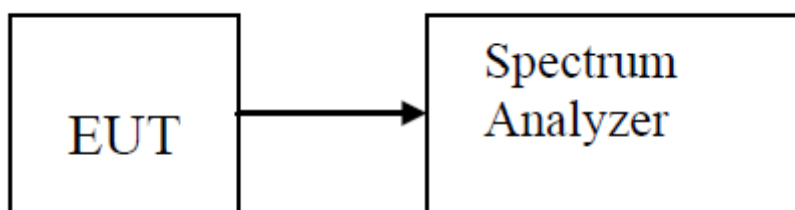

### 7.4 Test Result

**PASS**

All the test modes completed for test.

TX 802.11b Mode

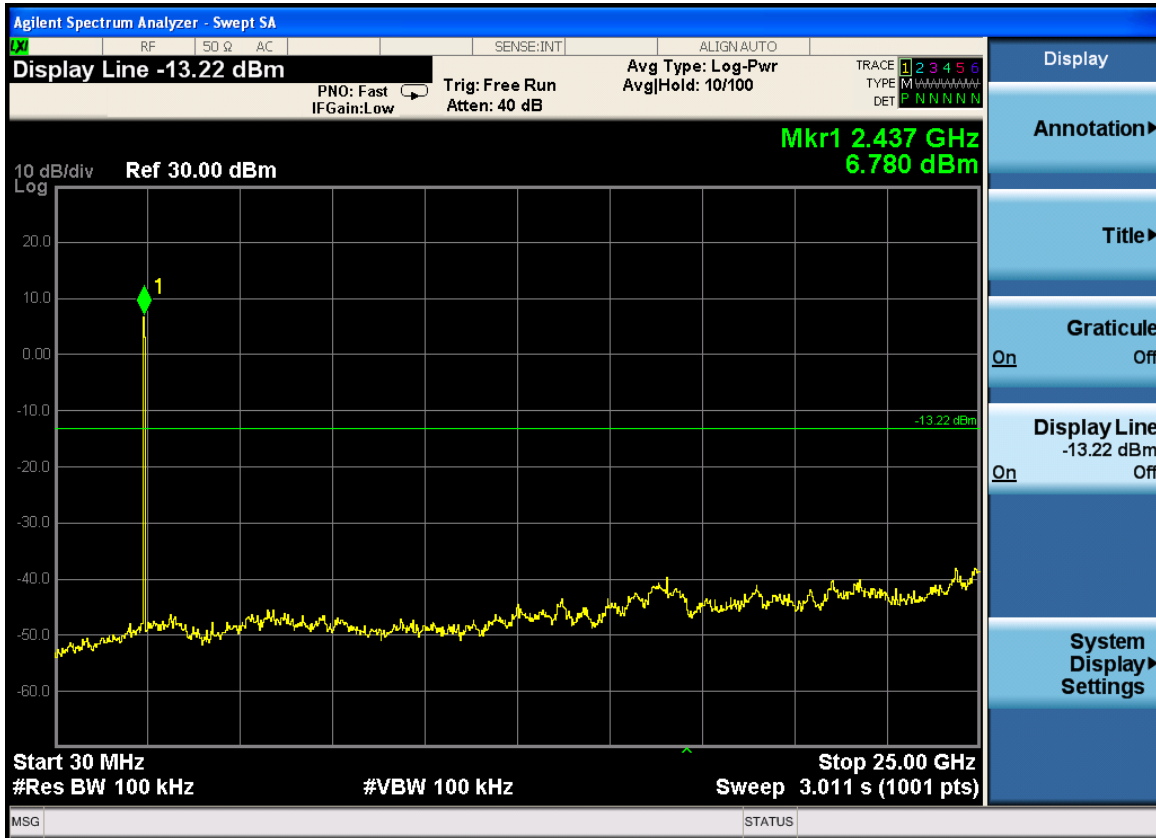
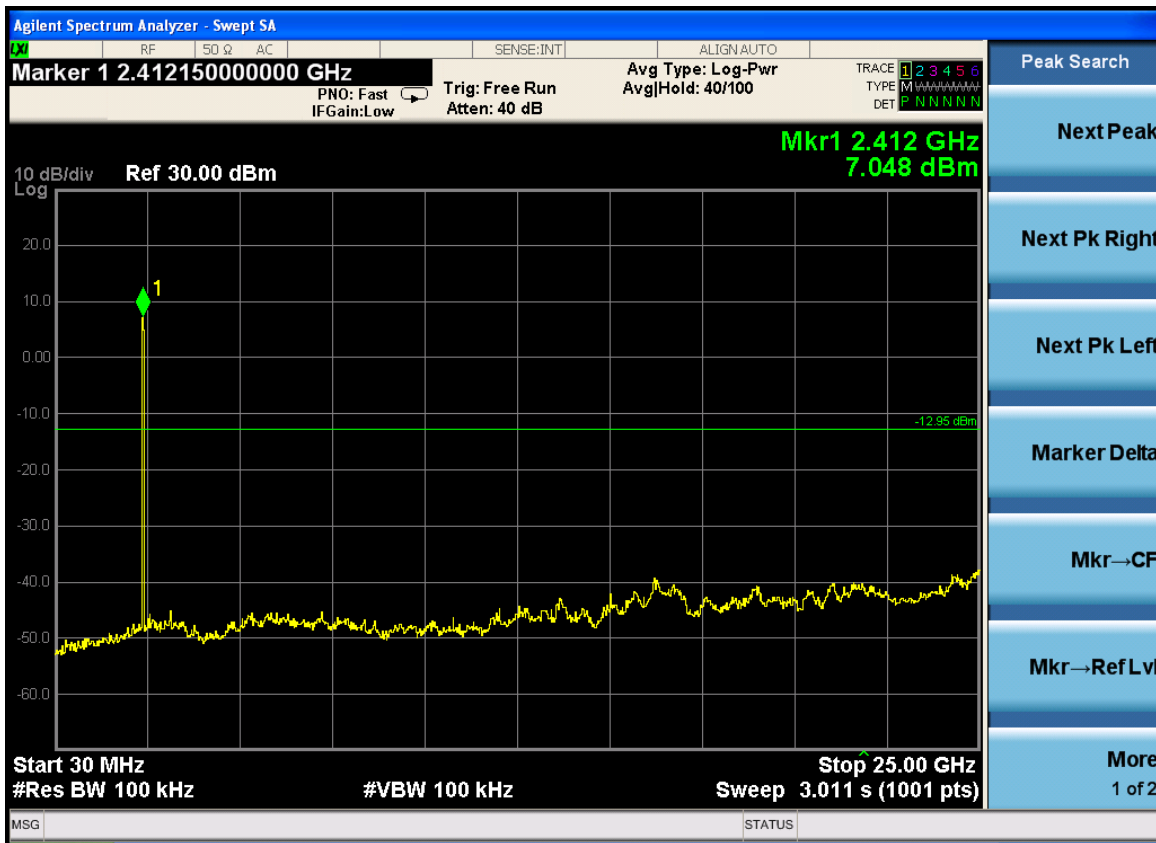



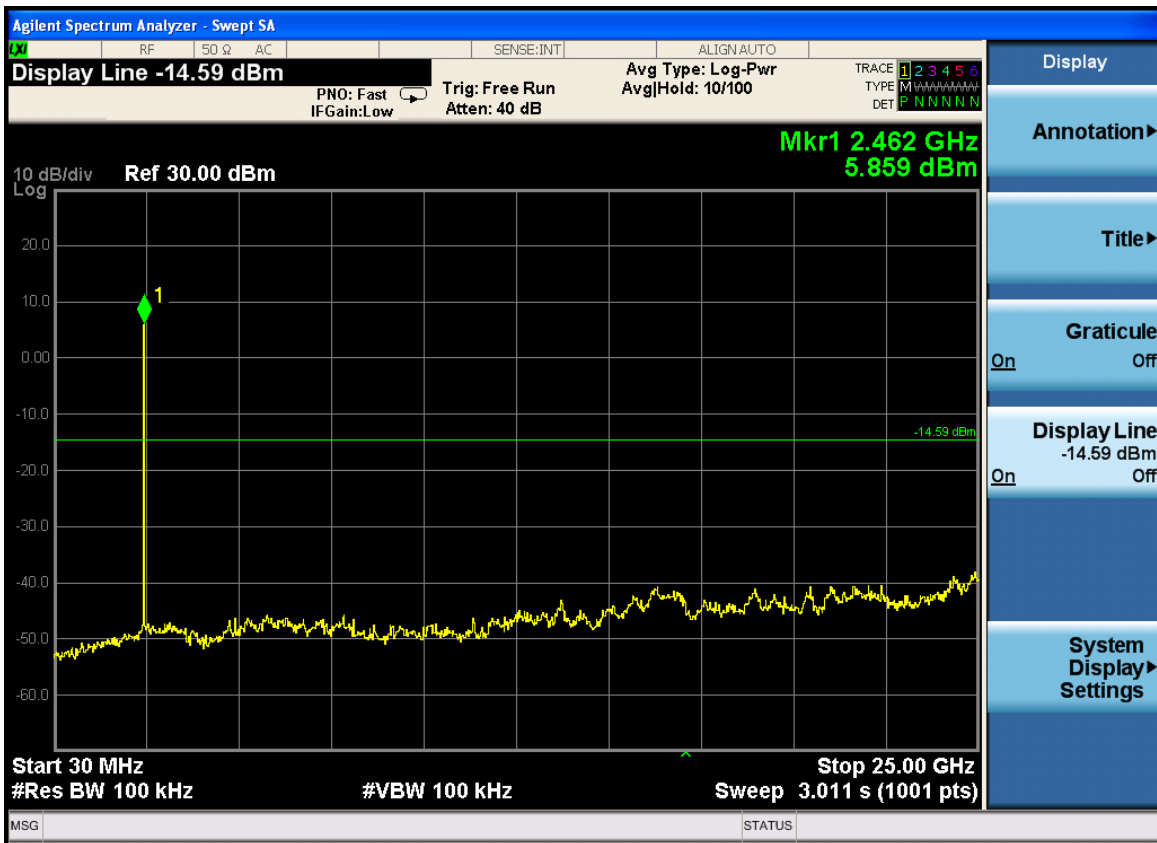

TX 802.11g Mode





TX 802.11n/HT20 Mode

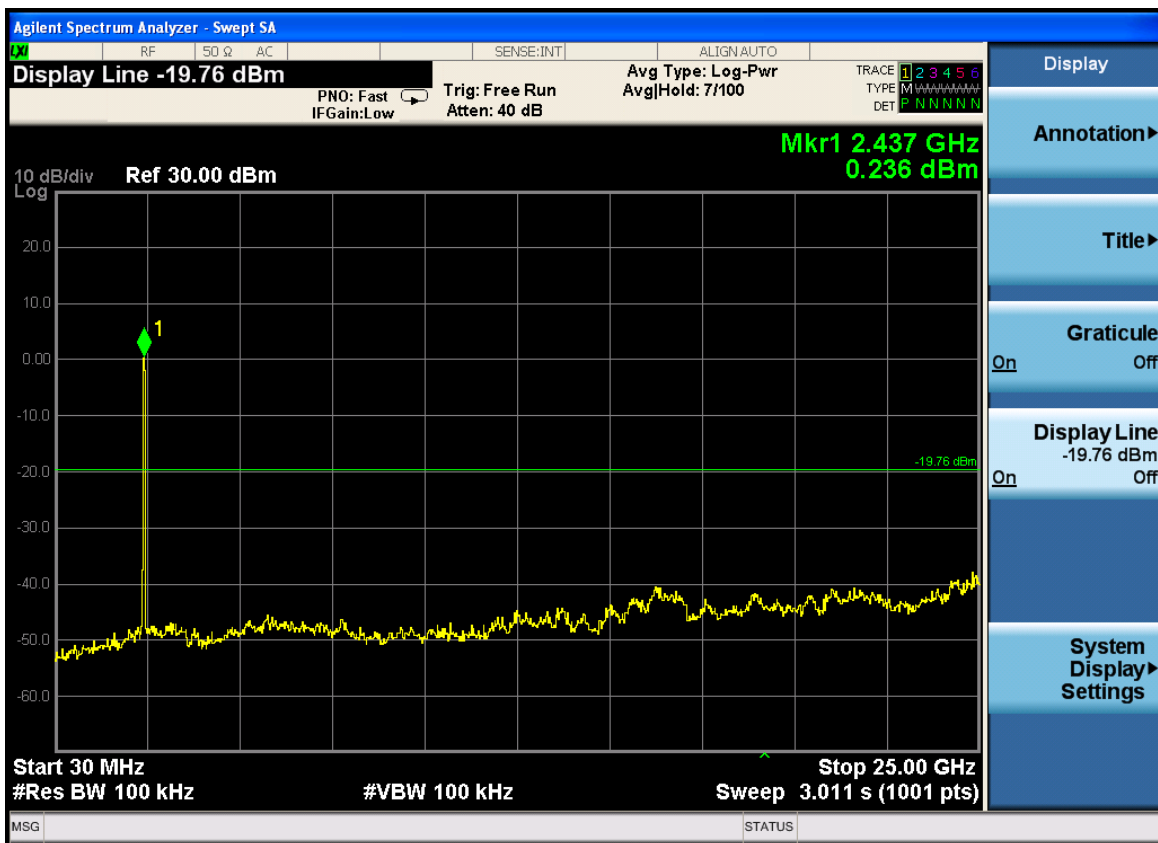
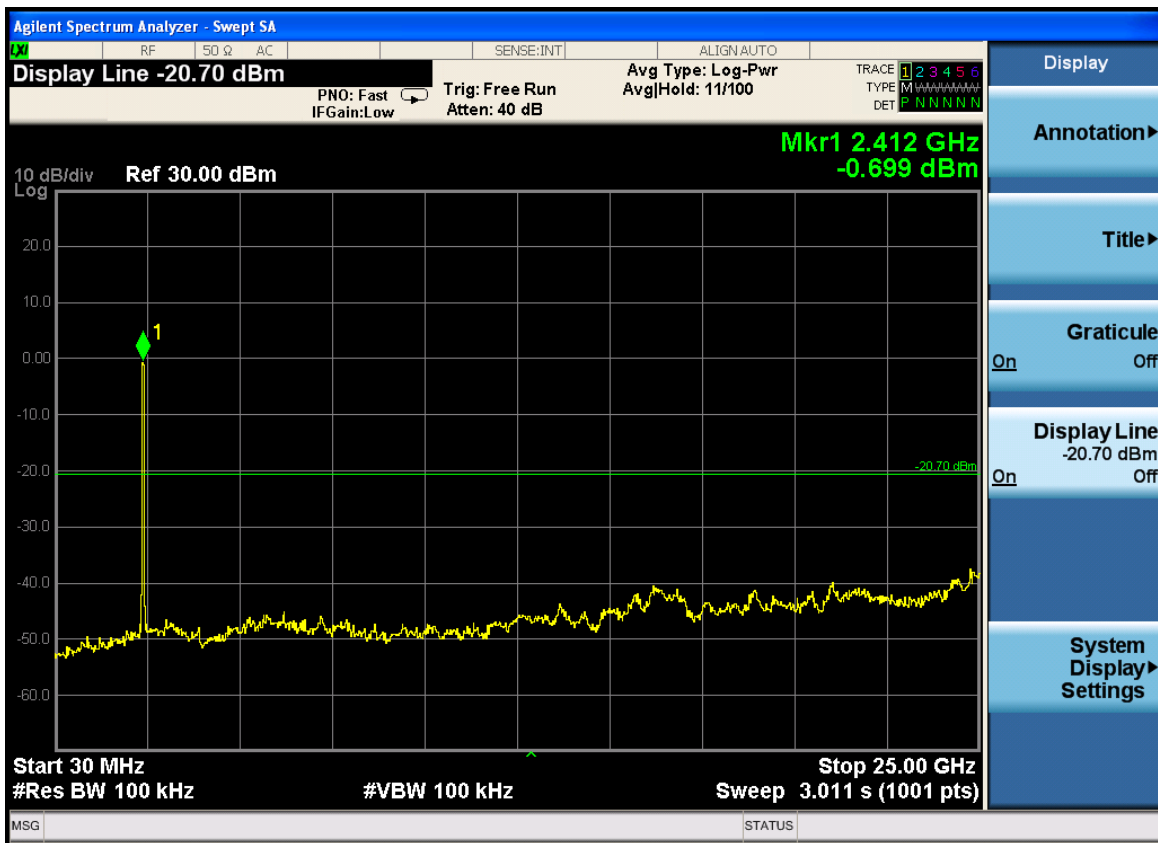

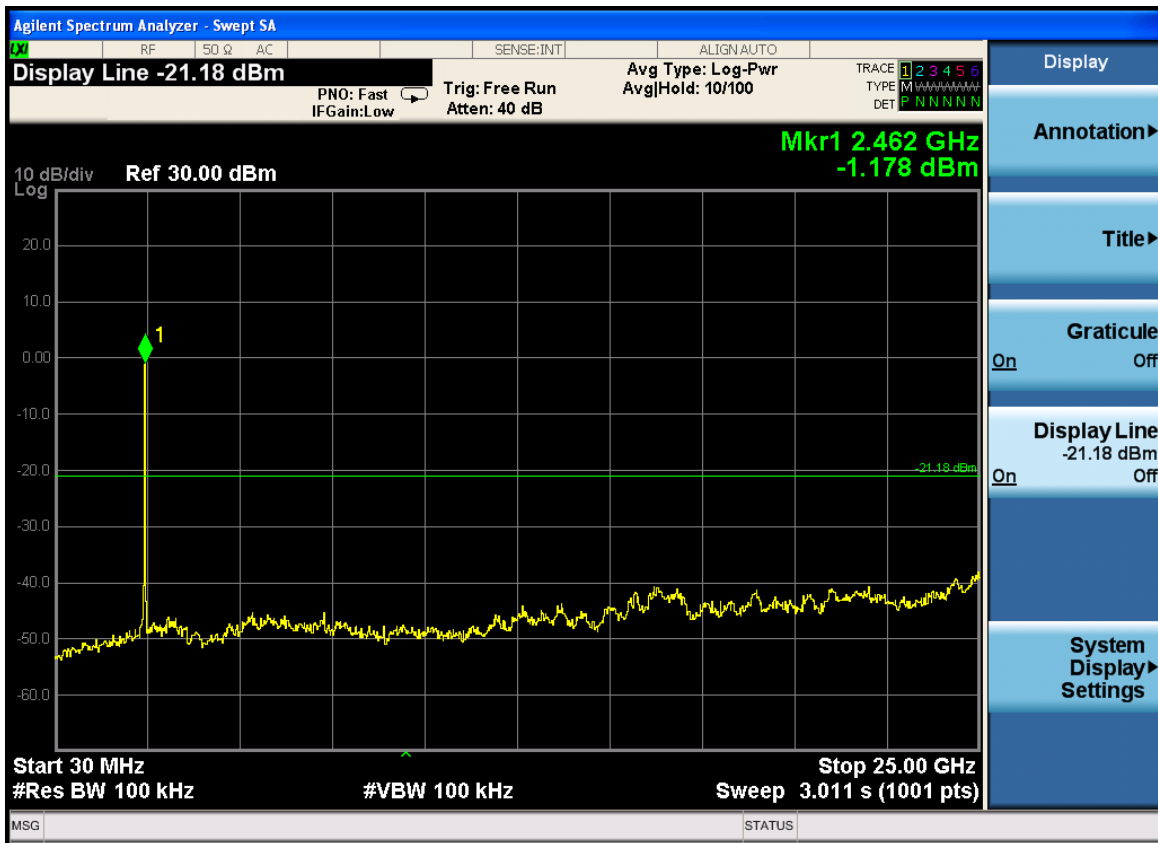

TX 802.11n/HT40 Mode

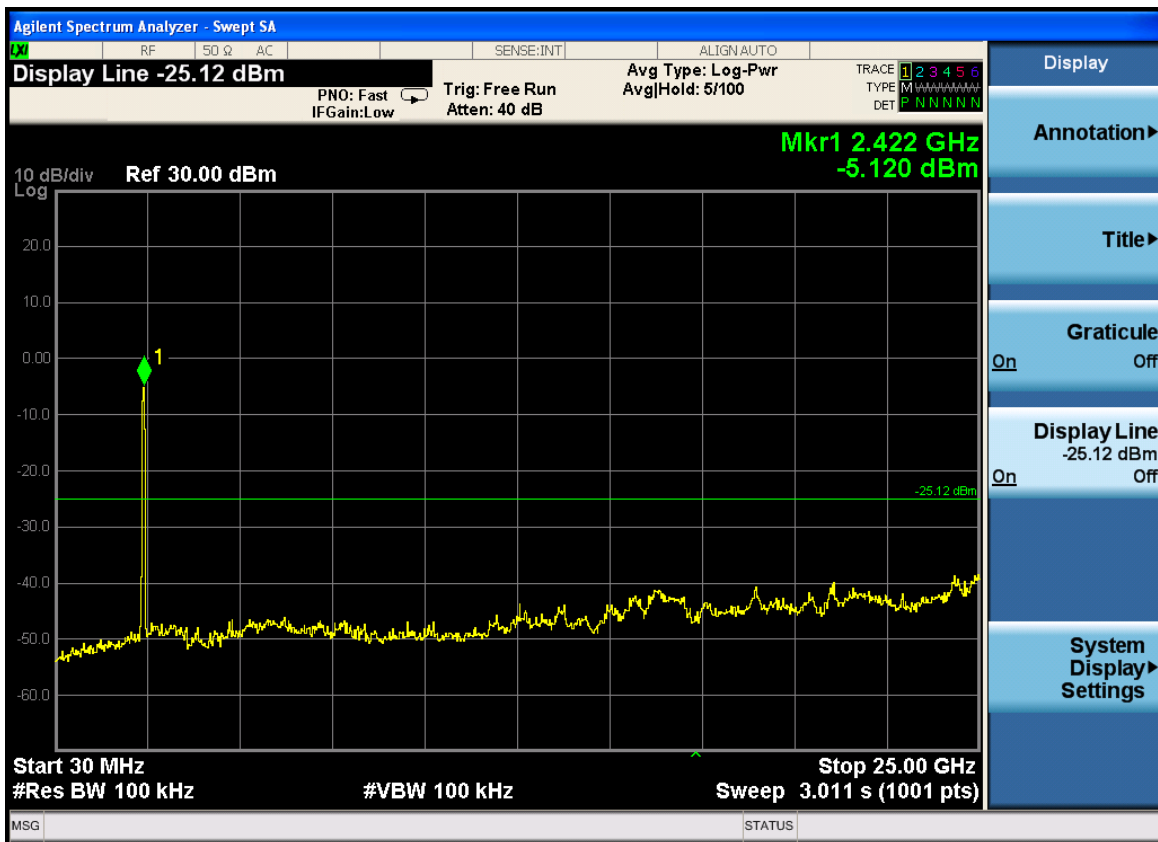

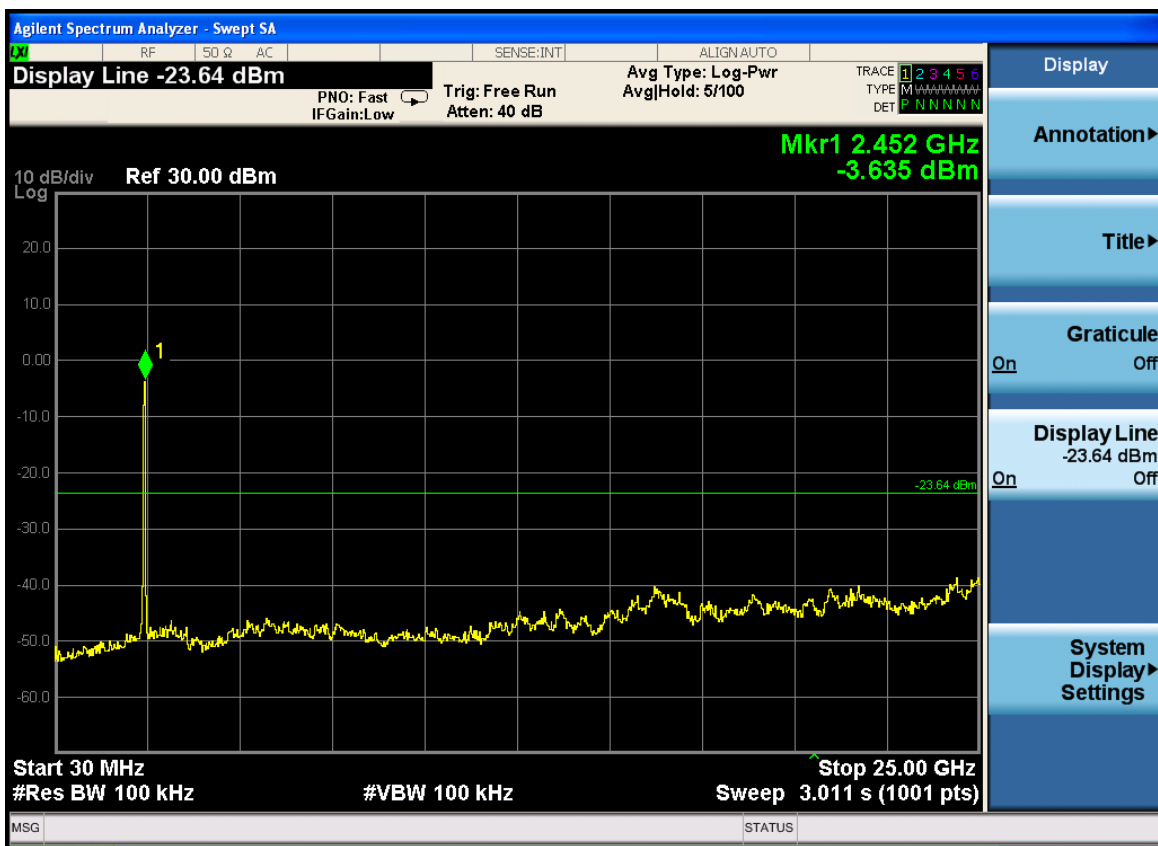
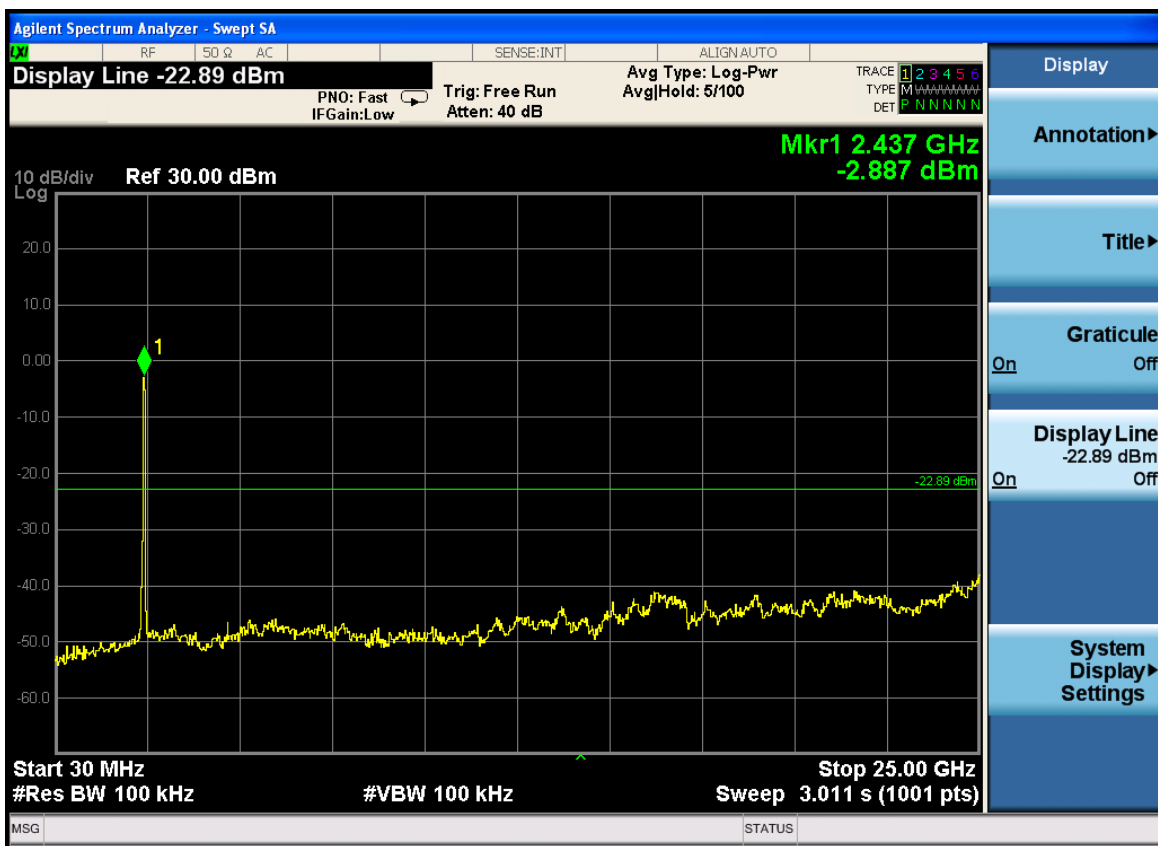

## 10 ANTENNA REQUIREMENT

### Standard Applicable

For intentional device, according to FCC 47 CFR Section 15.203, an intentional radiator shall be designed to ensure that no antenna other than that furnished by the responsible party shall be used with the device. And according to FCC 47 CFR Section 15.249, if transmitting antennas of directional gain greater than 6dBi are used, the power shall be reduced by the amount in dB that the directional gain of the antenna exceeds 6dBi.

### Refer to statement below for compliance.

The manufacturer may design the unit so that the user can replace a broken antenna, but the use of a standard antenna jack or electrical connector is prohibited. Further, this requirement does not apply to intentional radiators that must be professionally installed.

### Antenna Connected Construction

The antenna used in this product is a Internal antenna, The directional gains of antenna used for transmitting is 1dBi.

### WIFI ANTENNA



## 11 PHOTOGRAPH OF TEST

### 11.1 Radiated Emission

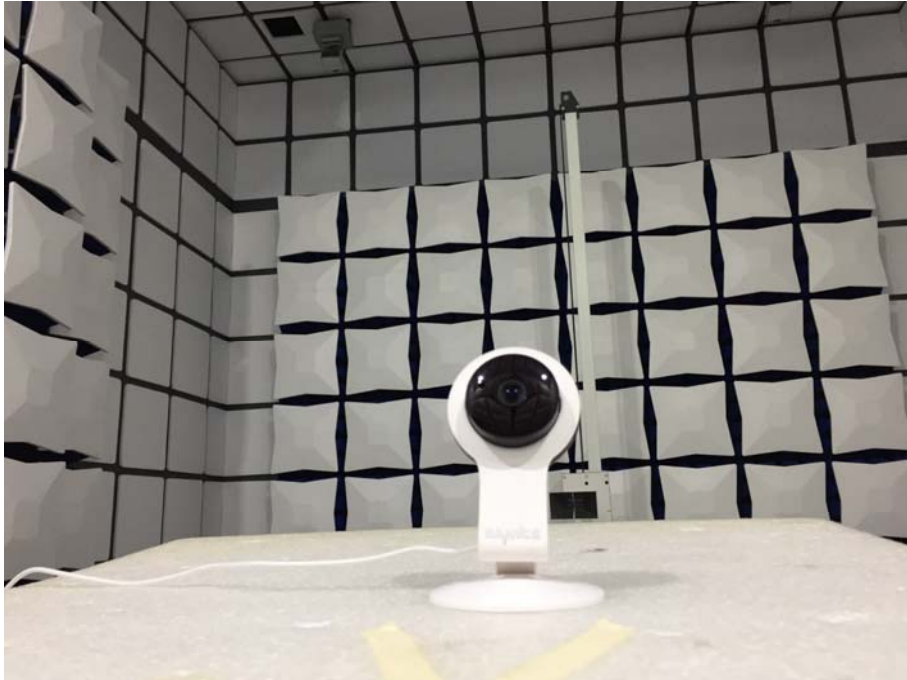
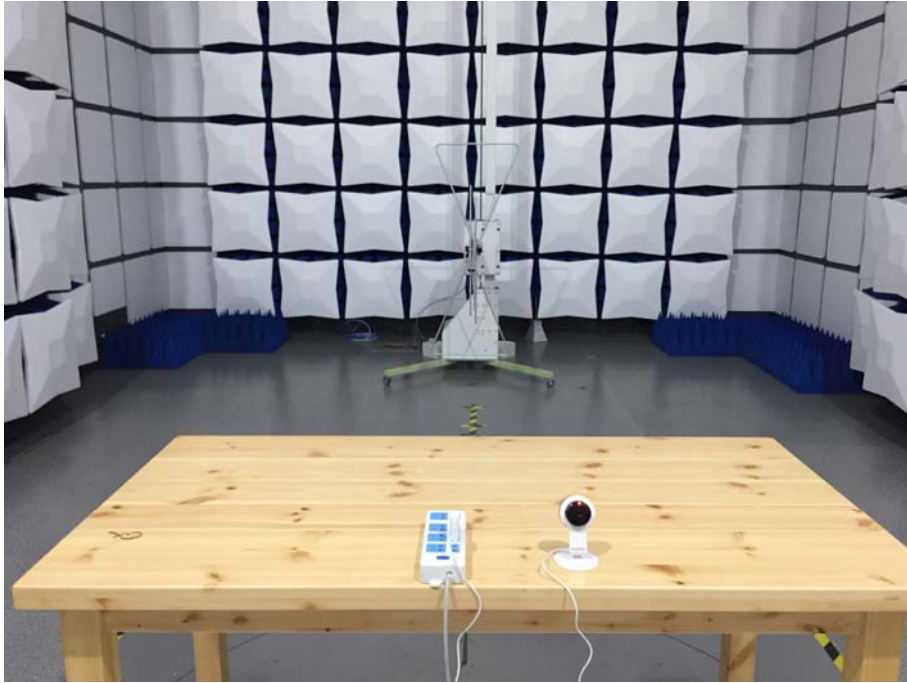

### 11.2 Conducted Emission

