



Report No.: EA2008600F04001

1 of 68

**ELECTROMAGNETIC EMISSIONS COMPLIANCE REPORT
INTENTIONAL RADIATOR CERTIFICATION TO
FCC PART 15 SUBPART C REQUIREMENT**

OF

LED string light

Model No.: ZYLED-WR01-A

(A represents the number of lamp holders, the value is 6-24)

FCC ID: 2AKKN-LED-WR01-A

Trademark: N/A

Report No.: EA2008600F04001

Issue Date: October 21, 2020

Prepared for

HAINING ZHONGYUAN PLASTIC CO.,LTD

**No.7 Wanlong Road, Economic development Zone, Haining City, Jiaxing
City, Zhejiang Province, China**

Prepared by

Dong Guan Anci Electronic Technology Co., Ltd.

**1-2 Floor, Building A, No.11, Headquarters 2 Road, Songshan, Lake
Hi-tech Industrial Development Zone, Dongguan City, Guangdong Pr.,
China.**

**This report shall not be reproduced, except in full, without the written approval of
Dong Guan Anci Eleaectronic Technology Co., Ltd.**



VERIFICATION OF COMPLIANCE

Applicant:	HAINING ZHONGYUAN PLASTIC CO.,LTD. No.7 Wanlong Road, Economic development Zone, Haining City, Jiaxing City, Zhejiang Province, China .
Manufacturer:	HAINING ZHONGYUAN PLASTIC CO.,LTD No.7 Wanlong Road, Economic development Zone, Haining City, Jiaxing City, Zhejiang Province, China
Product Description:	LED string light
Model Number:	ZYLED-WR01-A (A represents the number of lamp holders, the value is 6-24) (Note:All models are the same except the number of lamp holders. We choose model: ZYLED-WR01-24 as the main test.)

We hereby certify that:

The above equipment was tested by Dong Guan Anci Electronic Technology Co., Ltd. The test data, data evaluation, test procedures, and equipment configurations shown in this report were made in accordance with the procedures given in ANSI C63.10-2013 and the energy emitted by the sample EUT tested as described in this report is in compliance with conducted and radiated emission limits of FCC Rules Part 15.247(2020).

Date of Test : August 23, 2020 to October 15, 2020

Prepared by : Tomas Yang/Supervisor

Reviewer & Authorized Signer : Alan He/Manager



Modified Information

Version	Summary	Revision Date	Report No.
Ver.1.0	Original Report	/	EA2008600F04001



Table of Contents

- 1. GENERAL INFORMATION 6**
 - 1.1 PRODUCT DESCRIPTION 6
 - 1.2 TEST METHODOLOGY 6
- 2. SYSTEM TEST CONFIGURATION..... 7**
 - 2.1 EUT CONFIGURATION..... 7
 - 2.2 EUT EXERCISE 7
 - 2.3 TEST PROCEDURE 7
 - 2.4 CONFIGURATION OF TESTED SYSTEM..... 7
- 3. DESCRIPTION OF TEST MODES 9**
- 4. SUMMARY OF TEST RESULTS 12**
- 5. TEST FACILITY 13**
- 6. CONDUCTED EMISSIONS TEST 14**
 - 6.1 MEASUREMENT PROCEDURE: 14
 - 6.2 TEST SET-UP (BLOCK DIAGRAM OF CONFIGURATION) 14
 - 6.3 MEASUREMENT EQUIPMENT USED: 14
 - 6.4 CONDUCTED EMISSION LIMIT 14
 - 6.5 MEASUREMENT RESULT:..... 15
 - 6.5 CONDUCTED MEASUREMENT PHOTOS:..... 17
- 7. RADIATED EMISSION TEST..... 18**
 - 7.1 MEASUREMENT PROCEDURE 18
 - 7.2 TEST SET-UP (BLOCK DIAGRAM OF CONFIGURATION)..... 19
 - 7.3 MEASUREMENT EQUIPMENT USED..... 20
 - 7.4 RADIATED EMISSION LIMIT..... 21
 - 7.5 MEASUREMENT RESULT 22
 - 7.6 RADIATED MEASUREMENT PHOTOS: 27
- 8. 6DB BANDWIDTH TEST..... 28**
 - 8.1 MEASUREMENT PROCEDURE 28
 - 8.2 TEST SET-UP (BLOCK DIAGRAM OF CONFIGURATION)..... 28
 - 8.3 MEASUREMENT EQUIPMENT USED..... 28
 - 8.4 MEASUREMENT RESULTS 28
- 9. MAXIMUM PEAK OUTPUT POWER TEST 37**
 - 9.1 MEASUREMENT PROCEDURE 37
 - 9.2 TEST SET-UP (BLOCK DIAGRAM OF CONFIGURATION)..... 37
 - 9.3 MEASUREMENT EQUIPMENT USED..... 37
 - 9.4 PEAK POWER OUTPUT LIMIT 37
 - 9.5 MEASUREMENT RESULTS 37
- 10. BAND EDGE TEST 38**
 - 10.1 MEASUREMENT PROCEDURE 38
 - 10.2 TEST SET-UP (BLOCK DIAGRAM OF CONFIGURATION) 39
 - 10.3 MEASUREMENT EQUIPMENT USED 39
 - 10.4 MEASUREMENT RESULTS 39
- 11. POWER DENSITY 45**
 - 11.1 TEST EQUIPMENT..... 45
 - 11.2 MEASURING INSTRUMENTS AND SETTING 45
 - 11.3 TEST PROCEDURES 45



Report No.: EA2008600F04001

5 of 68

11.4 BLOCK DIAGRAM OF TEST SETUP	45
11.5 LIMIT	46
11.6 TEST RESULT	46
12. ANTENNA PORT EMISSION.....	54
12.1 TEST EQUIPMENT	54
12.2 MEASURING INSTRUMENTS AND SETTING.....	54
12.3 TEST PROCEDURES.....	54
12.4 BLOCK DIAGRAM OF TEST SETUP.....	54
12.5 TEST RESULT	54
13. ANTENNA APPLICATION.....	61
13.1 ANTENNA REQUIREMENT	61
13.2 RESULT	61

APPENDIX (PHOTOS OF EUT) (3 PAGES)

1. General Information

1.1 Product Description

Characteristics	Description
Product Name	LED string light
Model number	ZYLED-WR01-24
Power Supply	AC 100-130V, 50/60HZ 0.28A
Test Power Supply	AC 120V/60Hz
Modulation	802.11b: DSSS(DBPSK/DQPSK/CCK) 802.11g/n: OFDM(BPSK/QPSK/16QAM/64QAM)
Operating Frequency Range	2412-2462MHz for 802.11b/g; 2412-2462MHz for 802.11n(HT20); 2422-2452MHz for 802.11n(HT40);
Number of Channels	11 channels for 802.11b/g; 11 channels for 802.11n(HT20); 7 channels for 802.11n(HT40);
Transmit Power Max	802.11b: 10.24dBm 802.11g: 10.21dBm 802.11n(HT20): 9.28dBm 802.11n(HT40): 8.52dBm
Antenna Type	PCB antenna
Antenna Gain	-1dBi

Note: for more details, please refer to the User's manual of the EUT.

1.2 Test Methodology

All the test program has follow FCC new test procedure KDB 558074 D01 15.247 Meas Guidance v05r02 and in accordance with the procedures given in ANSI C63.10-2013.

2. System Test Configuration

2.1 EUT Configuration

The EUT configuration for testing is installed on RF field strength measurement to meet the Commissions requirement and operating in a manner which intends to maximize its emission characteristics in a continuous normal application.

2.2 EUT Exercise

The Transmitter was operated in the normal operating mode. The TX frequency was fixed which was for the purpose of the measurements.

2.3 Test Procedure

2.3.1 Conducted Emissions

The EUT is a placed on as turn table which is 0.8 m above ground plane. According to the requirements in Section 13.1.4.1 of ANSI C63.10-2013 Conducted emissions from the EUT measured in the frequency range between 0.15 MHz and 30 MHz using CISPR Quasi-Peak and average detector mode.

2.3.2 Radiated Emissions

The EUT is a placed on as turn table which is 0.8 m above ground plane. The turn table shall rotate 360 degrees to determine the position of maximum emission level. EUT is set 3m away from the receiving antenna which varied from 1m to 4m to find out the highest emission. And also, each emission was to be maximized by changing the polarization of receiving antenna both horizontal and vertical. In order to find out the max. Emission, the relative positions of this hand-held transmitter (EUT) was rotated through three orthogonal axes according to the requirements in Section 13.1.4.1 of ANSI C63.10-2013.

2.4 Configuration of Tested System

Fig. 2-1 Configuration of Tested System

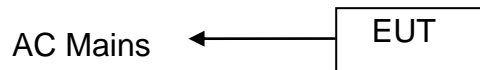



Table 2-1 Equipment Used in Tested System

Item	Equipment	Trademark	Model No.	FCC ID	Note
1.	LED string light	N.A	ZYLED-WR01-24	2AKKN-LED-W R01-A	EUT

Note:

- (1) Unless otherwise denoted as EUT in 『Remark』 column, device(s) used in tested system is a support equipment.

3. Description of Test Modes

The EUT has been tested under its typical operating condition and Only the worst case data were reported. The EUT configuration for testing is installed on RF field strength measurement to meet the Commissions requirement and operating in a manner which intends to maximize its emission characteristics in a continuous normal application.

The Transmitter was operated in the normal operating mode. The TX frequency was fixed which was for the purpose of the measurements.

Test of channel included the lowest and middle and highest frequency to perform the test, then record on this report.

Those data rates (802.11b: 1 Mbps; 802.11g: 6 Mbps; 802.11n (HT20): MCS0; 802.11n (HT40): MCS0) were used for all test.

Pre-defined engineering program for regulatory testing used to control the EUT for staying in continuous transmitting mode is programmed. EUT is connected by com port, and transmit the control instruction via test software(QATool_Dbg.exe).

Frequency and Channel list for 802.11 b/g/n (HT20):

Channel	Frequency (MHz)	Channel	Frequency (MHz)	Channel	Frequency (MHz)
1	2412	5	2432	9	2452
2	2417	6	2437	10	2457
3	2422	7	2442	11	2462
4	2427	8	2447		

Frequency and Channel list for 802.11 n (HT40):

Channel	Frequency (MHz)	Channel	Frequency (MHz)	Channel	Frequency (MHz)
3	2422	5	2432	8	2447
4	2427	6	2437	9	2452
		7	2442		

Test Frequency and Channel for 802.11 b/g/n (HT20):

Lowest Frequency		Middle Frequency		Highest Frequency	
Channel	Frequency (MHz)	Channel	Frequency (MHz)	Channel	Frequency (MHz)
1	2412	6	2437	11	2462

Test Frequency and channel for 802.11 n (HT40):

Lowest Frequency		Middle Frequency		Highest Frequency	
Channel	Frequency (MHz)	Channel	Frequency (MHz)	Channel	Frequency (MHz)
3	2422	6	2437	9	2452

Report No.: EA2008600F04001
 Operated Mode for Worst Duty cycle:
 Duty Cycle:

Mode	Frequency (MHz)	Duty Cycle (%)	Correction Factor (dB)
802.11b	2412	100	0
802.11b	2437	100	0
802.11b	2462	100	0
802.11g	2412	100	0
802.11g	2437	100	0
802.11g	2462	100	0
802.11n(HT20)	2412	100	0
802.11n(HT20)	2437	100	0
802.11n(HT20)	2462	100 </td <td>0</td>	0
802.11n(HT40)	2422	100	0
802.11n(HT40)	2437	100	0
802.11n(HT40)	2452	100	0

All the modulation modes were tested the data of the worst mode (TX 802.11n HT40) are recorded in the following pages:

Duty Cycle NVNT 802.11b 2412MHz

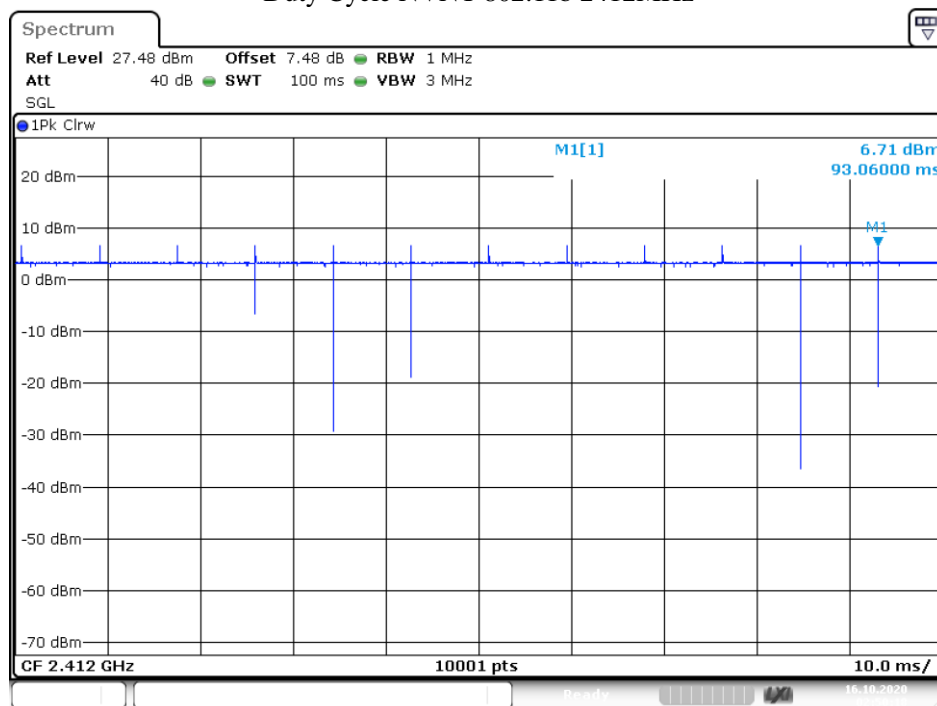



Report No.: EA2008600F04001

11 of 68
Duty Cycle NVNT 802.11b 2437MHz

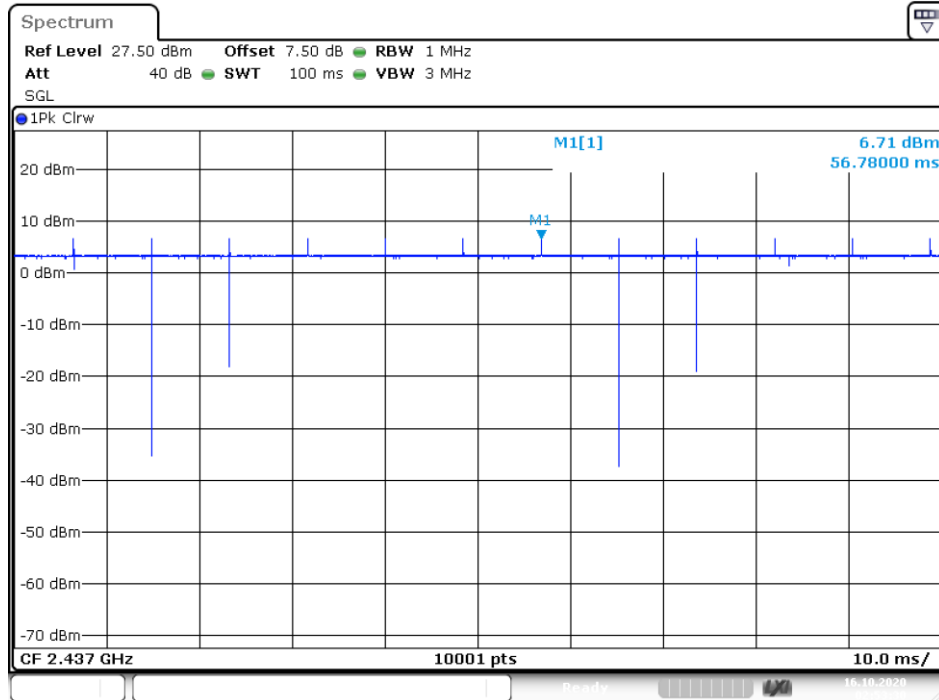

Date: 16.OCT.2020 02:53:31

Duty Cycle NVNT 802.11b 2462MHz

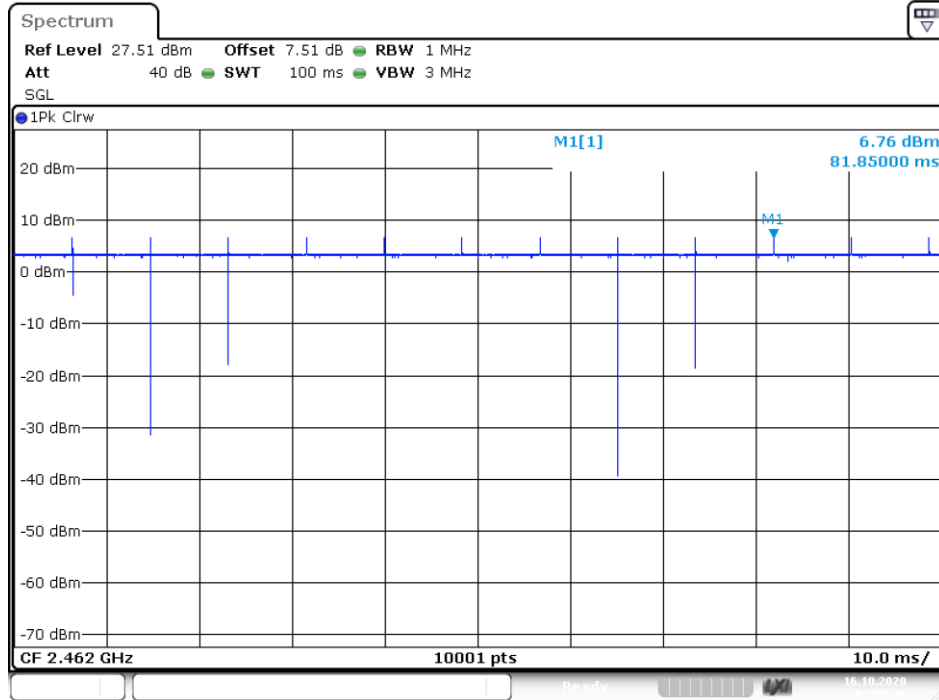

Date: 16.OCT.2020 02:55:18



4. Summary of Test Results

FCC Rules	Description Of Test	Result
§15.247(a)(2)	6dB bandwidth	Pass
§15.247(b)(3)	Max Peak output Power test	Pass
§15.247(e)	Power density	Pass
§15.247(d)	Band edge test	Pass
§15.207	AC Power Conducted Emission	Pass
§15.247(d), §15.209	Radiated Emission	Pass
§15.247(d)	Antenna Port Emission	Pass
§15.247(b)&§15.203	Antenna Application	Pass
N/A (Not Applicable).The product is battery powered.		



5. Test Facility

Site Description

EMC Lab : Accredited by CNAS, 2017.06.26
The certificate is valid until 2022.10.28
The Laboratory has been assessed and proved to be in compliance with CNAS-CL01:2006 (identical to ISO/IEC 17025:2005)
The Certificate Registration Number is L6214.

Accredited by A2LA, 2018.03.15
The Certificate Number is 4422.01.

Name of Firm : Dong Guan Anci Electronic Technology Co., Ltd.
Site Location : 1-2 Floor, Building A, No.11, Headquarters 2 Road, Songshan, Lake Hi-tech Industrial Development Zone, Dongguan City, Guangdong Pr., China.

6. Conducted Emissions Test

6.1 Measurement Procedure:

1. The EUT was placed on a table, which is 0.8m above ground plane.
2. Maximum procedure was performed on the six highest emissions to ensure EUT compliance.
3. Repeat above procedures until all frequency measured was complete.

6.2 Test SET-UP (Block Diagram of Configuration)

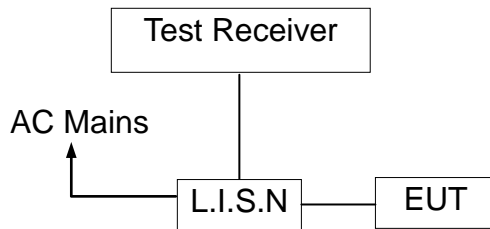

6.3 Measurement Equipment Used:

Conducted Emission Test Site				
EQUIPMENT TYPE	MFR	MODEL NUMBER	SERIAL NUMBER	Calibrated until
L.I.S.N	SCHWARZBECK	NSLK 8127	8127-669	2021-05-18
10 db attenuator	JFW	50FP-010-H4	4360846-427-1	2021-05-18
RF Cable	N/A	N/A	2#	2021-05-18
EMI Test Receiver	ROHDE&SCHWARZ	ESCI	101358	2021-05-18
Shielded Room	chengyu	8m*4m*3m	N/A	2021-05-18
Test Software	Farad	EZ-EMC Ver:ANCI-8A1	N/A	N/A

6.4 Conducted Emission Limit

(7) Conducted Emission Frequency(MHz)

0.15-0.5
0.5-5.0
5.0-30.0

Quasi-peak

66-56
56
60

Average

56-46
46
50

Note:

1. The lower limit shall apply at the transition frequencies
2. The limit decreases in line with the logarithm of the frequency in the range of 0.15 to 0.50MHz.

6.5 Measurement Result:

All the modulation modes were tested the data of the worst mode (802.11 g TX2462) are recorded in the following pages and the others modulation methods do not exceed the limits. Please refer to following pages.

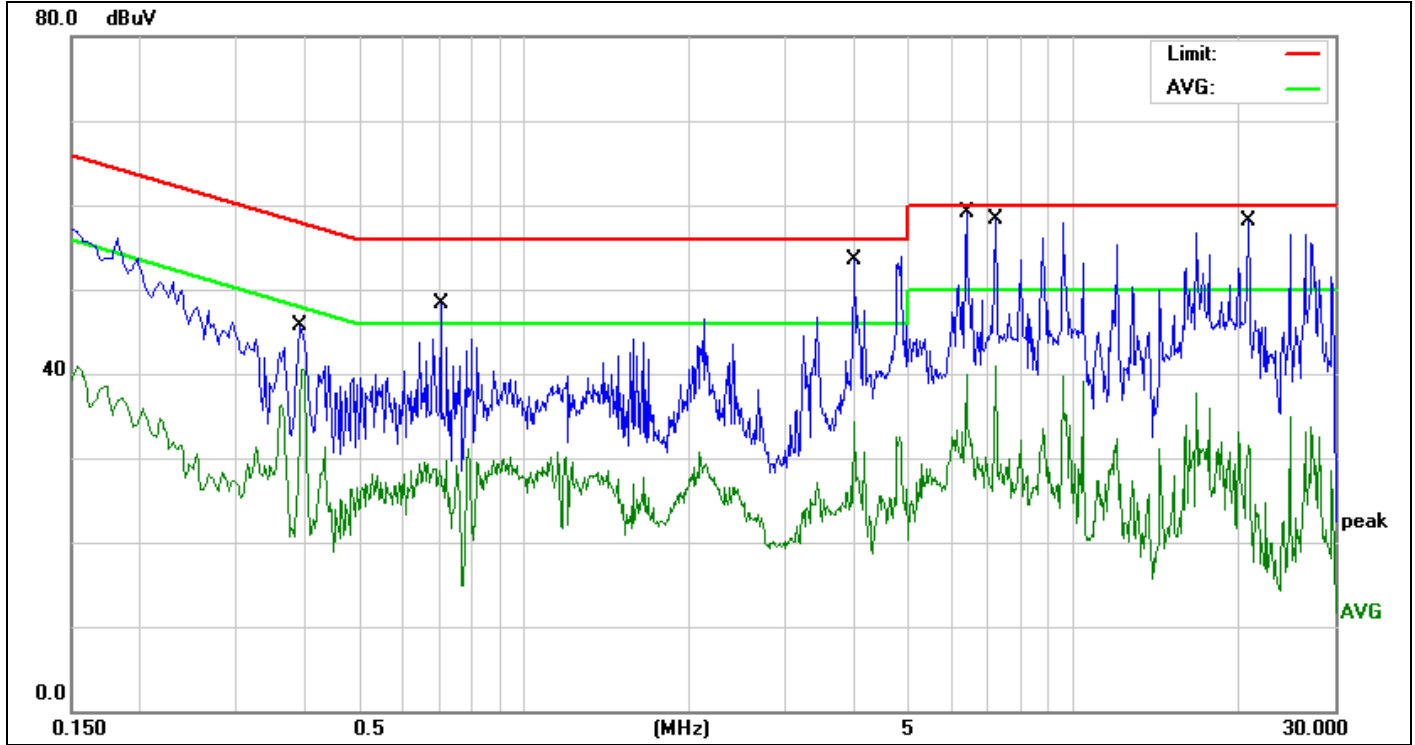

Site:	843	Phase: L1	Temperature(C): 26(C)
Limit:	FCC PART 15C Conduction(QP)	Test Time:	Humidity(%): 60%
EUT:	LED string light	Power Rating:	AC 120V/60Hz
M/N.:	ZYLED-WR01-24	Test Engineer:	Sunshine
Mode:	WIFI TX2462		
Note:			

No.	Frequency (MHz)	Reading Level(dBuV)	Factor (dB)	Measurement(dBuV)	Limit (dBuV)	Over (dB)	Detector	Comment
1	0.3899	35.47	10.18	45.65	58.06	-12.41	QP	
2	0.3899	30.33	10.18	40.51	48.06	-7.55	AVG	
3	0.7059	38.12	10.21	48.33	56.00	-7.67	QP	
4	0.7059	19.49	10.21	29.70	46.00	-16.30	AVG	
5	3.9860	40.15	10.41	50.56	56.00	-5.44	QP	
6	3.9860	23.94	10.41	34.35	46.00	-11.65	AVG	
7	6.3939	43.58	10.53	54.11	60.00	-5.89	QP	
8	6.3939	29.41	10.53	39.94	50.00	-10.06	AVG	
9	7.2259	44.25	10.57	54.82	60.00	-5.18	QP	
10	7.2259	30.28	10.57	40.85	50.00	-9.15	AVG	
11 *	20.8140	43.96	11.40	55.36	60.00	-4.64	QP	
12	20.8140	20.07	11.40	31.47	50.00	-18.53	AVG	

*:Maximum data x:Over limit !:over margin

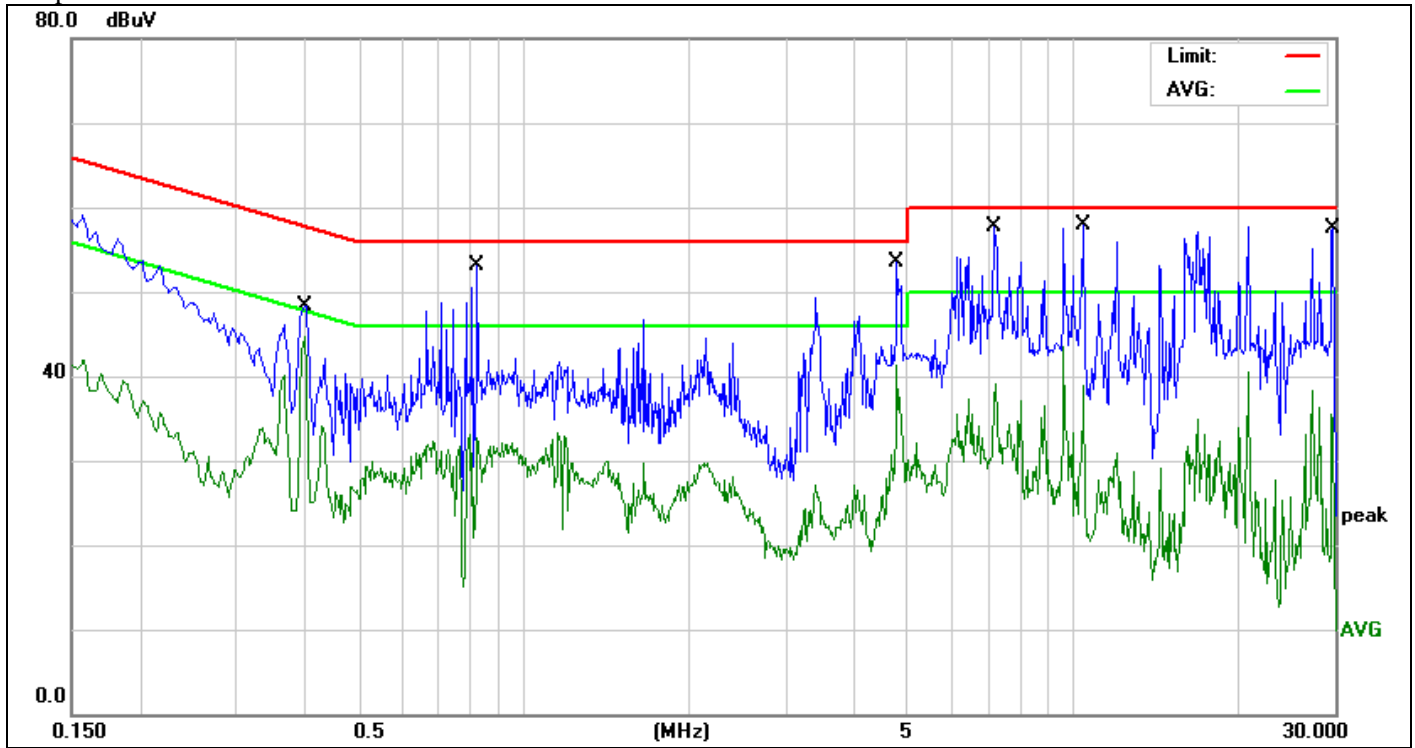

Site:	843	Phase:	N	Temperature(C):	26(C)
Limit:	FCC PART 15C Conduction(QP)	Test Time:	2020-09-23	Humidity(%):	60%
EUT:	LED string light	Power Rating:	AC 120V/60Hz	Test Engineer:	Sunshine
M/N.:	ZYLED-WR01-24				
Mode:	WIFI TX2462				
Note:					

No.	Frequency (MHz)	Reading Level(dBuV)	Factor (dB)	Measurement(dBuV)	Limit (dBuV)	Over (dB)	Detector	Comment
1	0.3980	38.14	10.18	48.32	57.89	-9.57	QP	
2 *	0.3980	34.50	10.18	44.68	47.89	-3.21	AVG	
3	0.8259	40.02	10.23	50.25	56.00	-5.75	QP	
4	0.8259	22.84	10.23	33.07	46.00	-12.93	AVG	
5	4.7857	40.58	10.44	51.02	56.00	-4.98	QP	
6	4.7857	30.84	10.44	41.28	46.00	-4.72	AVG	
7	7.1898	45.24	10.57	55.81	60.00	-4.19	QP	
8	7.1898	28.48	10.57	39.05	50.00	-10.95	AVG	
9	10.4618	44.69	10.73	55.42	60.00	-4.58	QP	
10	10.4618	28.12	10.73	38.85	50.00	-11.15	AVG	
11	29.6939	42.25	11.53	53.78	60.00	-6.22	QP	
12	29.6939	23.90	11.53	35.43	50.00	-14.57	AVG	

*:Maximum data x:Over limit !:over margin

6.5 Conducted Measurement Photos:



7. Radiated Emission Test

7.1 Measurement Procedure

1. Below 1000MHz, The EUT was placed on a turn table which is 0.8m above ground plane, And above 1000MHz, The EUT was placed on a styrofoam table which is 1.5m above ground plane.
2. Maximum procedure was performed on the six highest emissions to ensure EUT compliance.
3. And also, each emission was to be maximized by changing the polarization of receiving antenna both horizontal and vertical.
4. Repeat above procedures until all frequency measured was complete.

When spectrum scanned from 30MHz to 1GHz setting resolution bandwidth 120KHz and video bandwidth 300KHz:

EMI Test Receiver	Setting
Attenuation	Auto
RB	120KHz
VB	300KHz
Detector	QP
Trace	Max hold

When spectrum scanned above 1GHz setting resolution bandwidth 1MHz, video bandwidth 3MHz:

EMI Test Receiver	Setting
Attenuation	Auto
RB	1MHz
VB	3MHz
Detector	Peak
Trace	Max hold

When spectrum scanned above 1GHz setting resolution bandwidth 1MHz, video bandwidth 10Hz:

EMI Test Receiver	Setting
Attenuation	Auto
RB	1MHz
VB	10Hz
Detector	AVG
Trace	Max hold

7.2 Test SET-UP (Block Diagram of Configuration)

(A) Radiated Emission Test Set-Up, Frequency Below 30MHz

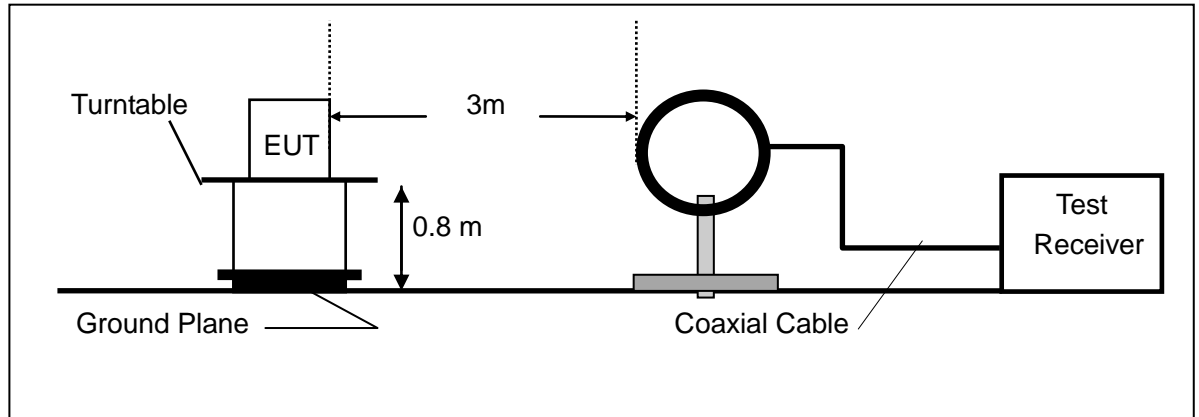

(B) Radiated Emission Test Set-Up, Frequency Below 1000MHz

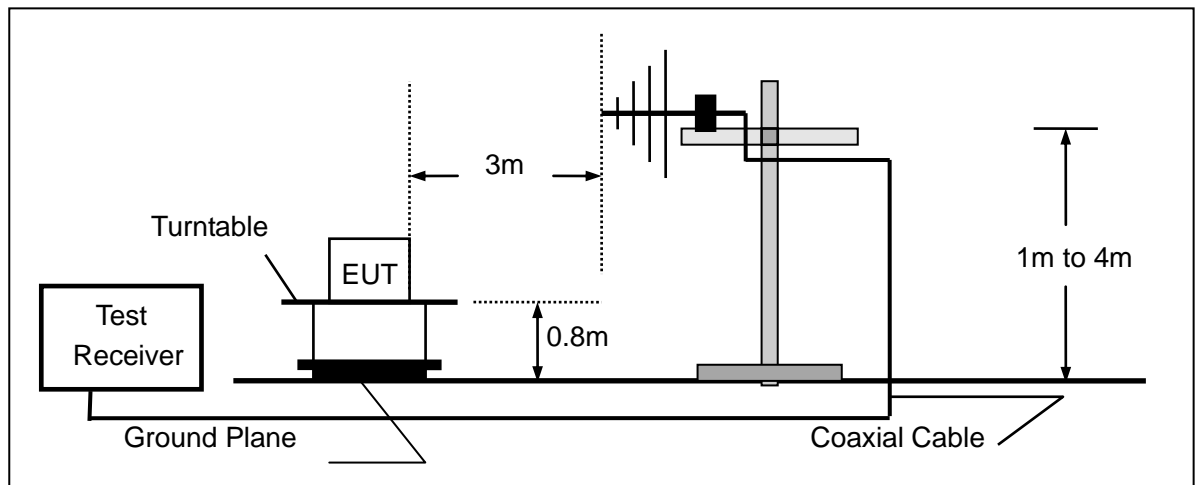

(C) Radiated Emission Test Set-Up, Frequency above 1000MHz

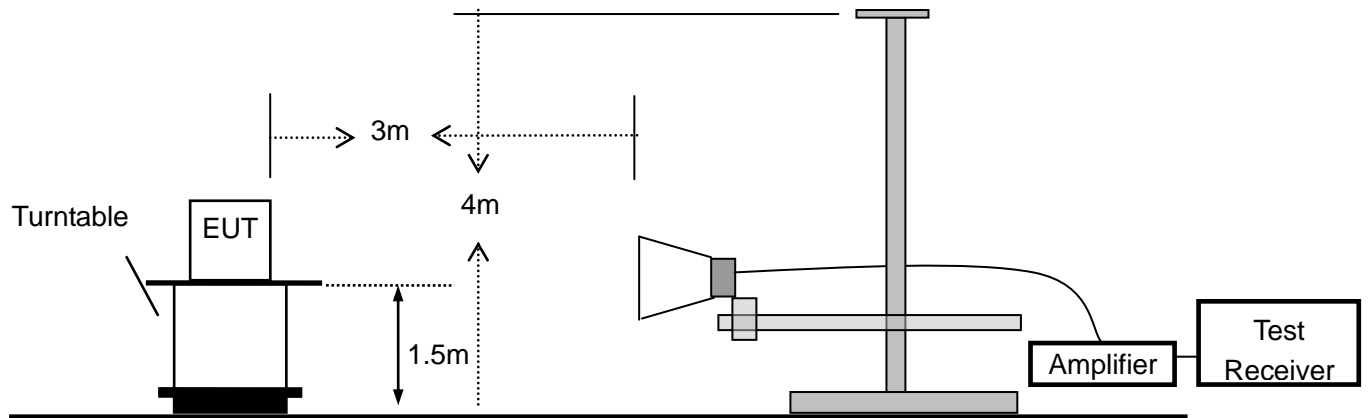

7.3 Measurement Equipment Used

Item	Equipment	Manufacturer	Model No.	Serial No.	Calibrated until
1.	EMI Test Receiver	Rohde & Schwarz	ESPI	100502	2020-11-28
2.	Pre-Amplifier	HP	8447D	2727A06172	2021-05-18
3.	Bilog Antenna	Schwarzbeck	VULB9163	VULB9163-588	2021-05-18
4.	Loop Antenna	Schwarzbeck	FMZB 1516	1516-141	2020-11-28
5.	Spectrum Analyzer	Rohde & Schwarz	FSV40	US40240623	2020-11-28
6.	Low noise Amplifiers	A-INFO	LA1018N4009	J101313052400 1	2021-05-18
7.	Horn antenna	A-INFO	LB-10180-SF	J203109061212 3	2021-05-18
8.	Broadband RF Power Amplifier	AEROFLEX	AEROFLEX10 0KHz-40GHz	J101313052400 1	2020-11-28
9.	DRG Horn Antenna	A.H.SYSTEMS	SAS-574	J203109061212 3	2020-11-28
10.	RF Cable	Gigalink Microwave	ZT40-2.92J-2.92J-2m	N/A	2020-11-28
11.	RF Cable	Gigalink Microwave	ZT40-2.92J-2.92J-0.3m	N/A	2020-11-28
12.	RF Cable	N/A	N/A	6#	2021-05-18
13.	RF Cable	N/A	N/A	1-1#	2021-05-18
14.	RF Cable	N/A	N/A	1-2#	2021-05-18
15.	RF Cable	N/A	N/A	7#	2021-05-18
16.	3m Semi-anechoic Chamber	chengyu	9m*6m*6m	N/A	2021-05-18
17.	Test Software	Farad	EZ-EMC Ver:ANCI-3A1	N/A	N/A

7.4 Radiated Emission Limit

The emissions from an intentional radiator shall not exceed the field strength levels specified in the following table 15.209(a):

Frequencies (MHz)	Field Strength (microrvolts/meter)	Measurement Distance (meters)
0.009~0.490	2400/F(KHz)	300
0.490~1.705	24000/F(KHz)	30
1.705~30.0	30	30
30~88	100	3
88~216	150	3
216~960	200	3
Above 960	500	3

15.205 Restricted bands of operation

MHz	MHz	MHz	GHz
0.090 - 0.110	16.42 - 16.423	399.9 - 410	4.5 - 5.15
¹ 0.495 - 0.505	16.69475 - 16.69525	608 - 614	5.35 - 5.46
2.1735 - 2.1905	16.80425 - 16.80475	960 - 1240	7.25 - 7.75
4.125 - 4.128	25.5 - 25.67	1300 - 1427	8.025 - 8.5
4.17725 - 4.17775	37.5 - 38.25	1435 - 1626.5	9.0 - 9.2
4.20725 - 4.20775	73 - 74.6	1645.5 - 1646.5	9.3 - 9.5
6.215 - 6.218	74.8 - 75.2	1660 - 1710	10.6 - 12.7
6.26775 - 6.26825	108 - 121.94	1718.8 - 1722.2	13.25 - 13.4
6.31175 - 6.31225	123 - 138	2200 - 2300	14.47 - 14.5
8.291 - 8.294	149.9 - 150.05	2310 - 2390	15.35 - 16.2
8.362 - 8.366	156.52475 - 156.52525	2483.5 - 2500	17.7 - 21.4
8.37625 - 8.38675	156.7 - 156.9	2690 - 2900	22.01 - 23.12
8.41425 - 8.41475	162.0125 - 167.17	3260 - 3267	23.6 - 24.0
12.29 - 12.293	167.72 - 173.2	3332 - 3339	31.2 - 31.8
12.51975 - 12.52025	240 - 285	3345.8 - 3358	36.43 - 36.5
12.57675 - 12.57725	322 - 335.4	3600 - 4400	(²)

- Remark 1. Emission level in dBuV/m=20 log (uV/m)
- :
- Measurement was performed at an antenna to the closed point of EUT distance of meters.
 - Only spurious frequency is permitted to locate within the Restricted Bands specified in provision of § 15.205, and the emissions located in restricted bands also comply with 15.209 limit.



7.5 Measurement Result

Below 30MHz:

All the modulation modes were tested the data of the test mode are recorded in the following pages.

Operation Mode:	TX Mode	Test Date :	October 13, 2020
Frequency Range:	9KHz~30MHz	Temperature :	26°C
Test Result:	PASS	Humidity :	60 %
Measured Distance:	3m	Test By:	Best

Freq. (MHz)	Ant.Pol. H/V	Emission Level (dBuV/m)	Limit 3m (dBuV/m)	Over (dB)
--	--	--	--	--

Note: the amplitude of spurious emission that is attenuated by more than 20dB below the permissible limit has no need to be reported.

Distance extrapolation factor =40log(Specific distance/ test distance)(dB);

Limit line=Specific limits(dBuV) + distance extrapolation factor.

Below 1000MHz:

All the modulation modes were tested the data of the worst mode (TX 802.11g 2462MHz) are recorded in the following pages and the others modulation methods do not exceed the limits.

Please refer to the following test plots:

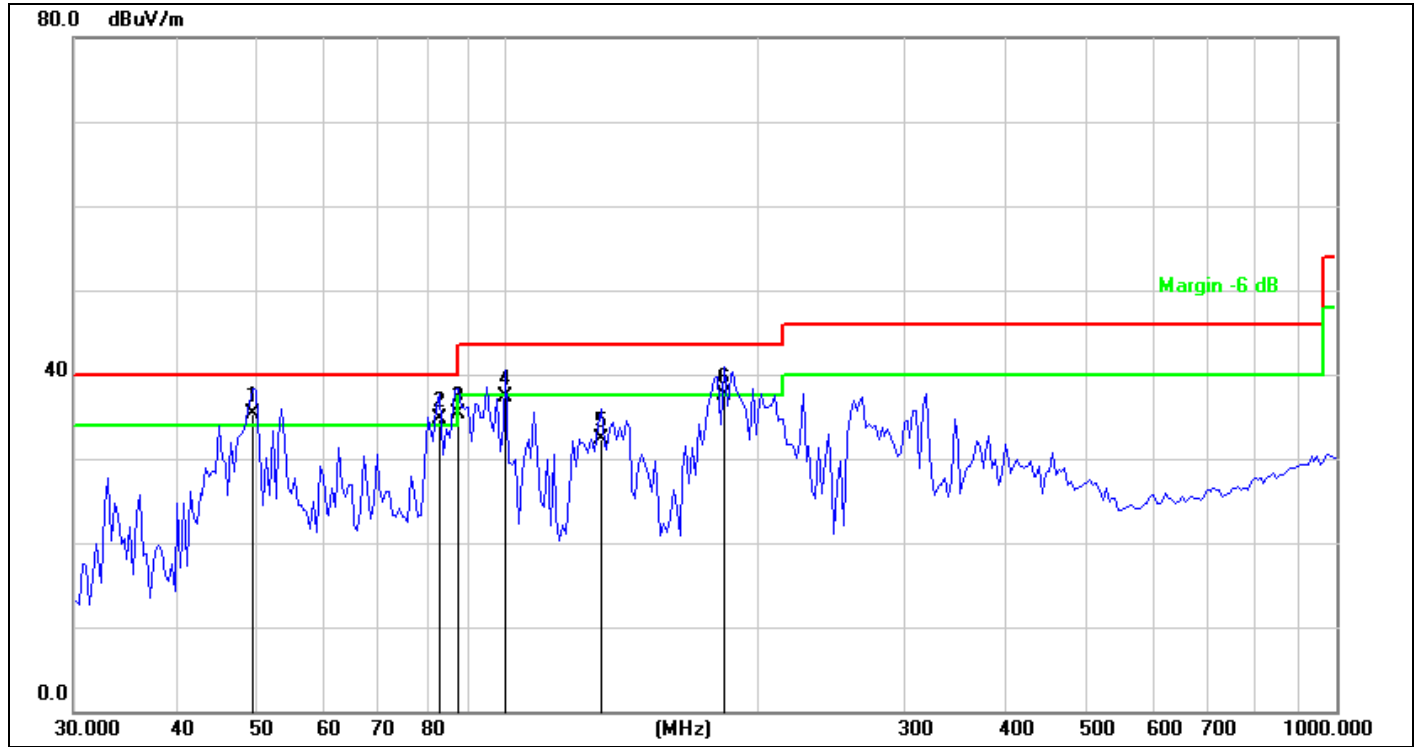

Site:	LAB	Antenna::	Horizontal	Temperature(C):	26(C)
Limit:	FCC Part 15 C 3m Radiation	Test Time:		Humidity(%):	60%
EUT:	LED string light	Power Rating:			2020/10/13
M/N.:	ZYLED-WR01-24	Test Engineer:			AC 120V/60Hz
Mode:	TX2462				Dyson
Note:					

No.	Frequency (MHz)	Reading (dBuV)	Factor (dB/m)	Level (dBuV/m)	Limit (dBuV/m)	Margin (dB)	Det.	Remark
1 !	49.4459	47.25	-11.99	35.26	40.00	-4.74	QP	
2 !	82.9385	49.39	-14.69	34.70	40.00	-5.30	QP	
3 *	87.4176	49.05	-13.69	35.36	40.00	-4.64	QP	
4	99.7027	48.39	-11.13	37.26	43.50	-6.24	QP	
5	129.6949	46.34	-13.98	32.36	43.50	-11.14	QP	
6	182.5592	49.44	-11.99	37.45	43.50	-6.05	QP	

Note: 1. Result Level = Read Level+ Antenna Factor+ Cable Loss- Amp. Factor

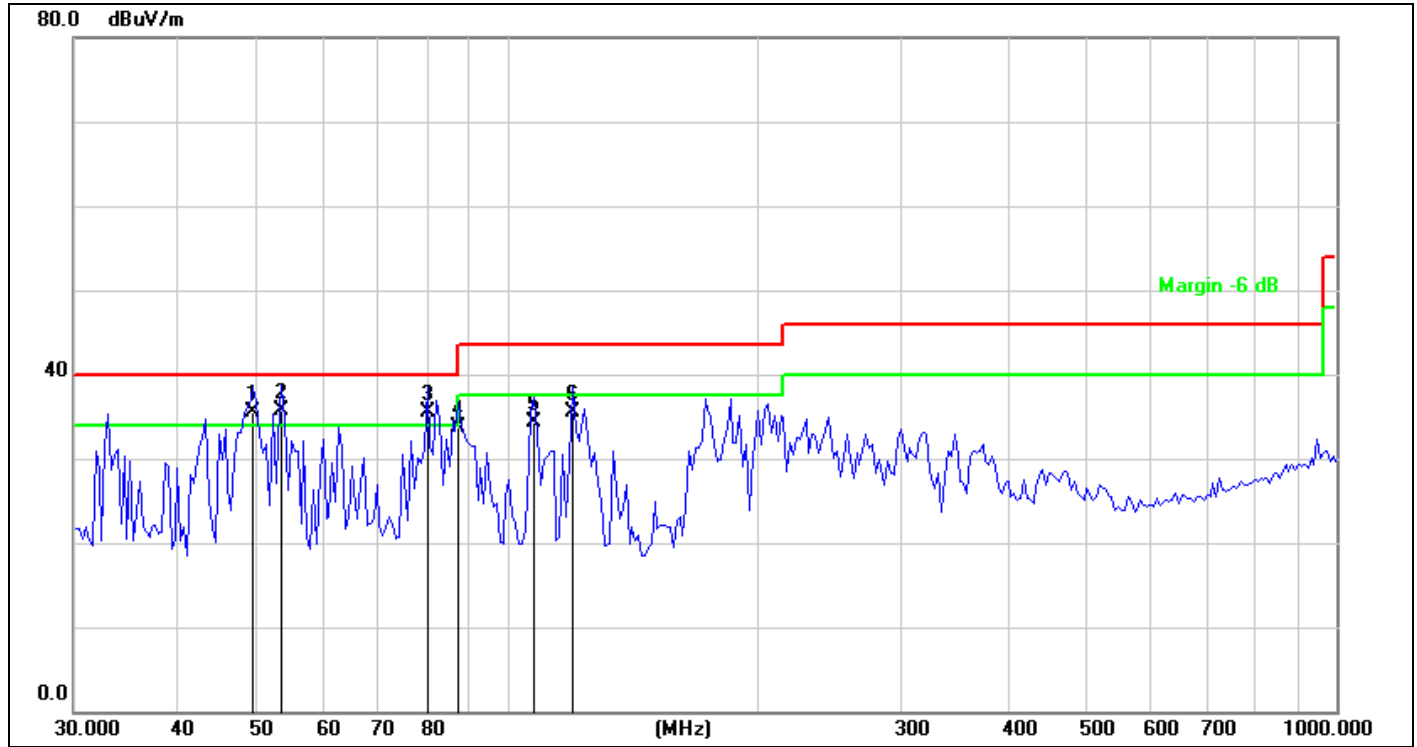

Site:	LAB	Antenna::	Vertical	Temperature(C):	26(C)
Limit:	FCC Part 15 C 3m Radiation	Test Time:		Humidity(%):	60%
EUT:	LED string light	Power Rating:			2020/10/13
M/N.:	ZYLED-WR01-24	Test Engineer:			AC 120V/60Hz
Mode:	TX2462				Dyson
Note:					

No.	Frequency (MHz)	Reading (dBuV)	Factor (dB/m)	Level (dBuV/m)	Limit (dBuV/m)	Margin (dB)	Det.	Remark
1 !	49.4459	47.50	-11.99	35.51	40.00	-4.49	QP	
2 *	53.5052	48.23	-12.50	35.73	40.00	-4.27	QP	
3 !	80.0806	50.93	-15.34	35.59	40.00	-4.41	QP	
4	87.4175	47.30	-13.69	33.61	40.00	-6.39	QP	
5	107.8876	45.44	-11.22	34.22	43.50	-9.28	QP	
6	119.8555	48.36	-12.81	35.55	43.50	-7.95	QP	

Note: 1. Result Level = Read Level+ Antenna Factor+ Cable Loss- Amp. Factor

**Above 1GHz:**

All the modulation modes were tested the data of the worst mode (TX 802.11b) are recorded in the following pages and the others modulation methods do not exceed the limits. The frequency range from 1GHz to 25GHz is investigated.

Operation Mode: 802.11b Lowest Test Date : October 13, 2020
 Test Voltage: AC 120V/60Hz Test by: Best

Freq. (MHz)	Ant. Pol. H/V	Emission Level(dBuV/m)		Limit 3m(dBuV/m)		Over(dB)	
		PK	AV	PK	AV	PK	AV
4824	V	64.68	45.2	74	54	-9.32	-8.8
7236	V	61.32	42.01	74	54	-12.68	-11.99
9648	V	58.14	40.66	74	54	-15.86	-13.34
12060	V	56.32	37.52	74	54	-17.68	-16.48
14472	V	55.32	36.52	74	54	-18.68	-17.48
16884	V	55.69	36.47	74	54	-18.31	-17.53
4824	H	64.85	45.39	74	54	-9.15	-8.61
7236	H	61.25	41.58	74	54	-12.75	-12.42
9648	H	58.23	39.63	74	54	-15.77	-14.37
12060	H	57.52	38.23	74	54	-16.48	-15.77
14472	H	56.21	36.52	74	54	-17.79	-17.48
16884	H	55.47	36.98	74	54	-18.53	-17.02

Operation Mode: 802.11b Middle Test Date : October 13, 2020
 Test Voltage: AC 120V/60Hz Test by: Best

Freq. (MHz)	Ant. Pol. H/V	Emission Level(dBuV/m)		Limit 3m(dBuV/m)		Over(dB)	
		PK	AV	PK	AV	PK	AV
4874	V	65.32	46.32	74	54	-8.68	-7.68
7311	V	61.26	42.09	74	54	-12.74	-11.91
9688	V	58.63	39.6	74	54	-15.37	-14.4
12185	V	57.52	38.14	74	54	-16.48	-15.86
14622	V	56.32	37.85	74	54	-17.68	-16.15
17059	V	56.25	36.58	74	54	-17.75	-17.42
4874	H	65.41	46.27	74	54	-8.59	-7.73
7311	H	61.25	42.36	74	54	-12.75	-11.64
9688	H	59.03	40.32	74	54	-14.97	-13.68
12185	H	58.32	39.25	74	54	-15.68	-14.75
14622	H	58.78	39.63	74	54	-15.22	-14.37
17059	H	58.18	39.17	74	54	-15.82	-14.83



Operation Mode: 802.11b Highest

Test Date : October 13, 2020

Test Voltage: AC 120V/60Hz

Test by: Best

Freq. (MHz)	Ant. Pol. H/V	Emission Level(dBuV/m)		Limit 3m(dBuV/m)		Over(dB)	
		PK	AV	PK	AV	PK	AV
4924	V	65.95	46.51	74	54	-8.05	-7.49
7386	V	62.35	43.29	74	54	-11.65	-10.71
9848	V	60.25	41.02	74	54	-13.75	-12.98
12310	V	58.47	39.62	74	54	-15.53	-14.38
14772	V	57.14	38.74	74	54	-16.86	-15.26
17234	V	56.23	37.52	74	54	-17.77	-16.48
4924	H	65.74	46.41	74	54	-8.26	-7.59
7386	H	62.58	43.25	74	54	-11.42	-10.75
9848	H	60.03	40.98	74	54	-13.97	-13.02
12310	H	58.66	39.14	74	54	-15.34	-14.86
14772	H	57.16	38.52	74	54	-16.84	-15.48
17234	H	56.2	37.41	74	54	-17.8	-16.59

All emissions not reported were more than 20dB below the specified limit or in the noise floor.

No others harmonics emissions are higher than 20 dB below the limits of 47 CFR Part 15.247.

- Note:**
- (1) All Readings are Peak Value and AV.
 - (2) Emission Level= Reading Level+Probe Factor +Cable Loss.
 - (3) Data of measurement within this frequency range shown “ – ” in the table above means the reading of emissions are attenuated more than 20dB below the permissible limits or the field strength is too small to be measured.

7.6 Radiated Measurement Photos:



8. 6dB Bandwidth Test

8.1 Measurement Procedure

The EUT was operating in IEEE 802.11b, 802.11g, 802.11n(HT20), 802.11n(HT40) mode or could be controlled its channel. Printed out the test result from the spectrum by hard copy function. The testing follows the Measurement Procedure of FCC KDB No. 558074 D01 15.247 Meas Guidance v05r02 .

1. Set resolution bandwidth (RBW) = 100 kHz.
2. Set the video bandwidth (VBW) $\geq 3 \times$ RBW.
3. Detector = Peak.
4. Trace mode = max hold.
5. Sweep = auto couple.
6. Allow the trace to stabilize.
7. Measure the maximum width of the emission that is constrained by the frequencies associated with the two outermost amplitude points (upper and lower frequency) that are attenuated by 6 dB relative to the maximum level measured in the fundamental emission.

8.2 Test SET-UP (Block Diagram of Configuration)

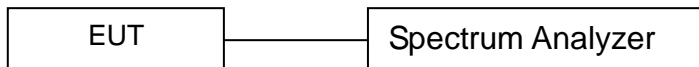

8.3 Measurement Equipment Used

EQUIPMENT TYPE	MFR	MODEL NUMBER	SERIAL NUMBER	CALIBRATED UNTIL
Spectrum Analyzer	Rohde & Schwarz	FSV40	US40240623	2020-11-28
Coaxial Cable	Gigalink Microwave	ZT40	19022092	2020-11-28
Antenna Connector	ARTHUR-YANG	2244-N1TG1	N/A	2020-11-28

Remark: The temporary antenna connector is soldered on the PCB board in order to perform conducted tests and this temporary antenna connector is listed in the equipment list.

8.4 Measurement Results

6db Bandwidth Test Data Chart:

Refer to attached data chart.

Spectrum Detector: PK
 Test By: Best
 Humidity : 60%

Test Date : October 13, 2020
 Temperature : 26°C

IEEE 802.11b			
Channel frequency (MHz)	Measurement level (MHz)	Required Limit (KHz)	Result
2412	11.056	>500	Pass
2437	11.072	>500	
2462	11.064	>500	

6dB NVNT 802.11b 2412MHz Ant1

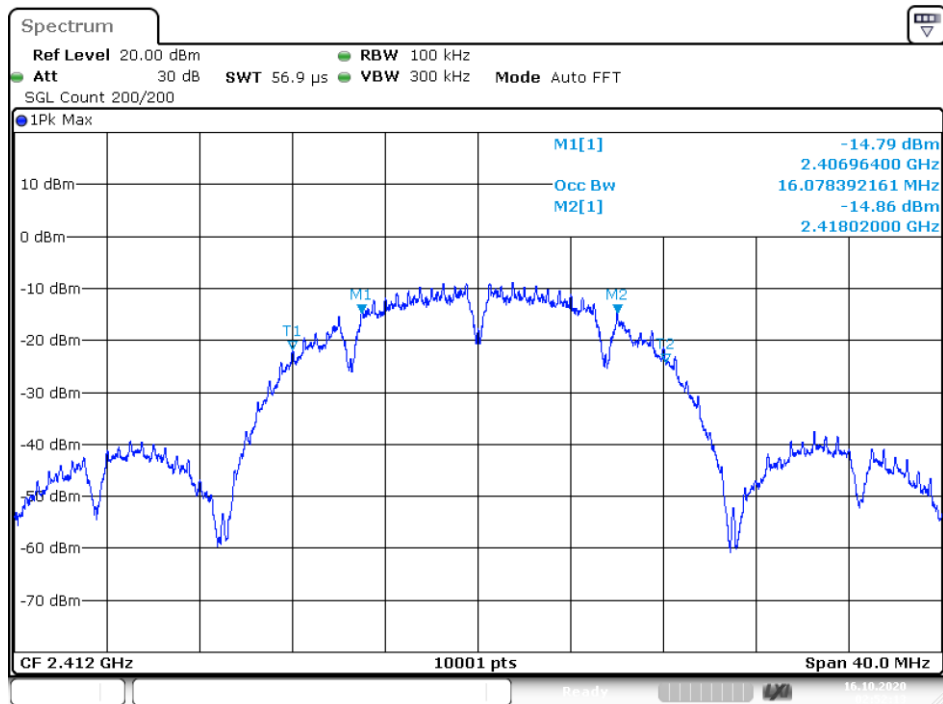

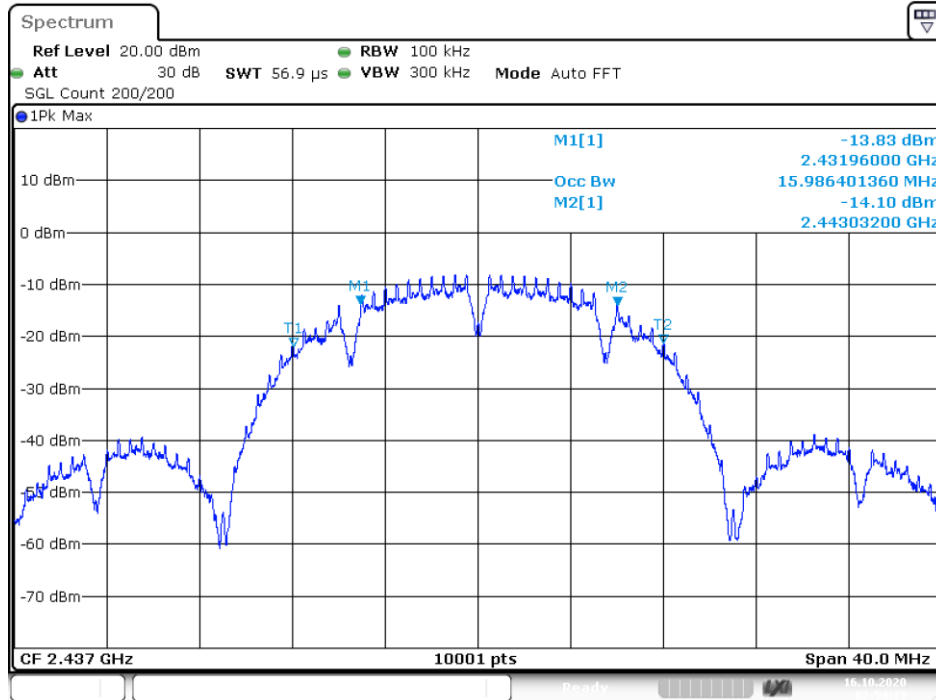

Date: 16.OCT.2020 02:54:13

6dB NVNT 802.11b 2462MHz Ant1

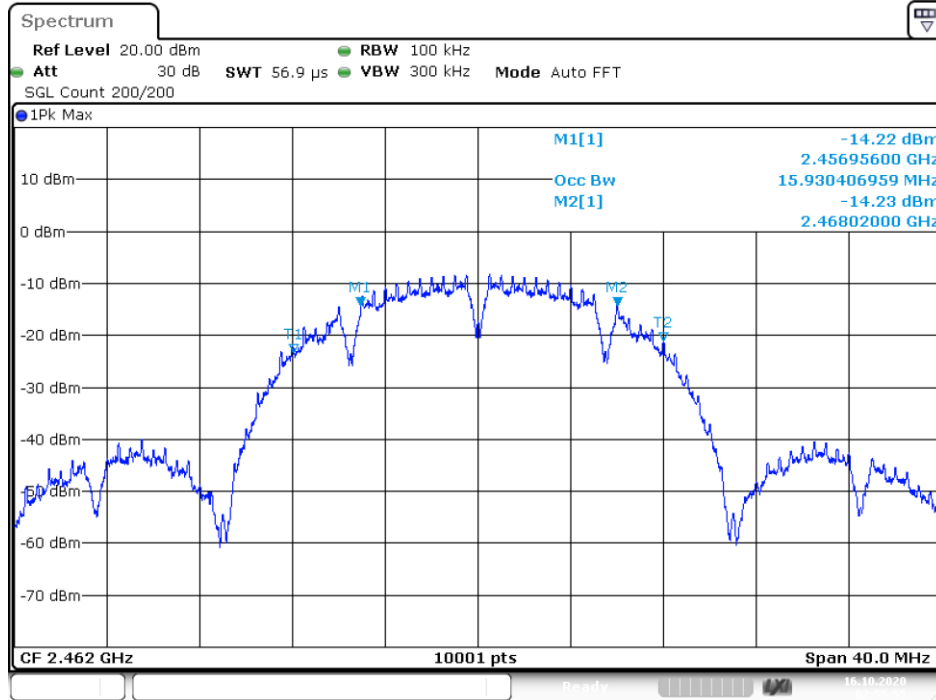

Date: 16.OCT.2020 02:55:55

IEEE 802.11g			
Channel frequency (MHz)	Measurement level (MHz)	Required Limit (KHz)	Result
2412	13.892	>500	Pass
2437	15.088	>500	
2462	15.056	>500	

6dB NVNT 802.11g 2412MHz Ant1

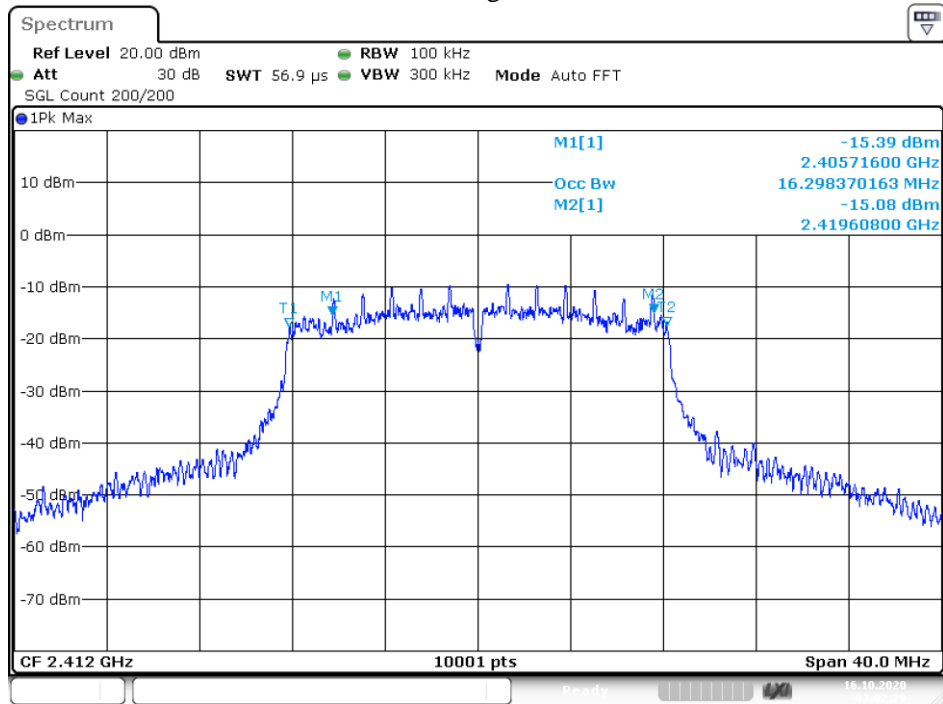

6dB NVNT 802.11g 2437MHz Ant1

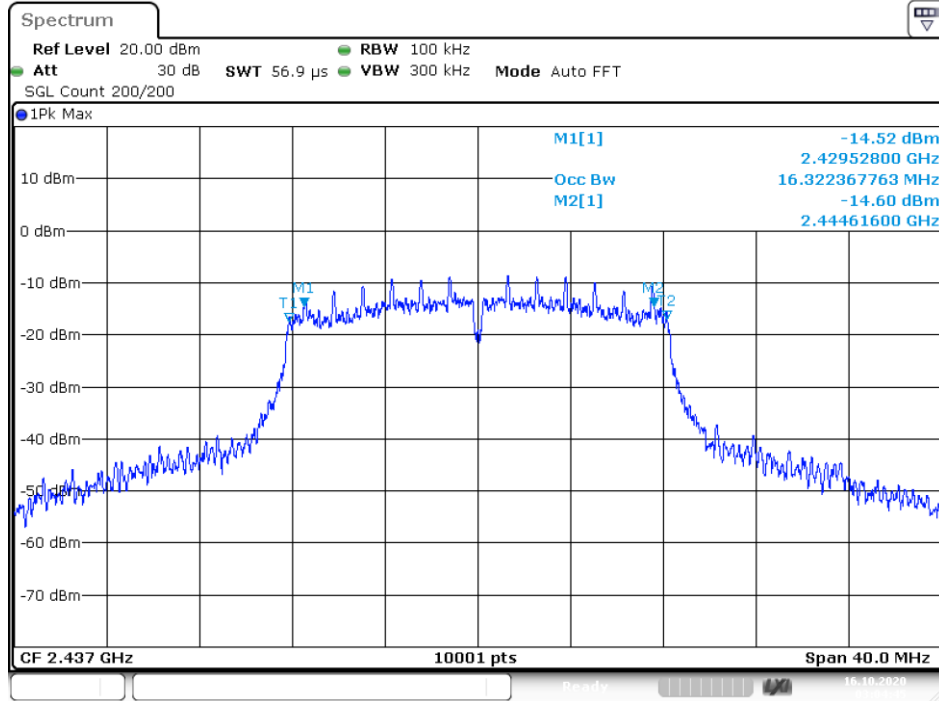

Date: 16.OCT.2020 03:04:45

6dB NVNT 802.11g 2462MHz Ant1

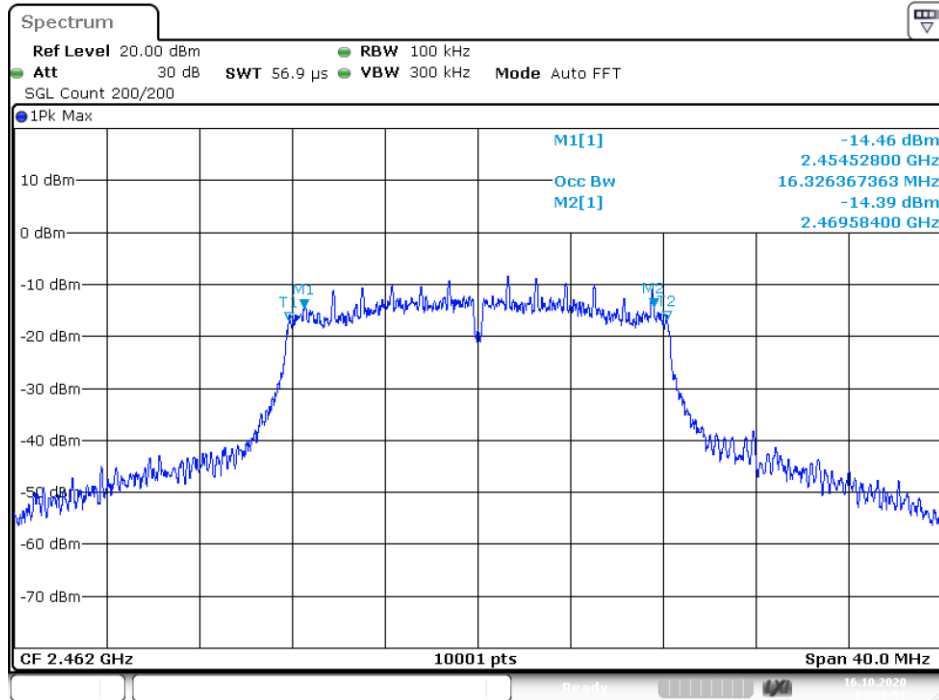

Date: 16.OCT.2020 03:06:53

IEEE 802.11n(HT20)			
Channel frequency (MHz)	Measurement level (MHz)	Required Limit (KHz)	Result
2412	15.752	>500	Pass
2437	15.444	>500	
2462	15.468	>500	

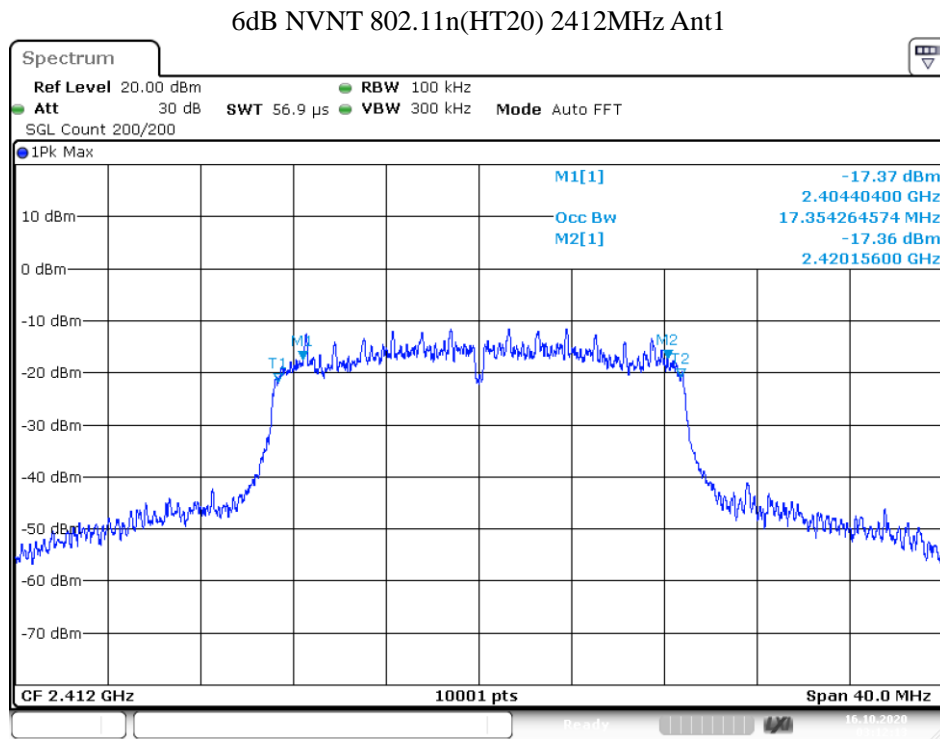

Date: 16.OCT.2020 03:12:13

6dB NVNT 802.11n(HT20) 2437MHz Ant1

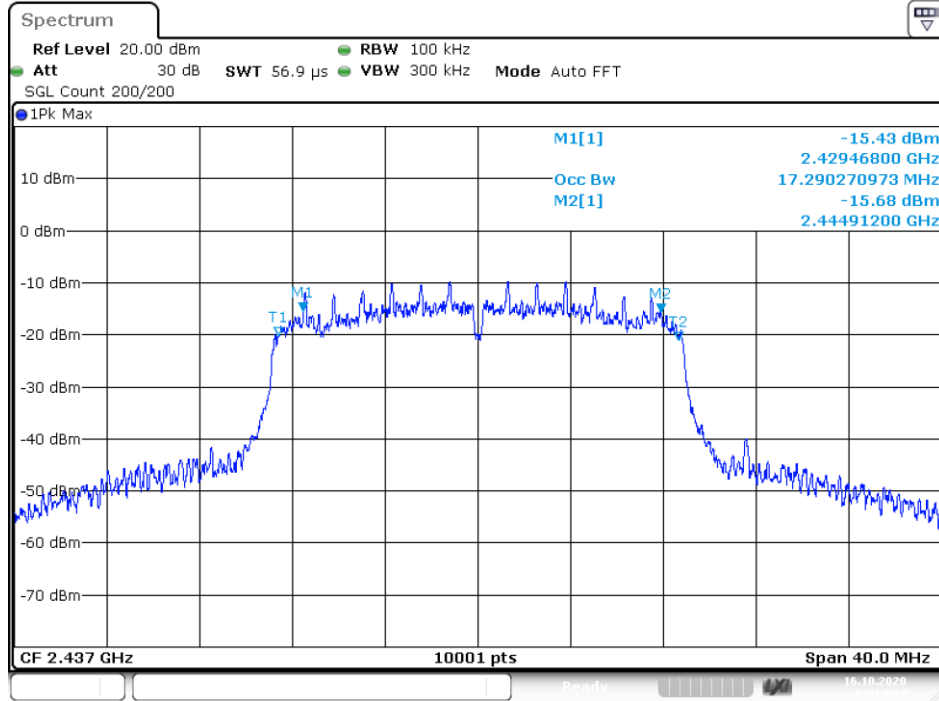

Date: 16.OCT.2020 03:14:37

6dB NVNT 802.11n(HT20) 2462MHz Ant1

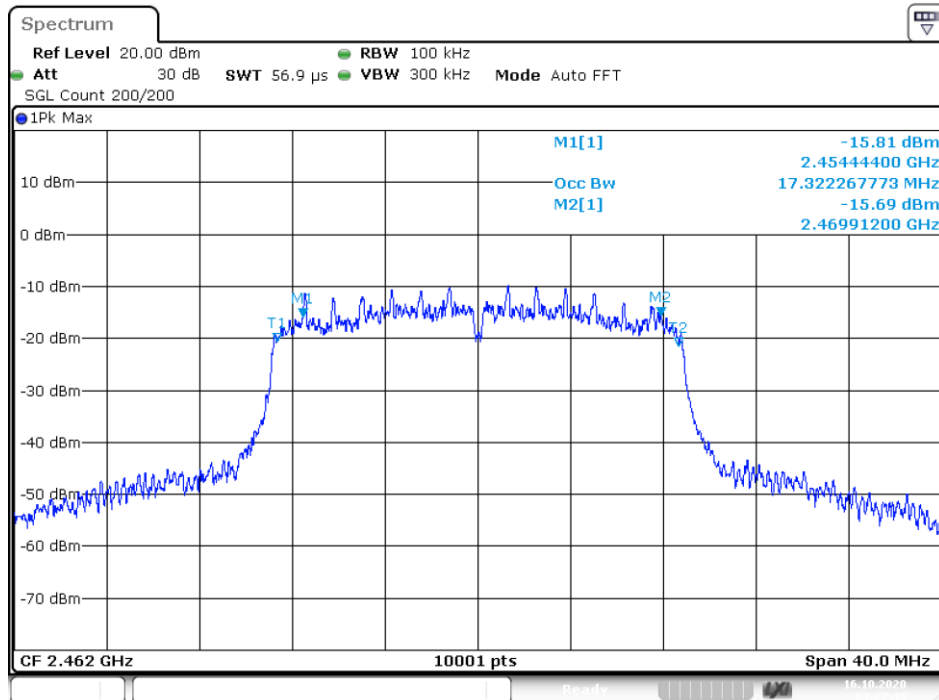

Date: 16.OCT.2020 03:27:35

IEEE 802.11n(HT40)			
Channel frequency (MHz)	Measurement level (MHz)	Required Limit (KHz)	Result
2422	35.112	>500	Pass
2437	35.096	>500	
2452	35.096	>500	

6dB NVNT 802.11n(HT40) 2422MHz Ant1

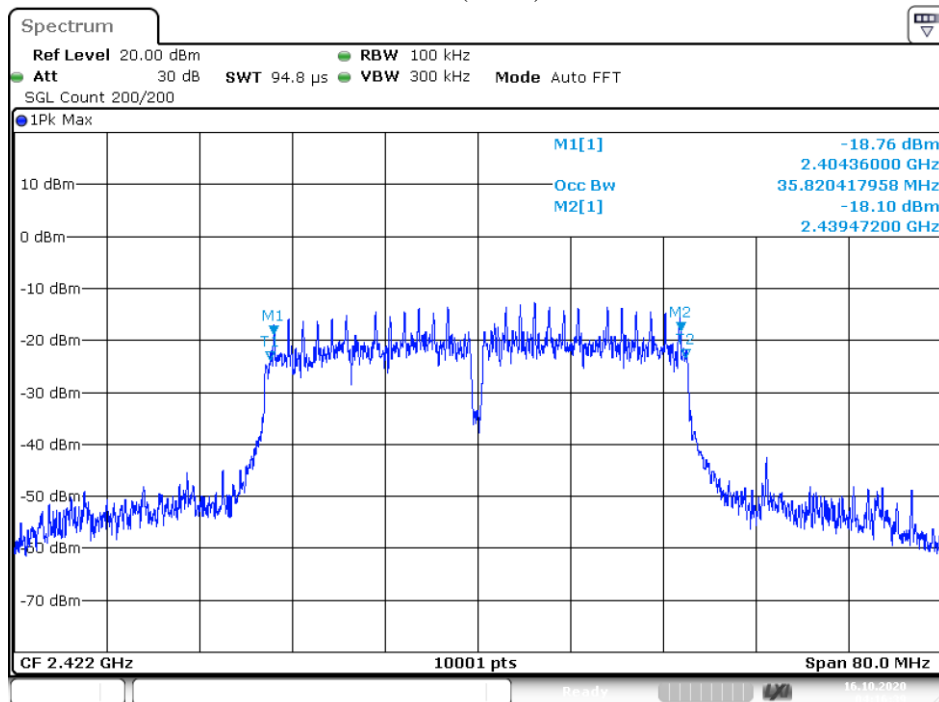

Date: 16.OCT.2020 04:16:39

6dB NVNT 802.11n(HT40) 2437MHz Ant1

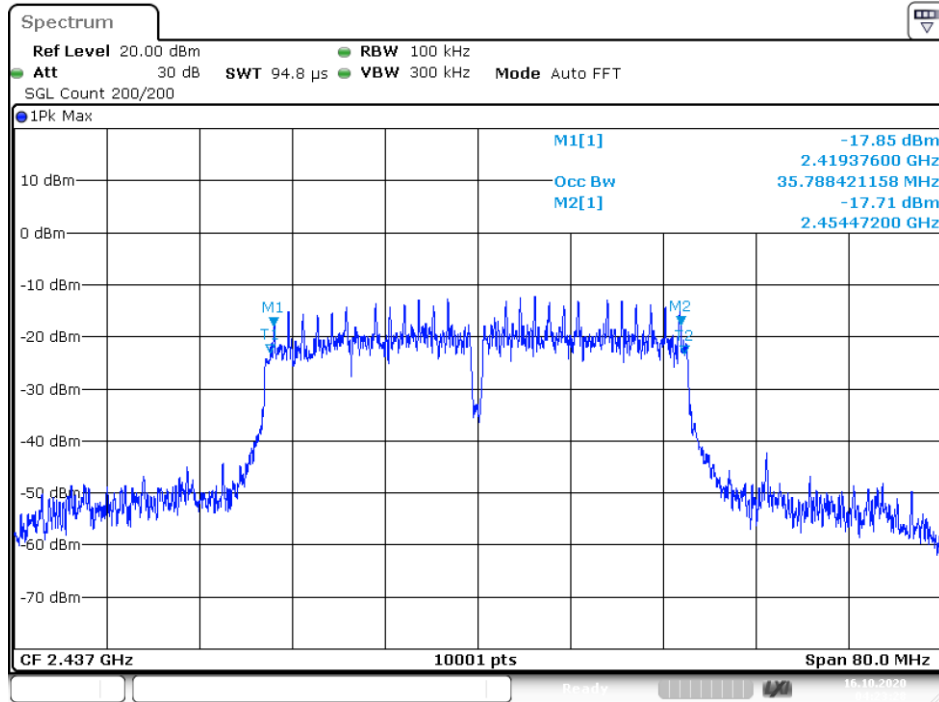

6dB NVNT 802.11n(HT40) 2452MHz Ant1

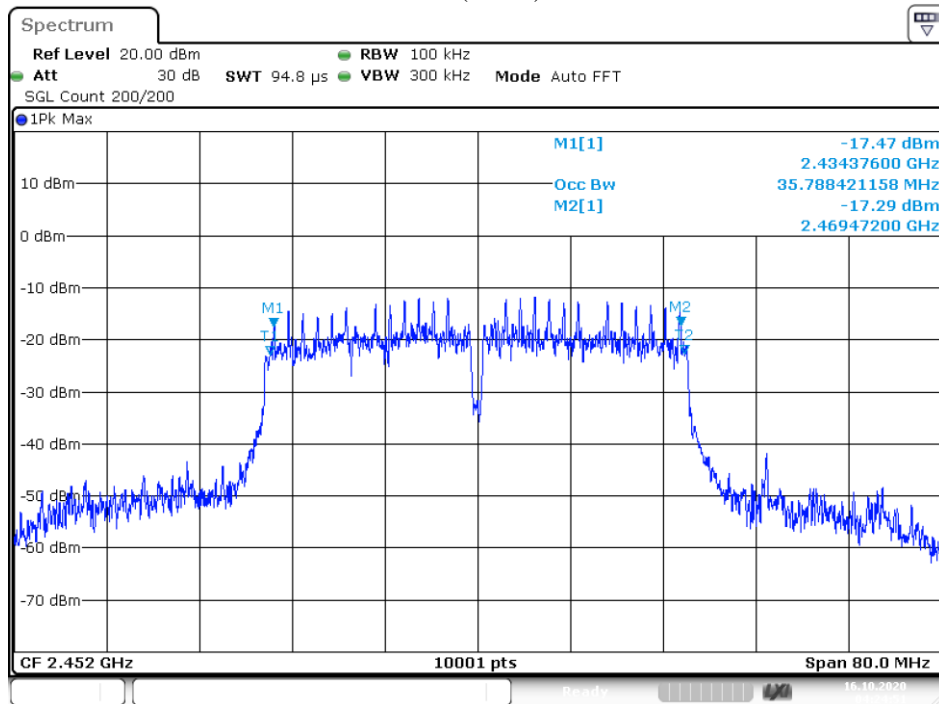

9. Maximum Peak Output Power Test

9.1 Measurement Procedure

1. The testing follows the Measurement Procedure of FCC KDB No. 558074 D01 15.247 Meas Guidance v05r02. The RF output of EUT was connected to the power meter by RF cable and attenuator. The path loss was compensated to the results for each measurement.
2. Set to the maximum power setting and enable the EUT transmit continuously.
3. Measure the conducted output power and record the results in the test report.

9.2 Test SET-UP (Block Diagram of Configuration)



9.3 Measurement Equipment Used

EQUIPMENT TYPE	Manufacturer	Model No.	Serial Number	Calibrated until.
USB RF Power sensor	RadiPower	RPR3006W	17I00015SNO88	2020-11-28
RF Test Software	MAIWEI	MTS 8310	N/A	N/A

Remark: The temporary antenna connector is soldered on the PCB board in order to perform conducted tests and this temporary antenna connector is listed in the equipment list.

9.4 Peak Power output limit

The maximum peak power shall be less 1Watt.

9.5 Measurement Results

Spectrum Detector:	PK	Test Date :	October 13, 2020
Test By:	Best	Temperature :	26°C
Test Result:	PASS	Humidity :	60%

Test Channel	Peak Output Power (dBm)				Limit(dBm)	Result
	802.11b	802.11g	802.11n(HT20)	802.11n(HT40)		
Lowest	9.81	9.14	8.24	7.32	30	Pass
Middle	10.24	10.16	9.12	8.12		
Highest	10.12	10.21	9.28	8.52		

10. Band Edge Test

10.1 Measurement Procedure

For Conducted Test

1. The testing follows FCC KDB Publication No. 5558074 D01 15.247 Meas Guidance v05r02.
2. The RF output of EUT was connected to the spectrum analyzer by RF cable and attenuator. The path loss was compensated to the results for each measurement.
3. Set to the maximum power setting and enable the EUT transmit continuously.
4. Set RBW = 100 kHz, VBW=300 kHz, Peak Detector. Unwanted Emissions measured in any 100 kHz bandwidth outside of the authorized frequency band shall be attenuated by at least 20 dB relative to the maximum in-band peak PSD level in 100 kHz when maximum peak conducted output power procedure is used. Measure and record the results in the test report.
5. The RF fundamental frequency should be excluded against the limit line in the operating frequency band.

For Radiated emission Test

1. The testing follows FCC KDB Publication No. 5558074 D01 15.247 Meas Guidance v05r02.
2. The EUT was arranged to its worst case and then tune the antenna tower (from 1 m to 4 m) and turntable (from 0 degree to 360 degrees) to find the maximum reading. A pre-amp and a high pass filter are used for the test in order to get better signal level.
3. The EUT was placed on a turntable with 0.8 meter above ground.
4. The EUT was set 3 meters from the interference receiving antenna, which was mounted on the top of a variable height antenna tower.
5. Corrected Reading: Antenna Factor + Cable Loss + Read Level - Preamp Factor = Level.
6. For measurement below 1GHz, If the emission level of the EUT measured by the peak detector is 3 dB lower than the applicable limit, the peak emission level will be reported. Otherwise, the emission measurement will be repeated using the quasi-peak detector and reported.
7. Repeat above procedures until all frequency measured were complete.

When spectrum scanned above 1GHz setting resolution bandwidth 1MHz, video bandwidth 3MHz.

EMI Test Receiver	Setting
Attenuation	Auto
RB	1MHz
VB	3MHz
Detector	Peak
Trace	Max hold

When spectrum scanned above 1GHz setting resolution bandwidth 1MHz, video bandwidth 10Hz.

EMI Test Receiver	Setting
Attenuation	Auto
RB	1MHz
VB	10Hz
Detector	AVG
Trace	Max hold

10.2 Test SET-UP (Block Diagram of Configuration)

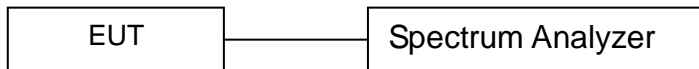

10.3 Measurement Equipment Used

EQUIPMENT TYPE	MFR	MODEL NUMBER	SERIAL NUMBER	CALIBRATED UNTIL
Spectrum Analyzer	Rohde & Schwarz	FSV40	US40240623	2020-11-28
Coaxial Cable	Gigalink Microwave	ZT40	19022092	2020-11-28
Antenna Connector	ARTHUR-YANG	2244-N1TG1	N/A	2020-11-28

Remark: The temporary antenna connector is soldered on the PCB board in order to perform conducted tests and this temporary antenna connector is listed in the equipment list.

10.4 Measurement Results

1. Conducted Test

Please refer to the following pages.

Band Edge 802.11b 2412MHz Ant1 Emission

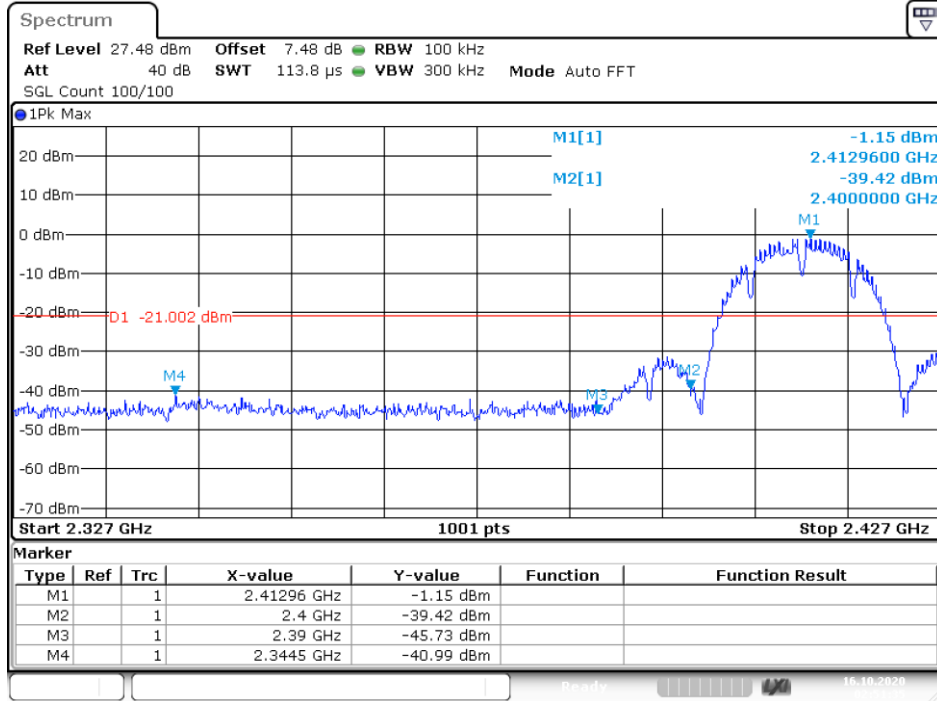

Band Edge 802.11b 2462MHz Ant1 Emission

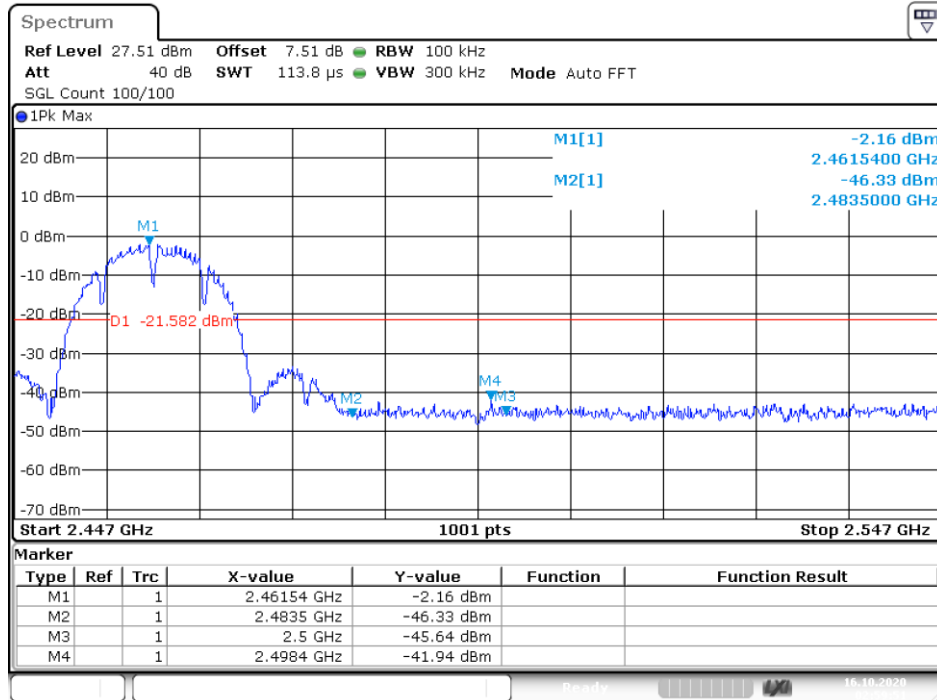

Band Edge 802.11g 2412MHz Ant1 Emission

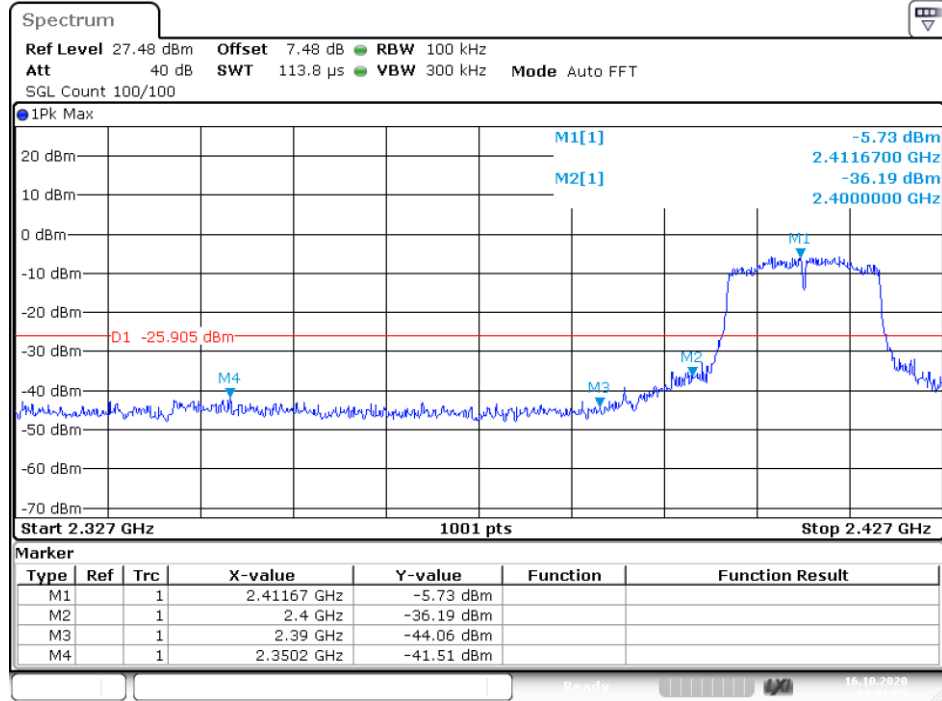

Band Edge 802.11g 2462MHz Ant1 Emission

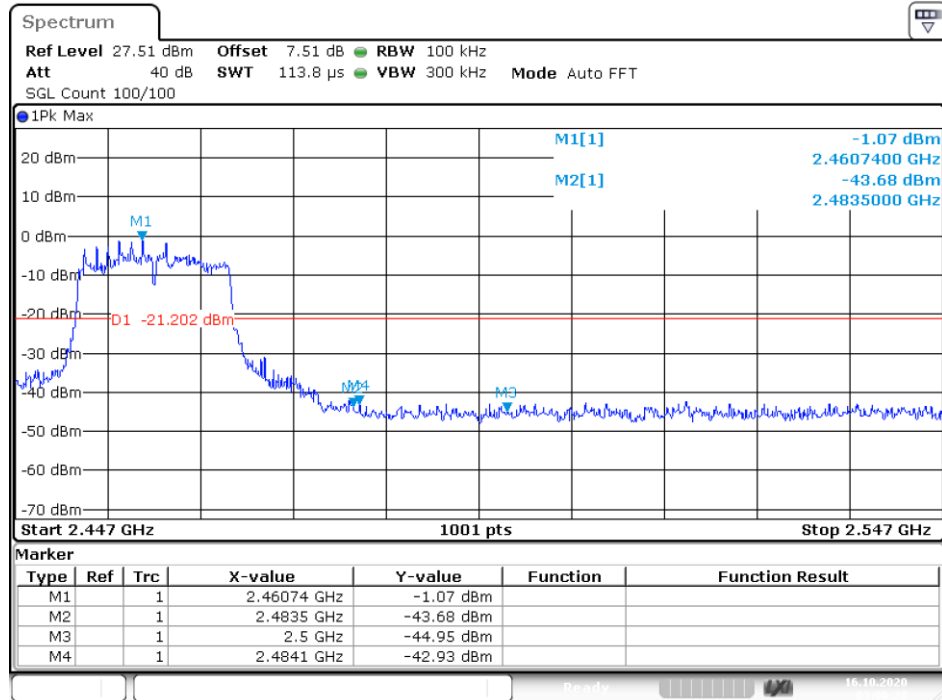

Band Edge 802.11n(HT20) 2412MHz Ant1 Emission

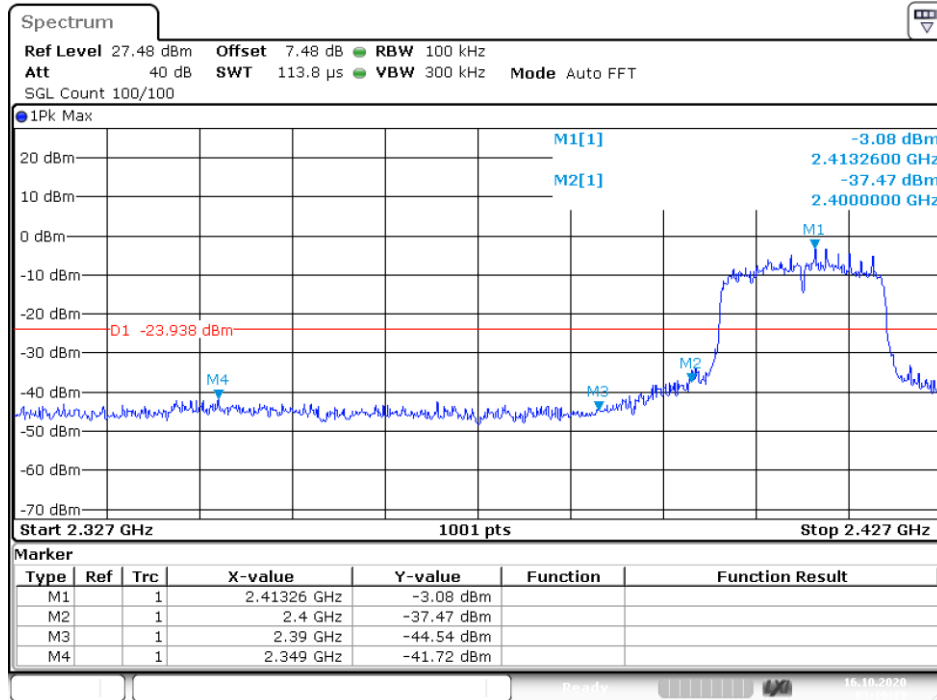

Band Edge 802.11n(HT20) 2462MHz Ant1 Emission

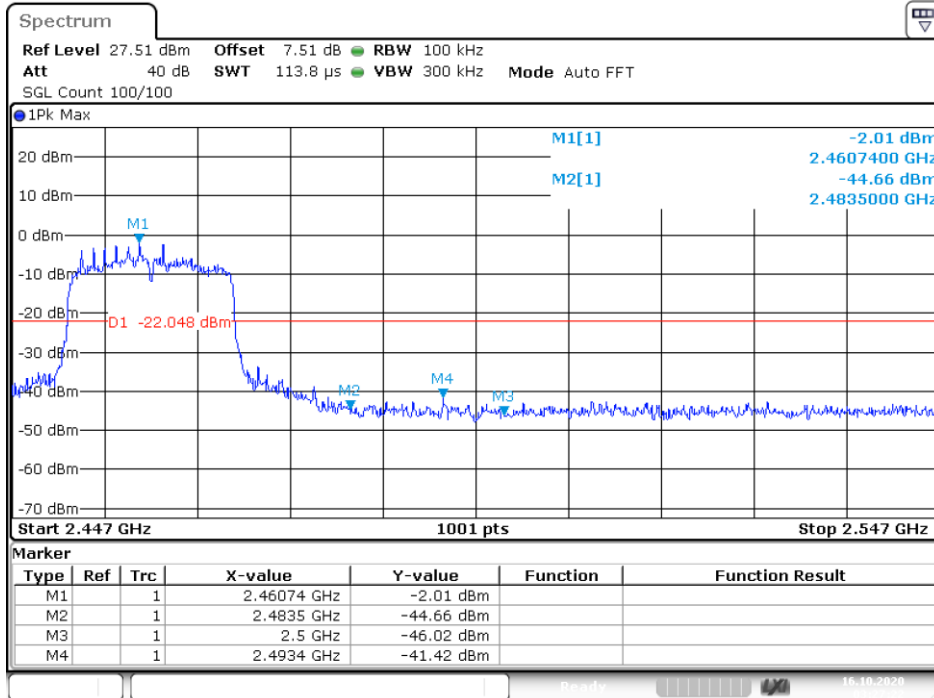

Date: 16.OCT.2020 03:27:21

Band Edge 802.11n(HT40) 2422MHz Ant1 Emission

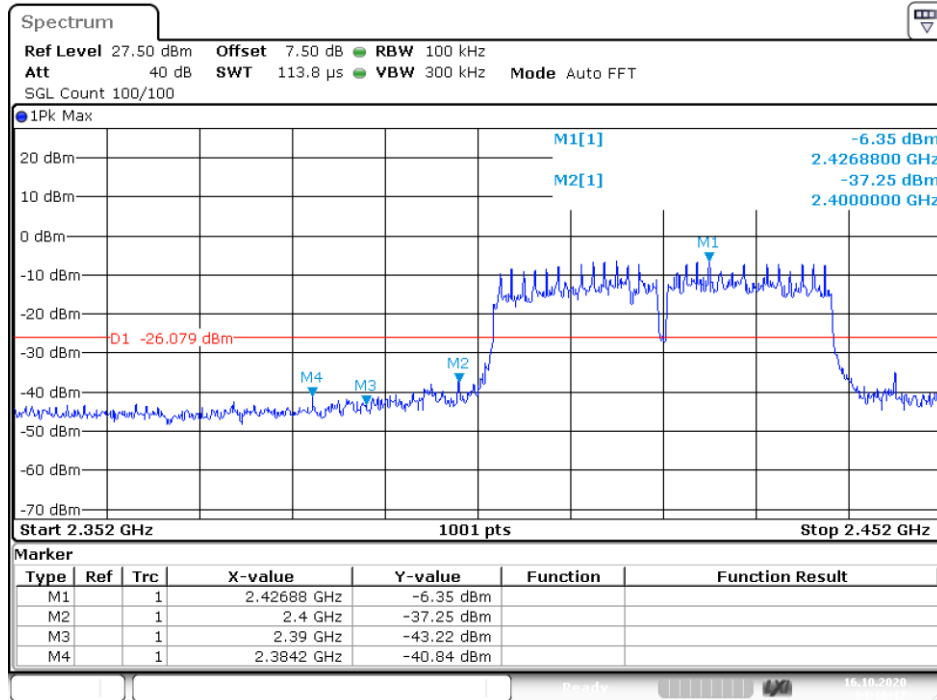

Band Edge 802.11n(HT40) 2452MHz Ant1 Emission

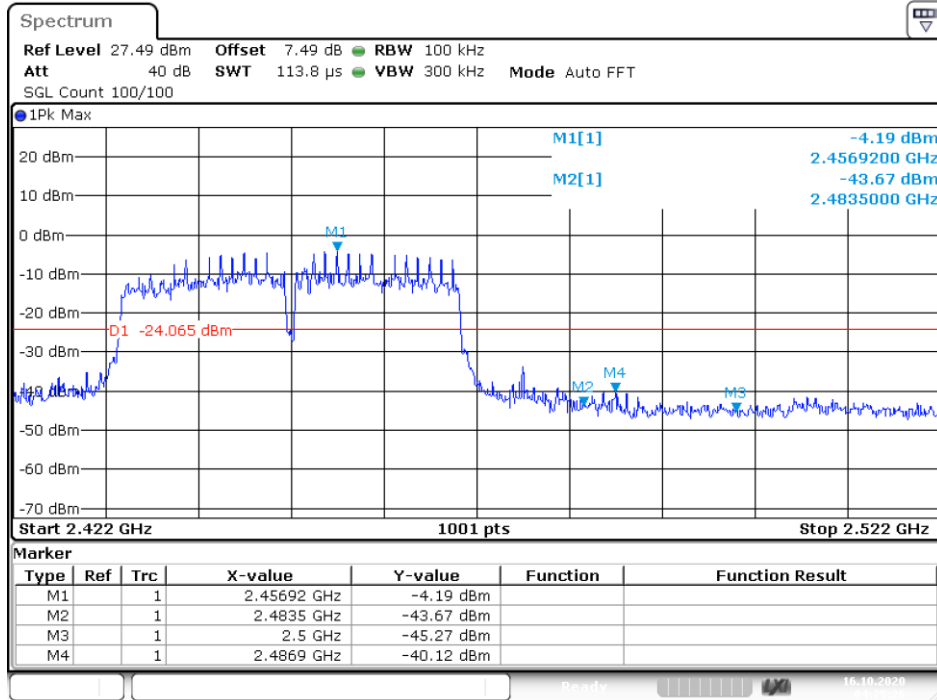

Date: 16.OCT.2020 04:25:25



Report No.: EA2008600F04001

44 of 68

2. Radiated emission Test

Spectrum Detector:

PK/AV

Test Date :

August 20, 2020

Test By:

Best

Temperature :

28 °C

Humidity :

65 %

IEEE 802.11b SISO Ant1										
Freq. (MHz)	Ant. Pol. H/V	Reading Level(dBuV/m)		Correct Factor dB	Emission Level(dBuV/m)		Limit 3m(dBuV/m)		Margin(dB)	
		PK	AV		PK	AV	PK	AV	PK	AV
<2400	H	83.65	64.02	-26.3	57.35	37.72	74	54	-16.65	-16.28
<2400	V	82.69	63.11	-26.1	56.59	37.01	74	54	-17.41	-16.99
>2483.5	H	83.23	64.25	-26.3	56.93	37.95	74	54	-17.07	-16.05
>2483.5	V	82.47	63.14	-26.1	56.37	37.04	74	54	-17.63	-16.96

IEEE 802.11g SISO Ant1										
Freq. (MHz)	Ant. Pol. H/V	Reading Level(dBuV/m)		Correct Factor dB	Emission Level(dBuV/m)		Limit 3m(dBuV/m)		Margin(dB)	
		PK	AV		PK	AV	PK	AV	PK	AV
<2400	H	84.23	64.19	-26.3	57.93	37.89	74	54	-16.07	-16.11
<2400	V	83.25	63.32	-26.1	57.15	37.22	74	54	-16.85	-16.78
>2483.5	H	83.69	64.02	-26.3	57.39	37.72	74	54	-16.61	-16.28
>2483.5	V	84.42	64.25	-26.1	58.32	38.15	74	54	-15.68	-15.85

IEEE 802.11n(HT20) SISO										
Freq. (MHz)	Ant. Pol. H/V	Reading Level(dBuV/m)		Correct Factor dB	Emission Level(dBuV/m)		Limit 3m(dBuV/m)		Margin(dB)	
		PK	AV		PK	AV	PK	AV	PK	AV
<2400	H	83.26	63.89	-26.3	56.96	37.59	74	54	-17.04	-16.41
<2400	V	82.36	64.02	-26.1	56.26	37.92	74	54	-17.74	-16.08
>2483.5	H	82.47	63.49	-26.3	56.17	37.19	74	54	-17.83	-16.81
>2483.5	V	82.71	63.58	-26.1	56.61	37.48	74	54	-17.39	-16.52

IEEE 802.11n(H40) SISO										
Freq. (MHz)	Ant. Pol. H/V	Reading Level(dBuV/m)		Correct Factor dB	Emission Level(dBuV/m)		Limit 3m(dBuV/m)		Margin(dB)	
		PK	AV		PK	AV	PK	AV	PK	AV
<2400	H	80.32	62.02	-26.3	54.02	35.72	74	54	-19.98	-18.28
<2400	V	79.63	61.33	-26.1	53.53	35.23	74	54	-20.47	-18.77
>2483.5	H	78.62	60.47	-26.3	52.32	34.17	74	54	-21.68	-19.83
>2483.5	V	78.23	60.23	-26.1	52.13	34.13	74	54	-21.87	-19.87

11. Power Density

11.1 Test Equipment

EQUIPMENT TYPE	MFR	MODEL NUMBER	SERIAL NUMBER	CALIBRATED UNTIL
Spectrum Analyzer	Rohde & Schwarz	FSV40	US40240623	2020-11-28
Coaxial Cable	Gigalink Microwave	ZT40	19022092	2020-11-28
Antenna Connector	ARTHUR-YANG	2244-N1TG1	N/A	2020-11-28

Remark: The temporary antenna connector is soldered on the PCB board in order to perform conducted tests and this temporary antenna connector is listed in the equipment list.

11.2 Measuring Instruments and Setting

The following table is the setting of spectrum analyzer.

Spectrum analyzer	Setting
Attenuation	Auto
Span Frequency	Set the span to 1.5 times the DTS bandwidth.
RB	3kHz
VB	10KHz
Detector	Peak
Trace	Max hold
Sweep Time	Automatic

11.3 Test Procedures

The testing follows the Measurement Procedure of FCC KDB No. 558074 D01 15.247 Meas Guidance v05r02.

- a. The transmitter output (antenna port) was connected to the spectrum analyzer.
- b. Set analyzer center frequency to DTS channel center frequency.
- c. Set the analyzer span to a minimum of 1.5 times the DTS bandwidth.
- d. Set the RBW ≥ 3 kHz. Set the VBW $\geq 3 \times$ RBW.
- e. Detector = peak.
- f. Sweep time = auto couple.
- g. Trace mode = max hold.
- h. Allow trace to fully stabilize.
- i. Use the peak marker function to determine the maximum amplitude level.

11.4 Block Diagram of Test Setup

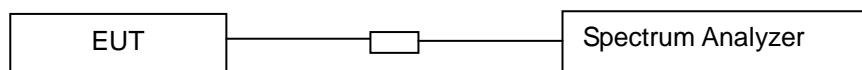

11.5 Limit

The transmitted power density averaged over any 1 second interval shall not be greater +8dBm in any 3 kHz bandwidth.

11.6 Test Result

Spectrum Detector:	PK	Test Date :	October 13, 2020
Test By:	Best	Temperature :	26°C
Test Result:	PASS	Humidity :	60%

IEEE 802.11b			
Channel frequency (MHz)	Measurement level (dBm)	Limit(dBm)	Result
2412	-15.61	8	Pass
2437	-14.26		
2462	-14.62		

PSD NVNT 802.11b 2412MHz Ant1

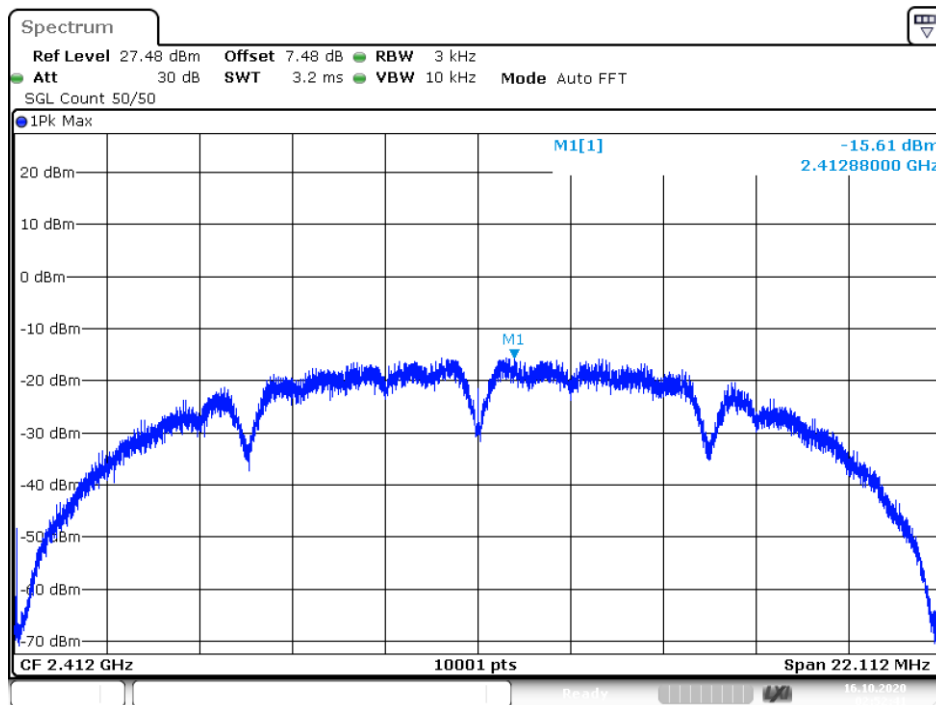

Date: 16.OCT.2020 02:52:40

PSD NVNT 802.11b 2437MHz Ant1

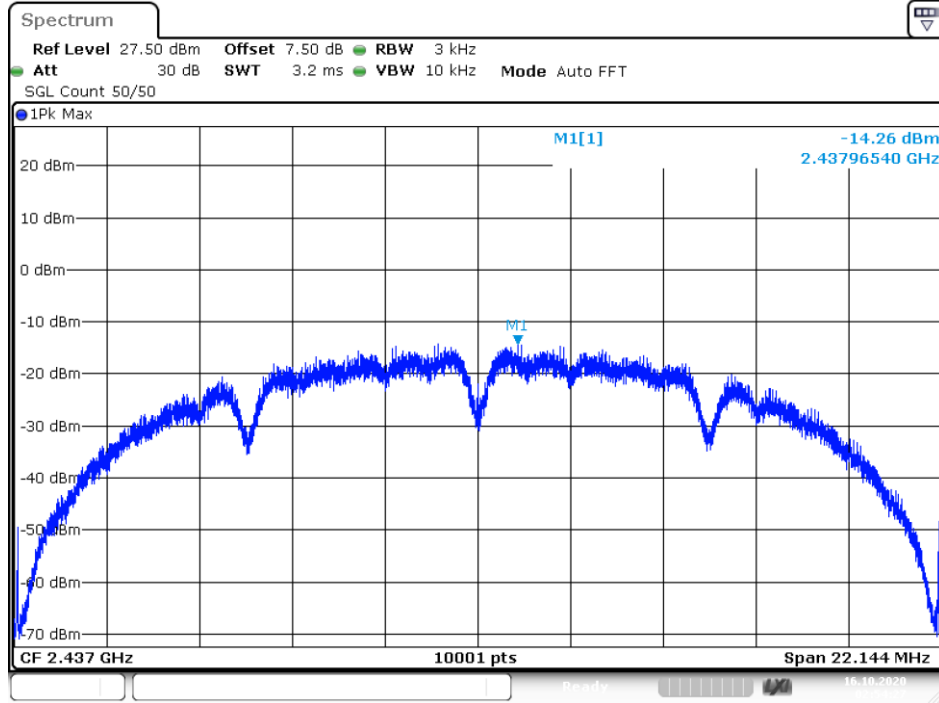

PSD NVNT 802.11b 2462MHz Ant1

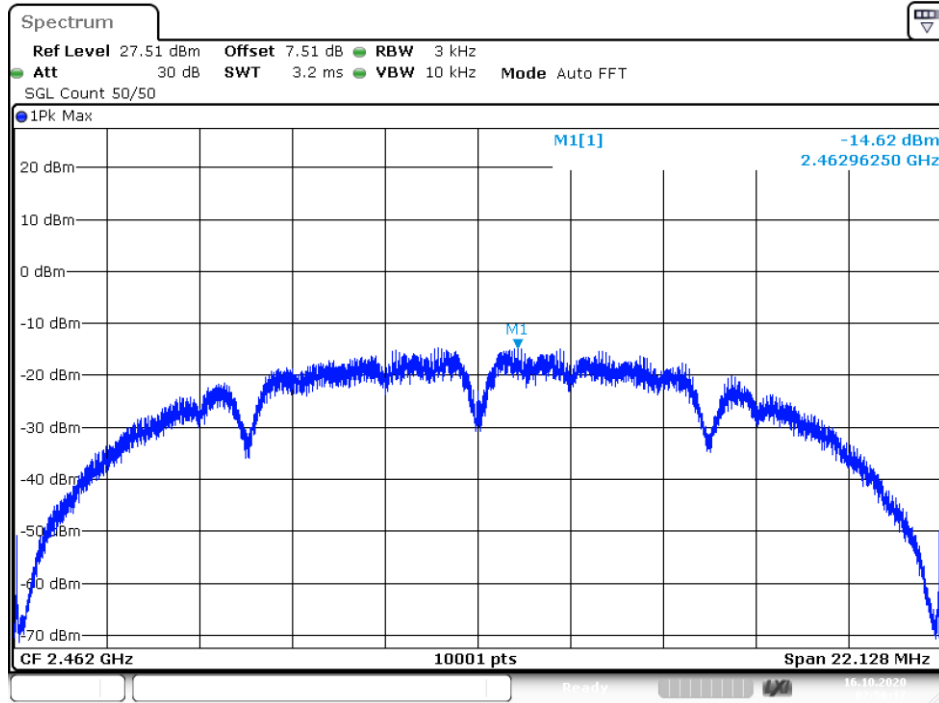

IEEE 802.11g			
Channel frequency (MHz)	Measurement level (dBm)	Limit(dBm)	Result
2412	-15.75	8	Pass
2437	-14.78		
2462	-14.63		

PSD NVNT 802.11g 2412MHz Ant1

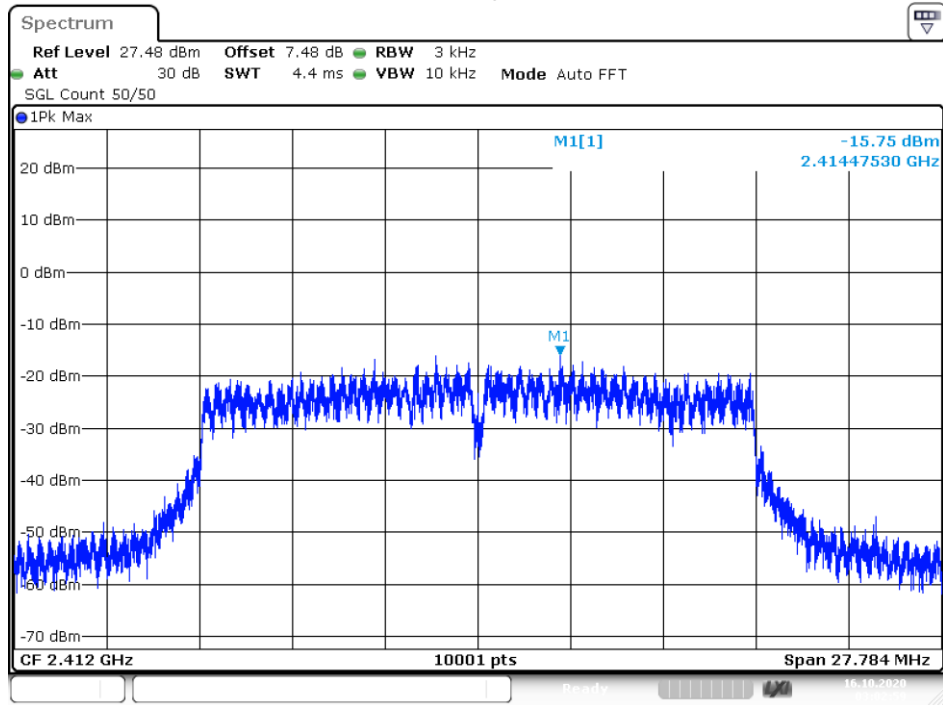

Date: 16.OCT.2020 03:02:58

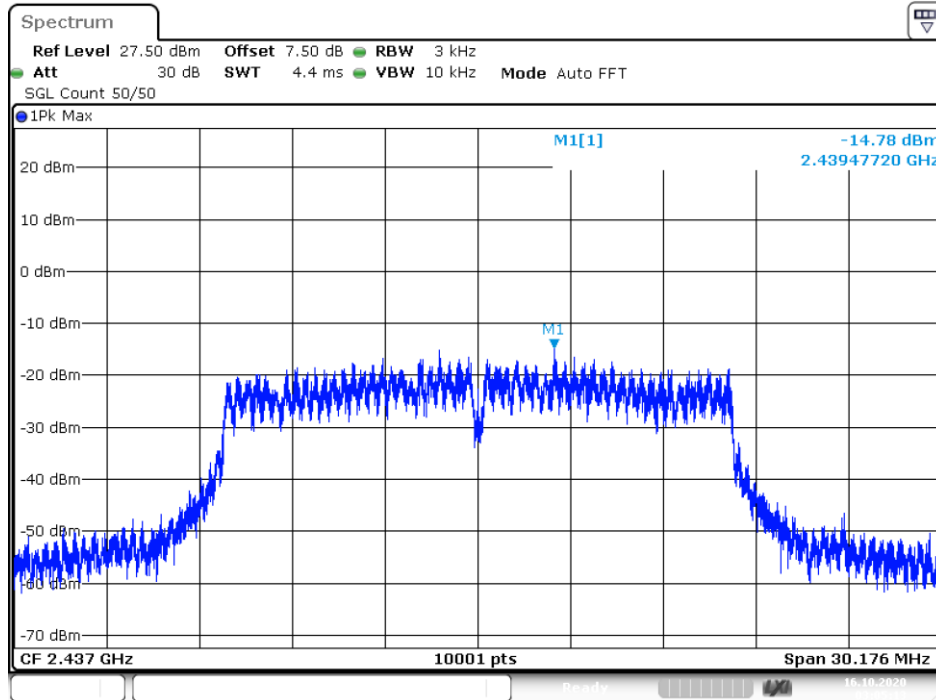

PSD NVNT 802.11g 2462MHz Ant1

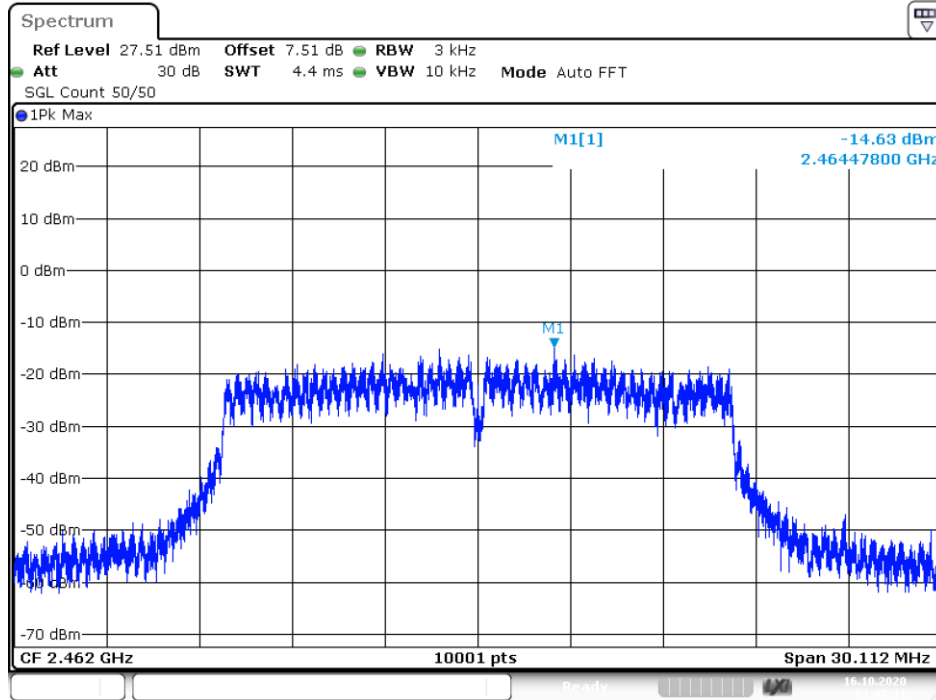

IEEE 802.11n(HT20)			
Channel frequency (MHz)	Measurement level (dBm)	Limit(dBm)	Result
2412	-17.05	8	Pass
2437	-16.33		
2462	-16.13		

PSD NVNT 802.11n(HT20) 2412MHz Ant1

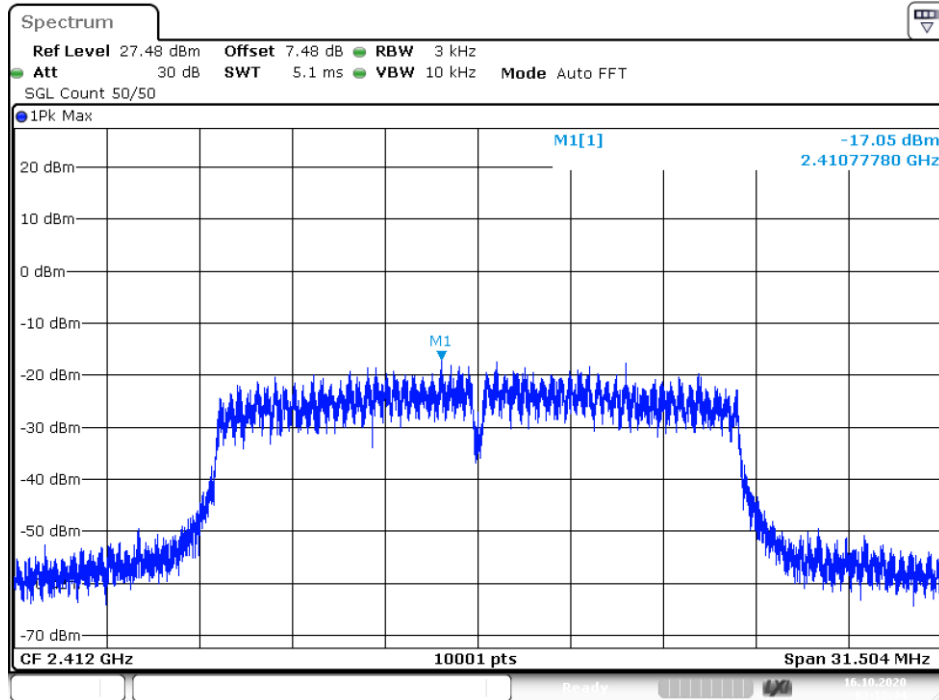

Date: 16.OCT.2020 03:12:44

PSD NVNT 802.11n(HT20) 2437MHz Ant1

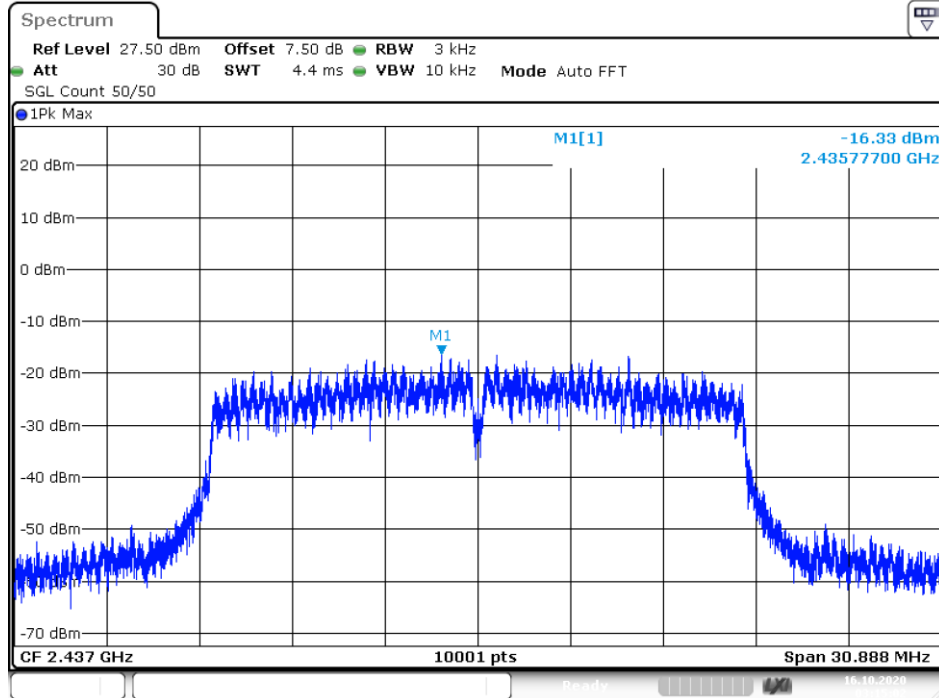

Date: 16.OCT.2020 03:15:02

PSD NVNT 802.11n(HT20) 2462MHz Ant1

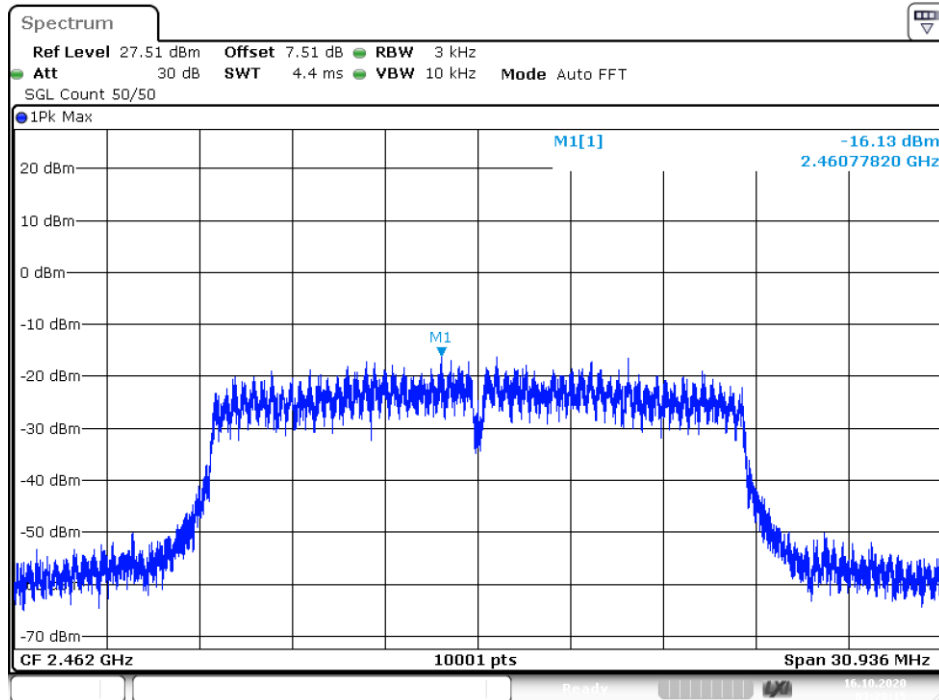

Date: 16.OCT.2020 03:28:15

IEEE 802.11n(HT40)			
Channel frequency (MHz)	Measurement level (dBm)	Limit(dBm)	Result
2422	-23.79	8	Pass
2437	-23.31		
2452	-22.53		

PSD NVNT 802.11n(HT40) 2422MHz Ant1

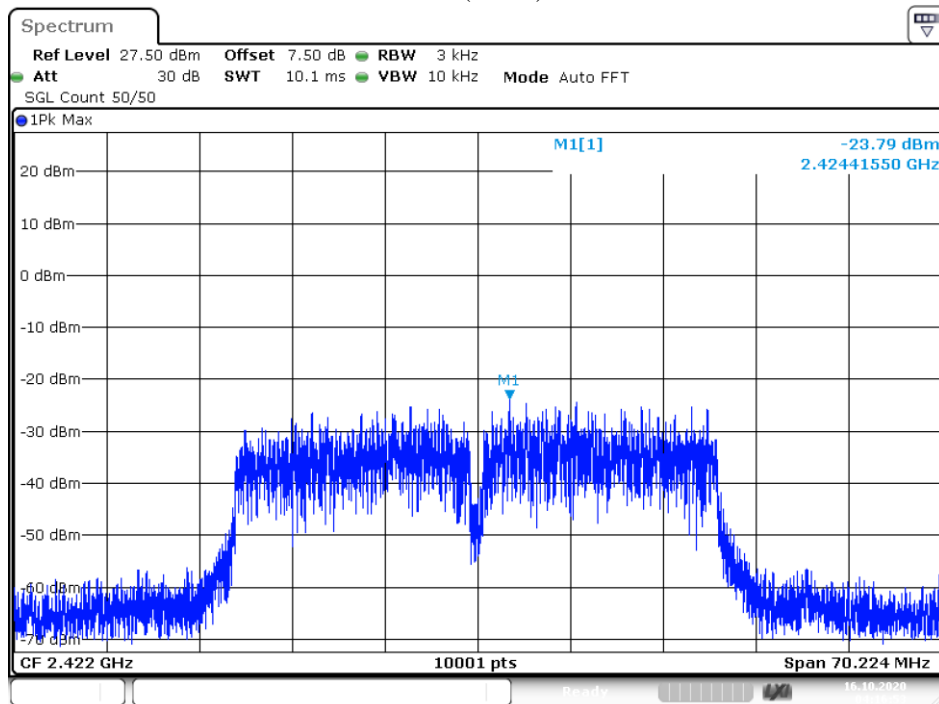

Date: 16.OCT.2020 04:16:53

PSD NVNT 802.11n(HT40) 2437MHz Ant1

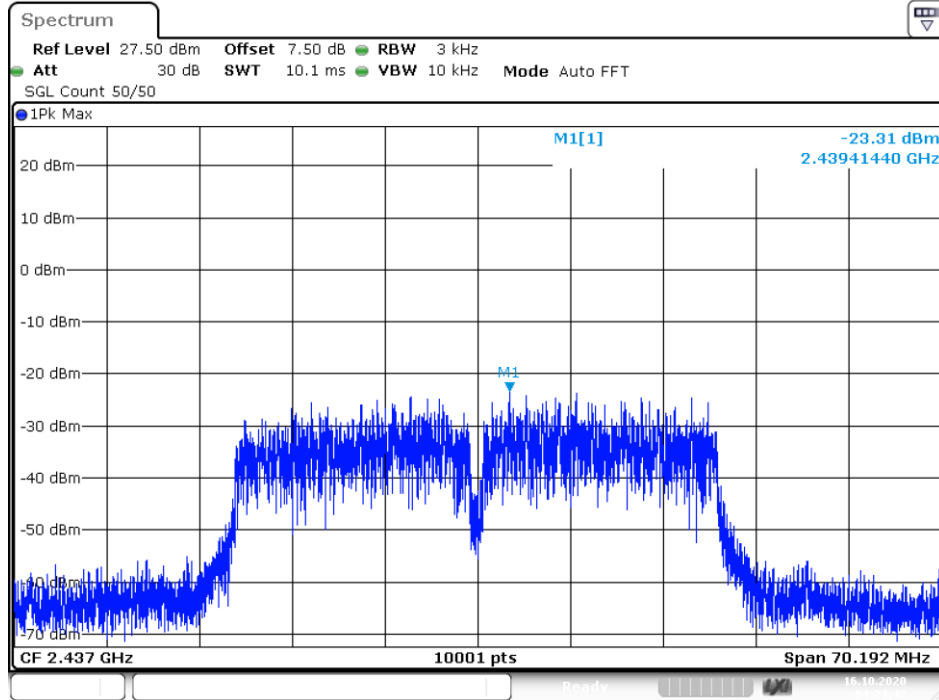

Date: 16.OCT.2020 04:23:42

PSD NVNT 802.11n(HT40) 2452MHz Ant1

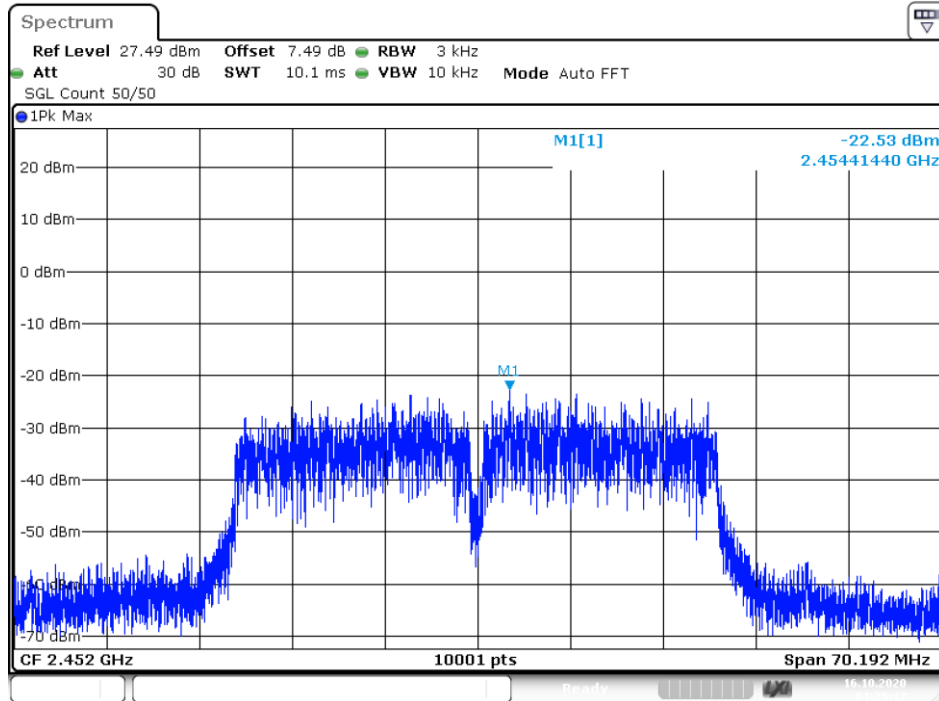

Date: 16.OCT.2020 04:25:12

12. Antenna Port Emission

12.1 Test Equipment

EQUIPMENT TYPE	MFR	MODEL NUMBER	SERIAL NUMBER	CALIBRATED UNTIL
Spectrum Analyzer	Rohde & Schwarz	FSV40	US40240623	2020-11-28
Coaxial Cable	Gigalink Microwave	ZT40	19022092	2020-11-28
Antenna Connector	ARTHUR-YANG	2244-N1TG1	N/A	2020-11-28

Remark: The temporary antenna connector is soldered on the PCB board in order to perform conducted tests and this temporary antenna connector is listed in the equipment list.

12.2 Measuring Instruments and Setting

The following table is the setting of spectrum analyzer.

Spectrum analyzer	Setting
Attenuation	Auto
RB	100kHz
VB	300kHz
Detector	Peak
Trace	Max hold

12.3 Test Procedures

The testing follows the Measurement Procedure of FCC KDB No. 558074 D01 15.247 Meas Guidance v05r02 .

The conducted spurious emissions were measured conducted using a spectrum analyzer at low, Middle, and high channels, the limit was determined by attenuation 20dB of the RF peak power output.

12.4 Block Diagram of Test setup

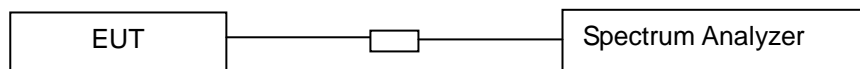

12.5 Test Result

PASS.

Please refer to following pages.



Tx. Spurious 802.11b 2412MHz Ant1 Emission

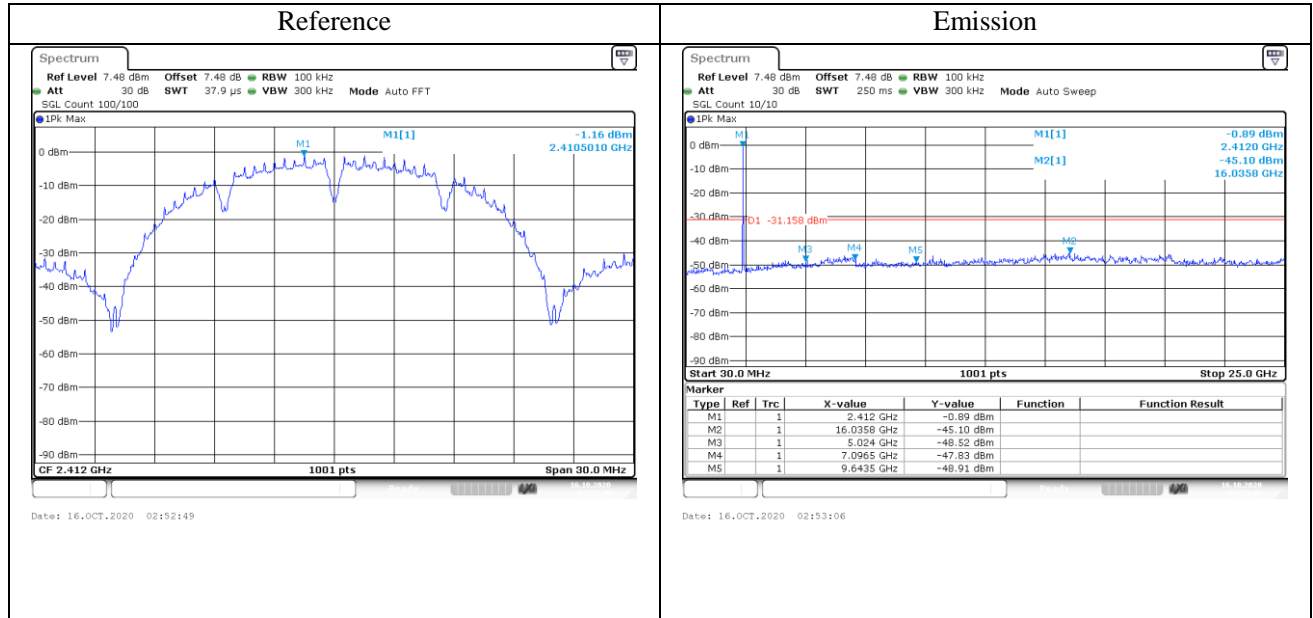

Tx. Spurious 802.11b 2437MHz Ant1 Emission

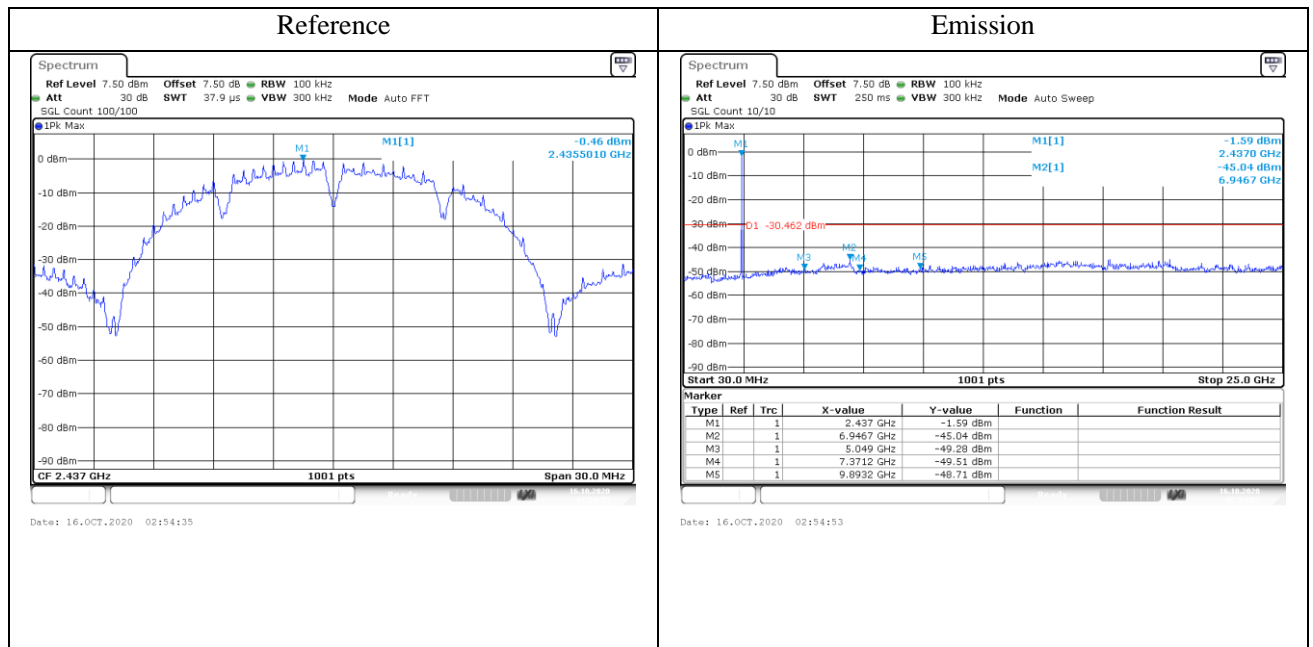



Tx. Spurious 802.11b 2462MHz Ant1 Emission

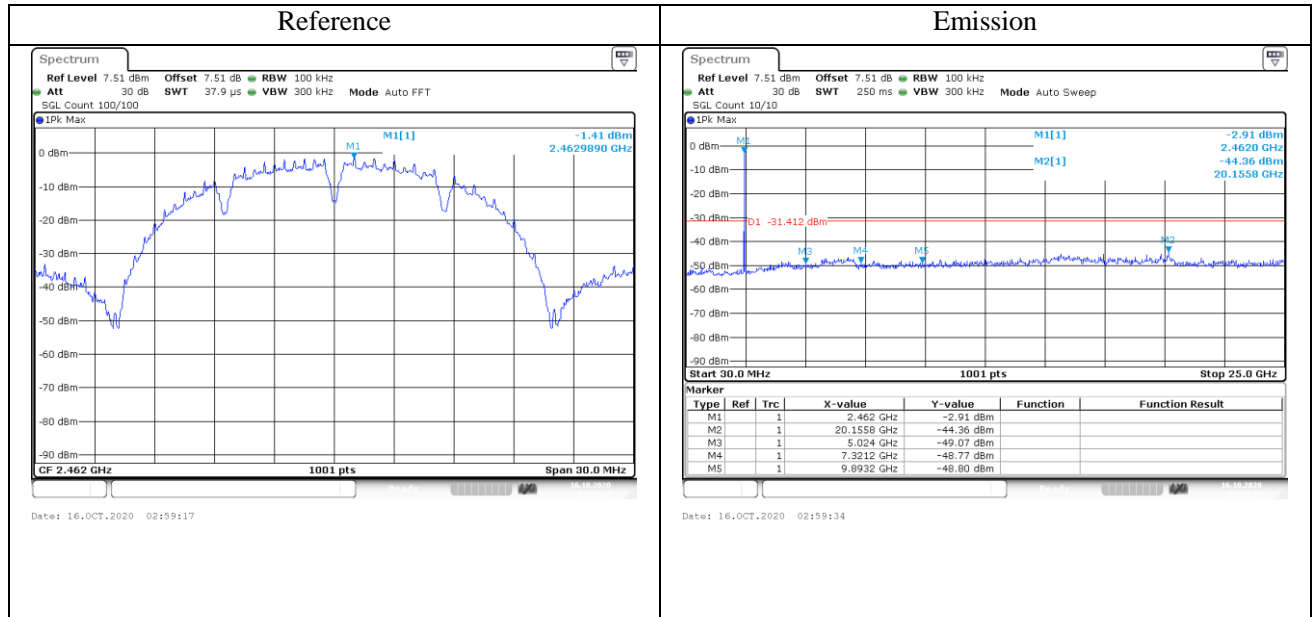

Tx. Spurious 802.11g 2412MHz Ant1 Emission

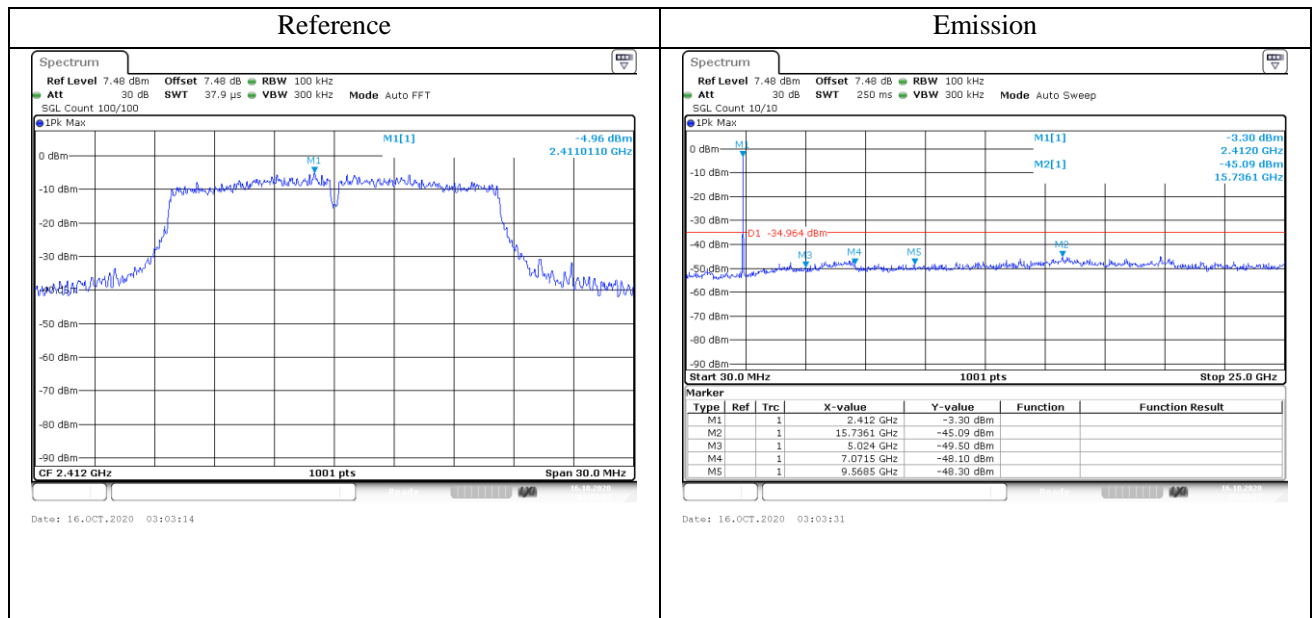

Tx. Spurious 802.11g 2437MHz Ant1 Emission

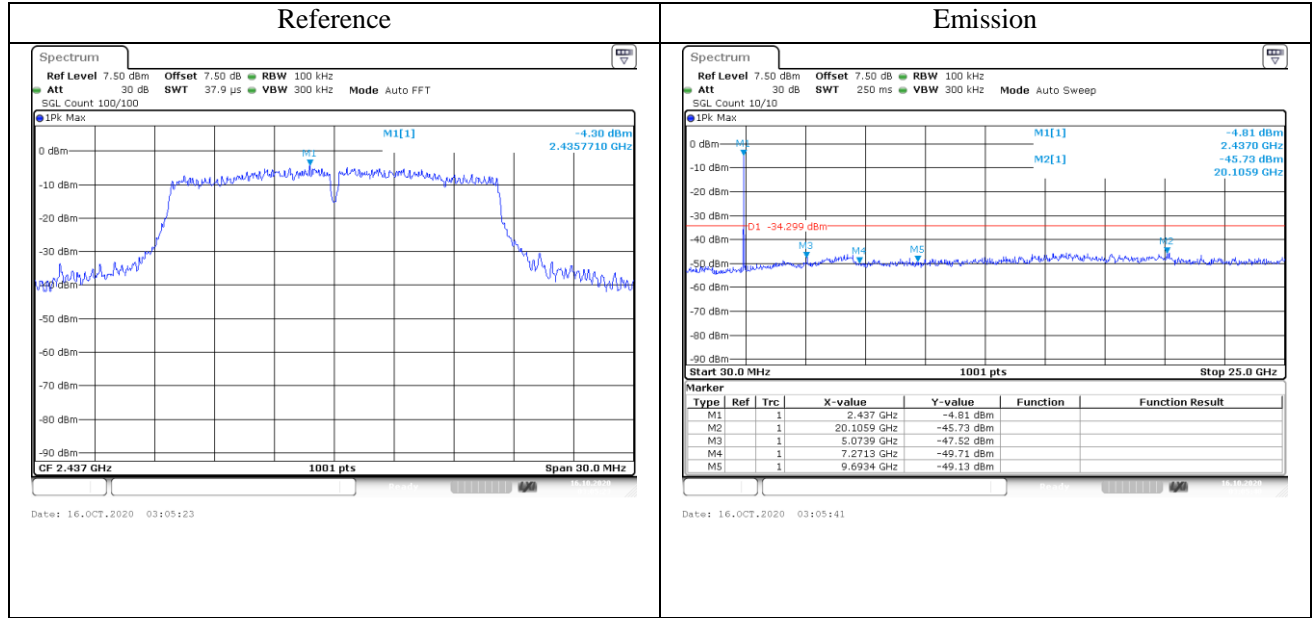

Tx. Spurious 802.11g 2462MHz Ant1 Emission

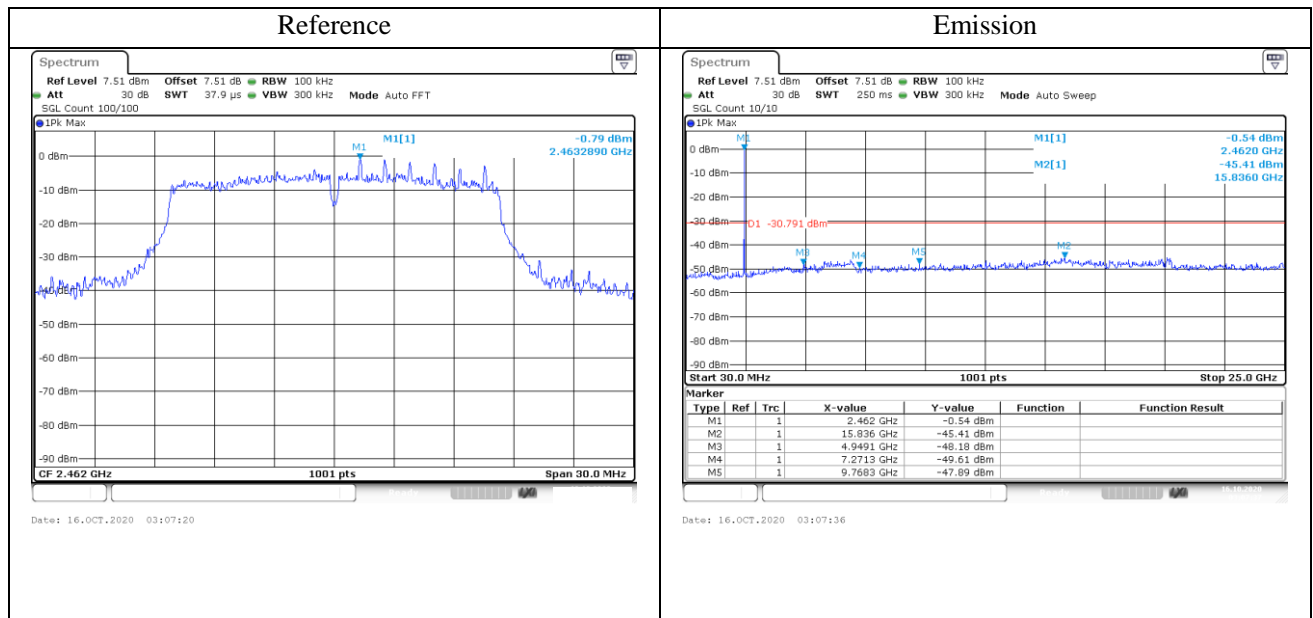



Tx. Spurious 802.11n(HT20) 2412MHz Ant1 Emission

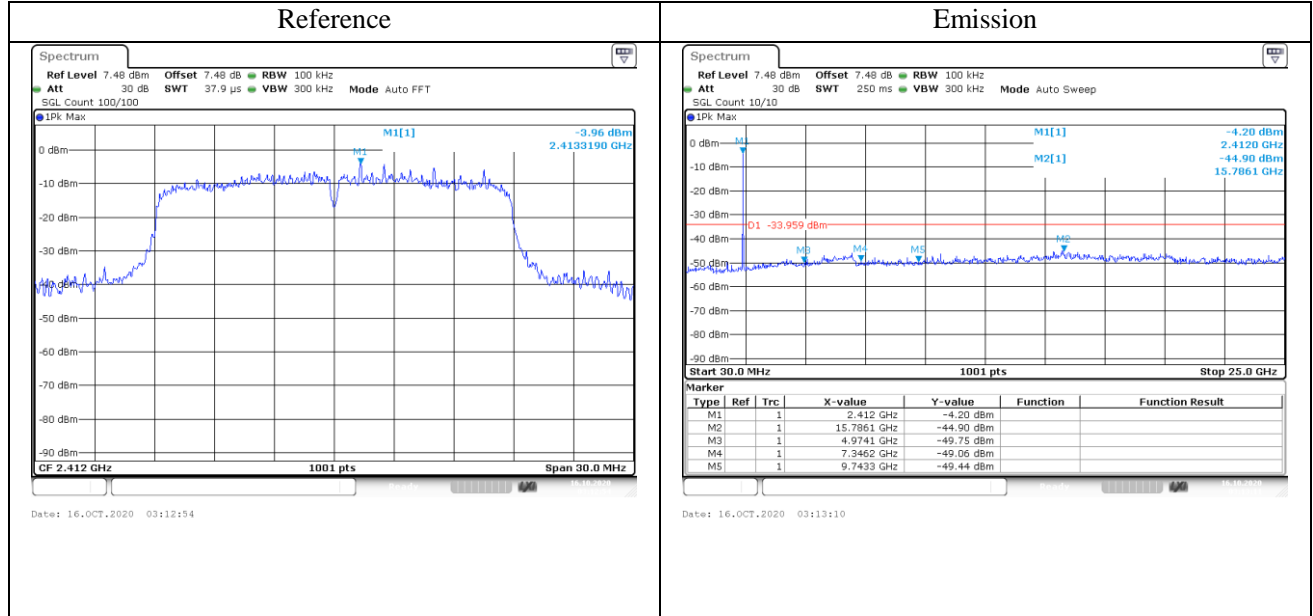

Tx. Spurious 802.11n(HT20) 2437MHz Ant1 Emission

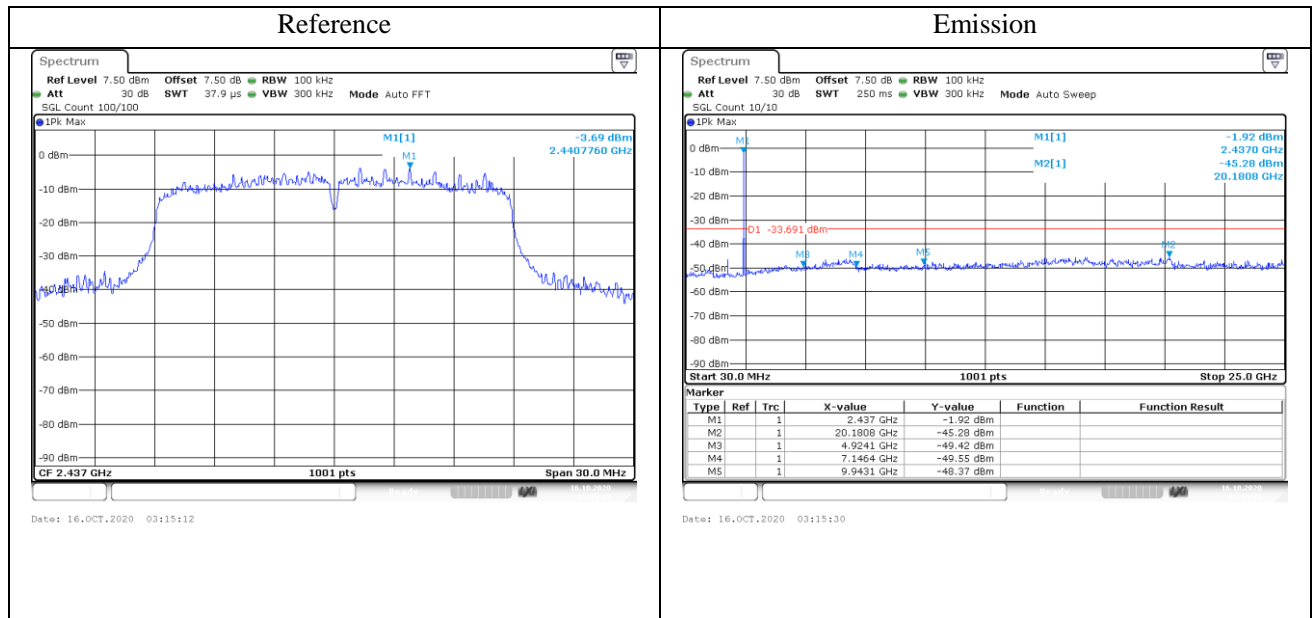

Tx. Spurious 802.11n(HT20) 2462MHz Ant1 Emission

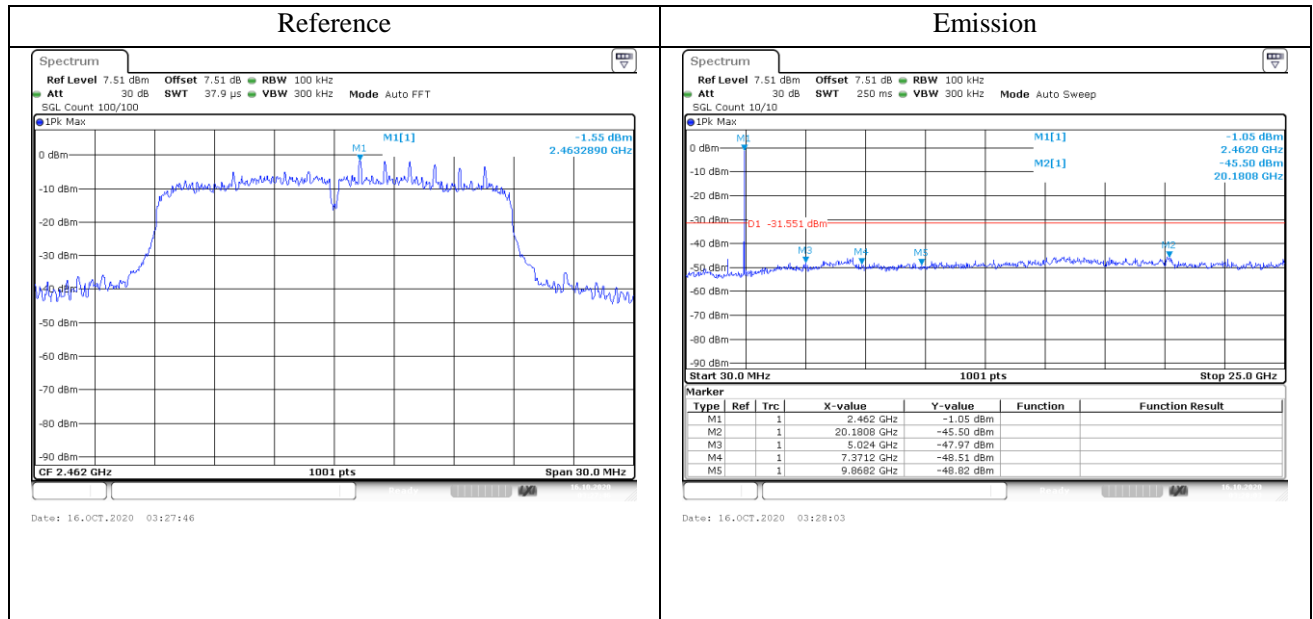

Tx. Spurious 802.11n(HT40) 2422MHz Ant1 Emission

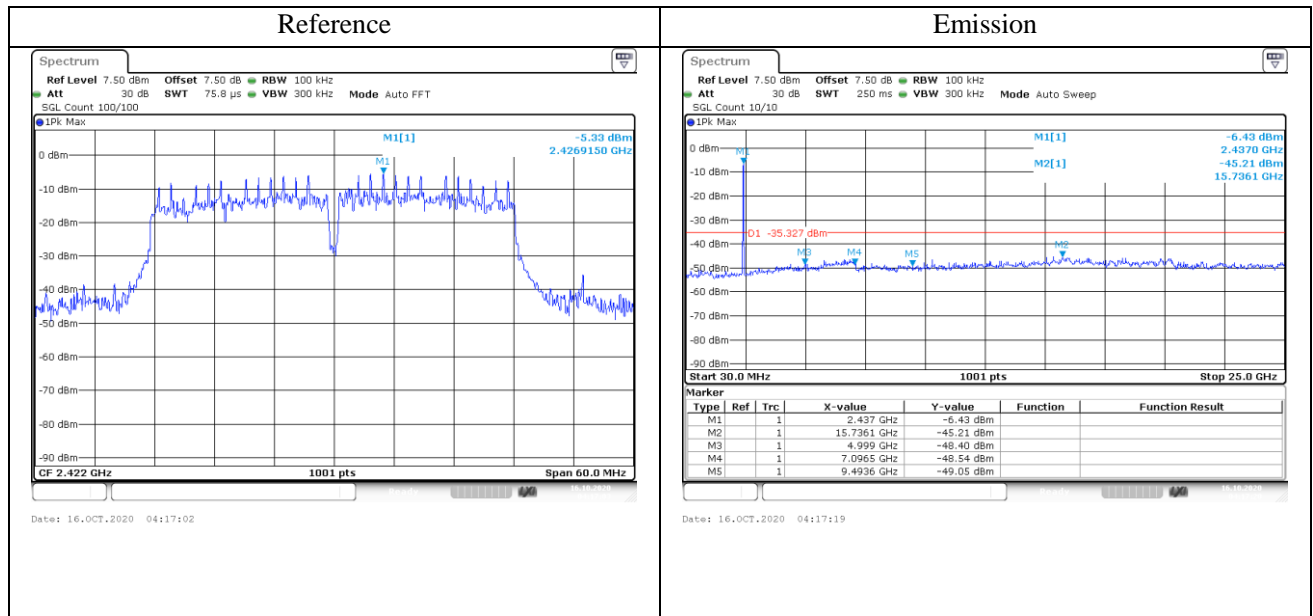

Tx. Spurious 802.11n(HT40) 2437MHz Ant1 Emission

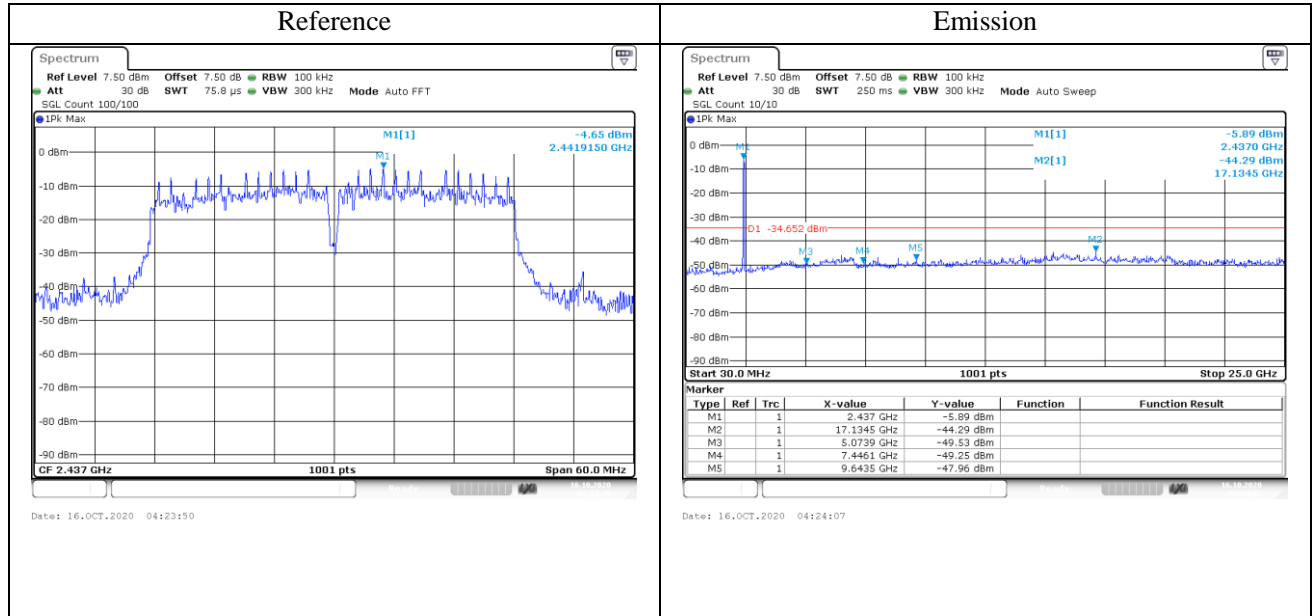

Tx. Spurious 802.11n(HT40) 2452MHz Ant1 Emission

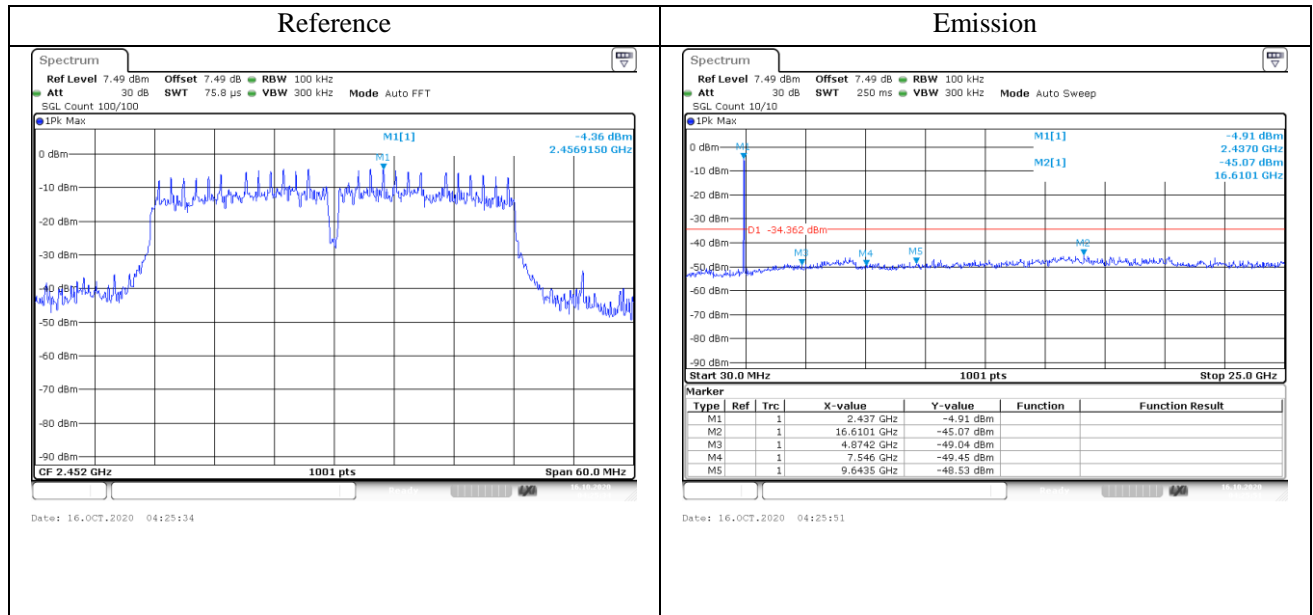



13. Antenna Application

13.1 Antenna Requirement

For intentional device, according to FCC 47 CFR Section 15.203, an intentional radiator shall be designed to ensure that no antenna other than that furnished by the responsible party shall be used with the device. And according to FCC 47 CFR Section 15.247 (b), if transmitting antennas of directional gain greater than 6dBi are used, the power shall be reduced by the amount in dB that the directional gain of the antenna exceeds 6dBi.

13.2 Result

The EUT's antenna is internal PCB antenna, using a permanently attached antenna which is not replaceable. The antenna's gain is -1dBi and meets the requirement.



APPENDIX I (Photos of EUT)



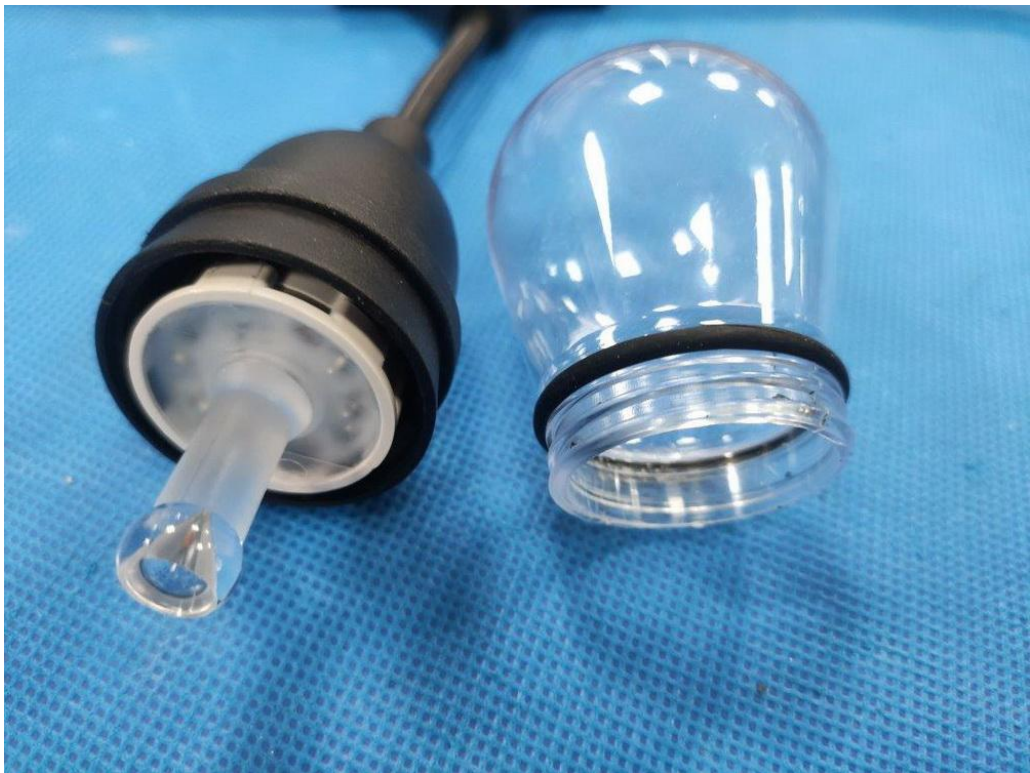

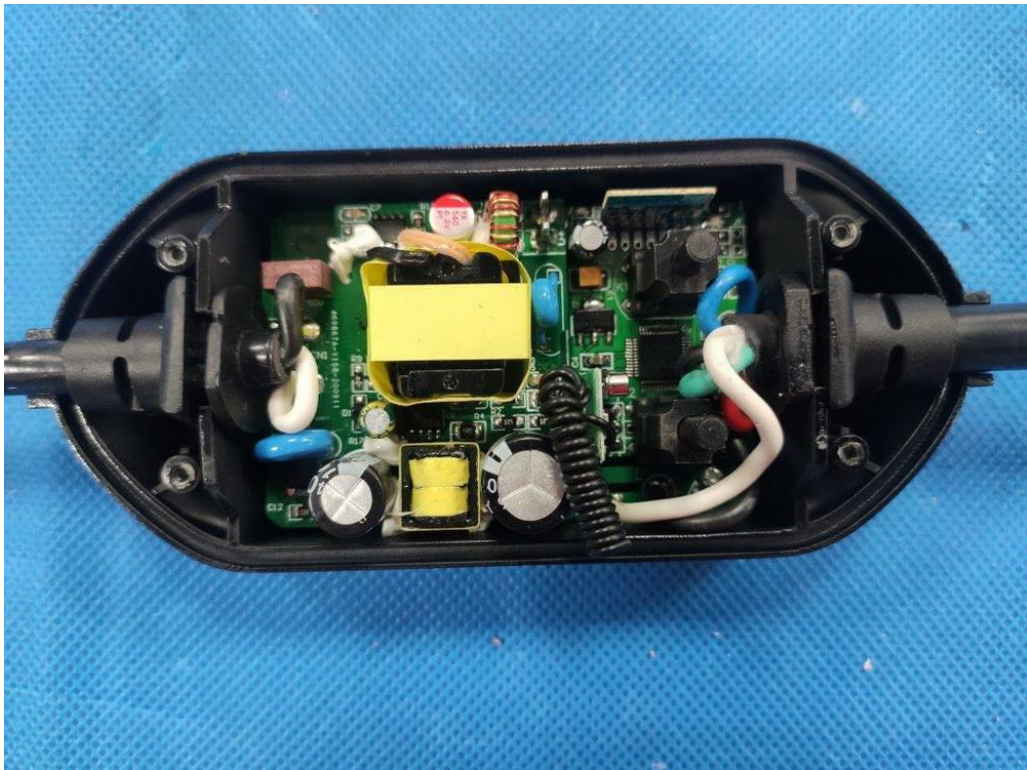

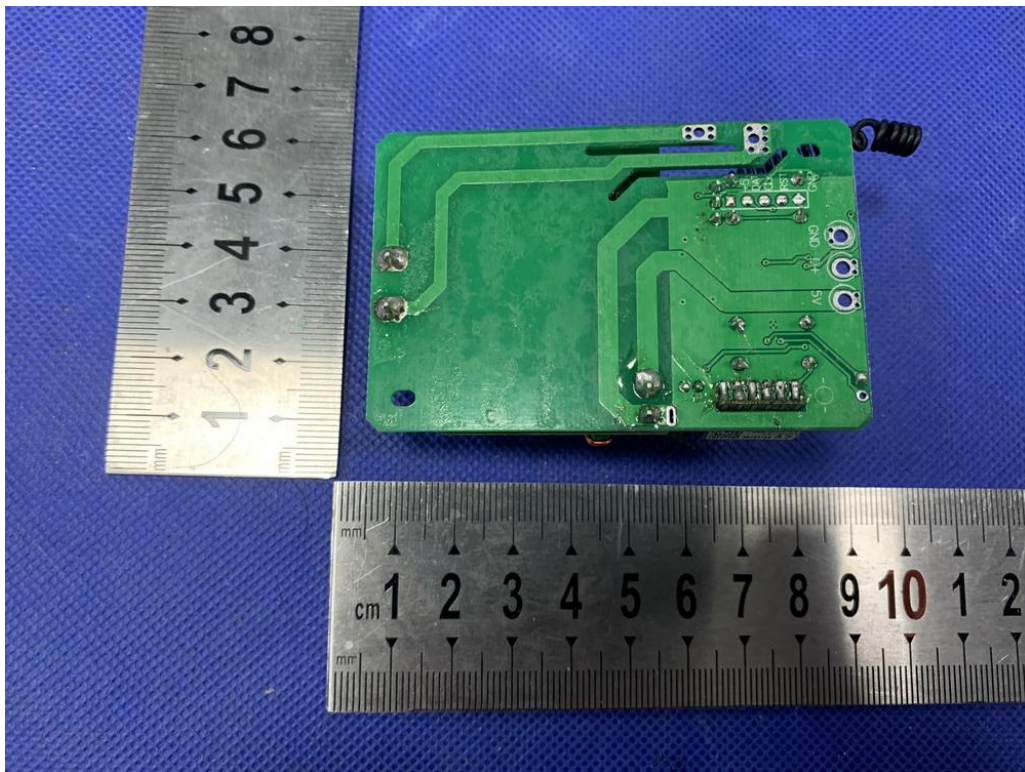
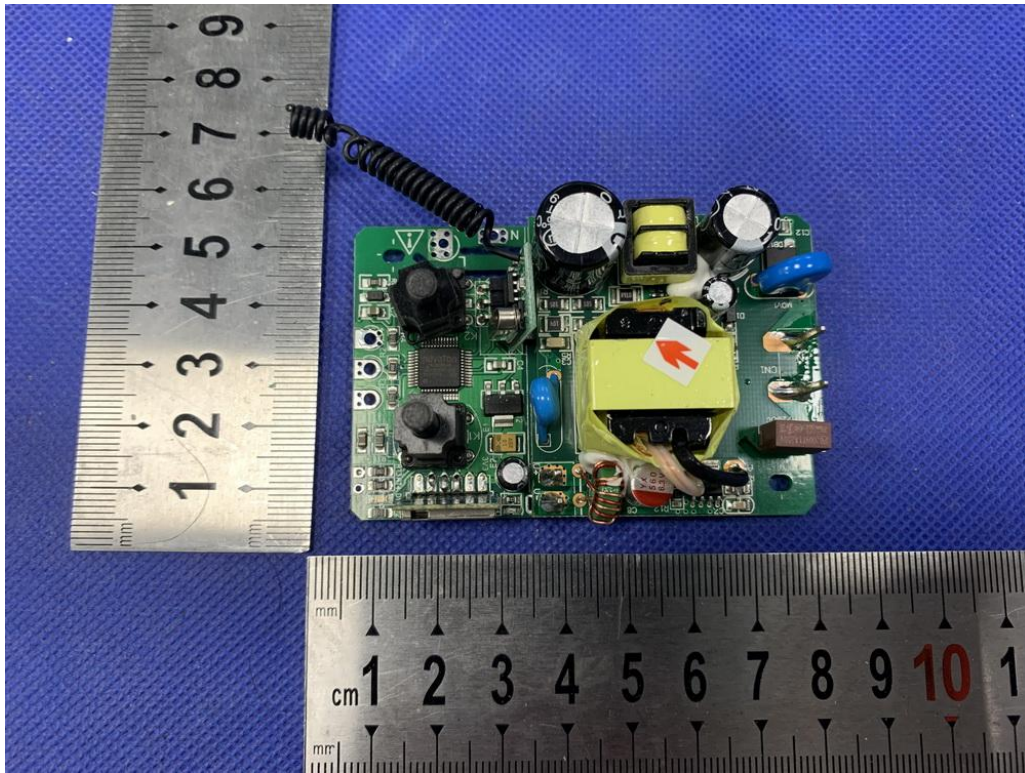

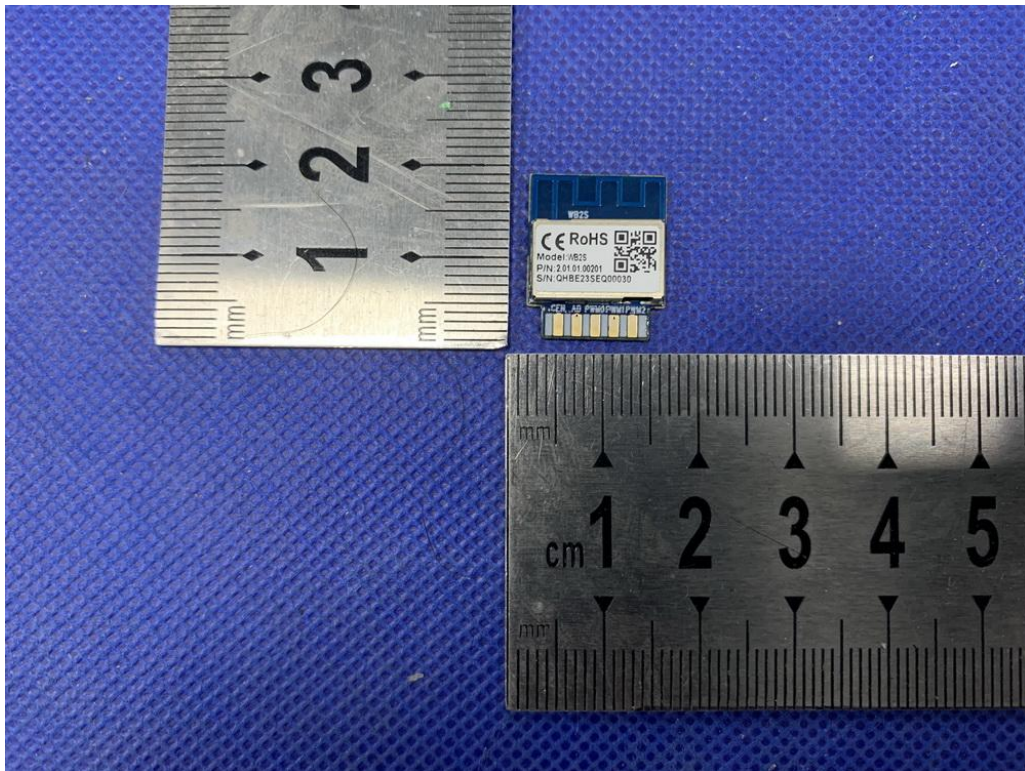
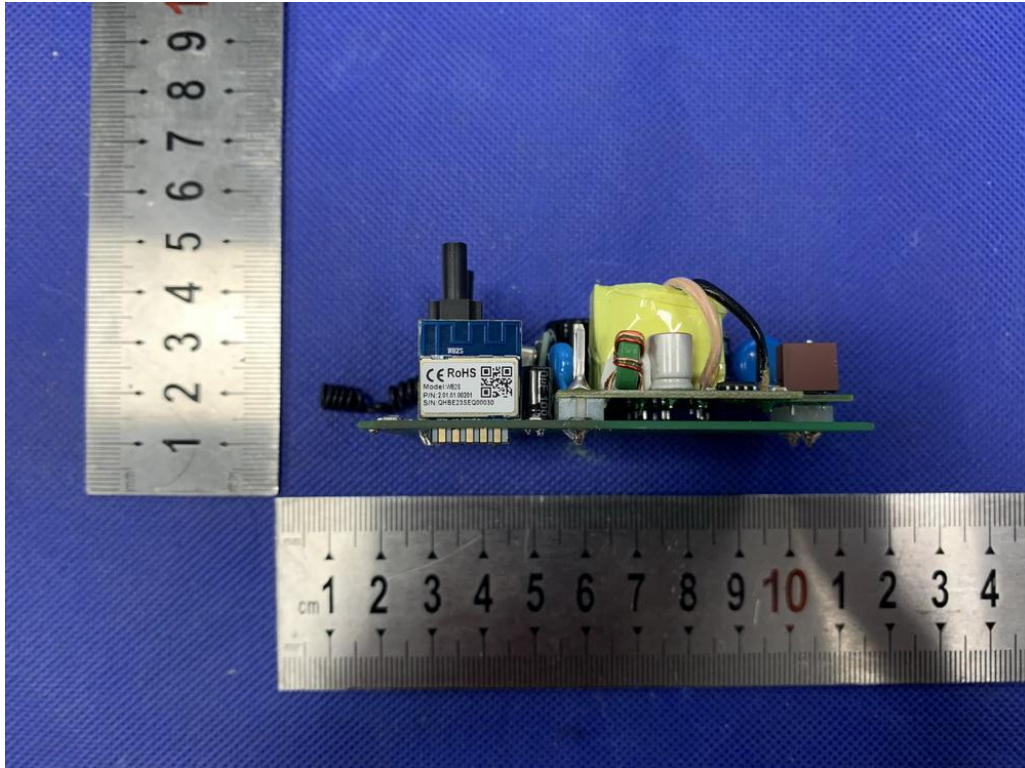

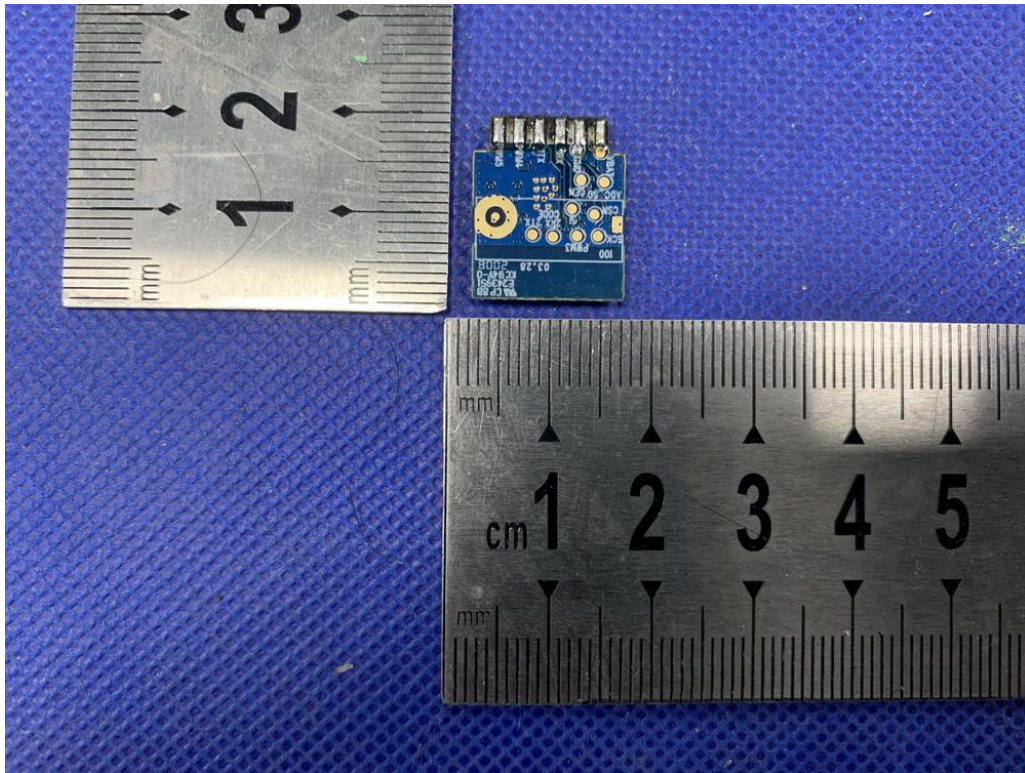

-----The end of report-----