



FCC PART 22H, PART 24E
TEST REPORT

For

Advanced Mobile Payment Inc.

Units 401-403, 15 Wertheim Court. Richmond Hill, Ontario L4B 3H7 Canada

FCC ID: 2AKJB-AMP9000

Report Type: Original Report	Product Type: AMP 9000
Report Number:	RSZ161123002-00C
Report Date:	2017-01-17
Reviewed By:	Manager Jesse Huang <i>Jesse Huang</i>
Prepared By:	Bay Area Compliance Laboratories Corp. (Kunshan) No.248 Chenghu Road, Kunshan, Jiangsu province, China Tel: +86-0512-86175000 Fax: +86-0512-88934268 www.baclcorp.com.cn

Note: This test report is prepared for the customer shown above and for the equipment described herein. It may not be duplicated or used in part without prior written consent from Bay Area Compliance Laboratories Corp.

TABLE OF CONTENTS

GENERAL INFORMATION.....	3
PRODUCT DESCRIPTION FOR EQUIPMENT UNDER TEST (EUT).....	3
OBJECTIVE.....	3
RELATED SUBMITTAL(S)/GRANT(S).....	3
TEST METHODOLOGY.....	3
MEASUREMENT UNCERTAINTY.....	4
TEST FACILITY.....	4
SYSTEM TEST CONFIGURATION.....	5
DESCRIPTION OF TEST CONFIGURATION.....	5
EQUIPMENT MODIFICATIONS.....	5
SUPPORT EQUIPMENT LIST AND DETAILS.....	5
BLOCK DIAGRAM OF TEST SETUP.....	5
SUMMARY OF TEST RESULTS.....	6
TEST EQUIPMENT LIST.....	7
FCC §1.1307 & §2.1093 - RF EXPOSURE.....	8
APPLICABLE STANDARD.....	8
TEST RESULT.....	8
FCC §2.1047 - MODULATION CHARACTERISTIC.....	9
FCC § 2.1046, § 22.913 (A) & § 24.232 (C) - RF OUTPUT POWER.....	10
APPLICABLE STANDARD.....	10
TEST PROCEDURE.....	10
TEST DATA.....	10
FCC §2.1049, §22.917, §22.905 & §24.238 - BANDWIDTH.....	14
APPLICABLE STANDARD.....	14
TEST PROCEDURE.....	14
TEST DATA.....	14
FCC §2.1051, §22.917(A) & §24.238(A) - SPURIOUS EMISSIONS AT ANTENNA TERMINALS.....	19
APPLICABLE STANDARD.....	19
TEST PROCEDURE.....	19
TEST DATA.....	19
FCC §2.1053, §22.917 & §24.238 - SPURIOUS RADIATED EMISSIONS.....	25
APPLICABLE STANDARD.....	25
TEST PROCEDURE.....	25
TEST DATA.....	25
FCC §22.917(A) & §24.238(A) - BAND EDGES.....	27
APPLICABLE STANDARD.....	27
TEST PROCEDURE.....	27
TEST DATA.....	27
FCC §2.1055, §22.355 & §24.235 - FREQUENCY STABILITY.....	34
APPLICABLE STANDARD.....	34
TEST PROCEDURE.....	34
TEST DATA.....	35

GENERAL INFORMATION

Product Description for Equipment under Test (EUT)

The *Advanced Mobile Payment Inc.*'s product, model number: *AMP 9000 (FCC ID: 2AKJB-AMP9000)* in this report is an *AMP 9000*, which was measured approximately: 140mm (L) * 80mm (W) *29mm (H), rated with input voltage: DC 3.7V battery or DC 5.0V from adapter.

Adapter Information:

Model: ADS-6MA-06 05050EPCU
Input: AC 100-240V, 50/60Hz, 0.3A
Output: DC 5.0V, 1.0A

** All measurement and test data in this report was gathered from production sample serial number: 1603740 (Assigned by BACL, Kunshan). The EUT supplied by the applicant was received on 2016-11-23.*

Objective

This test report is prepared on behalf of *Advanced Mobile Payment Inc.* in accordance with Part 2-Subpart J, Part 22-Subpart H and Part 24-Subpart E of the Federal Communication Commissions rules.

The objective is to determine the compliance of the EUT with FCC rules for output power, modulation characteristic, occupied bandwidth, and spurious emission at antenna terminal, spurious radiated emission, frequency stability and band edge.

Related Submittal(s)/Grant(s)

FCC Part 15.247 DTS, FCC Part 15.225 DXX and Part 15B JBP submissions with FCC ID: 2AKJB-AMP9000.

Test Methodology

All tests and measurements indicated in this document were performed in accordance with the Code of Federal Regulations Title 47 Part 2-Subpart J as well as the following parts:

Part 22 Subpart H - Public Mobile Services
Part 24 Subpart E - Personal Communication Services

Applicable Standards: TIA/EIA 603-D, ANSI C63.4-2014.

All emissions measurement was performed at Bay Area Compliance Laboratories Corp. (Kunshan). The radiated testing was performed at an antenna-to-EUT distance of 3 meters.

Measurement Uncertainty

Item		Uncertainty
AC Power Lines Conducted Emissions		±3.26 dB
RF conducted test with spectrum		±0.9dB
RF Output Power with Power meter		±0.5dB
Radiated emission	30MHz~1GHz	±5.91dB
	Above 1G	±4.92dB
Occupied Bandwidth		±0.5kHz
Temperature		±1.0°C
Humidity		±6%

Test Facility

The test site used by Bay Area Compliance Laboratories Corp. (Kunshan) to collect test data is located on the No.248 Chenghu Road, Kunshan, Jiangsu province, China.

Test site at Bay Area Compliance Laboratories Corp. (Kunshan) has been fully described in reports submitted to the Federal Communication Commission (FCC). The details of these reports have been found to be in compliance with the requirements of Section 2.948 of the FCC Rules on November 06, 2014. The facility also complies with the radiated and AC line conducted test site criteria set forth in ANSI C63.4-2014.

The Federal Communications Commission has the reports on file and is listed under FCC Registration No.: 815570. The test site has been approved by the FCC for public use and is listed in the FCC Public Access Link (PAL) database.

SYSTEM TEST CONFIGURATION

Description of Test Configuration

The EUT was configured for testing according to TIA/EIA-603-D.

The final qualification test was performed with the EUT operating at normal mode.

Equipment Modifications

No modification was made to the EUT.

Support Equipment List and Details

Manufacturer	Description	Model	Serial Number
Rohde & Schwarz	Universal Radio Communication Tester	CMU200	110605

Block Diagram of Test Setup

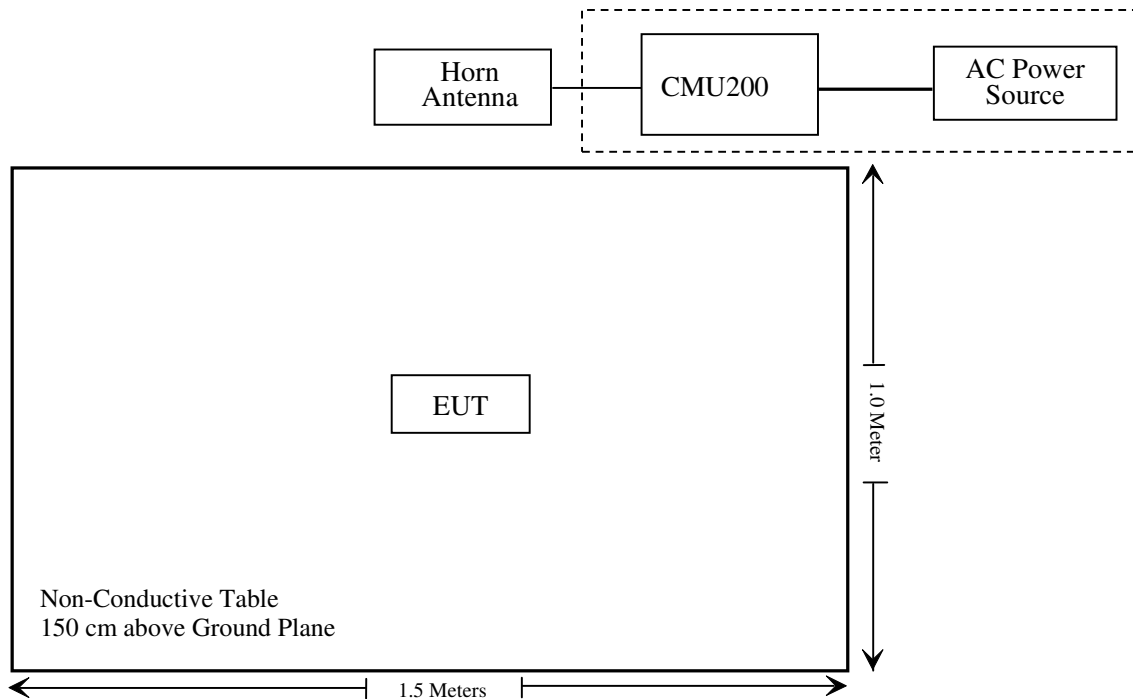

SUMMARY OF TEST RESULTS

FCC Rules	Description of Test	Result
§1.1307, §2.1093	RF Exposure (SAR)	Compliance*
§2.1046; § 22.913 (a); § 24.232 (c)	RF Output Power	Compliance
§ 2.1047	Modulation Characteristics	Not Applicable
§ 2.1049; § 22.905 § 22.917; § 24.238	Bandwidth	Compliance
§ 2.1051, § 22.917 (a); § 24.238 (a)	Spurious Emissions at Antenna Terminal	Compliance
§ 2.1053 § 22.917 (a); § 24.238 (a)	Field Strength of Spurious Radiation	Compliance
§ 22.917 (a); § 24.238 (a)	Out of band emission, Band Edge	Compliance
§ 2.1055 § 22.355; § 24.235	Frequency stability vs. temperature Frequency stability vs. voltage	Compliance

Note: * Please refer to SAR report released by BACL, report number: RSZ161123002-20.

TEST EQUIPMENT LIST

Manufacturer	Description	Model	Serial Number	Calibration Date	Calibration Due Date
Radiated Emission Test					
Sonoma Instrument	Amplifier	330	171377	2016-10-21	2017-10-21
Rohde & Schwarz	EMI Test Receiver	ESCI	100195	2016-11-25	2017-11-25
Sunol Sciences	Broadband Antenna	JB3	A090314-2	2016-01-09	2019-01-08
Sunol Sciences	Broadband Antenna	JB3	A090314-1	2016-01-09	2019-01-08
Narda	Pre-amplifier	AFS42-00101800	2001270	2016-09-08	2017-09-08
EMCO	Horn Antenna	3116	9510-2384	2015-11-07	2018-11-06
Rohde & Schwarz	Signal Analyzer	FSIQ26	100048	2016-11-25	2017-11-25
ETS	Horn Antenna	3115	6229	2016-01-11	2017-01-10
ETS	Horn Antenna	3115	9311-4159	2016-01-11	2017-01-10
R&S	Auto test Software	EMC32	V 09.10.0	NCR	NCR
haojintech	Coaxial Cable	Cable-1	001	2016-12-12	2017-12-12
haojintech	Coaxial Cable	Cable-2	002	2016-12-12	2017-12-12
haojintech	Coaxial Cable	Cable-3	003	2016-12-12	2017-12-12
MICRO-COAX	Coaxial Cable	Cable-4	004	2016-12-12	2017-12-12
MICRO-COAX	Coaxial Cable	Cable-5	005	2016-12-12	2017-12-12
MICRO-COAX	Coaxial Cable	Cable-7	007	2016-12-12	2017-12-12
HP	Signal Generator	8341B	2624A00116	2016-08-29	2017-08-29
RF Conducted test					
BACL	TS 8997 Cable-01	T-KS-EMC086	T-KS-EMC086	2016-12-10	2017-12-09
BACL	RF cable	KS-LAB-012	KS-LAB-012	2015-12-16	2016-12-15
BACL	RF cable	KS-LAB-012	KS-LAB-012	2016-12-15	2017-12-14
WEINSCHL	3dB Attenuator	5326	N/A	2016-06-18	2017-06-18
Rohde & Schwarz	OSP120 BASE UNIT	OSP120	101247	2016-07-04	2017-07-03
Rohde & Schwarz	Signal Analyzer	FSIQ26	836131/009	2016-09-21	2017-09-21
Rohde & Schwarz	Universal Radio Communication Tester	CMU200	110605	2016-11-25	2017-11-25
R&S	Wideband Radio Communication tester	CMW500	1201.002K50-116218-UY	2016-10-08	2017-10-08
HONOVA	Power Splitter	ZFRSC-14-S+	019411452	2016-06-12	2017-06-12
WEINSCHL	10dB Attenuator	5328	N/A	2016-06-18	2017-06-18

* **Statement of Traceability:** Bay Area Compliance Laboratories Corp. (Kunshan) attests that all calibrations have been performed in accordance to requirements that traceable to National Primary Standards and International System of Units (SI).

FCC §1.1307 & §2.1093 - RF EXPOSURE

Applicable Standard

FCC§1.1310 and §2.1093.

Test Result

Compliance, please refer to the SAR report: RSZ161123002-20.

FCC §2.1047 - MODULATION CHARACTERISTIC

According to FCC § 2.1047(d), Part 22H & 24E there is no specific requirement for digital modulation, therefore modulation characteristic is not presented.

FCC § 2.1046, § 22.913 (a) & § 24.232 (c) - RF OUTPUT POWER

Applicable Standard

According to FCC §2.1046 and §22.913 (a), the ERP of mobile transmitters and auxiliary test transmitters must not exceed 7 watts.

According to FCC §2.1046 and §24.232 (C), mobile and portable stations are limited to 2 watts EIRP and the equipment must employ a means for limiting power to the minimum necessary for successful communications.

Test Procedure

Conducted method:

The RF output of the transmitter was connected to the wireless test set and the spectrum analyzer through sufficient attenuation.

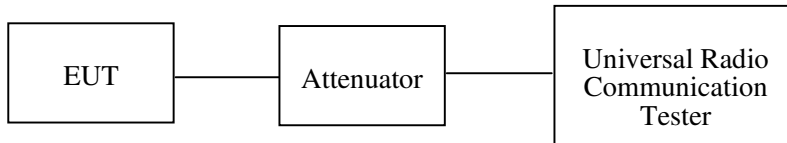

Radiated method:

TIA 603-D section 2.2.17

Test Data

Environmental Conditions

Temperature:	24.8 °C
Relative Humidity:	51 %
ATM Pressure:	101.0 kPa

The testing was performed by Poboo Li on 2016-12-15.

EUT operation mode: Transmitting

Conducted Power

Cellular Band (Part 22H)

Mode	Channel	Frequency (MHz)	Average Output Power (dBm)				Limit (dBm)
			1 slot	2 slots	3 slots	4 slots	
GPRS	128	824.2	33.52	31.44	30.13	29.06	38.45
	190	836.6	33.47	31.40	30.10	29.03	38.45
	251	848.8	33.37	31.31	29.95	28.93	38.45

Mode	Test Condition	Test Mode	3GPP Sub Test	Average Output Power (dBm)		
				Low Frequency	Middle Frequency	High Frequency
WCDMA (Band V)	Normal	RMC12.2k		22.58	22.56	22.59
		HSDPA	1	21.98	21.94	21.92
			2	21.02	21.02	20.98
			3	20.95	20.92	20.92
			4	20.92	20.83	20.82

PCS Band (Part 24E)

Mode	Channel	Frequency (MHz)	Average Output Power (dBm)				Limit (dBm)
			1 slot	2 slots	3 slots	4 slots	
GPRS	512	1850.2	29.20	27.18	26.27	25.30	33
	661	1880.0	29.38	27.33	26.40	25.41	33
	810	1909.8	29.36	27.37	26.43	25.47	33

Mode	Test Condition	Test Mode	3GPP Sub Test	Average Output Power (dBm)		
				Low Frequency	Middle Frequency	High Frequency
WCDMA (Band II)	Normal	RMC12.2k		21.99	22.04	22.11
		HSDPA	1	21.18	21.16	21.15
			2	21.21	21.25	21.14
			3	21.32	21.36	21.41
			4	21.14	21.21	21.12

Peak-to-average ratio (PAR)

Cellular Band

Mode	Channel	PAR (dB)	Limit (dB)
GPRS	Low	0.24	13
	Middle	0.31	13
	High	0.29	13

Mode	Channel	PAR (dB)	Limit (dB)
WCDMA (BPSK)	Low	2.98	13
	Middle	3.01	13
	High	3.31	13
HSDPA (16QAM)	Low	3.10	13
	Middle	3.01	13
	High	3.24	13

PCS Band

Mode	Channel	PAR (dB)	Limit (dB)
GPRS	Low	0.15	13
	Middle	0.13	13
	High	0.16	13

Mode	Channel	PAR (dB)	Limit (dB)
RMC (BPSK)	Low	2.42	13
	Middle	2.51	13
	High	2.27	13
HSDPA (16QAM)	Low	2.35	13
	Middle	2.55	13
	High	2.31	13

Radiated Power

GPRS Mode:

Frequency (MHz)	Receiver Reading (dBµV)	Turntable Angle Degree	Rx Antenna		Substituted			Absolute Level (dBm)	Limit (dBm)	Margin (dB)
			Height (m)	Polar (H/V)	S.G. Level (dBm)	Cable loss (dB)	Antenna Gain (dB)			
ERP for Cellular Band (Part 22H), Middle channel										
836.60	96.91	135	1.9	H	26.7	0.26	4.75	31.19	38.45	7.26
836.60	93.83	57	1.7	V	19.6	0.26	4.75	24.09	38.45	14.36
EIRP for PCS Band (Part 24E), Middle channel										
1880.00	80.88	112	1.8	H	19.4	0.45	8.84	27.79	33	5.21
1880.00	76.71	173	1.3	V	13.0	0.45	8.84	21.39	33	11.61

WCDMA Mode:

Frequency (MHz)	Receiver Reading (dBµV)	Turntable Angle Degree	Rx Antenna		Substituted			Absolute Level (dBm)	FCC Part 22H/24E	
			Height (m)	Polar (H/V)	S.G. Level (dBm)	Cable loss (dB)	Antenna Gain (dB)		Limit (dBm)	Margin (dB)
ERP for WCDMA Band V (Part 22H), Middle Channel										
836.60	86.82	153	2.1	H	16.6	0.26	4.75	21.09	38.45	17.36
836.60	79.84	353	1.5	V	5.6	0.26	4.75	10.09	38.45	28.36
EIRP for WCDMA Band II (Part 24E), Middle Channel										
1880.00	74.49	63	2.5	H	13.0	0.45	8.84	21.39	33	11.61
1880.00	70.92	88	2.2	V	7.2	0.45	8.84	15.59	33	17.41

Note:

All above data were tested with no amplifier.

Absolute Level = SG Level - Cable loss + Antenna Gain

Margin = Limit- Absolute Level

FCC §2.1049, §22.917, §22.905 & §24.238 - BANDWIDTH

Applicable Standard

FCC §2.1049, §22.917, §22.905 and §24.238.

Test Procedure

The RF output of the transmitter was connected to the simulator and the spectrum analyzer through sufficient attenuation.

The resolution bandwidth of the spectrum analyzer was set at 5 kHz (GSM) & 100 kHz (WCDMA) and the 26 dB & 99% bandwidth was recorded.

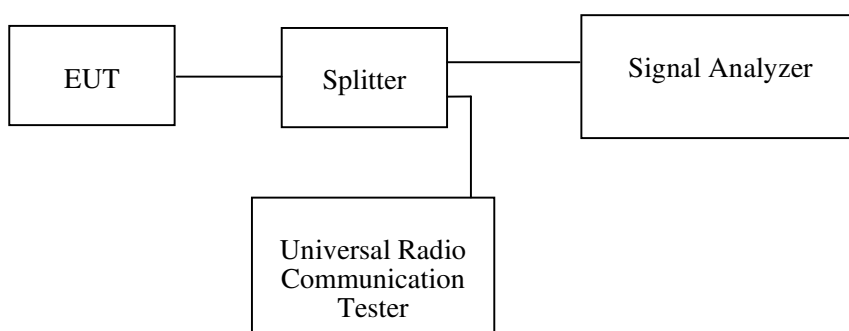

Test Data

Environmental Conditions

Temperature:	22~24.8 °C
Relative Humidity:	45~51 %
ATM Pressure:	100.0~101.0 kPa

The testing was performed by Poboo Li on 2016-12-15 and 2017-01-04.

EUT operation mode: Transmitting

Test Result: Compliance. Please refer to the following tables and plots.

Cellular Band (Part 22H)

Mode	Frequency (MHz)	99% Occupied Bandwidth (kHz)	26 dB Emission Bandwidth (kHz)
GPRS	836.6	244.5	316.6

Mode	Frequency (MHz)	99% Occupied Bandwidth (MHz)	26 dB Emission Bandwidth (MHz)
RMC (BPSK)	836.6	4.15	4.71
HSDPA (16QAM)	836.6	4.13	4.71

PCS Band (Part 24E)

Mode	Frequency (MHz)	99% Occupied Bandwidth (kHz)	26 dB Emission Bandwidth (kHz)
GPRS	1880.0	242.5	318.6

Mode	Frequency (MHz)	99% Occupied Bandwidth (MHz)	26 dB Emission Bandwidth (MHz)
RMC (BPSK)	1880.0	4.17	4.71
HSDPA (16QAM)	1880.0	4.15	4.69

Cellular Band (Part 22H)

26 dB Emissions & 99% Occupied Bandwidth for GPRS Mode

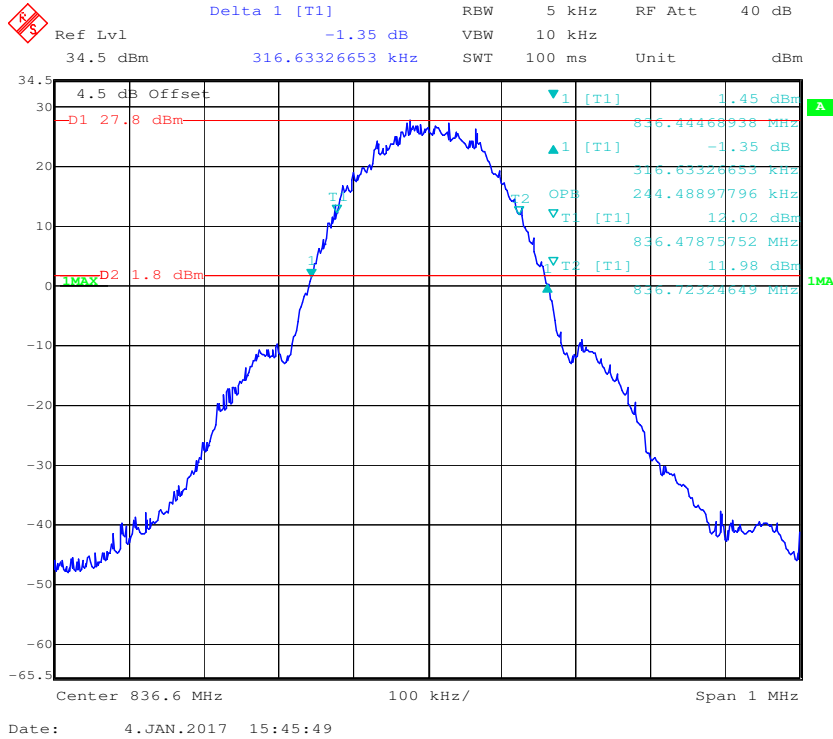

26 dB Emissions & 99% Occupied Bandwidth for RMC (BPSK) Mode

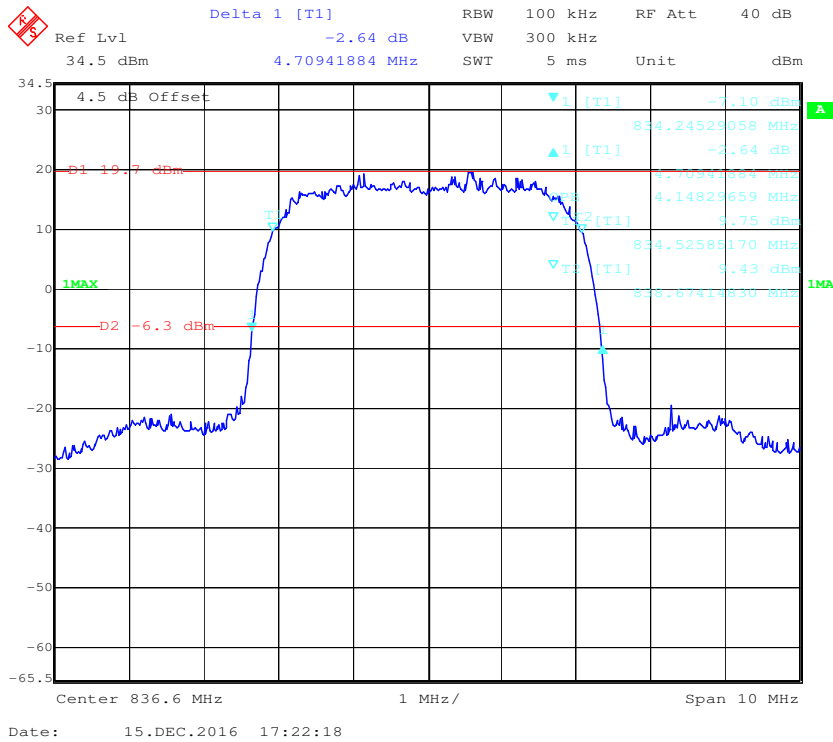

26 dB Emissions & 99% Occupied Bandwidth for HSDPA (16QAM) Mode

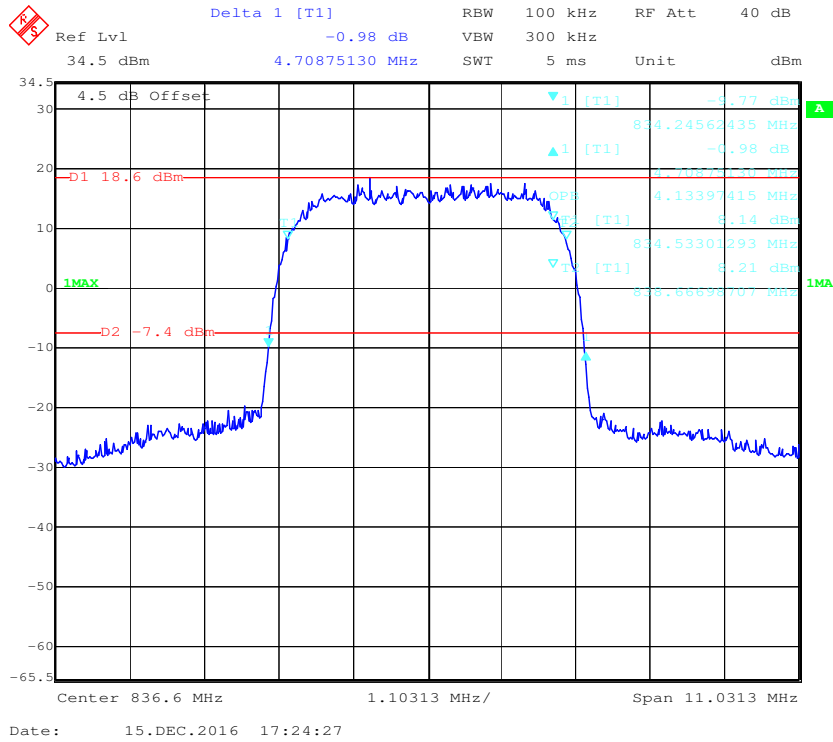

PCS Band (Part 24E)

26 dB Emissions & 99% Occupied Bandwidth for GPRS Mode

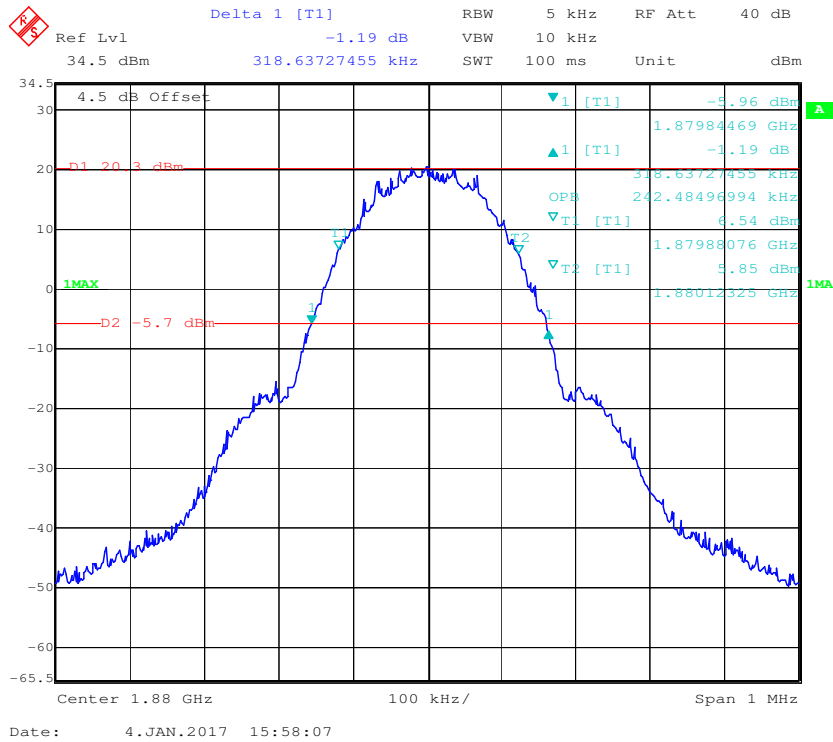

26 dB Emissions & 99% Occupied Bandwidth for RMC (BPSK) Mode

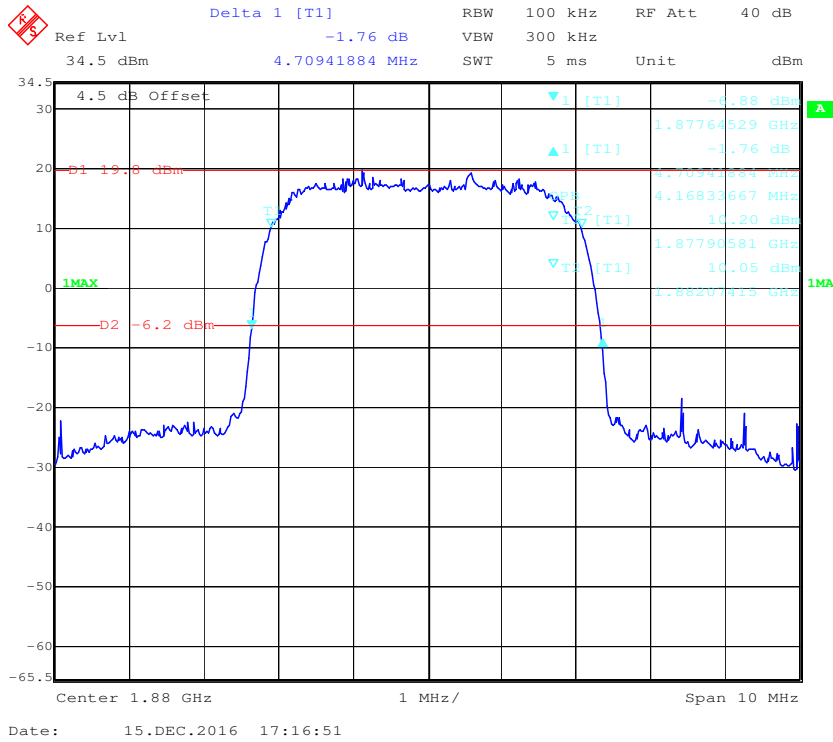

26 dB Emissions & 99% Occupied Bandwidth for HSDPA (16QAM) Mode

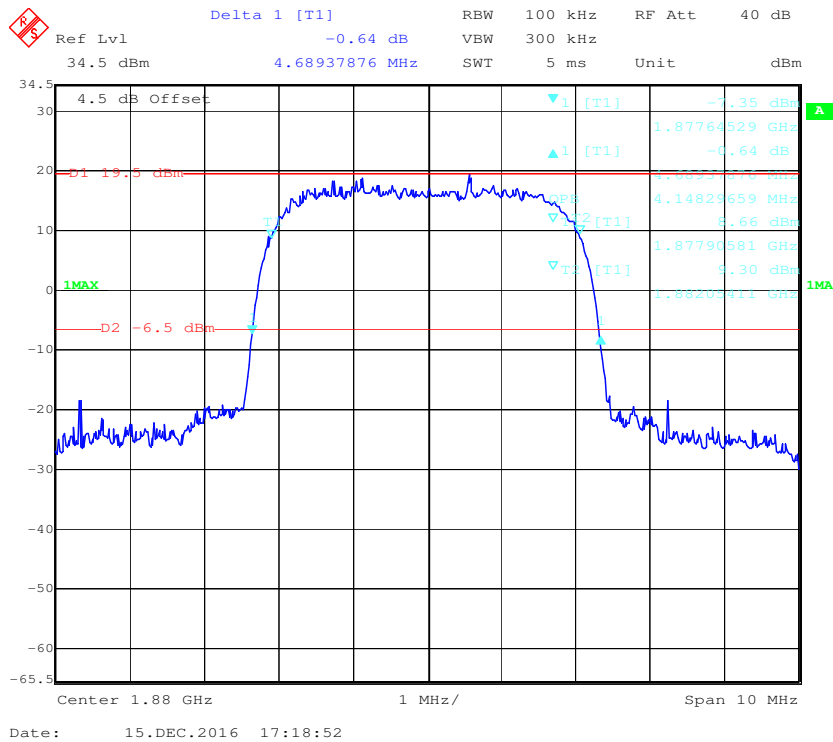

FCC §2.1051, §22.917(a) & §24.238(a) - SPURIOUS EMISSIONS AT ANTENNA TERMINALS

Applicable Standard

FCC §2.1051, §22.917(a) and §24.238(a).

The spectrum was to be investigated to the tenth harmonics of the highest fundamental frequency as specified in § 2.1051.

Test Procedure

The RF output of the transceiver was connected to a spectrum analyzer and simulator through appropriate attenuation. The resolution bandwidth of the spectrum analyzer was set at 1MHz. Sufficient scans were taken to show any out of band emissions up to 10th harmonic.

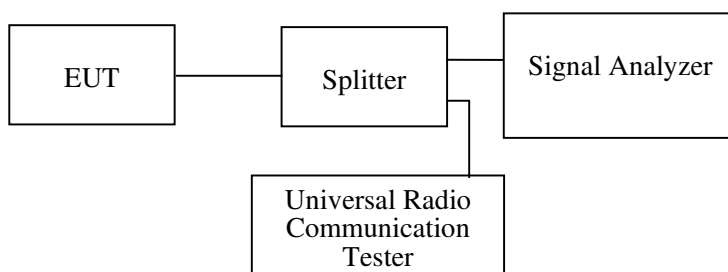

Test Data

Environmental Conditions

Temperature:	24.8 °C
Relative Humidity:	51 %
ATM Pressure:	101.0 kPa

The testing was performed by Poboo Li on 2016-12-15.

EUT operation mode: Transmitting

Test result: Compliance. Please refer to the following plots.

Cellular Band (Part 22H)

30 MHz – 1 GHz (GPRS Mode)

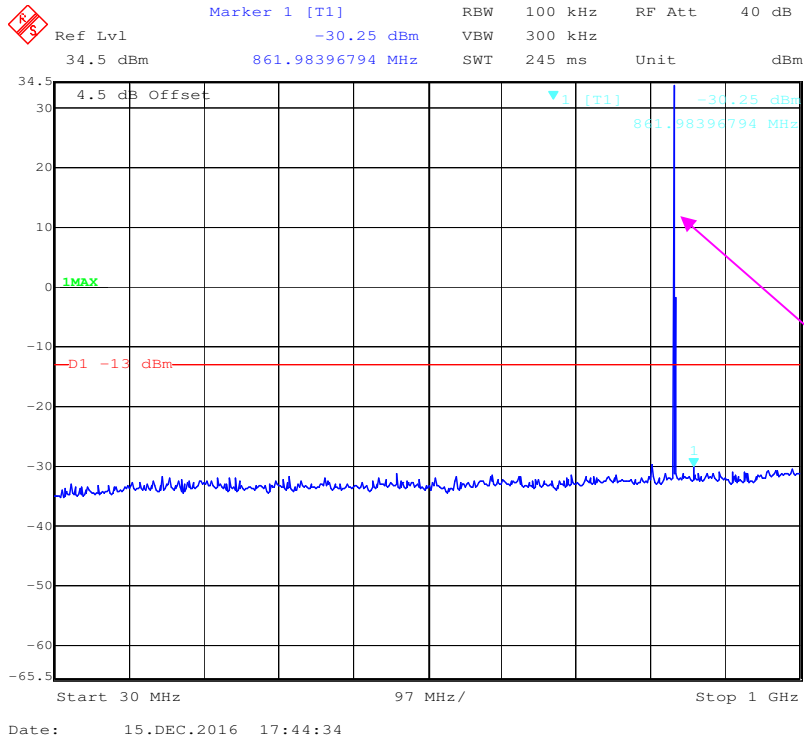

Fundamental test

1 GHz – 10 GHz (GPRS Mode)

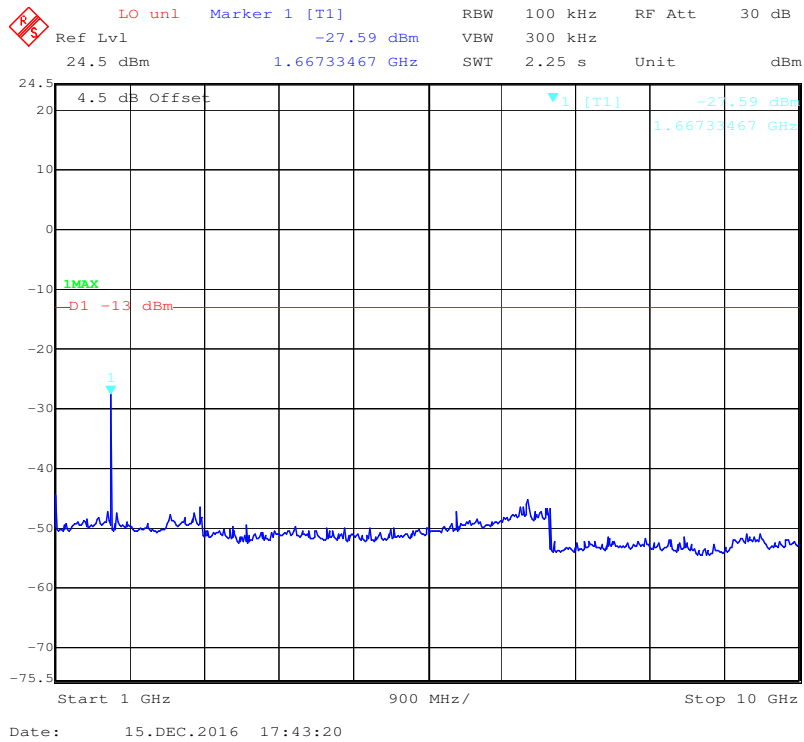

30 MHz – 1 GHz (WCDMA Mode)

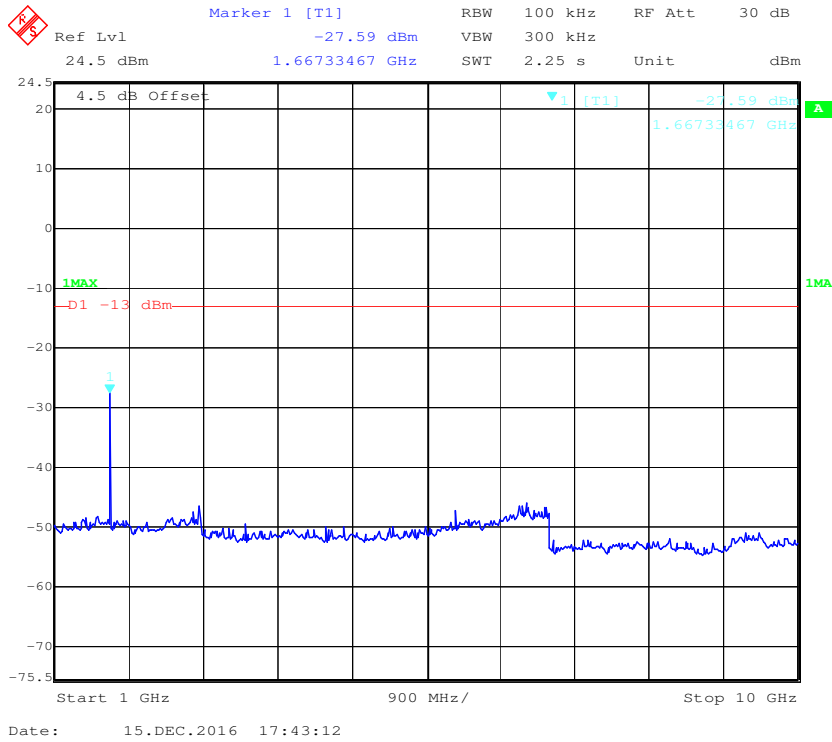

1 GHz – 10 GHz (WCDMA Mode)

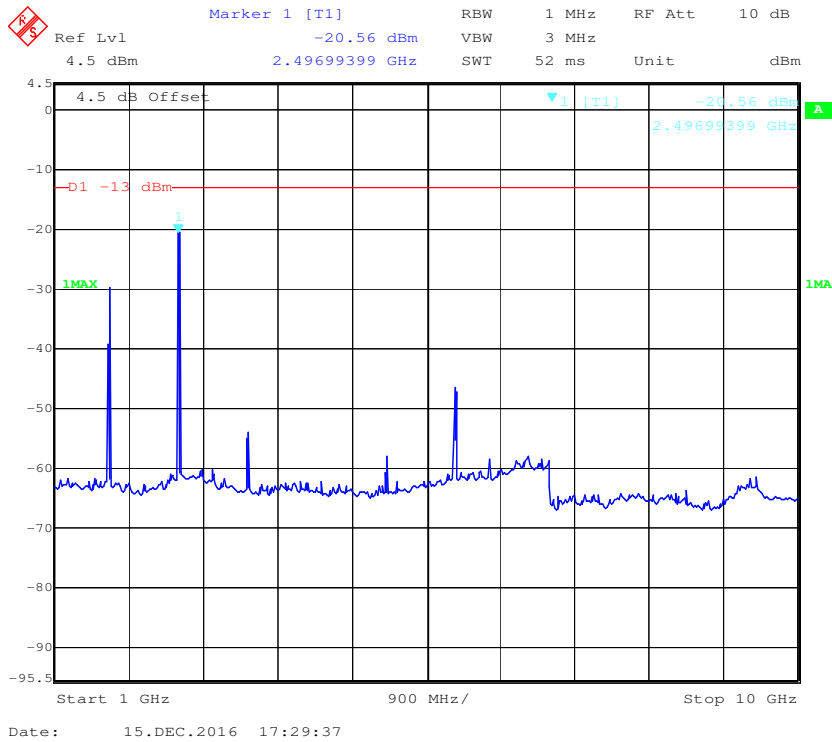

PCS Band (Part 24E)

30 MHz – 1 GHz (GPRS Mode)

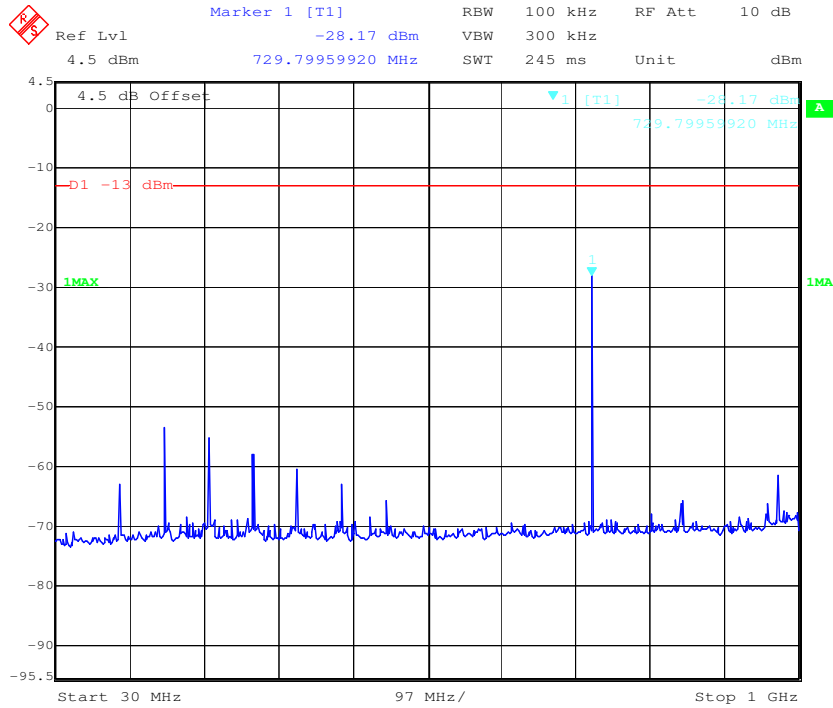

Date: 15.DEC.2016 18:31:42

1 GHz – 2 GHz (GPRS Mode)

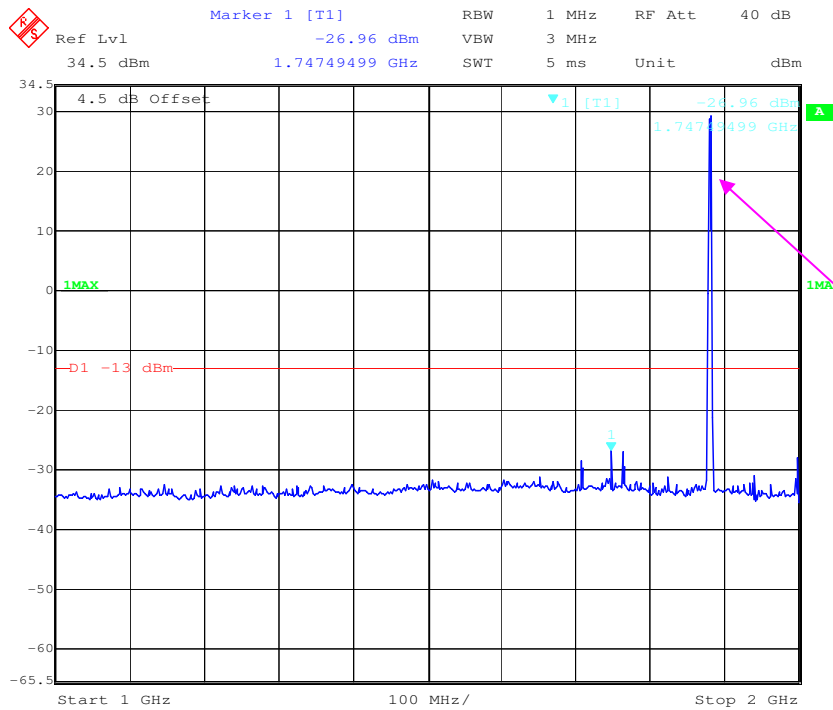

Date: 15.DEC.2016 18:27:48

Fundamental test

2 GHz – 20 GHz (GSM Mode)

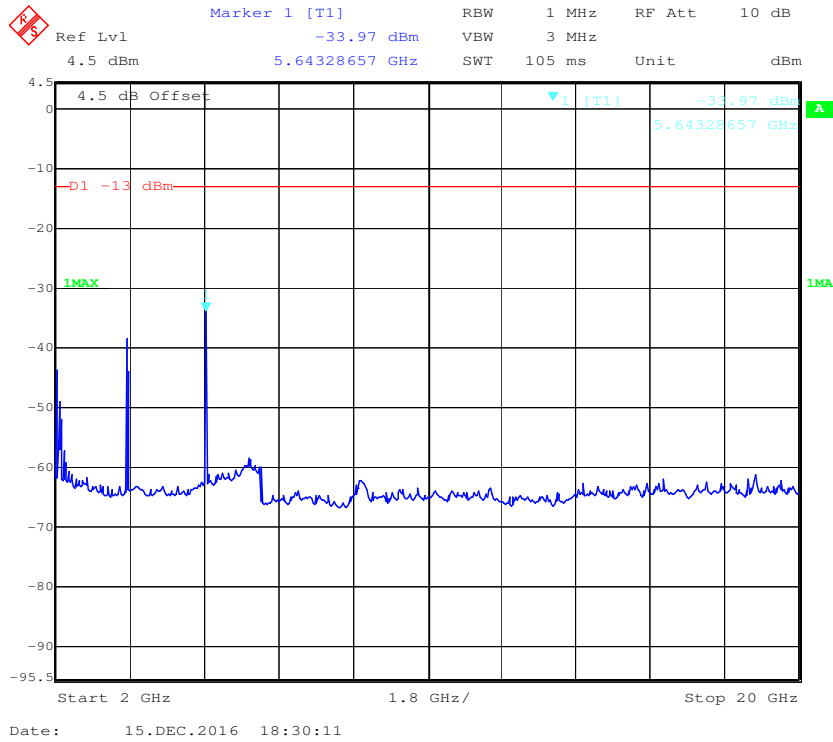

30 MHz – 1 GHz (WCDMA Mode)

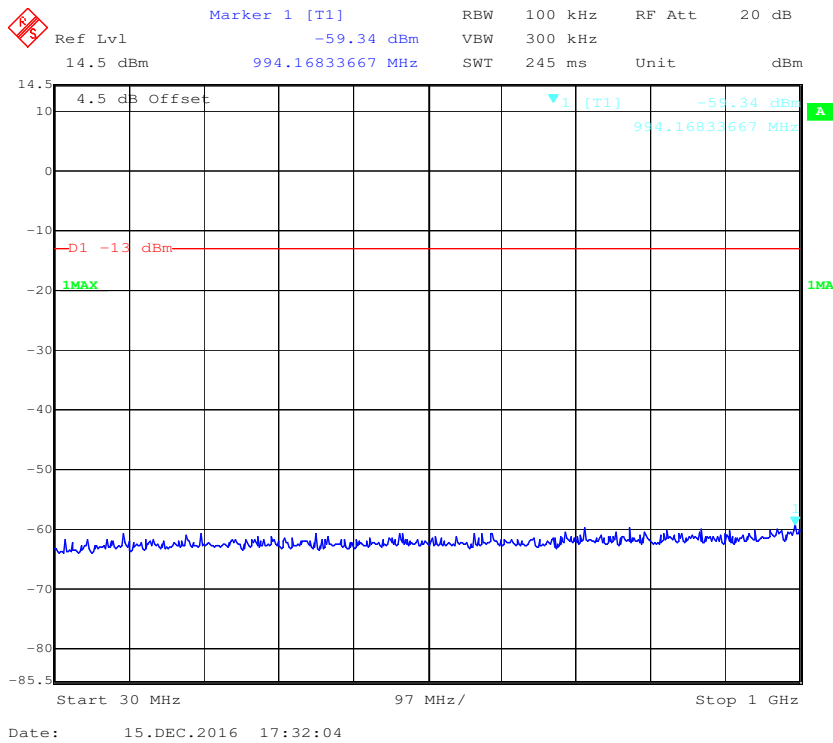

1 GHz – 20 GHz (WCDMA Mode)

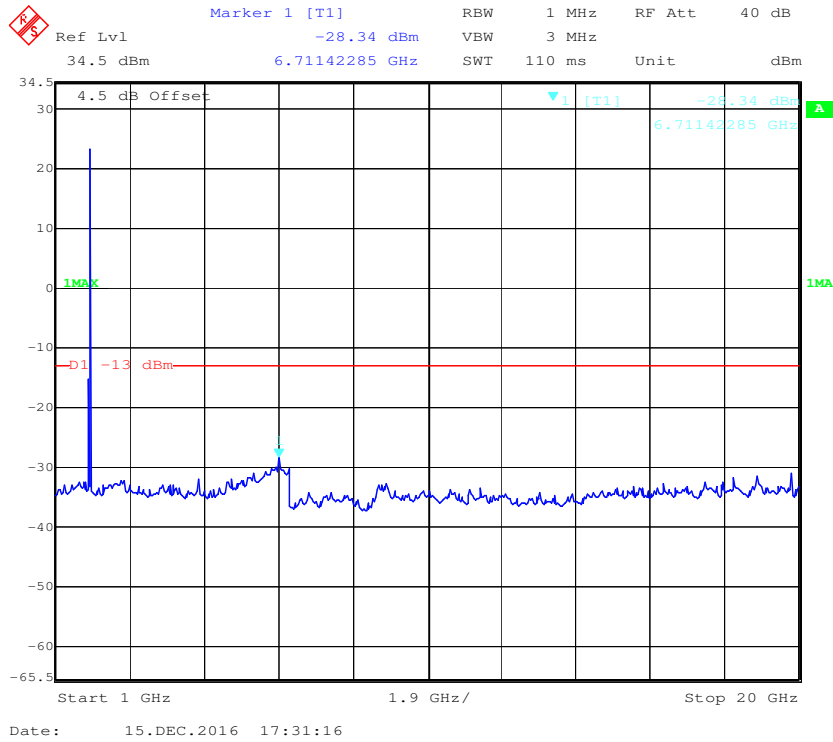

FCC §2.1053, §22.917 & §24.238 - SPURIOUS RADIATED EMISSIONS

Applicable Standard

FCC § 2.1053, §22.917 and § 24.238.

Test Procedure

The transmitter was placed on a wooden turntable, and it was transmitting into a non-radiating load which was also placed on the turntable.

The measurement antenna was placed at a distance of 3 meters from the EUT. During the tests, the receiving antenna height and polarization as well as EUT azimuth were varied in order to identify the maximum level of emissions from the EUT. The test was performed by placing the EUT on 3-orthogonal axis.

The frequency range up to tenth harmonic of the fundamental frequency was investigated.

Remove the EUT and replace it with substitution antenna. A signal generator was connected to the substitution antenna by a non-radiating cable. The absolute levels of the spurious emissions were measured by the substitution.

Spurious emissions in dB = 10 lg (TXpwr in Watts/0.001) – the absolute level

Spurious attenuation limit in dB = 43 + 10 Log₁₀ (power out in Watts)

Test Data

Environmental Conditions

Temperature:	24 °C
Relative Humidity:	49 %
ATM Pressure:	101.0 kPa

The testing was performed by Layne Li on 2016-12-20.

EUT operation mode: Transmitting

Pre-scan with Low, Middle and High channel, the worst case as below:

30 MHz ~ 10 GHz:

Cellular Band (Part 22H)

Frequency (MHz)	Receiver Reading (dBµV)	Turntable Angle Degree	Rx Antenna		Substituted			Absolute Level (dBm)	Limit (dBm)	Margin (dB)
			Height (m)	Polar (H/V)	SG Level (dBm)	Cable Loss (dB)	Antenna Gain (dB)			
GPRS Mode, Middle channel										
399.88	63.56	291	1.3	H	-39.1	0.23	4.65	-34.68	-13	21.68
399.88	64.70	232	1.9	V	-41.1	0.23	4.65	-36.68	-13	23.68
1673.20	57.40	257	1.2	H	-44.4	0.40	8.52	-36.28	-13	23.28
1673.20	55.77	250	1.3	V	-48.0	0.40	8.52	-39.88	-13	26.88
WCDMA Mode, Middle channel										
399.88	62.86	304	2.4	H	-39.8	0.23	4.65	-35.38	-13	22.38
399.88	63.60	73	1.6	V	-42.2	0.23	4.65	-37.78	-13	24.78
1673.20	40.60	265	1.9	H	-61.2	0.40	8.52	-53.08	-13	40.08
1673.20	40.27	307	1.7	V	-63.5	0.40	8.52	-55.38	-13	42.38

30 MHz ~ 20 GHz:

PCS Band (Part 24E)

Frequency (MHz)	Receiver Reading (dBµV)	Turntable Angle Degree	Rx Antenna		Substituted			Absolute Level (dBm)	Limit (dBm)	Margin (dB)
			Height (m)	Polar (H/V)	SG Level (dBm)	Cable Loss (dB)	Antenna Gain (dB)			
GPRS Mode, Middle channel										
399.88	63.76	56	1.6	H	-38.9	0.23	4.65	-34.48	-13	21.48
399.88	64.80	235	1.6	V	-41.0	0.23	4.65	-36.58	-13	23.58
3760.00	57.42	159	1.8	H	-38.6	0.59	9.72	-29.47	-13	16.47
3760.00	59.01	208	1.1	V	-38.1	0.59	9.72	-28.97	-13	15.97
WCDMA Mode, Middle channel										
399.88	63.56	208	1.1	H	-39.1	0.23	4.65	-34.68	-13	21.68
399.88	64.70	41	1.3	V	-41.1	0.23	4.65	-36.68	-13	23.68
3760.00	53.32	231	1.9	H	-42.7	0.59	9.72	-33.57	-13	20.57
3760.00	56.71	154	1.1	V	-40.4	0.59	9.72	-31.27	-13	18.27

Note:

- 1) Absolute Level = SG Level - Cable loss + Antenna Gain
- 2) Margin = Limit- Absolute Level

FCC §22.917(a) & §24.238(a) - BAND EDGES

Applicable Standard

According to § 22.917(a), the power of any emissions outside of the authorized operating frequency ranges must be attenuated below the transmitting power (P) by a factor of at least $43 + 10 \log(P)$ dB.

According to §24.238(a), the power of any emissions outside of the authorized operating frequency ranges must be attenuated below the transmitting power (P) by a factor of at least $43 + 10 \log(P)$ dB.

Test Procedure

The RF output of the transmitter was connected to the input of the spectrum analyzer through sufficient attenuation.

The center of the spectrum analyzer was set to block edge frequency

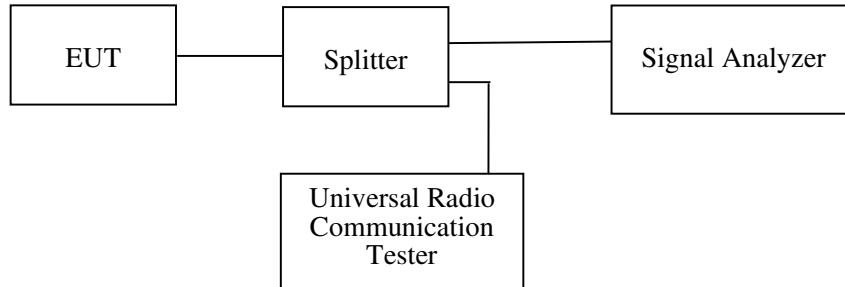

Test Data

Environmental Conditions

Temperature:	22~24.8 °C
Relative Humidity:	45~51 %
ATM Pressure:	100.0~101.0 kPa

The testing was performed by Poboo Li from 2016-12-15 to 2017-01-05.

Test Result: Compliance. Please refer to the following plots.

EUT operation mode: Transmitting

Cellular Band, Left Band Edge for GPRS Mode

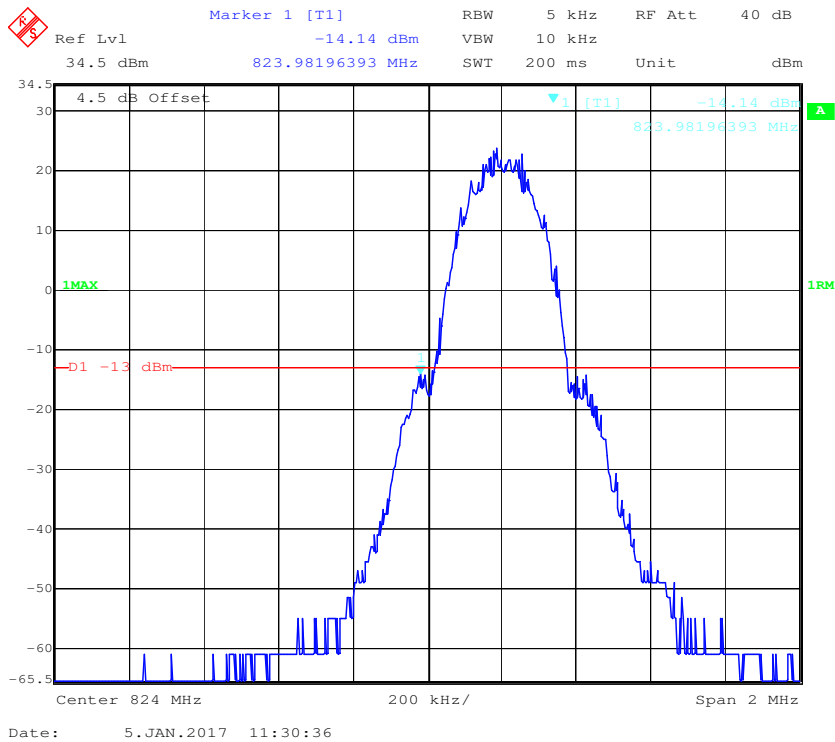

Cellular Band, Right Band Edge for GPRS Mode

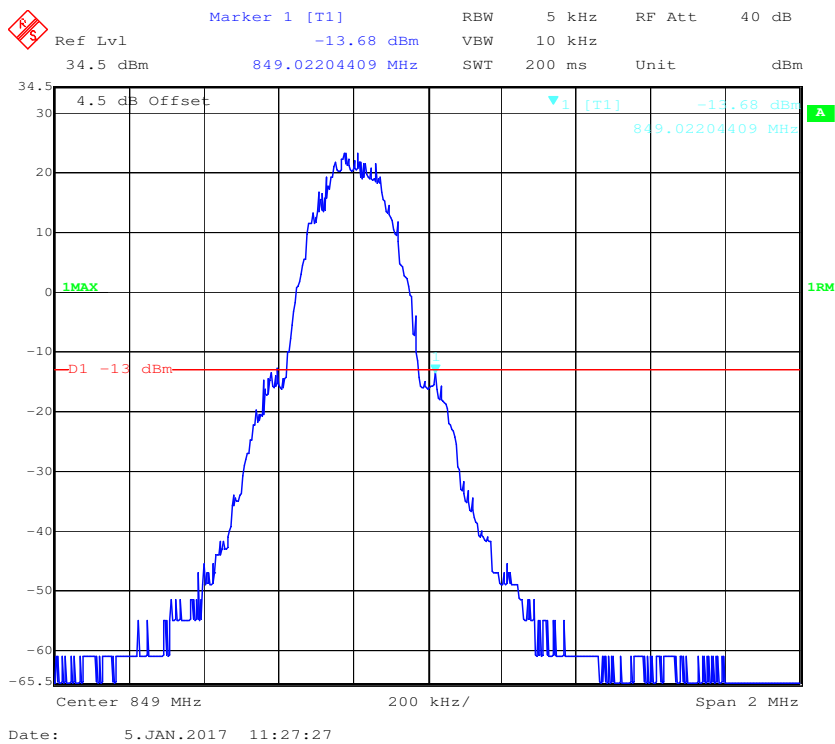

Cellular Band, Left Band Edge for WCDMA (BPSK) Mode

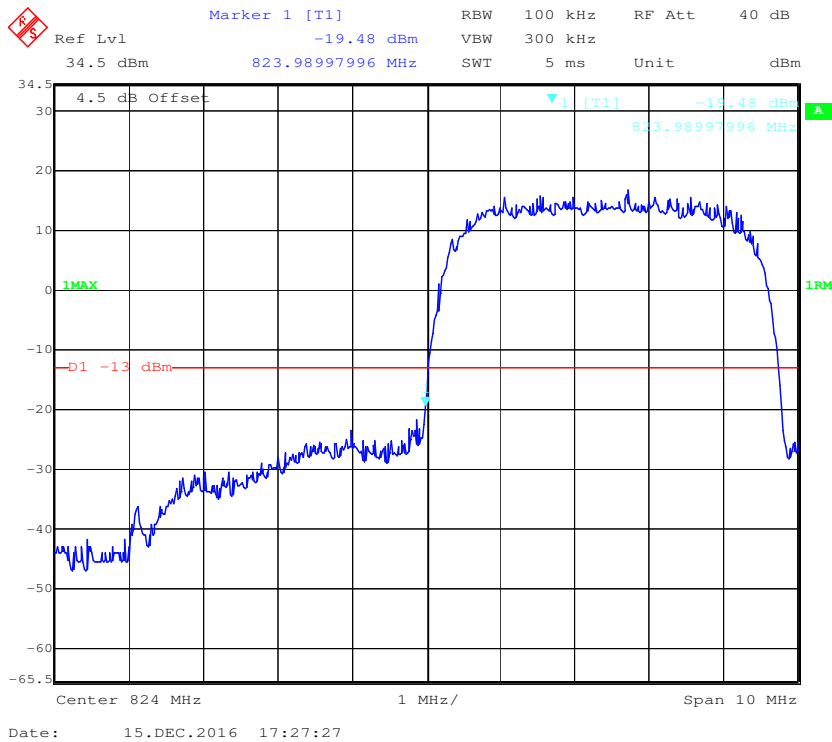

Cellular Band, Right Band Edge for WCDMA (BPSK) Mode

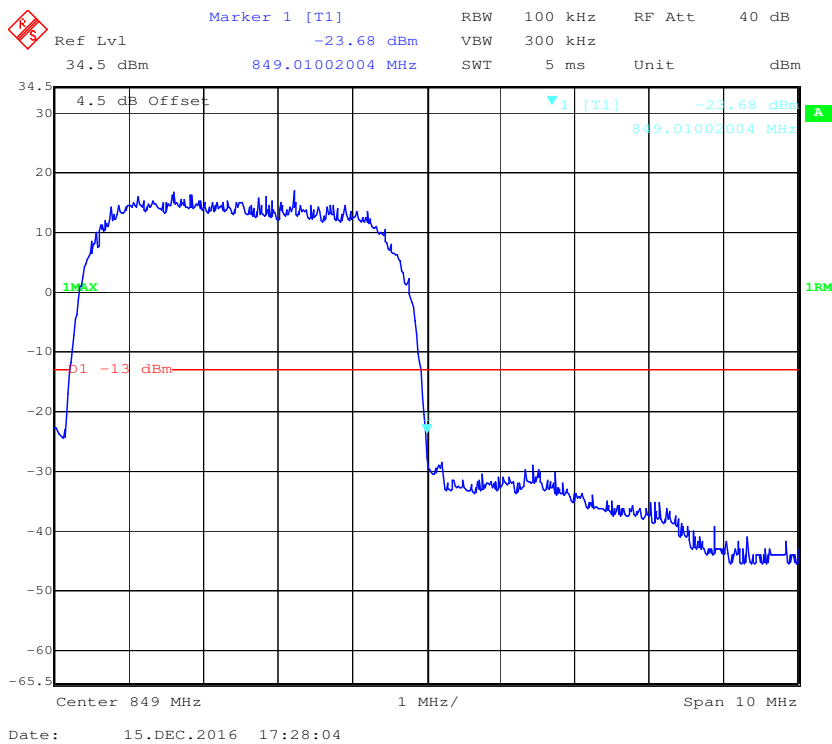

Cellular Band, Left Band Edge for HSDPA (16QAM) Mode

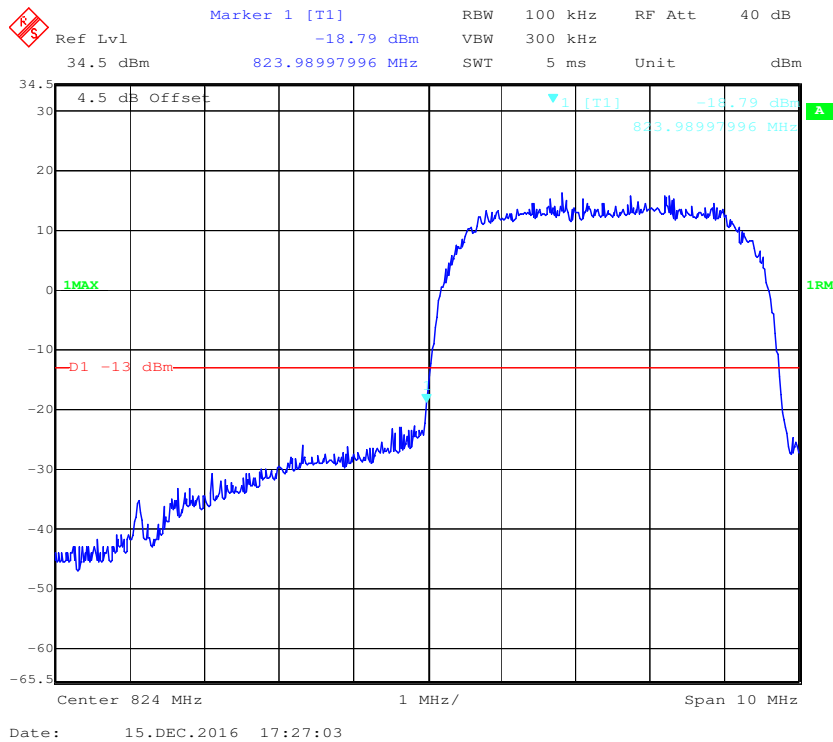

Cellular Band, Right Band Edge for HSDPA (16QAM) Mode

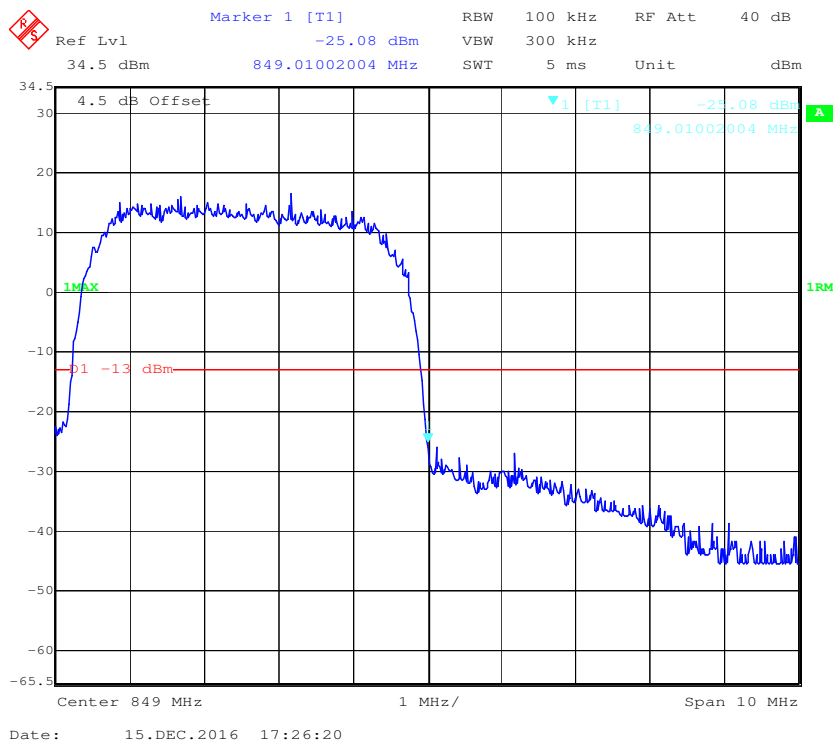

PCS Band, Left Band Edge for GSM (GMSK) Mode

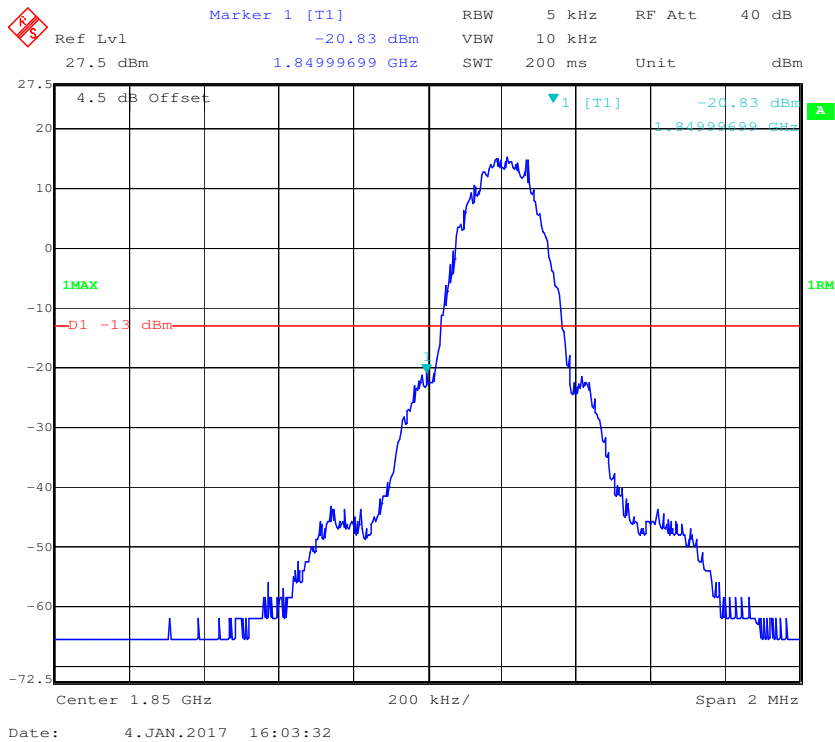

PCS Band, Right Band Edge for GSM (GMSK) Mode

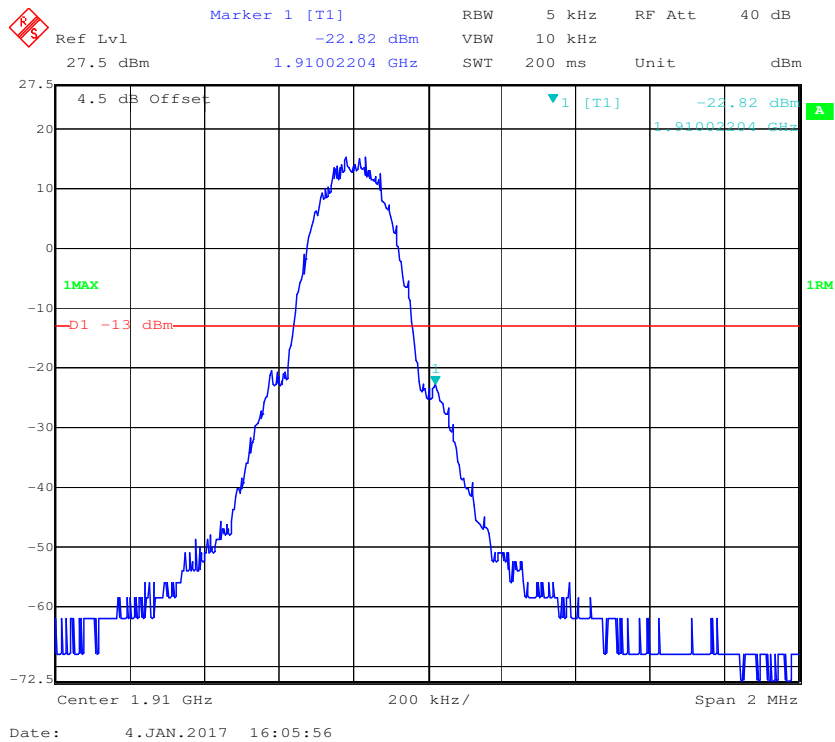

PCS Band, Left Band Edge for WCDMA (BPSK) Mode

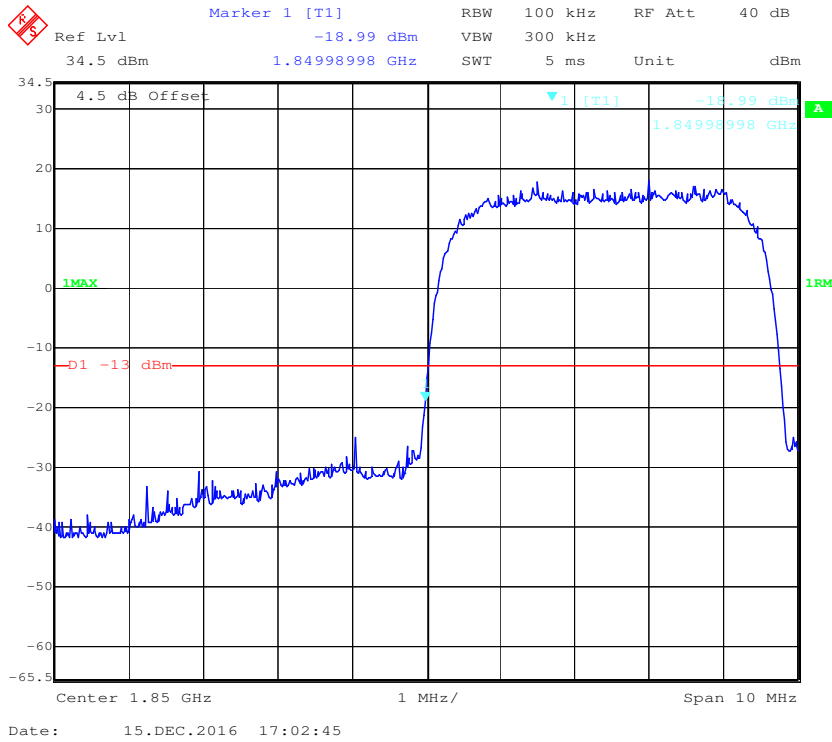

PCS Band, Right Band Edge for WCDMA (BPSK) Mode

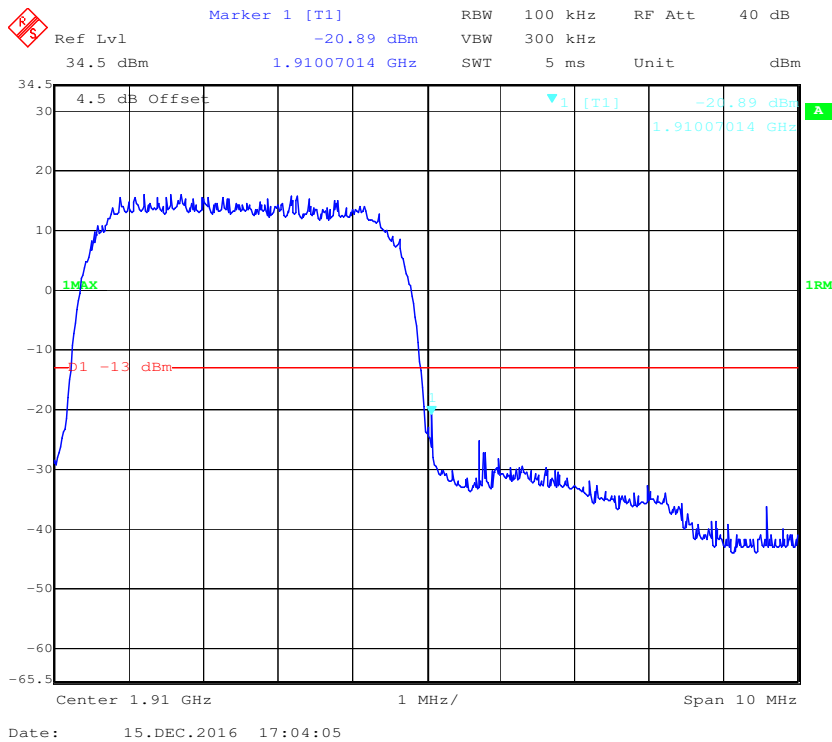

PCS Band, Left Band Edge for HSDPA (16QAM) Mode

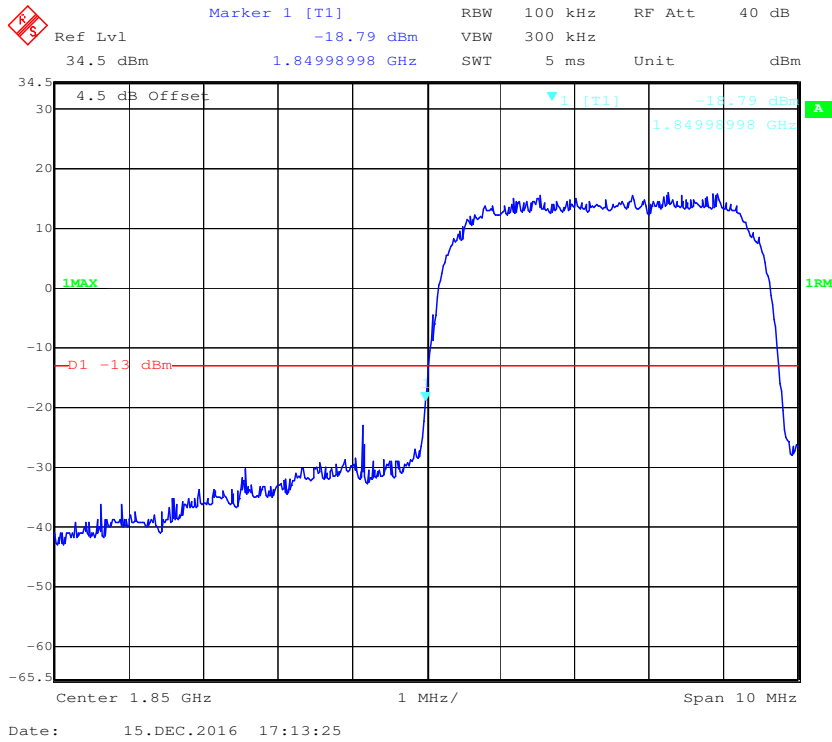

PCS Band, Right Band Edge for HSDPA (16QAM) Mode

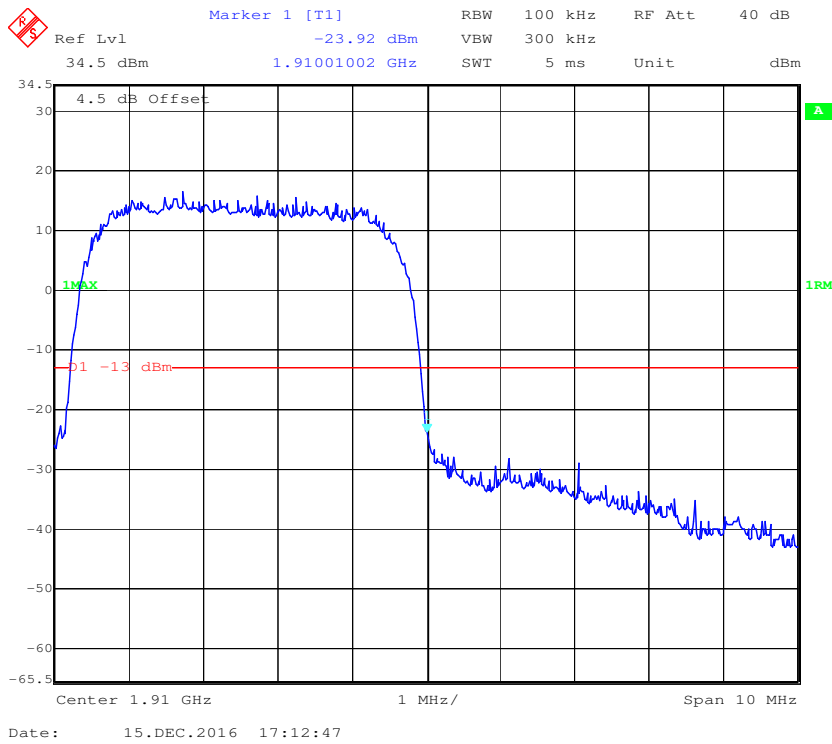

FCC §2.1055, §22.355 & §24.235 - FREQUENCY STABILITY

Applicable Standard

FCC § 2.1055, §22.355, §24.235

According to §22.355, the carrier frequency of each transmitter in the Public Mobile Services must be maintained within the tolerances given in Table below:

Frequency Tolerance for Transmitters in the Public Mobile Services

Frequency Range (MHz)	Base, fixed (ppm)	Mobile ≤ 3 watts (ppm)	Mobile > 3 watts (ppm)
25 to 50	20.0	20.0	50.0
50 to 450	5.0	5.0	50.0
450 to 512	2.5	5.0	5.0
821 to 896	1.5	2.5	2.5
928 to 929.	5.0	N/A	N/A
929 to 960.	1.5	N/A	N/A
2110 to 2220	10.0	N/A	N/A

According to §24.235, the frequency stability shall be sufficient to ensure that the fundamental emissions stays within the authorized frequency block.

Test Procedure

Frequency Stability vs. Temperature: The equipment under test was connected to an external DC power supply and the RF output was connected to communication test set via feed-through attenuators. The EUT was placed inside the temperature chamber. The DC leads and RF output cable exited the chamber through an opening made for the purpose.

After the temperature stabilized for approximately 20 minutes, the frequency output was recorded from the communication test set.

Frequency Stability vs. Voltage: For hand carried, battery powered equipment; reduce primary supply voltage to the battery operating end point which shall be specified by the manufacturer.

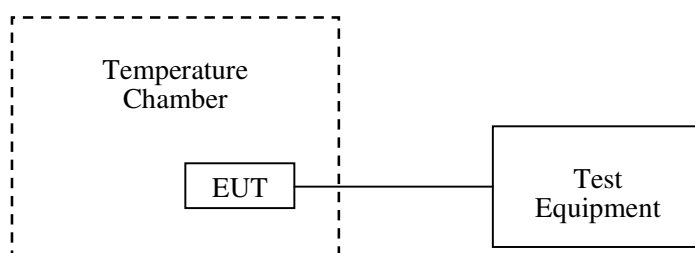

Test Data

Environmental Conditions

Temperature:	24.8 °C
Relative Humidity:	51 %
ATM Pressure:	101.0 kPa

The testing was performed by Poboo Li on 2016-12-15.

EUT operation mode: Transmitting

Test Result: Compliance. Please refer to the following tables.

Cellular Band (Part 22H)

GPRS Mode

Middle Channel, $f_0 = 836.6\text{MHz}$				
Temperature (°C)	Power Supplied (V _{DC})	Frequency Error (Hz)	Frequency Error (ppm)	Limit (ppm)
-30	3.7	-10	-0.01195	2.5
-20		-8	-0.0096	2.5
-10		-7	-0.0084	2.5
0		2	0.0024	2.5
10		-2	-0.0024	2.5
20		-5	-0.0060	2.5
30		-1	-0.0012	2.5
40		1	0.0012	2.5
50		-1	-0.0012	2.5
25		V _{min.} = 3.5	2	0.0024
25	V _{max.} = 4.2	2	0.0024	2.5

WCDMA Mode

Middle Channel, $f_0=836.6\text{MHz}$				
Temperature (°C)	Power Supplied (V _{DC})	Frequency Error (Hz)	Frequency Error (ppm)	Limit (ppm)
-20	3.7	6	0.0072	2.5
-10		4	0.0048	2.5
0		9	0.0108	2.5
10		10	0.0120	2.5
20		12	0.0143	2.5
30		15	0.0179	2.5
40		17	0.0203	2.5
50		14	0.0167	2.5
25	V _{min.} = 3.5	15	0.0179	2.5
25	V _{max.} = 4.2	19	0.0227	2.5

PCS Band (Part 24E)

GPRS Mode

Middle Channel, $f_0=1880.0\text{ MHz}$				
Temperature (°C)	Power Supplied (V _{DC})	Frequency Error (Hz)	Frequency Error (ppm)	Result
-30	3.7	-9	-0.0048	pass
-20		-8	-0.0043	pass
-10		-7	-0.0037	pass
0		-2	-0.0011	pass
10		5	0.0027	pass
20		6	0.0032	pass
30		8	0.0043	pass
40		6	0.0032	pass
50		6	0.0032	pass
25		V _{min.} = 3.5	7	0.0037
25	V _{max.} = 4.2	9	0.0048	pass

WCDMA Mode

Middle Channel, $f_0 = 1880.0$ MHz				
Temperature (°C)	Power Supplied (V_{DC})	Frequency Error (Hz)	Frequency Error (ppm)	Result
-20	3.7	-11	-0.0059	pass
-10		-13	-0.0069	pass
0		-11	-0.0059	pass
10		-12	-0.0064	pass
20		-10	-0.0053	pass
30		-6	-0.0032	pass
40		-4	-0.0021	pass
50		0	0.0000	pass
25	$V_{min} = 3.5$	-1	-0.0005	pass
25	$V_{max} = 4.2$	2	0.0011	pass

******* END OF REPORT *******