

FCC

RF

TEST REPORT

ISSUED BY  
Shenzhen BALUN Technology Co., Ltd.



FOR  
**Smart POS Terminal**

ISSUED TO  
Advanced Mobile Payment Inc.

Units 401-403, 15 Wertheim Court. Richmond Hill, Ontario L4B 3H7  
CANADA



Tested by: *Heng Aiping*  
Heng Aiping

Date: *Jan 15, 2020*

Approved by: *Wei Yanquan*  
Wei Yanquan  
(Chief Engineer)

Date: *Jan. 15, 2020*

Report No.: BL-SZ19A0583-601

EUT Name: Smart POS Terminal

Model Name: AMP 8200

Brand Name: AMP

Test Standard: 47 CFR Part 15 Subpart C

FCC ID: 2AKJB-AMP8200-1

Test conclusion: Pass

Test Date: Nov. 05, 2019 ~ Dec. 20, 2019

Date of Issue: Jan. 15, 2020

*NOTE: This test report of test results only related to testing samples, which can be duplicated completely for the legal use with the approval of the applicant; it shall not be reproduced except in full, without the written approval of Shenzhen BALUN Technology Co., Ltd. Any objections should be raised within thirty days from the date of issue. To validate the report, please contact us.*

### Revision History

<u>Version</u>	<u>Issue Date</u>	<u>Revisions Content</u>
<u>Rev. 01</u>	<u>Jan. 15, 2020</u>	<u>Initial Issue</u>

## TABLE OF CONTENTS

1	ADMINISTRATIVE DATA (GENERAL INFORMATION) .....	6
1.1	Identification of the Testing Laboratory .....	6
1.2	Identification of the Responsible Testing Location .....	6
1.3	Laboratory Condition .....	6
1.4	Announce .....	6
2	PRODUCT INFORMATION .....	7
2.1	Applicant Information .....	7
2.2	Manufacturer Information .....	7
2.3	Factory Information .....	7
2.4	General Description for Equipment under Test (EUT) .....	7
2.5	Technical Information .....	8
2.6	Additional Instructions .....	10
3	SUMMARY OF TEST RESULTS .....	11
3.1	Test Standards .....	11
3.2	Verdict .....	11
4	GENERAL TEST CONFIGURATIONS .....	12
4.1	Test Environments .....	12
4.2	Test Equipment List .....	12
4.3	Measurement Uncertainty .....	13
4.4	Description of Test Setup .....	14
4.4.1	For Antenna Port Test .....	14
4.4.2	For AC Power Supply Port Test .....	14
4.4.3	For Radiated Test (Below 30 MHz) .....	15
4.4.4	For Radiated Test (30 MHz-1 GHz) .....	15
4.4.5	For Radiated Test (Above 1 GHz) .....	16
4.5	Measurement Results Explanation Example .....	17

4.5.1	For conducted test items: .....	17
5	TEST ITEMS.....	18
5.1	Antenna Requirements.....	18
5.1.1	Relevant Standards.....	18
5.1.2	Antenna Anti-Replacement Construction .....	18
5.1.3	Antenna Gain .....	18
5.2	Frequency Hopping Systems .....	19
5.2.1	Relevant Standards.....	19
5.2.2	Description of the systems .....	19
5.3	Number of Hopping Frequencies .....	20
5.3.1	Limit.....	20
5.3.2	Test Setup .....	20
5.3.3	Test Procedure .....	20
5.3.4	Test Result .....	20
5.4	Peak Output Power and E.I.R.P.....	21
5.4.1	Test Limit.....	21
5.4.2	Test Setup .....	21
5.4.3	Test Procedure.....	21
5.4.4	Test Result .....	21
5.5	Occupied Bandwidth .....	22
5.5.1	Limit.....	22
5.5.2	Test Setup .....	22
5.5.3	Test Procedure.....	22
5.5.4	Test Result .....	22
5.6	Carrier Frequency Separation .....	23
5.6.1	Limit.....	23
5.6.2	Test Setup .....	23
5.6.3	Test Procedure.....	23
5.6.4	Test Result .....	23
5.7	Time of Occupancy (Dwell time) .....	24
5.7.1	Limit.....	24
5.7.2	Test Setup .....	24
5.7.3	Test Procedure.....	24

5.7.4	Test Result .....	25
5.8	Conducted Spurious Emission & Authorized-band band-edge .....	26
5.8.1	Limit.....	26
5.8.2	Test Setup .....	26
5.8.3	Test Procedure.....	26
5.8.4	Test Result .....	26
5.9	Conducted Emission .....	27
5.9.1	Limit.....	27
5.9.2	Test Setup .....	27
5.9.3	Test Procedure.....	27
5.9.4	Test Result .....	27
5.10	Radiated Spurious Emission .....	28
5.10.1	Limit.....	28
5.10.2	Test Setup .....	28
5.10.3	Test Procedure.....	28
5.10.4	Test Result .....	29
5.11	Band Edge (Restricted-band band-edge).....	30
5.11.1	Limit.....	30
5.11.2	Test Setup .....	30
5.11.3	Test Procedure.....	30
5.11.4	Test Result .....	30
ANNEX A	TEST RESULT .....	31
A.1	Number of Hopping Frequency .....	31
A.2	Peak Output Power .....	31
A.3	20 dB and 99% bandwidth .....	31
A.4	Hopping Frequency Separation.....	31
A.5	Average Time of Occupancy .....	31
A.6	Conducted Spurious Emissions & Authorized-band band-edge .....	31
A.7	Conducted Emissions.....	32
A.8	Radiated Spurious Emission .....	34
A.9	Band Edge (Restricted-band band-edge).....	52
ANNEX B	TEST SETUP PHOTOS .....	54
ANNEX C	EUT EXTERNAL PHOTOS.....	54

ANNEX D EUT INTERNAL PHOTOS .....54

# 1 ADMINISTRATIVE DATA (GENERAL INFORMATION)

## 1.1 Identification of the Testing Laboratory

Company Name	Shenzhen BALUN Technology Co., Ltd.
Address	Block B, 1st FL, Baisha Science and Technology Park, Shahe Xi Road, Nanshan District, Shenzhen, Guangdong Province, P. R. China
Phone Number	+86 755 6685 0100

## 1.2 Identification of the Responsible Testing Location

Test Location	Shenzhen BALUN Technology Co., Ltd.
Address	Block B, 1st FL, Baisha Science and Technology Park, Shahe Xi Road, Nanshan District, Shenzhen, Guangdong Province, P. R. China
Accreditation Certificate	<p>The laboratory has been listed by Industry Canada to perform electromagnetic emission measurements. The recognition numbers of test site are 11524A-1.</p> <p>The laboratory is a testing organization accredited by FCC as a accredited testing laboratory. The designation number is CN1196.</p> <p>The laboratory is a testing organization accredited by American Association for Laboratory Accreditation(A2LA) according to ISO/IEC 17025.The accreditation certificate is 4344.01.</p> <p>The laboratory is a testing organization accredited by China National Accreditation Service for Conformity Assessment (CNAS) according to ISO/IEC 17025. The accreditation certificate number is L6791.</p>
Description	All measurement facilities used to collect the measurement data are located at Block B, FL 1, Baisha Science and Technology Park, Shahe Xi Road, Nanshan District, Shenzhen, Guangdong Province, P. R. China 518055

## 1.3 Laboratory Condition

Ambient Temperature	20°C to 25°C
Ambient Relative Humidity	45% to 55%
Ambient Pressure	100 kPa to 102 kPa

## 1.4 Announce

- (1) The test report reference to the report template version v5.7.
- (2) The test report is invalid if not marked with the signatures of the persons responsible for preparing and approving the test report.
- (3) The test report is invalid if there is any evidence and/or falsification.
- (4) The results documented in this report apply only to the tested sample, under the conditions and modes of operation as described herein.
- (5) This document may not be altered or revised in any way unless done so by BALUN and all revisions are duly noted in the revisions section.
- (6) Content of the test report, in part or in full, cannot be used for publicity and/or promotional purposes without prior written approval from the laboratory.

## 2 PRODUCT INFORMATION

### 2.1 Applicant Information

Applicant	Advanced Mobile Payment Inc.
Address	Units 401-403, 15 Wertheim Court. Richmond Hill, Ontario L4B 3H7 CANADA

### 2.2 Manufacturer Information

Manufacturer	NEW POS TECHNOLOGY LIMITED
Address	Floor, Block A, Financial Technology Building, No.11 Keyuan Rd, Nanshan District, Shenzhen

### 2.3 Factory Information

Factory	N/A
Address	N/A

### 2.4 General Description for Equipment under Test (EUT)

EUT Name	Smart POS Terminal
Model Name Under Test	AMP 8200
Series Model Name	N/A
Description of Model name differentiation	N/A
Hardware Version	N0000H30225E0
Software Version	V1.0.1
Dimensions (Approx.)	N/A
Weight (Approx.)	N/A

## 2.5 Technical Information

Network and Wireless connectivity	2G Network GSM/GPRS/EGPRS 850/1900 MHz 3G Network WCDMA/HSDPA/HSUPA Band 2/4/5 4G Network FDD LTE Band 2/4/5/12/13 Bluetooth 4.1 (BR+EDR+BLE) WIFI 802.11a, 802.11b, 802.11g, 802.11n Band 1/4 SRD NFC
-----------------------------------	---

The requirement for the following technical information of the EUT was tested in this report:

Modulation Technology	FHSS
Modulation Type	GFSK, $\pi/4$ -DQPSK, 8-DPSK
Product Type	<input type="checkbox"/> Mobile <input checked="" type="checkbox"/> Portable <input type="checkbox"/> Fix Location
Transfer Rate	DH5: 1 Mbps 2DH5: 2 Mbps 3DH5: 3 Mbps
Frequency Range	The frequency range used is 2400 MHz to 2483.5 MHz.
Number of channel	79 (at intervals of 1 MHz)
Tested Channel	0 (2402 MHz), 39 (2441 MHz), 78 (2480 MHz)
Antenna Type	PIFA Antenna
Antenna Gain	3 dBi (In test items related to antenna gain, the final results reflect this figure.)
Antenna Impedance	50Ω
Antenna System(MIMO Smart Antenna)	N/A



All channel was listed on the following table:

Channel number	Freq. (MHz)	Channel number	Freq. (MHz)	Channel number	Freq. (MHz)	Channel number	Freq. (MHz)
<b>0</b>	<b>2402</b>	21	2423	42	2444	63	2465
1	2403	22	2424	43	2445	64	2466
2	2404	23	2425	44	2446	65	2467
3	2405	24	2426	45	2447	66	2468
4	2406	25	2427	46	2448	67	2469
5	2407	26	2428	47	2449	68	2470
6	2408	27	2429	48	2450	69	2471
7	2409	28	2430	49	2451	70	2472
8	2410	29	2431	50	2452	71	2473
9	2411	30	2432	51	2453	72	2474
10	2412	31	2433	52	2454	73	2475
11	2413	32	2434	53	2455	74	2476
12	2414	33	2435	54	2456	75	2477
13	2415	34	2436	55	2457	76	2478
14	2416	35	2437	56	2458	77	2479
15	2417	36	2438	57	2459	<b>78</b>	<b>2480</b>
16	2418	37	2439	58	2460	-	-
17	2419	38	2440	59	2461	-	-
18	2420	<b>39</b>	<b>2441</b>	60	2462	-	-
19	2421	40	2442	61	2463	-	-
20	2422	41	2443	62	2464	-	-

## 2.6 Additional Instructions

EUT Software Settings:

Mode	<input checked="" type="checkbox"/> Bluetooth test mode loop back enabled. EUT is controlled over CBT / CMW.
------	---

Power level setup in software			
Test Software Version	QRCT		
Mode	Channel	Frequency (MHz)	Soft Set
DH5	CH0	2402	TX LEVEL is built-in set parameters and cannot be changed and selected.
	CH39	2441	
	CH78	2480	
2DH5	CH0	2402	
	CH39	2441	
	CH78	2480	
3DH5	CH0	2402	
	CH39	2441	
	CH78	2480	

Run Software:

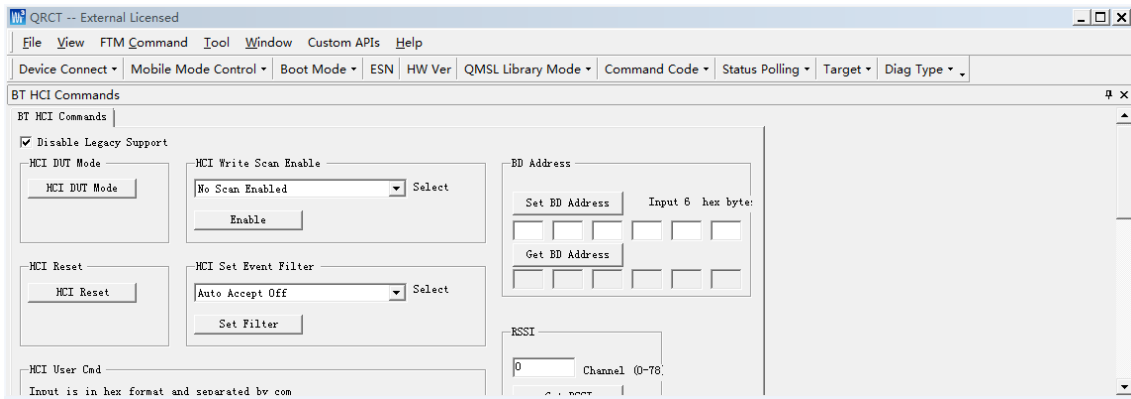

### 3 SUMMARY OF TEST RESULTS

#### 3.1 Test Standards

No.	Identity	Document Title
1	47 CFR Part 15, Subpart C (10-1-17 Edition)	Miscellaneous Wireless Communications Services
2	ANSI C63.10-2013	American National Standard for Testing Unlicensed Wireless Devices
3	KDB 558074 D01 15.247 Meas Guidance v05r02	Guidance for compliance measurements on digital transmission system, frequency hopping spread spectrum system, and hybrid system devices operating under section 15.247 of the FCC rules

#### 3.2 Verdict

No.	Description	FCC Part No.	Channel	Test Result	Verdict	Remark
1	Antenna Requirement	15.203	N/A	--	Pass	Note <sup>1</sup>
2	Number of Hopping Frequencies	15.247(a)	Hopping Mode	ANNEX A.1	Pass	Note <sup>2</sup>
3	Peak Output Power	15.247(b)	Low/Middle/High	ANNEX A.2	Pass	--
4	Occupied Bandwidth	15.247(a)	Low/Middle/High	ANNEX A.3	Pass	Note <sup>2</sup>
5	Carrier Frequency Separation	15.247(a)	Hopping Mode	ANNEX A.4	Pass	Note <sup>2</sup>
6	Time of Occupancy (Dwell time)	15.247(a)	Hopping Mode	ANNEX A.5	Pass	Note <sup>2</sup>
7	Conducted Spurious Emission & Authorized-band band-edge	15.247(d)	Low/Middle/High	ANNEX A.6	Pass	Note <sup>2</sup>
8	Conducted Emission	15.207	Low/Middle/High	ANNEX A.7	Pass	Note <sup>2</sup>
9	Radiated Spurious Emission	15.209 15.247(d)	Hopping Mode, Low/Middle/High	ANNEX A.8	Pass	Note <sup>2</sup>
10	Band Edge(Restricted-band band-edge)	15.209 15.247(d)	Hopping Mode, Low/Middle/High	ANNEX A.9	Pass	Note <sup>2</sup>
11	Receiver Spurious Emissions	--	--	--	N/A	Note <sup>3</sup>

Note <sup>1</sup>: Please refer to section 5.1

Note <sup>2</sup>:  $\pi/4$ -DQPSK is the EDR 2M rate mode, 8-DPSK is the EDR 3M rate mode. The consistency of test results in  $\pi/4$ -DQPSK and 8-DPSK is very high. So we chose 8-DPSK as a typical representative to appear on the report. Another we will show all the modes on the RF output power test item.

Note <sup>3</sup>: Only radio communication receivers operating in stand-alone mode within the band 30-960 MHz, as well as scanner receivers, are subject to Industry Canada requirements, so this test is not applicable.

Note <sup>4</sup>: Because the RF module installed in the EUT is electronically and mechanically identical to the original certified module in the test report No. FR741007A (FCC ID: XMR201706SC20A) (which issued by Sporton International (KunShan) INC. on Aug. 11, 2017), so just Conducted Emission & Radiated Spurious Emission & Band Edge(Restricted-band band-edge) were retested in this report. Other test items please refer to the No. FR741007A (FCC ID: XMR201706SC20A) (which issued by Sporton International (KunShan) INC. on Aug. 11, 2017).

## 4 GENERAL TEST CONFIGURATIONS

### 4.1 Test Environments

During the measurement, the normal environmental conditions were within the listed ranges:

Relative Humidity	45% to 55%	
Atmospheric Pressure	100 kPa to 102 kPa	
Temperature	NT (Normal Temperature)	+22°C to +25°C
Working Voltage of the EUT	NV (Normal Voltage)	7.2 V

### 4.2 Test Equipment List

Description	Manufacturer	Model	Serial No.	Cal. Date	Cal. Due
Spectrum Analyzer	ROHDE&SCHWARZ	FSV-30	103118	2019.06.13	2020.06.12
Switch Unit with OSP-B157	ROHDE&SCHWARZ	OSP120	101270	2019.06.13	2020.06.12
EMI Receiver	KEYSIGHT	N9038A	MY53220118	2019.10.29	2020.10.28
EMI Receiver	ROHDE&SCHWARZ	ESRP	101036	2019.06.13	2020.06.12
LISN	SCHWARZBECK	NSLK 8127	8127-687	2019.06.13	2020.06.12
Bluetooth Tester	ROHDE&SCHWARZ	CBT	101005	2019.06.13	2020.06.12
DC Power Supply	ROHDE&SCHWARZ	HMP2020	018141664	2019.06.18	2020.06.17
Power Splitter	KMW	DCPD-LDC	1305003215	--	--
Power Sensor	ROHDE&SCHWARZ	NRP-Z21	103971	2019.06.13	2020.06.12
Attenuator (20 dB)	KMW	ZA-S1-201	110617091	2019.01.09	2020.01.08
Attenuator (6 dB)	KMW	ZA-S1-61	1305003189	2019.01.09	2020.01.08
Temperature Chamber	AHK	SP20	1412	2019.06.24	2020.06.23
Test Antenna-Loop(9 kHz-30 MHz)	SCHWARZBECK	FMZB 1519	1519-037	2017.11.09	2020.11.08
Test Antenna-Bi-Log(30 MHz-3 GHz)	SCHWARZBECK	VULB 9163	9163-624	2018.08.22	2020.08.21
Test Antenna-Horn(1-18 GHz)	SCHWARZBECK	BBHA 9120D	9120D-1148	2018.07.11	2020.07.10
Test Antenna-Horn (18-40 GHz)	A-INFO	LB-180400KF	J211060273	2019.01.05	2021.01.04
Anechoic Chamber	RAINFORD	9m*6m*6m	N/A	2017.02.21	2020.02.20
Anechoic Chamber	EMC Electronic Co., Ltd	20.10*11.60*7.35m	N/A	2018.07.19	2020.07.18
Shielded Enclosure	ChangNing	CN-130701	130703	--	--
Signal Generator	ROHDE&SCHWARZ	SMB100A	177746	2019.08.23	2020.08.22
Power Amplifier	OPHIR RF	5225F	1037	2019.02.28	2020.02.27
Power Amplifier	OPHIR RF	5273F	1016	2019.02.28	2020.02.27
Directional Coupler	Werlantone	C5982-10	109275	N/A	N/A
Directional Coupler	Werlantone	CHP-273E	S00801z-01	N/A	N/A
Sound Level Meter	B&K	NL-20	00844023	2019.11.12	2020.11.11
Ear Simulator	B&K	4185	2409449	2019.11.12	2020.11.11

Description	Manufacturer	Model	Serial No.	Cal. Date	Cal. Due
Ear Simulator	B&K	4195	2418189	2019.11.12	2020.11.11
Audio analyzer	B&K	UPL 16	100129	2019.11.12	2020.11.11
Software	BALUN	BL410	-	-	-
Cable	ROHDE&SCHWARZ	JUNFLON	APR0914004	2019.01.09	2020.01.08

Note: The Test Equipment List please refer to the Report No. FR741007A (FCC ID: XMR201706SC20A) (which issued by Sporton International (KunShan) INC. on Aug. 11, 2017), **Section 4 List of Measuring Equipment.**

### 4.3 Measurement Uncertainty

The following measurement uncertainty levels have been estimated for tests performed on the EUT as specified in CISPR 16-4-2.

This uncertainty represents an expanded uncertainty expressed at approximately the 95% confidence level using a coverage factor of k=2.

Measurement	Value
Occupied Channel Bandwidth	±4%
RF output power, conducted	±1.4 dB
Power Spectral Density, conducted	±2.5 dB
Unwanted Emissions, conducted	±2.8 dB
All emissions, radiated	±5.4 dB
Temperature	±1°C
Humidity	±4%

Note: The Measurement Uncertainty please refer to the Report No. FR741007A (FCC ID: XMR201706SC20A) (which issued by Sporton International (KunShan) INC. on Aug. 11, 2017), **Section 5 Uncertainty of Evaluation.**

## 4.4 Description of Test Setup

### 4.4.1 For Antenna Port Test

Conducted value (dBm) = Measurement value (dBm) + cable loss (dB)

For example: the measurement value is 10 dBm and the cable 0.5dBm used, then the final result of EUT:

Conducted value (dBm) = 10 dBm + 0.5 dB = 10.5 dBm

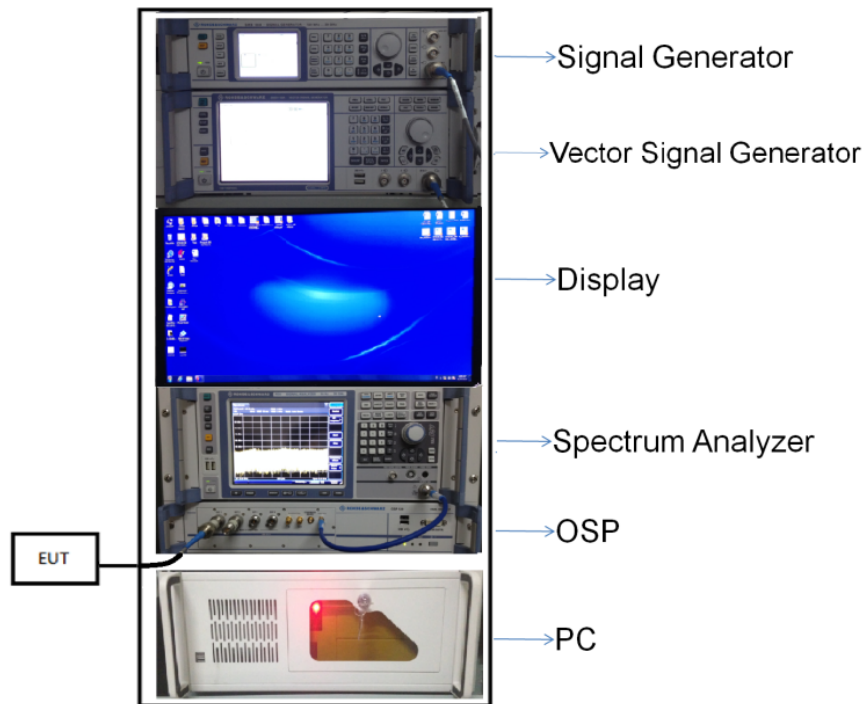

(Diagram 1)

### 4.4.2 For AC Power Supply Port Test

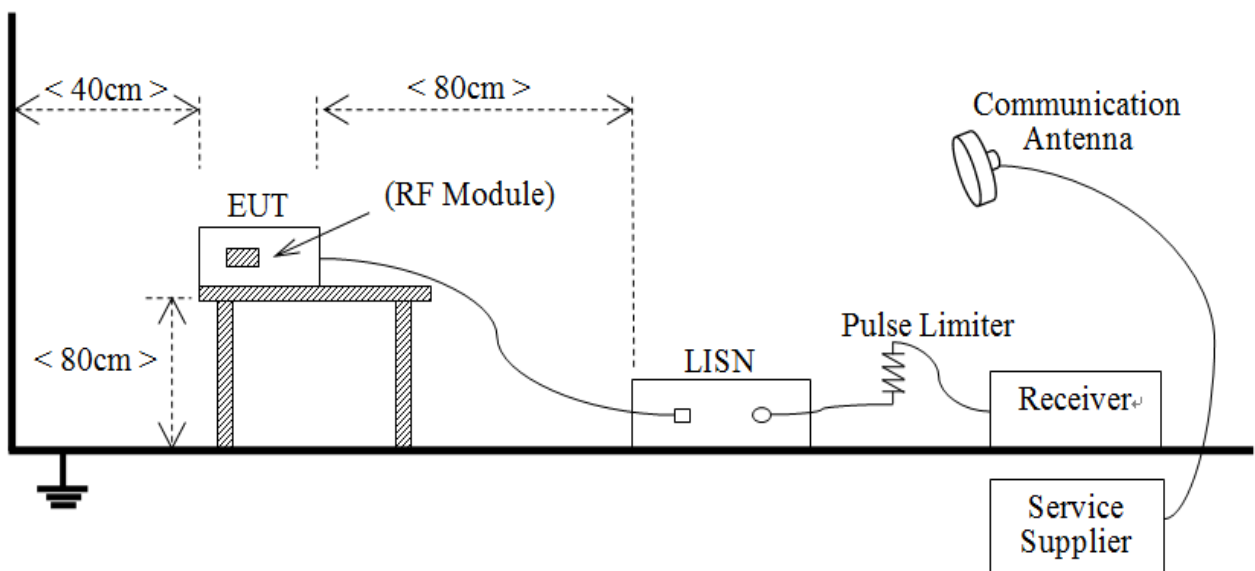

(Diagram 2)

4.4.3 For Radiated Test (Below 30 MHz)

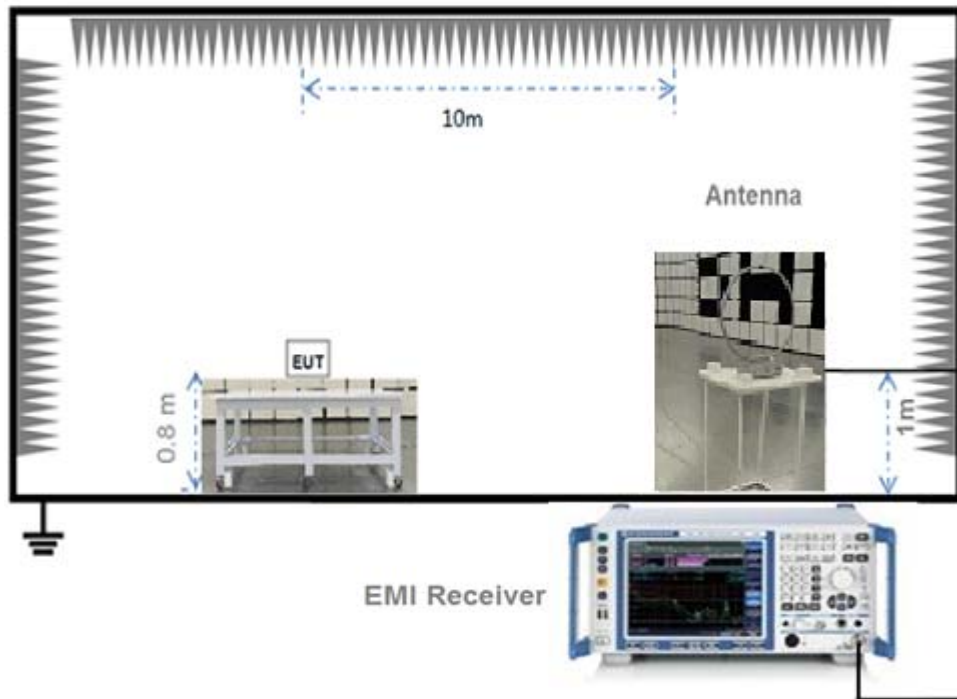

(Diagram 3)

4.4.4 For Radiated Test (30 MHz-1 GHz)

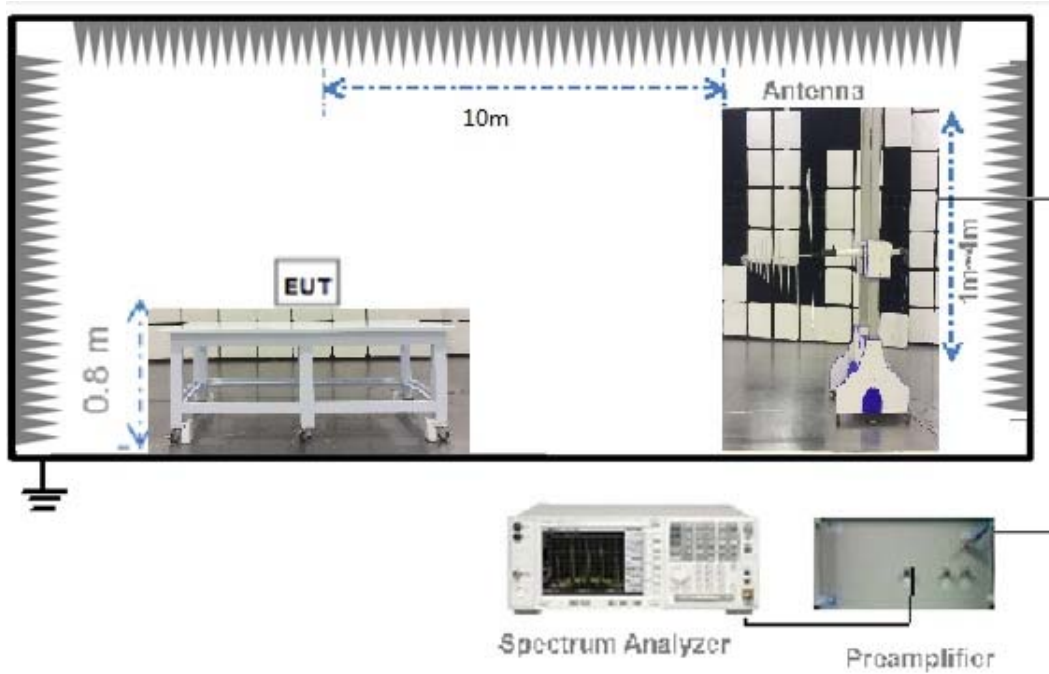

(Diagram 4)

4.4.5 For Radiated Test (Above 1 GHz)

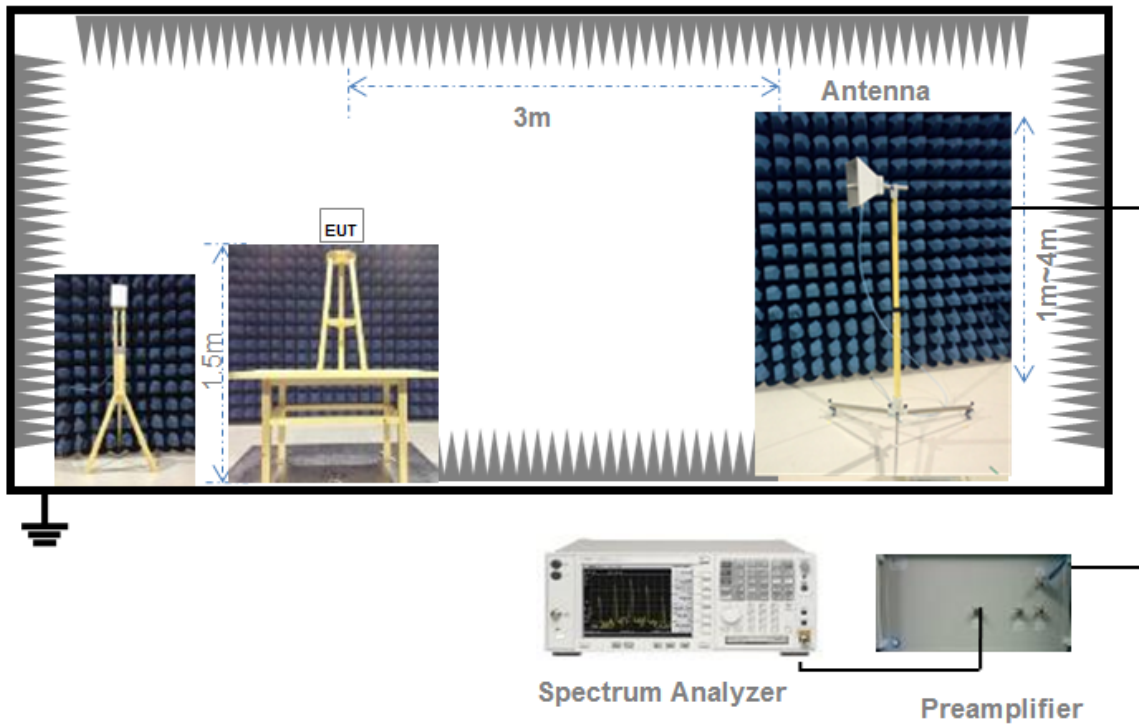

(Diagram 5)



## 4.5 Measurement Results Explanation Example

### 4.5.1 For conducted test items:

The offset level is set in the spectrum analyzer to compensate the RF cable loss and attenuator between EUT conducted output port and spectrum analyzer. With the offset compensation, the spectrum analyzer reading level is exactly the EUT RF output level.

The spectrum analyzer offset is derived from RF cable loss and attenuator factor.

Offset = RF cable loss + attenuator factor.

## 5 TEST ITEMS

### 5.1 Antenna Requirements

#### 5.1.1 Relevant Standards

FCC §15.203 & 15.247(b); RSS-247, 5.4 (f)

An intentional radiator shall be designed to ensure that no antenna other than that furnished by the responsible party shall be used with the device. The use of a permanently attached antenna or of an antenna that uses a unique coupling to the intentional radiator shall be considered sufficient to comply with the provisions of this section. The manufacturer may design the unit so that a broken antenna can be replaced by the user, but the use of a standard antenna jack or electrical connector is prohibited. This requirement does not apply to carrier current devices or to devices operated under the provisions of § 15.211, § 15.213, § 15.217, § 15.219, or § 15.221. Further, this requirement does not apply to intentional radiators that must be professionally installed, such as perimeter protection systems and some field disturbance sensors, or to other intentional radiators which, in accordance with § 15.31(d), must be measured at the installation site. However, the installer shall be responsible for ensuring that the proper antenna is employed so that the limits in this part are not exceeded.

If directional gain of transmitting antennas is greater than 6 dBi, the power shall be reduced by the same level in dB comparing to gain minus 6 dBi. For the fixed point-to-point operation, the power shall be reduced by one dB for every 3 dB that the directional gain of the antenna exceeds 6 dBi. The use of a permanently attached antenna or of an antenna that uses a unique coupling to the intentional radiator shall be considered sufficient to comply with the FCC rule.

#### 5.1.2 Antenna Anti-Replacement Construction

The Antenna Anti-Replacement as following method:

Protected Method	Description
The antenna is embedded in the product.	An embedded-in antenna design is used.

Reference Documents	Item
Photo	Please refer to the EUT Photo documents.

#### 5.1.3 Antenna Gain

The antenna peak gain of EUT is less than 6 dBi. Therefore, it is not necessary to reduce maximum peak output power limit.

## 5.2 Frequency Hopping Systems

### 5.2.1 Relevant Standards

FCC §15.247(a) (1) (i) (ii) (iii) (iv); FCC §15.247(g); FCC §15.247(h)

Describe how the hopping sequence is generated. Provide an example of the hopping sequence channels, to demonstrate that the sequence meets the requirement specified in the definition of an FHSS system. Per the definition in Section 2.1(c), the hop set shall appear as random in the near term, shall appear as evenly distributed in the long term, and sequential hops shall be randomly distributed in both direction and magnitude of change.

Describe how each individual EUT meets the requirement that each of its hopping channels is used equally on average (e.g., that each new transmission event begins on the next channel in the hopping sequence after the final channel used in the previous transmission event).

Describe how the associated receiver(s) complies with the requirement that the input bandwidth (either RF or IF) matches the bandwidth of the transmitted signal.

Describe how the associated receiver(s) has the ability to shift frequencies in synchronization with the transmitted signals.

For short burst systems, describe how the EUT complies with the requirement that it be designed to be capable of operating as a true frequency hopping system. Specifically, the device shall comply with the equal frequency use and pseudorandom hopping sequence requirement when transmitting in short bursts, and shall be designed to comply when presented with continuous data (or information) stream.

Describe how the EUT complies with the requirement that it not have the ability to be coordinated with other FHSS systems in an effort to avoid the simultaneous occupancy of individual hopping frequencies by multiple transmitters.

### 5.2.2 Description of the systems

1. According to the preset procedure of the whole network, all the stations in the automatic control network synchronously change the frequency multiple times within one second, and temporarily stay on each frequency hopping channel. Periodic synchronization signaling is sent from the primary station, instructing all slaves to simultaneously change the operating frequency, then the hopping sequence is generated.
2. The hop set shall appear as random in the near term, shall appear as evenly distributed in the long term, and sequential hops shall be randomly distributed in both direction and magnitude of change.

#### Reference Documents

Please refer to the Report No. FR741007A (FCC ID: XMR201706SC20A), which issued by Sporton International (KunShan) INC. on Aug. 11, 2017.

3. Channels are classified into two categories, used and unused, where used channels are part of the hopping sequence and unused channels are replaced in the hopping sequence by used channels in a pseudo-random way. Make each individual EUT meets the requirement that each of its hopping channels is used equally on average.
4. The input bandwidth and transmitted bandwidth are both 1MHz, the associated receiver(s) complies with the requirement that the input bandwidth matches the bandwidth of the transmitted signal.
5. Connected devices communicate on the same physical channel by synchronizing with a common clock and hopping sequence.
6. EUT isn't short burst systems.
7. EUT can't have the ability to be coordinated with other FHSS systems in an effort.

## 5.3 Number of Hopping Frequencies

### 5.3.1 Limit

FCC §15.247(a) (1) (iii); RSS-247, 5.1 (d)

Frequency hopping systems operating in the 2400 MHz to 2483.5 MHz bands shall use at least 15 hopping frequencies.

### 5.3.2 Test Setup

See section 4.4.1 for test setup description for the antenna port. The photo of test setup please refer to ANNEX B.

### 5.3.3 Test Procedure

The EUT must have its hopping function enabled. Use the following spectrum analyzer settings:

Span = The frequency band of operation

RBW = To identify clearly the individual channels, set the RBW to less than 30% of the channel spacing or the 20 dB bandwidth, whichever is smaller.

VBW  $\geq$  RBW

Sweep = auto

Detector function = peak

Trace = max hold

Allow the trace to stabilize

### 5.3.4 Test Result

Please refer to ANNEX A.1.

## 5.4 Peak Output Power and E.I.R.P

### 5.4.1 Test Limit

FCC § 15.247(b)

For frequency hopping systems operating in the 2400-2483.5 MHz band employing at least 75 non-overlapping hopping channels band: 1 watt. For all other frequency hopping systems in the 2400-2483.5 MHz band: 0.125 watts.

RSS-247, 5.4 (b)

For FHSs operating in the band 2400-2483.5 MHz, the maximum peak conducted output power shall not exceed 1.0 W and the e.i.r.p. shall not exceed 4 W if the hopset uses 75 or more hopping channels; the maximum peak conducted output power shall not exceed 0.125 W and the e.i.r.p. shall not exceed 0.5 W if the hopset uses less than 75 hopping channels (see Section 5.4(5) for exceptions).

### 5.4.2 Test Setup

See section 4.4.1 for test setup description for the antenna port. The photo of test setup please refer to ANNEX B.

### 5.4.3 Test Procedure

The Module operates at hopping-off test mode. The lowest, middle and highest channels are selected to perform testing to verify the conducted RF output peak power of the Module.

Use the following spectrum analyzer settings:

Span = approximately 5 times the 20 dB bandwidth, centered on a hopping channel

RBW > the 20 dB bandwidth of the emission being measured

VBW  $\geq$  RBW

Sweep = auto

Detector function = peak

Trace = max hold

Allow the trace to stabilize.

### 5.4.4 Test Result

Please refer to ANNEX A.2.

## 5.5 Occupied Bandwidth

### 5.5.1 Limit

FCC §15.247(a); RSS-247, 5.1 (a)

Measurement of the 20dB bandwidth of the modulated signal.

### 5.5.2 Test Setup

See section 4.4.1 for test setup description for the antenna port. The photo of test setup please refer to ANNEX B.

### 5.5.3 Test Procedure

Use the following spectrum analyzer settings:

Span = approximately 2 to 5 times the 20 dB bandwidth, centered on a hopping channel

RBW = in the range of 1% to 5% of the OBW

VBW  $\geq$  RBW

Sweep = auto

Detector function = peak

Trace = max hold

The EUT should be transmitting at its maximum data rate, Allow the trace to stabilize.

### 5.5.4 Test Result

Please refer to ANNEX A.3.

## 5.6 Carrier Frequency Separation

### 5.6.1 Limit

FCC §15.247(a); RSS-247, 5.1 (b)

Frequency hopping systems shall have hopping channel carrier frequencies separated by a minimum of 25 kHz or the 2/3 of the 20 dB bandwidth of the hopping channel, whichever is greater.

### 5.6.2 Test Setup

See section 4.4.1 for test setup description for the antenna port. The photo of test setup please refer to ANNEX B.

### 5.6.3 Test Procedure

The EUT must have its hopping function enabled. Use the following spectrum analyzer settings:

Span = wide enough to capture the peaks of two adjacent channels

Resolution (or IF) Bandwidth (RBW)  $\geq$  1% of the span

Video (or Average) Bandwidth (VBW)  $\geq$  RBW

Sweep = auto

Detector function = peak

Trace = max hold

Allow the trace to stabilize. Use the marker-delta function to determine the separation between the peaks of the adjacent channels.

### 5.6.4 Test Result

Please refer to ANNEX A.4.

## 5.7 Time of Occupancy (Dwell time)

### 5.7.1 Limit

FCC §15.247(a); RSS-247, 5.1 (d)

Frequency hopping systems in the 2400 MHz - 2483.5 MHz band shall use at least 15 non-overlapping channels. The average time of occupancy on any channel shall not be greater than 0.4 seconds within a period of 0.4 seconds multiplied by the number of hopping channels employed. Frequency hopping systems may avoid or suppress transmissions on a particular hopping frequency provided that a minimum of 15 channels are used.

### 5.7.2 Test Setup

See section 4.4.1 for test setup description for the antenna port. The photo of test setup please refer to ANNEX B.

### 5.7.3 Test Procedure

The EUT shall have its hopping function enabled. Use the following spectrum analyzer settings:

Span: Zero span, centered on a hopping channel

RBW shall be  $\leq$  channel spacing and where possible RBW should be set  $\gg 1 / T$ , where T is the expected dwell time per channel

Sweep: As necessary to capture the entire dwell time per hopping channel; where possible use a video trigger and trigger delay so that the transmitted signal starts a little to the right of the start of the plot. The trigger level might need slight adjustment to prevent triggering when the system hops on an adjacent channel; a second plot might be needed with a longer sweep time to show two successive hops on a channel

Detector function: Peak

Trace: Max hold

Use the marker-delta function to determine the transmit time per hop. If this value varies with different modes of operation (data rate, modulation format, number of hopping channels, etc.), then repeat this test for each variation in transmit time.

The average time of occupancy on any channel within the Period can be calculated with formulas:

For GFSK and 8-DPSK:

For DH1 package type

$$\begin{aligned}\{\text{Total of Dwell}\} &= \{\text{Pulse Time}\} * (1600 / 2) / \{\text{Number of Hopping Frequency}\} * \{\text{Period}\} \\ \{\text{Period}\} &= 0.4 \text{ s} * \{\text{Number of Hopping Frequency}\}\end{aligned}$$

For DH3 package type

$$\begin{aligned}\{\text{Total of Dwell}\} &= \{\text{Pulse Time}\} * (1600 / 4) / \{\text{Number of Hopping Frequency}\} * \{\text{Period}\} \\ \{\text{Period}\} &= 0.4 \text{ s} * \{\text{Number of Hopping Frequency}\}\end{aligned}$$

For DH5 package type

$$\begin{aligned}\{\text{Total of Dwell}\} &= \{\text{Pulse Time}\} * (1600 / 6) / \{\text{Number of Hopping Frequency}\} * \{\text{Period}\} \\ \{\text{Period}\} &= 0.4 \text{ s} * \{\text{Number of Hopping Frequency}\}\end{aligned}$$

For AFH Mode:

For DH1 package type

$$\begin{aligned}\{\text{Total of Dwell}\} &= \{\text{Pulse Time}\} * (800 / 2) / \{\text{Number of Hopping Frequency}\} * \{\text{Period}\} \\ \{\text{Period}\} &= 0.4 \text{ s} * \{\text{Number of Hopping Frequency}\}\end{aligned}$$

For DH3 package type

$$\begin{aligned}\{\text{Total of Dwell}\} &= \{\text{Pulse Time}\} * (800 / 4) / \{\text{Number of Hopping Frequency}\} * \{\text{Period}\} \\ \{\text{Period}\} &= 0.4 \text{ s} * \{\text{Number of Hopping Frequency}\}\end{aligned}$$

For DH5 package type

$$\{\text{Total of Dwell}\} = \{\text{Pulse Time}\} * (800 / 6) / \{\text{Number of Hopping Frequency}\} * \{\text{Period}\}$$



{Period} = 0.4 s \* {Number of Hopping Frequency}

The lowest, middle and highest channels are selected to perform testing to record the dwell time of each occupation measured in this channel, which is called Pulse Time here.

#### 5.7.4 Test Result

Please refer to ANNEX A.5

## 5.8 Conducted Spurious Emission & Authorized-band band-edge

### 5.8.1 Limit

FCC §15.247(d); RSS-247, 5.5

In any 100 kHz bandwidth outside the frequency band in which the spread spectrum or digitally modulated intentional radiator is operating, the radio frequency power that is produced by the intentional radiator shall be at least 20 dB below that in the 100 kHz bandwidth within the band that contains the highest level of the desired power, based on either an RF conducted or a radiated measurement.

### 5.8.2 Test Setup

See section 4.4.1 for test setup description for the antenna port. The photo of test setup please refer to ANNEX B.

### 5.8.3 Test Procedure

Use the following spectrum analyzer settings:

Span = wide enough to capture the peak level of the in-band emission and all spurious emissions (e.g., harmonics) from the lowest frequency generated in the EUT up through the 10th harmonic. Typically, several plots are required to cover this entire span.

RBW = 100 kHz

VBW = 300 kHz

Sweep = auto

Detector function = peak

Trace = max hold

Allow the trace to stabilize

### 5.8.4 Test Result

Please refer to ANNEX A.6.

## 5.9 Conducted Emission

### 5.9.1 Limit

FCC §15.207; RSS-GEN, 8.8

For an intentional radiator that is designed to be connected to the public utility (AC) power line, the radio frequency voltage that is conducted back onto the AC power line on any frequency within the band 150 kHz to 30 MHz shall not exceed the limits in the following table, as measured using a 50 $\mu$ H/50 $\Omega$  line impedance stabilization network (LISN).

Frequency range (MHz)	Conducted Limit (dB $\mu$ V)	
	Quai-peak	Average
0.15 - 0.50	66 to 56	56 to 46
0.50 - 5	56	46
0.50 - 30	60	50

### 5.9.2 Test Setup

See section 4.4.2 for test setup description for the AC power supply port. The photo of test setup please refer to ANNEX B.

### 5.9.3 Test Procedure

The maximum conducted interference is searched using Peak (PK), if the emission levels more than the AV and QP limits, and that have narrow margins from the AV and QP limits will be re-measured with AV and QP detectors. Tests for both L phase and N phase lines of the power mains connected to the EUT are performed. Refer to recorded points and plots below.

Devices subject to Part 15 must be tested for all available U.S. voltages and frequencies (such as a nominal 120 VAC, 50/60 Hz and 240 VAC, 50/60 Hz) for which the device is capable of operation. A device rated for 50/60 Hz operation need not be tested at both frequencies provided the radiated and line conducted emissions are the same at both frequencies.

### 5.9.4 Test Result

Please refer to ANNEX A.7.

## 5.10 Radiated Spurious Emission

### 5.10.1 Limit

FCC §15.209&15.247(d); RSS-247, 5.5

Radiated emission outside the frequency band attenuation below the general limits specified in FCC section 15.209(a) is not required. In addition, radiated emissions which fall in the restricted bands, as defined in FCC section 15.205(a), must also comply with the radiated emission limits specified in FCC section 15.209(a).

According to FCC section 15.209 (a), except as provided elsewhere in this subpart, the emissions from an intentional radiator shall not exceed the field strength levels specified in the following table:

Frequency (MHz)	Field Strength ( $\mu\text{V}/\text{m}$ )	Measurement Distance (m)
0.009 - 0.490	2400/F(kHz)	300
0.490 - 1.705	24000/F(kHz)	30
1.705 - 30.0	30	30
30 - 88	100	3
88 - 216	150	3
216 - 960	200	3
Above 960	500	3

Note:

1. Field Strength (dB $\mu\text{V}/\text{m}$ ) = 20\*log[Field Strength ( $\mu\text{V}/\text{m}$ )].
2. In the emission tables above, the tighter limit applies at the band edges.
3. For Above 1000 MHz, the emission limit in this paragraph is based on measurement instrumentation employing an average detector, measurement using instrumentation with a peak detector function, corresponding to 20dB above the maximum permitted average limit.
4. For above 1000 MHz, limit field strength of harmonics: 54dBuV/m@3m (AV) and 74dBuV/m@3m (PK).

### 5.10.2 Test Setup

See section 4.4.3 to 4.4.5 for test setup description for the antenna port. The photo of test setup please refer to ANNEX B.

### 5.10.3 Test Procedure

The measurement frequency range is from 9 kHz to the 10th harmonic of the fundamental frequency. The Turn Table is actuated to turn from 0° to 360°, and both horizontal and vertical polarizations of the Test Antenna are used to find the maximum radiated power. Mid channels on all channel bandwidth verified. Only the worst RB size/offset presented.

The power of the EUT transmitting frequency should be ignored.

All Spurious Emission tests were performed in X, Y, Z axis direction. And only the worst axis test condition was recorded in this test report.

Use the following spectrum analyzer settings:

Span = wide enough to fully capture the emission being measured

RBW = 1 MHz for  $f \geq 1$  GHz, 100 kHz for  $f < 1$  GHz

VBW  $\geq$  RBW

Sweep = auto

Detector function = peak

Trace = max hold

For measurement below 1GHz, If the emission level of the EUT measured by the peak detector is 3 dB lower than the applicable limit, the peak emission level will be reported, Otherwise, the emission measurement will be repeated using the quasi-peak detector and reported.

#### 5.10.4 Test Result

Please refer to ANNEX A.8.

## 5.11 Band Edge (Restricted-band band-edge)

### 5.11.1 Limit

FCC §15.209&15.247(d)

Radiated emission outside the frequency band attenuation below the general limits specified in FCC section 15.209(a) is not required. In addition, radiated emissions which fall in the restricted bands, as defined in FCC section 15.205(a), must also comply with the radiated emission limits specified in FCC section 15.209(a).

### 5.11.2 Test Setup

See section 4.4.3 to 4.4.5 for test setup description for the antenna port. The photo of test setup please refer to ANNEX B.

### 5.11.3 Test Procedure

The measurement frequency range is from 9 kHz to the 10th harmonic of the fundamental frequency. The Turn Table is actuated to turn from 0° to 360°, and both horizontal and vertical polarizations of the Test Antenna are used to find the maximum radiated power. Mid channels on all channel bandwidth verified. Only the worst RB size/offset presented.

The power of the EUT transmitting frequency should be ignored.

All Spurious Emission tests were performed in X, Y, Z axis direction. And only the worst axis test condition was recorded in this test report.

Use the following spectrum analyzer settings:

Span = wide enough to fully capture the emission being measured

RBW = 1 MHz for  $f \geq 1$  GHz, 100 kHz for  $f < 1$  GHz

VBW  $\geq$  RBW

Sweep = auto

Detector function = peak

Trace = max hold

For measurement below 1GHz, If the emission level of the EUT measured by the peak detector is 3 dB lower than the applicable limit, the peak emission level will be reported, Otherwise, the emission measurement will be repeated using the quasi-peak detector and reported.

### 5.11.4 Test Result

Please refer to ANNEX A.9.

## ANNEX A TEST RESULT

### A.1 Number of Hopping Frequency

Note: The Number of Hopping Frequency please refer to the Report No. FR741007A (FCC ID: XMR201706SC20A) (which issued by Sporton International (KunShan) INC. on Aug. 11, 2017), **Section 3.1 Number of Channel Measurement.**

### A.2 Peak Output Power

Note: The Peak Output Power please refer to the Report No. FR741007A (FCC ID: XMR201706SC20A) (which issued by Sporton International (KunShan) INC. on Aug. 11, 2017), **Section 3.5 Peak Output Power Measurement.**

### A.3 20 dB and 99% bandwidth

Note: The 20 dB and 99% bandwidth please refer to the Report No. FR741007A (FCC ID: XMR201706SC20A) (which issued by Sporton International (KunShan) INC. on Aug. 11, 2017), **Section 3.4 20 dB Bandwidth Measurement.**

### A.4 Hopping Frequency Separation

Note: The Hopping Frequency Separation please refer to the Report No. FR741007A (FCC ID: XMR201706SC20A) (which issued by Sporton International (KunShan) INC. on Aug. 11, 2017), **Section 3.2 Hopping Channel Separation Measurement.**

### A.5 Average Time of Occupancy

Note: The Average Time of Occupancy please refer to the Report No. FR741007A (FCC ID: XMR201706SC20A) (which issued by Sporton International (KunShan) INC. on Aug. 11, 2017), **Section 3.3 Dwell Time Measurement.**

### A.6 Conducted Spurious Emissions & Authorized-band band-edge

Note: The Conducted Spurious Emissions & Authorized-band band-edge please refer to the Report No. FR741007A (FCC ID: XMR201706SC20A) (which issued by Sporton International (KunShan) INC. on Aug. 11, 2017), **Section 3.6 Conducted Band Edges Measurement.**

## A.7 Conducted Emissions

Note 1: The EUT is working in the Normal link mode.

Note 2: Devices subject to Part 15 must be tested for all available U.S. voltages and frequencies (such as a nominal 120 VAC, 60 Hz and 240 VAC, 50 Hz) for which the device is capable of operation. So, The configuration 120 VAC, 60 Hz and 240 VAC, 50 Hz were tested respectively, but only the worst configuration (120 VAC, 60 Hz ) shown here.

Note 3: Results (dBuV) = Original reading level of Spectrum Analyzer (dBuV) + Factor (dB)

### Test Data and Plots

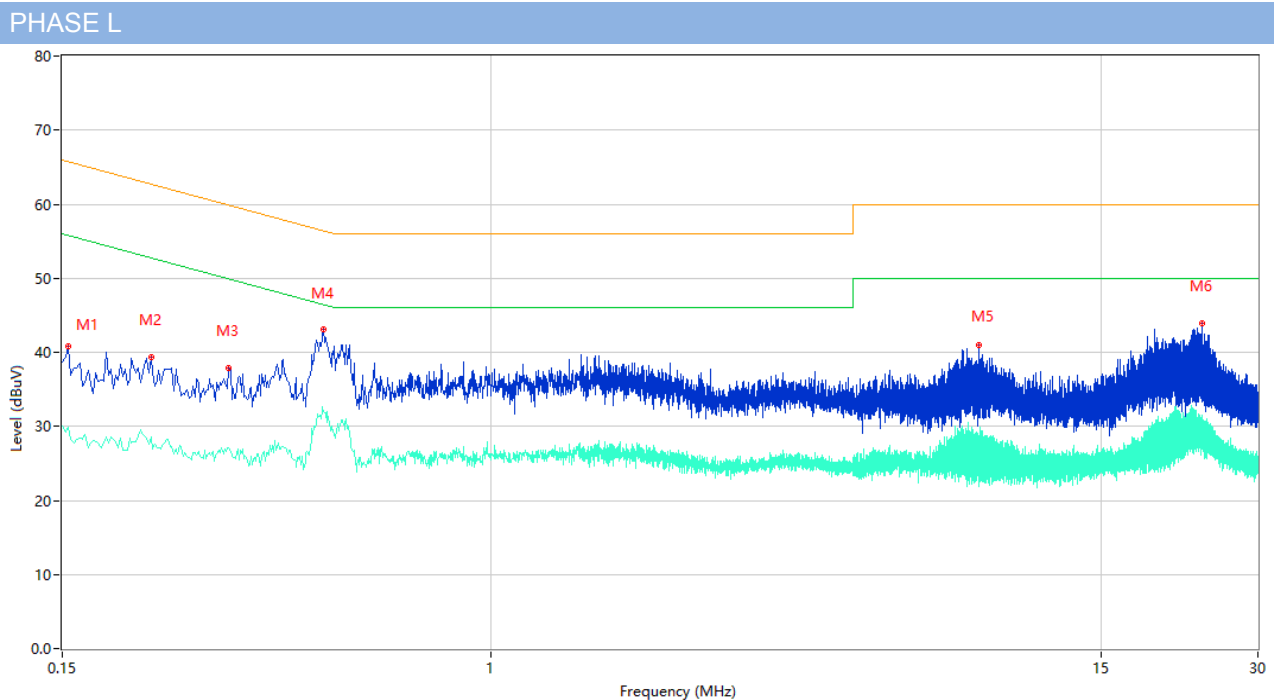

No.	Frequency (MHz)	Results (dBuV)	Factor (dB)	Limit (dBuV)	Over Limit (dB)	Detector	Line	Verdict
1	0.150	38.63	10.41	66.00	-27.37	Peak	L	Pass
1**	0.150	30.06	10.41	56.00	-25.94	AV	L	Pass
2	0.222	39.33	10.37	62.74	-23.41	Peak	L	Pass
2**	0.222	28.57	10.37	52.74	-24.17	AV	L	Pass
3	0.314	37.89	10.33	59.86	-21.97	Peak	L	Pass
3**	0.314	27.18	10.33	49.86	-22.68	AV	L	Pass
4	0.478	43.05	10.29	56.37	-13.32	Peak	L	Pass
4**	0.478	31.98	10.29	46.37	-14.39	AV	L	Pass
5	8.694	41.01	10.36	60.00	-18.99	Peak	L	Pass
5**	8.694	28.54	10.36	50.00	-21.46	AV	L	Pass
6	23.380	43.85	10.62	60.00	-16.15	Peak	L	Pass
6**	23.380	28.53	10.62	50.00	-21.47	AV	L	Pass



## PHASE N

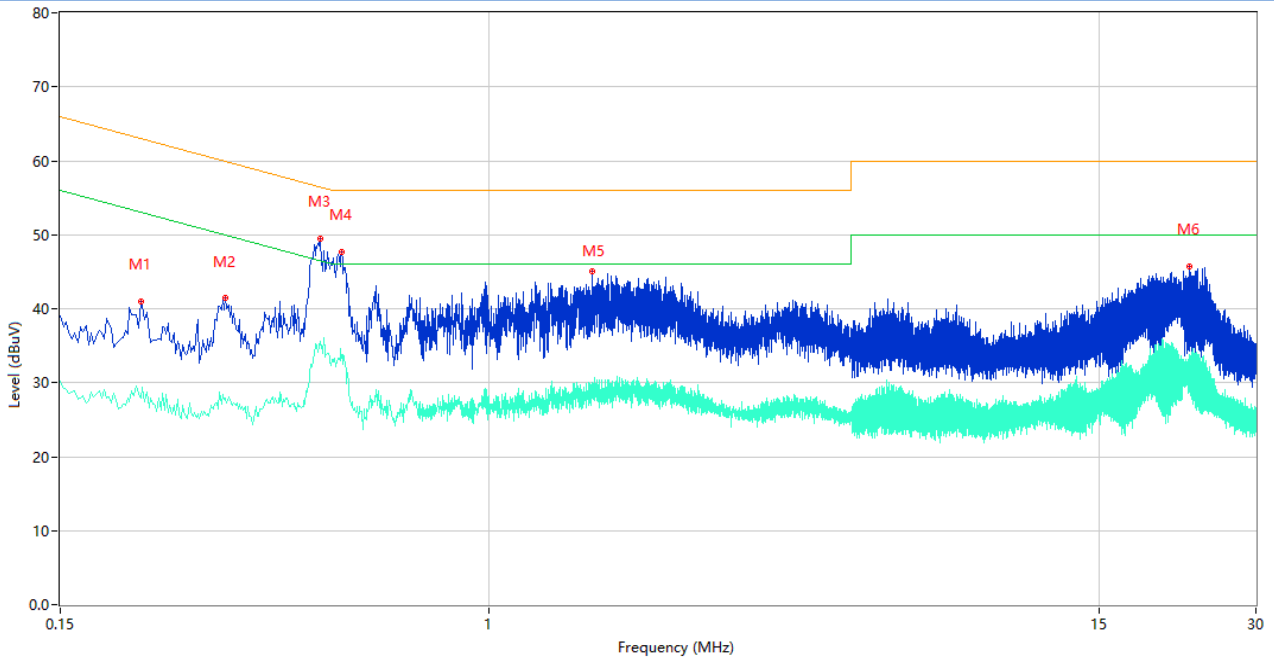

No.	Frequency (MHz)	Results (dBuV)	Factor (dB)	Limit (dBuV)	Over Limit (dB)	Detector	Line	Verdict
1	0.214	41.00	10.38	63.05	-22.05	Peak	N	Pass
1**	0.214	27.88	10.38	53.05	-25.17	AV	N	Pass
2	0.312	41.40	10.33	59.92	-18.52	Peak	N	Pass
2**	0.312	27.90	10.33	49.92	-22.02	AV	N	Pass
3	0.474	49.48	10.30	56.44	-6.96	Peak	N	Pass
3**	0.474	35.56	10.30	46.44	-10.88	AV	N	Pass
4	0.522	47.69	10.30	56.00	-8.31	Peak	N	Pass
4**	0.522	33.28	10.30	46.00	-12.72	AV	N	Pass
5	1.588	45.14	10.25	56.00	-10.86	Peak	N	Pass
5**	1.588	29.90	10.25	46.00	-16.10	AV	N	Pass
6	22.326	45.70	10.59	60.00	-14.30	Peak	N	Pass
6**	22.326	32.03	10.59	50.00	-17.97	AV	N	Pass

## A.8 Radiated Spurious Emission

### Test Data and Plots

Note 1: The symbol of "--" in the table which means not application.

Note 2: For the test data above 1 GHz, according the ANSI C63.10-2013, where limits are specified for both average and peak (or quasi-peak) detector functions, if the peak (or quasi-peak) measured value complies with the average limit, it is unnecessary to perform an average measurement.

Note 3: The EUT is working in the Normal link mode below 1 GHz.

Note 4: Results (dBuV/m) = Original reading level of Spectrum Analyzer (dBuV/m) + Factor (dB)

The low frequency, which started from 9 kHz to 30 MHz, was pre-scanned and the result which was 20 dB lower than the limit line per 15.31(o) was not reported.

30 MHz to 1 GHz, ANT H

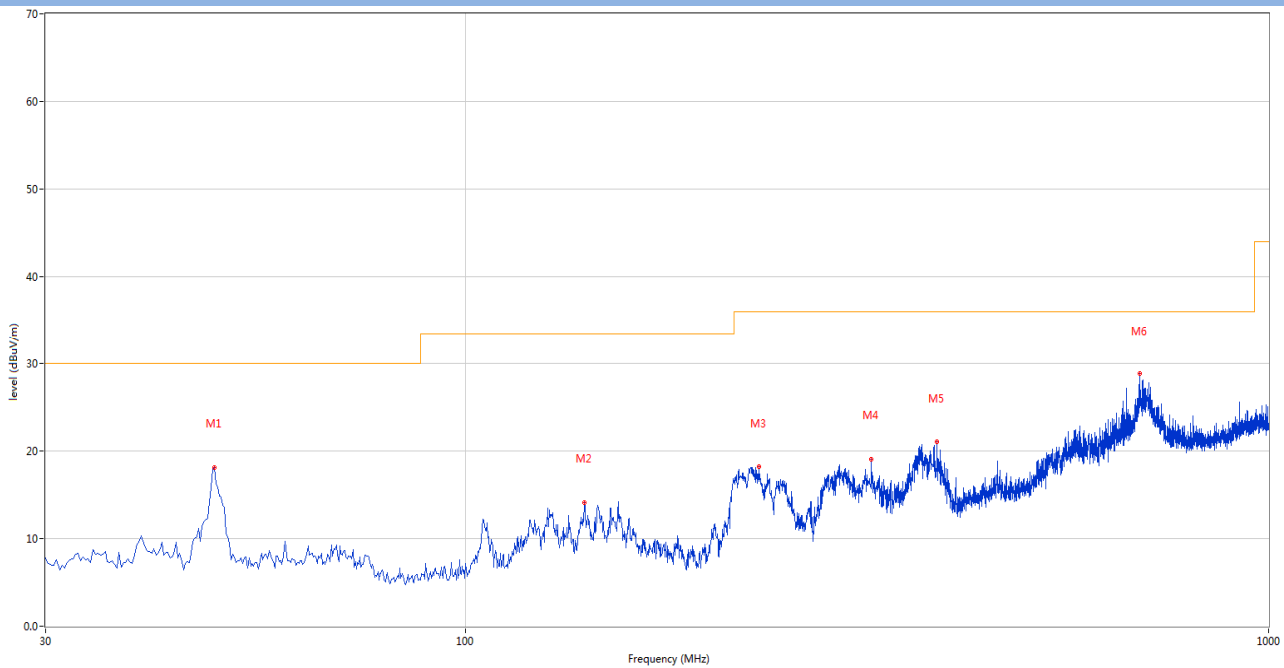

No.	Frequency (MHz)	Results (dBuV/m)	Factor (dB)	Limit (dBuV/m)	Over Limit (dB)	Detector	Table (Degree)	Height (cm)	Antenna	Verdict
1	48.668	18.15	-27.27	30.0	-11.85	Peak	327.00	100	Horizontal	Pass
2	140.552	14.12	-26.37	33.5	-19.38	Peak	150.00	400	Horizontal	Pass
3	232.194	18.21	-28.12	36.0	-17.79	Peak	241.00	400	Horizontal	Pass
4	319.958	19.07	-25.31	36.0	-16.93	Peak	119.00	300	Horizontal	Pass
5	386.386	21.03	-23.39	36.0	-14.97	Peak	270.00	300	Horizontal	Pass
6	691.132	28.83	-16.10	36.0	-7.17	Peak	161.00	100	Horizontal	Pass

## 30 MHz to 1 GHz, ANT V

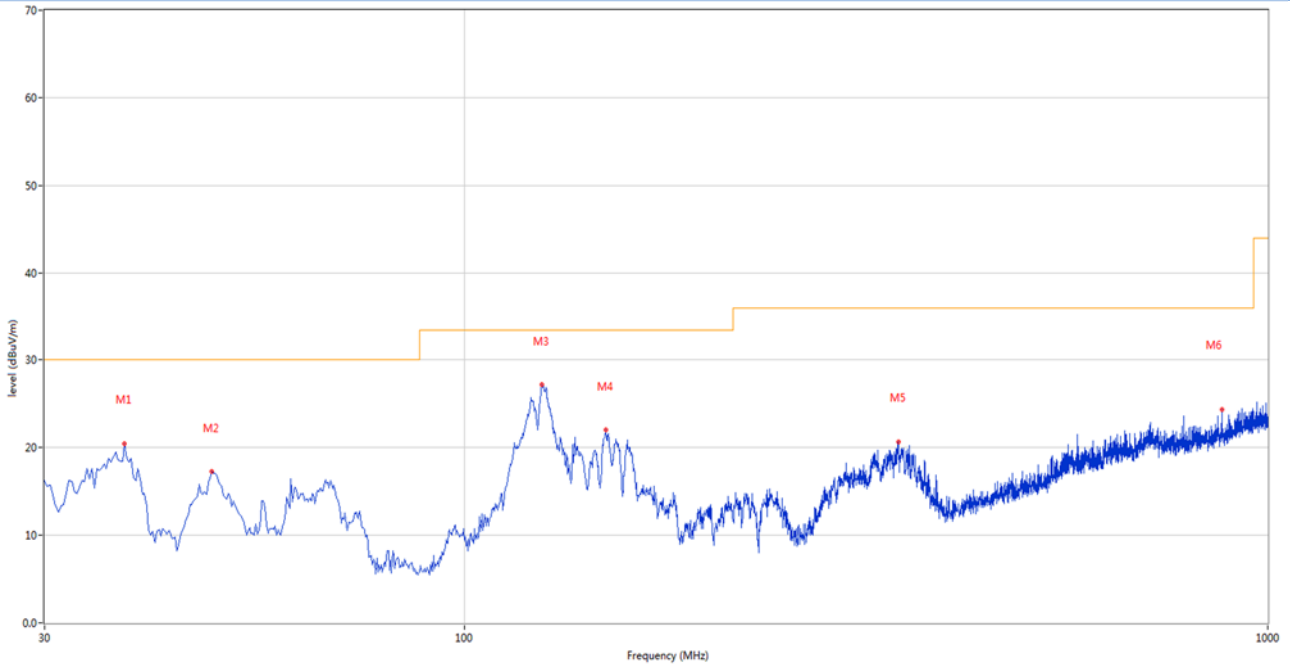

No.	Frequency (MHz)	Results (dBuV/m)	Factor (dB)	Limit (dBuV/m)	Over Limit (dB)	Detector	Table (Degree)	Height (cm)	Antenna	Verdict
1	37.758	20.40	-27.03	30.0	-9.60	Peak	317.00	100	Vertical	Pass
2	48.425	17.26	-27.24	30.0	-12.74	Peak	196.00	300	Vertical	Pass
3	124.794	27.21	-27.67	33.5	-6.29	Peak	161.00	100	Vertical	Pass
4	150.007	21.99	-25.94	33.5	-11.51	Peak	95.00	100	Vertical	Pass
5	346.626	20.65	-24.47	36.0	-15.35	Peak	171.00	100	Vertical	Pass
6	877.568	24.28	-12.80	36.0	-11.72	Peak	360.00	200	Vertical	Pass

Test Data and Plots (1 GHz ~ 10th Harmonic)

Note 1: The marked spikes near 2400 MHz with circle should be ignored because they are Fundamental signal.

Note 2: The spurious from 18GHz-25GHz is noise only, do not show on the report.

GFSK LOW CHANNEL 1 GHz to 18 GHz, ANT H

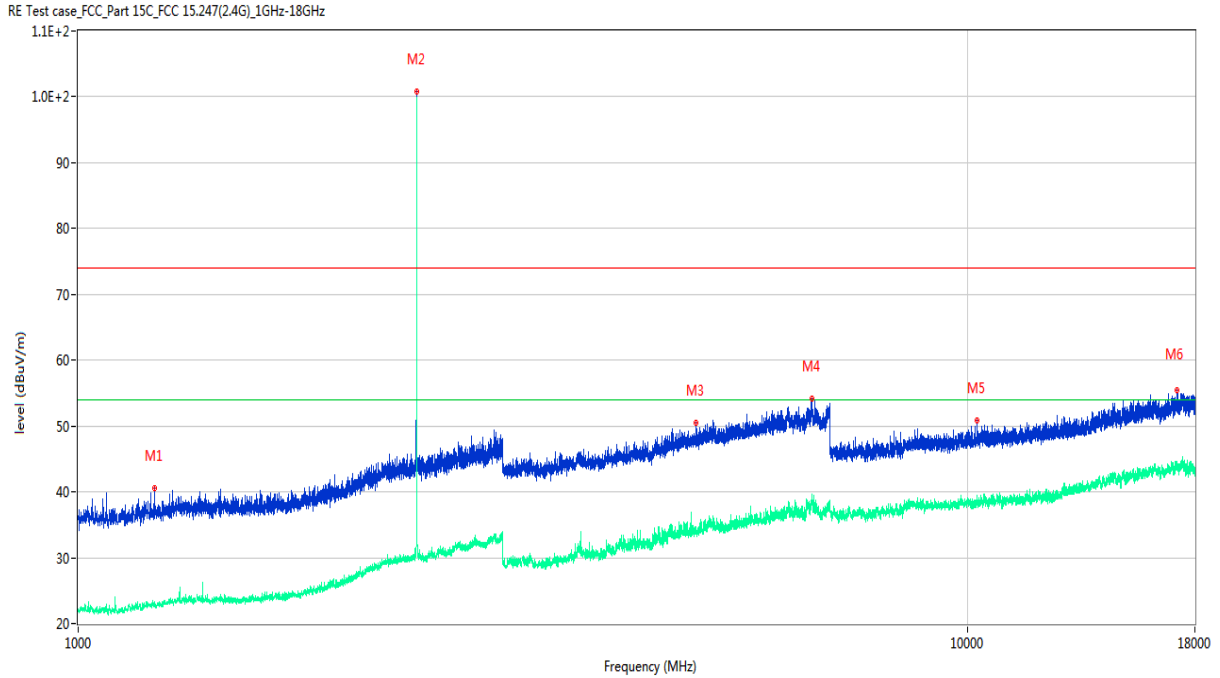

No.	Frequency (MHz)	Results (dBuV/m)	Factor (dB)	Limit (dBuV/m)	Over Limit (dB)	Detector	Table (Degree)	Height (cm)	Antenna	Verdict
1	1219.500	40.62	-17.73	74.0	-33.38	Peak	207.00	150	Horizontal	Pass
1**	1219.500	22.56	-17.73	54.0	-31.44	AV	207.00	150	Horizontal	Pass
2	2402.000	100.76	-11.82	74.0	26.76	Peak	139.00	150	Horizontal	N/A
2**	2402.000	96.18	-11.82	54.0	42.18	AV	139.00	150	Horizontal	N/A
3	4945.000	50.42	-3.20	74.0	-23.58	Peak	331.00	150	Horizontal	Pass
3**	4945.000	33.94	-3.20	54.0	-20.06	AV	331.00	150	Horizontal	Pass
4	6679.000	54.19	0.14	74.0	-19.81	Peak	234.00	150	Horizontal	Pass
4**	6679.000	38.53	0.14	54.0	-15.47	AV	234.00	150	Horizontal	Pass
5	10250.188	50.91	1.18	74.0	-23.09	Peak	26.00	150	Horizontal	Pass
5**	10250.188	38.26	1.18	54.0	-15.74	AV	26.00	150	Horizontal	Pass
6	17179.688	55.37	3.31	74.0	-18.63	Peak	359.00	150	Horizontal	Pass
6**	17179.688	43.98	3.31	54.0	-10.02	AV	359.00	150	Horizontal	Pass

GFSK LOW CHANNEL 1 GHz to 18 GHz, ANT V

RE Test case\_FCC\_Part 15C\_FCC 15.247(2.4G)\_1GHz-18GHz

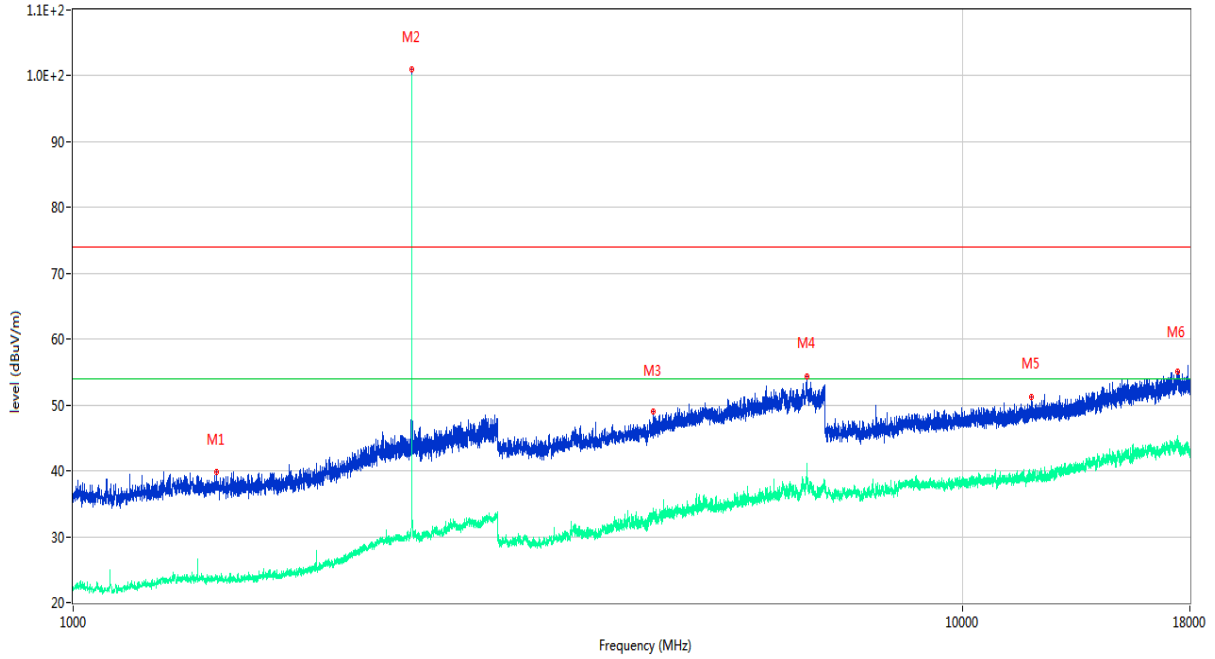

No.	Frequency (MHz)	Results (dBuV/m)	Factor (dB)	Limit (dBuV/m)	Over Limit (dB)	Detector	Table (Degree)	Height (cm)	Antenna	Verdict
1	1448.500	39.80	-17.01	74.0	-34.20	Peak	343.00	150	Vertical	Pass
1**	1448.500	23.97	-17.01	54.0	-30.03	AV	343.00	150	Vertical	Pass
2	2402.000	101.05	-11.82	74.0	27.05	Peak	343.00	150	Vertical	N/A
2**	2402.000	96.33	-11.82	54.0	42.33	AV	343.00	150	Vertical	N/A
3	4487.000	49.02	-4.38	74.0	-24.98	Peak	172.00	150	Vertical	Pass
3**	4487.000	33.12	-4.38	54.0	-20.88	AV	172.00	150	Vertical	Pass
4	6676.000	54.43	0.41	74.0	-19.57	Peak	137.00	150	Vertical	Pass
4**	6676.000	38.82	0.41	54.0	-15.18	AV	137.00	150	Vertical	Pass
5	11933.500	51.31	1.78	74.0	-22.69	Peak	88.00	150	Vertical	Pass
5**	11933.500	39.01	1.78	54.0	-14.99	AV	88.00	150	Vertical	Pass
6	17439.562	55.01	4.15	74.0	-18.99	Peak	194.00	150	Vertical	Pass
6**	17439.562	44.28	4.15	54.0	-9.72	AV	194.00	150	Vertical	Pass

GFSK MIDDLE CHANNEL 1 GHz to 18 GHz, ANT H

RE Test case\_FCC\_Part 15C\_FCC 15.247(2.4G)\_1GHz-18GHz

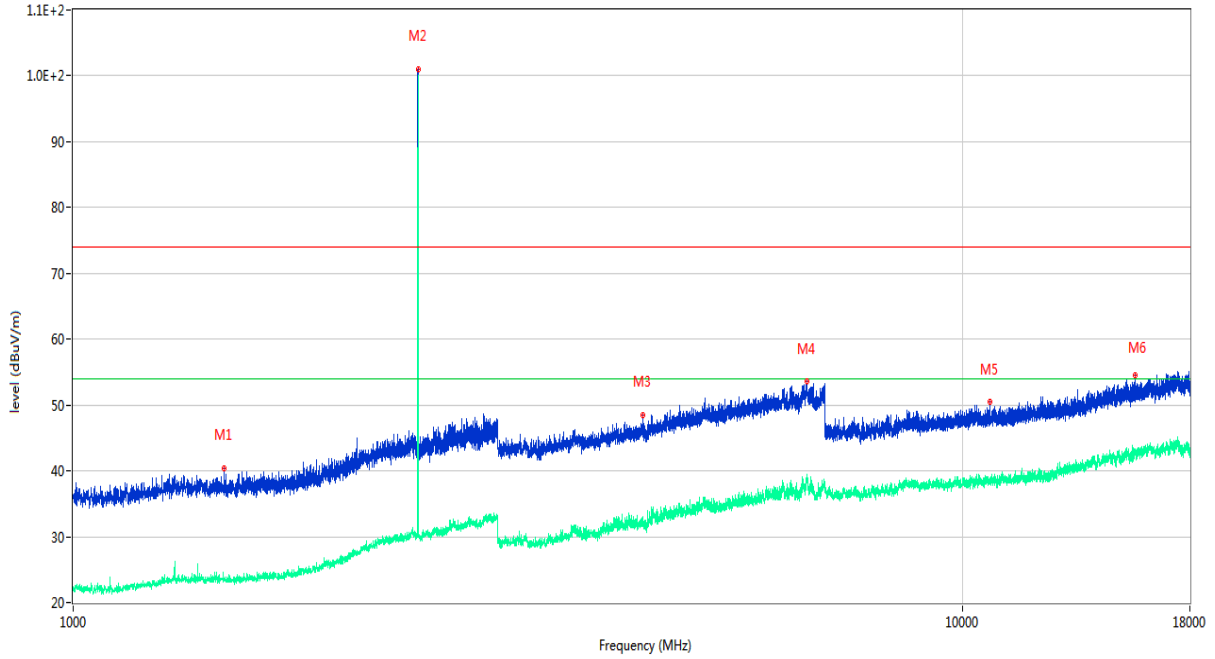

No.	Frequency (MHz)	Results (dBuV/m)	Factor (dB)	Limit (dBuV/m)	Over Limit (dB)	Detector	Table (Degree)	Height (cm)	Antenna	Verdict
1	1477.500	40.44	-17.35	74.0	-33.56	Peak	19.00	150	Horizontal	Pass
1**	1477.500	23.53	-17.35	54.0	-30.47	AV	19.00	150	Horizontal	Pass
2	2441.000	101.08	-12.60	74.0	27.08	Peak	140.00	150	Horizontal	N/A
2**	2441.000	95.89	-12.60	54.0	41.89	AV	140.00	150	Horizontal	N/A
3	4368.000	48.55	-4.07	74.0	-25.45	Peak	190.00	150	Horizontal	Pass
3**	4368.000	32.37	-4.07	54.0	-21.63	AV	190.00	150	Horizontal	Pass
4	6678.000	53.70	0.29	74.0	-20.30	Peak	0.00	150	Horizontal	Pass
4**	6678.000	38.22	0.29	54.0	-15.78	AV	0.00	150	Horizontal	Pass
5	10738.938	50.54	-0.29	74.0	-23.46	Peak	213.00	150	Horizontal	Pass
5**	10738.938	38.46	-0.29	54.0	-15.54	AV	213.00	150	Horizontal	Pass
6	15621.750	54.48	2.60	74.0	-19.52	Peak	171.00	150	Horizontal	Pass
6**	15621.750	42.59	2.60	54.0	-11.41	AV	171.00	150	Horizontal	Pass

GFSK MIDDLE CHANNEL 1 GHz to 18 GHz, ANT V

RE Test case\_FCC\_Part 15C\_FCC 15.247(2.4G)\_1GHz-18GHz

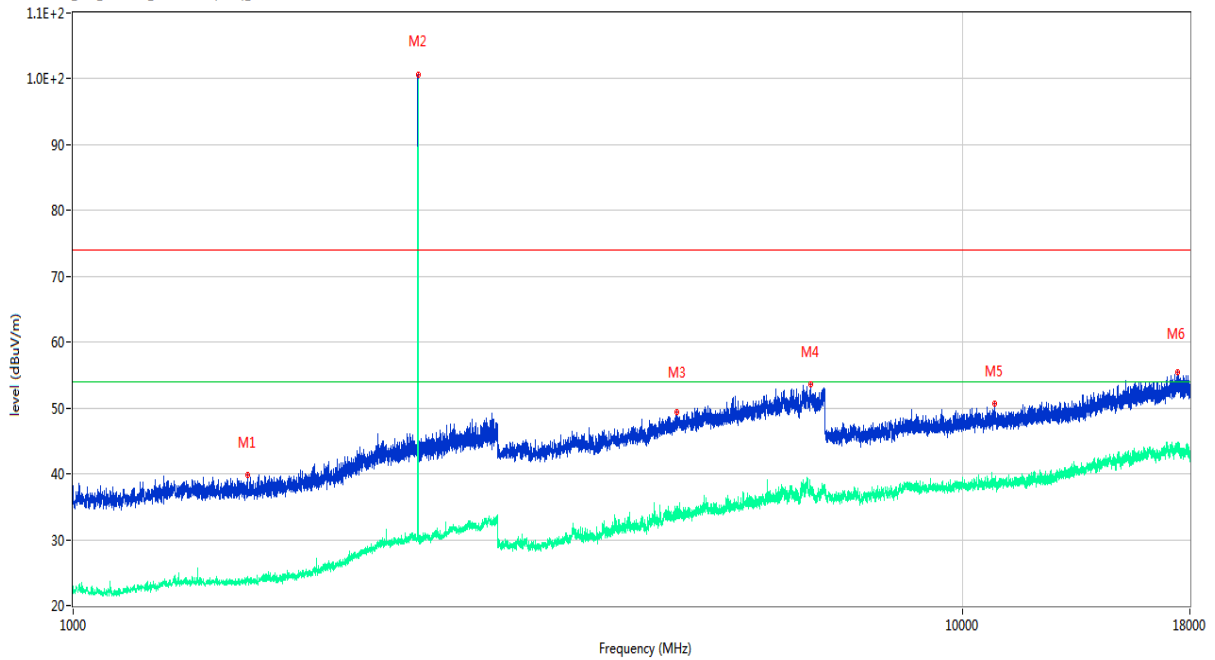

No.	Frequency (MHz)	Results (dBuV/m)	Factor (dB)	Limit (dBuV/m)	Over Limit (dB)	Detector	Table (Degree)	Height (cm)	Antenna	Verdict
1	1570.500	39.85	-17.07	74.0	-34.15	Peak	68.00	150	Vertical	Pass
1**	1570.500	23.75	-17.07	54.0	-30.25	AV	68.00	150	Vertical	Pass
2	2441.000	100.72	-12.60	74.0	26.72	Peak	345.00	150	Vertical	N/A
2**	2441.000	95.73	-12.60	54.0	41.73	AV	345.00	150	Vertical	N/A
3	4769.000	49.39	-3.02	74.0	-24.61	Peak	48.00	150	Vertical	Pass
3**	4769.000	33.23	-3.02	54.0	-20.77	AV	48.00	150	Vertical	Pass
4	6747.000	53.66	0.14	74.0	-20.34	Peak	359.00	150	Vertical	Pass
4**	6747.000	38.20	0.14	54.0	-15.80	AV	359.00	150	Vertical	Pass
5	10862.562	50.63	0.55	74.0	-23.37	Peak	170.00	150	Vertical	Pass
5**	10862.562	38.42	0.55	54.0	-15.58	AV	170.00	150	Vertical	Pass
6	17429.062	55.40	4.58	74.0	-18.60	Peak	122.00	150	Vertical	Pass
6**	17429.062	44.21	4.58	54.0	-9.79	AV	122.00	150	Vertical	Pass

GFSK HIGH CHANNEL 1 GHz to 18 GHz, ANT H

RE Test case\_FCC\_Part 15C\_FCC 15.247(2.4G)\_1GHz-18GHz

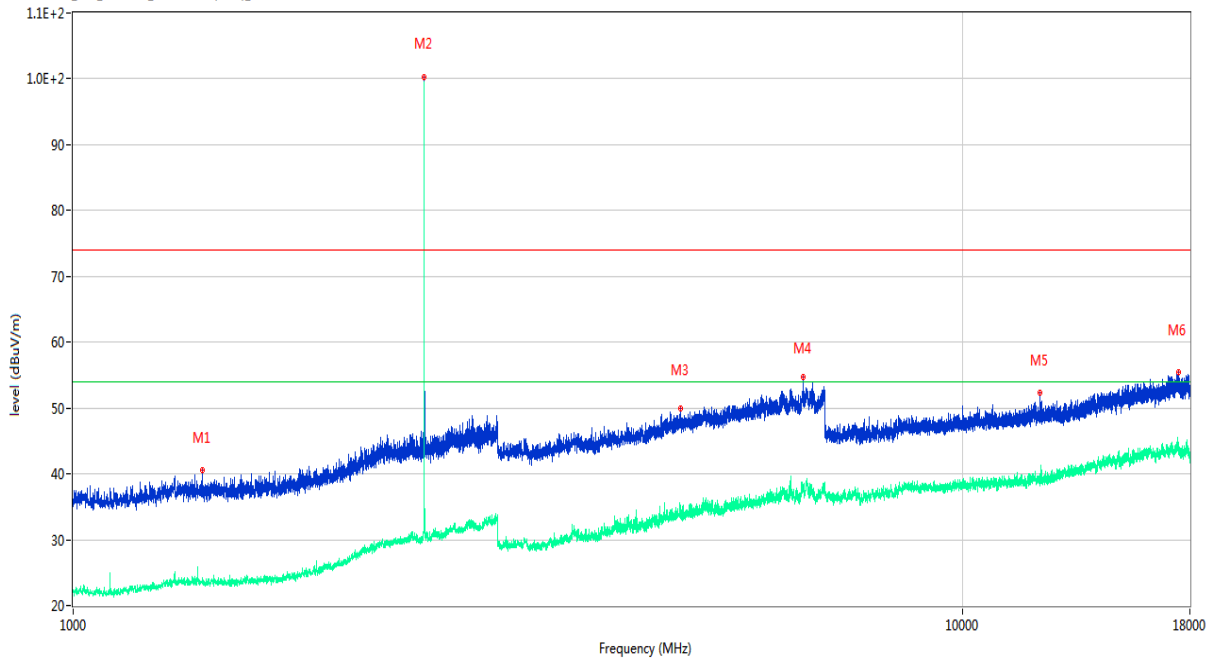

No.	Frequency (MHz)	Results (dBuV/m)	Factor (dB)	Limit (dBuV/m)	Over Limit (dB)	Detector	Table (Degree)	Height (cm)	Antenna	Verdict
1	1395.500	40.54	-17.05	74.0	-33.46	Peak	191.00	150	Horizontal	Pass
1**	1395.500	23.59	-17.05	54.0	-30.41	AV	191.00	150	Horizontal	Pass
2	2479.500	100.23	-11.99	74.0	26.23	Peak	138.00	150	Horizontal	N/A
2**	2479.500	82.17	-11.99	54.0	28.17	AV	138.00	150	Horizontal	N/A
3	4818.000	49.86	-3.14	74.0	-24.14	Peak	235.00	150	Horizontal	Pass
3**	4818.000	34.15	-3.14	54.0	-19.85	AV	235.00	150	Horizontal	Pass
4	6613.000	54.66	0.35	74.0	-19.34	Peak	253.00	150	Horizontal	Pass
4**	6613.000	37.71	0.35	54.0	-16.29	AV	253.00	150	Horizontal	Pass
5	12223.875	52.40	1.69	74.0	-21.60	Peak	2.00	150	Horizontal	Pass
5**	12223.875	39.69	1.69	54.0	-14.31	AV	2.00	150	Horizontal	Pass
6	17464.500	55.41	3.84	74.0	-18.59	Peak	-2.00	150	Horizontal	Pass
6**	17464.500	43.86	3.84	54.0	-10.14	AV	-2.00	150	Horizontal	Pass



GFSK HIGH CHANNEL 1 GHz to 18 GHz, ANT V

RE Test case\_FCC\_Part 15C\_FCC 15.247(2.4G)\_1GHz-18GHz

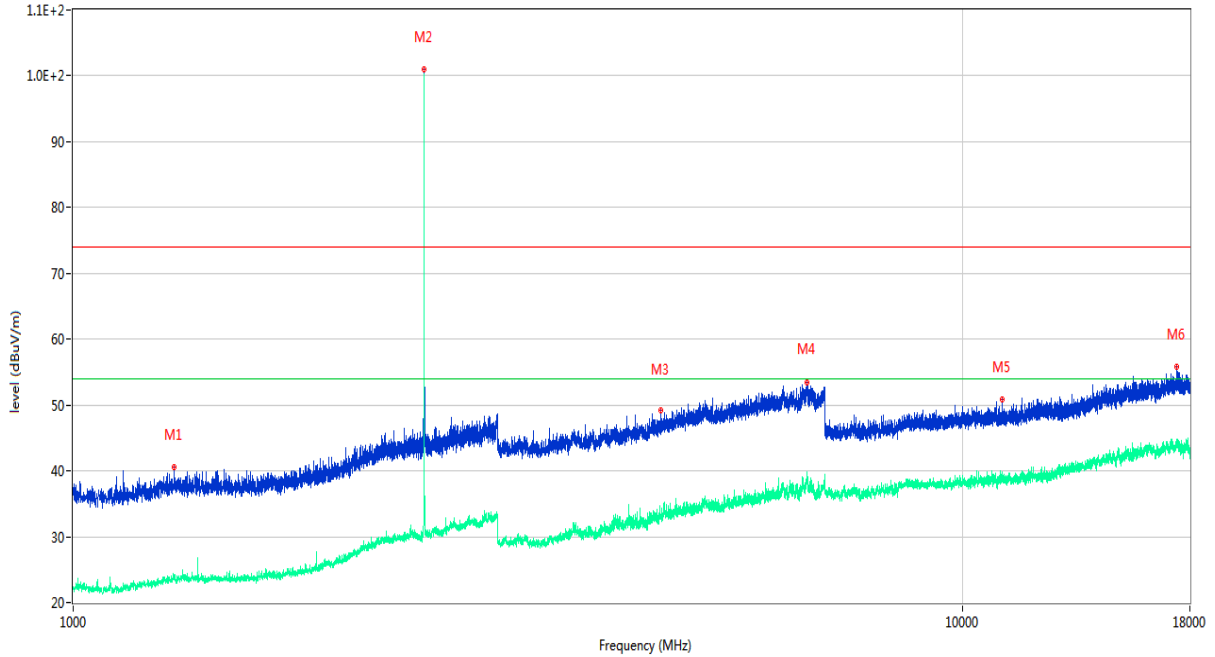

No.	Frequency (MHz)	Results (dBuV/m)	Factor (dB)	Limit (dBuV/m)	Over Limit (dB)	Detector	Table (Degree)	Height (cm)	Antenna	Verdict
1	1298.000	40.50	-17.02	74.0	-33.50	Peak	214.00	150	Vertical	Pass
1**	1298.000	23.50	-17.02	54.0	-30.50	AV	214.00	150	Vertical	Pass
2	2480.000	101.01	-11.99	74.0	27.01	Peak	337.00	150	Vertical	N/A
2**	2480.000	96.20	-11.99	54.0	42.20	AV	337.00	150	Vertical	N/A
3	4571.000	49.18	-4.16	74.0	-24.82	Peak	162.00	150	Vertical	Pass
3**	4571.000	32.86	-4.16	54.0	-21.14	AV	162.00	150	Vertical	Pass
4	6674.000	53.44	0.18	74.0	-20.56	Peak	162.00	150	Vertical	Pass
4**	6674.000	38.08	0.18	54.0	-15.92	AV	162.00	150	Vertical	Pass
5	11063.812	50.91	-0.47	74.0	-23.09	Peak	269.00	150	Vertical	Pass
5**	11063.812	38.96	-0.47	54.0	-15.04	AV	269.00	150	Vertical	Pass
6	17384.438	55.75	3.96	74.0	-18.25	Peak	310.00	150	Vertical	Pass
6**	17384.438	44.71	3.96	54.0	-9.29	AV	310.00	150	Vertical	Pass

## 8-DPSK LOW CHANNEL 1 GHz to 18 GHz, ANT H

RE Test case\_FCC\_Part 15C\_FCC 15.247(2.4G)\_1GHz-18GHz

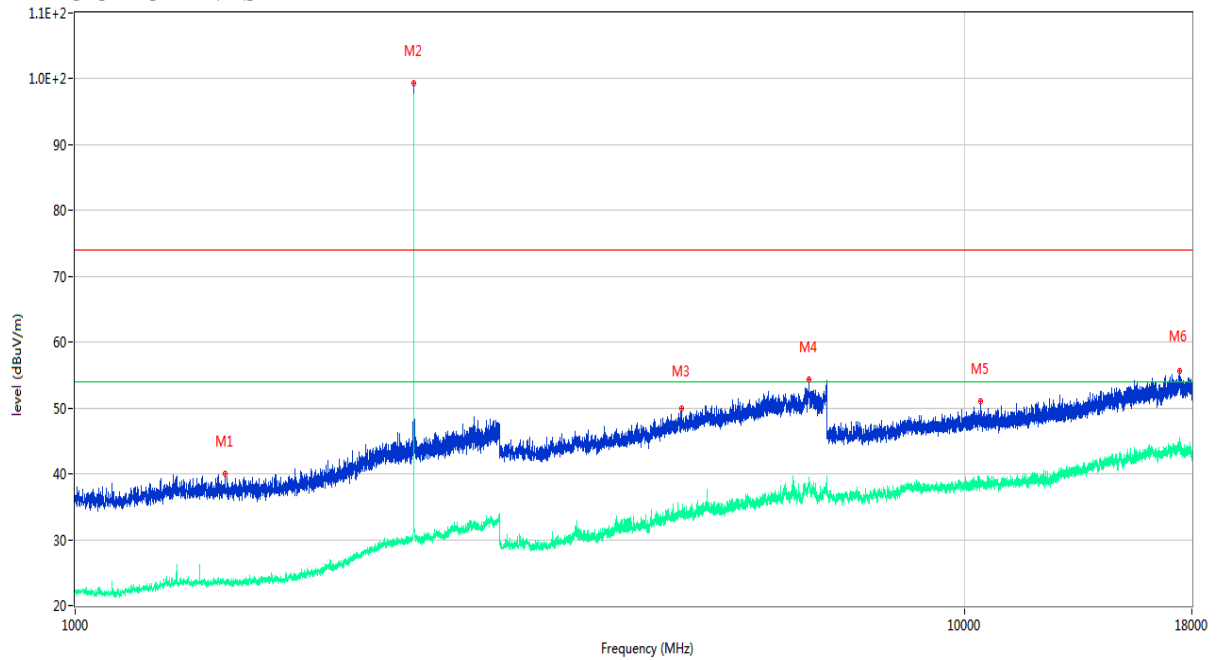

No.	Frequency (MHz)	Results (dBuV/m)	Factor (dB)	Limit (dBuV/m)	Over Limit (dB)	Detector	Table (Degree)	Height (cm)	Antenna	Verdict
1	1473.500	40.04	-17.28	74.0	-33.96	Peak	178.00	150	Horizontal	Pass
1**	1473.500	23.62	-17.28	54.0	-30.38	AV	178.00	150	Horizontal	Pass
2	2402.000	99.36	-11.82	74.0	25.36	Peak	139.00	150	Horizontal	N/A
2**	2402.000	93.59	-11.82	54.0	39.59	AV	139.00	150	Horizontal	N/A
3	4809.000	49.96	-2.91	74.0	-24.04	Peak	287.00	150	Horizontal	Pass
3**	4809.000	34.30	-2.91	54.0	-19.70	AV	287.00	150	Horizontal	Pass
4	6678.000	54.32	0.29	74.0	-19.68	Peak	360.00	150	Horizontal	Pass
4**	6678.000	39.44	0.29	54.0	-14.56	AV	360.00	150	Horizontal	Pass
5	10419.812	51.13	0.65	74.0	-22.87	Peak	218.00	150	Horizontal	Pass
5**	10419.812	38.97	0.65	54.0	-15.03	AV	218.00	150	Horizontal	Pass
6	17443.500	55.69	4.01	74.0	-18.31	Peak	306.00	150	Horizontal	Pass
6**	17443.500	44.14	4.01	54.0	-9.86	AV	306.00	150	Horizontal	Pass

8-DPSK LOW CHANNEL 1 GHz to 18 GHz, ANT V

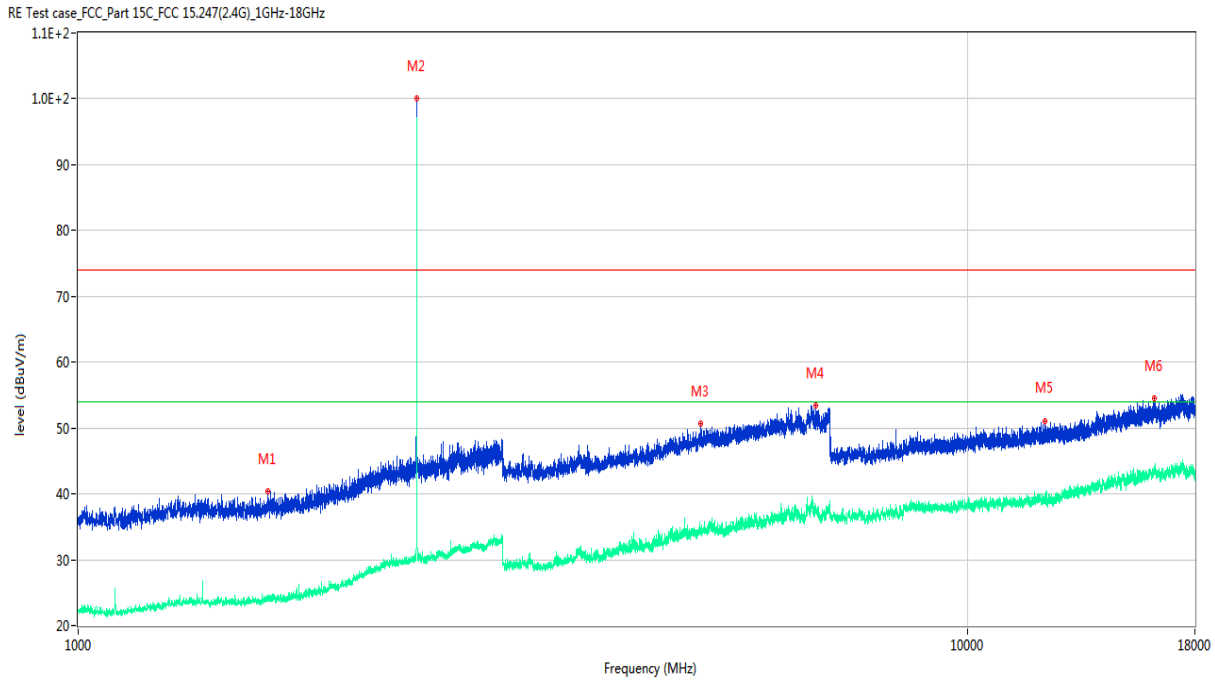

No.	Frequency (MHz)	Results (dBuV/m)	Factor (dB)	Limit (dBuV/m)	Over Limit (dB)	Detector	Table (Degree)	Height (cm)	Antenna	Verdict
1	1633.000	40.39	-17.23	74.0	-33.61	Peak	185.00	150	Vertical	Pass
1**	1633.000	24.08	-17.23	54.0	-29.92	AV	185.00	150	Vertical	Pass
2	2402.000	100.00	-11.82	74.0	26.00	Peak	359.00	150	Vertical	N/A
2**	2402.000	95.17	-11.82	54.0	41.17	AV	359.00	150	Vertical	N/A
3	5004.000	50.63	-2.90	74.0	-23.37	Peak	69.00	150	Vertical	Pass
3**	5004.000	34.35	-2.90	54.0	-19.65	AV	69.00	150	Vertical	Pass
4	6742.000	53.50	0.47	74.0	-20.50	Peak	126.00	150	Vertical	Pass
4**	6742.000	37.91	0.47	54.0	-16.09	AV	126.00	150	Vertical	Pass
5	12218.125	51.07	1.62	74.0	-22.93	Peak	157.00	150	Vertical	Pass
5**	12218.125	39.75	1.62	54.0	-14.25	AV	157.00	150	Vertical	Pass
6	16207.126	54.48	2.53	74.0	-19.52	Peak	15.00	150	Vertical	Pass
6**	16207.126	43.34	2.53	54.0	-10.66	AV	15.00	150	Vertical	Pass

8-DPSK MIDDLE CHANNEL 1 GHz to 18 GHz, ANT H

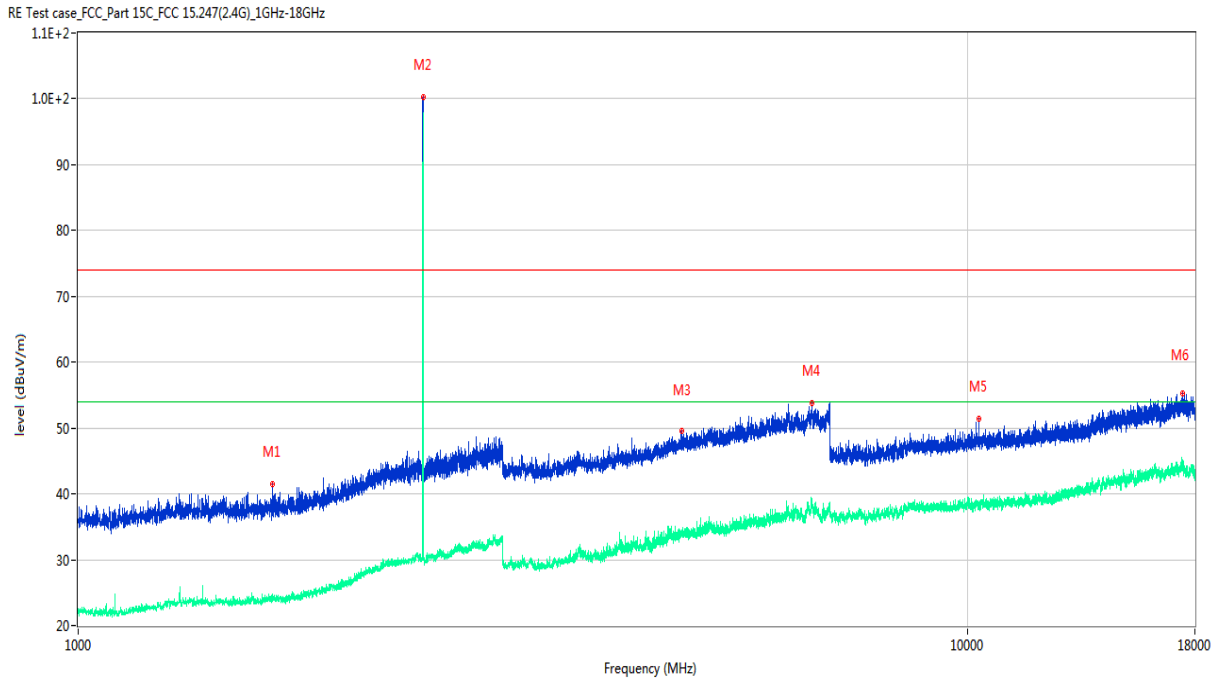

No.	Frequency (MHz)	Results (dBuV/m)	Factor (dB)	Limit (dBuV/m)	Over Limit (dB)	Detector	Table (Degree)	Height (cm)	Antenna	Verdict
1	1652.500	41.50	-17.24	74.0	-32.50	Peak	153.00	150	Horizontal	Pass
1**	1652.500	23.67	-17.24	54.0	-30.33	AV	153.00	150	Horizontal	Pass
2	2441.000	100.25	-12.60	74.0	26.25	Peak	135.00	150	Horizontal	N/A
2**	2441.000	94.17	-12.60	54.0	40.17	AV	135.00	150	Horizontal	N/A
3	4768.000	49.51	-3.02	74.0	-24.49	Peak	0.00	150	Horizontal	Pass
3**	4768.000	33.66	-3.02	54.0	-20.34	AV	0.00	150	Horizontal	Pass
4	6677.000	53.77	0.46	74.0	-20.23	Peak	289.00	150	Horizontal	Pass
4**	6677.000	39.24	0.46	54.0	-14.76	AV	289.00	150	Horizontal	Pass
5	10289.000	51.46	0.50	74.0	-22.54	Peak	60.00	150	Horizontal	Pass
5**	10289.000	38.67	0.50	54.0	-15.33	AV	60.00	150	Horizontal	Pass
6	17430.374	55.31	4.53	74.0	-18.69	Peak	177.00	150	Horizontal	Pass
6**	17430.374	44.49	4.53	54.0	-9.51	AV	177.00	150	Horizontal	Pass

8-DPSK MIDDLE CHANNEL 1 GHz to 18 GHz, ANT V

RE Test case\_FCC\_Part 15C\_FCC 15.247(2.4G)\_1GHz-18GHz

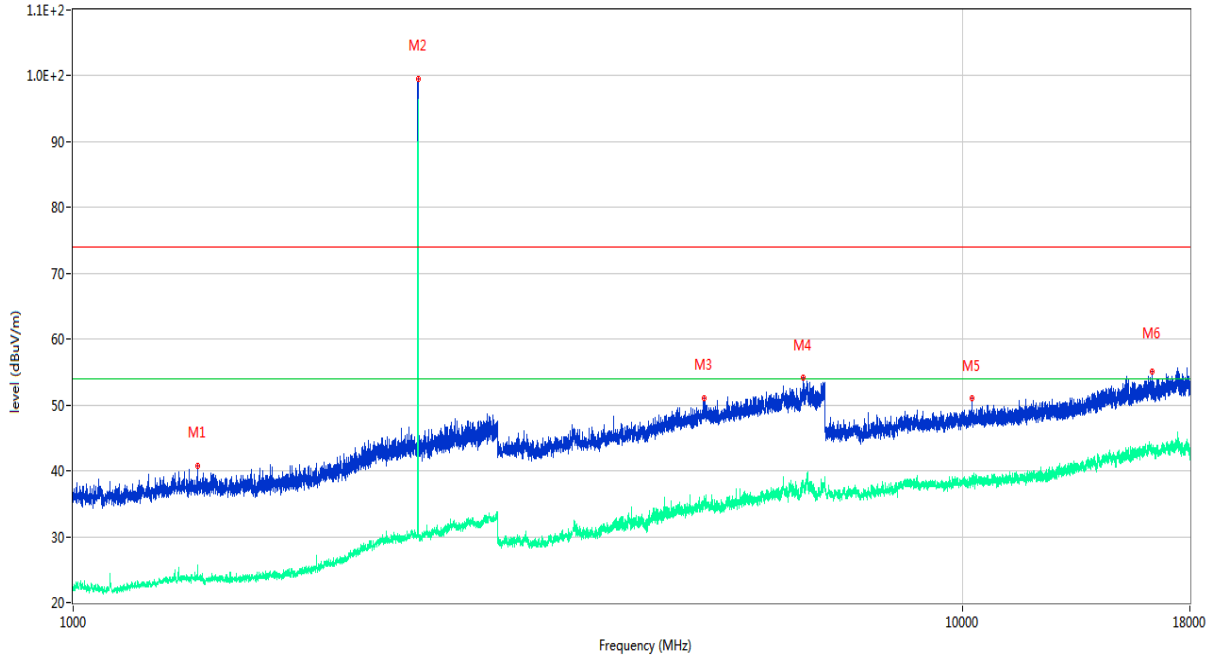

No.	Frequency (MHz)	Results (dBuV/m)	Factor (dB)	Limit (dBuV/m)	Over Limit (dB)	Detector	Table (Degree)	Height (cm)	Antenna	Verdict
1	1379.000	40.84	-17.22	74.0	-33.16	Peak	21.00	150	Vertical	Pass
1**	1379.000	24.92	-17.22	54.0	-29.08	AV	21.00	150	Vertical	Pass
2	2441.000	99.62	-12.60	74.0	25.62	Peak	342.00	150	Vertical	N/A
2**	2441.000	93.96	-12.60	54.0	39.96	AV	342.00	150	Vertical	N/A
3	5122.000	51.07	-2.23	74.0	-22.93	Peak	54.00	150	Vertical	Pass
3**	5122.000	34.96	-2.23	54.0	-19.04	AV	54.00	150	Vertical	Pass
4	6622.000	54.21	0.31	74.0	-19.79	Peak	185.00	150	Vertical	Pass
4**	6622.000	37.77	0.31	54.0	-16.23	AV	185.00	150	Vertical	Pass
5	10240.125	51.03	1.05	74.0	-22.97	Peak	346.00	150	Vertical	Pass
5**	10240.125	38.57	1.05	54.0	-15.43	AV	346.00	150	Vertical	Pass
6	16337.063	55.07	1.78	74.0	-18.93	Peak	252.00	150	Vertical	Pass
6**	16337.063	43.31	1.78	54.0	-10.69	AV	252.00	150	Vertical	Pass

8-DPSK HIGH CHANNEL 1 GHz to 18 GHz, ANT H

RE Test case\_FCC\_Part 15C\_FCC 15.247(2.4G)\_1GHz-18GHz

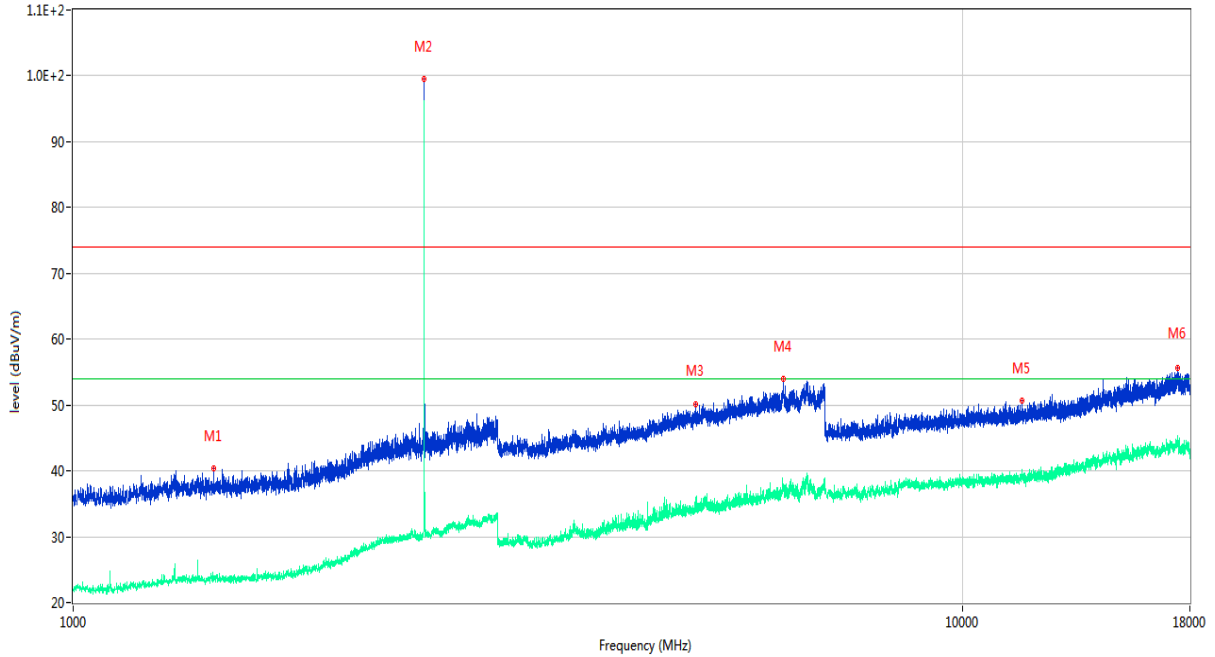

No.	Frequency (MHz)	Results (dBuV/m)	Factor (dB)	Limit (dBuV/m)	Over Limit (dB)	Detector	Table (Degree)	Height (cm)	Antenna	Verdict
1	1439.500	40.40	-17.22	74.0	-33.60	Peak	192.00	150	Horizontal	Pass
1**	1439.500	23.36	-17.22	54.0	-30.64	AV	192.00	150	Horizontal	Pass
2	2480.000	99.52	-11.99	74.0	25.52	Peak	136.00	150	Horizontal	N/A
2**	2480.000	93.92	-11.99	54.0	39.92	AV	136.00	150	Horizontal	N/A
3	5011.000	50.19	-3.08	74.0	-23.81	Peak	132.00	150	Horizontal	Pass
3**	5011.000	34.02	-3.08	54.0	-19.98	AV	132.00	150	Horizontal	Pass
4	6285.000	53.93	0.40	74.0	-20.07	Peak	357.00	150	Horizontal	Pass
4**	6285.000	37.47	0.40	54.0	-16.53	AV	357.00	150	Horizontal	Pass
5	11656.063	50.61	0.33	74.0	-23.39	Peak	42.00	150	Horizontal	Pass
5**	11656.063	39.63	0.33	54.0	-14.37	AV	42.00	150	Horizontal	Pass
6	17434.313	55.54	4.39	74.0	-18.46	Peak	129.00	150	Horizontal	Pass
6**	17434.313	44.59	4.39	54.0	-9.41	AV	129.00	150	Horizontal	Pass

8-DPSK HIGH CHANNEL 1 GHz to 18 GHz, ANT V

RE Test case\_FCC\_Part 15C\_FCC 15.247(2.4G)\_1GHz-18GHz

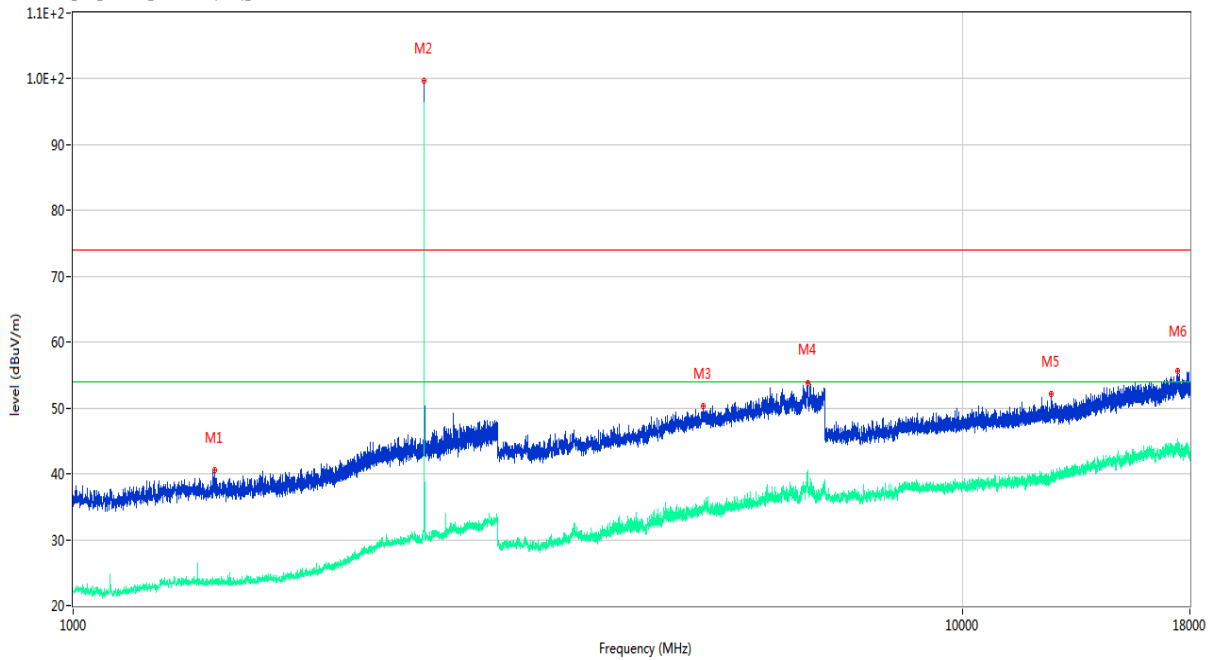

No.	Frequency (MHz)	Results (dBuV/m)	Factor (dB)	Limit (dBuV/m)	Over Limit (dB)	Detector	Table (Degree)	Height (cm)	Antenna	Verdict
1	1443.000	40.53	-17.20	74.0	-33.47	Peak	357.00	150	Vertical	Pass
1**	1443.000	23.73	-17.20	54.0	-30.27	AV	357.00	150	Vertical	Pass
2	2480.000	99.68	-11.99	74.0	25.68	Peak	338.00	150	Vertical	N/A
2**	2480.000	95.24	-11.99	54.0	41.24	AV	338.00	150	Vertical	N/A
3	5110.000	50.25	-2.27	74.0	-23.75	Peak	192.00	150	Vertical	Pass
3**	5110.000	34.60	-2.27	54.0	-19.40	AV	192.00	150	Vertical	Pass
4	6690.000	53.85	-0.07	74.0	-20.15	Peak	192.00	150	Vertical	Pass
4**	6690.000	37.76	-0.07	54.0	-16.24	AV	192.00	150	Vertical	Pass
5	12567.437	52.15	1.83	74.0	-21.85	Peak	241.00	150	Vertical	Pass
5**	12567.437	39.58	1.83	54.0	-14.42	AV	241.00	150	Vertical	Pass
6	17417.251	55.57	4.78	74.0	-18.43	Peak	57.00	150	Vertical	Pass
6**	17417.251	44.04	4.78	54.0	-9.96	AV	57.00	150	Vertical	Pass

Hopping Mode:

GFSK MODE 1 GHz to 18 GHz, ANT H

RE Test case\_FCC\_Part 15C\_FCC 15.247(2.4G)\_1GHz-18GHz

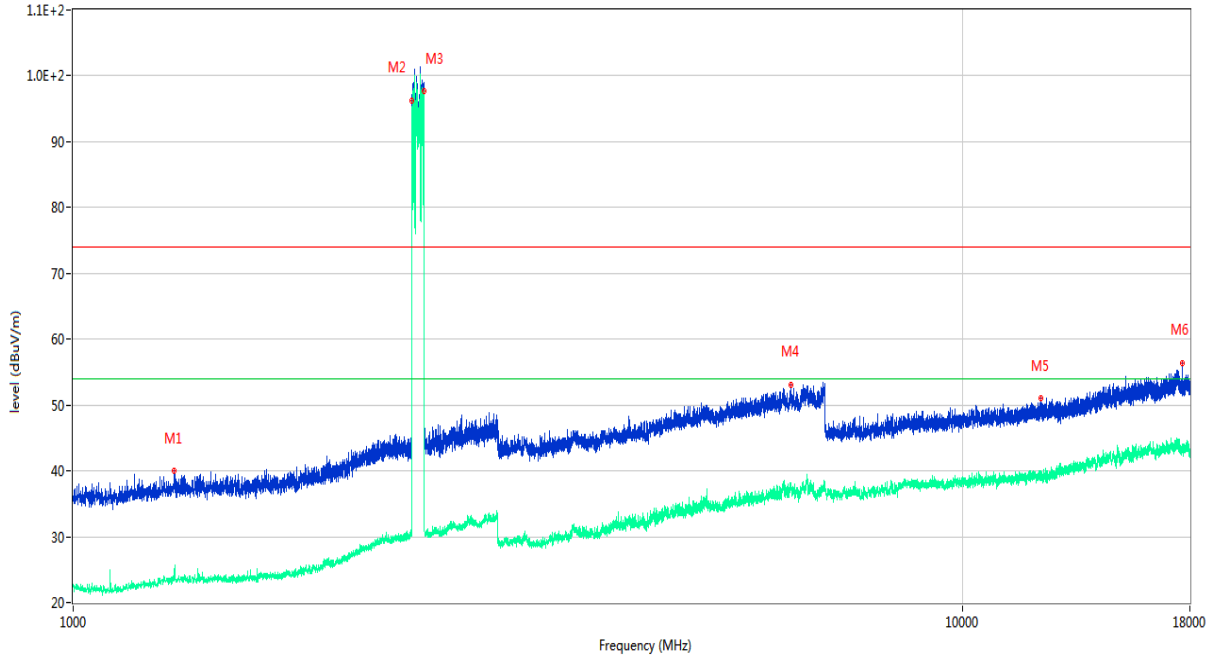

No.	Frequency (MHz)	Results (dBuV/m)	Factor (dB)	Limit (dBuV/m)	Over Limit (dB)	Detector	Table (Degree)	Height (cm)	Antenna	Verdict
1	1299.500	39.98	-17.01	74.0	-34.02	Peak	291.00	150	Horizontal	Pass
1**	1299.500	23.84	-17.01	54.0	-30.16	AV	291.00	150	Horizontal	Pass
2	2402.000	96.28	-11.82	74.0	22.28	Peak	111.00	150	Horizontal	N/A
2**	2402.000	91.77	-11.82	54.0	37.77	AV	111.00	150	Horizontal	N/A
3	2479.500	97.67	-11.99	74.0	23.67	Peak	201.00	150	Horizontal	N/A
3**	2479.500	97.21	-11.99	54.0	43.21	AV	201.00	150	Horizontal	N/A
4	6412.000	52.98	-0.16	74.0	-21.02	Peak	287.00	150	Horizontal	Pass
4**	6412.000	37.26	-0.16	54.0	-16.74	AV	287.00	150	Horizontal	Pass
5	12231.063	50.98	1.65	74.0	-23.02	Peak	20.00	150	Horizontal	Pass
5**	12231.063	39.64	1.65	54.0	-14.36	AV	20.00	150	Horizontal	Pass
6	17648.251	56.30	3.08	74.0	-17.70	Peak	-2.00	150	Horizontal	Pass
6**	17648.251	43.56	3.08	54.0	-10.44	AV	-2.00	150	Horizontal	Pass



## GFSK MODE 1 GHz to 18 GHz, ANT V

RE Test case\_FCC\_Part 15C\_FCC 15.247(2.4G)\_1GHz-18GHz

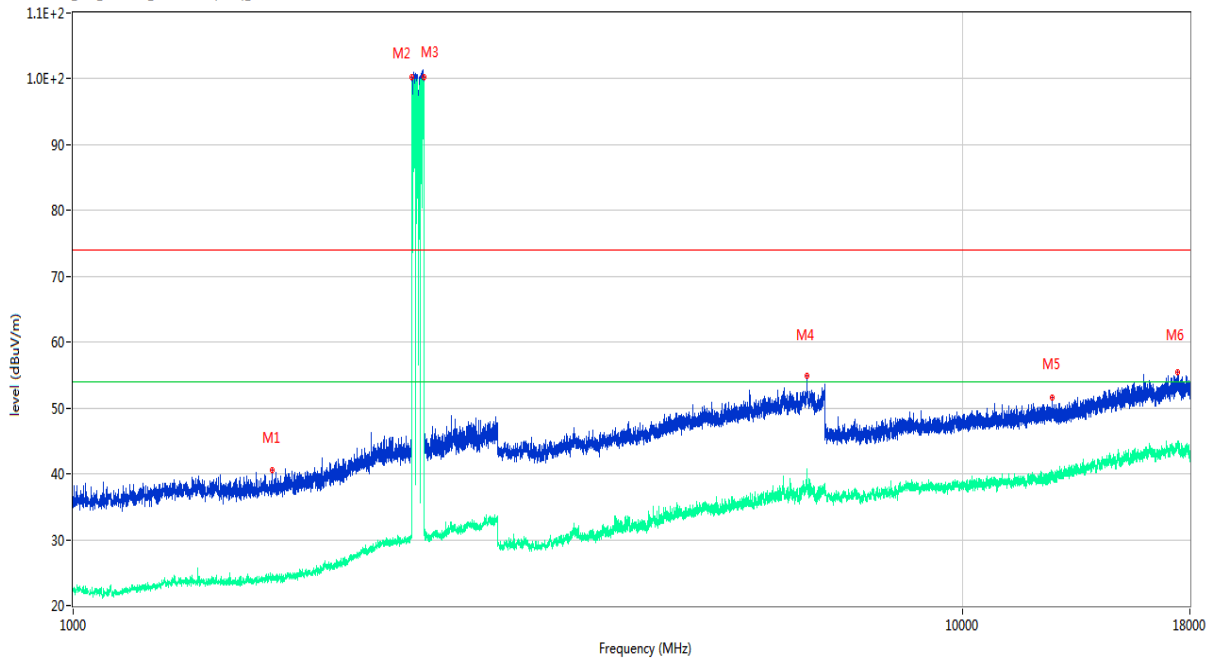

No.	Frequency (MHz)	Results (dBuV/m)	Factor (dB)	Limit (dBuV/m)	Over Limit (dB)	Detector	Table (Degree)	Height (cm)	Antenna	Verdict
1	1673.500	40.51	-16.98	74.0	-33.49	Peak	183.00	150	Vertical	Pass
1**	1673.500	23.77	-16.98	54.0	-30.23	AV	183.00	150	Vertical	Pass
2	2403.500	100.24	-11.82	74.0	26.24	Peak	342.00	150	Vertical	N/A
2**	2403.500	88.17	-11.82	54.0	34.17	AV	342.00	150	Vertical	N/A
3	2477.000	100.28	-12.04	74.0	26.28	Peak	360.00	150	Vertical	N/A
3**	2477.000	95.24	-12.04	54.0	41.24	AV	360.00	150	Vertical	N/A
4	6676.000	54.90	0.41	74.0	-19.10	Peak	179.00	150	Vertical	Pass
4**	6676.000	38.87	0.41	54.0	-15.13	AV	179.00	150	Vertical	Pass
5	12616.313	51.58	2.21	74.0	-22.42	Peak	237.00	150	Vertical	Pass
5**	12616.313	39.63	2.21	54.0	-14.37	AV	237.00	150	Vertical	Pass
6	17430.374	55.37	4.53	74.0	-18.63	Peak	358.00	150	Vertical	Pass
6**	17430.374	44.36	4.53	54.0	-9.64	AV	358.00	150	Vertical	Pass

8-DPSK MODE 1 GHz to 18 GHz, ANT H

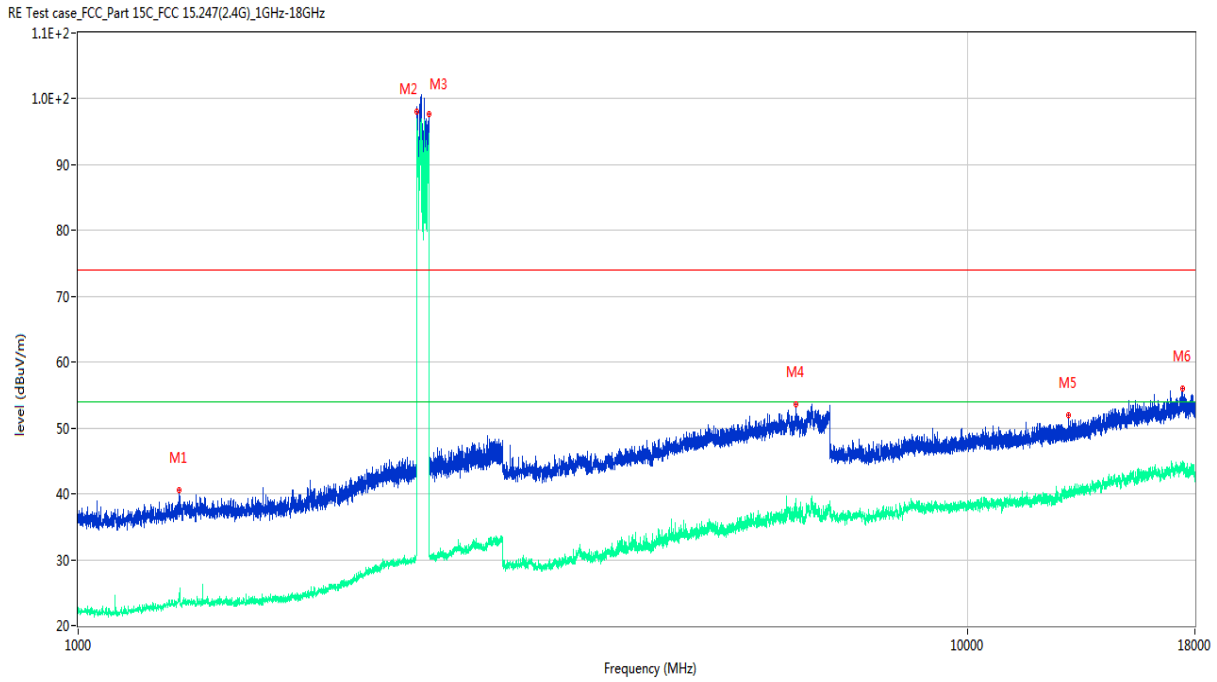

No.	Frequency (MHz)	Results (dBuV/m)	Factor (dB)	Limit (dBuV/m)	Over Limit (dB)	Detector	Table (Degree)	Height (cm)	Antenna	Verdict
1	1300.000	40.57	-17.02	74.0	-33.43	Peak	39.00	150	Horizontal	Pass
1**	1300.000	23.96	-17.02	54.0	-30.04	AV	39.00	150	Horizontal	Pass
2	2402.000	98.11	-11.82	74.0	24.11	Peak	201.00	150	Horizontal	N/A
2**	2402.000	92.25	-11.82	54.0	38.25	AV	201.00	150	Horizontal	N/A
3	2478.000	97.65	-11.96	74.0	23.65	Peak	128.00	150	Horizontal	N/A
3**	2478.000	92.42	-11.96	54.0	38.42	AV	128.00	150	Horizontal	N/A
4	6404.000	53.57	-0.72	74.0	-20.43	Peak	303.00	150	Horizontal	Pass
4**	6404.000	37.09	-0.72	54.0	-16.91	AV	303.00	150	Horizontal	Pass
5	12971.813	51.93	1.27	74.0	-22.07	Peak	360.00	150	Horizontal	Pass
5**	12971.813	40.50	1.27	54.0	-13.50	AV	360.00	150	Horizontal	Pass
6	17423.813	56.08	4.74	74.0	-17.92	Peak	183.00	150	Horizontal	Pass
6**	17423.813	44.64	4.74	54.0	-9.36	AV	183.00	150	Horizontal	Pass

8-DPSK MODE 1 GHz to 18 GHz, ANT V

RE Test case\_FCC\_Part 15C\_FCC 15.247(2.4G)\_1GHz-18GHz

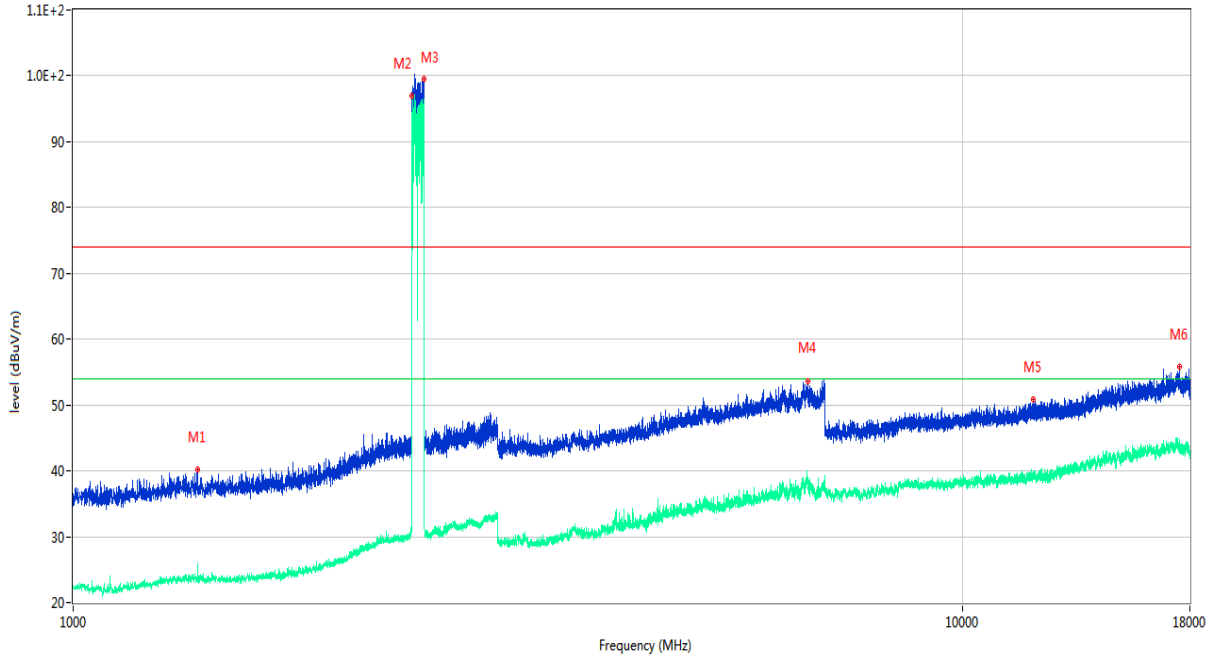

No.	Frequency (MHz)	Results (dBuV/m)	Factor (dB)	Limit (dBuV/m)	Over Limit (dB)	Detector	Table (Degree)	Height (cm)	Antenna	Verdict
1	1379.000	40.16	-17.22	74.0	-33.84	Peak	333.00	150	Vertical	Pass
1**	1379.000	24.30	-17.22	54.0	-29.70	AV	333.00	150	Vertical	Pass
2	2402.500	96.94	-11.82	74.0	22.94	Peak	131.00	150	Vertical	N/A
2**	2402.500	88.19	-11.82	54.0	34.19	AV	131.00	150	Vertical	N/A
3	2479.000	99.56	-11.98	74.0	25.56	Peak	315.00	150	Vertical	N/A
3**	2479.000	94.13	-11.98	54.0	40.13	AV	315.00	150	Vertical	N/A
4	6693.000	53.61	-0.03	74.0	-20.39	Peak	339.00	150	Vertical	Pass
4**	6693.000	38.08	-0.03	54.0	-15.92	AV	339.00	150	Vertical	Pass
5	11999.625	50.90	1.46	74.0	-23.10	Peak	278.00	150	Vertical	Pass
5**	11999.625	39.37	1.46	54.0	-14.63	AV	278.00	150	Vertical	Pass
6	17514.375	55.78	3.11	74.0	-18.22	Peak	256.00	150	Vertical	Pass
6**	17514.375	43.96	3.11	54.0	-10.04	AV	256.00	150	Vertical	Pass

## A.9 Band Edge (Restricted-band band-edge)

Note 1: The lowest and highest channels are tested to verify the band edge emissions. Please refer to the following the plots for emissions values.

Note 2: The test data all are tested in the vertical and horizontal antenna which the trace is max hold. So these plots have shown the worst case.

Note 3: According the ANSI C63.10-2013, where limits are specified for both average and peak (or quasi-peak) detector functions, if the peak (or quasi-peak) measured value complies with the average limit, it is unnecessary to perform an average measurement.

Note 4: The Level (dBuV/m) has been corrected by factor.

Test Mode	Test Channel	Frequency (MHz)	Level (dBuV/m)	Factor (dB)	Limit Line (dBuV/m)	Margin (dB)	Remark	Verdict												
GFSK	Low	2390.00	53.057	31.47	74	20.943	PEAK	Pass												
		2390.00	N/A	N/A	54	N/A	AVERAGE	Pass												
GFSK	HIGH	2483.50	53.157	31.40	74	20.843	PEAK	Pass												
		2483.50	N/A	N/A	54	N/A	AVERAGE	Pass												
8-DPSK	Low	2390.00	52.543	31.47	74	21.457	PEAK	Pass												
		2390.00	N/A	N/A	54	N/A	AVERAGE	Pass												
8-DPSK	HIGH	2483.50	52.839	31.40	74	21.161	PEAK	Pass												
		2483.50	N/A	N/A	54	N/A	AVERAGE	Pass												
GFSK(Hopping)	Low	2390.00	52.028	31.47	74	21.972	PEAK	Pass												
		2390.00	N/A	N/A	54	N/A	AVERAGE	Pass												
GFSK(Hopping)	HIGH	2483.50	51.928	31.40	74	22.072	PEAK	Pass												
		2483.50	N/A	N/A	54	N/A	AVERAGE	Pass												
8-DPSK (Hopping)	Low	2390.00	52.348	31.47	74	21.652	PEAK	Pass												
		2390.00	N/A	N/A	54	N/A </tr <tr> <td rowspan="2">8-DPSK (Hopping)</td> <td rowspan="2">HIGH</td> <td>2483.50</td> <td>52.54</td> <td>31.40</td> <td>74</td> <td>21.460</td> <td>PEAK</td> <td>Pass</td> </tr> <tr> <td>2483.50</td> <td>N/A</td> <td>N/A</td> <td>54</td> <td>N/A</td> <td>AVERAGE</td> <td>Pass</td> </tr>	8-DPSK (Hopping)	HIGH	2483.50	52.54	31.40	74	21.460	PEAK	Pass	2483.50	N/A	N/A	54	N/A
8-DPSK (Hopping)	HIGH	2483.50	52.54	31.40	74	21.460			PEAK	Pass										
		2483.50	N/A	N/A	54	N/A	AVERAGE	Pass												

### Test Plots

GFSK LOW CHANNEL, PEAK



GFSK HIGH CHANNEL, PEAK

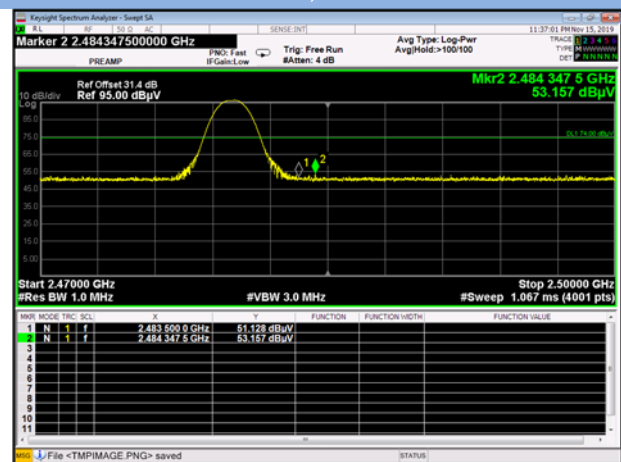

8-DPSK LOW CHANNEL, PEAK

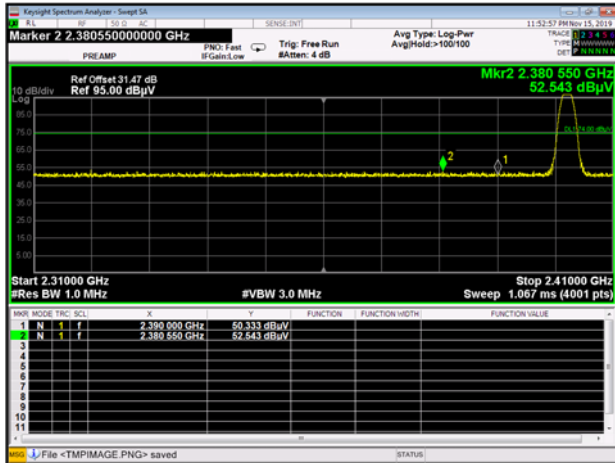

8-DPSK HIGH CHANNEL, PEAK

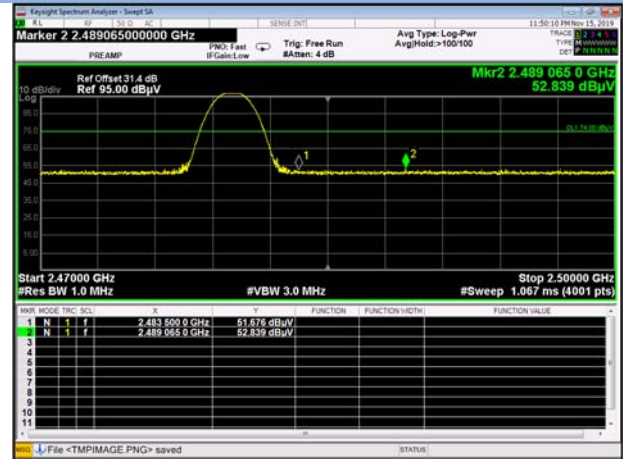

Hopping Mode:

GFSK LOW FREQUENCY BAND, PEAK

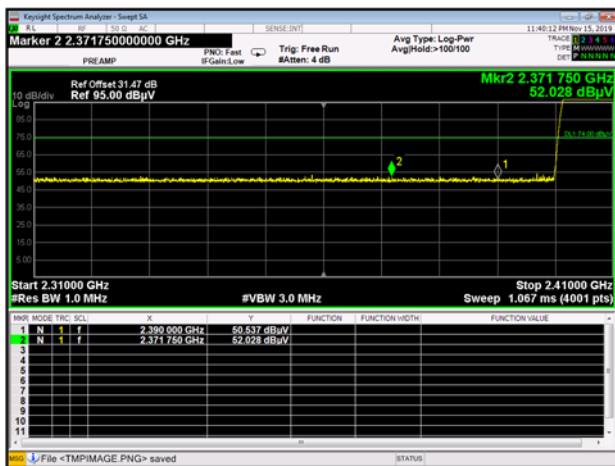

GFSK HIGH FREQUENCY BAND, PEAK

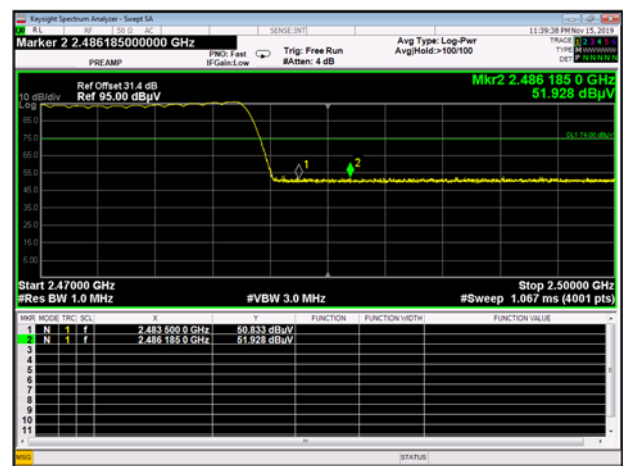

8-DPSK LOW FREQUENCY BAND, PEAK

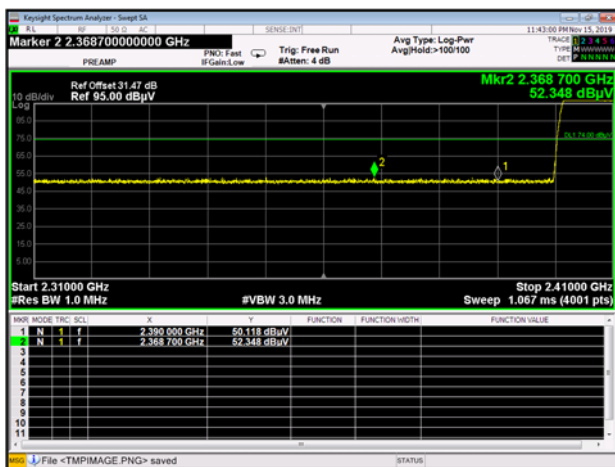

8-DPSK HIGH FREQUENCY BAND, PEAK



## **ANNEX B TEST SETUP PHOTOS**

Please refer the document "BL-SZ19A0583-AR.PDF".

## **ANNEX C EUT EXTERNAL PHOTOS**

Please refer the document "BL-SZ19A0583-AW.PDF".

## **ANNEX D EUT INTERNAL PHOTOS**

Please refer the document "BL-SZ19A0583-AI.PDF".

--END OF REPORT--