



Advanced Mobile Payment Inc.

AMP 7 Series Countertop / Mobile Terminal

Quick Reference Guide

DQ-7000-1-E



2015 Advanced Mobile Payment Inc. (AMP) All rights reserved. AMP, the AMP logo, vTerminal are either trademarks or registered trademarks of AMP in Canada and/or other countries. All other trademarks or brand names are the properties of their respective holders. All features and specifications are subject to change without notice. Product display image for representation purposes only. Actual product display may vary. Reproduction or posting of this document without prior AMP approval is prohibited.

Package contents

AMP 7000-XX	1
AC Power Supply	1
AC Power Cable	1
Li-ion Battery	1 (if supplied)
Thermal paper roll	1
Quick Reference Guide	1

Electrical Considerations

- Use only approved power supply that is provided with this device, using other power supply may cause damage to the device or risk of fire.
- Avoid using this product during electrical storms.
- Avoid locations near electrical appliances or other devices that cause excessive voltage fluctuations or emit electrical noise (for example, air conditioners, electric motors, neon signs, high-frequency or magnetic security devices, or computer equipment).
- Do not use the terminal near water or in moist conditions.

Unpacking the shipping carton

Open the shipping carton and inspect all its contents for possible tampering or damage. The AMP 7 Series terminal is a secure device and any tampering may cause cease to function properly.

To unpack the shipping carton

- Remove and inspect the following items
 - Terminal
 - Power Supply
 - Power chord
 - Telephone cable (if available)
- Remove plastic wrapping from the terminal
- Remove plastic protective film from the LCD



Do not use a terminal that has been damaged or tampered. AMP 7 Series terminal comes equipped with tamper-evident labels. If a label or component appears damaged, please notify the shipping company and your AMP representative or service provider immediately.

- Keep the shipping carton and packing materials for feature packing or moving terminal.

Examining terminal features before starting the installation

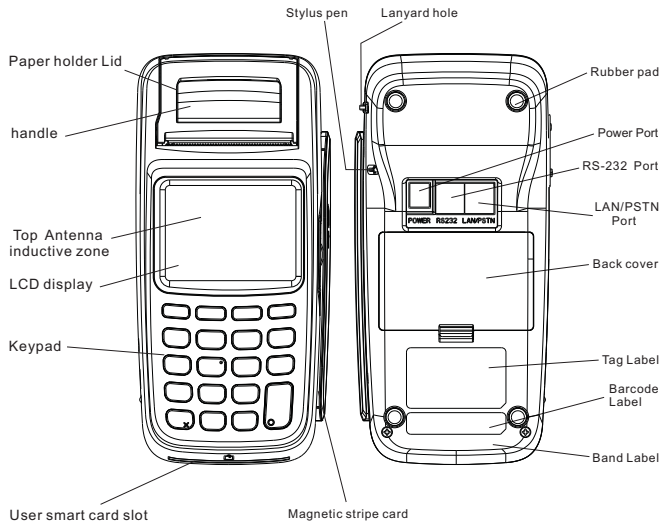

Description

Paper holder lid:	Container for thermal paper roll (Φ38X57mm)
Handle:	Pull handle to open the paper holder lid
LCD display:	2.8 inch and 320*240 TFT LCD. Optional signature capture function.
Antenna inductive zone:	The zone for tapping contactless card
Key pad:	10 alphanumeric keys, 8 functional keys, 1 power switch key.
User smart card slot:	Supporting EMV card with contact surface facing up.
Magnetic Card Reader:	ISO7812, 1/2 Tracks or 2/3 Tracks or 1/2/3 Tracks, bi-directional swiping with the magnetic stripe facing LCD.
Rubber pad:	Four pads, anti-vibration/non-slip.
Tag label:	Showing model name, rated device parameter.
Barcode Label:	Device serial number.
Band Label:	Frequency bands of communication module.
Back cover:	Remove the cover to install battery or SIM/UIM/SAM card.
Power port:	Approved power supply for AMP 7 Series
RS-232 port:	1 RS-232(up to 2), output: 5VDC, 500mA.
LAN/PSTN port:	An optional communication between LAN Port and PSTN Port.
Lanyard hole:	Slide lanyard through and make a loop on the outside.
Internal wireless:	GPRS

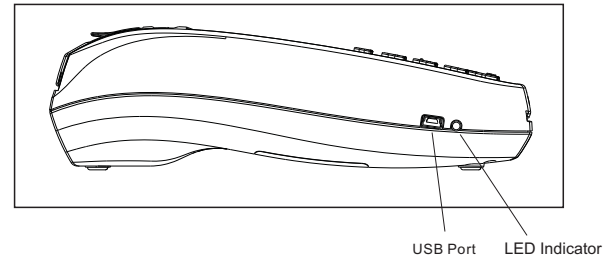

LED indicator:

Power status indicator of device

USB Port:

USB communication interface

Battery installation (if supplied)

- Place the terminal face down and remove the battery cover.
- Fit the battery inside the battery compartment and plug its cable.
- If a SIM or SAM is required and is not already inserted, insert a SIM/SAM in to the socket marked as SIM or SAM.

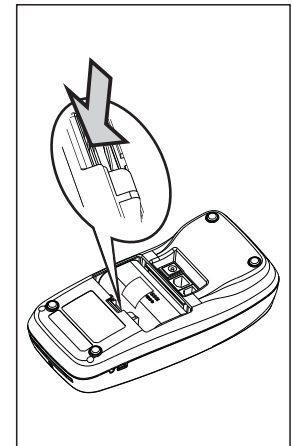
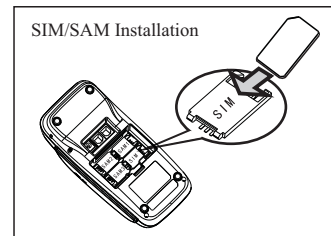
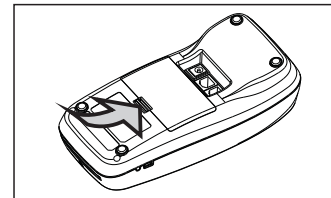

Paper roll installation

- Gently pull upwards on the lever located on the middle of the printer door.
- Discard any packing material from the paper roll.
- Put and fit the roll as shown in the figure below and notice the correct orientation of the paper while fitting it in.
- Pull the paper round 10cm until protrudes from the top of the terminal.
- Close the printer door and gently push it until a 'click' sound is heard.
- Remove the excess paper by tearing along the serrated edge.

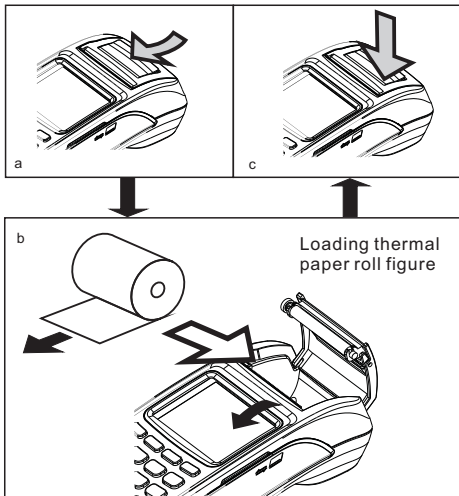
Charging the terminal

- Insert the power supply plug directly into the power port located at the back of the terminal and then plug the power supply into the electrical outlet.
- Charging the battery will take 2 to 4 hours.
- Battery charging status is indicated in the top right hand corner of the display when the terminal is switched on and also in the LED at left side of the terminal when the terminal is in off state. The LED lit Red when the battery is charging and turns to Green after the battery is fully charged.
- When terminal is not in use leave it connected to the power supply to maintain charge.

Establishing Telephone line connections

- Place the terminal face down.
- Connect the telephone cord to the LAN/PSTN port on the terminal, and then route it directly to a telephone wall jack (see below Figure). This is a direct connection and the line is dedicated to the terminal.



To reduce the risk of fire, use only No. 26AWG or larger UL Listed or CSA Certified Telecommunication Line Cord.



Establishing LAN connections

- Place the terminal face down.
- Connect the Ethernet cable to the LAN/PSTN port on the terminal, and then route it directly to a LAN jack.

Optional device connections

- This terminal has a port that can operate either as a PIN pad port or a RS-232 port, depending on the power source available.
- Please refer to the User Manual for the procedures on how to connect a PIN pad to the device.

Turning on/off the terminal

- Press and hold down the power button marked as  until the display illuminates and the device starts to boot on.
- Your terminal may prompt you to enter your MID as a security check.
- The device can be powered both with AC power supply or battery (if supplied).
- To switch off the terminal press and hold the power button  for 2 to 3 seconds while the device is on.

How to present payment card to the device

Below pictures show how you can present the payment card to the device. Please refer to the User Manual for performing all transaction types and reading card data by keypad, swipe, or contactless.

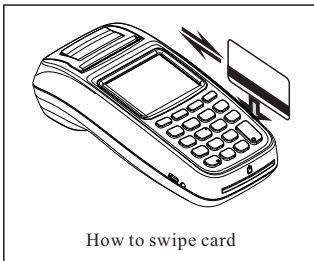
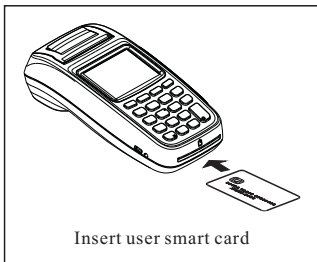
Troubleshooting

In the event you experience issues with this product, please refer to relevant procedure detailed below. If this doesn't resolve the issue please contact your service provider or visit www.amobilepayment.com for more information and assistance.

● **Poor printing performance**

- Check if the printer door is closed fully.
- Ensure that the orientation and installation of the paper roll is correct.
- Refer to User Manual for further printer setup options.

● **No Display**

- Check the battery is fitted correctly (if supplied).
- Check the LED at the side of the terminal for the status of the battery and make sure that the battery is charged.
- Check power supply and all connections.
- Ensure the power is connected to wall power socket (if the terminal is operating on external power).

● **Poor battery life**

- Charge the battery for 2 to 4 hours and check if the full charge LED at the left side of the terminal turns to Green.
- Check battery charge indicator on LCD is at maximum.
- Refer to User Manual for expected battery life and more information.

● **Card read error or cannot read cards**

- Ensure that the orientation of the magstripe card is correct. The magnetic stripe should be downward and face the LCD of the device.
- Ensure that you swipe the card at steady speed.
- Ensure that the chip card has been inserted in the correct orientation.
- Ensure that the contactless card has been placed at a distance of 0 to 4cm from the terminal display.
- Repeat the test with another card of the same type.

Caution and Safety Instructions

- Do not use the terminal if it is tampered or there is any sign of tampering.
- Do not disassemble, service or repair any part of terminal.
- To avoid any potential hazard of electrical shock do not use the terminal in wet environment.
- Use only the supplied power adaptor with an electrical outlet of the correct rating.
- Only use the battery supplied or specified by AMP.
- Do not expose to excessive heat and cold. Refer to device spec for more information.
- Do not use ethanol and other corrosive liquid to clean the device.

- Dispose any part in an environmentally sound manner and accordance with local laws.
- AMP will not be liable for any damage resulting from user operation that does not comply with the guidance stated.

Advanced Mobile Payment Inc.

Address: Unit 401, 15 Wertheim Court, Richmond Hill, Ontario L4B
3H7 Canada
Tel: +1 905 597 2333
Fax: +1 289 809 0133
Email: sales@amobilepayment.com
Website: www.amobilepayment.com
www.vterminal.com

2015 Advanced Mobile Payment Inc. (AMP) All rights reserved. AMP, the AMP logo, vTerminal are either trademarks or registered trademarks of AMP in Canada and/or other countries. All other trademarks or brand names are the properties of their respective holders. All features and specifications are subject to change without notice. Product display image for representation purposes only. Actual product display may vary. Reproduction or posting of this document without prior AMP approval is prohibited.

FCC Caution:

Any Changes or modifications not expressly approved by the party responsible for compliance could void the user's authority to operate the equipment.

This device complies with part 15 of the FCC Rules. Operation is subject to the following two conditions: (1) This device may not cause harmful interference, and (2) this device must accept any interference received, including interference that may cause undesired operation.

IMPORTANT NOTE:

Note: This equipment has been tested and found to comply with the limits for a Class B digital device, pursuant to part 15 of the FCC Rules. These limits are designed to provide reasonable protection against harmful interference in a residential installation. This equipment generates, uses and can radiate radio frequency energy and, if not installed and used in accordance with the instructions, may cause harmful interference to radio communications. However, there is no guarantee that interference will not occur in a particular installation. If this equipment does cause harmful interference to radio or television reception, which can be determined by turning the equipment off and on, the user is encouraged to try to correct the interference by one or more of the following measures:

- Reorient or relocate the receiving antenna.
- Increase the separation between the equipment and receiver.
- Connect the equipment into an outlet on a circuit different from that to which the receiver is connected.
- Consult the dealer or an experienced radio/TV technician for help.

Specific Absorption Rate (SAR) information

SAR tests are conducted using standard operating positions accepted by the FCC with the POS terminal transmitting at its highest certified power level in all tested frequency bands, although the SAR is determined at the highest certified power level, the actual SAR level of the POS terminal while operating can be well below the maximum value.

Before a new POS terminal is available for sale to the public, it must be tested and certified to the FCC that it does not exceed the exposure limit established by the FCC, Tests for each POS terminal are performed in positions and locations (e.g. worn on the body) as required by the FCC.

For body worn operation, this POS terminal has been tested and meets the FCC RF exposure Guidelines.