



TEST REPORT

No. I18D00226-EMC04

For

Client : Advanced Mobile Payment Inc.

Production: AMP 6500

Model Name : AMP 6500

Brand Name: AMP POS

FCC ID: 2AKJB-AMP6500-1

Hardware Version: AMP 6500-CD

Software Version: V1.0.11

Issued date: 2019-01-09

Note:

The test results in this test report relate only to the devices specified in this report. This report shall not be reproduced except in full without the written approval of ECIT Shanghai.

Test Laboratory:

ECIT Shanghai, East China Institute of Telecommunications

Add: 7F, G Area, No.668, Beijing East Road, Huangpu District, Shanghai, P. R. China

Tel: (+86)-021-63843300, E-Mail: welcome@ecit.org.cn

Revision Version

Report Number	Revision	Date	Memo
I18D00226-EMC04	00	2019-01-09	Initial creation of test report

CONTENTS

1. TEST LABORATORY	5
1.1. TESTING LOCATION	5
1.2. TESTING ENVIRONMENT	5
1.3. PROJECT DATA	5
1.4. SIGNATURE.....	5
2. CLIENT INFORMATION	6
2.1. APPLICANT INFORMATION.....	6
2.2. MANUFACTURER INFORMATION.....	6
3. EQUIPMENT UNDER TEST (EUT) AND ANCILLARY EQUIPMENT (AE)	7
3.1. ABOUT EUT.....	7
3.2. INTERNAL IDENTIFICATION OF EUT USED DURING THE TEST	7
3.3. INTERNAL IDENTIFICATION OF AE USED DURING THE TEST	7
4. REFERENCE DOCUMENTS.....	8
4.3. REFERENCE DOCUMENTS FOR TESTING	8
5. TEST RESULTS.....	9
5.1. SUMMARY OF TEST RESULTS.....	9
5.2. STATEMENTS.....	9
6. TEST EQUIPMENT UTILIZED	10
7. SYSTEM CONFIGURATION DURING TEST.....	11
7.1 TEST MODE.....	11
7.2 CONNECTION DIAGRAM OF TEST SYSTEM.....	11
8. MEASUREMENT RESULTS.....	12
8.1 20DB BANDWIDTH	12
8.2 FREQUENCY STABILITY.....	14

8.3 RADIATED EMISSIONS..... 16

8.3.1 ELECTRIC FIELD STRENGTH OF FUNDAMENTAL EMISSIONS..... 16

8.3.2 ELECTRIC FIELD RADIATED EMISSIONS (BELOW 30MHZ) 18

8.3.3 ELECTRIC FIELD RADIATED EMISSIONS (ABOVE 30MHZ)..... 20

8.4 CONDUCTED EMISSIONS 22

ANNEX A TEST CONFIGURATION PHOTOS..... 24

1. Test Laboratory

1.1. Testing Location

Company Name: ECIT Shanghai, East China Institute of Telecommunications
Address: 7F, G Area, No. 668, Beijing East Road, Huangpu District, Shanghai,
P. R. China
Postal Code: 200001
Telephone: 86-21-63843300
Fax: 86-21-63843301
FCC registration No: 958356

1.2. Testing Environment

Normal Temperature: 15-35°C
Relative Humidity: 30-60%RH

1.3. Project data

Project Leader: Yu Anlu
Testing Start Date: 2018-12-06
Testing End Date: 2018-12-24

1.4. Signature

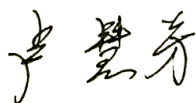

Lu Huifang
(Prepared this test report)



You Jinjun
(Reviewed this test report)

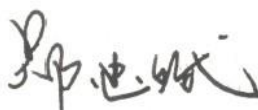

Zheng Zhongbin
(Approved this test report)

2. Client Information

2.1. Applicant Information

Company Name: Advanced Mobile Payment Inc.
Address : Units 401-403, 15 Wertheim Court. Richmond Hill, Ontario L4B 3H7
CANADA
Telephone: 1 (905) 597 2333
Postcode: L4B 3H7

2.2. Manufacturer Information

Company Name: NEW POS TECHNOLOGY LIMITED
Address : Floor, Block A, Financial Technology Building, No.11 Keyuan Rd ,
Nanshan District, Shenzhen
Telephone: /
Postcode: /

3. Equipment under Test (EUT) and Ancillary Equipment (AE)

3.1. About EUT

ProductName	AMP 6500
Model name	AMP 6500
GSM Frequency Band	GSM1900
UMTS Frequency Band	WCDMA Band II
LTE Frequency Band	LTE 2/4/5/7/25/26
Additional Communication Function	BT1.2,2.0,2.1,EDR,3.0,4.0,BLE,4.1,4.2;WIFI802.11a,b,g,n;GPS, GLONASS, Beidou, NFC;

3.2. Internal Identification of EUT used during the test

EUT ID*	SN or IMEI	HW Version	SW Version	Date of receipt
N01	/	AMP 6500-CD	V1.0.11	2018-11-26

*EUT ID: is used to identify the test sample in the lab internally.

3.3. Internal Identification of AE used during the test

AE ID*	Description	Model	SN
CA02	Adapter	ADS-40NP-12-1 12024E	/
UB02	Microfit Cable	/	/
AE1	Type A Card	/	/

*AE ID: is used to identify the test sample in the lab internally.

4. Reference Documents

4.3. Reference Documents for testing

The following documents listed in this section are referred for testing.

Reference	Title	Version
FCC CFR47 Part 2	Frequency allocations and radio treaty matters; general rules and regulations	2017
FCC CFR47 Part 15C	Radio Frequency Devices-Intentional Radiators	2017
ANSI C63.10	American National Standard of Procedures for Compliance Testing of Unlicensed Wireless Devices	2013

5. Test Results

5.1. Summary of Test Results

Items	Test List	Clause in FCC rules	Verdict
1	20 dB bandwidth	2.1049	Pass
2	Frequency Stability	15.225(e)	Pass
3	Radiated Emissions	15.225 (a) (b) (c) (d) and 15.209	Pass
4	Conducted Emissions	15.207	Pass

5.2. Statements

The AMP 6500, supporting NFC, manufactured by NEW POS TECHNOLOGY LIMITED is a new product for testing. ECIT only performed test cases which identified with Pass/Fail/Inc result in section 5.1.

ECIT has verified that the compliance of the tested device specified in section 3 of this test report is successfully evaluated according to the procedure and test methods as defined in type certification requirement listed in section 4 of this test report.

6. Test Equipment Utilized

No.	Name	Type	Series Number	Producer	Cal. Date	Cal. interval
1	Test Receiver	ESU40	100307	R&S	2018-05-11	1 Year
2	Trilog Antenna	VULB9163	VULB9163-515	Schwarzbeck	2017-02-25	3 Year
3	Loop Antenna	AL-130R	121083	COM-POWER	2016-11-21	3 Year
4	EMI Test Software	EMC32 V9.15	NA	R&S	NA	NA
5	Test Receiver	ESCI	101235	R&S	2018-05-11	1 Year
6	2-Line V-Network	ENV216	101380	R&S	2018-05-11	1 Year
7	EMI Test Software	EMC32 V9.12	NA	R&S	NA	NA
8	Vector Signal Analyser	FSQ26	101096	R&S	2018-05-11	1 Year
9	Climate chamber	SH-641	92012011	ESPEC	2017-12-05	2 Year

7. System Configuration during Test

7.1 Test Mode

Test Item	Function Type
20 dB bandwidth	Mode 1: TX mode <Figure 1>
Frequency Stability	Mode 1: TX mode <Figure 1>
Radiated Emissions	Mode 1: TX mode <Figure 1>
Conducted Emissions	Mode 1: TX mode <Figure 1>
Remark: The NFC function is opened in the setting menu. The EUT will transmit the NFC command continuously during the test, and will read the information from the Type A Card continuously.	

7.2 Connection Diagram of Test System

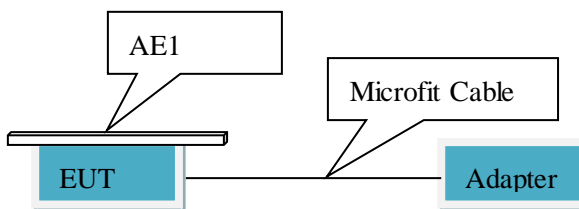

<Figure 1> Mode 1

8. Measurement Results

8.1 20dB Bandwidth

Reference

See Clause 6.9 of ANSI C63.10-2013

Measurement Methods

The transmitter output signal was picked up by coil antenna to the spectrum analyzer.

The transmitter output signal was picked up by coil antenna connected to the spectrum analyzer.

The bandwidth of the center frequency was measured with 140Hz RBW, 420Hz VBW and 14kHz span.

Test Setup

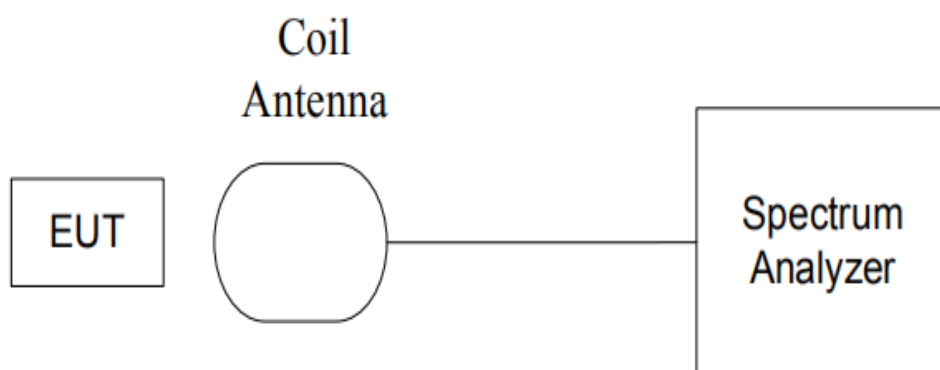

EUT Operating Mode and Test Conditions

The measurement of EUT is carried out under the transmit state of NFC and without modulation.

EUT had been not connected to a travel adapter.

During the measurements, the ambient temperature is in the range of 15~25°C.

Limits

The 20dB bandwidth shall be less than 80% of the permitted frequency band. For 13.56MHz NFC, the permitted frequency band is 14kHz, so the limit is 11.2kHz.

Uncertainty Measurement

The measurement uncertainty is 60.8Hz (k=2)

Test Results:

Carrier frequency (MHz)	20dB Bandwidth (kHz)	Conclusion
13.56	0.897	Pass

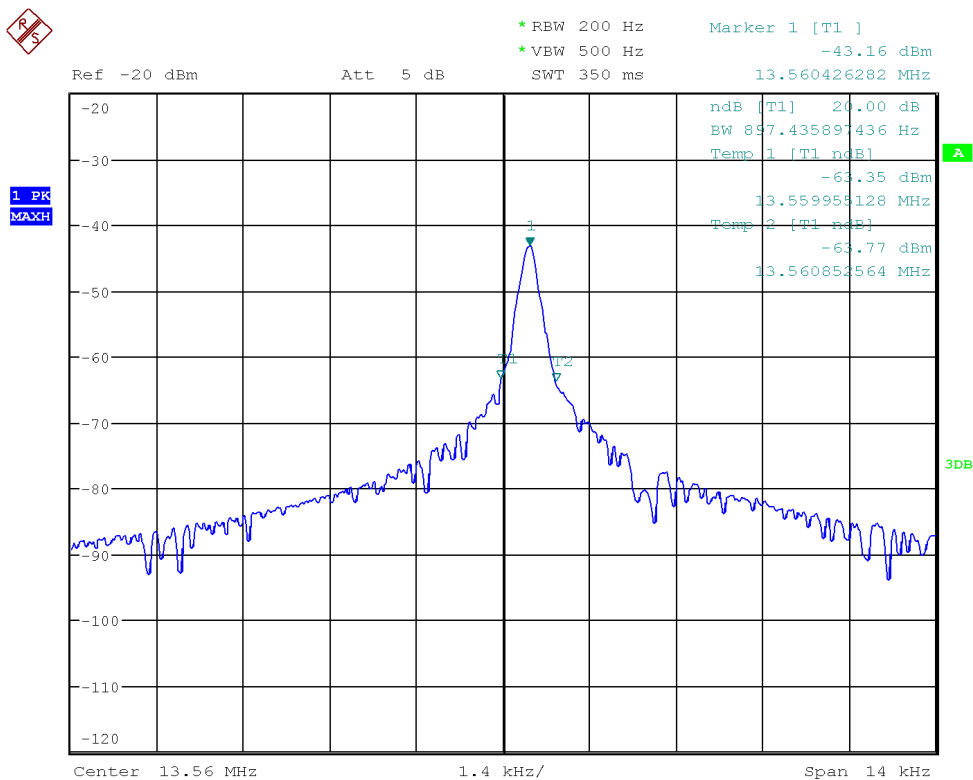

8.2 Frequency Stability

Reference

See Clause 6.8 of ANSI C63.10-2013

Measurement Methods

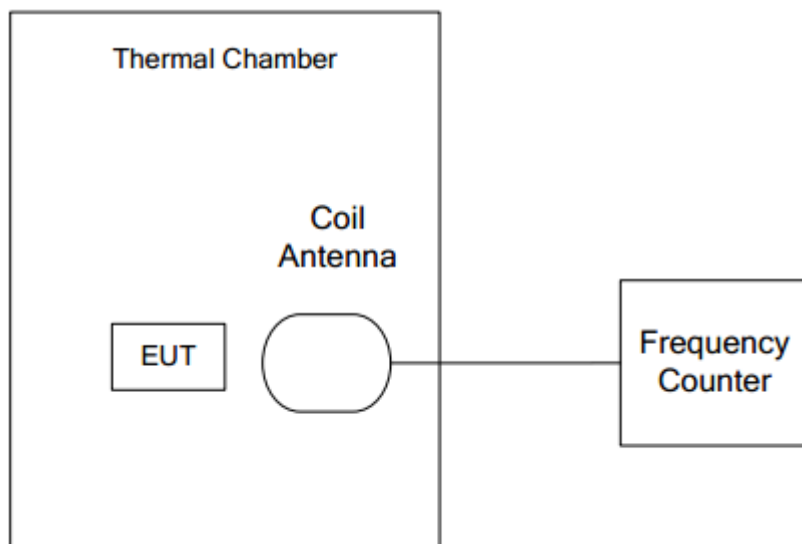

The transmitter output signal was picked up by coil antenna connected to the frequency counter. The center frequency was measured with 30Hz RBW and 1kHz span. During the test, the EUT was placed in a thermal chamber until thermal balance and lasting appropriate time.

EUT Operating Mode and Test Conditions

The measurement of EUT is carried out under the transmit state of without modulation, EUT1 had been not connected to a travel adapter.

Operation Temperature: $T_{min}=-20^{\circ}\text{C}$, $T_{nom}=25^{\circ}\text{C}$, and $T_{max}=50^{\circ}\text{C}$

Operation Voltage: $V_{min}=22.8\text{V}$, $V_{max}=25.2\text{V}$, and $T_{nom}=24\text{V}$.

Limits

The frequency tolerance of the carrier signal shall be maintained within $\pm 0.01\%$ of the operating frequency.

Uncertainty Measurement

The measurement uncertainty $U=60.8\text{Hz}(k=2)$.

Test Results

Temperature	Voltage	Frequency Error (MHz)			
		Startup	2Min Later	5Min Later	10Min Later
Tmin	Vnom	13.560825	13.560827	13.560820	13.560829
Tmax	Vnom	13.560814	13.560815	13.560817	13.560813
Tnom	Vnom	13.560833	13.560836	13.560839	13.560834
Tnom	Vmin	13.560828	13.560821	13.560822	13.560820
Tnom	Vmax	13.560809	13.560811	13.560813	13.560818

Temperature	Voltage	Frequency Error (%)			
		Startup	2Min Later	5Min Later	10Min Later
Tmin	Vnom	0.006	0.006	0.006	0.006
Tmax	Vnom	0.006	0.006	0.006	0.006
Tnom	Vnom	0.006	0.006	0.006	0.006
Tnom	Vmin	0.006	0.006	0.006	0.006
Tnom	Vmax	0.006	0.006	0.006	0.006

8.3 Radiated Emissions

8.3.1 Electric Field Strength of Fundamental Emissions

Reference

See Clause 6.4 of ANSI C63.10-2013

Method of Measurement

The test set-up was made in accordance to the general provisions of ANSI C63.10-2013. The transmitter carrier output levels (E-Field) from the EUT are measured in a semi-anechoic chamber. The EUT is placed on a non-conductive stand of 80cm high, and at a measurement distance of 3m from the receiving antenna. The center of the receiving antenna is 1 meter above the ground. The E-field is measured with a shielded loop antenna connected to a measurement receiver. Detected E-field was maximized by rotating the EUT through 360° and adjusting the receiving antenna polarizations. Both horizontal and vertical polarizations of the antenna were set during the measurement. The maximization processes were repeated with the EUT positioned respectively in its three orthogonal axes. The measurements were performed with the peak detector and if required, the quasi-peak detector.

The measurement bandwidth:

Frequency (MHz)	RBW / VBW
12.56-14.56	10 / 30kHz

The E-field measured at 3m is calculated as:

$$E\text{-field (dBuV/m)} = Rx \text{ (dBuV)} + \text{Cable Loss (dB)} + AF@3m \text{ (dB/m)}$$

Test Setup

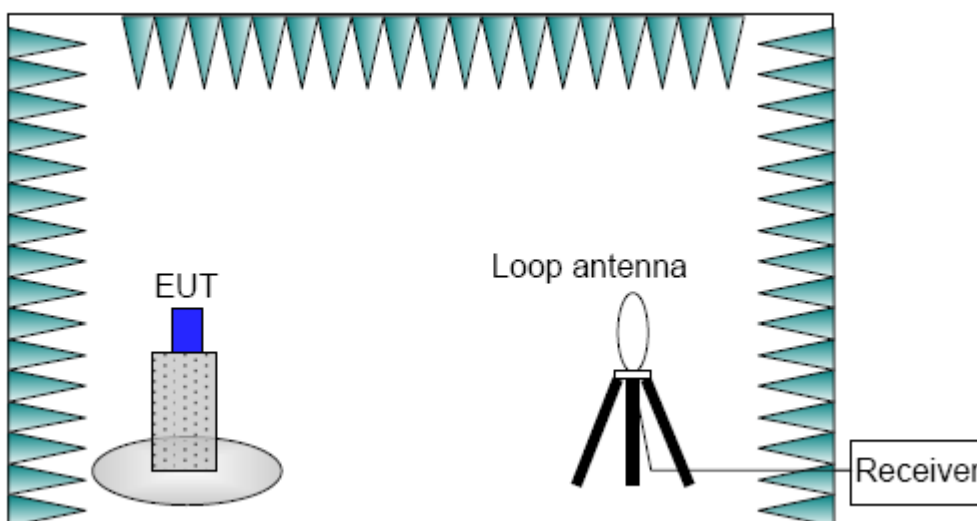

Limits

Clause 15.225(a) the field strength of any emissions within the band 13.553-13.567 MHz shall not exceed 15,848 microvolts/meter at 30 meters.

Clause 15.225(b) within the bands 13.410-13.553 MHz and 13.567-13.710 MHz, the field strength

of any emissions shall not exceed 334 microvolts/meter at 30 meters.

Clause 15.225(c) within the bands 13.110-13.410 MHz and 13.710-14.010 MHz the field strength of any emissions shall not exceed 106 microvolts/meter at 30 meters.

Frequency Range (MHz)	E-field Strength Limit @30m (uV/m)	E-field Strength Limit @3m (dBuV/m)
13.560 ± 0.007	+15,848	124
13.410 to 13.553 13.567 to 13.710	+334	90
13.110 to 13.410 13.710 to 14.010	+106	81

Note: Where the limits have been defined at one distance, and a signal level measured at another, the limits have been extrapolated using the following formula:

Extrapolation (dB) = $40 \log_{10}(\text{Measurement Distance} / \text{Specification Distance})$

Measurement Uncertainty

Measurement uncertainty: (9kHz-30MHz) 5.66dB k=2

Measurement Results

Measurement results of normal conditions see Figure 1 for different set-ups of EUT. The result displayed take into account applicable antenna factors and cable losses

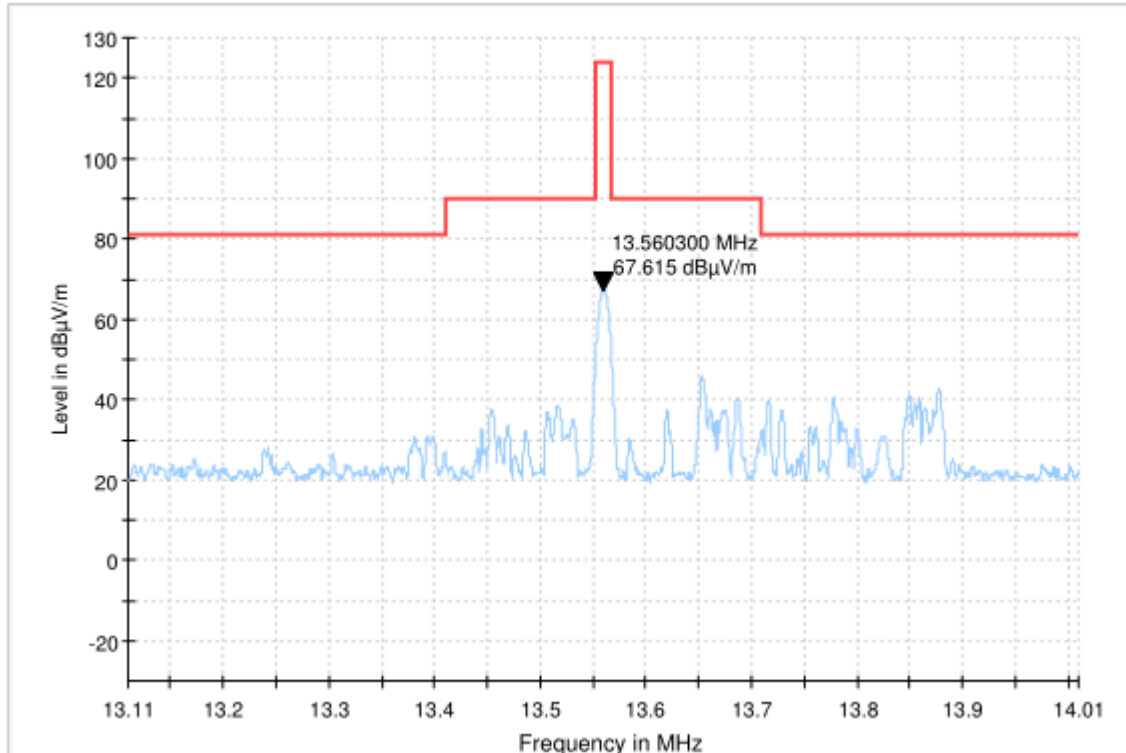

Figure 1 TX mode

8.3.2 Electric Field Radiated Emissions (Below 30MHz)

Reference

See Clause 6.4 of ANSI C63.10-2013

Method of Measurement

The electric field radiated emissions from the EUT are measured in a semi-anechoic chamber. The EUT is placed on a non-conductive stand of 80cm high, and at a measurement distance of 3m from the receiving antenna. The center of the receiving antenna is 1 meter above the ground. The E-field is measured with a shielded loop antenna connected to a measurement receiver. Detected E-field was maximized by rotating the EUT through 360° and adjusting the receiving antenna polarizations. Both horizontal and vertical polarizations of the antenna were set during the measurement. The maximization processes were repeated with the EUT positioned respectively in its three orthogonal axes. The measurements were performed with the peak detector and if required, the quasi-peak detector.

The measurement bandwidth:

Frequency (MHz)	RBW / VBW
0.009-30	10 / 30kHz

The E-field measured at 3m is calculated as:

$$E\text{-field (dBuV/m)} = Rx \text{ (dBuV)} + \text{Cable Loss (dB)} + AF@3m \text{ (dB/m)}$$

Test Setup

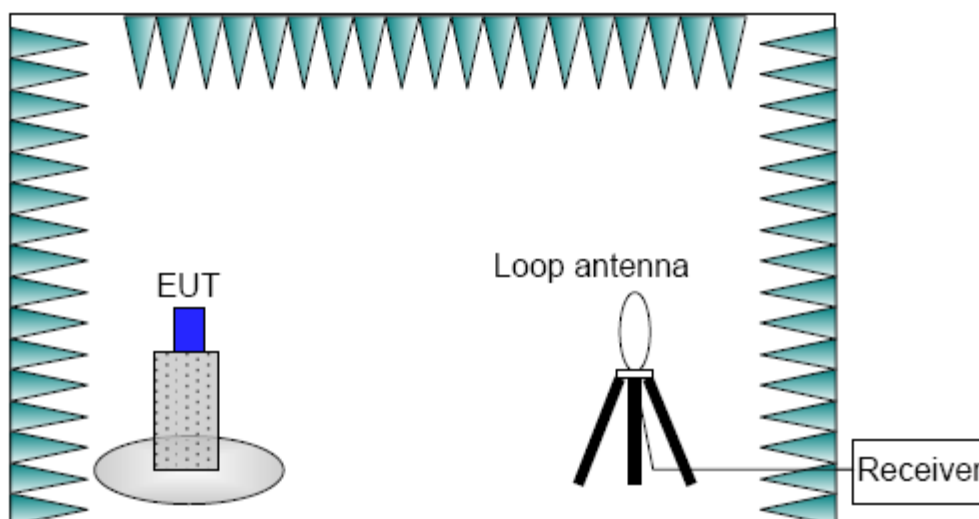

Limits

Frequency Range (MHz)	E-field Strength Limit @30m (mV/m)	E-field Strength Limit @3m (dBuV/m)
0.009-0490	2400/F (kHz)	129-94
0.490-1.705	24000/F (kHz)	74-63
1.705-30	30	70

Note: Where the limits have been defined at one distance, and a signal level measured at another, the limits have been extrapolated using the following formula:

Extrapolation (dB) = $40\log_{10}$ (Measurement Distance / Specification Distance)

Measurement Uncertainty

Measurement uncertainty: (9kHz-30MHz) 5.66dB k=2

Measurement Results

Measurement results of normal conditions see Figure 2 for different set-ups of EUT. The result displayed take into account applicable antenna factors and cable losses

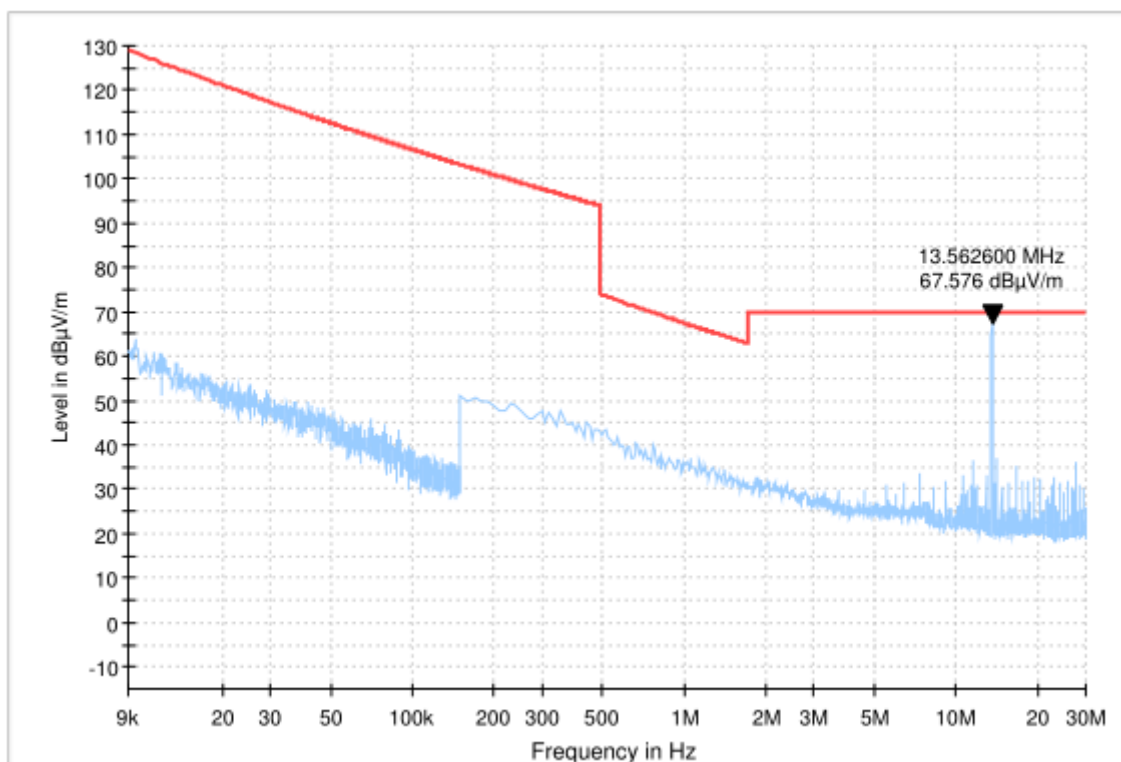

Figure 1 TX mode (9kHz-30MHz)

8.3.3 Electric Field Radiated Emissions (Above 30MHz)

Reference

See Clause 6.5 of ANSI C63.10-2013

Method of Measurement

The electric field radiated emissions from the EUT are measured in a semi-anechoic chamber. The EUT is placed on a non-conductive stand of 80cm high, and at a measurement distance of 3m from the receiving antenna. The table was rotated 360 degree and the received antenna mounted on a variable-height antenna tower was varied from 1m to 4m to find the maximum value of the field strength. Both horizontal and vertical polarizations of the antenna were set during the measurement. The data of cable loss and antenna factor has been calibrated in full testing frequency range before the testing. The measurements were performed with the peak detector and if required, the quasi-peak detector.

The measurement bandwidth:

Frequency (MHz)	RBW / VBW
30-1000	120 kHz / 300kHz

Test Setup

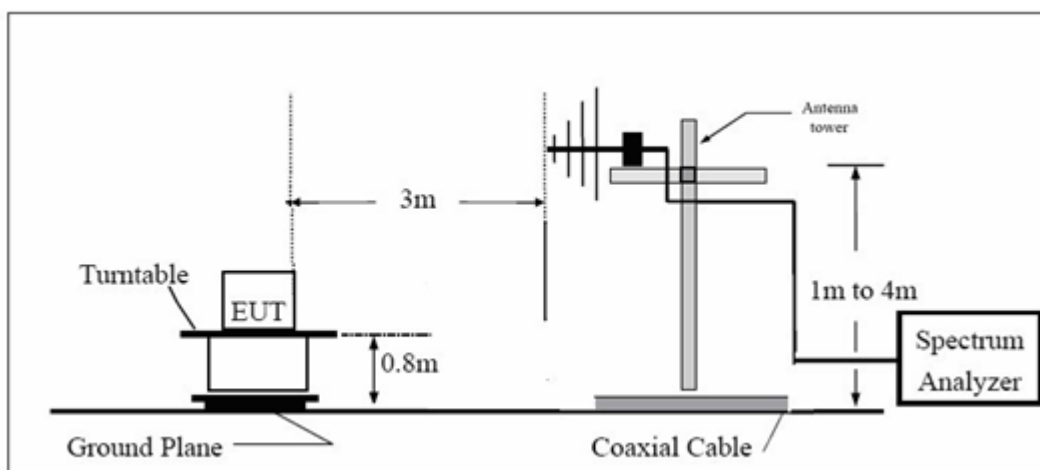

Limits

Frequency Range (MHz)	E-field Strength Limit @3m (mV/m)	E-field Strength Limit @3m (dBuV/m)
30-88	100	40
88-216	150	43.5
216-960	200	46
960-1000	500	54

Measurement Uncertainty

Measurement uncertainty: (30MHz-1000MHz) 4.98dB k=2

Measurement Results

Measurement results of normal conditions see Figure 3 for different set-ups of EUT. The result displayed take into account applicable antenna factors and cable losses

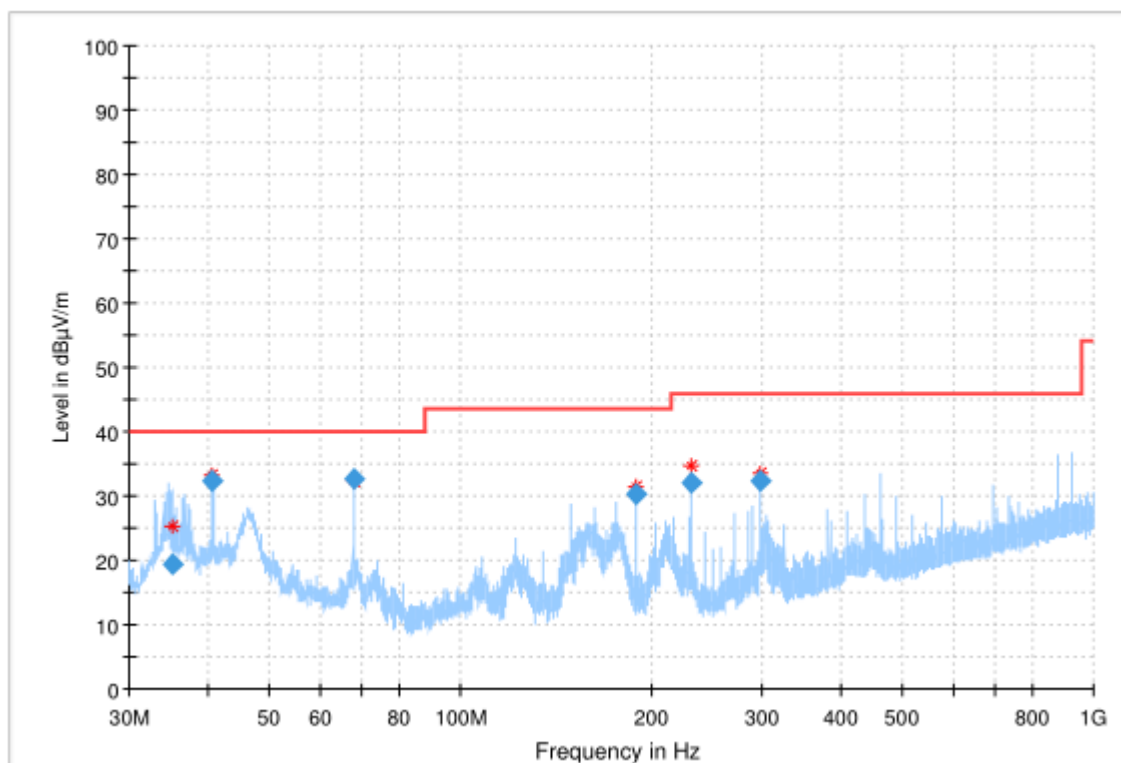

Figure 1 TX mode (30MHz-1000MHz)

Frequency (MHz)	QuasiPeak (dBµV/m)	Limit (dBµV/m)	Margin (dB)	Meas. Time (ms)	Bandwidth (kHz)	Height (cm)	PoI	Azimuth (deg)	Corr. (dB)
35.054259	19.34	40.00	20.66	1000.0	120.000	100.0	V	67.0	-22.0
40.669091	32.26	40.00	7.74	1000.0	120.000	100.0	V	321.0	-20.8
67.803717	32.57	40.00	7.43	1000.0	120.000	100.0	V	80.0	-24.5
189.840211	30.18	43.50	13.32	1000.0	120.000	115.0	H	207.0	-25.1
231.344587	32.02	46.00	13.98	1000.0	120.000	115.0	H	248.0	-23.6
298.318773	32.25	46.00	13.75	1000.0	120.000	109.0	H	306.0	-22.0

8.4 Conducted Emissions

Reference

See Clause 6.2 of ANSI C63.10-2013

Methods of Measurement

The conducted emissions from the AC port of the EUT are measured in a shielding room. The EUT is connected to a Line Impedance Stabilization Network (LISN). An overview sweep with peak detection was performed. The measurements were performed with a quasi-peak detector and if required, an average detector. Tested in accordance with the procedures of ANSI C63.10-2013. The conducted emission measurements were made with the following detector of the test receiver Quasi-Peak / Average Detector.

Test Setup

The measurement bandwidth and Test Condition

Frequency (MHz)	RBW	Sweep Time (s)	Test Voltage
0.15-30	9 kHz	Auto	120V/60Hz

Test Setup

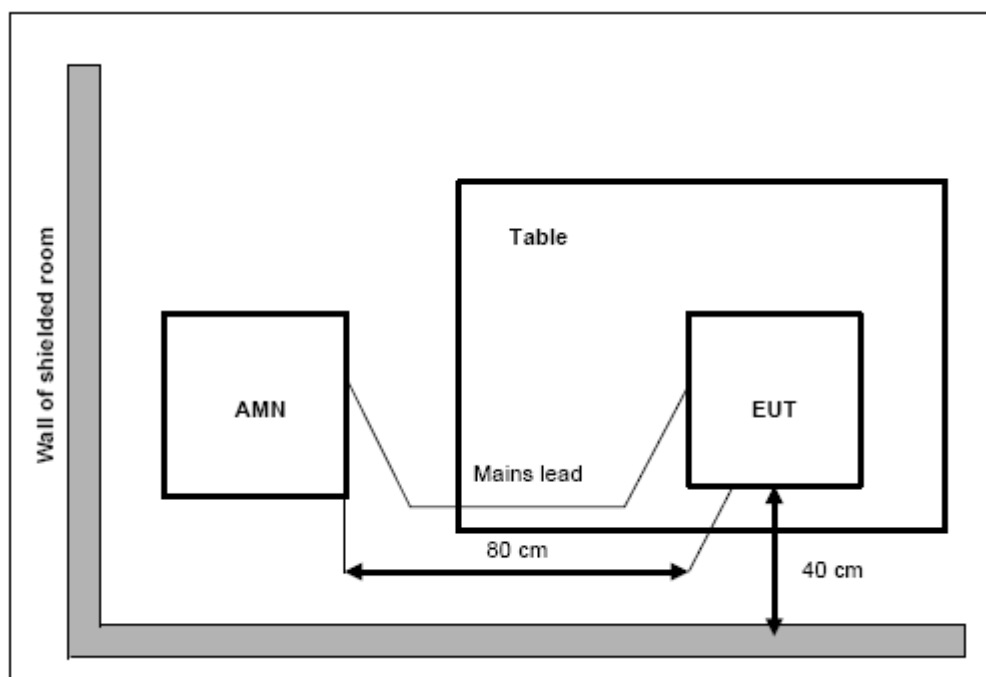

Limits

Frequency Range (MHz)	Conducted Limit (dBuV)	
	Quasi-peak	Average
0.15-0.5	66 to 56*	56 to 46*
0.5-5	56	46
5-30	60	50

*Decreases with the logarithm of the frequency

Measurement Uncertainty

Measurement uncertainty: (150kHz-30MHz) 3.66dB k=2

Measurement Results

Note: The measurement result at 13.56MHz is the fundamental emission of NFC signal.

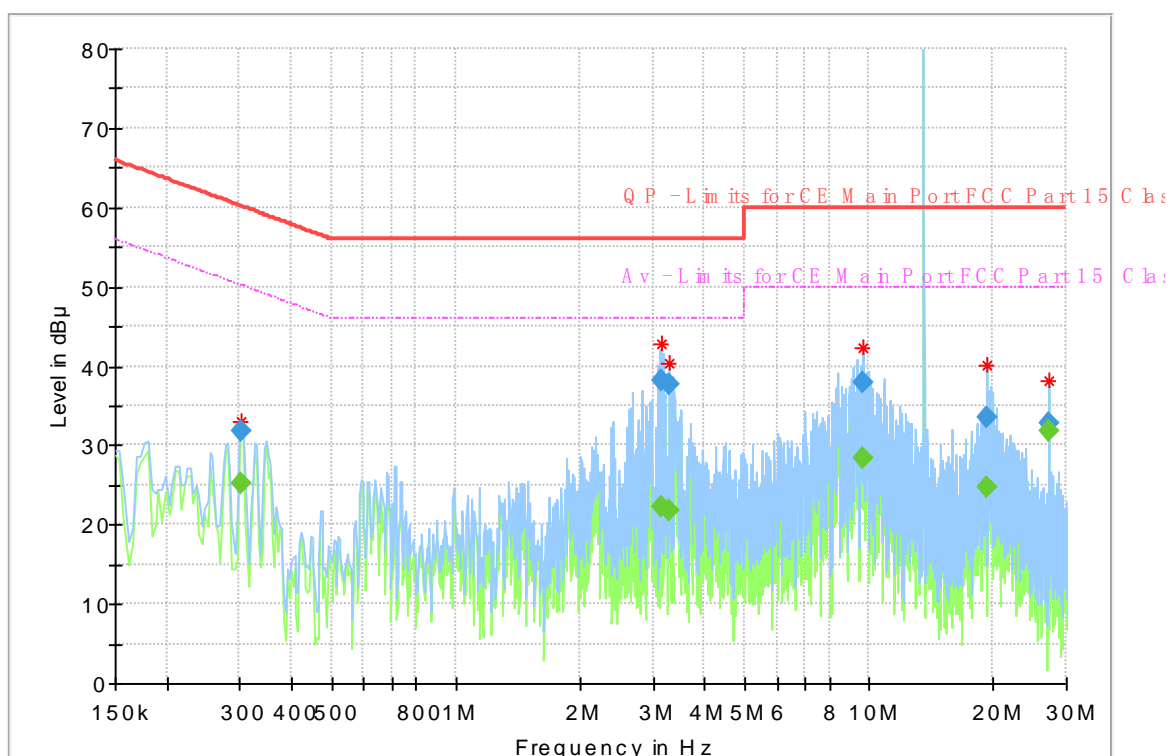

Figure 1 TX mode (150kHz-30MHz)

Frequency (MHz)	QuasiPeak (dBµV)	Average (dBµV)	Limit (dBµV)	Margin (dB)	Meas. Time	Bandwidth (kHz)	Line	Filter	Corr. (dB)
0.302981	---	25.25	50.16	24.91	1000.0	9.000	N	ON	9.7
0.302981	31.79	---	60.16	28.37	1000.0	9.000	N	ON	9.7
3.142463	38.12	---	56.00	17.88	1000.0	9.000	L1	ON	9.7
3.142463	---	22.25	46.00	23.75	1000.0	9.000	L1	ON	9.7
3.291713	37.62	---	56.00	18.39	1000.0	9.000	N	ON	9.7
3.291713	---	21.86	46.00	24.14	1000.0	9.000	N	ON	9.7
9.634838	37.85	---	60.00	22.15	1000.0	9.000	L1	ON	9.8
9.634838	---	28.27	50.00	21.73	1000.0	9.000	L1	ON	9.8
19.216688	---	24.71	50.00	25.29	1000.0	9.000	N	ON	9.9
19.216688	33.60	---	60.00	26.40	1000.0	9.000	N	ON	9.9
27.123206	32.86	---	60.00	27.14	1000.0	9.000	L1	ON	9.9
27.123206	---	31.79	50.00	18.21	1000.0	9.000	L1	ON	9.9

Note:

1. Emission level(quasi-peak or Average peak)=Raw value by receiver + Corr(Insertion loss+cable loss)
2. The raw value is used to calculate by software which is not shown in the sheet.
3. Margin=limit value – emission level.
4. L1 and N line is all have been tested , the result of them is synthesized in the above data diagram.

Annex A Test Configuration Photos

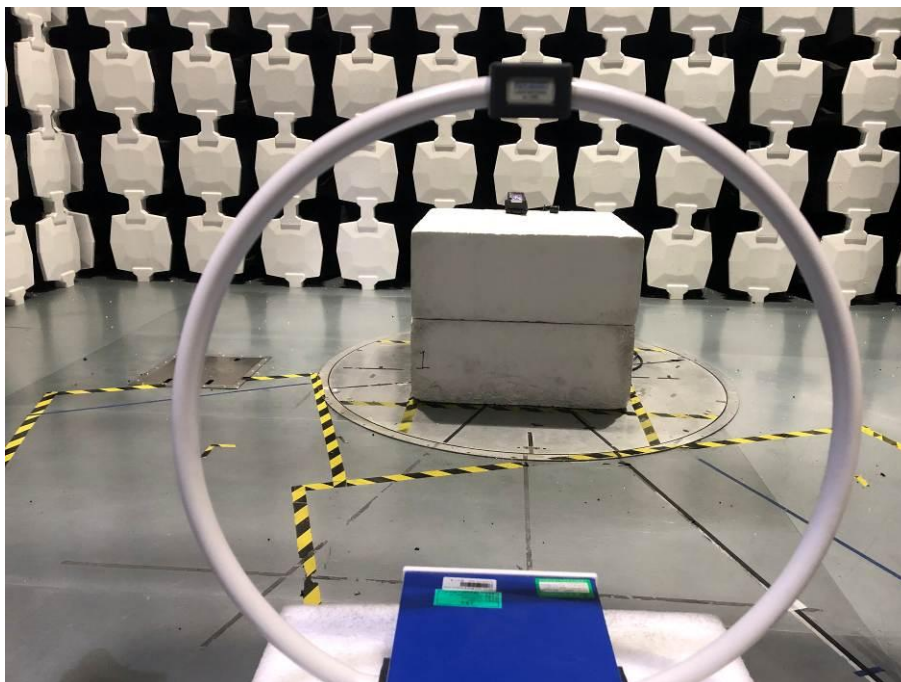

Picture1: Field Radiated Emissions (Below 30MHz)

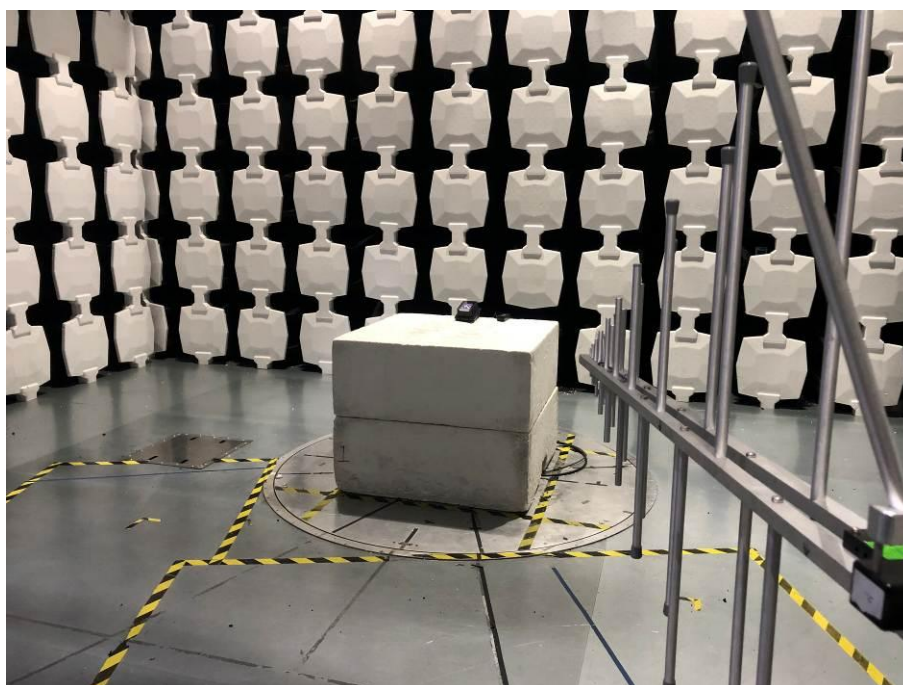

Picture2: Field Radiated Emissions (Above 30MHz)



Picture3: Conducted Emissions

*****END OF REPORT*****