

TEST REPORT

Product Name : Roller Shade Driver E1
Model Number : RSD-M01
FCC ID : 2AKIT-RSDM01

Prepared for : Lumi United Technology Co., Ltd
Address : B1, Chongwen Park, Nanshan iPark, Liuxian Avenue,
Taoyuan Residential District, Nanshan District Shenzhen,
China

Prepared by : EMTEK (DONGGUAN) CO., LTD.
Address : -1&2/F., Building 2, Zone A, Zhongda Marine Biotechnology
Research and Development Base, No.9, Xincheng Avenue,
Songshanhu High-technology Industrial Development Zone,
Dongguan, Guangdong, China

TEL: +86-0769-22807078
FAX: +86-0769-22807079

Report Number : EDG2303290157E00701R
Date(s) of Tests : March 29, 2023 to April 10, 2023
Date of issue : April 10, 2023

TABLE OF CONTENTS

1	TEST RESULT CERTIFICATION	3
2	EUT TECHNICAL DESCRIPTION	5
3	SUMMARY OF TEST RESULT	6
4	TEST METHODOLOGY	7
4.1	GENERAL DESCRIPTION OF APPLIED STANDARDS	7
4.2	MEASUREMENT EQUIPMENT USED	7
4.3	DESCRIPTION OF TEST MODES	8
5	FACILITIES AND ACCREDITATIONS	9
5.1	FACILITIES	9
5.2	LABORATORY ACCREDITATIONS AND LISTINGS	9
6	TEST SYSTEM UNCERTAINTY	10
7	SETUP OF EQUIPMENT UNDER TEST	11
7.1	RADIO FREQUENCY TEST SETUP 1	11
7.2	RADIO FREQUENCY TEST SETUP 2	11
7.3	CONDUCTED EMISSION TEST SETUP	13
7.4	BLOCK DIAGRAM CONFIGURATION OF TEST SYSTEM	14
7.5	SUPPORT EQUIPMENT	14
8	TEST REQUIREMENTS	15
8.1	DTS (6DB) BANDWIDTH	15
8.2	MAXIMUM PEAK CONDUCTED OUTPUT POWER	21
8.3	MAXIMUM POWER SPECTRAL DENSITY	24
8.4	UNWANTED EMISSIONS IN NON-RESTRICTED FREQUENCY BANDS	27
8.5	RADIATED SPURIOUS EMISSION	34
8.6	CONDUCTED EMISSIONS TEST	44
8.7	ANTENNA APPLICATION	47

1 TEST RESULT CERTIFICATION

Applicant : Lumi United Technology Co., Ltd

Address : B1, Chongwen Park, Nanshan iPark, Liuxian Avenue, Taoyuan Residential District, Nanshan District Shenzhen, China

Manufacturer : Lumi United Technology Co., Ltd.

Address : B1, Chongwen Park, Nanshan iPark, Liuxian Avenue, Taoyuan Residential District, Nanshan District Shenzhen, China

EUT : Roller Shade Driver E1

Model Name : RSD-M01

Trademark : N/A

Measurement Procedure Used:

APPLICABLE STANDARDS	
STANDARD	TEST RESULT
FCC 47 CFR Part 2 , Subpart J FCC 47 CFR Part 15, Subpart C	PASS
IC RSS-GEN, Issue 5(04-2018)+A1(03-2019)+A2(02-2021) IC RSS-247 Issue 2(02-2017)	PASS

The above equipment was tested by EMTEK(DONGGUAN) CO., LTD. The test data, data evaluation, test procedures, and equipment configurations shown in this report were made in accordance with the procedures given in ANSI C63.10 (2013) and the energy emitted by the sample EUT tested as described in this report is in compliance with the requirements of FCC Rules Part 2, Part 15.247, IC RSS-247 Issue 2 and IC RSS-GEN, Issue 5.

The test results of this report relate only to the tested sample identified in this report.

Date of Test : March 29, 2023 to April 10, 2023

Prepared by : Warren Deng

Warren Deng /Editor

Reviewer : Tim Dong

Tim Dong/ Supervisor

Approve & Authorized Signer : Sam Lv

Sam Lv / Manager

Modified History

Version	Report No.	Revision Date	Summary
	EDG2303290157E00701R	/	Original Report



2 EUT TECHNICAL DESCRIPTION

Characteristics	Description
Device Type:	2.4G ISM Band
Standards:	IEEE802.15.4
Modulation:	O-QPSK
Operating Frequency Range(s):	2405-2480MHz
Number of Channels:	16 Channels
Channel Separation:	5MHz
Transmit Power Max:	-9.81dBm
Antenna Type :	FPC Antenna
Antenna Gain:	1.75 dBi
Power supply:	<input checked="" type="checkbox"/> : DC 5V for USB C <input checked="" type="checkbox"/> : DC 7.4V for battery
	<input type="checkbox"/> Adapter : Model: Input: Output:

Note: for more details, please refer to the User's manual of the EUT.

3 SUMMARY OF TEST RESULT

FCC Part Clause	Test Parameter	Verdict	Remark
15.247(a)(2)	DTS (6dB) Bandwidth	PASS	
15.247(b)(3)	Maximum Peak Conducted Output Power	PASS	
15.247(e)	Maximum Power Spectral Density Level	PASS	
15.247(d)	Unwanted Emission Into Non-Restricted Frequency Bands	PASS	
15.247(d) 15.209	Unwanted Emission Into Restricted Frequency Bands (conducted)	PASS	
15.247(d) 15.209	Radiated Spurious Emission	PASS	
15.207	Conducted Emission Test	PASS	
15.247(b)	Antenna Application	PASS	
<p>NOTE1: N/A (Not Applicable)</p> <p>NOTE2: According to FCC OET KDB 558074, the report use radiated measurements in the restricted frequency bands. In addition, the radiated test is also performed to ensure the emissions emanating from the device cabinet also comply with the applicable limits.</p>			

RELATED SUBMITTAL(S) / GRANT(S):

This submittal(s) (test report) is intended for FCC ID: 2AKIT-RSDM01 filing to comply with Section 15.247 of the FCC Part 15, Subpart C Rules.

The system is compliance with Subpart B is authorized under a DOC procedure

4 TEST METHODOLOGY

4.1 GENERAL DESCRIPTION OF APPLIED STANDARDS

According to its specifications, the EUT must comply with the requirements of the following standards:

FCC 47 CFR Part 2, Subpart J

FCC 47 CFR Part 15, Subpart C

FCC KDB 558074 D01 DTS Meas Guidance v04

4.2 MEASUREMENT EQUIPMENT USED

Conducted Emission Test Equipment

Equipment	Manufacturer	Model No.	Serial No.	Last Cal.	Cal. Interval
Test Receiver	Rohde& Schwarz	ESCI	100137	2022/05/19	1Year
L.I.S.N.	Rohde& Schwarz	ENV216	101209	2022/05/19	1Year
RF Switching Unit	CDS	RSU-M2	38401	2022/05/19	1Year

For Spurious Emissions Test

Equipment	Manufacturer	Model No.	Serial No.	Last Cal.	Cal. Interval
EMI Test Receiver	Rohde & Schwarz	ESCI	101415	2022/05/19	1Year
Power Amplifier	HP	8447F	OPTH64	2022/05/19	1Year
Bilog Antenna	Schwarzbeck	VULB9163	141	2022/05/22	1Year
Horn antenna	Schwarzbeck	BBHA9120D	1272	2022/05/22	1Year
Power Amplifier	LUNAR EM	LNA1G18-40	J10100000081	2022/05/19	1Year
Loop Antenna	Schwarzbeck	FMZB1513	1513-60	2022/05/22	2 Year
Signal Analyzer	R&S	FSV30	103039	2022/05/19	1Year
Bilog Antenna	Schwarzbeck	VULB9163	141	2022/05/22	1Year
Band reject Filter(50dB)	WI/DE	WRCGV-2400(2400-2485MHz)	2	2022/05/20	1 Year

For other test items:

Equipment	Manufacturer	Model No.	Serial No.	Last Cal.	Cal. Interval
Wireless Connectivity Tester	R&S	CMW270	102543	2022/06/21	1Year
Automatic Control Unit	Tonscend	JS0806-2	2118060480	2022/06/21	1Year
Signal Analyzer	KEYSIGHT	N9010B	MY60242456	2022/06/21	1Year
Analog Signal Generator	KEYSIGHT	N5173B	MY61252625	2022/06/21	1Year
UP/DOWN-Converter	R&S	CMW-Z800A	100274	2022/06/21	1Year
Vector Signal Generator	KEYSIGHT	N5182B	MY61252674	2022/06/21	1Year
Frequency Extender	KEYSIGHT	N5182BX07	MY59362541	2022/06/21	1Year
Temperature&Humidity test chamber	ESPEC	EL-02KA	12107166	2022/06/21	1 Year

Remark: Each piece of equipment is scheduled for calibration once a year.

4.3 DESCRIPTION OF TEST MODES

The EUT has been tested under its typical operating condition.

The EUT configuration for testing is installed on RF field strength measurement to meet the Commissions requirement and operating in a manner which intends to maximize its emission characteristics in a continuous normal application.

The Transmitter was operated in the normal operating mode. The TX frequency was fixed which was for the purpose of the measurements.

Test of channel included the lowest and middle and highest frequency to perform the test, then record on this report.

Pre-defined engineering program for regulatory testing used to control the EUT for staying in continuous transmitting and receiving mode is programmed.

Frequency and Channel list:

Channel	Frequency (MHz)	Channel	Frequency (MHz)	Channel	Frequency (MHz)
1	2405	7	2435	13	2465
2	2410	8	2440	14	2470
3	2415	9	2445	15	2475
4	2420	10	2450	16	2480
5	2425	11	2455		
6	2430	12	2460		

Test Frequency and Channel:

Lowest Frequency		Middle Frequency		Highest Frequency	
Channel	Frequency (MHz)	Channel	Frequency (MHz)	Channel	Frequency (MHz)
1	2405	8	2440	16	2480

5 FACILITIES AND ACCREDITATIONS

5.1 FACILITIES

All measurement facilities used to collect the measurement data are located at:

EMTEK (DONGGUAN) CO., LTD.

-1&2/F., Building 2, Zone A, Zhongda Marine Biotechnology Research and Development Base, No.9, Xincheng Avenue, Songshanhu High-technology Industrial Development Zone, Dongguan, Guangdong, China

The sites are constructed in conformance with the requirements of ANSI C63.7, ANSI C63.4 and CISPR Publication 22.

5.2 LABORATORY ACCREDITATIONS AND LISTINGS

Site Description

EMC Lab. : Accredited by CNAS, 2020.08.27
The certificate is valid until 2024.07.05
The Laboratory has been assessed and proved to be in compliance with
CNAS-CL01:2018
The Certificate Registration Number is L3150

Accredited by FCC
Designation Number: CN1300
Test Firm Registration Number: 945551

Accredited by A2LA, April 05, 2021
The Certificate Registration Number is 4321.02

Accredited by Industry Canada
The Certificate Registration Number is CN0113

Name of Firm : EMTEK (DONGGUAN) CO., LTD.

Site Location : -1&2/F., Building 2, Zone A, Zhongda Marine Biotechnology Research and Development Base, No.9, Xincheng Avenue, Songshanhu High-technology Industrial Development Zone, Dongguan, Guangdong, China

6 TEST SYSTEM UNCERTAINTY

The following measurement uncertainty levels have been estimated for tests performed on the apparatus:

Parameter	Uncertainty
Radio Frequency	$\pm 1 \times 10^{-5}$
Maximum Peak Output Power Test	$\pm 1.0\text{dB}$
Conducted Emissions Test	$\pm 2.0\text{dB}$
Radiated Emission Test	$\pm 2.0\text{dB}$
Power Density	$\pm 2.0\text{dB}$
Occupied Bandwidth Test	$\pm 1.0\text{dB}$
Band Edge Test	$\pm 3\text{dB}$
All emission, radiated	$\pm 3\text{dB}$
Antenna Port Emission	$\pm 3\text{dB}$
Temperature	$\pm 0.5^\circ\text{C}$
Humidity	$\pm 3\%$

Measurement Uncertainty for a level of Confidence of 95%

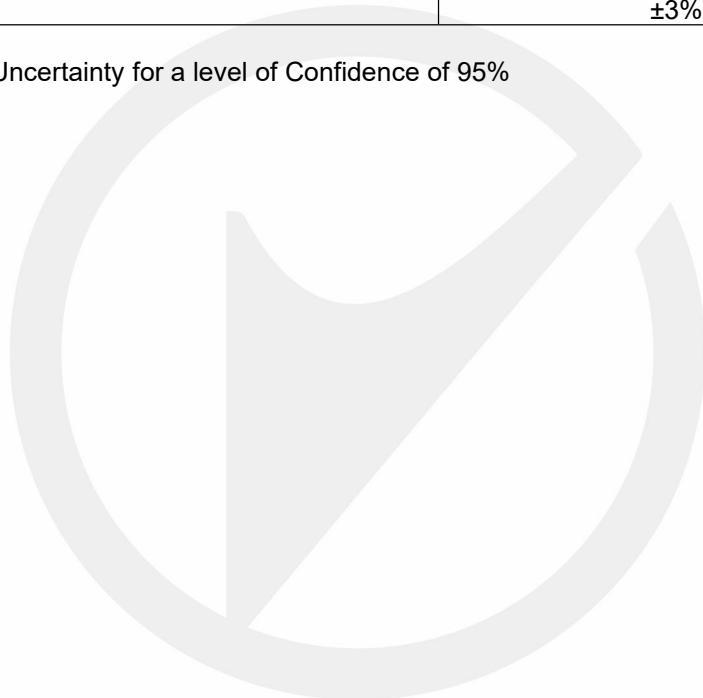

7 SETUP OF EQUIPMENT UNDER TEST

7.1 RADIO FREQUENCY TEST SETUP 1

The WLAN component's antenna ports(s) of the EUT are connected to the measurement instrument per an appropriate attenuator. The EUT is controlled by PC/software to emit the specified signals for the purpose of measurements.

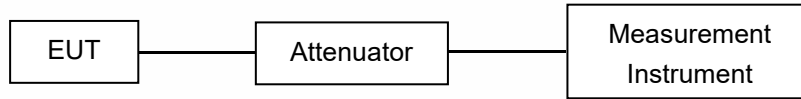

7.2 RADIO FREQUENCY TEST SETUP 2

The test site semi-anechoic chamber has met the requirement of NSA tolerance 4 dB according to the standards: ANSI C63.4. The test distance is 3m. The setup is according to the requirements in Section 13.1.4.1 of ANSI C63.4-2014 and CAN/CSA-CEI/IEC CISPR 22.

Below 30MHz:

The EUT is placed on a turntable 0.8 meters above the ground in the chamber, 3 meter away from the antenna (loop antenna). The Antenna should be positioned with its plane vertical at the specified distance from the EUT and rotated about its vertical axis for maximum response at each azimuth about the EUT. The center of the loop shall be 1 m above the ground. For certain applications, the loop antenna plane may also need to be positioned horizontally at the specified distance from the EUT.

Above 30MHz:

The EUT is placed on a turntable 0.8 meters above the ground in the chamber, 3 meter away from the antenna. The maximal emission value is acquired by adjusting the antenna height, polarisation and turntable azimuth. Normally, the height range of antenna is 1 m to 4 m, the azimuth range of turntable is 0° to 360°, and the receive antenna has two polarizations Vertical (V) and Horizontal (H).

Above 1GHz:

(Note: the FCC's permission to use 1.5m as an alternative per TCBC Conf call of Dec. 2, 2014.)

The EUT is placed on a turntable 1.5 meters above the ground in the chamber, 3 meter away from the antenna. The maximal emission value is acquired by adjusting the antenna height, polarisation and turntable azimuth. Normally, the height range of antenna is 1 m to 4 m, the azimuth range of turntable is 0° to 360°, and the receive antenna has two polarizations Vertical (V) and Horizontal (H).

(a) Radiated Emission Test Set-Up, Frequency Below 30MHz

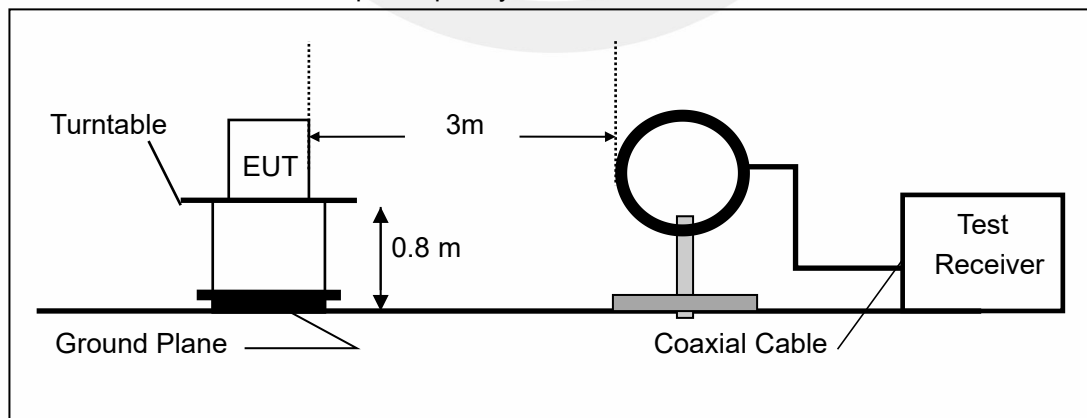

(b) Radiated Emission Test Set-Up, Frequency Below 1000MHz

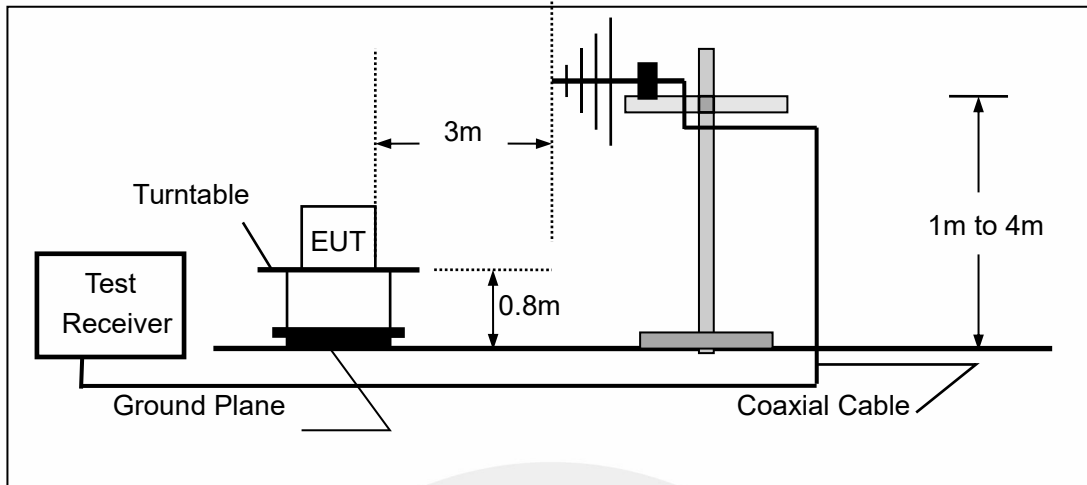

(c) Radiated Emission Test Set-Up, Frequency above 1000MHz

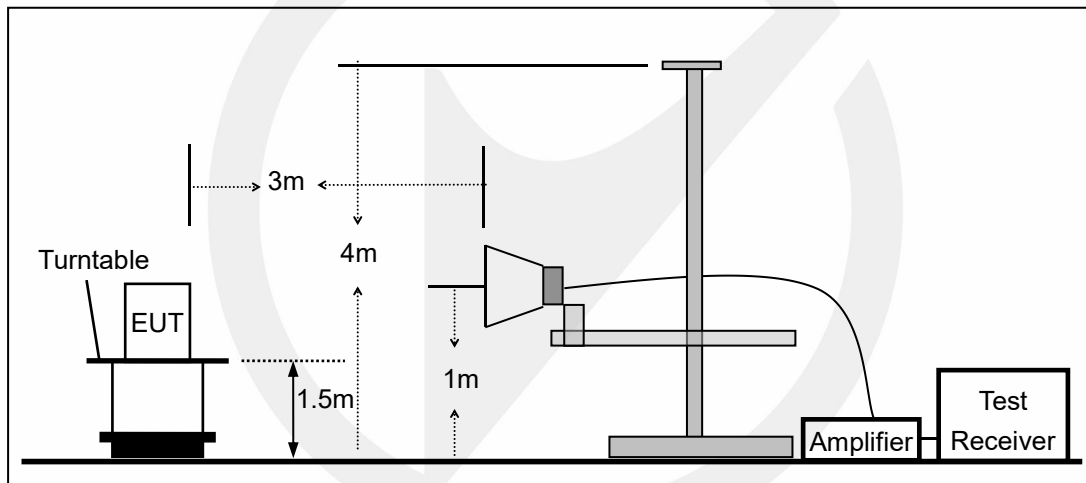

7.3 CONDUCTED EMISSION TEST SETUP

The mains cable of the EUT (maybe per AC/DC Adapter) must be connected to LISN. The LISN shall be placed 0.8 m from the boundary of EUT and bonded to a ground reference plane for LISN mounted on top of the ground reference plane. This distance is between the closest points of the LISN and the EUT. All other units of the EUT and associated equipment shall be at least 0.8m from the LISN.

Ground connections, where required for safety purposes, shall be connected to the reference ground point of the LISN and, where not otherwise provided or specified by the manufacturer, shall be of same length as the mains cable and run parallel to the mains connection at a separation distance of not more than 0.1 m.

According to the requirements in Section 13.1.4.1 of ANSI C63.4-2014 Conducted emissions from the EUT measured in the frequency range between 0.15 MHz and 30 MHz using CISPR Quasi-Peak and average detector mode.

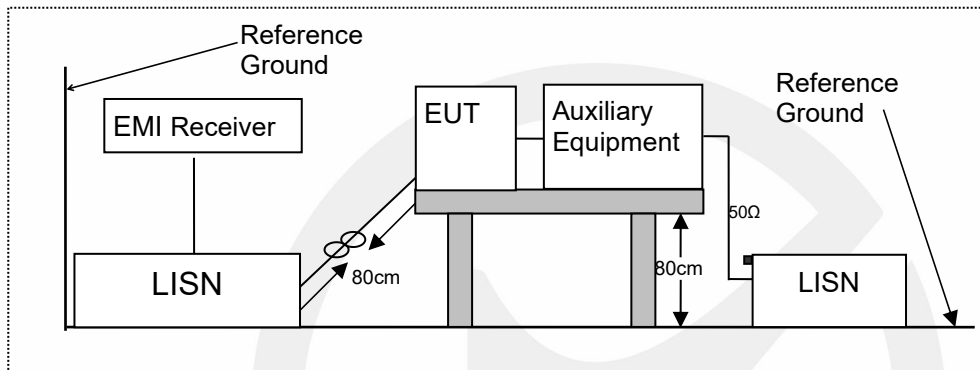

7.4 BLOCK DIAGRAM CONFIGURATION OF TEST SYSTEM

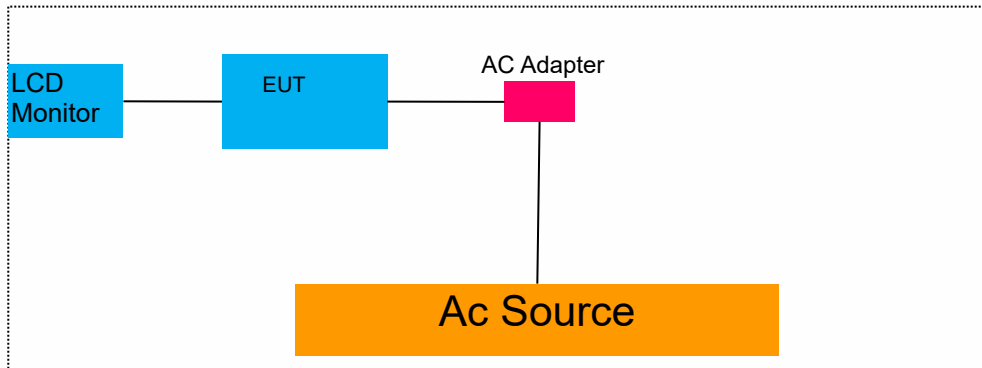

7.5 SUPPORT EQUIPMENT

EUT Cable List and Details			
Cable Description	Length (m)	Shielded/Unshielded	With / Without Ferrite
Adapter cable	1.0	Unshielded	Without Ferrite

Auxiliary Cable List and Details			
Cable Description	Length (m)	Shielded/Unshielded	With / Without Ferrite

Auxiliary Equipment List and Details			
Description	Manufacturer	Model	Serial Number
Notebook	Lenovo	E46L	11S168003748Z0LR0 6E0HG
Adaptor	APPLE	/	/

Notes:

1. All the equipment/cables were placed in the worst-case configuration to maximize the emission during the test.
2. Grounding was established in accordance with the manufacturer's requirements and conditions for the intended use.

8 TEST REQUIREMENTS

8.1 DTS (6DB) BANDWIDTH

Applicable Standard

According to FCC Part 15.247(a)(2) and KDB 558074 DTS 01 Meas. Guidance v04

Conformance Limit

The minimum -6 dB bandwidth shall be at least 500 kHz.

Test Configuration

Test according to clause 7.1 radio frequency test setup 1

Test Procedure

The EUT was operating in O-QPSK mode and controlled its channel. Printed out the test result from the spectrum by hard copy function.

The RF output of EUT was connected to the spectrum analyzer by RF cable and attenuator. The path loss was compensated to the results for each measurement.

Set to the maximum power setting and enable the EUT transmit continuously

Set RBW = 100 kHz.

Set the video bandwidth (VBW) =300 kHz.

Set Span=2 times OBW

Set Detector = Peak.

Set Trace mode = max hold.

Set Sweep = auto couple.

Allow the trace to stabilize.

Measure the maximum width of the emission that is constrained by the frequencies associated with the two outermost amplitude points (upper and lower frequencies) that are attenuated by 6 dB relative to the maximum level measured in the fundamental emission.

Measure and record the results in the test report.

Test Results

Temperature:	26° C
Relative Humidity:	54%
ATM Pressure:	1011 mbar

TestMode	Antenna	Frequency[MHz]	DTS BW [MHz]	FL[MHz]	FH[MHz]	Limit[MHz]	Verdict
ZIGB	Ant1	2405	1.380	2404.220	2405.600	0.5	PASS
ZIGB	Ant1	2440	1.470	2439.200	2440.670	0.5	PASS
ZIGB	Ant1	2480	1.380	2479.270	2480.650	0.5	PASS



ZIGB-Ant1-2405



ZIGB-Ant1-2440



ZIGB-Ant1-2480

8.2 DTS 99% BANDWIDTH

Applicable Standard

According to RSS-Gen 6.7 and KDB 558074 D01 DTS Meas Guidance v05r02

Test Configuration

Test according to clause 7.1 radio frequency test setup 1

Test Procedure

The EUT was operating in Bluetooth mode and controlled its channel. Printed out the test result from the spectrum by hard copy function.

The RF output of EUT was connected to the spectrum analyzer by RF cable and attenuator. The path loss was compensated to the results for each measurement.

Set to the maximum power setting and enable the EUT transmit continuously

Set RBW = 1%-5% OBW(43 KHz).

Set the video bandwidth (VBW) =130 kHz.

Set Span=4 MHz

Set Detector = Peak.

Set Trace mode = max hold.

Set Sweep = auto couple.

Allow the trace to stabilize.

Use the 99 % power bandwidth function of the instrument

Measure the maximum width of the emission.

Measure and record the results in the test report.

Test Results

Temperature:	25°C
Relative Humidity:	45%
ATM Pressure:	1011 mbar

Note: N/A

TestMode	Antenna	Frequency[MHz]	OCB [MHz]	FL[MHz]	FH[MHz]	Limit[MHz]	Verdict
ZIGB	Ant1	2405	2.1229	2403.9199	2406.0428	---	---
ZIGB	Ant1	2440	2.1159	2438.9191	2441.0350	---	---
ZIGB	Ant1	2480	2.1015	2478.9242	2481.0257	---	---

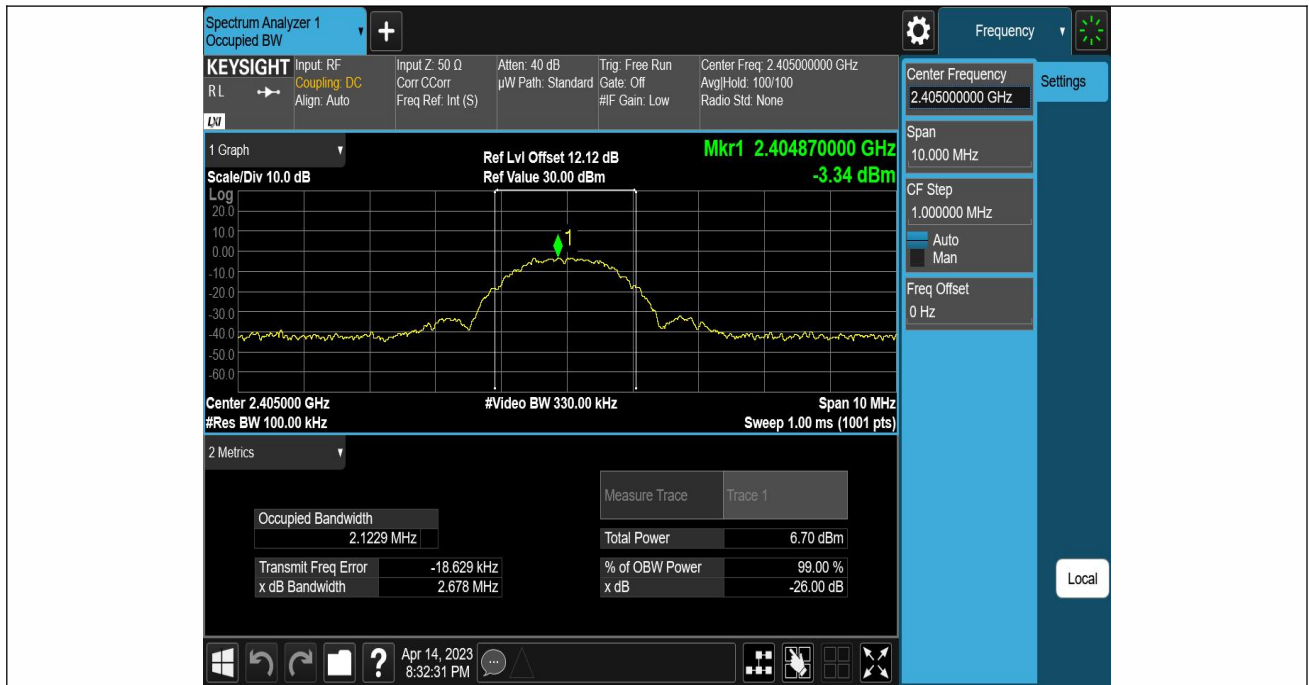

ZIGB-Ant1-2405

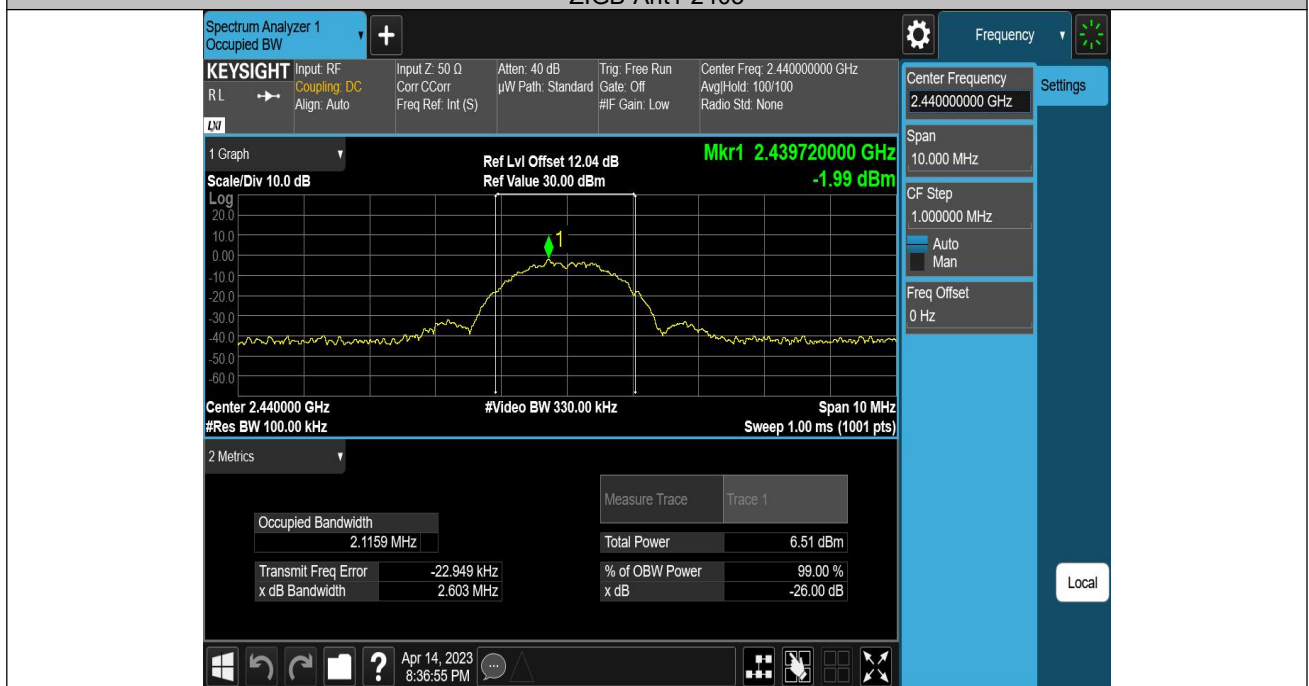

ZIGB-Ant1-2440

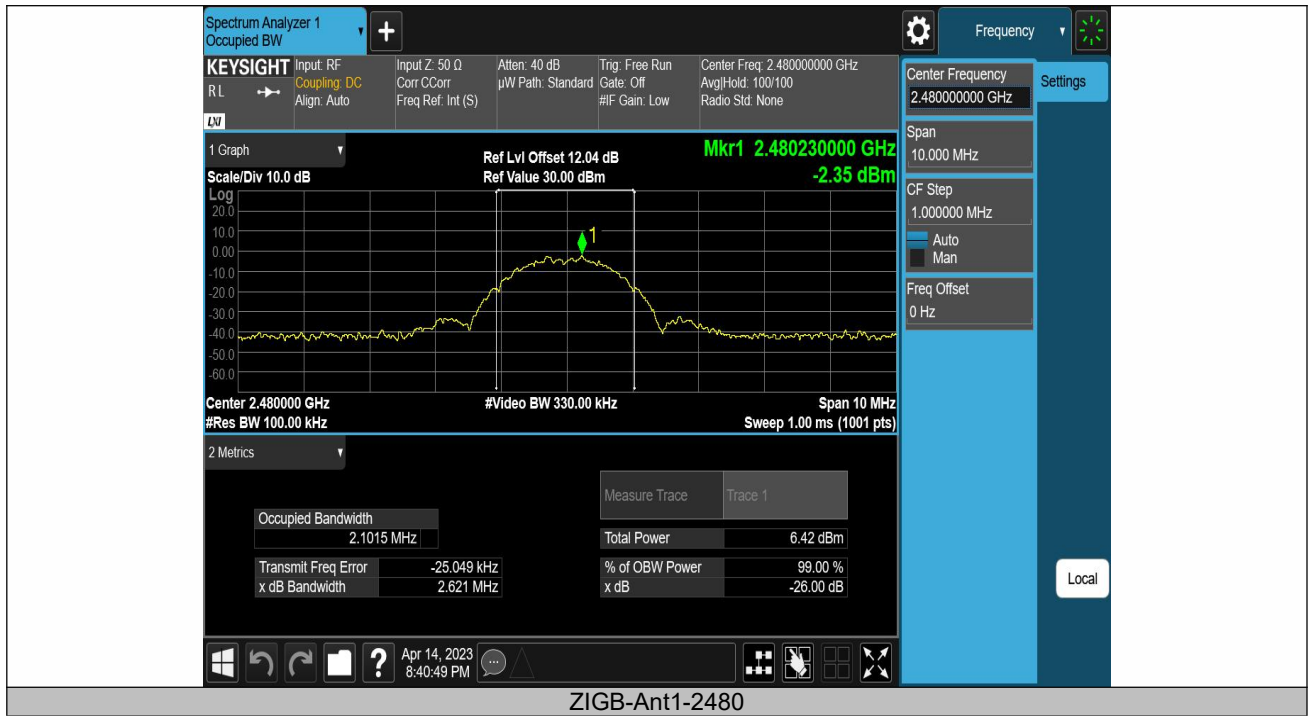

8.3 MAXIMUM PEAK CONDUCTED OUTPUT POWER

8.3.1 Applicable Standard

According to FCC Part 15.247(b)(3) and KDB 558074 DTS 01 Meas. Guidance v04

Conformance Limit

The maximum peak conducted output power of the intentional radiator for systems using digital modulation in the 2400 - 2483.5 MHz bands shall not exceed: 1 Watt (30dBm).

8.3.2 Test Configuration

Test according to clause 7.1 radio frequency test setup 1

8.3.3 Test Procedure

■ According to FCC Part15.247(b)(3)

The maximum peak conducted output power may be measured using a broadband peak RF power meter. The power meter shall have a video bandwidth that is greater than or equal to the DTS bandwidth and shall utilize a fast-responding diode detector.

The testing follows FCC public Notice DA 00-705 Measurement Guidelines.

The RF output of EUT was connected to the power meter by RF cable and attenuator. The path loss was compensated to the results for each measurement.

Set to the maximum output power setting and enable the EUT transmit continuously.

Measure the conducted output power with cable loss and record the results in the test report.

Measure and record the results in the report.

■ According to FCC Part 15.247(b)(4):

Conducted output power limit specified in paragraph (b) of this section is based on the use of antennas with directional gains that do not exceed 6 dBi. If transmitting antennas of directional gain greater than 6 dBi are used, the conducted output power from the intentional radiator shall be reduced below the stated values in paragraphs (b)(3) of this section, as appropriate, by the amount in dB that the directional gain of the antenna exceeds 6 dBi.

Note: If antenna Gain exceeds 6 dBi, then Output power Limit=30-(Gain - 6)

8.3.4 Test Results

Temperature:	26° C
Relative Humidity:	54%
ATM Pressure:	1011 mbar

TestMode	Antenna	Frequency[MHz]	Result[dBm]	Ant Gain[dBi]	E.I.R.P[dBm]	Limit[dBm]	Verdict
ZIGB	Ant1	2405	-9.9	1.75	-8.15	≤30	PASS
ZIGB	Ant1	2440	-9.81	1.75	-8.06	≤30	PASS
ZIGB	Ant1	2480	-10.43	1.75	-8.68	≤30	PASS

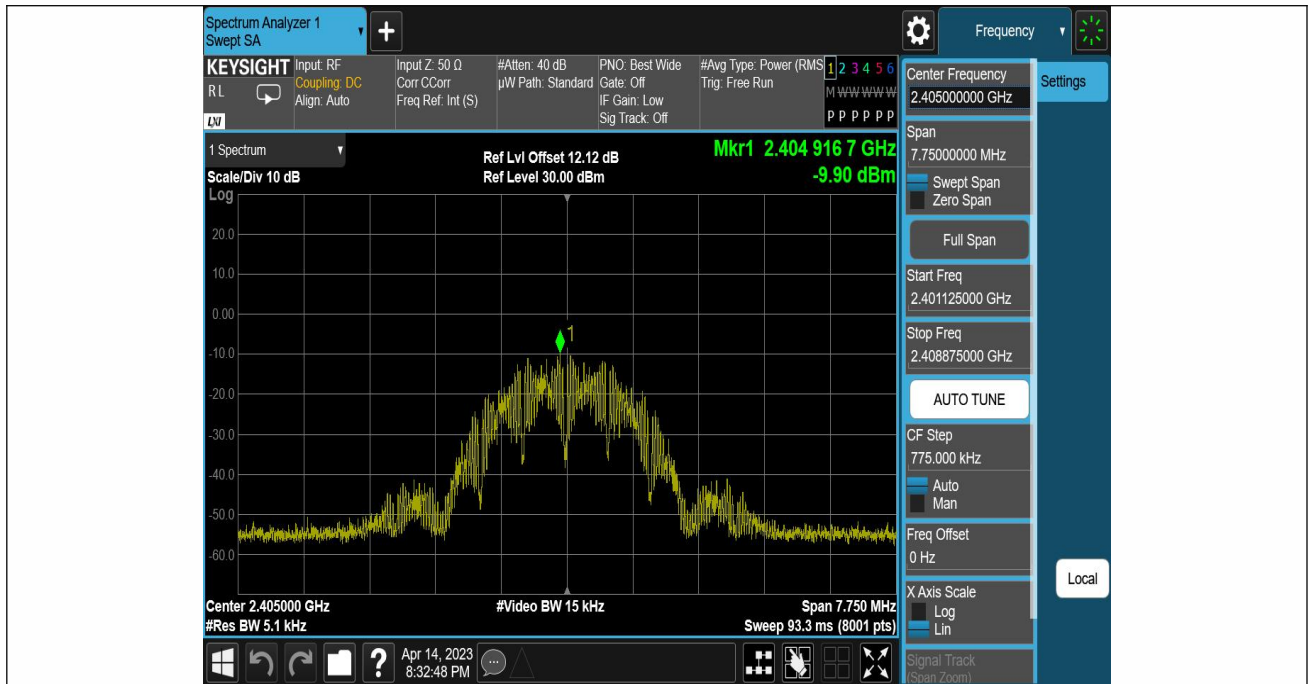

ZIGB-Ant1-2405

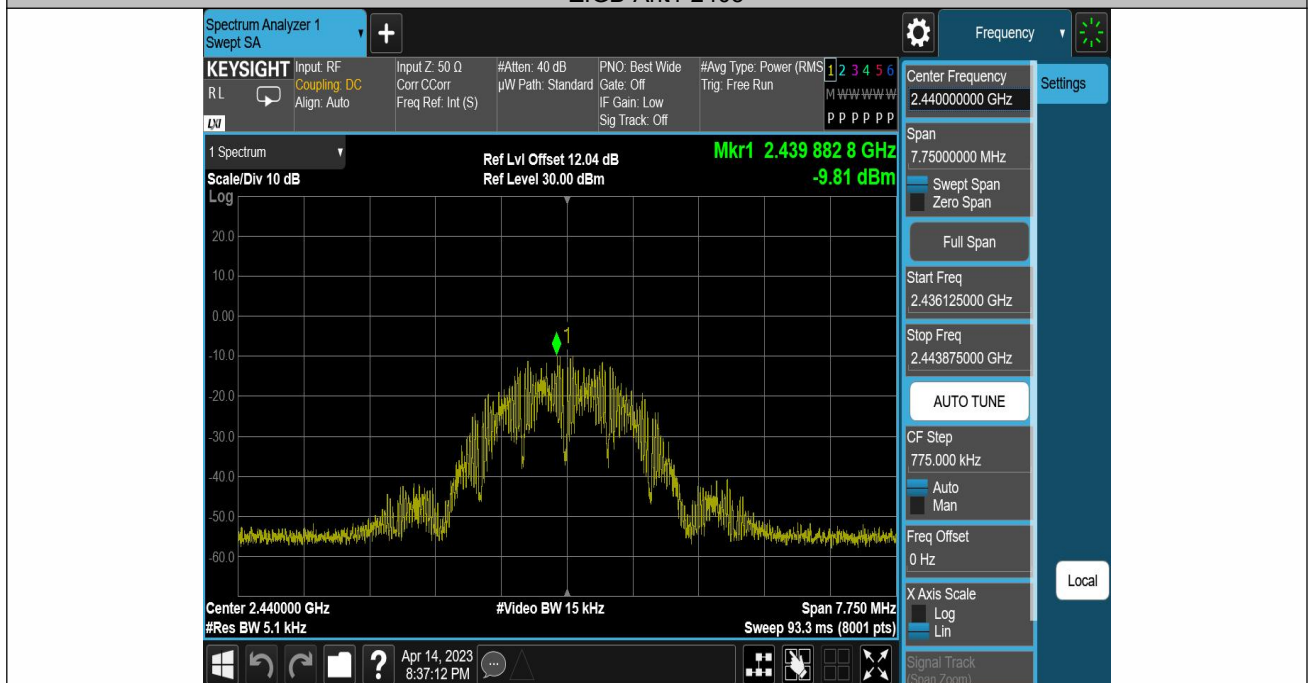

ZIGB-Ant1-2440

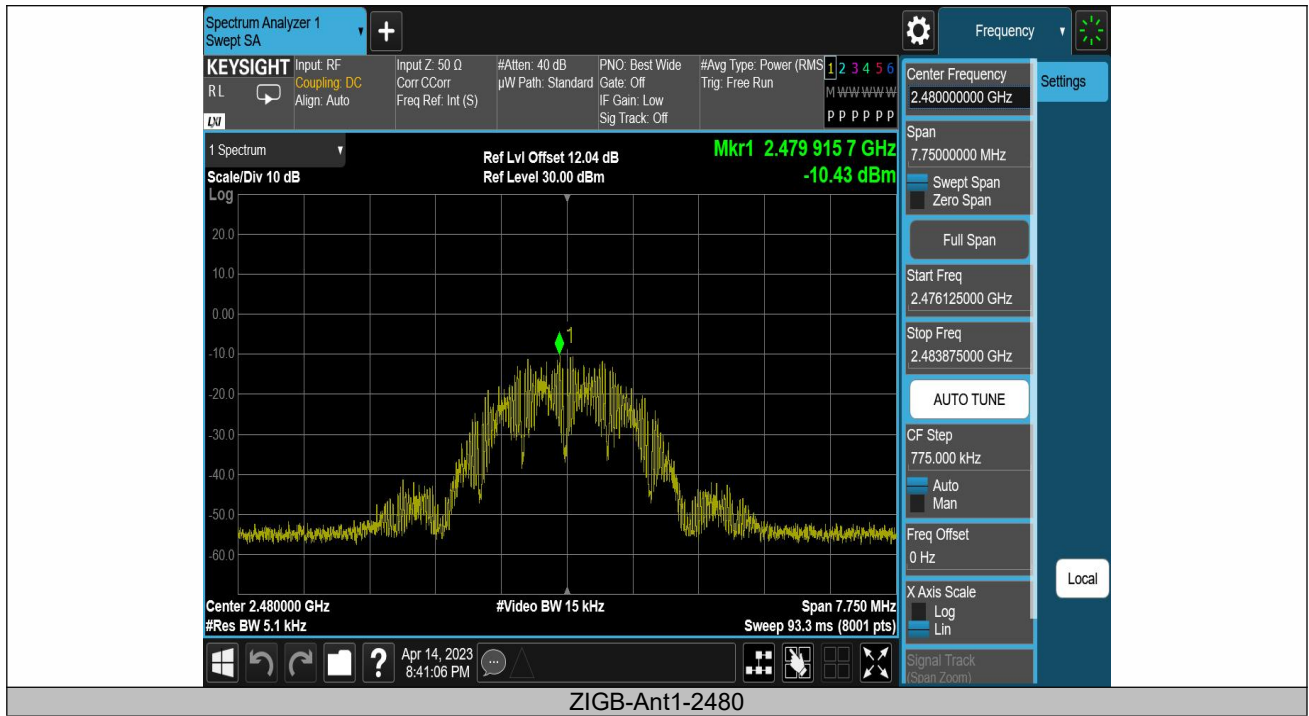

8.4 MAXIMUM POWER SPECTRAL DENSITY

8.4.1 Applicable Standard

According to FCC Part 15.247(e) and KDB 558074 DTS 01 Meas. Guidance v04

8.4.2 Conformance Limit

The transmitter power spectral density conducted from the transmitter to the antenna shall not be greater than 8 dBm in any 3 kHz band during any time interval of continuous transmission.

8.4.3 Test Configuration

Test according to clause 7.1 radio frequency test setup 1

8.4.4 Test Procedure

This procedure shall be used if maximum peak conducted output power was used to demonstrate compliance

The transmitter output (antenna port) was connected to the spectrum analyzer

Set analyzer center frequency to DTS channel center frequency.

Set the span to 1.5 times the DTS bandwidth.

Set the RBW to: 3 kHz

Set the VBW to: 10 kHz.

Set Detector = peak.

Set Sweep time = auto couple.

Set Trace mode = max hold.

Allow trace to fully stabilize.

Use the peak marker function to determine the maximum amplitude level within the RBW.

Note: If antenna Gain exceeds 6 dBi, then PSD Limit=8-(Gain - 6)

8.4.5 Test Results

Temperature:	26° C
Relative Humidity:	54%
ATM Pressure:	1011 mbar

TestMode	Antenna	Frequency[MHz]	Result[dBm/3-100kHz]	Limit[dBm/3kHz]	Verdict
ZIGB	Ant1	2405	-11.23	≤8.00	PASS
ZIGB	Ant1	2440	-11.7	≤8.00	PASS
ZIGB	Ant1	2480	-11.36	≤8.00	PASS



ZIGB-Ant1-2405--4.04-0.00-0.00-0.00

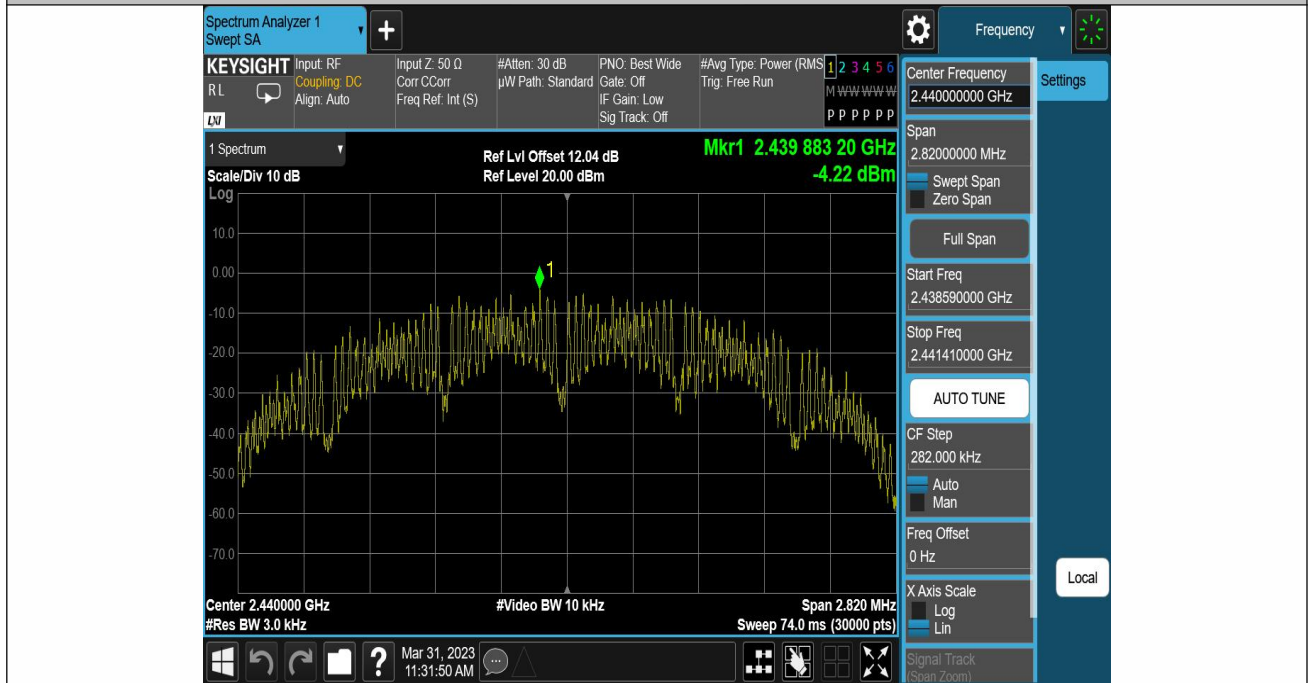

ZIGB-Ant1-2440--4.22-0.00-0.00-0.00

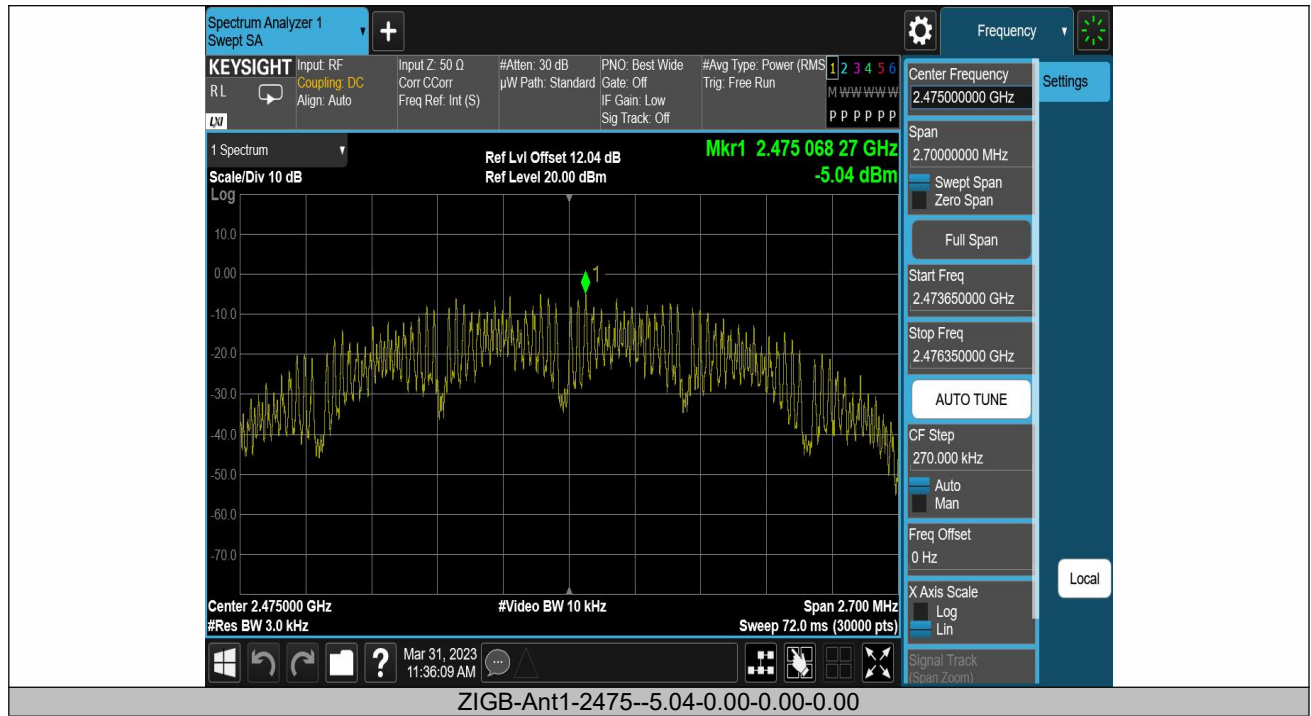

8.5 UNWANTED EMISSIONS IN NON-RESTRICTED FREQUENCY BANDS

8.5.1 Applicable Standard

According to FCC Part 15.247(d) and KDB 558074 DTS 01 Meas. Guidance v04

8.5.2 Conformance Limit

According to FCC Part 15.247(d):

In any 100 kHz bandwidth outside the frequency band in which the spread spectrum or digitally modulated intentional radiator is operating, the radio frequency power that is produced by the intentional radiator shall be at least 20 dB below that in the 100 kHz bandwidth within the band that contains the highest level of the desired power, based on either an RF conducted or a radiated measurement, provided the transmitter demonstrates compliance with the peak conducted power limits. If the transmitter complies with the conducted power limits based on the use of RMS averaging over a time interval, as permitted under paragraph (b)(3) of this section, the attenuation required under this paragraph shall be 30 dB instead of 20 dB.

8.5.3 Test Configuration

Test according to clause 7.1 radio frequency test setup 1

8.5.4 Test Procedure

The transmitter output (antenna port) was connected to the spectrum analyzer

■ Reference level measurement

Establish a reference level by using the following procedure:

Set instrument center frequency to DTS channel center frequency.

Set the span to ≥ 1.5 times the DTS bandwidth.

Set the RBW = 100 kHz.

Set the VBW $\geq 3 \times$ RBW.

Set Detector = peak.

Set Sweep time = auto couple.

Set Trace mode = max hold.

Allow trace to fully stabilize.

Use the peak marker function to determine the maximum PSD level.

Note that the channel found to contain the maximum PSD level can be used to establish the reference level.

■ Emission level measurement

Set the center frequency and span to encompass frequency range to be measured.

Set the RBW = 100 kHz.

Set the VBW = 300 kHz.

Set Detector = peak

Sweep time = auto couple.

Trace mode = max hold.

Allow trace to fully stabilize.

Use the peak marker function to determine the maximum amplitude level.

Ensure that the amplitude of all unwanted emissions outside of the authorized frequency band (excluding restricted frequency bands) are attenuated by at least the minimum requirements. Report the three highest emissions relative to the limit.

8.5.5 Test Results

Temperature:	26° C
Relative Humidity:	54%
ATM Pressure:	1011 mbar

8.5.6 Band edge measurements

TestMode	Antenna	ChName	Frequency[MHz]	RefLevel[dBm]	Result[dBm]	Limit[dBm]	Verdict
ZIGB	Ant1	Low	2405	-2.24	-48.15	≤-22.24	PASS
ZIGB	Ant1	High	2480	-3.01	-47.85	≤-23.01	PASS

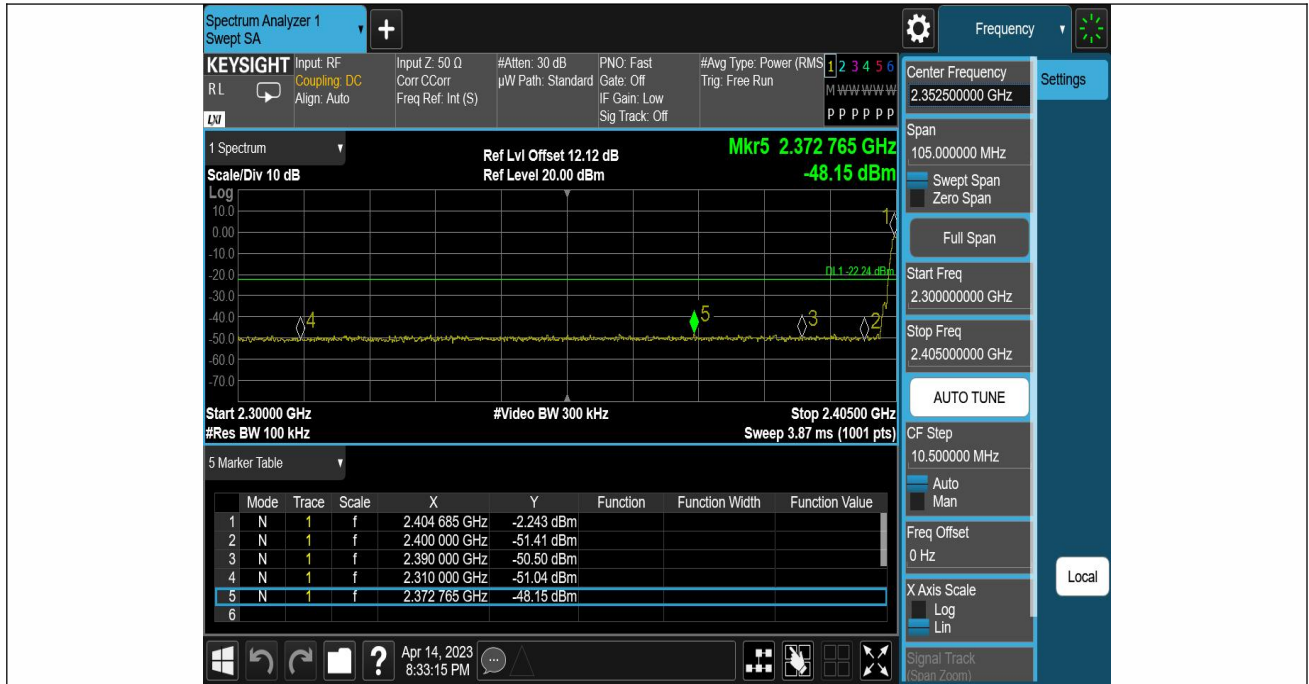

8.5.7 Conducted Spurious Emission

TestMode	Antenna	Frequency[MHz]	FreqRange [MHz]	RefLevel [dBm]	Result[dBm]	Limit[dBm]	Verdict
ZIGB	Ant1	2405	0~Reference	-2.23	-2.23	---	PASS
ZIGB	Ant1	2405	30~1000	-2.23	-59.45	≤-22.23	PASS
ZIGB	Ant1	2405	1000~26500	-2.23	-48.09	≤-22.23	PASS
ZIGB	Ant1	2440	0~Reference	-1.97	-1.97	---	PASS
ZIGB	Ant1	2440	30~1000	-1.97	-59.8	≤-21.97	PASS
ZIGB	Ant1	2440	1000~26500	-1.97	-49.53	≤-21.97	PASS
ZIGB	Ant1	2480	0~Reference	-2.24	-2.24	---	PASS
ZIGB	Ant1	2480	30~1000	-2.24	-59.42	≤-22.24	PASS
ZIGB	Ant1	2480	1000~26500	-2.24	-49.72	≤-22.24	PASS

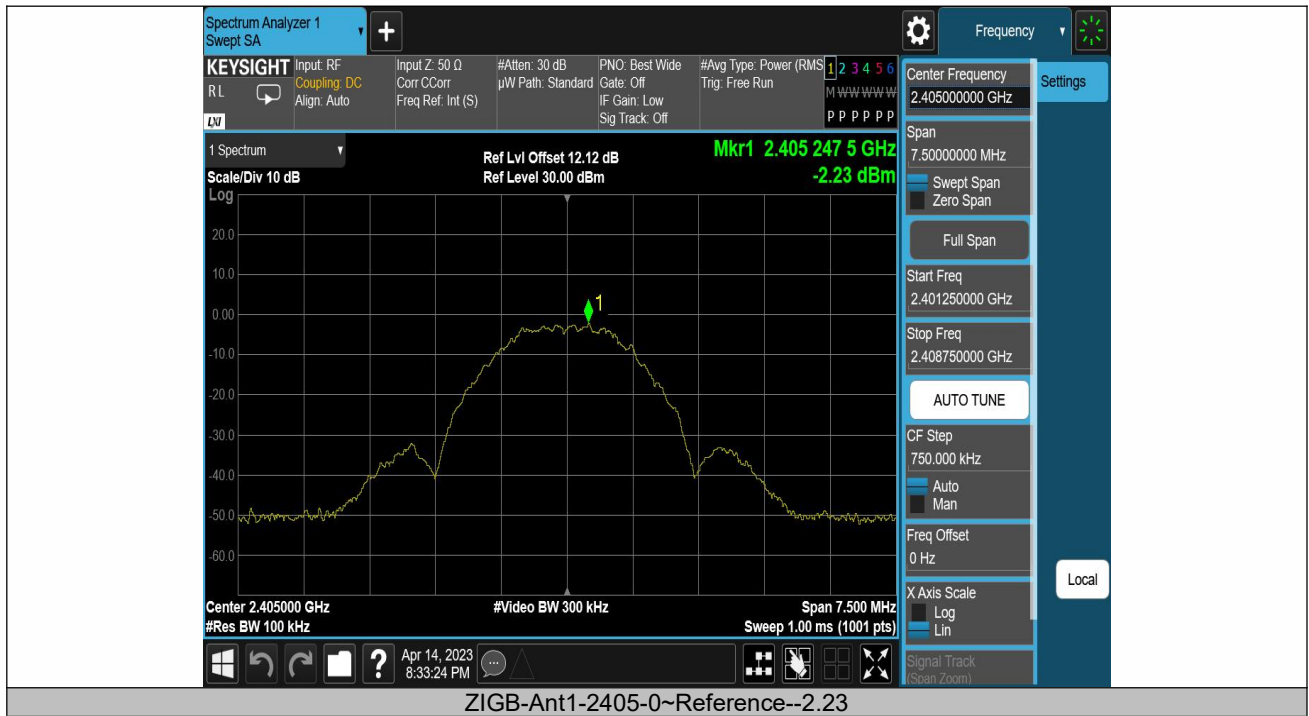

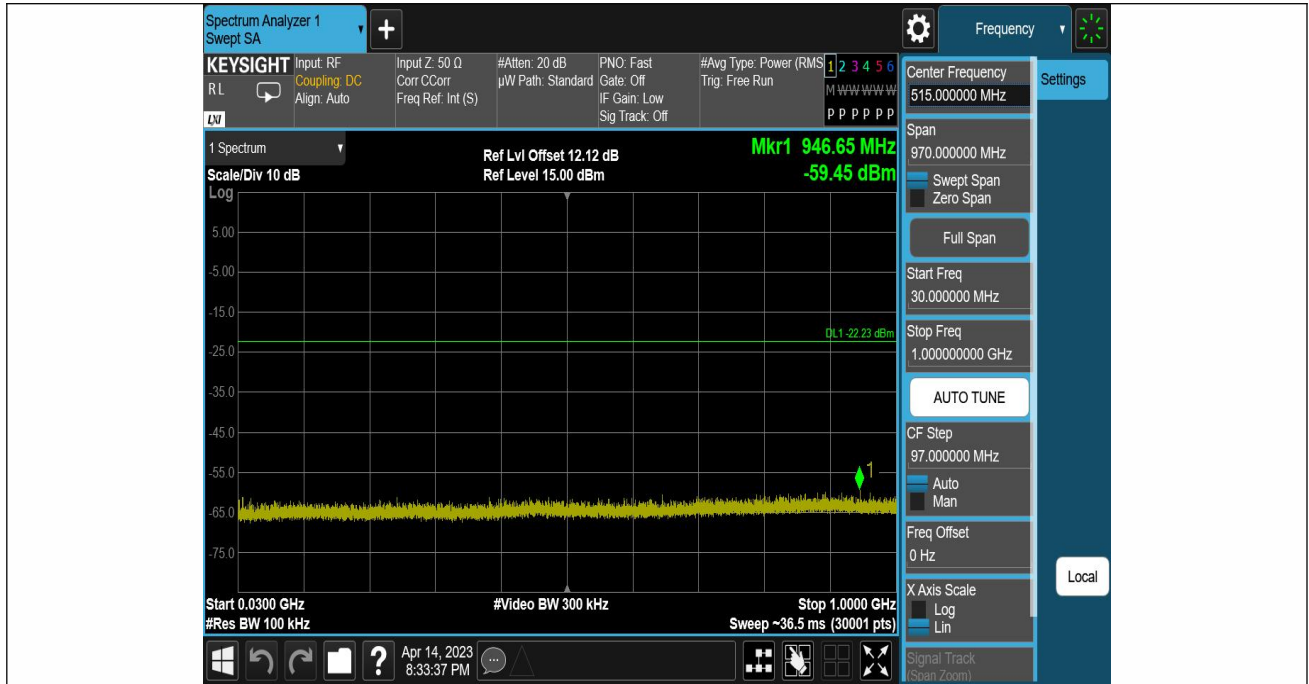

ZIGB-Ant1-2405-30~1000--2.23



ZIGB-Ant1-2405-1000~26500--2.23

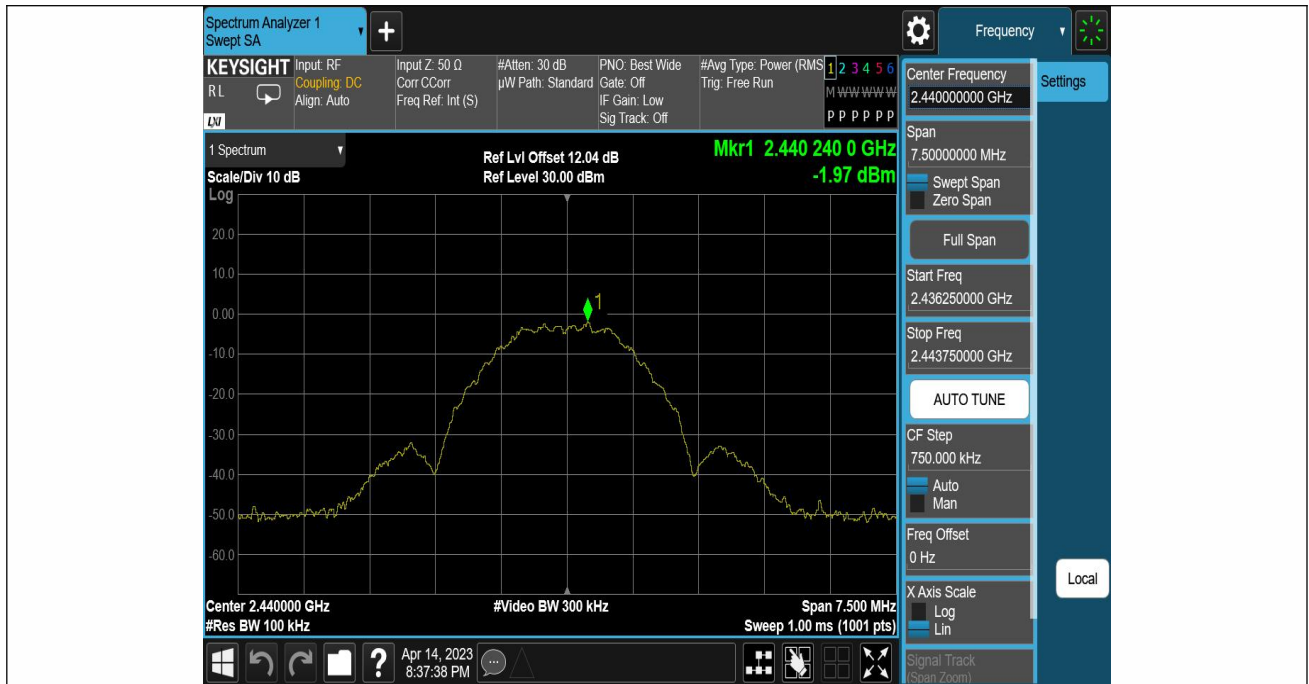

ZIGB-Ant1-2440-0~Reference--1.97

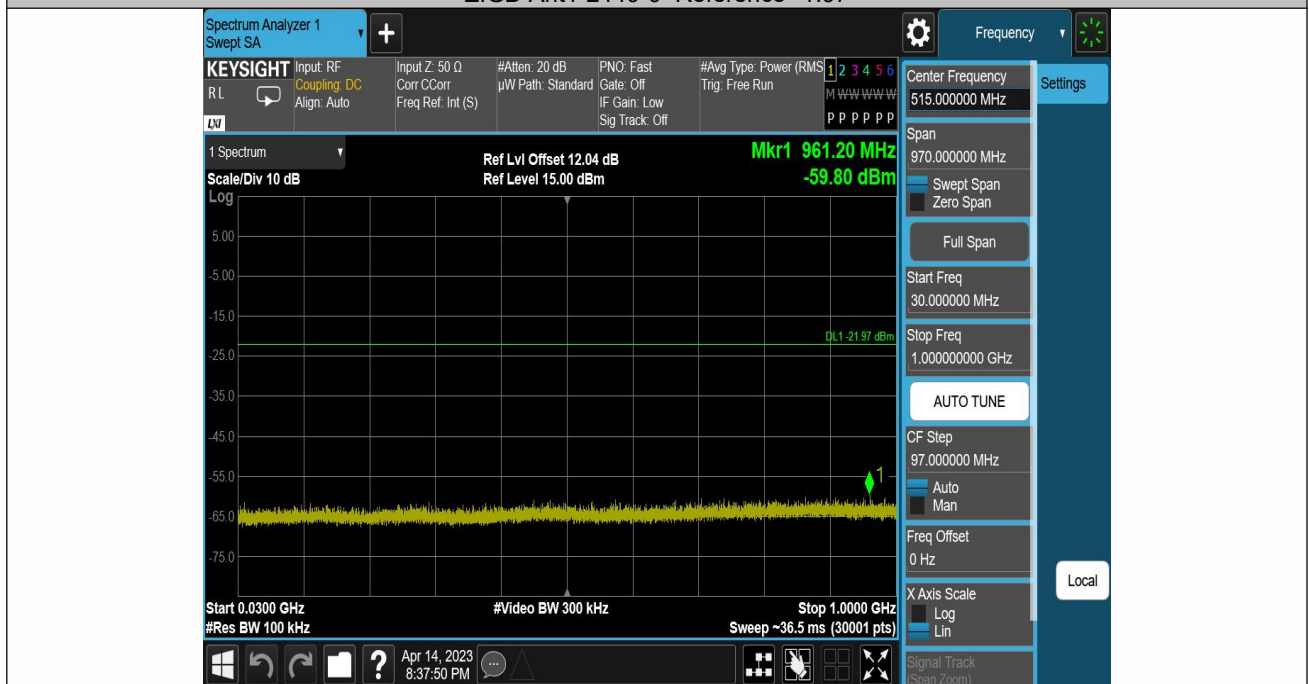

ZIGB-Ant1-2440-30~1000--1.97



ZIGB-Ant1-2440-1000~26500--1.97

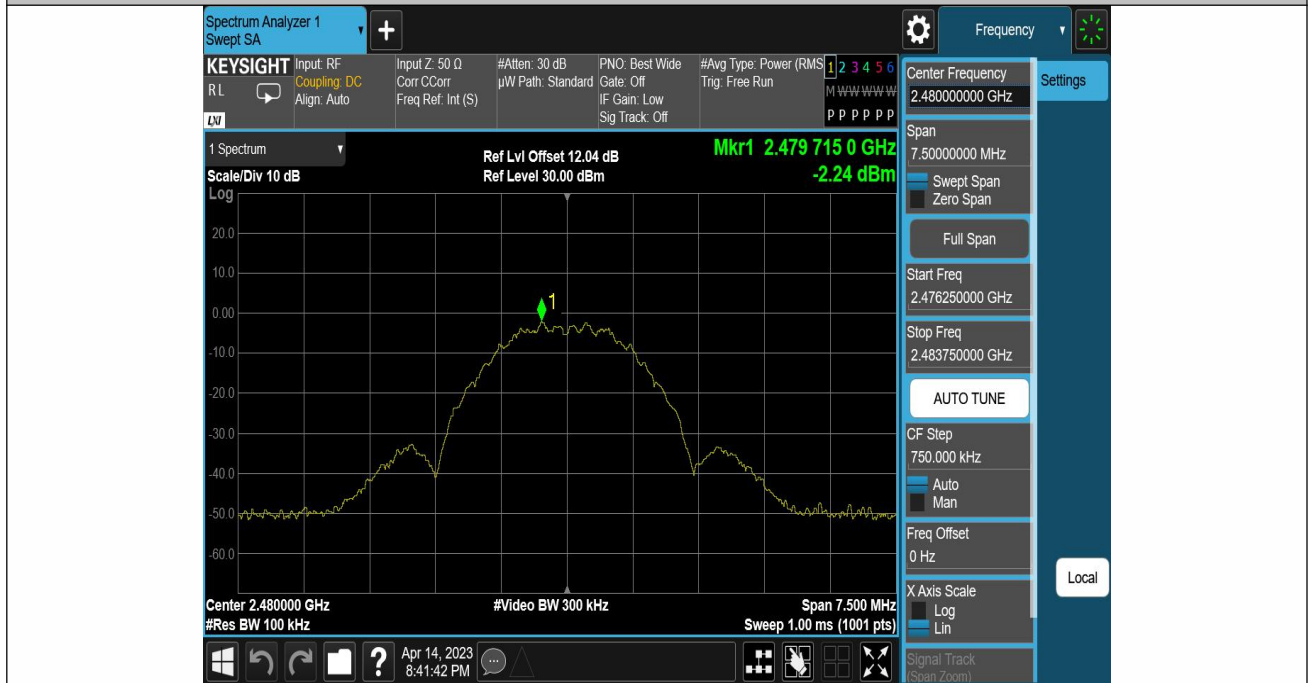

ZIGB-Ant1-2480-0~Reference--2.24

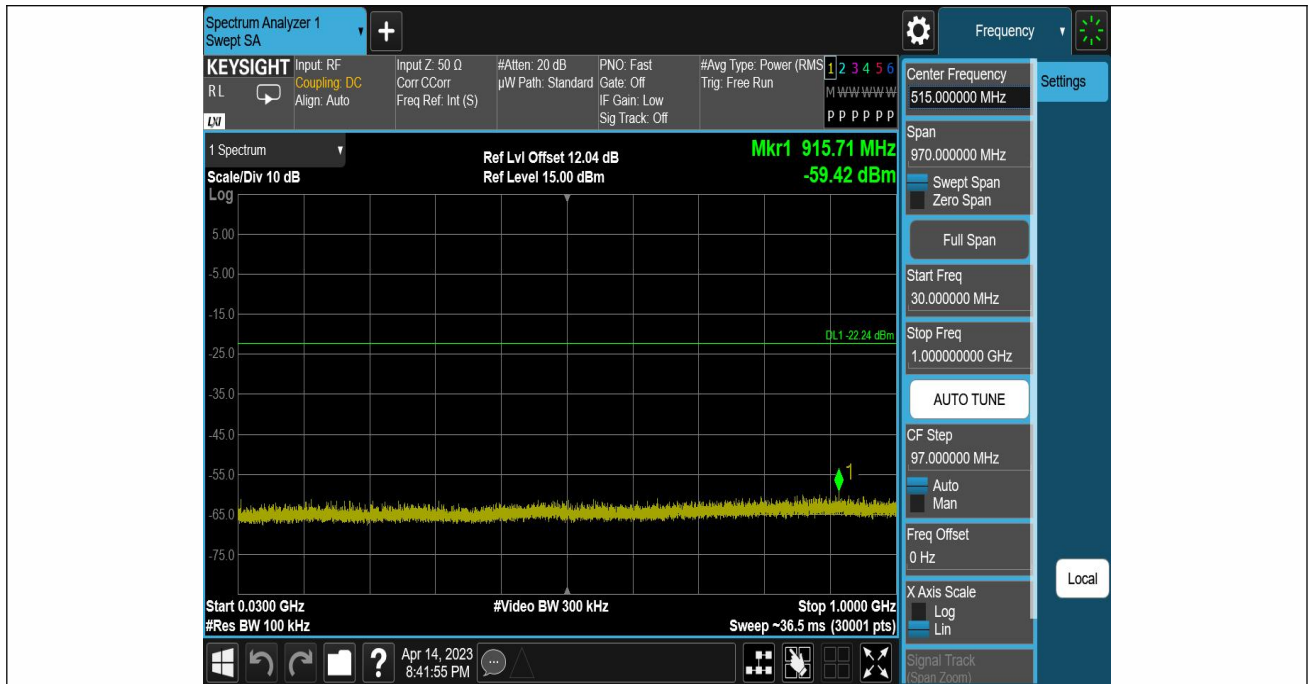

ZIGB-Ant1-2480-30~1000--2.24



ZIGB-Ant1-2480-1000~26500--2.24

8.6 RADIATED SPURIOUS EMISSION

8.6.1 Applicable Standard

According to FCC Part 15.247(d) and 15.209 and KDB 558074 DTS 01 Meas. Guidance v04

8.6.2 Conformance Limit

According to FCC Part 15.247(d): radiated emissions which fall in the restricted bands, as defined in §15.205(a), must also comply with the radiated emission limits specified in §15.209(a) (see §15.205(c)).

According to FCC Part 15.205, Restricted bands

MHz	MHz	MHz	GHz
0.090-0.110	16.42-16.423	399.9-410	4.5-5.15
10.495-0.505	16.69475-16.69525	608-614	5.35-5.46
2.1735-2.1905	16.80425-16.80475	960-1240	7.25-7.75
4.125-4.128	25.5-25.67	1300-1427	8.025-8.5
4.17725-4.17775	37.5-38.25	1435-1626.5	9.0-9.2
4.20725-4.20775	73-74.6	1645.5-1646.5	9.3-9.5
6.215-6.218	74.8-75.2	1660-1710	10.6-12.7
6.26775-6.26825	123-138	2200-2300	14.47-14.5
8.291-8.294	149.9-150.05	2310-2390	15.35-16.2
8.362-8.366	156.52475-156.52525	2483.5-2500	17.7-21.4
8.37625-8.38675	156.7-156.9	2690-2900	22.01-23.12
8.41425-8.41475	162.0125-167.17	3260-3267	23.6-24.0
12.29-12.293	167.72-173.2	3332-3339	31.2-31.8
12.51975-12.52025	240-285	3345.8-3358	36.43-36.5
12.57675-12.57725	322-335.4	3600-4400	(2)
13.36-13.41			

According to FCC Part 15.205, the level of any transmitter spurious emission in Restricted bands shall not exceed the level of the emission specified in the following table

Restricted Frequency(MHz)	Field Strength ($\mu\text{V}/\text{m}$)	Field Strength ($\text{dB}\mu\text{V}/\text{m}$)	Measurement Distance
0.009-0.490	2400/F(KHz)	20 log ($\mu\text{V}/\text{m}$)	300
0.490-1.705	2400/F(KHz)	20 log ($\mu\text{V}/\text{m}$)	30
1.705-30	30	29.5	30
30-88	100	40	3
88-216	150	43.5	3
216-960	200	46	3
Above 960	500	54	3

8.6.3 Test Configuration

Test according to clause 7.2 radio frequency test setup 2

8.6.4 Test Procedure

This test is required for any spurious emission that falls in a Restricted Band, as defined in Section 15.205. It must be performed with the highest gain of each type of antenna proposed for use with the EUT. Use the following spectrum analyzer settings:

For Above 1GHz:

The EUT was placed on a turn table which is 1.5m above ground plane.

Maximum procedure was performed on the highest emissions to ensure EUT compliance.

Span = wide enough to fully capture the emission being measured

RBW = 1 MHz

VBW \geq RBW

Sweep = auto

Detector function = peak

Trace = max hold

For Below 1GHz:

The EUT was placed on a turn table which is 0.8m above ground plane.

Maximum procedure was performed on the highest emissions to ensure EUT compliance.

Span = wide enough to fully capture the emission being measured

RBW = 100 kHz for

VBW \geq RBW

Sweep = auto

Detector function = peak

Trace = max hold

For Below 30MHz:

The EUT was placed on a turn table which is 0.8m above ground plane.

Maximum procedure was performed on the highest emissions to ensure EUT compliance.

Span = wide enough to fully capture the emission being measured

RBW = 9kHz

VBW \geq RBW

Sweep = auto

Detector function = peak

Trace = max hold

For Below 150KHz:

The EUT was placed on a turn table which is 0.8m above ground plane.

Maximum procedure was performed on the highest emissions to ensure EUT compliance.

Span = wide enough to fully capture the emission being measured

RBW = 200Hz

VBW \geq RBW

Sweep = auto

Detector function = peak

Trace = max hold

Follow the guidelines in ANSI C63.10-2013 with respect to maximizing the emission by rotating the EUT, measuring the emission while the EUT is situated in three orthogonal planes (if appropriate), adjusting the measurement antenna height and polarization, etc. A pre-amp and a high pass filter are required for this test, in order to provide the measuring system with sufficient sensitivity. Allow the trace to stabilize. The peak reading of the emission, after being corrected by the antenna factor, cable loss, pre-amp gain, etc., is the peak field strength, which must comply with the limit specified in Section 15.35(b). Submit this data.

Now set the VBW to 10 Hz, while maintaining all of the other instrument settings. This peak level, once corrected, must comply with the limit specified in Section 15.209. If the dwell time per channel of the hopping signal is less than 100 ms, then the reading obtained with the 10 Hz VBW may be further adjusted by a "duty cycle correction factor", derived from $20\log(\text{dwell time}/100 \text{ ms})$, in an effort to demonstrate compliance with the 15.209 limit. Submit this data.

Repeat above procedures until all frequency measured was complete.

8.6.5 Test Results

Temperature:	26° C
Relative Humidity:	54%
ATM Pressure:	1011 mbar

■ Spurious Emission below 30MHz (9KHz to 30MHz)

Test mode: TX Mode

Freq. (MHz)	Ant.Pol. H/V	Emission Level(dBuV/m)		Limit 3m(dBuV/m)		Over(dB)	
		PK	AV	PK	AV	PK	AV
--	--	--	--	--	--	--	--

Note: the amplitude of spurious emission that is attenuated by more than 20dB below the permissible limit has no need to be reported.

Distance extrapolation factor = $40 \log(\text{Specific distance} / \text{test distance})$ (dB);

Limit line = Specific limits(dBuV) + distance extrapolation factor

■ Spurious Emission Above 1GHz (1GHz to 25GHz)

Test mode: O-QPSK Frequency: Channel 1: 2405MHz

Freq. (MHz)	Ant.Pol. H/V	Emission Level(dBuV/m)		Limit 3m(dBuV/m)		Over(dB)	
		PK	AV	PK	AV	PK	AV
7829.86	V	58.7	43.37	74	54	-15.30	-10.63
10156.13	V	60.31	44.94	74	54	-13.69	-9.06
13404	V	58.51	43.04	74	54	-15.49	-10.96
8465.379	H	58.17	42.99	74	54	-15.83	-11.01
9838.311	H	58.95	43.58	74	54	-15.05	-10.42
13520.74	H	58.67	43.46	74	54	-15.33	-10.54

Test mode: O-QPSK Frequency: Channel 8: 2440MHz

Freq. (MHz)	Ant.Pol. H/V	Emission Level(dBuV/m)		Limit 3m(dBuV/m)		Over(dB)	
		PK	AV	PK	AV	PK	AV
7989.892	V	57.6	42.43	74	54	-26.62	-12.28
9952.717	V	58.36	43.08	74	54	-21.57	-14.13
13481.71	V	58.62	43.26	74	54	-17.91	-12.48
8013.02	H	57.58	42.36	74	54	-26.77	-12.05
9838.311	H	58.89	43.7	74	54	-16.66	-11.92
16946	H	59.2	43.91	74	54	-27.06	-17.86

Test mode: O-QPSK Frequency: Channel 1: 2480MHz

Freq. (MHz)	Ant.Pol H/V	Emission Level(dBuV/m)		Limit 3m(dBuV/m)		Over(dB)	
		PK	AV	PK	AV	PK	AV
7497.646	V	58.43	43.22	74	54	-26.62	-12.28
10303.97	V	59.06	43.97	74	54	-21.57	-14.13
13211.68	V	57.97	42.84	74	54	-17.91	-12.48
7807.262	H	58.04	42.96	74	54	-26.77	-12.05
9952.717	H	59.08	43.95	74	54	-16.66	-11.92
13404	H	58.82	43.68	74	54	-27.06	-17.86

- Note:**
- (1) All Readings are Peak Value (VBW=3MHz) and Peak Value (VBW=10Hz).
 - (2) Emission Level= Reading Level+Probe Factor +Cable Loss.
 - (3) Data of measurement within this frequency range shown "--" in the table above means the reading of emissions are attenuated more than 20dB below the permissible limits or the field strength is too small to be measured.



■ Spurious Emission in Restricted Band 2310-2390MHz and 2483.5-2500MHz

Test mode: O-QPSK Frequency: Channel 1: 2405MHz

Frequency (MHz)	Polarity	PK(dBuV/m) (VBW=3MHz)	Limit 3m (dBuV/m)	PK(dBuV/m) (VBW=10Hz)	Limit 3m (dBuV/m)
2386.480	H	44.51	74.00	31.13	54.00
2389.680	V	46.79	74.00	33.43	54.00

Test mode: O-QPSK Frequency: Channel 16: 2480MHz

Frequency (MHz)	Polarity	PK(dBuV/m) (VBW=3MHz)	Limit 3m (dBuV/m)	PK(dBuV/m) (VBW=10Hz)	Limit 3m (dBuV/m)
2483.632	H	47.01	74.00	38.19	54.00
2483.533	V	52.83	74.00	50.25	54.00

- Note:**
- (1) All Readings are Peak Value (VBW=3MHz) and Peak Value (VBW=10Hz).
 - (2) Emission Level= Reading Level+Probe Factor +Cable Loss.
 - (3) Data of measurement within this frequency range shown “ -- ” in the table above means the reading of emissions are attenuated more than 20dB below the permissible limits or the field strength is too small to be measured.

All the modulation modes were tested, the data of the worst mode are described in the following table

Test Model Spurious Emission in Restricted Band 2310-2390MHz
 O-QPSK
 Channel 1: 2405MHz Channel 16: 2480MHz Polarity: H

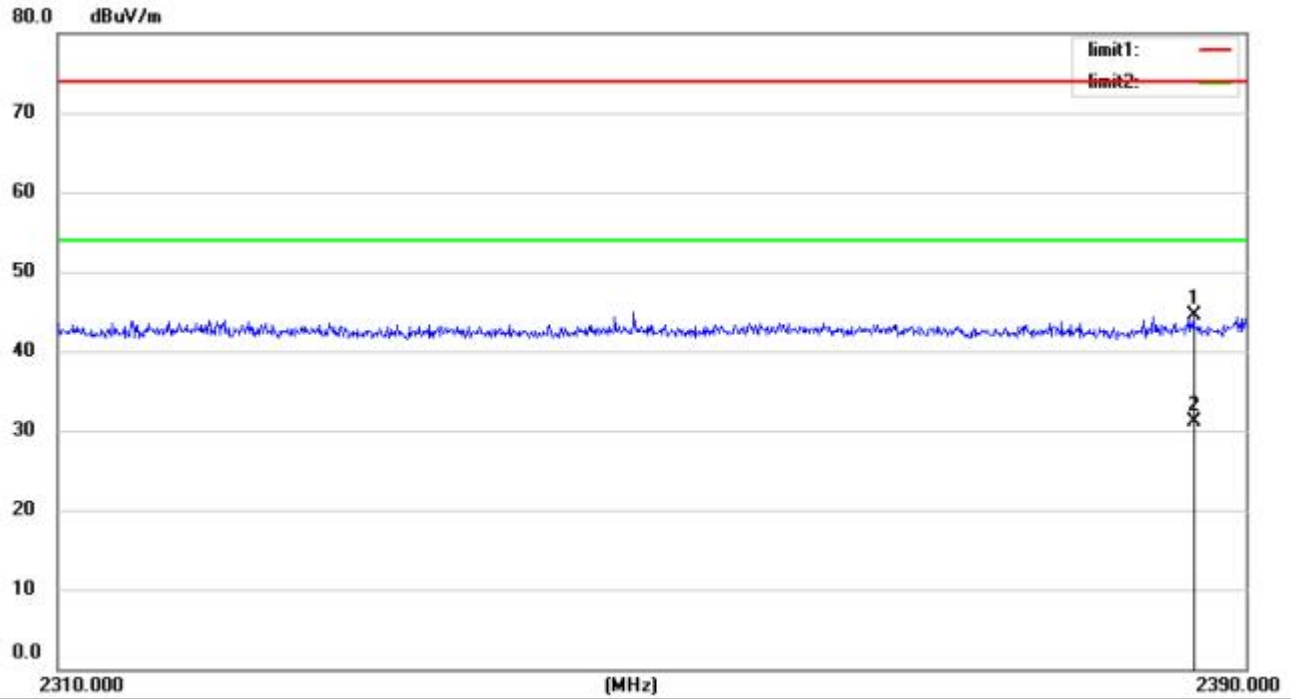

Site Chamber #1 Polarization: **Horizontal** Temperature: 21.5

Test Model Spurious Emission in Restricted Band 2310-2390MHz
 O-QPSK
 Channel 1: 2405MHz Channel 16: 2480MHz Polarity: V

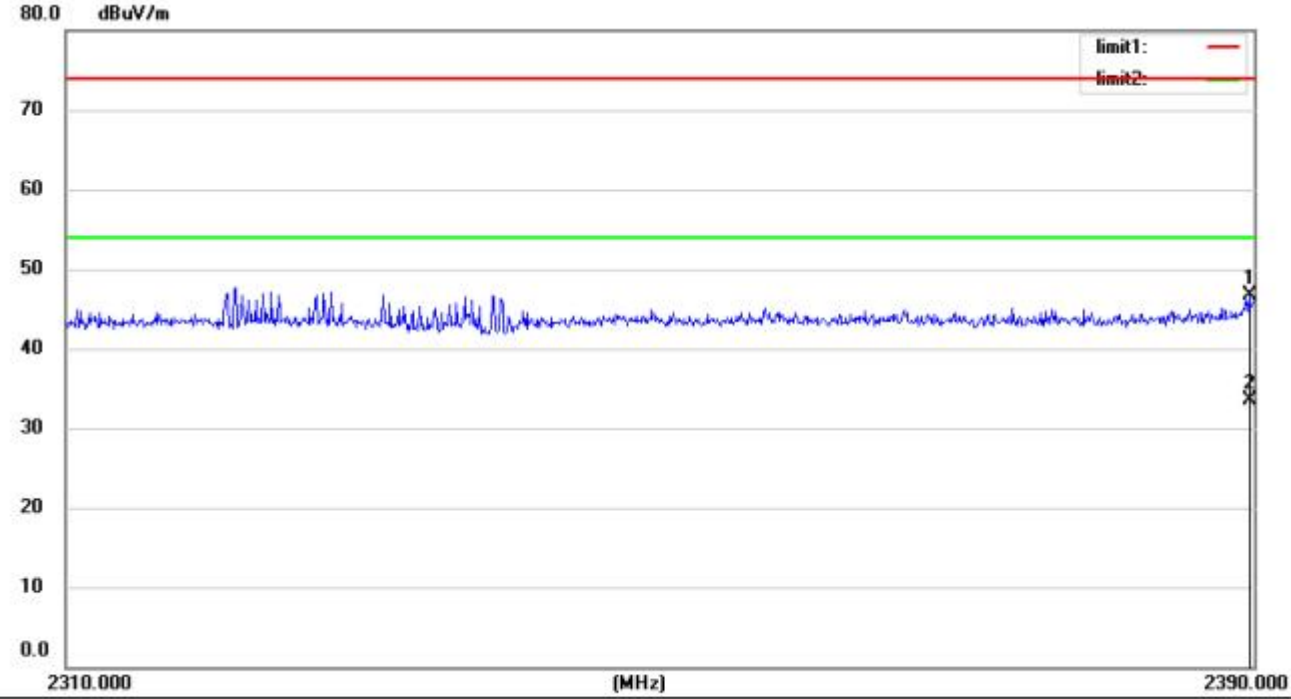

Site Chamber #1 Polarization: **Vertical** Temperature: 21.5

Test Model Spurious Emission in Restricted Band 2483.5-2500MHz
 O-QPSK
 Channel 1: 2405MHz Channel 16: 2480MHz Polarity: H

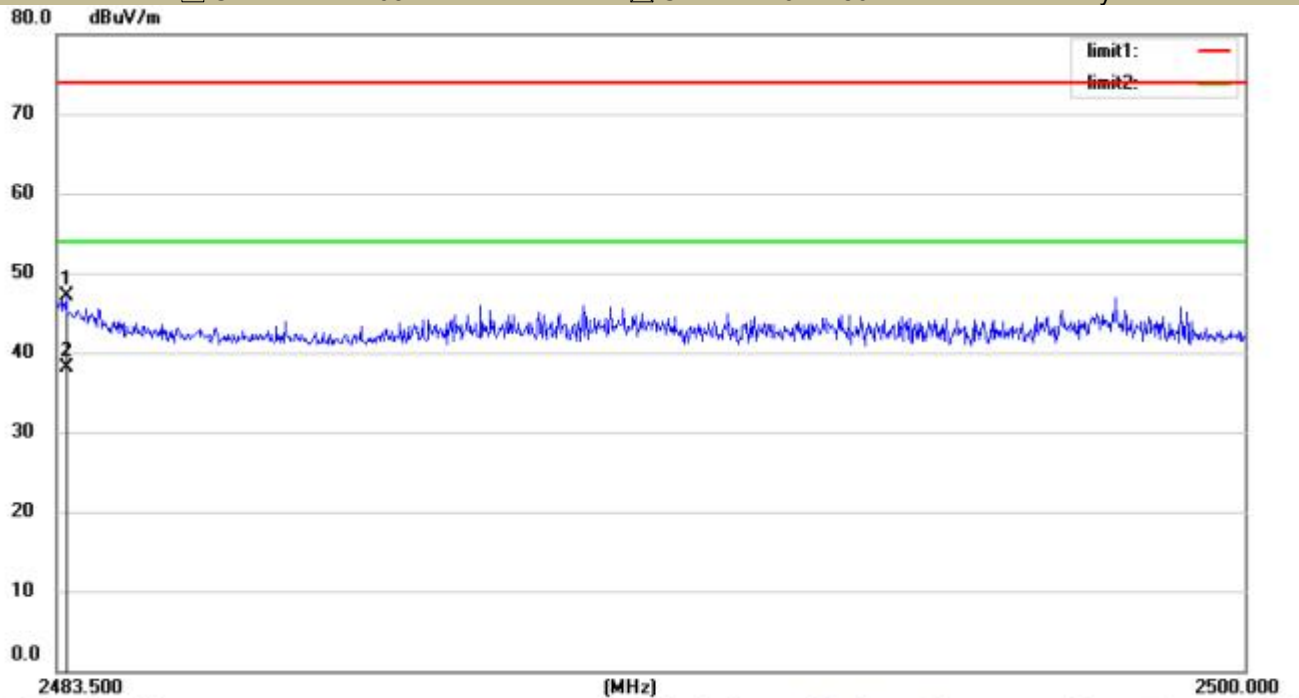

Site Chamber #1

Polarization: **Horizontal**

Temperature: 21.5

Test Model Spurious Emission in Restricted Band 2483.5-2500MHz
 O-QPSK
 Channel 1: 2405MHz Channel 16: 2480MHz Polarity: V

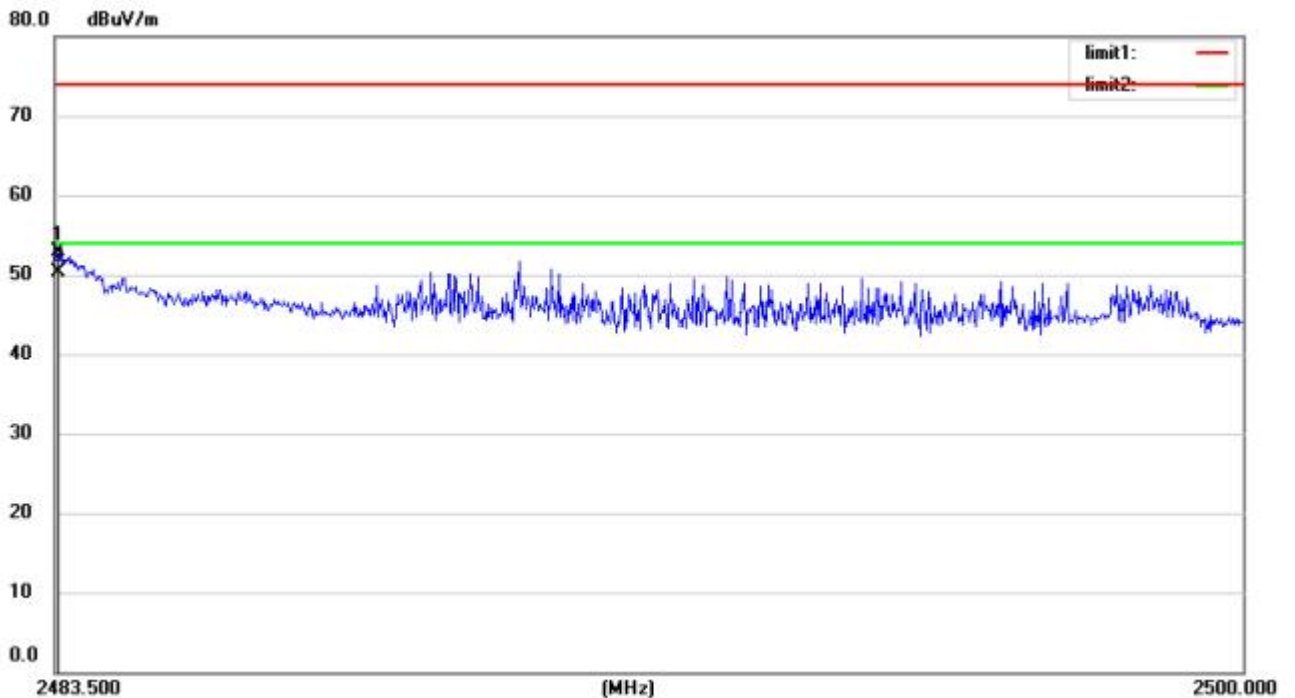

Site Chamber #1

Polarization: **Vertical**

Temperature: 21.5

■ Spurious Emission below 1GHz (30MHz to 1GHz)

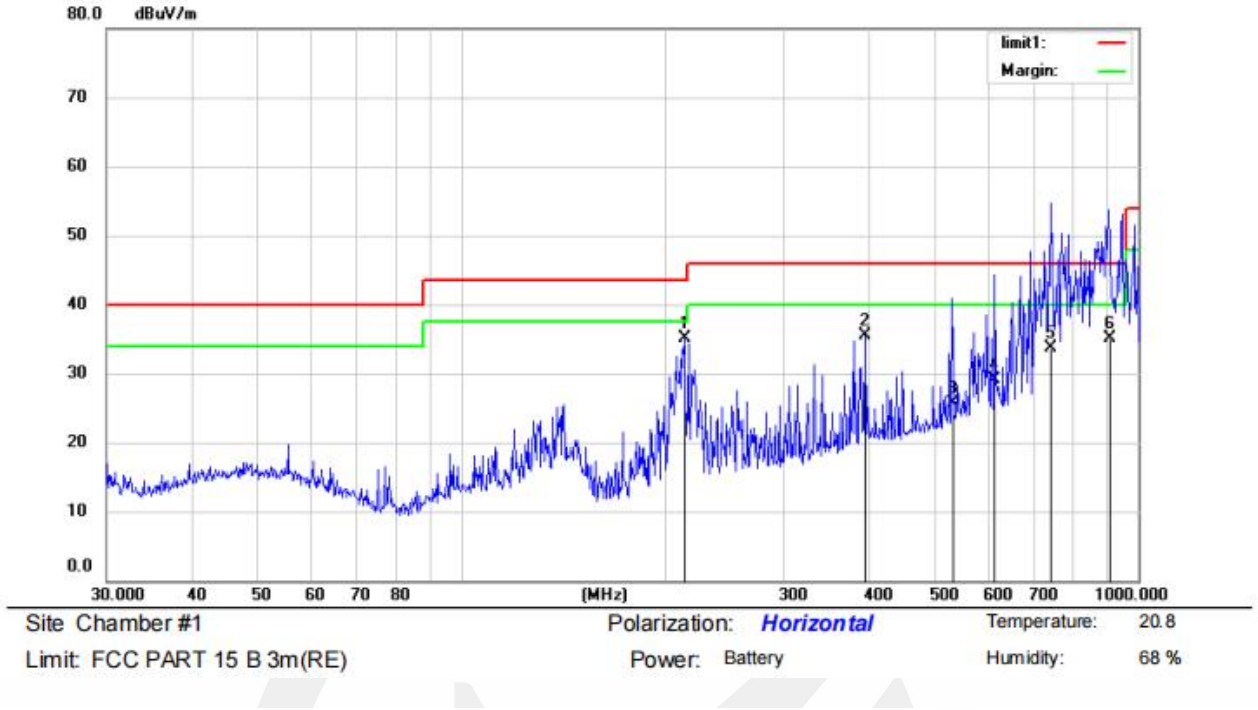

No.	Mk.	Freq. MHz	Reading Level dBuV	Correct Factor dB	Measure- ment dBuV/m	Limit dBuV/m	Over dB	Antenna Height cm	Table Degree	Detector	Comment
1	*	213.7634	50.26	-15.14	35.12	43.50	-8.38			QP	
2		394.8545	45.77	-10.26	35.51	46.00	-10.49			QP	
3		530.1014	33.60	-7.82	25.78	46.00	-20.22			QP	
4		614.2142	34.80	-5.71	29.09	46.00	-16.91			QP	
5		742.2587	38.40	-4.63	33.77	46.00	-12.23			QP	
6		903.3094	36.70	-1.66	35.04	46.00	-10.96			QP	

*:Maximum data x:Over limit !:over margin

Operator: Ccyf

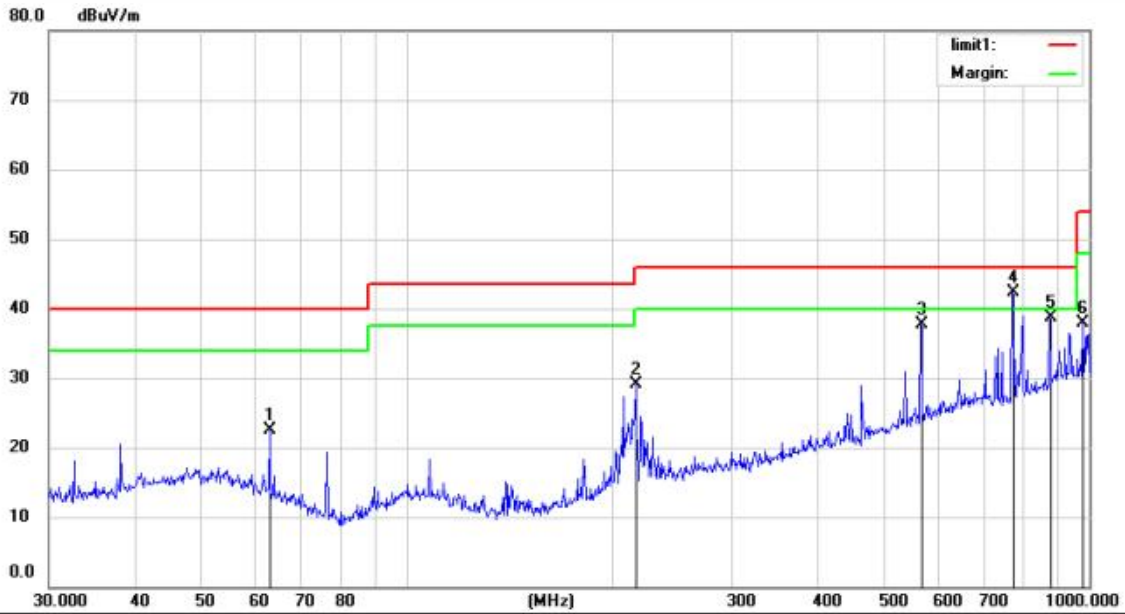

Site Chamber #1 Polarization: **Vertical** Temperature: 20.8
 Limit: FCC PART 15 B 3m(RE) Power: Battery Humidity: 68 %

No.	Mk.	Freq.	Reading Level	Correct Factor	Measurement	Limit	Over	Antenna Height	Table Degree	
		MHz	dBuV	dB	dBuV/m	dBuV/m	dB	cm	degree	Comment
1		63.0916	40.22	-17.75	22.47	40.00	-17.53			
2		216.7828	44.04	-15.03	29.01	46.00	-16.99			
3		566.6223	44.52	-6.87	37.65	46.00	-8.35			
4	*	771.4486	46.62	-4.28	42.34	46.00	-3.66			
5		875.2470	40.90	-2.24	38.66	46.00	-7.34			
6		979.1804	38.44	-0.63	37.81	54.00	-16.19			

*:Maximum data x:Over limit !:over margin

Operator: Ccyf

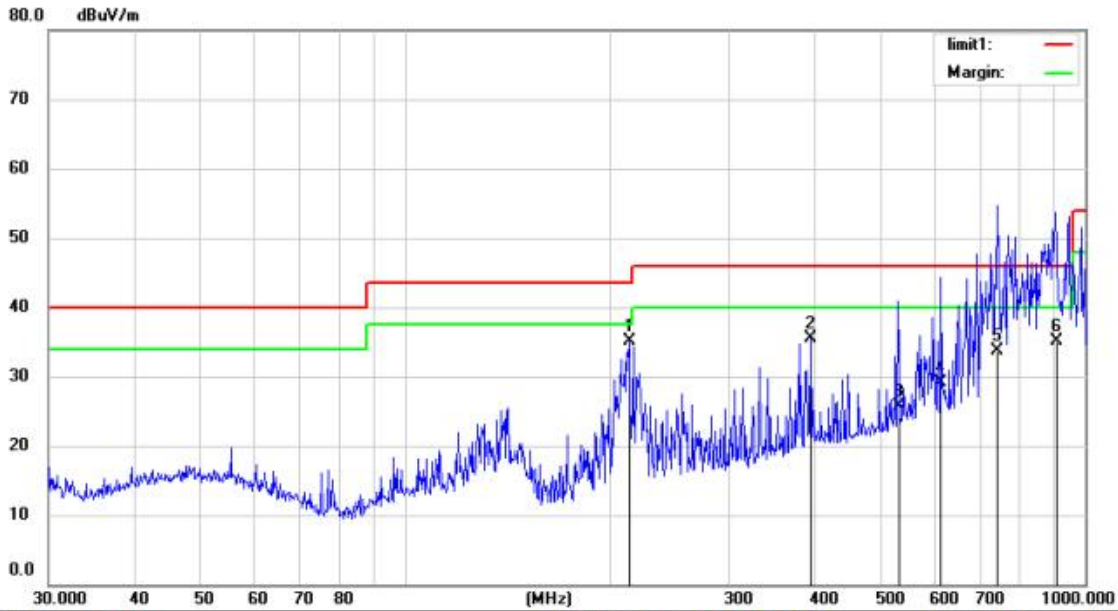

Site Chamber #1 Polarization: **Horizontal** Temperature: 20.8
 Limit: FCC PART 15 B 3m(RE) Power: Battery Humidity: 68 %

No.	Mk.	Freq.	Reading Level	Correct Factor	Measurement	Limit	Over	Antenna Height	Table Degree	
		MHz	dBuV	dB	dBuV/m	dBuV/m	dB	cm	degree	Comment
1	*	213.7634	50.26	-15.14	35.12	43.50	-8.38	QP		
2		394.8545	45.77	-10.26	35.51	46.00	-10.49	QP		
3		530.1014	33.60	-7.82	25.78	46.00	-20.22	QP		
4		614.2142	34.80	-5.71	29.09	46.00	-16.91	QP		
5		742.2587	38.40	-4.63	33.77	46.00	-12.23	QP		
6		903.3094	36.70	-1.66	35.04	46.00	-10.96	QP		

*:Maximum data x:Over limit !:over margin

Operator: Ccyf

8.7 CONDUCTED EMISSIONS TEST

Applicable Standard

According to FCC Part 15.207(a)

Conformance Limit

Frequency(MHz)	Conducted Emission Limit	
	Quasi-peak	Average
0.15-0.5	66-56	56-46
0.5-5.0	56	46
5.0-30.0	60	50

Note: 1. The lower limit shall apply at the transition frequencies

2. The limit decreases in line with the logarithm of the frequency in the range of 0.15 to 0.50MHz.

Test Configuration

Test according to clause 7.3 conducted emission test setup

Test Procedure

The EUT was placed on a table which is 0.8m above ground plane.
Maximum procedure was performed on the highest emissions to ensure EUT compliance.
Repeat above procedures until all frequency measured were complete.

Test Results

Pass

The 120V &240V voltage have been tested, and the worst result recorded was report as below:

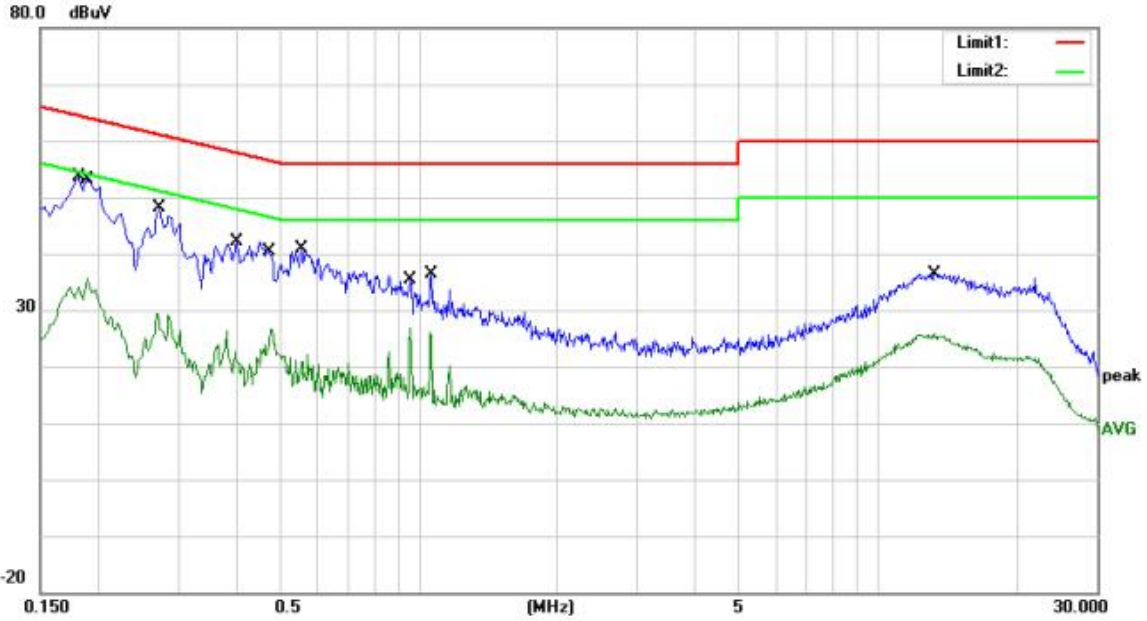

Site site #1 Phase: **L1** Temperature: 24.2
 Limit: (CE)FCC PART 15 B_QP Power: AC 120V/60Hz Humidity: 54 %

No.	Mk.	Freq.	Reading Level	Correct Factor	Measurement	Limit	Over	Detector	Comment
		MHz	dBuV	dB	dBuV	dBuV	dB		
1	*	0.1820	43.14	10.49	53.63	64.39	-10.76	QP	
2		0.1900	25.07	10.49	35.56	54.04	-18.48	AVG	
3		0.2700	19.06	10.39	29.45	51.12	-21.67	AVG	
4		0.2740	37.72	10.39	48.11	61.00	-12.89	QP	
5		0.4020	31.96	10.24	42.20	57.81	-15.61	QP	
6		0.4780	16.57	10.16	26.73	46.37	-19.64	AVG	
7		0.5580	30.85	10.13	40.98	56.00	-15.02	QP	
8		0.9620	16.67	10.12	26.79	46.00	-19.21	AVG	
9		1.0620	15.93	10.12	26.05	46.00	-19.95	AVG	
10		1.0660	26.18	10.12	36.30	56.00	-19.70	QP	
11		13.2940	26.44	10.04	36.48	60.00	-23.52	QP	
12		13.2940	15.89	10.04	25.93	50.00	-24.07	AVG	

*:Maximum data x:Over limit !:over margin Comment: Factor build in receiver. Operator:

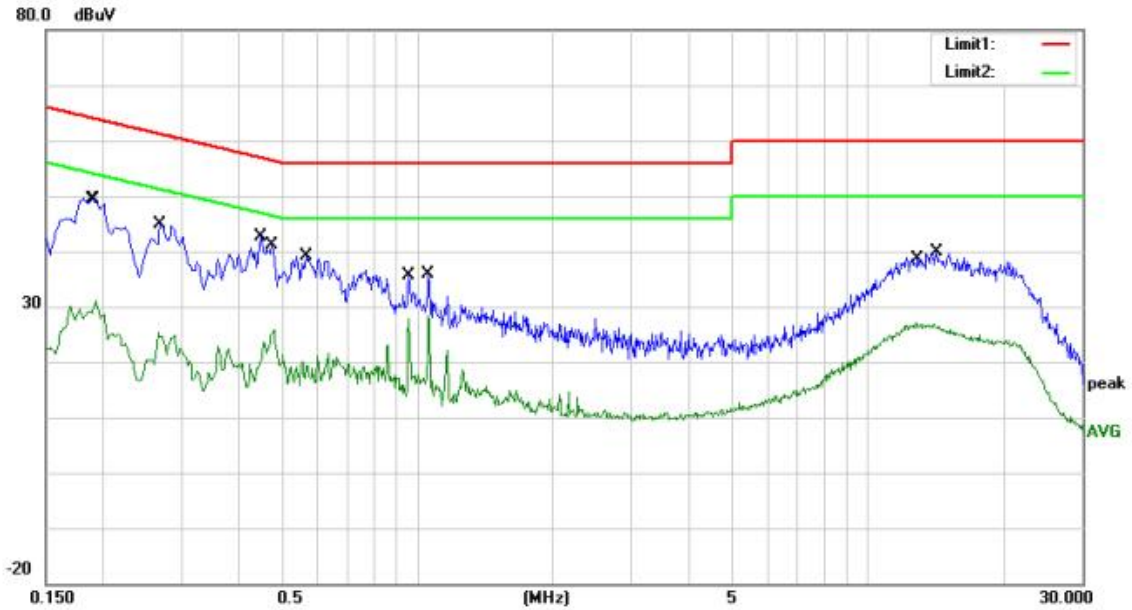

Site site #1 Phase: **N** Temperature: 24.2
 Limit (CE)FCC PART 15 B_QP Power: AC 120V/60Hz Humidity: 54 %

No.	Mk.	Freq.	Reading Level	Correct Factor	Measurement	Limit	Over	Detector	Comment
		MHz	dBuV	dB	dBuV	dBuV	dB		
1		0.1900	38.89	10.49	49.38	64.04	-14.66	QP	
2		0.1940	20.68	10.48	31.16	53.86	-22.70	AVG	
3		0.2660	15.05	10.40	25.45	51.24	-25.79	AVG	
4		0.2700	34.51	10.39	44.90	61.12	-16.22	QP	
5	*	0.4500	32.38	10.19	42.57	56.88	-14.31	QP	
6		0.4820	15.67	10.15	25.82	46.30	-20.48	AVG	
7		0.5700	28.91	10.13	39.04	56.00	-16.96	QP	
8		0.9620	17.72	10.12	27.84	46.00	-18.16	AVG	
9		1.0620	25.65	10.12	35.77	56.00	-20.23	QP	
10		1.0620	18.17	10.12	28.29	46.00	-17.71	AVG	
11		12.8140	16.98	10.04	27.02	50.00	-22.98	AVG	
12		14.2460	29.78	10.04	39.82	60.00	-20.18	QP	

*:Maximum data x:Over limit !:over margin Comment: Factor build in receiver. Operator:

8.8 ANTENNA APPLICATION

Antenna Requirement

Standard	Requirement
FCC CRF Part 15.203	An intentional radiator shall be designed to ensure that no antenna other than that furnished by the responsible party shall be used with the device. The use of a permanently attached antenna or of an antenna that uses a unique coupling to the intentional radiator shall be considered sufficient to comply with the provisions of this section. The manufacturer may design the unit so that a broken antenna can be replaced by the user, but the use of a standard antenna jack or electrical connector is prohibited. This requirement does not apply to carrier current devices or to devices operated under the provisions of §15.211, §15.213, §15.217, §15.219, or §15.221. Further, this requirement does not apply to intentional radiators that must be professionally installed, such as perimeter protection systems and some field disturbance sensors, or to other intentional radiators which, in accordance with §15.31(d), must be measured at the installation site. However, the installer shall be responsible for ensuring that the proper antenna is employed so that the limits in this part are not exceeded.

For intentional device, according to FCC 47 CFR Section 15.203, an intentional radiator shall be designed to ensure that no antenna other than that furnished by the responsible party shall be used with the device. And according to FCC 47 CFR Section 15.247 (b), if transmitting antennas of directional gain greater than 6dBi are used, the power shall be reduced by the amount in dB that the directional gain of the antenna exceeds 6dBi.

Result

PASS.

The EUT has 1 antenna: a Internal Antenna for ZigBee, the gain is 1.75 dBi;

- Note:
- Antenna use a permanently attached antenna which is not replaceable.
 - Not using a standard antenna jack or electrical connector for antenna replacement
 - The antenna has to be professionally installed (please provide method of installation)

which in accordance to section 15.203, please refer to the internal photos.

Detail of factor for radiated emission

Frequency(MHz)	Ant F(dB)	Cab L(dB)	Preamp(dB)	Correct Factor(dB)
0.009	20.6	0.03	\	20.63
0.15	20.7	0.1	\	20.8
1	20.9	0.15	\	21.05
10	20.1	0.28	\	20.38
30	18.8	0.45	\	19.25
30	11.7	0.62	27.9	-15.58
100	12.5	1.02	27.8	-14.28
300	12.9	1.91	27.5	-12.69
600	19.2	2.92	27	-4.88
800	21.1	3.54	26.6	-1.96
1000	22.3	4.17	26.2	0.27
1000	25.6	1.76	41.4	-14.04
3000	28.9	3.27	43.2	-11.03
5000	31.1	4.2	44.6	-9.3
8000	36.2	5.95	44.7	-2.55
10000	38.4	6.3	43.9	0.8
12000	38.5	7.14	42.3	3.34
15000	40.2	8.15	41.4	6.95
18000	45.4	9.02	41.3	13.12
18000	37.9	1.81	47.9	-8.19
21000	37.9	1.95	48.7	-8.85
25000	39.3	2.01	42.8	-1.49
28000	39.6	2.16	46.0	-4.24
31000	41.2	2.24	44.5	-1.06
34000	41.5	2.29	46.6	-2.81
37000	43.8	2.30	46.4	-0.3
40000	43.2	2.50	42.2	3.5

----- END OF REPORT -----