

Test Report

Verified code: 060664

Report No.: E20230828994601-5

Customer: Lumi United Technology Co., Ltd

Address: B1, Chongwen Park, Nanshan iPark, Liuxian Avenue, Taoyuan Residential District,
Nanshan District, Shenzhen, China

Sample Name: Motion and Light Sensor P2

Sample Model: ML-S03D

Receive Sample Date: Aug.28,2023

Test Date: Aug.30,2023 ~ Sep.05,2023

Reference Document: 47 CFR FCC Part 15 Subpart C
RADIO FREQUENCY DEVICES:Subpart C—Intentional Radiators

Test Result: Pass

Prepared by: Chen Xiacong
Chen Xiacong

Reviewed by: Jiang Tao
Jiang Tao

Approved by: Xiao Liang
Xiao Liang

GRG METROLOGY & TEST GROUP CO., LTD.

Issued Date: 2023-11-21

GRG METROLOGY & TEST GROUP CO., LTD.

Address: No.163,Pingyun Road, West of Huangpu Avenue, Guangzhou, Guangdong, China
Tel: (+86) 400-602-0999 FAX: (+86) 020-38698685 Web: <http://www.grgtest.com>



Statement

1. The report is invalid without "special seal for inspection and testing"; some copies are invalid; The report is invalid if it is altered or missing; The report is invalid without the signature of the person who prepared, reviewed and approved it.
2. The sample information is provided by the client and responsible for its authenticity; The content of the report is only valid for the samples sent this time.
3. When there are reports in both Chinese and English, the Chinese version will prevail when the language problems are inconsistent.
4. If there is any objection concerning the report, please inform us within 15 days from the date of receiving the report.
5. Without the agreement of the laboratory, the client is not authorized to use the test results for unapproved propaganda.

----- **The following blanks** -----

TABLE OF CONTENTS

1.	TEST RESULT SUMMARY	6
2.	GENERAL DESCRIPTION OF EUT	7
2.1	APPLICANT	7
2.2	MANUFACTURER	7
2.3	BASIC DESCRIPTION OF EQUIPMENT UNDER TEST	7
2.4	CHANNEL LIST	8
2.5	TEST OPERATION MODE	8
2.6	LOCAL SUPPORTIVE	8
2.7	CONFIGURATION OF SYSTEM UNDER TEST	8
2.8	DUTY CYCLE	9
3.	LABORATORY	10
4.	ACCREDITATIONS	10
5.	MEASUREMENT UNCERTAINTY	11
6.	LIST OF USED TEST EQUIPMENT AT GRGT	12
7.	RADIATED SPURIOUS EMISSIONS	13
7.1	LIMITS	13
7.2	TEST PROCEDURES	13
7.3	TEST SETUP	16
7.4	DATA SAMPLE	18
7.5	TEST RESULTS	19
8.	6DB BANDWIDTH	29
8.1	LIMITS	29
8.2	TEST PROCEDURES	29
8.3	TEST SETUP	29
8.4	TEST RESULTS	29
9.	MAXIMUM PEAK OUTPUT POWER	32
9.1	LIMITS	32
9.2	TEST PROCEDURES	32
9.3	TEST SETUP	32
9.4	TEST RESULTS	32
10.	POWER SPECTRAL DENSITY	33
10.1	LIMITS	33
10.2	TEST PROCEDURES	33
10.3	TEST SETUP	33
10.4	TEST RESULTS	33
11.	CONDUCTED BAND EDGES AND SPURIOUS EMISSIONS	36
11.1	LIMITS	36
11.2	TEST PROCEDURES	36
11.3	TEST SETUP	36
11.4	TEST RESULTS	36
12.	RESTRICTED BANDS OF OPERATION	43
12.1	LIMITS	43
12.2	TEST PROCEDURES	44
12.3	TEST SETUP	44
12.4	TEST RESULTS	45
	APPENDIX A. PHOTOGRAPH OF THE TEST CONNECTION DIAGRAM	51

APPENDIX B. PHOTOGRAPH OF THE EUT.....51

----- **The following blanks** -----

REPORT ISSUED HISTORY

Report Version	Report No.	Description	Compile Date
1.0	E20230828994601-5	Original Issue	2023-11-02

----- The following blanks -----

1. TEST RESULT SUMMARY

Technical Requirements		
47 CFR FCC Part 15 Subpart C (§15.247) ANSI C63.10-2013 KDB 558074 D01 15.247 measurement guidance v05r02		
Limit / Severity	Item	Result
§15.247(b)(3)	Maximum peak output power	Pass
§15.207 (a)	Conducted Emissions	N/A ¹⁾
§15.247(e)	Power spectral density	Pass
§15.247(a)(2)	6dB bandwidth	Pass
§15.247(d)& §15.205& §15.209	Restricted bands of operation	Pass
§15.247(d)	Conducted band edges and spurious emissions	Pass
§15.247(d) & §15.209 & §15.205	Radiated spurious emissions	Pass
§15.203	Antenna requirement	Pass

Note:

¹⁾Test is not applicable to this Equipment. This EUT is no AC mains power ports.

²⁾The EUT has one antenna. The antenna is PIFA antenna, the max gain of antenna is 0.95dBi, which accordance 15.203 is considered sufficient to comply with the provisions of this section.

----- The following blanks -----

2. GENERAL DESCRIPTION OF EUT

2.1 APPLICANT

Name: Lumi United Technology Co., Ltd
Address: B1, Chongwen Park, Nanshan iPark, Liuxian Avenue, Taoyuan Residential District, Nanshan District, Shenzhen, China

2.2 MANUFACTURER

Name: Lumi United Technology Co., Ltd
Address: B1, Chongwen Park, Nanshan iPark, Liuxian Avenue, Taoyuan Residential District, Nanshan District, Shenzhen, China

2.3 BASIC DESCRIPTION OF EQUIPMENT UNDER TEST

Equipment: Motion and Light Sensor P2
Model No.: ML-S03D
Adding Model: ML-S03E
Models Difference: ML-S03E & ML-S03D have the same technical construction including circuit diagram, PCB LAYOUT, hardware version and software version identical, except sales area and packaging are different.
Trade Name: Aqara
FCC ID: 2AKIT-MLS03
Power Supply: DC 3V power supplied by battery
Battery Model: CR2450
Specification: Norminal Voltage:3.0Vdc
Frequency Range: 2405MHz-2480MHz
Transmit Power: 8.26dBm
Modulation type: O-QPSK
Antenna Specification: PIFA antenna 0.95dBi gain (Max.)
Temperature Range: -10 °C ~ 55 °C
Hardware Version: X3
Software Version: 0.0.0.1
Sample No: E20230828994601-0001, E20230828994601-0007

Note 1: The EUT antenna gain is provided by the applicant. This report is made solely on the basis of such data and/or information. We accept no responsibility for the authenticity and completeness of the above data and information and the validity of the results and/or conclusions.

Note 2: All the tests were performed on the model ML-S03D.

2.4 CHANNEL LIST

Channel No.	Frequency (MHz)	Channel No.	Frequency (MHz)	Channel No.	Frequency (MHz)	Channel No.	Frequency (MHz)
*11	2405	12	2410	13	2415	14	2420
15	2425	16	2430	17	2435	*18	2440
19	2445	20	2450	21	2455	22	2460
23	2465	24	2470	25	2475	*26	2480

* is the test frequency

2.5 TEST OPERATION MODE

Mode No.	Description of the modes
1	Thread fixed frequency transmitting

2.6 LOCAL SUPPORTIVE

Name of Equipment	Manufacturer	Model	Serial Number	Note
Notebook	LENOVO	TianYi 310-14ISK	MP18DLC6	/
Test board	/	/	/	/

No.	Cable Type	Qty.	Shielded Type	Ferrite Core(Qty.)	Length
1	DC cable	1	No	0	0.5m
2	DC cable	1	No	0	0.2m

Note :The notebook is just used to produce fixed frequency transmitting.

2.7 CONFIGURATION OF SYSTEM UNDER TEST

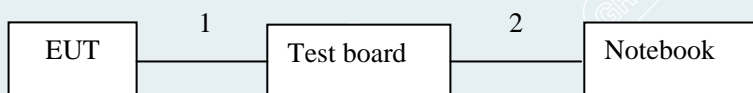

Test software:

Software version	Test level
QCOM_V1.0	2405MHz: 8 2440MHz: 8 2480MHz: 8

2.8 DUTY CYCLE

Environment: 23.8°C/47%RH/101.0kPa

Voltage: DC 3V

Tested By: Qin Tingting

Date: 2023-08-30

Test Mode	Antenna	Frequency (MHz)	Transmission Duration [ms]	Transmission Period [ms]	Duty Cycle [%]
Thread	Ant1	2405	1.00	1.00	100
		2440	1.00	1.00	100
		2480	1.00	1.00	100

Lowest_2405MHz

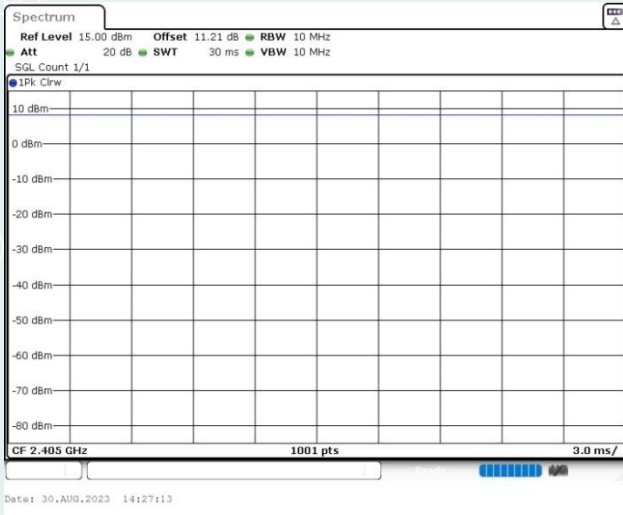

Middle_2440MHz

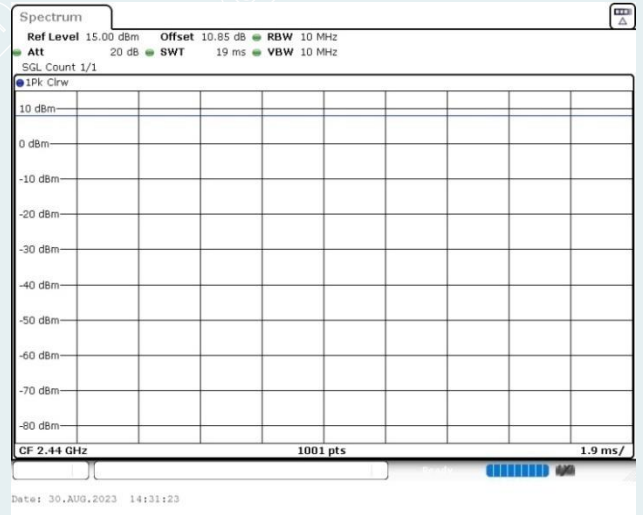

Highest_2480MHz

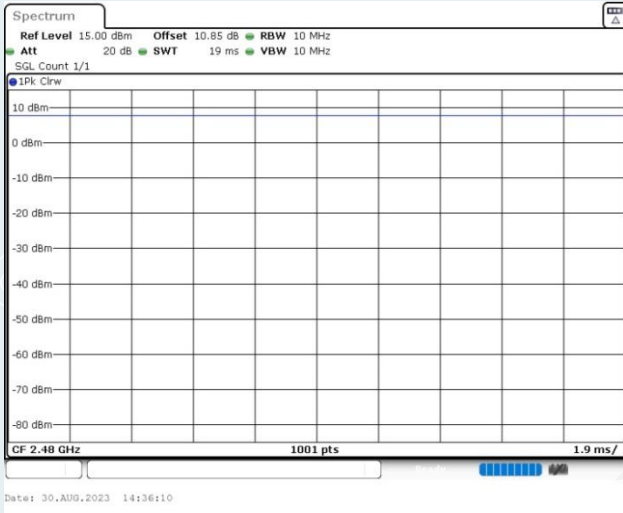

3. LABORATORY

The tests & measurements refer to this report were performed by Shenzhen EMC Laboratory of GRG METROLOGY & TEST GROUP CO., LTD.

Add : No.1301 Guanguang Road Xinlan Community, Guanlan Street, Longhua District
Shenzhen, 518110, People's Republic of China

P.C. : 518110

Tel : 0755-61180008

Fax : 0755-61180008

4. ACCREDITATIONS

Our laboratories are accredited and approved by the following approval agencies according to ISO/IEC 17025:2017.

USA A2LA(Certificate #2861.01)

The measuring facility of laboratories has been authorized or registered by the following approval agencies.

Canada ISED (Company Number: 24897, CAB identifier:CN0069)

USA FCC (Registration Number: 759402, Designation Number:CN1198)

Copies of granted accreditation certificates are available for downloading from our web site,
<http://www.grgtest.com>

----- The following blanks -----

5. MEASUREMENT UNCERTAINTY

Where relevant, the following measurement uncertainty levels have been estimated for tests performed on the EUT as specified in CISPR 16-4-2:

Measurement		Frequency	Uncertainty
Radiated Emission	Coplanar	9kHz~30MHz	4.4dB ¹⁾
	Coaxial	9kHz~30MHz	4.4dB ¹⁾
	Horizontal	30MHz~200MHz	4.6dB ¹⁾
		200MHz~1000MHz	4.8dB ¹⁾
		1GHz~18GHz	5.0dB ¹⁾
		18GHz~26.5GHz	5.2dB ¹⁾
	Vertical	30MHz~200MHz	4.7dB ¹⁾
		200MHz~1000MHz	4.7dB ¹⁾
		1GHz~18GHz	5.1dB ¹⁾
		18GHz~26.5GHz	5.4dB ¹⁾
Conduction Emission		150kHz~30MHz	3.3dB ¹⁾

Measurement	Uncertainty
RF frequency	6.0×10^{-6}
RF power conducted	0.80dB
Power spectral density conducted	0.80dB
Occupied channel bandwidth	0.40dB
Unwanted emission, conducted	0.70dB
Humidity	6.0%
Temperature	2.0°C

Note:

¹⁾ This uncertainty represents an expanded uncertainty expressed at approximately the 95%.

This uncertainty represents an expanded uncertainty factor of $k=2$.

6. LIST OF USED TEST EQUIPMENT AT GRGT

Name of Equipment	Manufacturer	Model	Serial Number	Calibration Due
Radiated Spurious Emission&Restricted bands of operation				
Test S/W	EZ	CCS-03A1		
Test Receiver	R&S	ESR7	102444	2024-08-11
Preamplifier	EMEC	EM330	I00426	2024-02-06
Bi-log Antenna	Schwarzbeck	CBL6143A	26039	2024-10-23
Loop Antenna	TESEQ	HLA6121	52599	2024-02-03
Test Receiver	R&S	ESR26	101758	2023-10-27
Horn Antenna	Schwarzbeck	BBHA9120D	02143	2023-10-15
Board-Band Horn Antenna	Schwarzbeck	BBHA 9170	BBHA9170-497	2023-10-14
Amplifier	Tonscend	TAP01018048	AP20E8060075	2024-04-11
Amplifier	SHIRONG ELECTRONIC	DLNA-1G18G-G40	20200928005	2024-08-17
Test S/W	Tonscend	JS36-RE/2.5.1.5		
6dB Bandwidth&Conducted band edges and Spurious Emission&Power Spectral Density& Maximum Peak Output Power				
Spectrum Analyzer	R&S	FSV30	104381	2024-10-13
Automatic power measuring unit	TONSCEND	JS0806-2	21B8060365	2023-11-17
BT/WIFI System	Tonscend	JS1120-3		

Note:

- The calibration cycle of the above instruments is 12 months.

----- The following blanks -----

7. RADIATED SPURIOUS EMISSIONS

7.1 LIMITS

In any 100 kHz bandwidth outside the frequency band in which the spread spectrum or digitally modulated intentional radiator is operating, the radio frequency power that is produced by the intentional radiator shall be at least 20 dB below that in the 100 kHz bandwidth within the band that contains the highest level of the desired power, based on either an RF conducted or a radiated measurement, provided the transmitter demonstrates compliance with the peak conducted power limits. If the transmitter complies with the conducted power limits based on the use of RMS averaging over a time interval, as permitted under paragraph (b)(3) of this section, the attenuation required under this paragraph shall be 30 dB instead of 20 dB. Attenuation below the general limits specified in §15.209(a) is not required.

Frequency (MHz)	Quasi-peak($\mu\text{V}/\text{m}$)	Measurement distance(m)	Quasi-peak(dB $\mu\text{V}/\text{m}$)@distance 3m
0.009-0.490	2400/F(kHz)	300	128.5~93.8
0.490-1.705	24000/F(kHz)	30	73.8~63
1.705-30.0	30	30	69.5
30~88	100	3	40
88~216	150	3	43.5
216~960	200	3	46
Above 960	500	3	54

NOTE: (1) The lower limit shall apply at the transition frequencies.

(2) Above 18GHz test distance is 1m, so the Peak Limit= $74+20*\log(3/1)=83.54$ (dB $\mu\text{V}/\text{m}$).

The Avg Limit= $54+20*\log(3/1)=63.54$ (dB $\mu\text{V}/\text{m}$).

7.2 TEST PROCEDURES

1) Sequence of testing 9kHz to 30MHz

Setup:

--- The equipment was set up to simulate a typical usage like described in the user manual or described by manufacturer.

--- If the EUT is a tabletop system, a rotatable table with 0.8 m height is used.

--- If the EUT is a floor standing device, it is placed on the ground.

--- Use serial board or connecting line to make EUT and notebook to communicate, according to the actual need to make EUT send constant frequency signal continuously.

--- The EUT is placed on a desktop position in the center of the turntable.

--- The measurement distance is 3 meter.

--- The EUT was set into operation.

Pre measurement:

--- The turntable rotates from 0 ° to 360 °.

--- The antenna height is 1.0 meter.

--- At each turntable position the analyzer sweeps with peak detection to find the maximum of all emissions.

Final measurement:

--- Identified emissions during the pre measurement the software maximizes by rotating the turntable position (0 ° to 360 °) and by rotating the elevation axes (0 ° to 360 °).

--- The final measurement will be done in the position (turntable and elevation) causing the highest

emissions with QP detector.

--- The final levels, frequency, measuring time, bandwidth, turntable position, correction factor, margin to the limit and limit will be recorded. Also a plot with the graph of the pre measurement and the limit will be stored.

2) Sequence of testing 30MHz to 1GHz

Setup:

--- The equipment was set up to simulate a typical usage like described in the user manual or described by manufacturer.

--- If the EUT is a tabletop system, a table with 0.8 m height is used, which is placed on the ground plane.

--- If the EUT is a floor standing device, it is placed on the ground plane with insulation between both.

--- Use serial board or connecting line to make EUT and notebook to communicate, according to the actual need to make EUT send constant frequency signal continuously.

--- The EUT is placed on a desktop position in the center of the turntable.

--- The measurement distance is 3 meter.

--- The EUT was set into operation.

Pre measurement:

--- The turntable rotates from 0 ° to 360 °.

--- The antenna is polarized vertical and horizontal.

--- The antenna height changes from 1 to 4 meter.

--- At each turntable position, antenna polarization and height the analyzer sweeps three times in peak to find the maximum of all emissions.

Final measurement:

--- The final measurement will be performed with minimum the six highest peaks.

--- According to the maximum antenna and turntable positions of pre measurement the software maximize the peaks by changing turntable rotates from 0 ° to 360 ° and antenna movement between 1 and 4 meter.

--- The final measurement will be done with QP detector with an EMI receiver.

--- The final levels, frequency, measuring time, bandwidth, antenna height, antenna polarization, turntable angle, correction factor, margin to the limit and limit will be recorded. Also a plot with the graph of the pre measurement with marked maximum final measurements and the limit will be stored.

3) Sequence of testing 1GHz to 18GHz

Setup:

--- The equipment was set up to simulate a typical usage like described in the user manual or described by manufacturer.

--- If the EUT is a tabletop system, a rotatable table with 1.5 m height is used.

--- If the EUT is a floor standing device, it is placed on the ground plane with insulation between both.

--- Use serial board or connecting line to make EUT and notebook to communicate, according to the actual need to make EUT send constant frequency signal continuously.

--- The EUT is placed on a desktop position in the center of the turntable.

--- The measurement distance is 3 meter.

--- The EUT was set into operation.

Pre measurement:

- The turntable rotates from 0 ° to 360 °.
- The antenna is polarized vertical and horizontal.
- The antenna height scan range is 1 meter to 4 meter.
- At each turntable position and antenna polarization the analyzer sweeps with peak detection to find the maximum of all emissions.

Final measurement:

- The final measurement will be performed with minimum the six highest peaks.
- According to the maximum antenna and turntable positions of pre measurement the software maximize the peaks by changing turntable rotates from 0 ° to 360 ° and antenna movement between 1 and 4 meter. This procedure is repeated for both antenna polarizations.
- The final measurement will be done in the position (turntable, EUT-table and antenna polarization) causing the highest emissions with Peak and Average detector.
- The final levels, frequency, measuring time, bandwidth, turntable position, EUT-table position, antenna polarization, correction factor, margin to the limit and limit will be recorded. Also a plot with the graph of the pre measurement with marked maximum final measurements and the limit will be stored.

4) Sequence of testing above 18GHz**Setup:**

- The equipment was set up to simulate a typical usage like described in the user manual or described by manufacturer.
- If the EUT is a tabletop system, a rotatable table with 1.5 m height is used.
- If the EUT is a floor standing device, it is placed on the ground plane with insulation between both.
- Use serial board or connecting line to make EUT and notebook to communicate, according to the actual need to make EUT send constant frequency signal continuously.
- The EUT is placed on a desktop position in the center of the turntable.
- The measurement distance is 1 meter.
- The EUT was set into operation.

Pre measurement:

- The turntable rotates from 0 ° to 360 °.
- The antenna is polarized vertical and horizontal.
- The antenna height scan range is 1 meter to 4 meter.
- At each turntable position and antenna polarization the analyzer sweeps with peak detection to find the maximum of all emissions.

Final measurement:

- The final measurement will be performed with minimum the six highest peaks.
- According to the maximum antenna and turntable positions of pre measurement the software maximize the peaks by changing turntable rotates from 0 ° to 360 ° and antenna movement between 1 and 4 meter. This procedure is repeated for both antenna polarizations.
- The final measurement will be done in the position (turntable, EUT-table and antenna polarization) causing the highest emissions with Peak and Average detector.
- The final levels, frequency, measuring time, bandwidth, turntable position, EUT-table position, antenna polarization, correction factor, margin to the limit and limit will be recorded. Also a plot with the graph of the pre measurement with marked maximum final measurements and the limit will be stored.

NOTE:

- (a). The frequency from 9kHz to 150kHz, Set RBW=300Hz (for Peak&AVG), RBW=300Hz (for Peak&AVG).
the frequency from 150kHz to 30MHz, Set RBW=9kHz, RBW=9kHz, (for QP Detector).
- (b). The frequency from 30MHz to 1GHz, Set RBW=120kHz, RBW=300kHz, (for QP Detector).
- (c). The frequency above 1GHz, for Peak detector: Set RBW=1MHz, RBW=3MHz.
- (d). The frequency above 1GHz, for Avg detector: Set RBW=1MHz, the EUT is configured to transmit with duty cycle $\geq 98\%$, set $VBW \leq RBW/100$ (i.e., 10kHz) but not less than 10 Hz. If the EUT duty cycle is $< 98\%$, set $VBW \geq 1/T$, Where T is defined in section 2.8.

7.3 TEST SETUP

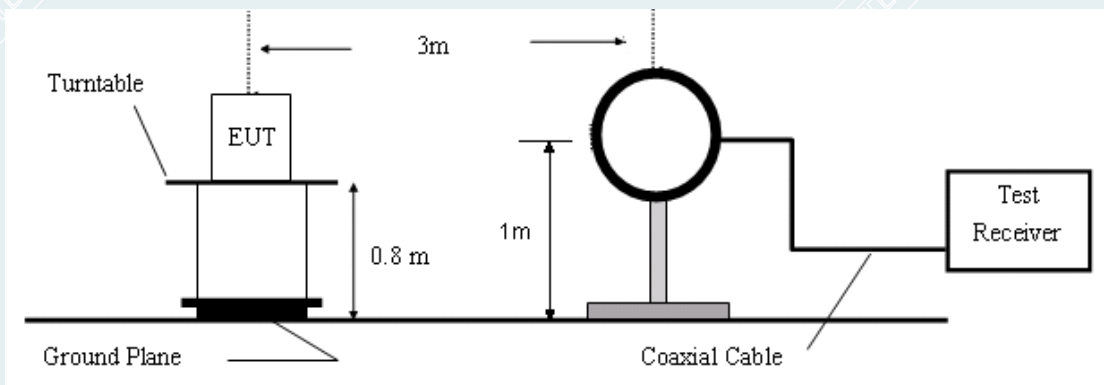

Figure 1. 9kHz to 30MHz radiated emissions test configuration

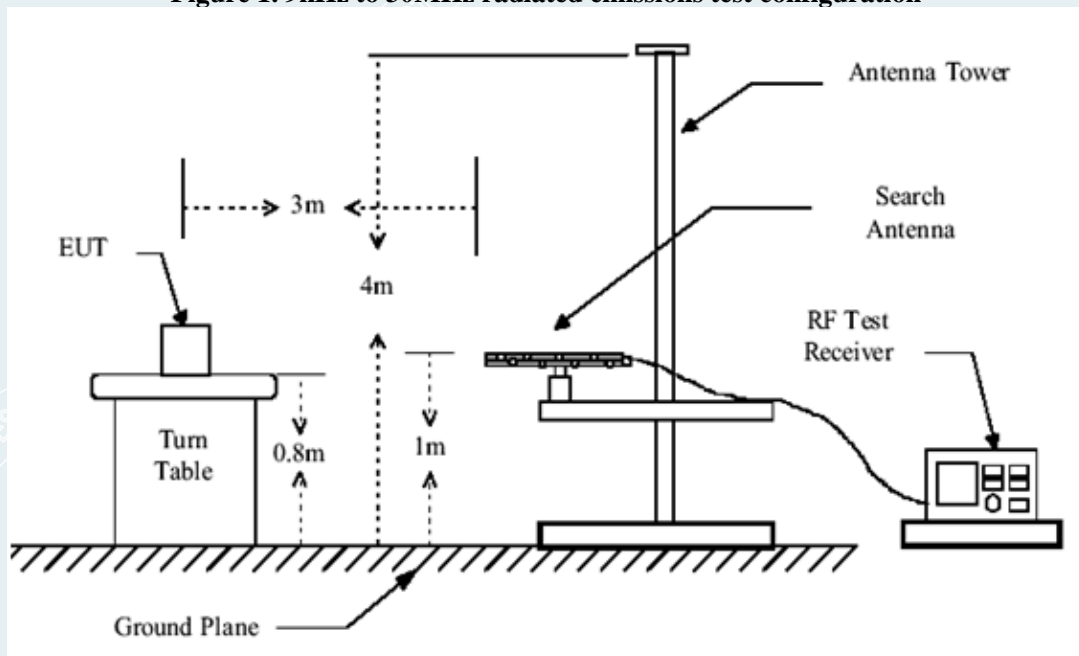

Figure 2. 30MHz to 1GHz radiated emissions test configuration

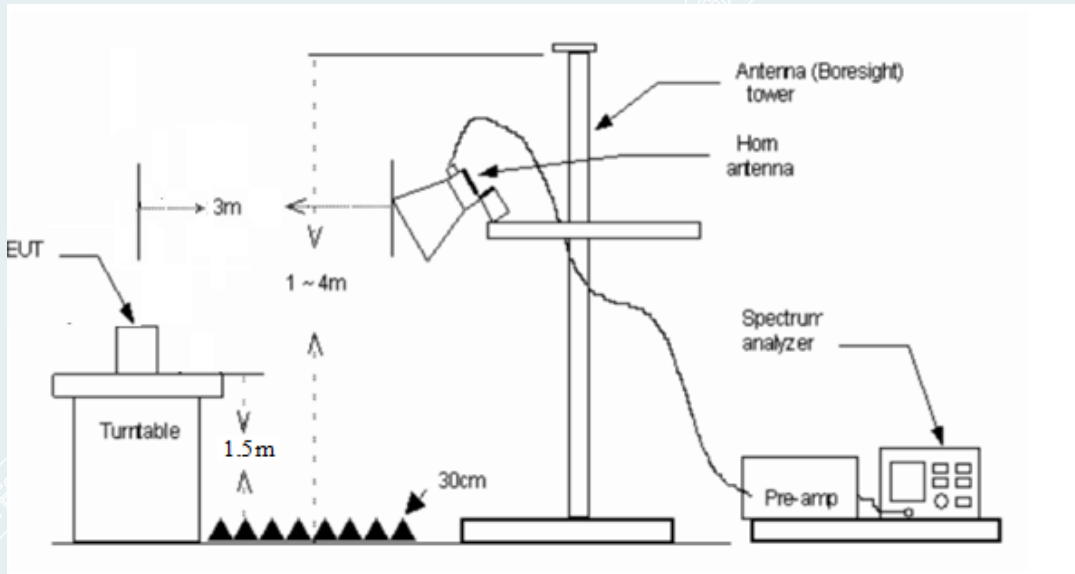

Figure 3. 1GHz-18GHz radiated emissions test configuration

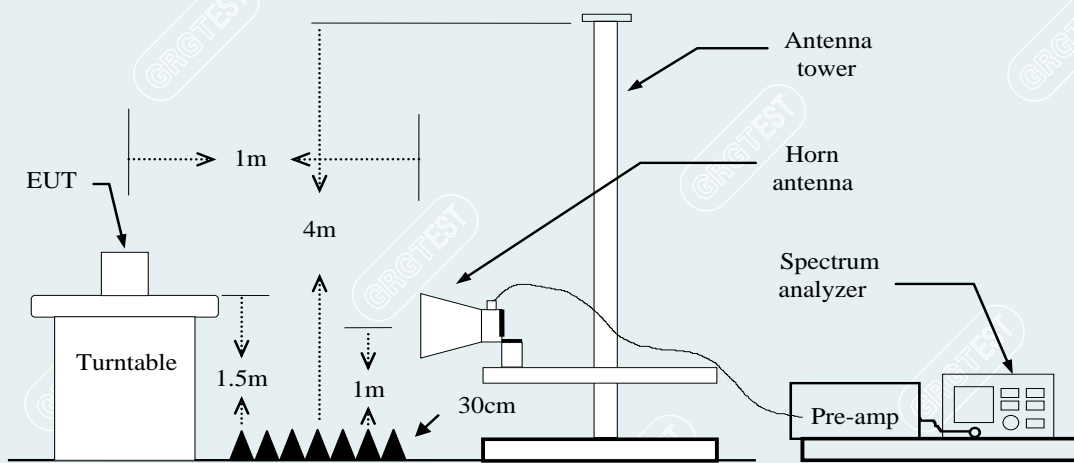

Figure 4. 18GHz-26.5GHz radiated emissions test configuration

----- The following blanks -----

7.4 DATA SAMPLE

30MHz to 1GHz

Frequency (MHz)	Reading (dBuV)	Correct Factor (dB/m)	Result (dBuV/m)	Limit (dBuV/m)	Margin (dB)	Degree (deg.)	Heigh (cm)	Detectorty pe
XXX.XXXX	48.49	-9.91	38.58	47.00	-8.42	100	108	QP

- Frequency (MHz) = Emission frequency in MHz
- Reading (dBuV) = Uncorrected Analyzer / Receiver reading
- Correct Factor (dB/m) = Antenna factor + Cable loss – Amplifier gain
- Result (dBuV/m) = Reading (dBuV) + Correct Factor (dB/m)
- Limit (dBuV/m) = Limit stated in standard
- Margin (dB) = Result (dBuV/m)-Limit (dBuV/m)
- Peak = Peak Reading
- QP = Quasi-peak Reading

1GHz-18GHz

No.	Freq. [MHz]	Reading [dBμV/m]	Level [dBμV/m]	Factor [dB]	Limit [dBμV/m]	Margin [dB]	Height [cm]	Angle [°]	Polarity	Remark
xxx	xxxx	78.01	55.30	-22.71	74.00	18.70	100	50	Horizontal	Peak
xxx	xxxx	66.37	43.66	-22.71	54.00	10.34	100	50	Horizontal	AVG

Above 18GHz

NO.	Freq. [MHz]	Reading [dBμV/m]	Level for 1m [dBμV/m]	Level for 3m [dBμV/m]	Factor [dB]	Limit [dBμV/m]	Margin [dB]	Height [cm]	Angle [°]	Polarity	Remark
xxx	xxxx	54.49	42.38	32.84	-12.11	74	41.16	100	211	Horizontal	Peak
xxx	xxxx	43.99	31.88	22.34	-12.11	54	31.66	100	211	Horizontal	AVG

- Frequency (MHz) = Emission frequency in MHz
- Reading (dBuV/m) = Uncorrected Analyzer / Receiver reading
- Factor (dB) = Antenna factor + Cable loss – Amplifier gain
- Level for 1m (dBuV/m) = Reading (dBuV/m) + Factor (dB)
- Level for 3m (dBuV/m) = Level for 1m (dBuV/m) + 20*log(1/3)
- Limit (dBuV/m) = Limit stated in standard
- Margin (dB) = Limit (dBuV/m) – Level (dBuV/m)
- Polarity = Antenna polarization
- Peak = Peak Reading
- AVG = Average Reading

7.5 TEST RESULTS

The test are under 3-axes(X,Y,Z) position(X denotes lying on the table, Y denotes side stand and Z denotes vertical stand), After pre-test, It was found that the worse radiation emission was get at the Z position. So the data shown the Z position only.

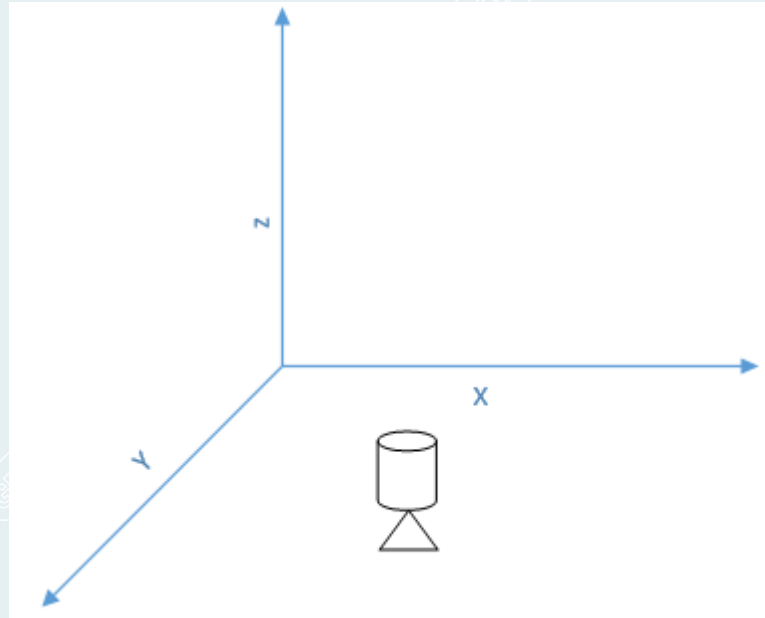

----- The following blanks -----

Below 1GHz

Only the worst Frequency were recorded in this report. Highest Frequency (2480MHz)

EUT Name:	Motion and Light Sensor P2	Test Mode:	Mode 1
Model:	ML-S03D	Sample No:	E20230828994601-0007
Power supply:	DC 3V	Environmental Conditions:	25.6°C/58%RH/101.0kPa
Test Engineer:	Huang Xinlong	Test Date:	2023-09-05
Frequency	Highest Frequency (2480MHz)	Polarity:	Horizontal

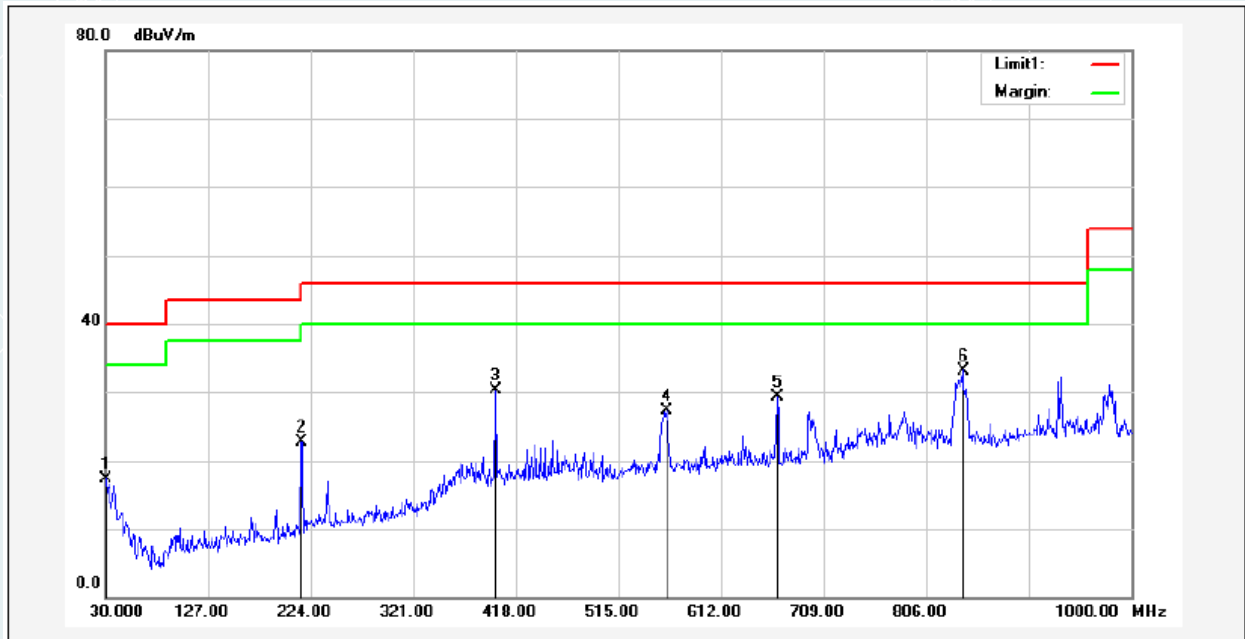

No.	Frequency (MHz)	Reading (dBuV)	Correction factor(dB/m)	Result (dBuV/m)	Limit (dBuV/m)	Margin (dB)	Degree (deg.)	Height (cm)	Detector type
1	30.0000	34.74	-17.34	17.40	40.00	-22.60	145	100	QP
2	215.2700	48.45	-25.67	22.78	43.50	-20.72	166	200	QP
3	399.5700	49.93	-19.69	30.24	46.00	-15.76	356	200	QP
4	560.5900	43.51	-16.19	27.32	46.00	-18.68	111	100	QP
5	665.3500	44.59	-15.28	29.31	46.00	-16.69	91	100	QP
6*	840.9200	46.42	-13.22	33.20	46.00	-12.80	339	100	QP

EUT Name:	Motion and Light Sensor P2	Test Mode:	Mode 1
Model:	ML-S03D	Sample No:	E20230828994601-0007
Power supply:	DC 3V	Environmental Conditions:	25.6°C/58%RH/101.0kPa
Test Engineer:	Huang Xinlong	Test Date:	2023-09-05
Frequency	Highest Frequency(2480MHz)	Polarity:	Vertical

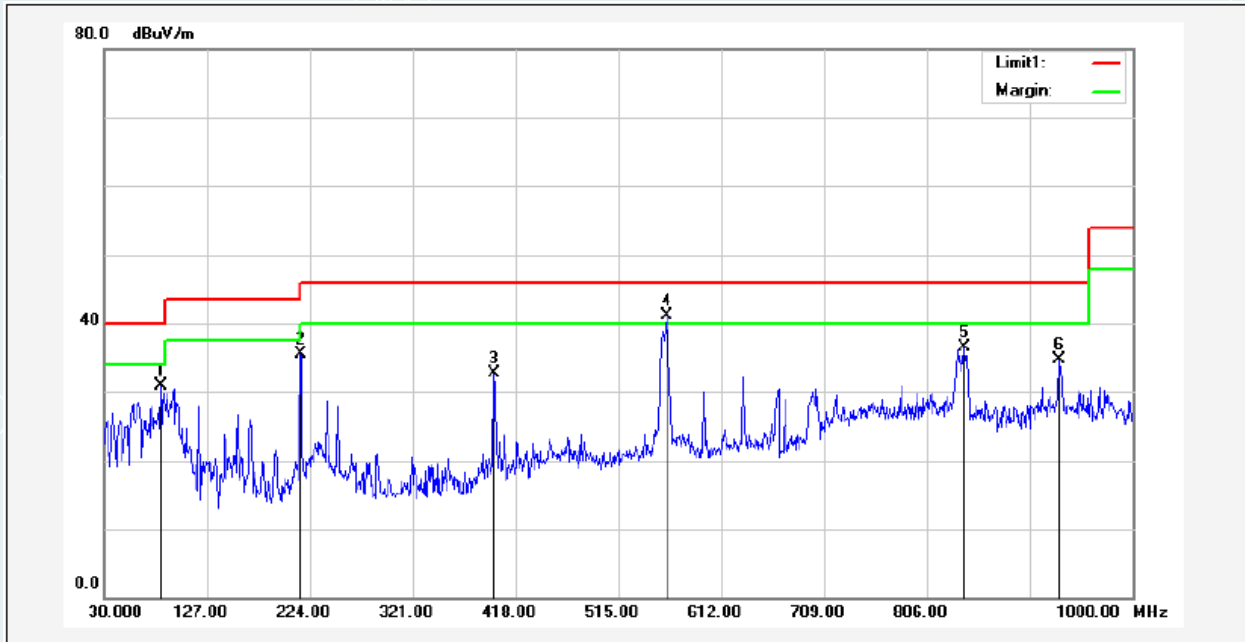

No.	Frequency (MHz)	Reading (dBuV)	Correction factor(dB/m)	Result (dBuV/m)	Limit (dBuV/m)	Margin (dB)	Degree (deg.)	Height (cm)	Detector type
1	83.3500	62.19	-31.23	30.96	40.00	-9.04	1	100	QP
2	215.2700	61.13	-25.67	35.46	43.50	-8.04	231	100	QP
3	397.6300	52.52	-19.78	32.74	46.00	-13.26	18	100	QP
4*	560.5900	57.29	-16.19	41.10	46.00	-4.90	358	100	QP
5	840.9200	49.68	-13.22	36.46	46.00	-9.54	16	100	QP
6	930.1600	46.97	-12.31	34.66	46.00	-11.34	360	103	QP

Remark:

- 1 No emission found between lowest internal used/generated frequency to 30MHz.
- 2 Radiated emissions measured in frequency range from 9kHz to 1GHz were made with an instrument using Quasi-peak detector mode.
- 3 Data of measurement within this frequency range shown “---” in the table above means the reading of emissions are attenuated more than 20dB below the permissible limits or the field strength is too small to be measured.
- 4 The IF bandwidth of Receiver between 30MHz to 1GHz was 120kHz.

1GHz-18GHz:

According to C63.10, if the peak (or quasi-peak) measured value complies with the average limit, it is unnecessary to perform an average measurement, so AV emission value did not show in below table if the peak value complies with average limit.

EUT Name:	Motion and Light Sensor P2	Test Mode:	Mode 1
Model:	ML-S03D	Sample No:	E20230828994601-0007
Power supply:	DC 3V	Environmental Conditions:	25.8°C/53%RH/101.0kPa
Test Engineer:	Zhang Zishan	Test Date:	2023-09-05
Frequency	Lowest Frequency (2405MHz)	/	/

Suspected Data List

NO.	Freq. [MHz]	Reading [dBμV/m]	Level [dBμV/m]	Factor [dB]	Limit [dBμV/m]	Margin [dB]	Height [cm]	Angle [°]	Polarity
1	1196.6000	54.94	45.94	-9.00	74.00	28.06	100	344	Horizontal
2	1999.8000	55.65	50.24	-5.41	74.00	23.76	100	45	Horizontal
3	2657.8000	52.03	49.23	-2.80	74.00	24.77	100	45	Horizontal
4	4809.0000	50.47	48.16	-2.31	74.00	25.84	200	306	Horizontal
5	5973.0000	55.67	54.35	-1.32	74.00	19.65	100	152	Horizontal
6	15652.5000	38.11	50.94	12.83	74.00	23.06	200	297	Horizontal

AV Final Data List

NO.	Freq. [MHz]	Factor [dB]	AV Reading [dBμV/m]	AV Value [dBμV/m]	AV Limit [dBμV/m]	AV Margin [dB]	Height [cm]	Angle [°]	Polarity
1	1998.5270	-5.41	38.38	32.97	54.00	21.03	101	17.8	Horizontal
2	2663.3390	-2.80	38.26	35.46	54.00	18.54	100	56.5	Horizontal
3	4810.7400	-2.31	42.63	40.32	54.00	13.68	166	309.6	Horizontal
4	5979.9150	-1.32	34.11	32.79	54.00	21.21	122	180.8	Horizontal
5	15703.6975	12.83	27.26	40.09	54.00	13.91	158	292.9	Horizontal

Suspected Data List

NO.	Freq. [MHz]	Reading [dBμV/m]	Level [dBμV/m]	Factor [dB]	Limit [dBμV/m]	Margin [dB]	Height [cm]	Angle [°]	Polarity
1	1198.0000	59.58	50.54	-9.04	74.00	23.46	100	314	Vertical
2	1990.8000	58.94	52.21	-6.73	74.00	21.79	100	148	Vertical
3	2661.4000	59.93	57.10	-2.83	74.00	16.90	100	139	Vertical
4	3990.0000	59.66	51.12	-8.54	74.00	22.88	100	158	Vertical
5	4809.0000	53.63	51.26	-2.37	74.00	22.74	100	323	Vertical
6	5988.0000	55.51	54.05	-1.46	74.00	19.95	200	347	Vertical

AV Final Data List									
NO.	Freq. [MHz]	Factor [dB]	AV Reading [dB μ V/m]	AV Value [dB μ V/m]	AV Limit [dB μ V/m]	AV Margin [dB]	Height [cm]	Angle [°]	Polarity
1	1198.6410	-9.04	44.60	35.56	54.00	18.44	114	320.8	Vertical
2	1996.8790	-6.73	42.74	36.01	54.00	17.99	100	130	Vertical
3	2662.3240	-2.83	42.36	39.53	54.00	14.47	114	141.2	Vertical
4	3993.8110	-8.54	44.92	36.38	54.00	17.62	101	184.9	Vertical
5	4810.5310	-2.37	45.67	43.30	54.00	10.70	121	321.5	Vertical
6	5977.7740	-1.46	34.13	32.67	54.00	21.33	104	87.6	Vertical

----- The following blanks -----

EUT Name:	Motion and Light Sensor P2	Test Mode:	Mode 1
Model:	ML-S03D	Sample No:	E20230828994601-0007
Power supply:	DC 3V	Environmental Conditions:	25.8°C/53%RH/101.0kPa
Test Engineer:	Zhang Zishan	Test Date:	2023-09-05
Frequency	Middle Frequency (2440MHz)	/	/

Suspected Data List

NO.	Freq. [MHz]	Reading [dB μ V/m]	Level [dB μ V/m]	Factor [dB]	Limit [dB μ V/m]	Margin [dB]	Height [cm]	Angle [°]	Polarity
1	1195.0000	58.29	49.28	-9.01	74.00	24.72	100	199	Horizontal
2	1998.0000	58.80	53.35	-5.45	74.00	20.65	100	61	Horizontal
3	2657.4000	56.85	54.05	-2.80	74.00	19.95	100	61	Horizontal
4	3987.0000	57.08	48.93	-8.15	74.00	25.07	100	68	Horizontal
5	4960.5000	51.27	50.16	-1.11	74.00	23.84	200	68	Horizontal
6	5976.0000	55.65	54.30	-1.35	74.00	19.70	100	110	Horizontal

AV Final Data List

NO.	Freq. [MHz]	Factor [dB]	AV Reading [dB μ V/m]	AV Value [dB μ V/m]	AV Limit [dB μ V/m]	AV Margin [dB]	Height [cm]	Angle [°]	Polarity
1	1195.3980	-9.01	45.60	36.59	54.00	17.41	100	212.6	Horizontal
2	1998.1450	-5.45	38.12	32.67	54.00	21.33	122	79.5	Horizontal
3	2659.2070	-2.80	43.13	40.33	54.00	13.67	100	58.7	Horizontal
4	3982.5570	-8.15	39.93	31.78	54.00	22.22	119	78.2	Horizontal
5	4959.0645	-1.11	45.07	43.96	54.00	10.04	200	64.5	Horizontal
6	5991.0480	-1.35	35.96	34.61	54.00	19.39	189	113.5	Horizontal

Suspected Data List

NO.	Freq. [MHz]	Reading [dB μ V/m]	Level [dB μ V/m]	Factor [dB]	Limit [dB μ V/m]	Margin [dB]	Height [cm]	Angle [°]	Polarity
1	1196.8000	59.48	50.40	-9.08	74.00	23.60	200	345	Vertical
2	1995.2000	60.40	53.68	-6.72	74.00	20.32	100	335	Vertical
3	2658.4000	59.16	56.32	-2.84	74.00	17.68	100	150	Vertical
4	3984.0000	62.45	53.91	-8.54	74.00	20.09	100	213	Vertical
5	4959.0000	55.85	54.34	-1.51	74.00	19.66	100	328	Vertical
6	5995.5000	59.26	57.72	-1.54	74.00	16.28	100	308	Vertical

AV Final Data List

NO.	Freq. [MHz]	Factor [dB]	AV Reading [dB μ V/m]	AV Value [dB μ V/m]	AV Limit [dB μ V/m]	AV Margin [dB]	Height [cm]	Angle [°]	Polarity
1	1196.4540	-9.08	40.83	31.75	54.00	22.25	200	25	Vertical
2	1995.1130	-6.72	38.01	31.29	54.00	22.71	121	179.1	Vertical
3	2662.7090	-2.84	37.60	34.76	54.00	19.24	114	154	Vertical
4	3982.2700	-8.54	39.61	31.07	54.00	22.93	101	232.8	Vertical
5	4959.9330	-1.51	45.27	43.76	54.00	10.24	141	333.9	Vertical
6	5981.3575	-1.54	34.22	32.68	54.00	21.32	100	309.9	Vertical

EUT Name:	Motion and Light Sensor P2	Test Mode:	Mode 1
Model:	ML-S03D	Sample No:	E20230828994601-0007
Power supply:	DC 3V	Environmental Conditions:	25.8°C/53%RH/101.0kPa
Test Engineer:	Zhang Zishan	Test Date:	2023-09-05
Frequency	Highest Frequency (2480MHz)	/	/

Suspected Data List

NO.	Freq. [MHz]	Reading [dB μ V/m]	Level [dB μ V/m]	Factor [dB]	Limit [dB μ V/m]	Margin [dB]	Height [cm]	Angle [°]	Polarity
1	1163.0000	52.98	43.86	-9.12	74.00	30.14	200	211	Horizontal
2	1328.8000	51.95	43.48	-8.47	74.00	30.52	100	79	Horizontal
3	1665.0000	53.69	46.02	-7.67	74.00	27.98	100	244	Horizontal
4	2906.4000	48.53	47.70	-0.83	74.00	26.30	200	18	Horizontal
5	4881.0000	49.41	47.29	-2.12	74.00	26.71	100	131	Horizontal
6	12139.5000	37.40	51.43	14.03	74.00	22.57	100	305	Horizontal

AV Final Data List

NO.	Freq. [MHz]	Factor [dB]	AV Reading [dB μ V/m]	AV Value [dB μ V/m]	AV Limit [dB μ V/m]	AV Margin [dB]	Height [cm]	Angle [°]	Polarity
1	12139.5000	14.03	30.01	44.04	54.00	9.96	100	305	Horizontal

Suspected Data List

NO.	Freq. [MHz]	Reading [dB μ V/m]	Level [dB μ V/m]	Factor [dB]	Limit [dB μ V/m]	Margin [dB]	Height [cm]	Angle [°]	Polarity
1	1197.4000	58.15	49.09	-9.06	74.00	24.91	100	65	Vertical
2	2000.0000	60.23	53.52	-6.71	74.00	20.48	100	169	Vertical
3	2657.8000	57.74	54.89	-2.85	74.00	19.11	100	118	Vertical
4	3985.5000	61.21	52.67	-8.54	74.00	21.33	100	213	Vertical
5	4881.0000	54.91	52.37	-2.54	74.00	21.63	100	328	Vertical
6	5988.0000	59.34	57.88	-1.46	74.00	16.12	100	110	Vertical

AV Final Data List

NO.	Freq. [MHz]	Factor [dB]	AV Reading [dB μ V/m]	AV Value [dB μ V/m]	AV Limit [dB μ V/m]	AV Margin [dB]	Height [cm]	Angle [°]	Polarity
1	1198.5090	-9.06	43.03	33.97	54.00	20.03	112	61.4	Vertical
2	1993.8640	-6.71	40.60	33.89	54.00	20.11	100	202.2	Vertical
3	2664.2230	-2.85	40.60	37.75	54.00	16.25	100	146.8	Vertical
4	3987.1145	-8.54	46.23	37.69	54.00	16.31	100	185.2	Vertical
5	4880.5760	-2.54	46.28	43.74	54.00	10.26	112	319.1	Vertical
6	5980.8070	-1.46	34.70	33.24	54.00	20.76	100	99.2	Vertical

18GHz-26.5GHz:

According to C63.10, if the peak (or quasi-peak) measured value complies with the average limit, it is unnecessary to perform an average measurement, so AV emission value did not show in below table if the peak value complies with average limit.

EUT Name:	Motion and Light Sensor P2	Test Mode:	Mode 1
Model:	ML-S03D	Sample No:	E20230828994601-0007
Power supply:	DC 3V	Environmental Conditions:	25.8°C/53%RH/101.0kPa
Test Engineer:	Zhang Zishan	Test Date:	2023-09-05
Frequency	Lowest Frequency (2405MHz)	/	/

Suspected Data List										
NO.	Freq. [MHz]	Reading [dB μ V/m]	Level for 1m [dB μ V/m]	Level for 3m [dB μ V/m]	Factor [dB]	Limit [dB μ V/m]	Margin [dB]	Height [cm]	Angle [°]	Polarity
1	18326.8250	48.08	30.17	20.63	-17.91	74	53.37	150	101	Horizontal
2	19916.7500	47.90	31.34	21.8	-16.56	74	52.20	150	245	Horizontal
3	22590.8500	44.78	29.78	20.24	-15.00	74	53.76	150	27	Horizontal
4	24011.2000	46.11	31.88	22.34	-14.23	74	51.66	150	173	Horizontal
5	24763.0250	45.96	31.98	22.44	-13.98	74	51.56	150	221	Horizontal
6	26409.0500	46.35	32.43	22.89	-13.92	74	51.11	150	126	Horizontal

Suspected Data List										
NO.	Freq. [MHz]	Reading [dB μ V/m]	Level for 1m [dB μ V/m]	Level for 3m [dB μ V/m]	Factor [dB]	Limit [dB μ V/m]	Margin [dB]	Height [cm]	Angle [°]	Polarity
1	18232.4750	48.61	30.51	20.97	-18.10	74	53.03	150	221	Vertical
2	19837.7000	47.35	30.48	20.94	-16.87	74	53.06	150	197	Vertical
3	21587.8500	45.00	29.12	19.58	-15.88	74	54.42	150	148	Vertical
4	23500.7750	45.57	30.54	21	-15.03	74	53.00	150	197	Vertical
5	24502.5000	46.08	31.85	22.31	-14.23	74	51.69	150	209	Vertical
6	25537.3750	45.91	31.85	22.31	-14.06	74	51.69	150	246	Vertical

----- The following blanks -----

EUT Name:	Motion and Light Sensor P2	Test Mode:	Mode 1
Model:	ML-S03D	Sample No:	E20230828994601-0007
Power supply:	DC 3V	Environmental Conditions:	25.8°C/53%RH/101.0kPa
Test Engineer:	Zhang Zishan	Test Date:	2023-09-05
Frequency	Middle Frequency (2440MHz)	/	/

Suspected Data List										
NO.	Freq. [MHz]	Reading [dB μ V/m]	Level for 1m [dB μ V/m]	Level for 3m [dB μ V/m]	Factor [dB]	Limit [dB μ V/m]	Margin [dB]	Height [cm]	Angle [°]	Polarity
1	18225.2500	48.90	30.80	21.26	-18.10	74	52.74	150	360	Horizontal
2	19921.8500	48.21	31.66	22.12	-16.55	74	51.88	150	137	Horizontal
3	21601.8750	45.32	29.40	19.86	-15.92	74	54.14	150	356	Horizontal
4	22949.5500	45.81	31.07	21.53	-14.74	74	52.47	150	332	Horizontal
5	24018.4250	46.32	32.09	22.55	-14.23	74	51.45	150	113	Horizontal
6	25305.7500	46.52	32.48	22.94	-14.04	74	51.06	150	282	Horizontal

Suspected Data List										
NO.	Freq. [MHz]	Reading [dB μ V/m]	Level for 1m [dB μ V/m]	Level for 3m [dB μ V/m]	Factor [dB]	Limit [dB μ V/m]	Margin [dB]	Height [cm]	Angle [°]	Polarity
1	18249.0500	47.74	29.66	20.12	-18.08	74	53.88	150	76	Vertical
2	19912.9250	47.65	30.82	21.28	-16.83	74	52.72	150	345	Vertical
3	22050.2500	45.06	29.24	19.7	-15.82	74	54.30	150	138	Vertical
4	23706.0500	45.10	30.44	20.9	-14.66	74	53.10	150	308	Vertical
5	25005.7000	45.81	31.87	22.33	-13.94	74	51.67	150	150	Vertical
6	25453.6500	46.00	31.93	22.39	-14.07	74	51.61	150	64	Vertical

----- The following blanks -----

EUT Name:	Motion and Light Sensor P2	Test Mode:	Mode 1
Model:	ML-S03D	Sample No:	E20230828994601-0007
Power supply:	DC 3V	Environmental Conditions:	25.8°C/53%RH/101.0kPa
Test Engineer:	Zhang Zishan	Test Date:	2023-09-05
Frequency	Highest Frequency (2480MHz)	/	/

Suspected Data List										
NO.	Freq. [MHz]	Reading [dBμV/m]	Level for 1m [dBμV/m]	Level for 3m [dBμV/m]	Factor [dB]	Limit [dBμV/m]	Margin [dB]	Height [cm]	Angle [°]	Polarity
1	18231.2000	47.90	29.80	20.26	-18.10	74	53.74	150	320	Horizontal
2	19896.3500	47.17	31.03	21.49	-16.58	74	52.95	150	148	Horizontal
3	21383.4250	44.22	29.94	20.4	-15.84	74	55.16	150	28	Horizontal
4	22964.4250	45.88	31.26	21.72	-14.74	74	52.40	150	333	Horizontal
5	24016.3000	45.53	31.59	22.05	-14.23	74	52.24	150	360	Horizontal
6	25201.6250	45.46	31.29	21.75	-13.96	74	52.04	150	40	Horizontal

Suspected Data List										
NO.	Freq. [MHz]	Reading [dBμV/m]	Level for 1m [dBμV/m]	Level for 3m [dBμV/m]	Factor [dB]	Limit [dBμV/m]	Margin [dB]	Height [cm]	Angle [°]	Polarity
1	18231.2000	48.69	30.58	21.04	-18.11	74	52.96	150	332	Vertical
2	19899.7500	47.74	30.90	21.36	-16.84	74	52.64	150	86	Vertical
3	21558.5250	44.99	29.12	19.58	-15.87	74	54.42	150	258	Vertical
4	23051.1250	45.54	30.80	21.26	-14.74	74	52.74	150	320	Vertical
5	25024.8250	45.89	31.93	22.39	-13.96	74	51.61	150	184	Vertical
6	25421.3500	46.00	31.92	22.38	-14.08	74	51.62	150	73	Vertical

Remark:

- 1 Measuring frequencies from 1 GHz to the 10th harmonic of highest fundamental frequency.
- 2 Measurements above show only up to 6 maximum emissions noted, or would be lesser if no specific emissions from the EUT are recorded (ie: margin>20dB from the applicable limit) and considered that's already beyond the background noise floor.
- 3 Radiated emissions measured in frequency above 1000MHz were made with an instrument using Peak detector mode and average detector mode of the emission shown in Actual FS column.
- 4 Above 18G test distance is 1m, so the Level for 3m= Level for 1m + 20*log(1/3)

8. 6dB BANDWIDTH

8.1 LIMITS

Systems using digital modulation techniques may operate in the 902–928 MHz, 2400–2483.5 MHz, and 5725–5850 MHz bands. The minimum 6 dB bandwidth shall be at least 500 kHz.

8.2 TEST PROCEDURES

- 1) Remove the antenna from the EUT, and then connect a low loss RF cable from antenna port to Automatic power measuring unit.
- 2) Set resolution bandwidth (RBW) = 100kHz. Set the video bandwidth (VBW) $\geq 3 \times$ RBW. Detector = Peak. Trace mode = max hold. Sweep = auto couple. Allow the trace to stabilize, record 6dB bandwidth value.
- 3) Repeat above procedures until all frequencies measured were complete.

8.3 TEST SETUP

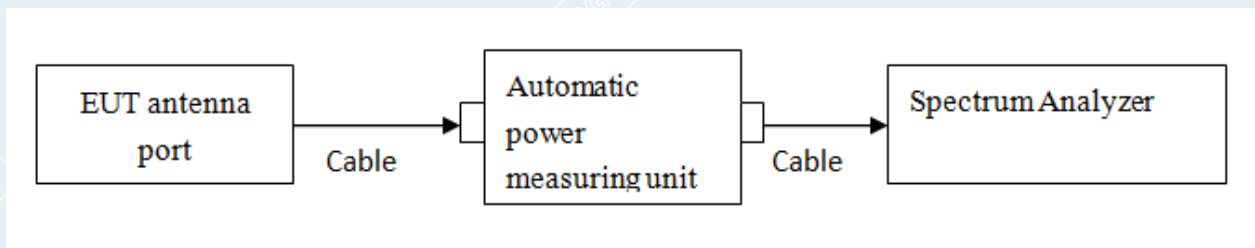

8.4 TEST RESULTS

Environment: 23.8°C/47%RH/101.0kPa

Tested By: Qin Tingting

Voltage: DC 3V

Date: 2023-08-30

Ch Name	Frequency (MHz)	Bandwidth [kHz]	Limit[kHz]	Verdict
Lowest	2405	1560	≥ 500	PASS
Middle	2440	1560		PASS
Highest	2480	1560		PASS

----- The following blanks -----

Lowest Frequency (2405MHz)

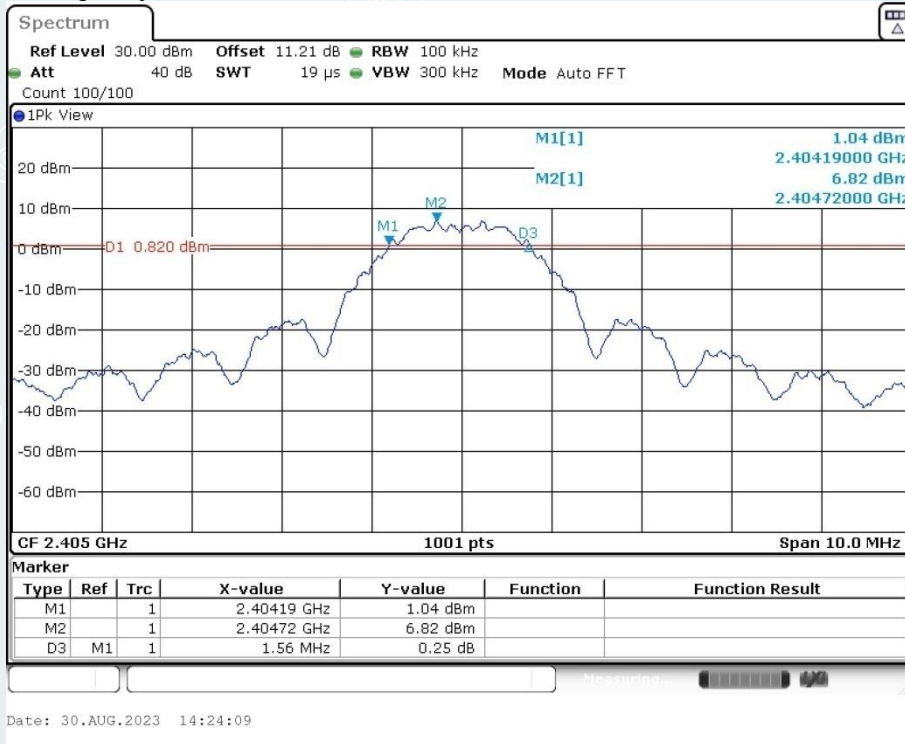

Middle Frequency (2440 MHz)

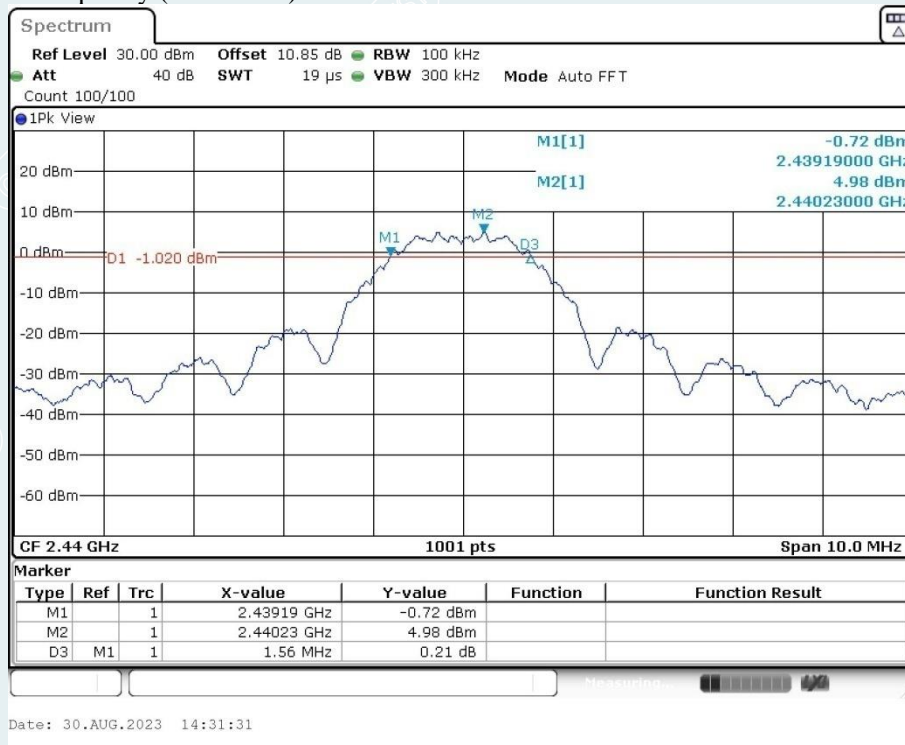

Highest Frequency (2480MHz)

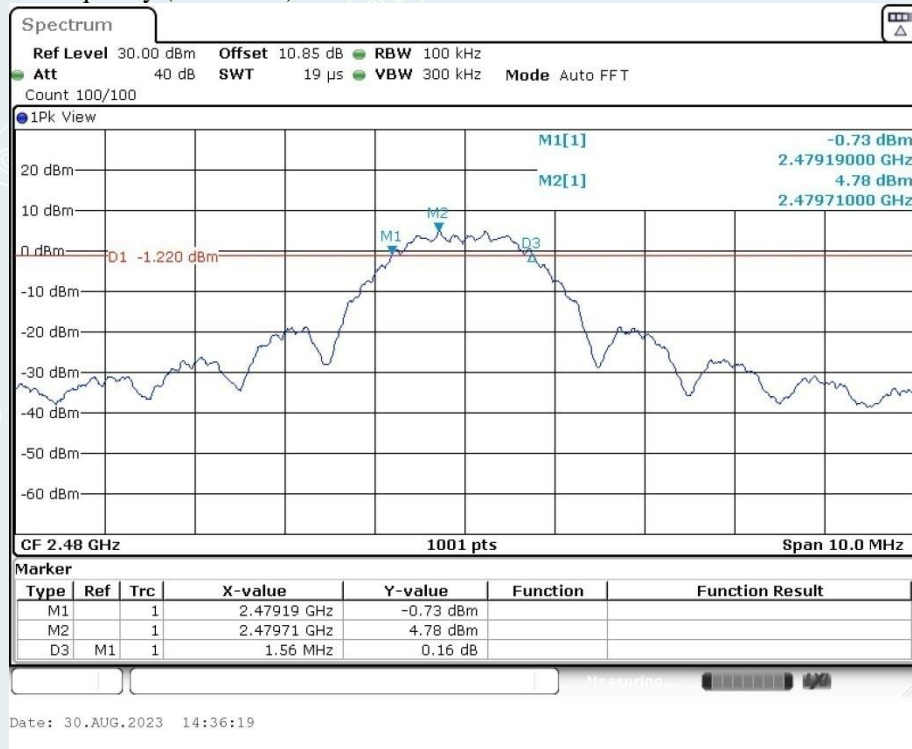

----- The following blanks -----

9. MAXIMUM PEAK OUTPUT POWER

9.1 LIMITS

The maximum Peak output power measurement is 1W

9.2 TEST PROCEDURES

- 1) According to the test mode, the channel requirements set EUT to continuous transmission mode.
- 2) Remove the antenna from the EUT and then connect a low loss RF cable from the antenna port to the power meter.

9.3 TEST SETUP

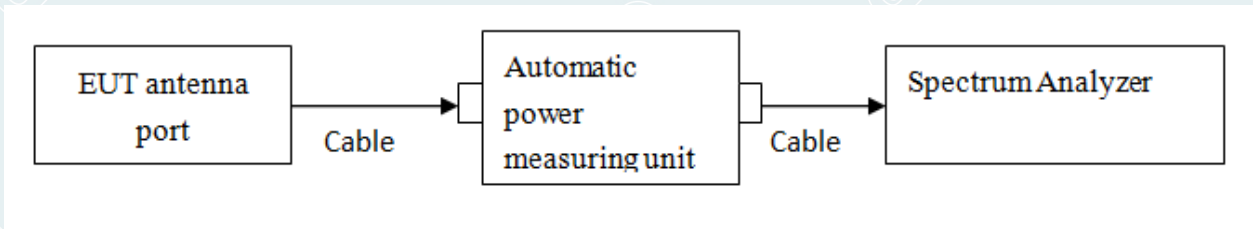

9.4 TEST RESULTS

Environment: 23.8°C/47%RH/101.0kPa
 Tested By: Qin Tingting

Voltage: DC 3V
 Date: 2023-08-30

ChName	Frequency (MHz)	Measured Channel Power (dBm)	Limit	Peak/Average	Result
Lowest	2405	8.26	1W (30dBm)	Peak	Pass
Middle	2440	8.20			Pass
Highest	2480	8.12			Pass

----- The following blanks -----

10. POWER SPECTRAL DENSITY

10.1 LIMITS

For digitally modulated systems, the power spectral density conducted from the intentional radiator to the antenna shall not be greater than 8 dBm in any 3 kHz band during any time interval of continuous transmission. This power spectral density shall be determined in accordance with the provisions of paragraph (b) of this section. The same method of determining the conducted output power shall be used to determine the power spectral density.

10.2 TEST PROCEDURES

- 1) Remove the antenna from the EUT, and then connect a low loss RF cable from antenna port to the spectrum analyzer.
- 2) Position the EUT was set without connection to measurement instrument. Turn on the EUT and connect its antenna terminal to measurement instrument via a low loss cable. Then set it to any one measured frequency within its operating range, and make sure the instrument is operated in its linear range.
- 3) The following procedure shall be used if maximum peak conducted output power was used to determine compliance, and it is optional if the maximum conducted (average) output power was used to determine compliance:
 - a) Set analyzer center frequency to DTS channel center frequency.
 - b) Set the span to 1.5 times the DTS bandwidth.
 - c) Set the RBW to $3 \text{ kHz} \leq \text{RBW} \leq 100 \text{ kHz}$.
 - d) Set the VBW $\geq [3 \times \text{RBW}]$.
 - e) Detector = peak
 - f) Sweep time = auto couple.
 - g) Trace mode = max hold.
 - h) Allow trace to fully stabilize.
 - i) Use the peak marker function to determine the maximum amplitude level within the RBW.
 - j) If measured value exceeds requirement, then reduce RBW (but no less than 3 kHz) and repeat.
- 4) Repeat above procedures until all frequencies measured were complete.

10.3 TEST SETUP

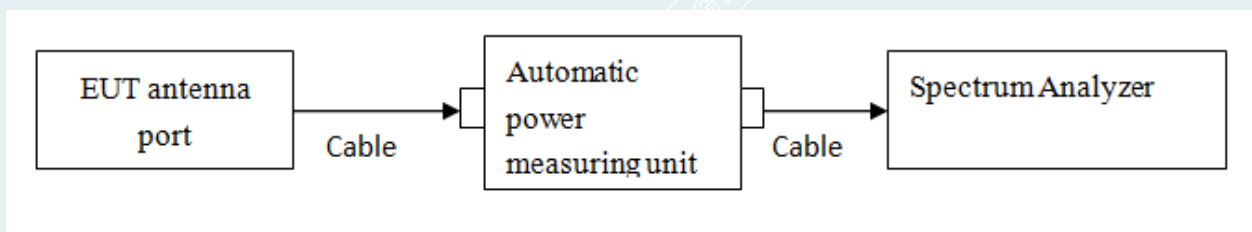

10.4 TEST RESULTS

Environment: 23.8°C/47%RH/101.0kPa
 Tested By: Qin Tingting

Voltage: DC 3V
 Date: 2023-08-30

Ch Name	Frequency (MHz)	PSD (dBm/3kHz)	Limit (dBm/3kHz)	Result
Lowest	2405	-3.84	8.00	Pass
Middle	2440	-4.11	8.00	Pass
Highest	2480	-4.31	8.00	Pass

Lowest Frequency (2405MHz)

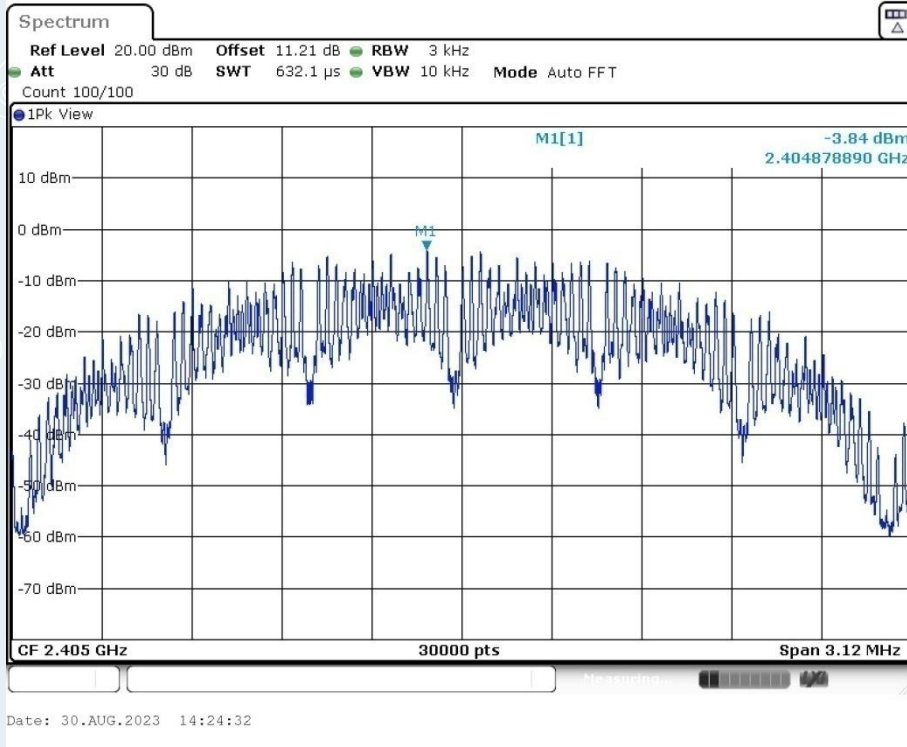

Middle Frequency (2440 MHz)

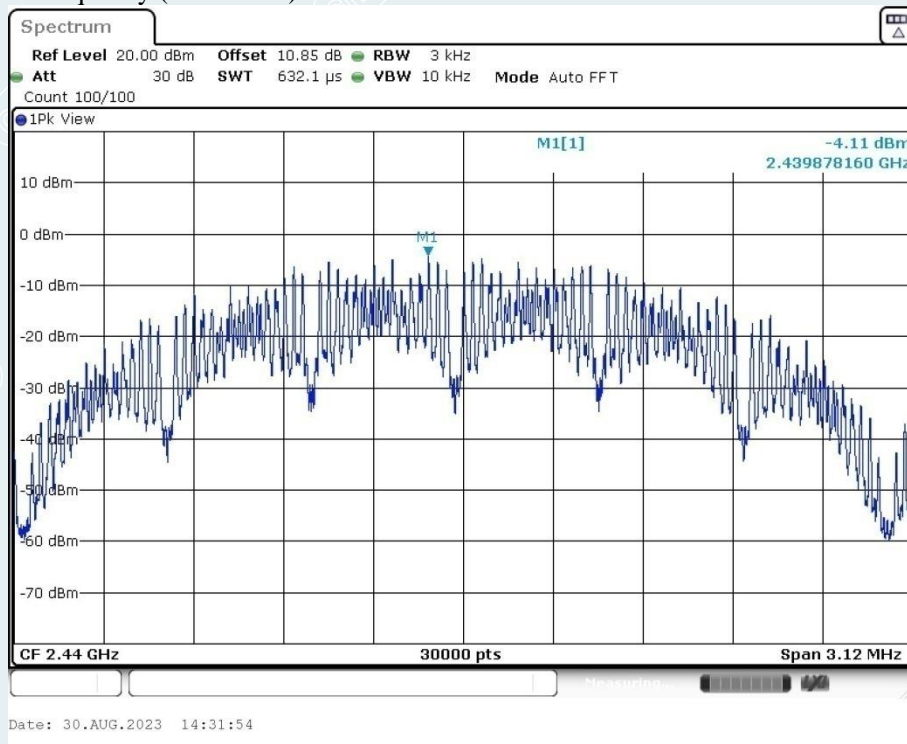

Highest Frequency (2480MHz)

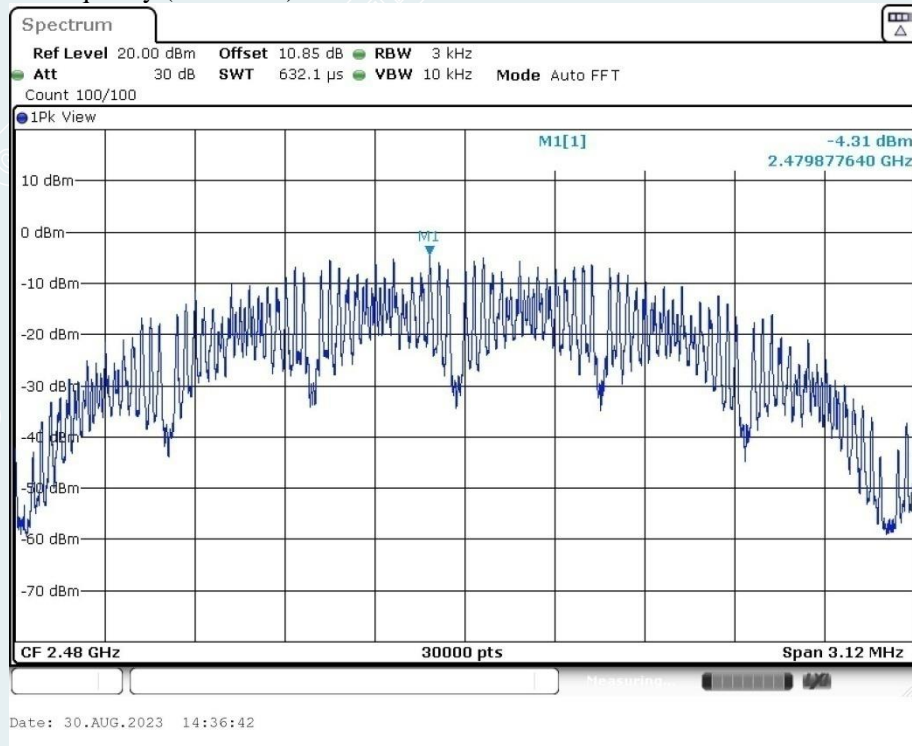

----- The following blanks -----

11. CONDUCTED BAND EDGES AND SPURIOUS EMISSIONS

11.1 LIMITS

(d) In any 100 kHz bandwidth outside the frequency band in which the spread spectrum or digitally modulated intentional radiator is operating, the radio frequency power that is produced by the intentional radiator shall be at least 20 dB below that in the 100 kHz bandwidth within the band that contains the highest level of the desired power, based on either an RF conducted or a radiated measurement, provided the transmitter demonstrates compliance with the peak conducted power limits. If the transmitter complies with the conducted power limits based on the use of RMS averaging over a time interval, as permitted under paragraph (b)(3) of this section, the attenuation required under this paragraph shall be 30 dB instead of 20 dB.

11.2 TEST PROCEDURES

Remove the antenna from the EUT and then connect a low attenuation cable from the antenna port to the spectrum.

- 1) Remove the antenna from the EUT and then connect a low attenuation cable from the antenna port to the spectrum.
- 2) Set the spectrum analyzer: RBW=100kHz; VBW=300kHz, Span=10MHz to 26.5GHz;Sweep=auto; Detector Function=Peak. Trace=Max, hold.
- 3) Measure and record the results in the test report.
- 4) The RF fundamental frequency should be excluded against the limit line in the operating frequency band.
- 5) Measurements are made from 30MHz to 26.5GHz with the transmitter set to the lowest, middle, and highest channels.

11.3 TEST SETUP

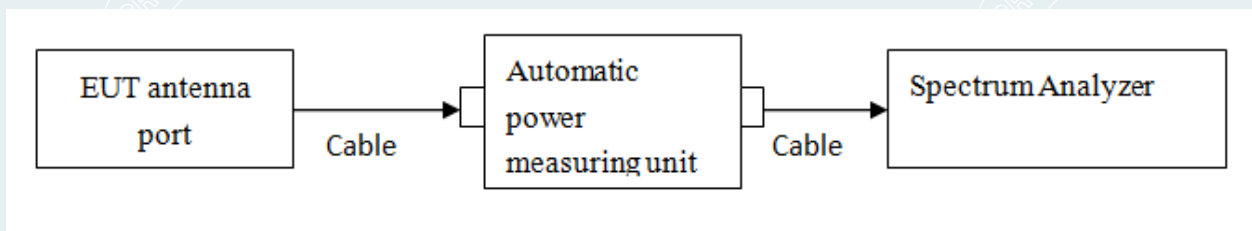

11.4 TEST RESULTS

Environment: 23.8°C/47%RH/101.0kPa

Tested By: Qin Tingting

Voltage: DC 3V

Date: 2023-08-30

Band edge

Test Mode	Antenna	Ch Name	Frequency [MHz]	Ref Level[dBm]	Result[dBm]	Limit[dBm]	Verdict
Thread	Ant1	Lowest	2405	5.15	-37.38	≤-14.85	PASS
		Highest	2480	4.87	-33.26	≤-15.13	PASS

Lowest Frequency (2405MHz)
2.35GHz-2.41GHz

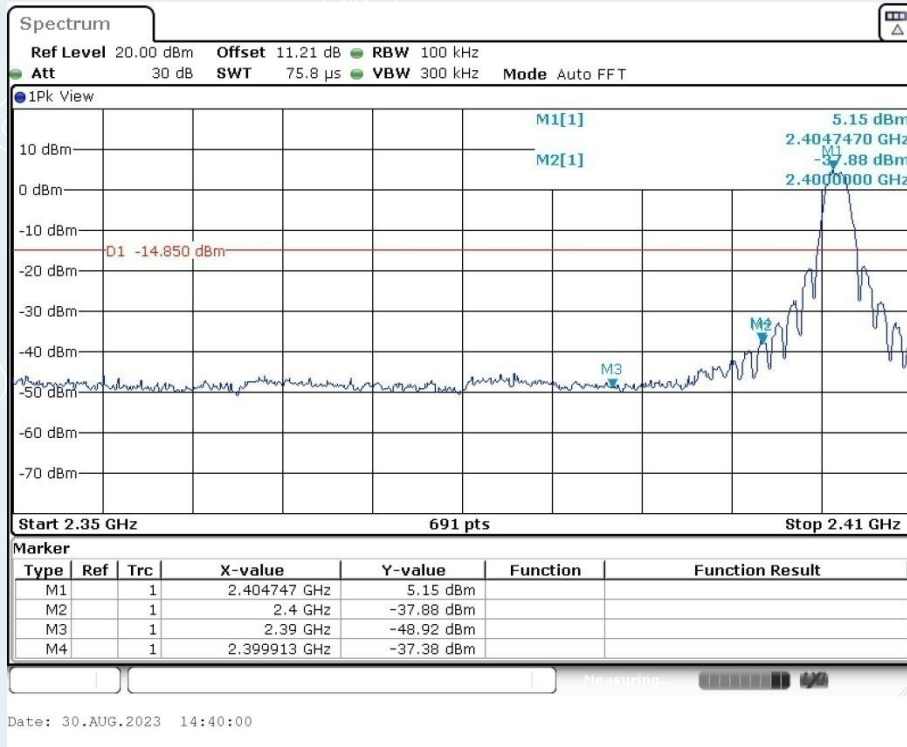

Highest Frequency (2480MHz)
2.47GHz-2.55GHz

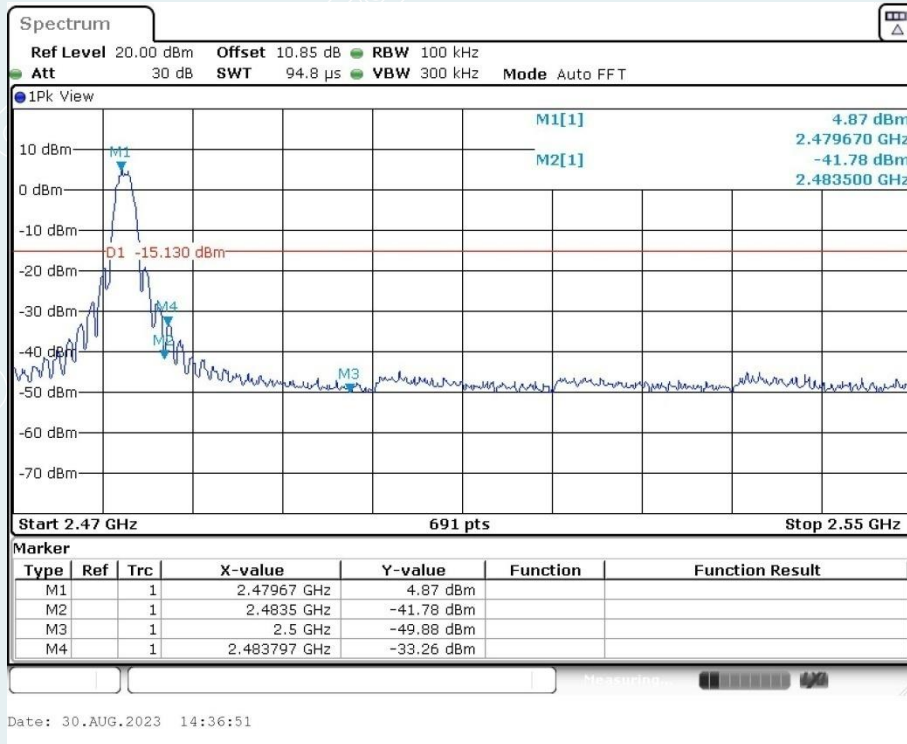

Conducted Spurious Emission

Test Mode	Antenna	Frequency [MHz]	Freq Range [MHz]	Ref Level [dBm]	Result[dBm]	Limit[dBm]	Verdict
Thread	Ant1	2405	Reference	5.30	5.30	---	PASS
			30~1000	5.30	-54.56	≤-14.7	PASS
			1000~26500	5.30	-41.77	≤-14.7	PASS
		2440	Reference	5.01	5.01	---	PASS
			30~1000	5.01	-55.62	≤-14.99	PASS
			1000~26500	5.01	-42.51	≤-14.99	PASS
		2480	Reference	4.81	4.81	---	PASS
			30~1000	4.81	-55.78	≤-15.19	PASS
			1000~26500	4.81	-42.21	≤-15.19	PASS

Lowest Frequency (2405MHz)

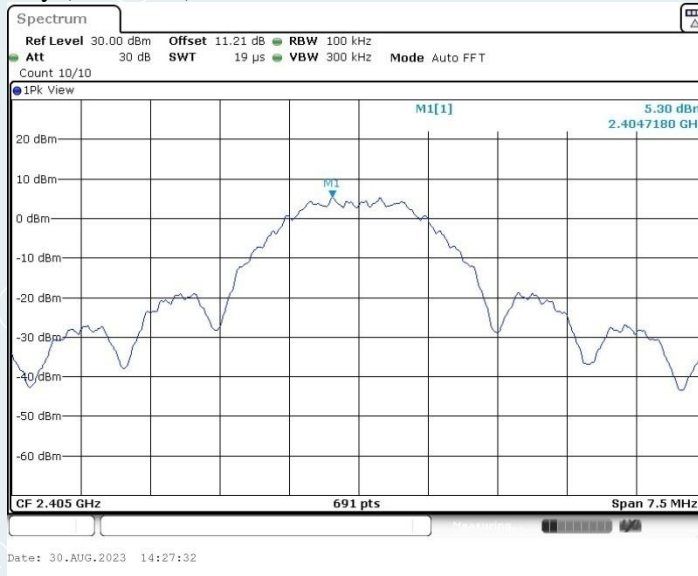

0.03GHz-1GHz

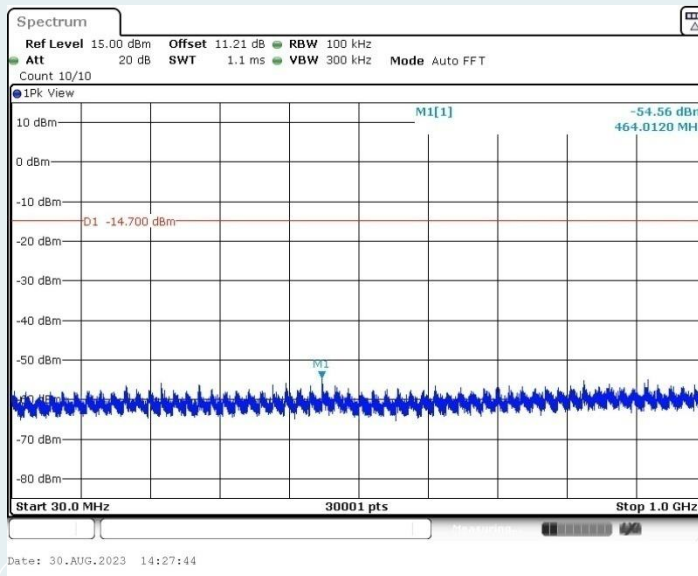

1GHz-26.5GHz

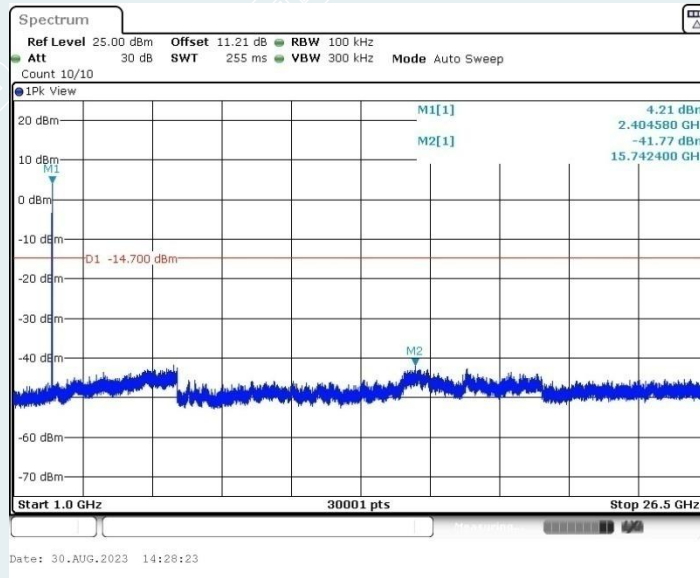

Middle Frequency (2440MHz)



0.03GHz-1GHz

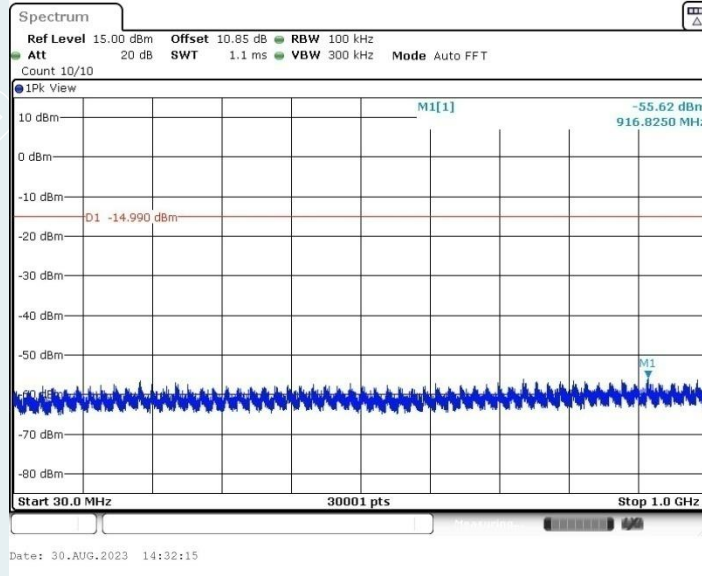

1GHz-26.5GHz

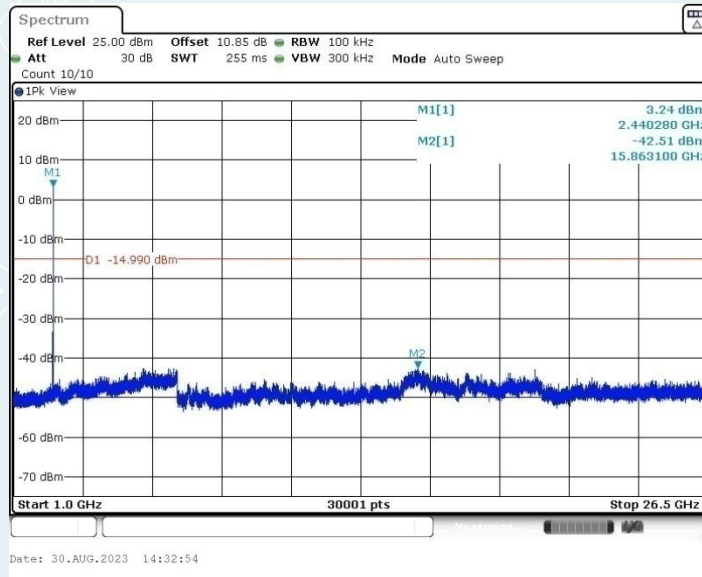

Highest Frequency (2480MHz)

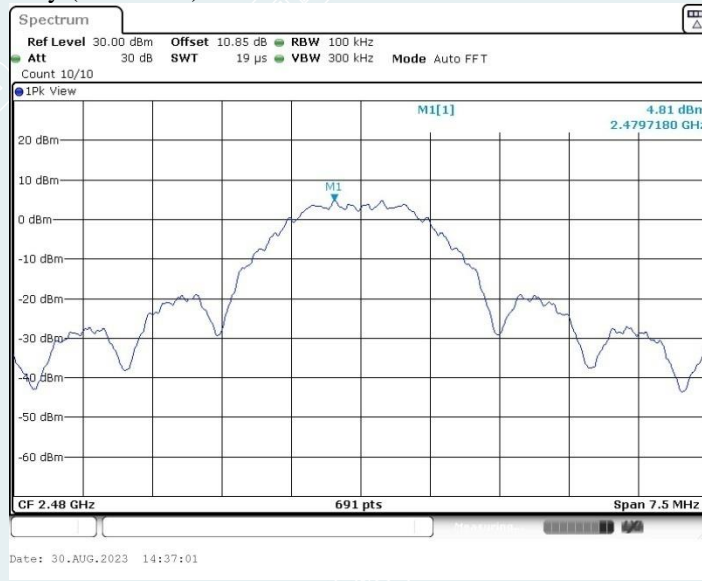

0.03GHz-1GHz

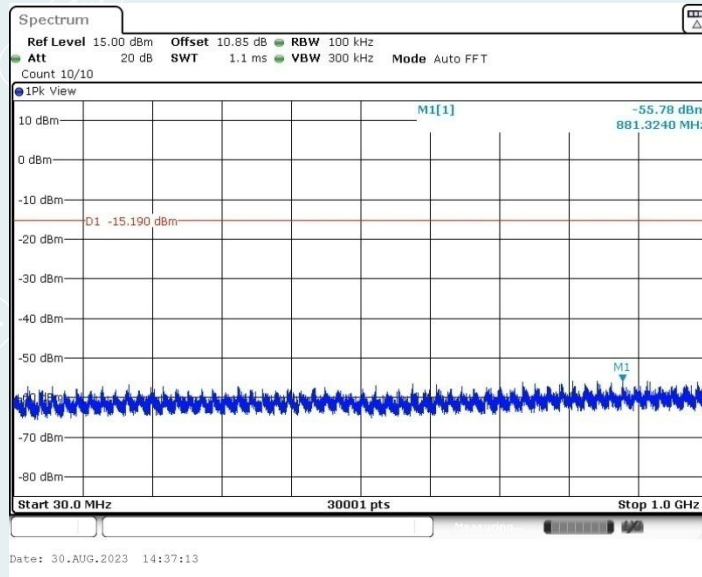

1GHz-26.5GHz

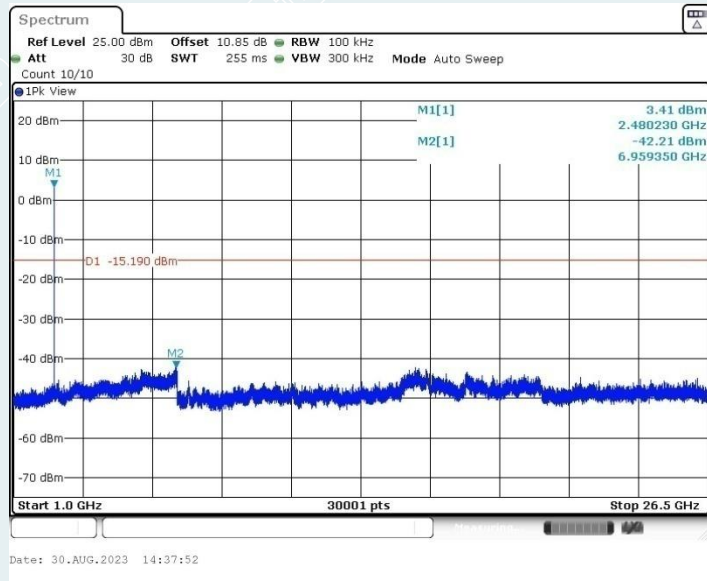

----- The following blanks -----

12. RESTRICTED BANDS OF OPERATION

12.1 LIMITS

Section 15.247(d) In addition, Radiated emissions which fall in the restricted bands, as defined in §15.205(a), must also comply with the radiated emission limits specified in §15.209(a) (see §15.205(c)).

MHz	MHz	MHz	GHz
0.090 - 0.110	16.42 - 16.423	399.9 - 410	4.5 - 5.15
0.495 - 0.505	16.69475 - 16.69525	608 - 614	5.35 - 5.46
2.1735 - 2.1905	16.80425 - 16.80475	960 - 1240	7.25 - 7.75
4.125 - 4.128	25.5 - 25.67	1300 - 1427	8.025 - 8.5
4.17725 - 4.17775	37.5 - 38.25	1435 - 1626.5	9.0 - 9.2
4.20725 - 4.20775	73 - 74.6	1645.5 - 1646.5	9.3 - 9.5
6.215 - 6.218	74.8 - 75.2	1660 - 1710	10.6 - 12.7
6.26775 - 6.26825	108 - 121.94	1718.8 - 1722.2	13.25 - 13.4
6.31175 - 6.31225	123 - 138	2200 - 2300	14.47 - 14.5
8.291 - 8.294	149.9 - 150.05	2310 - 2390	15.35 - 16.2
8.362 - 8.366	156.52475 - 156.52525	2483.5 - 2500	17.7 - 21.4
8.37625 - 8.38675	156.7 - 156.9	2655 - 2900	22.01 - 23.12
8.41425 - 8.41475	162.0125 - 167.17	3260 - 3267	23.6 - 24.0
12.29 - 12.293	167.72 - 173.2	3332 - 3339	31.2 - 31.8
12.51975 - 12.52025	240 - 285	3345.8 - 3358	36.43 - 36.5
12.57675 - 12.57725	322 - 335.4	3600 - 4400	
13.36 - 13.41			

Frequency (MHz)	Quasi-peak(μ V/m)	Measurement distance(m)	Quasi-peak(dB μ V/m)@distance 3m
0.009-0.490	2400/F(kHz)	300	128.5~93.8
0.490-1.705	24000/F(kHz)	30	73.8~63
1.705-30.0	30	30	69.5
30 ~ 88	100	3	40
88~216	150	3	43.5
216 ~ 960	200	3	46
Above 960	500	3	54

12.2 TEST PROCEDURES

- 1) The EUT is placed on a turntable, which is 1.5m above the ground plane.
- 2) The turntable shall be rotated for 360 degrees to determine the position of maximum emission level.
- 3) EUT is set 3m away from the receiving antenna, which is varied from 1m to 4m to find out the highest emission.
- 4) Set the spectrum analyzer in the following setting in order to capture the lower and upper band-edges of the emission:
 - a) For Peak detector: Set RBW=1MHz, RBW=3MHz, Sweep=AUTO.
 - b) For Avg detector: Set RBW=1MHz, Sweep=AUTO, the EUT is configured to transmit with duty cycle $\geq 98\%$, set $VBW \leq RBW/100$ (i.e., 10kHz) but not less than 10 Hz. If the EUT duty cycle is $< 98\%$, set $VBW \geq 1/T$, Where T is defined in section 2.8.
- 5) Repeat the procedures until all the PEAK and AVERAGE versus polarization are measured.

12.3 TEST SETUP

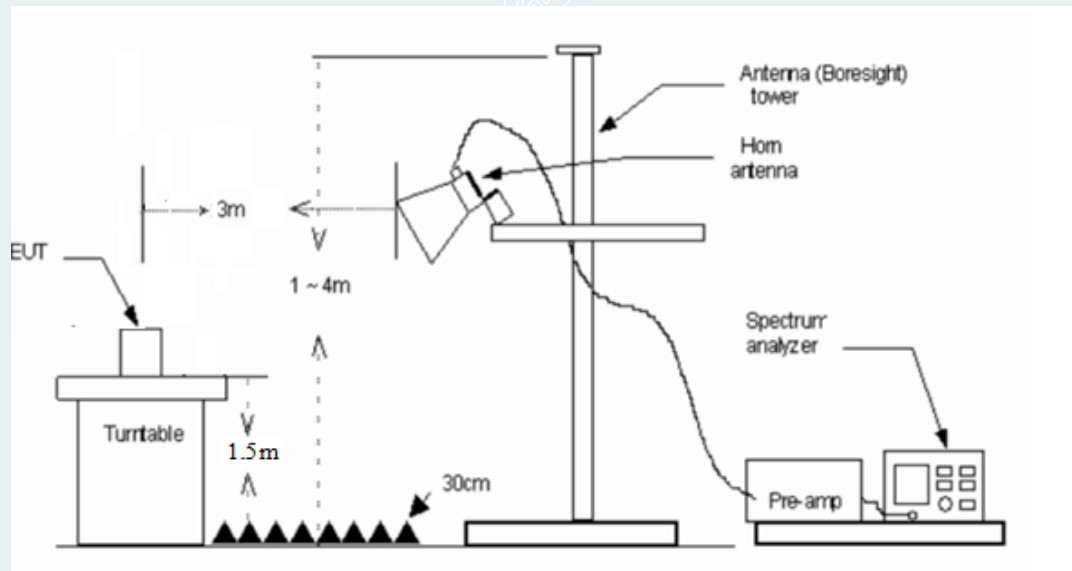

----- The following blanks -----

12.4 TEST RESULTS

The test are under 3-axes(X,Y,Z) position(X denotes lying on the table, Y denotes side stand and Z denotes vertical stand), After pre-test, It was found that the worse radiation emission was get at the Z position. So the data shown the Z position only.

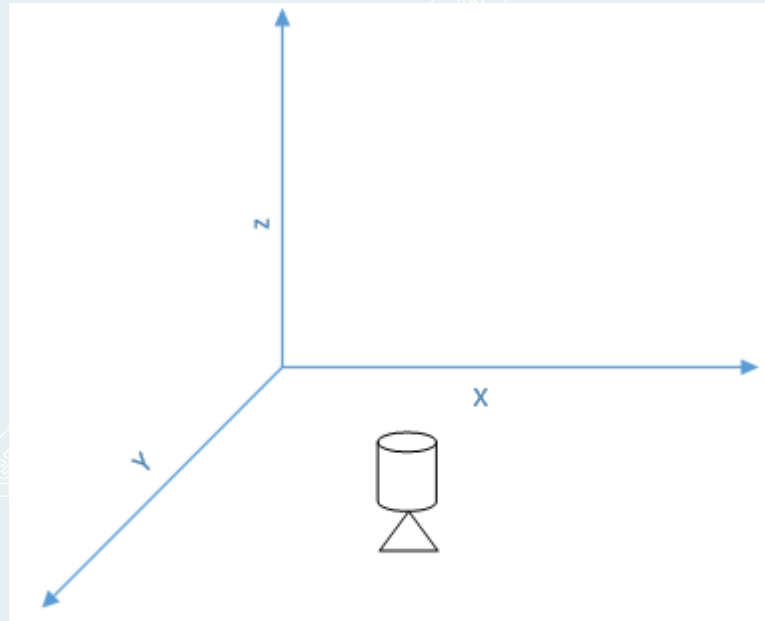

----- The following blanks -----

EUT Name:	Motion and Light Sensor P2	Test Mode:	Mode 1
Model:	ML-S03D	Sample No:	E20230828994601-0007
Test Engineer:	Zhang Zishan	Test Voltage:	DC 3V
Environmental Conditions:	25.8°C /53%RH/101.0kPa	Test Date:	2023-09-05

Lowest Channel

Frequency: 2405MHz

Detector mode: Peak

Polarity: Horizontal

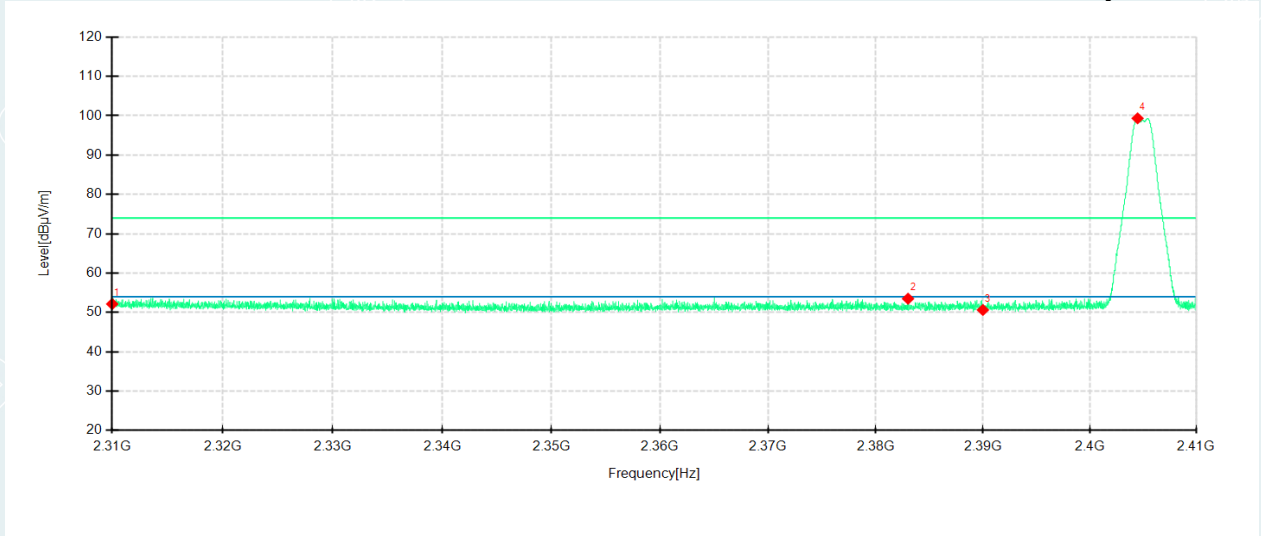

Detector mode: Peak

Polarity: Vertical

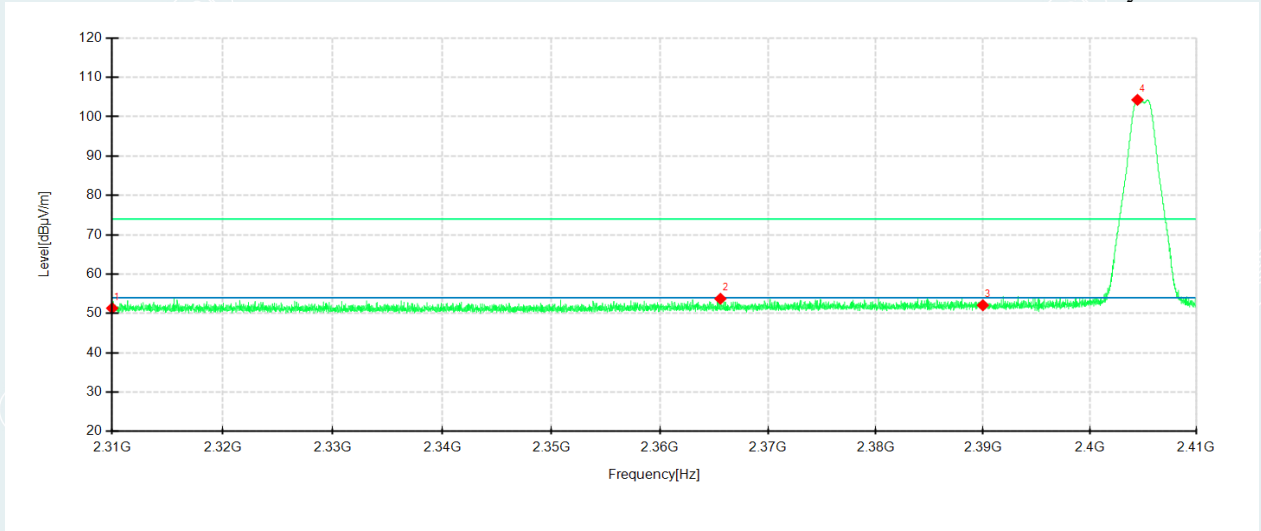

No.	Frequency MHz	Reading dB μ V/m	Level dB μ V/m	Factor dB	Limit dB μ V/m	Margin dB	Height cm	Angle °	Pole	Comment
1	2310.0000	46.56	52.15	5.59	74.00	21.85	100	38	Horizontal	/
2	2383.0125	48.75	53.49	4.74	74.00	20.51	200	154	Horizontal	/
3	2390.0000	45.83	50.63	4.80	74.00	23.37	200	75	Horizontal	
4	2404.5000	94.44	99.34	4.90	74.00	-25.34	100	206	Horizontal	No limit
1	2310.0000	46.44	51.33	4.89	74.00	22.67	100	354	Vertical	/
2	2365.6000	48.93	53.74	4.81	74.00	20.26	200	0	Vertical	/
3	2390.0000	46.86	52.08	5.22	74.00	21.92	200	206	Vertical	/
4	2404.4875	98.88	104.29	5.41	74.00	-30.29	100	215	Vertical	No limit

----- The following blanks -----

Lowest Channel

Frequency: 2405MHz

Detector mode: Average

Polarity: Horizontal

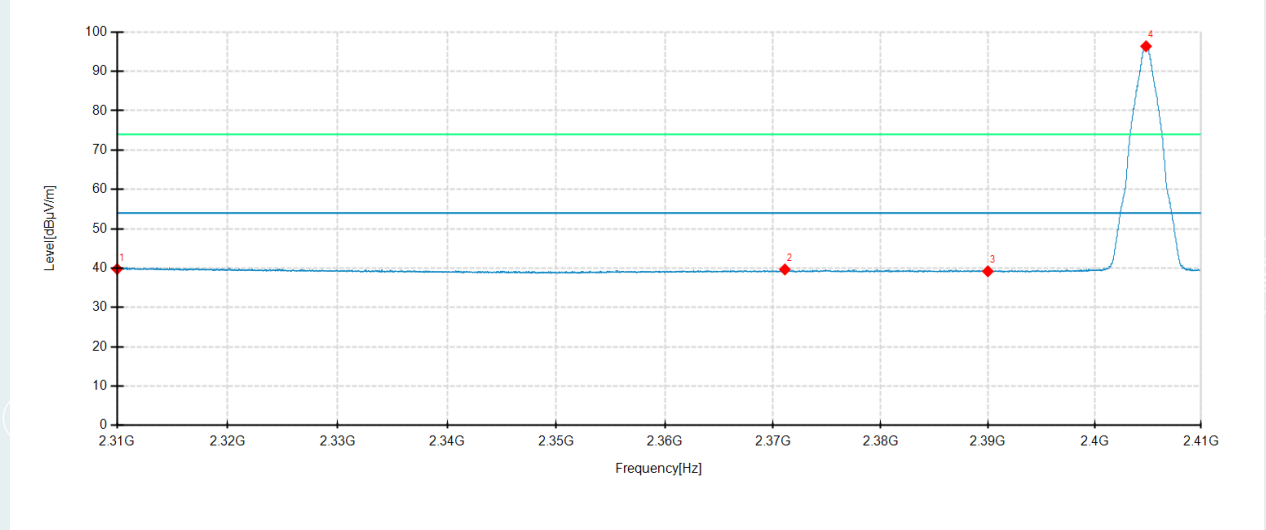

Detector mode: Average

Polarity: Vertical

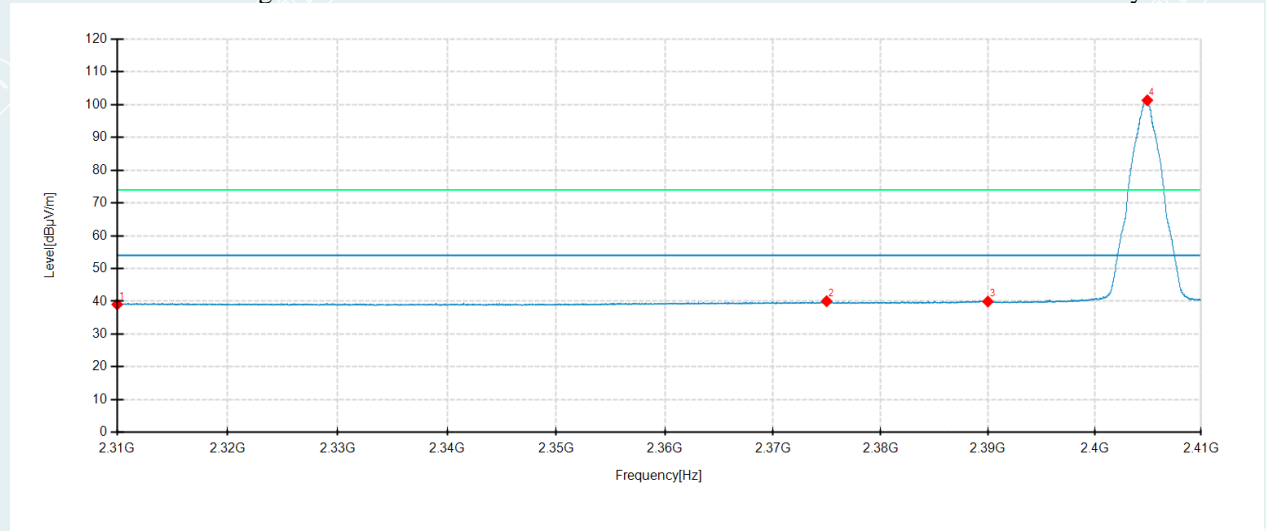

No.	Frequency MHz	Reading dBμV/m	Level dBμV/m	Factor dB	Limit dBuV/m	Margin dB	Height cm	Angle °	Pole	Comment
1	2310.0000	34.18	39.77	5.59	54.00	14.23	100	18	Horizontal	/
2	2371.1000	35.02	39.66	4.64	54.00	14.34	100	136	Horizontal	/
3	2390.0000	34.38	39.18	4.80	54.00	14.82	200	175	Horizontal	/
4	2404.8250	91.48	96.38	4.90	54.00	-42.38	100	206	Horizontal	No limit
1	2310.0000	34.16	39.05	4.89	54.00	14.95	100	216	Vertical	/
2	2374.9750	35.06	40.03	4.97	54.00	13.97	200	26	Vertical	/
3	2390.0000	34.72	39.94	5.22	54.00	14.06	100	154	Vertical	/
4	2404.9500	95.91	101.32	5.41	54.00	-47.32	100	216	Vertical	No limit

Highest Channel

Frequency: 2480MHz

Detector mode: Peak

Polarity: Horizontal

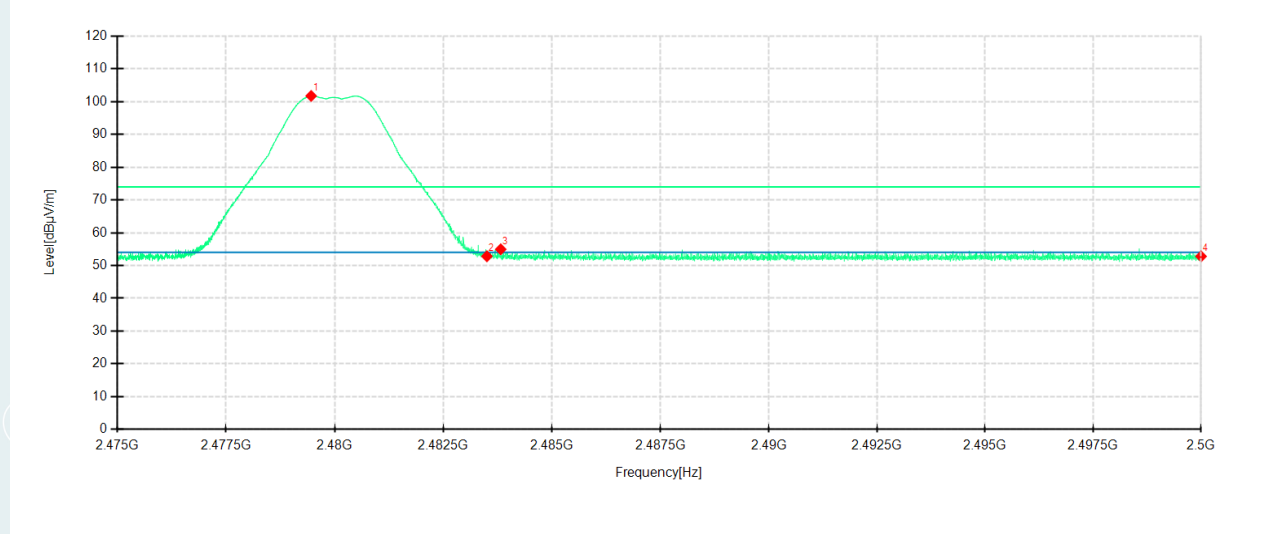

Detector mode: Peak

Polarity: Vertical

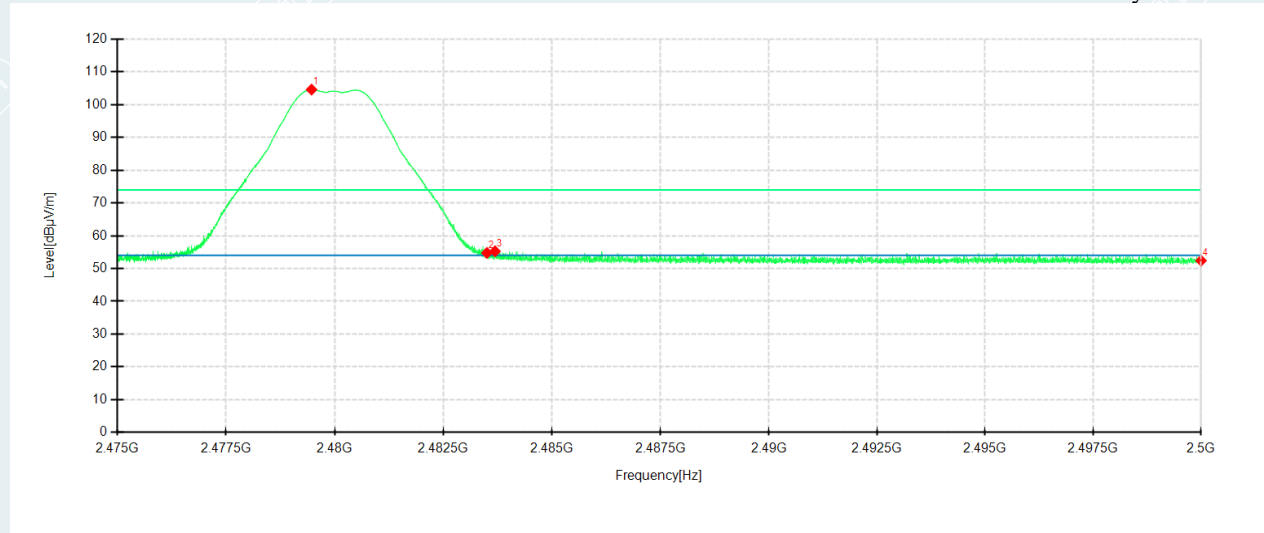

No.	Frequency MHz	Reading dBμV/m	Level dBμV/m	Factor dB	Limit dBuV/m	Margin dB	Height cm	Angle °	Pole	Comment
1	2479.4563	96.17	101.73	5.56	74.00	-27.73	100	205	Horizontal	No limit
2	2483.5000	47.20	52.83	5.63	74.00	21.17	100	244	Horizontal	/
3	2483.8188	49.31	54.95	5.64	74.00	19.05	100	77	Horizontal	/
4	2500.0000	46.90	52.80	5.90	74.00	21.20	100	77	Horizontal	/
1	2479.4656	98.90	104.59	5.69	74.00	-30.59	100	215	Vertical	No limit
2	2483.5000	49.07	54.77	5.70	74.00	19.23	100	85	Vertical	/
3	2483.6875	49.56	55.26	5.70	74.00	18.74	100	346	Vertical	/
4	2500.0000	46.71	52.41	5.70	74.00	21.59	100	236	Vertical	/

Highest Channel

Frequency: 2480MHz

Detector mode: Average

Polarity: Horizontal

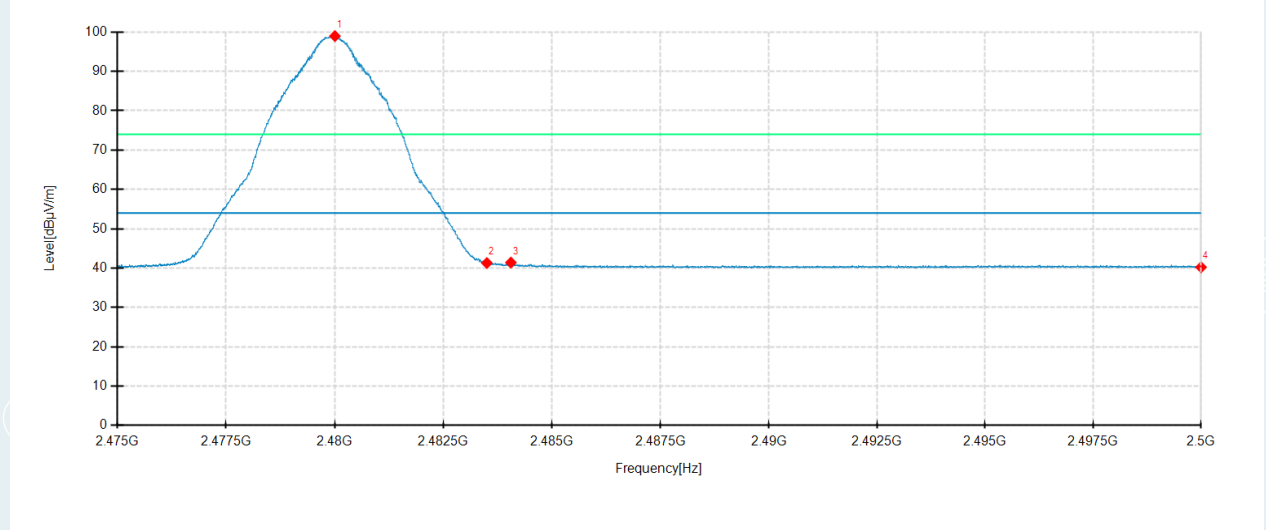

Detector mode: Average

Polarity: Vertical

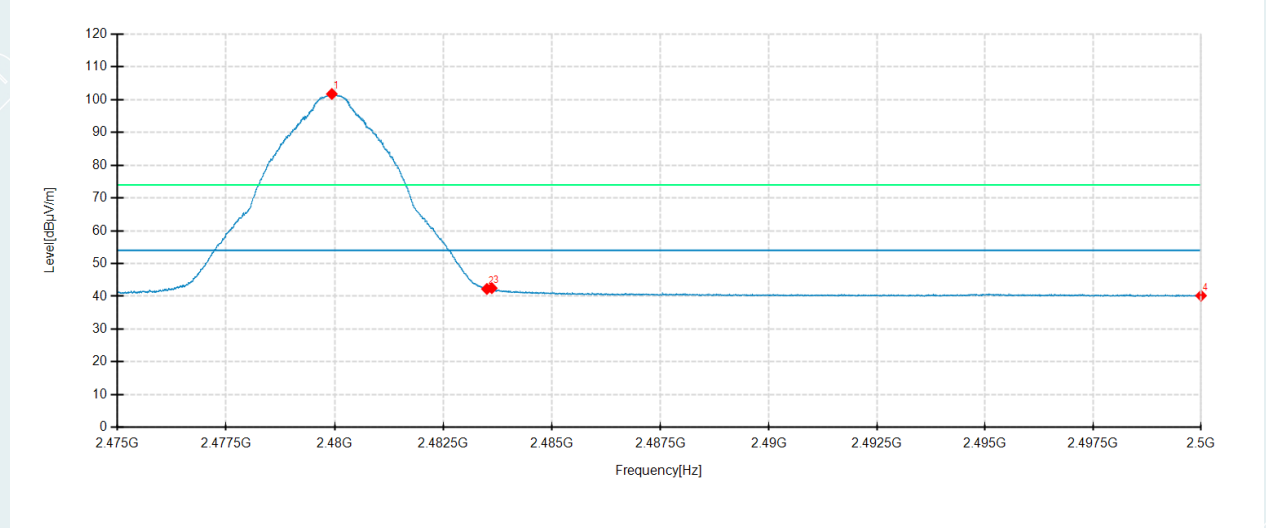

No.	Frequency MHz	Reading dBµV/m	Level dBµV/m	Factor dB	Limit dBµV/m	Margin dB	Height cm	Angle °	Pole	Comment
1	2480.0031	93.40	98.97	5.57	54.00	-44.97	100	206	Horizontal	No limit
2	2483.5000	35.66	41.29	5.63	54.00	12.71	100	76	Horizontal	/
3	2484.0531	35.76	41.40	5.64	54.00	12.60	100	76	Horizontal	/
4	2500.0000	34.32	40.22	5.90	54.00	13.78	200	46	Horizontal	/
1	2479.9313	96.03	101.72	5.69	54.00	-47.72	100	223	Vertical	No limit
2	2483.5000	36.55	42.25	5.70	54.00	11.75	100	44	Vertical	/
3	2483.6125	36.80	42.50	5.70	54.00	11.50	100	214	Vertical	/
4	2500.0000	34.49	40.19	5.70	54.00	13.81	200	65	Vertical	/

Remark: Max field strength in 3m distance. No any other emission which falls in restricted bands can be detected and be reported.

APPENDIX A. PHOTOGRAPH OF THE TEST CONNECTION DIAGRAM

Please refer to the attached document E20230828994601-15 Test Photo.

APPENDIX B. PHOTOGRAPH OF THE EUT

Please refer to the attached document E20230828994601-16 EUT photo.

----- End of Report -----