

Test Report

Verified code: 995242

Report No.: E20230331478001-12

Customer: Lumi United Technology Co., Ltd

Address: B1, Chongwen Park, Nanshan iPark, Liuxian Avenue, Taoyuan Residential District,
Nanshan District, Shenzhen, China

Sample Name: Hub M3

Sample Model: HM-G01E

Receive Sample Date: Aug.02,2023

Test Date: Nov.29,2023 ~ Dec.18,2023

Reference Document: 47 CFR, FCC Part 15 Subpart C
RADIO FREQUENCY DEVICES:Subpart C—Intentional Radiators

Test Result: Pass

Prepared by: Chen Xiacong
Chen Xiacong

Reviewed by: Jiang Tao
Jiang Tao

Approved by: Xiao Liang
Xiao Liang

GRG METROLOGY & TEST GROUP CO., LTD.

Issued Date: 2024-01-09

GRG METROLOGY & TEST GROUP CO., LTD.

Address: No.163,Pingyun Road, West of Huangpu Avenue, Guangzhou, Guangdong, China
Tel: (+86) 400-602-0999 FAX: (+86) 020-38698685 Web: <http://www.grgtest.com>



Statement

1. The report is invalid without "special seal for inspection and testing"; some copies are invalid; The report is invalid if it is altered or missing; The report is invalid without the signature of the person who prepared, reviewed and approved it.
2. The sample information is provided by the client and responsible for its authenticity; The content of the report is only valid for the samples sent this time.
3. When there are reports in both Chinese and English, the Chinese version will prevail when the language problems are inconsistent.
4. If there is any objection concerning the report, please inform us within 15 days from the date of receiving the report.
5. Without the agreement of the laboratory, the client is not authorized to use the test results for unapproved propaganda.

----- The following blanks -----

TABLE OF CONTENTS

1.	TEST RESULT SUMMARY	6
2.	GENERAL DESCRIPTION OF EUT	7
2.1	APPLICANT	7
2.2	MANUFACTURER	7
2.3	BASIC DESCRIPTION OF EQUIPMENT UNDER TEST	7
2.4	CHANNEL LIST	8
2.5	TEST OPERATION MODE	8
2.6	LOCAL SUPPORTIVE	8
2.7	CONFIGURATION OF SYSTEM UNDER TEST	9
2.8	DUTY CYCLE	10
3.	LABORATORY AND ACCREDITATIONS	11
3.1	LABORATORY	11
3.2	ACCREDITATIONS	11
4.	MEASUREMENT UNCERTAINTY	12
5.	LIST OF USED TEST EQUIPMENT AT GRGT	13
6.	CONDUCTED EMISSION MEASUREMENT	14
7.1	LIMITS	14
7.2	TEST PROCEDURES	14
7.3	TEST SETUP	15
7.4	DATA SAMPLE	15
7.5	TEST RESULTS	16
7.	RADIATED SPURIOUS EMISSIONS	18
8.1	LIMITS	18
8.2	TEST PROCEDURES	18
8.3	TEST SETUP	21
8.4	DATA SAMPLE	23
8.5	TEST RESULTS	24
8.	6DB BANDWIDTH	30
9.1	LIMITS	30
9.2	TEST PROCEDURES	30
9.3	TEST SETUP	30
9.4	TEST RESULTS	30
9.	MAXIMUM PEAK OUTPUT POWER	33
10.1	LIMITS	33
10.2	TEST PROCEDURES	33
10.3	TEST SETUP	33
10.4	TEST RESULTS	33
10.	POWER SPECTRAL DENSITY	34
11.1	LIMITS	34
11.2	TEST PROCEDURES	34
11.3	TEST SETUP	34
11.4	TEST RESULTS	35
11.	CONDUCTED BAND EDGES AND SPURIOUS EMISSIONS	37
12.1	LIMITS	37
12.2	TEST PROCEDURES	37
12.3	TEST SETUP	37
12.4	TEST RESULTS	37

12. RESTRICTED BANDS OF OPERATION	44
13.1 LIMITS.....	44
13.2 TEST PROCEDURES.....	45
13.3 TEST SETUP	45
13.4 TEST RESULTS	46
APPENDIX A. PHOTOGRAPH OF THE TEST CONNECTION DIAGRAM.....	51
APPENDIX B. PHOTOGRAPH OF THE EUT.....	51

----- The following blanks -----

REPORT ISSUED HISTORY

Report Version	Report No.	Description	Compile Date
1.0	E20230331478001-12	Original Issue	2023-12-22

----- The following blanks -----

1. TEST RESULT SUMMARY

Technical Requirements		
47 CFR, FCC Part 15 Subpart C (§15.247) ANSI C63.10-2020 KDB 558074 D01 15.247 measurement guidance v05r02		
Limit / Severity	Item	Result
§15.247(b)(3)	Maximum peak output power	Pass
§15.207 (a)	Conducted Emissions	Pass
§15.247(e)	Power spectral density	Pass
§15.247(a)(2)	6dB bandwidth	Pass
§15.247(d)& §15.205& §15.209	Restricted bands of operation	Pass
§15.247(d)	Conducted band edges and spurious emissions	Pass
§15.247(d) & §15.209 & §15.205	Radiated spurious emissions	Pass
§15.203	Antenna requirement	Pass

Note:

1)The EUT has one antenna. The antenna is PIFA antenna, the max gain of antenna is 0.5dBi.which accordance 15.203.is considered sufficient to comply with the provisions of this section.

----- The following blanks -----

2. GENERAL DESCRIPTION OF EUT

2.1 APPLICANT

Name: Lumi United Technology Co., Ltd
Address: B1, Chongwen Park, Nanshan iPark, Liuxian Avenue, Taoyuan Residential District, Nanshan District, Shenzhen, China

2.2 MANUFACTURER

Name: Lumi United Technology Co., Ltd
Address: B1, Chongwen Park, Nanshan iPark, Liuxian Avenue, Taoyuan Residential District, Nanshan District, Shenzhen, China

2.3 BASIC DESCRIPTION OF EQUIPMENT UNDER TEST

Equipment: Hub M3
Model No.: HM-G01E
Adding Model: HM-G01D
Models Difference: The model NO. HM-G01E & HM-G01D have the same technical construction including circuit diagram, PCB LAYOUT, hardware version and software version identical, except sales area and packaging are different.
Trade Name: Aqara
FCC ID: 2AKIT-HMG01
Power Supply: DC 5V/2A or PoE input 48V/0.27A
Frequency Range: 2405MHz-2475MHz
Transmit Power: 6.72dBm
Modulation type: O-QPSK
Antenna Specification: PIFA antenna 0.5dBi gain (Max.)
Temperature Range: -10 °C ~ 50 °C
Hardware Version: V2.0.5_1060
Software Version: T0
Sample No: E20230331478001-0002, E20230331478001-0006

Note 1: The EUT antenna gain is provided by the applicant. This report is made solely on the basis of such data and/or information. We accept no responsibility for the authenticity and completeness of the above data and information and the validity of the results and/or conclusions.

Note 2: All the tests were performed on the model HM-G01E.

2.4 CHANNEL LIST

Channel No.	Frequency (MHz)	Channel No.	Frequency (MHz)	Channel No.	Frequency (MHz)	Channel No.	Frequency (MHz)
*11	2405	12	2410	13	2415	14	2420
15	2425	16	2430	17	2435	*18	2440
19	2445	20	2450	21	2455	22	2460
23	2465	24	2470	*25	2475	/	/

* is the test frequency

2.5 TEST OPERATION MODE

Mode No.	Description of the modes
1	Thread fixed frequency transmitting

2.6 LOCAL SUPPORTIVE

Name of Equipment	Manufacturer	Model	Serial Number	Note
Notebook	LENOVO	TianYi 310-14ISK	MP18DLC6	/
Test board	/	/	/	/
Adapter	Jian Aohai	A70-050200U-EU1	/	/
PoE Adapter	UE	PoE35-54A	/	/

No.	Cable Type	Qty.	Shielded Type	Ferrite Core(Qty.)	Length
1	Serial cable	1	No	0	0.3m
2	USB-MINI cable	1	Yes	0	1.0m
3	USB-C cable	1	Yes	0	0.8m
4	RJ45 cable	1	No	0	1.5m

Note :The notebook is just used to produce fixed frequency transmitting.

----- The following blanks -----

2.7 CONFIGURATION OF SYSTEM UNDER TEST

For 6 dB Bandwidth & Maximum Peak Output Power & Power Spectral Density & Conducted band edges and Spurious Emission



For Conducted Emissions Measurement & Restricted bands of operation & Radiated Spurious Emission



Test software:

Software version	Test level
QCOM_V1.0	2405MHz: 8 2440MHz: 8 2475MHz: 8

----- The following blanks -----

2.8 DUTY CYCLE

Environment: 27.1 °C/49%RH/101.0kPa
 Tested By: Huang Tianmei

Voltage: DC 5V
 Date: 2023-11-29

Test Mode	Antenna	Frequency (MHz)	Transmission Duration [ms]	Transmission Period [ms]	Duty Cycle [%]	T [s]
Thread	Ant3	2405	50.00	50.00	100	/
		2440	50.00	50.00	100	/
		2475	50.00	50.00	100	/

Lowest_2405MHz

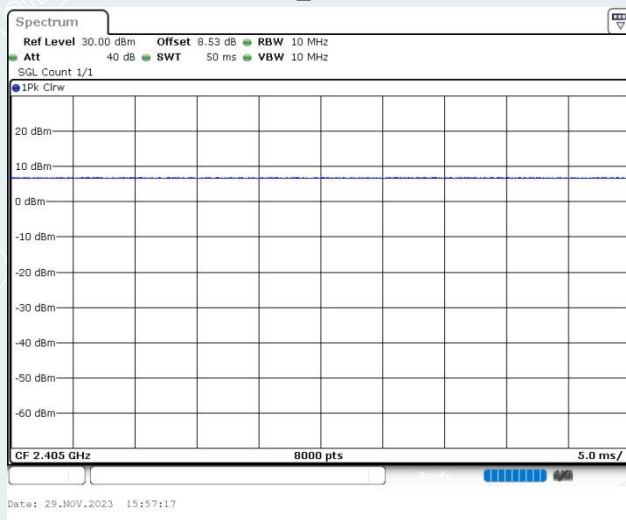

Middle_2440MHz

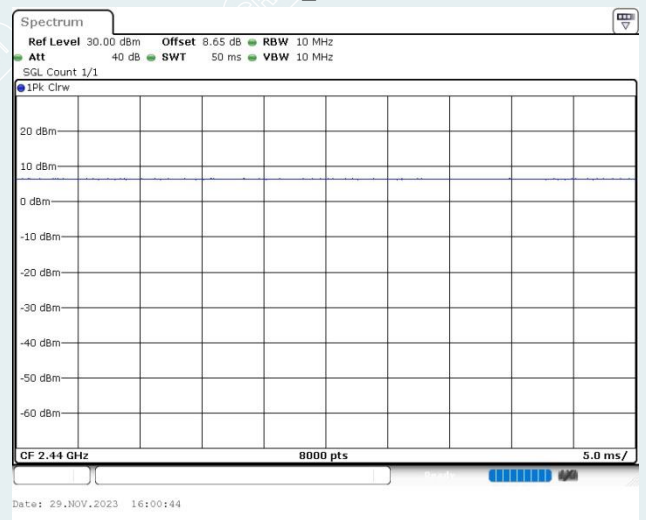

Highest_2475MHz

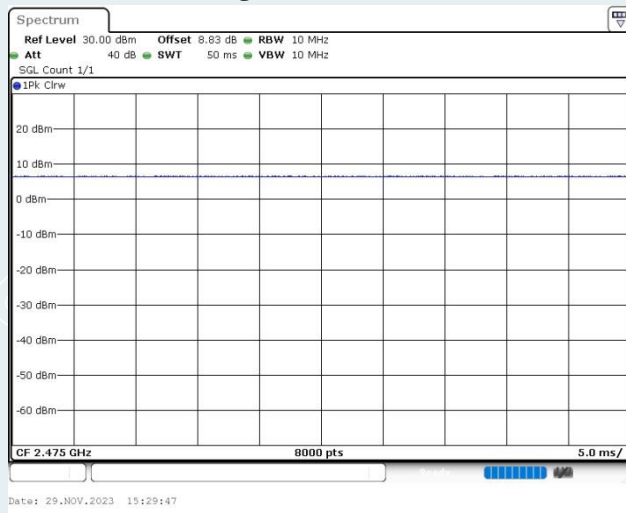

3. LABORATORY AND ACCREDITATIONS

3.1 LABORATORY

The tests & measurements refer to this report were performed by Shenzhen EMC Laboratory of GRG METROLOGY & TEST GROUP CO., LTD.

Add : No.1301 Guanguang Road Xinlan Community, Guanlan Street, Longhua District
Shenzhen, 518110, People's Republic of China

P.C. : 518110

Tel : 0755-61180008

Fax : 0755-61180008

3.2 ACCREDITATIONS

Our laboratories are accredited and approved by the following approval agencies according to ISO/IEC 17025:2017.

USA A2LA(Certificate #2861.01)

The measuring facility of laboratories has been authorized or registered by the following approval agencies.

Canada ISED (Company Number: 24897, CAB identifier:CN0069)

USA FCC (Registration Number: 759402, Designation Number:CN1198)

Copies of granted accreditation certificates are available for downloading from our web site,
<http://www.grgtest.com>

----- The following blanks -----

4. MEASUREMENT UNCERTAINTY

Where relevant, the following measurement uncertainty levels have been estimated for tests performed on the EUT as specified in CISPR 16-4-2:

Measurement		Frequency	Uncertainty
Radiated Emission	Coplanar	9kHz~30MHz	4.4dB ¹⁾
	Coaxial	9kHz~30MHz	4.4dB ¹⁾
	Horizontal	30MHz~200MHz	4.6dB ¹⁾
		200MHz~1000MHz	4.8dB ¹⁾
		1GHz~18GHz	5.0dB ¹⁾
		18GHz~26.5GHz	5.2dB ¹⁾
	Vertical	30MHz~200MHz	4.7dB ¹⁾
		200MHz~1000MHz	4.7dB ¹⁾
		1GHz~18GHz	5.1dB ¹⁾
		18GHz~26.5GHz	5.4dB ¹⁾
Conduction Emission		150kHz~30MHz	3.3dB ¹⁾

Measurement	Uncertainty
RF frequency	6.0×10^{-6}
RF power conducted	0.80dB
Power spectral density conducted	0.80dB
Occupied channel bandwidth	0.40dB
Unwanted emission, conducted	0.70dB
Humidity	6.0%
Temperature	2.0°C

Note:

¹⁾ This uncertainty represents an expanded uncertainty expressed at approximately the 95%.

This uncertainty represents an expanded uncertainty factor of $k=2$.

5. LIST OF USED TEST EQUIPMENT AT GRGT

Name of Equipment	Manufacturer	Model	Serial Number	Calibration Due
Radiated Spurious Emission&Restricted bands of operation				
Test S/W	EZ	CCS-03A1		
Loop Antenna	Schwarzbeck	FMZB 1513-60	1513-60-56	2024-07-15
Preamplifier	SHIRONG ELECTRONIC	DLNA-30M1G-G 41	20200928002	2024-10-24
Bi-log Antenna	Schwarzbeck	VULB9160	VULB9160-3402	2024-10-06
Horn Antenna	Schwarzbeck	BBHA 9120D	02143	2024-09-23
Test Receiver	R&S	ESR26	101758	2024-09-22
Board-Band Horn Antenna	Schwarzbeck	BBHA 9170	BBHA 9170-497	2024-09-18
Amplifier	Tonscend	TAP01018048	AP20E8060075	2024-04-11
Amplifier	Tonscend	TAP184050	AP20E806071	2024-04-16
Amplifier	SHIRONG ELECTRONIC	DLNA-1G18G-G 40	20200928005	2024-08-17
Test S/W	Tonscend	JS36-RE/2.5.1.5		
6dB Bandwidth&Conducted band edges and Spurious Emission&Power Spectral Density				
Spectrum Analyzer	R&S	FSV30	104381	2024-10-13
Automatic power measuring unit	TONSCEND	JS0806-2	21B8060365	2023-11-17
BT/WIFI System	Tonscend	JS1120-3		
Maximum Peak Output Power				
Pulse power sensor	Anristu	MA2411B	1126150	2024-02-12
Power meter	Anristu	ML2495A	1204003	2024-02-12
Conducted Emissions				
EZ-EMC	EZ	CCS-3A1-CE	/	/
EMI Receiver	R&S	ESCI	100783	2024-08-11
LISN(EUT)	R&S	ENV216	101543	2024-09-10

Note:

1. The calibration cycle of the above instruments is 12 months.

6. CONDUCTED EMISSION MEASUREMENT

7.1 LIMITS

Frequency range	Limits (dB μ V)	
	Quasi-peak	Average
150kHz~0.5MHz	66~56	56~46
0.5MHz~5MHz	56	46
5MHz~30MHz	60	50

NOTE: (1) The lower limit shall apply at the transition frequencies.

(2) The limit decreases in line with the logarithm of the frequency in the range of 150 kHz to 0.5MHz.

7.2 TEST PROCEDURES

Procedure of Preliminary Test

Test procedures follow ANSI C63.10:2020.

For measurement of the disturbance voltage the equipment under test (EUT) is connected to the power supply mains and any other extended network via one or more artificial network(s). An EUT, whether intended to be grounded or not, and which is to be used on a table is configured as follows:

- a) Either the bottom or the rear of the EUT shall be at a controlled distance of 40 cm from a reference ground plane. This ground plane is normally the wall or floor of a shielded room. It may also be a grounded metal plane of at least 2 m by 2 m. This is physically accomplished as follows:
 - 1) Place the EUT on a table of non-conducting material which is at least 80 cm high. Place the EUT so that it is 40 cm from the wall of the shielded room, or
 - 2) Place the EUT on a table of non-conducting material which is 40 cm high so that the bottom of the EUT is 40 cm above the ground plane;
- b) All other conductive surfaces of the EUT shall be at least 80 cm from the reference ground plane;
- c) The EUT are placed on the floor that one side of the housings is 40 cm from the vertical reference ground plane and other metallic parts;
- d) Interconnecting cables that hang closer than 40 cm to the ground plane shall be folded back and forth forming a bundle 30 cm to 40 cm long, hanging approximately in the middle between the ground plane and the table.
- e) I/O cables that are connected to a peripheral shall be bundled in the centre. The end of the cable may be terminated if required using correct terminating impedance. The total length shall not exceed 1 m.
- f) Use serial board or connecting line to make EUT and notebook to communicate, according to the actual need to make EUT send constant frequency signal continuously.

The test mode(s) described in Item 2.5 were scanned during the preliminary test. After the preliminary scan, we found the test mode described in Item 2.5 producing the highest emission level. The EUT configuration and cable configuration of the above highest emission levels were recorded for reference of the final test.

Procedure of Final Test

EUT and support equipment were set up on the test bench as per the configuration with highest emission level in the preliminary test. A scan was taken on both power lines, recording at least the six highest emissions. Emission frequency and amplitude were recorded into a computer in which correction factors were used to calculate the emission level and compare reading to the applicable limit. The test data of the worst-case condition(s) was recorded.

7.3 TEST SETUP

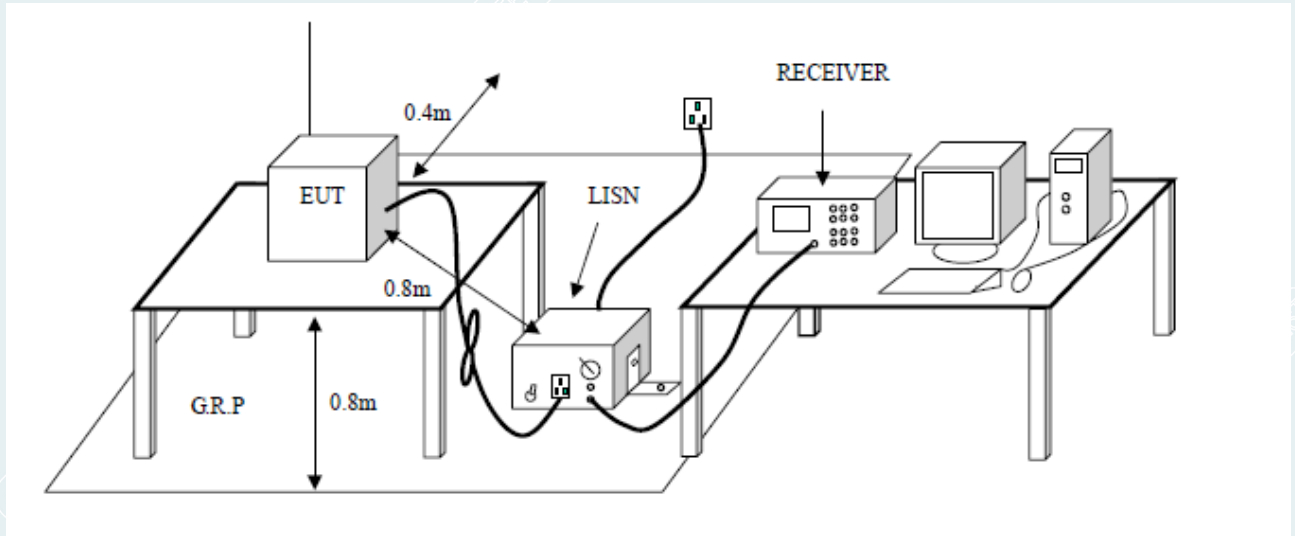

7.4 DATA SAMPLE

Frequency (MHz)	QuasiPeak Reading (dBuV)	Average Reading (dBuV)	Correction Factor (dB)	QuasiPeak Result (dBuV)	Average Result (dBuV)	QuasiPeak Limit (dBuV)	Average Limit (dBuV)	QuasiPeak Margin (dB)	Average Margin (dB)	Remark (Pass/Fail)
X.XXXX	32.69	25.65	11.52	44.21	37.17	65.78	55.79	-21.57	-18.62	Pass

- Correction factor = Insertion loss of LISN + Cable Loss
- Result = QuasiPeak Reading/ Average Reading + Correction factor
- Limit = Limit stated in standard
- Margin = Result (dBuV) – Limit (dBuV)

----- The following blanks -----

7.5 TEST RESULTS

Note: Pre-scan all modes, the worst power supply is AC 120/60Hz(DC 5V/2A power by Adapter). In the two power supply modes, only the worst case(Thread_2405MHz) in the worst power supply is recorded, in this report.

Power supply: AC 120V/60Hz (DC 5V/2A power by Adapter)

Project No	E20230331478001	EUT:	Hub M3
Model:	HM-G01E	Sample No:	E20230331478001-0006
Mode:	Thread_2405MHz	Voltage:	AC 120V/60Hz
Environment:	24.2°C/52%RH/101.0kPa	Engineer:	Chen Zexin
Test Date:	2023-12-13	Line	L

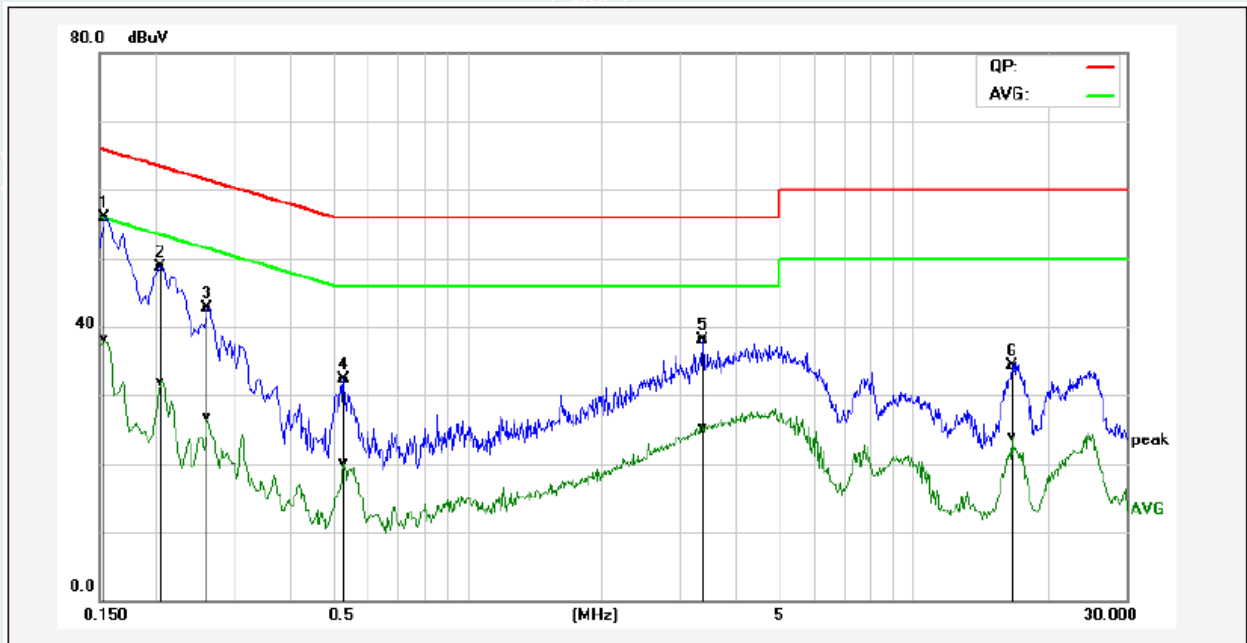

No.	Frequency (MHz)	QuasiPeak reading (dBuV)	Average reading (dBuV)	Correction factor (dB)	QuasiPeak result (dBuV)	Average result (dBuV)	QuasiPeak limit (dBuV)	Average limit (dBuV)	QuasiPeak margin (dB)	Average margin (dB)	Remark
1*	0.1539	46.18	28.29	9.74	55.92	38.03	65.78	55.79	-9.86	-17.76	Pass
2	0.2060	39.08	22.24	9.69	48.77	31.93	63.36	53.37	-14.59	-21.44	Pass
3	0.2620	33.04	17.04	9.69	42.73	26.73	61.36	51.37	-18.63	-24.64	Pass
4	0.5299	22.52	10.42	9.70	32.22	20.12	56.00	46.00	-23.78	-25.88	Pass
5	3.3660	28.26	15.17	9.92	38.18	25.09	56.00	46.00	-17.82	-20.91	Pass
6	16.5740	24.42	13.87	9.97	34.39	23.84	60.00	50.00	-25.61	-26.16	Pass

Project No	E20230331478001	EUT:	Hub M3
Model:	HM-G01E	Sample No:	E20230331478001-0006
Mode:	Thread_2405MHz	Voltage:	AC 120V/60Hz
Environment:	24.2°C/52%RH/101.0kPa	Engineer:	Chen Zexin
Test Date:	2023-12-13	Line	N

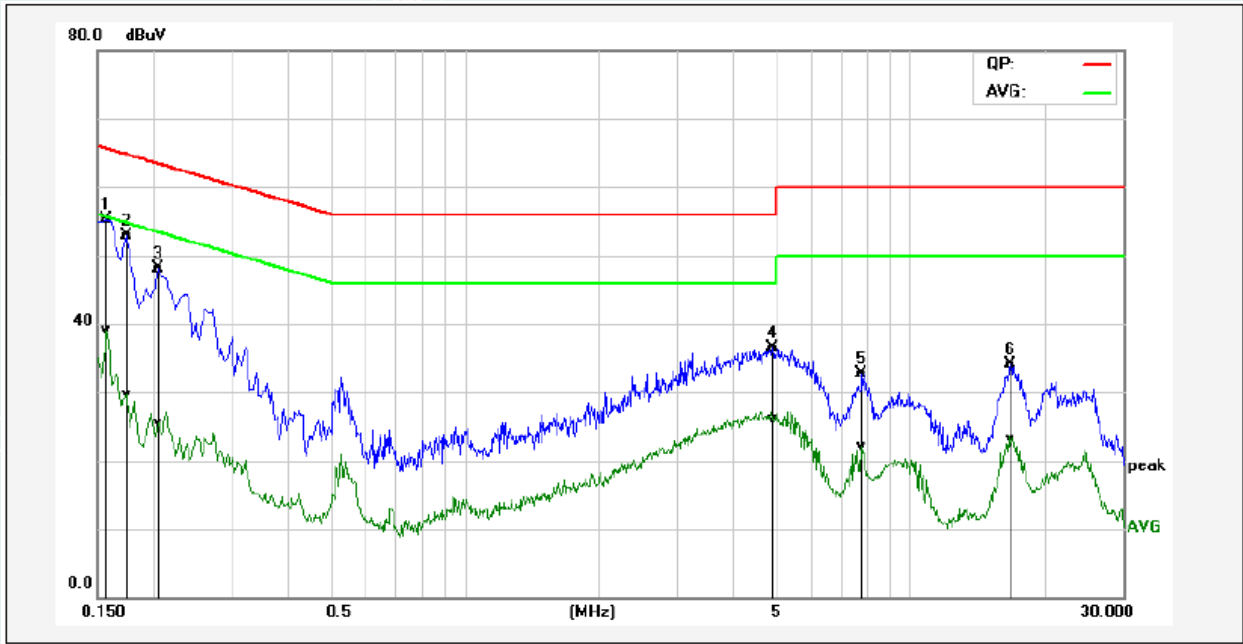

No.	Frequency (MHz)	QuasiPeak reading (dBuV)	Average reading (dBuV)	Correction factor (dB)	QuasiPeak result (dBuV)	Average result (dBuV)	QuasiPeak limit (dBuV)	Average limit (dBuV)	QuasiPeak margin (dB)	Average margin (dB)	Remark
1*	0.1580	45.55	29.47	9.68	55.23	39.15	65.56	55.57	-10.33	-16.42	Pass
2	0.1740	43.29	20.10	9.66	52.95	29.76	64.76	54.77	-11.81	-25.01	Pass
3	0.2060	38.37	15.78	9.67	48.04	25.45	63.36	53.37	-15.32	-27.92	Pass
4	4.9100	26.68	16.41	9.77	36.45	26.18	56.00	46.00	-19.55	-19.82	Pass
5	7.7740	22.89	12.30	9.84	32.73	22.14	60.00	50.00	-27.27	-27.86	Pass
6	16.7780	23.97	12.97	10.12	34.09	23.09	60.00	50.00	-25.91	-26.91	Pass

7. RADIATED SPURIOUS EMISSIONS

8.1 LIMITS

In any 100 kHz bandwidth outside the frequency band in which the spread spectrum or digitally modulated intentional radiator is operating, the radio frequency power that is produced by the intentional radiator shall be at least 20 dB below that in the 100 kHz bandwidth within the band that contains the highest level of the desired power, based on either an RF conducted or a radiated measurement, provided the transmitter demonstrates compliance with the peak conducted power limits. If the transmitter complies with the conducted power limits based on the use of RMS averaging over a time interval, as permitted under paragraph (b)(3) of this section, the attenuation required under this paragraph shall be 30 dB instead of 20 dB. Attenuation below the general limits specified in §15.209(a) is not required.

Frequency (MHz)	Quasi-peak($\mu\text{V}/\text{m}$)	Measurement distance(m)	Quasi-peak($\text{dB}\mu\text{V}/\text{m}$)@distance 3m
0.009-0.490	2400/F(kHz)	300	128.5~93.8
0.490-1.705	24000/F(kHz)	30	73.8~63
1.705-30.0	30	30	69.5
30~88	100	3	40
88~216	150	3	43.5
216~960	200	3	46
Above 960	500	3	54

NOTE: (1) The lower limit shall apply at the transition frequencies.

(2) Above 18GHz test distance is 1m, so the Peak Limit= $74+20*\log(3/1)=83.54$ ($\text{dB}\mu\text{V}/\text{m}$).

The Avg Limit= $54+20*\log(3/1)=63.54$ ($\text{dB}\mu\text{V}/\text{m}$).

8.2 TEST PROCEDURES

a) Sequence of testing 9kHz to 30MHz

Setup:

--- The equipment was set up to simulate a typical usage like described in the user manual or described by manufacturer.

--- If the EUT is a tabletop system, a rotatable table with 0.8 m height is used.

--- If the EUT is a floor standing device, it is placed on the ground.

--- Use serial board or connecting line to make EUT and notebook to communicate, according to the actual need to make EUT send constant frequency signal continuously.

--- The EUT is placed on a desktop position in the center of the turntable.

--- The measurement distance is 3 meter.

--- The EUT was set into operation.

Pre measurement:

--- The turntable rotates from 0° to 360° .

--- The antenna height is 1.0 meter.

--- At each turntable position the analyzer sweeps with peak detection to find the maximum of all emissions.

Final measurement:

--- Identified emissions during the pre measurement the software maximizes by rotating the turntable position (0° to 360°) and by rotating the elevation axes (0° to 360°).

--- The final measurement will be done in the position (turntable and elevation) causing the highest

emissions with QP detector.

--- The final levels, frequency, measuring time, bandwidth, turntable position, correction factor, margin to the limit and limit will be recorded. Also a plot with the graph of the pre measurement and the limit will be stored.

b) Sequence of testing 30MHz to 1GHz

Setup:

--- The equipment was set up to simulate a typical usage like described in the user manual or described by manufacturer.

--- If the EUT is a tabletop system, a table with 0.8 m height is used, which is placed on the ground plane.

--- If the EUT is a floor standing device, it is placed on the ground plane with insulation between both.

--- Use serial board or connecting line to make EUT and notebook to communicate, according to the actual need to make EUT send constant frequency signal continuously.

--- The EUT is placed on a desktop position in the center of the turntable.

--- The measurement distance is 3 meter.

--- The EUT was set into operation.

Pre measurement:

--- The turntable rotates from 0 ° to 360 °.

--- The antenna is polarized vertical and horizontal.

--- The antenna height changes from 1 to 4 meter.

--- At each turntable position, antenna polarization and height the analyzer sweeps three times in peak to find the maximum of all emissions.

Final measurement:

--- The final measurement will be performed with minimum the six highest peaks.

--- According to the maximum antenna and turntable positions of pre measurement the software maximize the peaks by changing turntable rotates from 0 ° to 360 ° and antenna movement between 1 and 4 meter.

--- The final measurement will be done with QP detector with an EMI receiver.

--- The final levels, frequency, measuring time, bandwidth, antenna height, antenna polarization, turntable angle, correction factor, margin to the limit and limit will be recorded. Also a plot with the graph of the pre measurement with marked maximum final measurements and the limit will be stored.

c) Sequence of testing 1GHz to 18GHz

Setup:

--- The equipment was set up to simulate a typical usage like described in the user manual or described by manufacturer.

--- If the EUT is a tabletop system, a rotatable table with 1.5 m height is used.

--- If the EUT is a floor standing device, it is placed on the ground plane with insulation between both.

--- Use serial board or connecting line to make EUT and notebook to communicate, according to the actual need to make EUT send constant frequency signal continuously.

--- The EUT is placed on a desktop position in the center of the turntable.

--- The measurement distance is 3 meter.

--- The EUT was set into operation.

Pre measurement:

- The turntable rotates from 0 ° to 360 °.
- The antenna is polarized vertical and horizontal.
- The antenna height scan range is 1 meter to 4 meter.
- At each turntable position and antenna polarization the analyzer sweeps with peak detection to find the maximum of all emissions.

Final measurement:

- The final measurement will be performed with minimum the six highest peaks.
- According to the maximum antenna and turntable positions of pre measurement the software maximize the peaks by changing turntable rotates from 0 ° to 360 ° and antenna movement between 1 and 4 meter. This procedure is repeated for both antenna polarizations.
- The final measurement will be done in the position (turntable, EUT-table and antenna polarization) causing the highest emissions with Peak and Average detector.
- The final levels, frequency, measuring time, bandwidth, turntable position, EUT-table position, antenna polarization, correction factor, margin to the limit and limit will be recorded. Also a plot with the graph of the pre measurement with marked maximum final measurements and the limit will be stored.

**d) Sequence of testing above 18GHz
Setup:**

- The equipment was set up to simulate a typical usage like described in the user manual or described by manufacturer.
- If the EUT is a tabletop system, a rotatable table with 1.5 m height is used.
- If the EUT is a floor standing device, it is placed on the ground plane with insulation between both.
- Use serial board or connecting line to make EUT and notebook to communicate, according to the actual need to make EUT send constant frequency signal continuously.
- The EUT is placed on a desktop position in the center of the turntable.
- The measurement distance is 1 meter.
- The EUT was set into operation.

Pre measurement:

- The turntable rotates from 0 ° to 360 °.
- The antenna is polarized vertical and horizontal.
- The antenna height scan range is 1 meter to 4 meter.
- At each turntable position and antenna polarization the analyzer sweeps with peak detection to find the maximum of all emissions.

Final measurement:

- The final measurement will be performed with minimum the six highest peaks.
- According to the maximum antenna and turntable positions of pre measurement the software maximize the peaks by changing turntable rotates from 0 ° to 360 ° and antenna movement between 1 and 4 meter. This procedure is repeated for both antenna polarizations.
- The final measurement will be done in the position (turntable, EUT-table and antenna polarization) causing the highest emissions with Peak and Average detector.
- The final levels, frequency, measuring time, bandwidth, turntable position, EUT-table position, antenna polarization, correction factor, margin to the limit and limit will be recorded. Also a plot with the graph of the pre measurement with marked maximum final measurements and the limit will be stored.

NOTE:

- (1).The frequency from 9kHz to 150kHz, Set RBW=300Hz(for Peak&AVG), RBW=300Hz(for Peak&AVG).
the frequency from 150kHz to 30MHz, Set RBW=9kHz, RBW=9kHz, (for QP Detector).
- (2).The frequency from 30MHz to 1GHz, Set RBW=120kHz, RBW=300kHz, (for QP Detector).
- (3).The frequency above 1GHz, for Peak detector: Set RBW=1MHz, RBW=3MHz.
- (4).The frequency above 1GHz, for Avg detector: Set RBW=1MHz, the EUT is configured to transmit with duty cycle \geq 98%, set VBW \leq RBW/100 (i.e.,10kHz) but not less than 10 Hz. If the EUT duty cycle is $<$ 98% , set VBW \geq 1/T, Where T is defined in section 2.8.

8.3 TEST SETUP

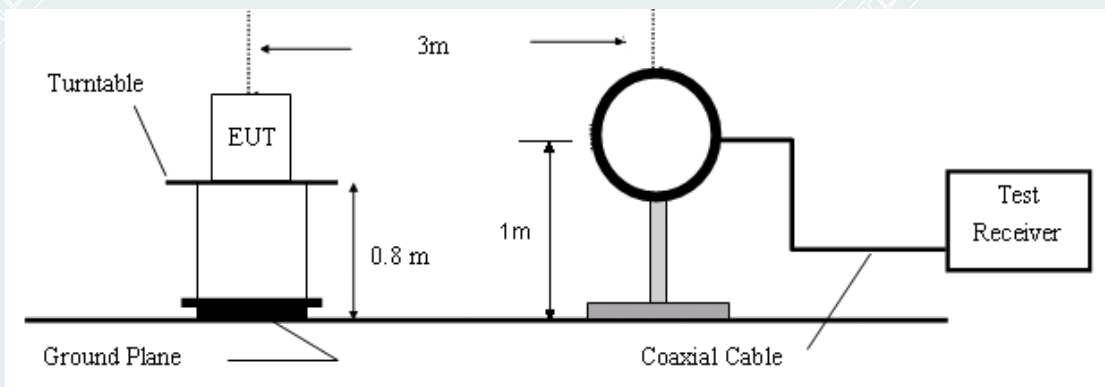

Figure 1. 9kHz to 30MHz radiated emissions test configuration

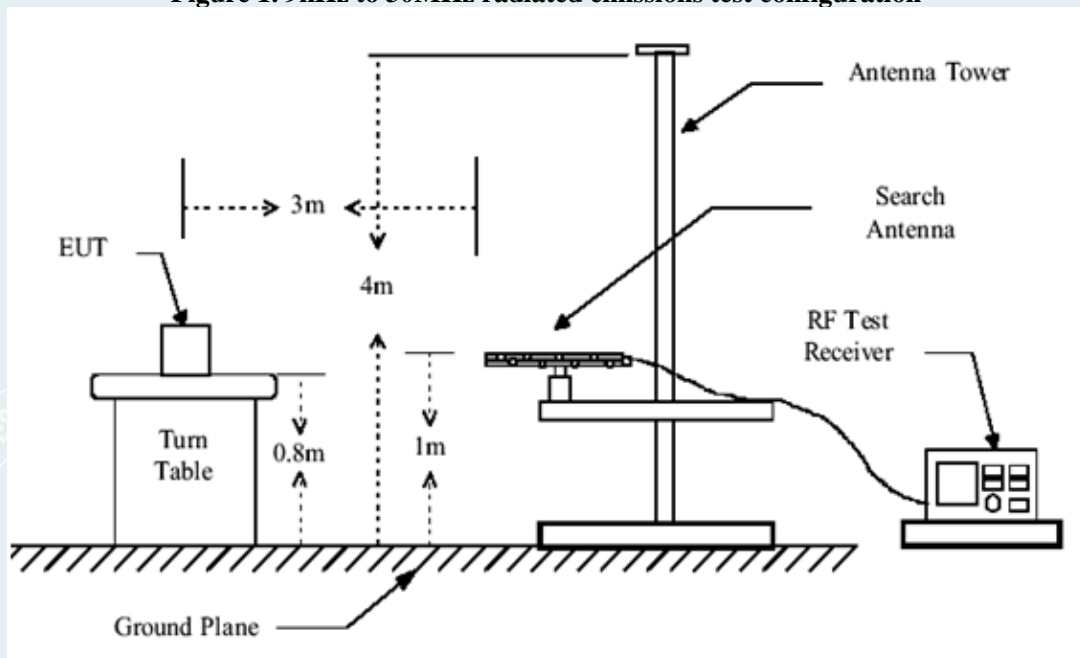

Figure 2. 30MHz to 1GHz radiated emissions test configuration

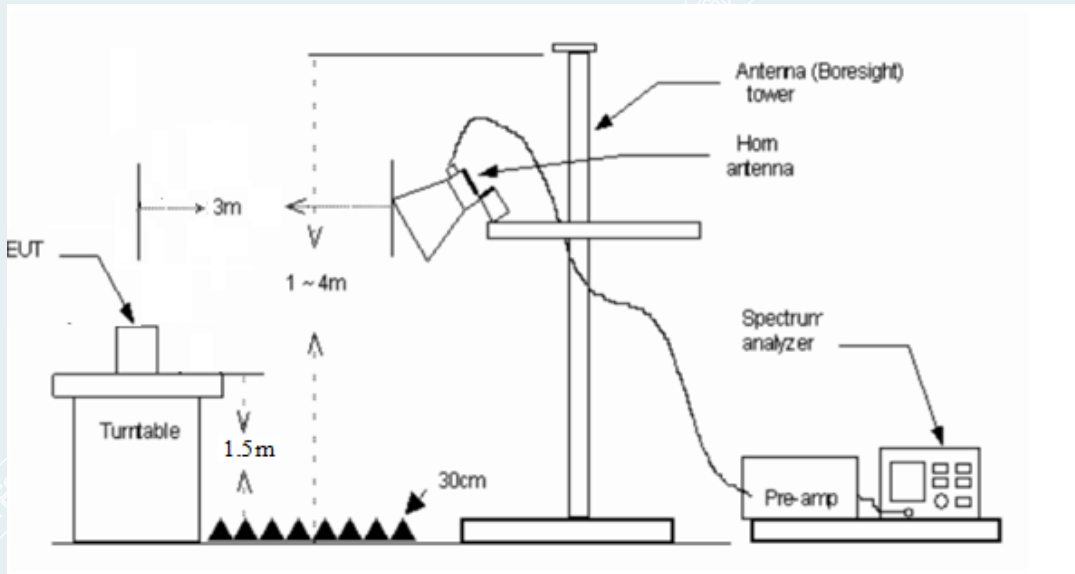

Figure 3. 1GHz-18GHz radiated emissions test configuration

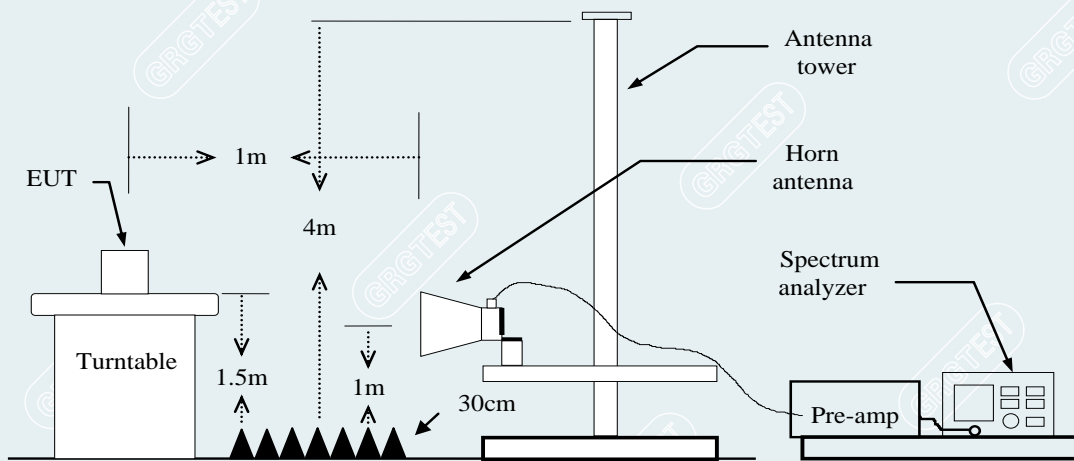

Figure 4. 18GHz-26.5GHz radiated emissions test configuration

----- The following blanks -----

8.4 DATA SAMPLE

30MHz to 1GHz

Frequency (MHz)	Reading (dBuV)	Correct Factor (dB/m)	Result (dBuV/m)	Limit (dBuV/m)	Margin (dB)	Degree (deg.)	Heigh (cm)	Detectorty pe
XXX.XXXX	48.49	-9.91	38.58	47.00	-8.42	100	108	QP

- Frequency (MHz) = Emission frequency in MHz
- Reading (dBuV) = Uncorrected Analyzer / Receiver reading
- Correct Factor (dB/m) = Antenna factor + Cable loss – Amplifier gain
- Result (dBuV/m) = Reading (dBuV) + Correct Factor (dB/m)
- Limit (dBuV/m) = Limit stated in standard
- Margin (dB) = Result (dBuV/m)-Limit (dBuV/m)
- Peak = Peak Reading
- QP = Quasi-peak Reading

1GHz-18GHz

No.	Freq. [MHz]	Reading [dBμV/m]	Level [dBμV/m]	Factor [dB]	Limit [dBμV/m]	Margin [dB]	Height [cm]	Angle [°]	Polarity	Remark
xxx	xxxx	78.01	55.30	-22.71	74.00	18.70	100	50	Horizontal	Peak
xxx	xxxx	66.37	43.66	-22.71	54.00	10.34	100	50	Horizontal	AVG

Above 18GHz

NO.	Freq. [MHz]	Reading [dBμV/m]	Level for 1m [dBμV/m]	Level for 3m [dBμV/m]	Factor [dB]	Limit [dBμV/m]	Margin [dB]	Height [cm]	Angle [°]	Polarity	Remark
xxx	xxxx	54.49	42.38	32.84	-12.11	74	41.16	100	211	Horizontal	Peak
xxx	xxxx	43.99	31.88	22.34	-12.11	54	31.66	100	211	Horizontal	AVG

- Frequency (MHz) = Emission frequency in MHz
- Reading (dBuV/m) = Uncorrected Analyzer / Receiver reading
- Factor (dB) = Antenna factor + Cable loss – Amplifier gain
- Level for 1m (dBuV/m) = Reading (dBuV/m) + Factor (dB)
- Level for 3m (dBuV/m) = Level for 1m (dBuV/m) + 20*log(1/3)
- Limit (dBuV/m) = Limit stated in standard
- Margin (dB) = Limit (dBuV/m) – Level (dBuV/m)
- Polarity = Antenna polarization
- Peak = Peak Reading
- AVG = Average Reading

8.5 TEST RESULTS

Below 1GHz

Note: Pre-scan all modes, the worst power supply is AC 120/60Hz(DC 5V/2A power by Adapter). In the two power supply modes, only the worst case(2405MHz) in the worst power supply is recorded, in this report.

Power supply: AC 120V/60Hz (DC 5V/2A power by Adapter)

EUT Name:	Hub M3	Test Mode:	Mode 1
Model:	HM-G01E	Sample No:	E20230331478001-0006
Power supply:	AC 120V/60Hz	Environmental Conditions:	24.3°C/54%RH/101.0kPa
Test Engineer:	Huang Xinlong	Test Date:	2023-12-18
Frequency	Lowest Frequency(2405MHz)	Polarity:	Horizontal

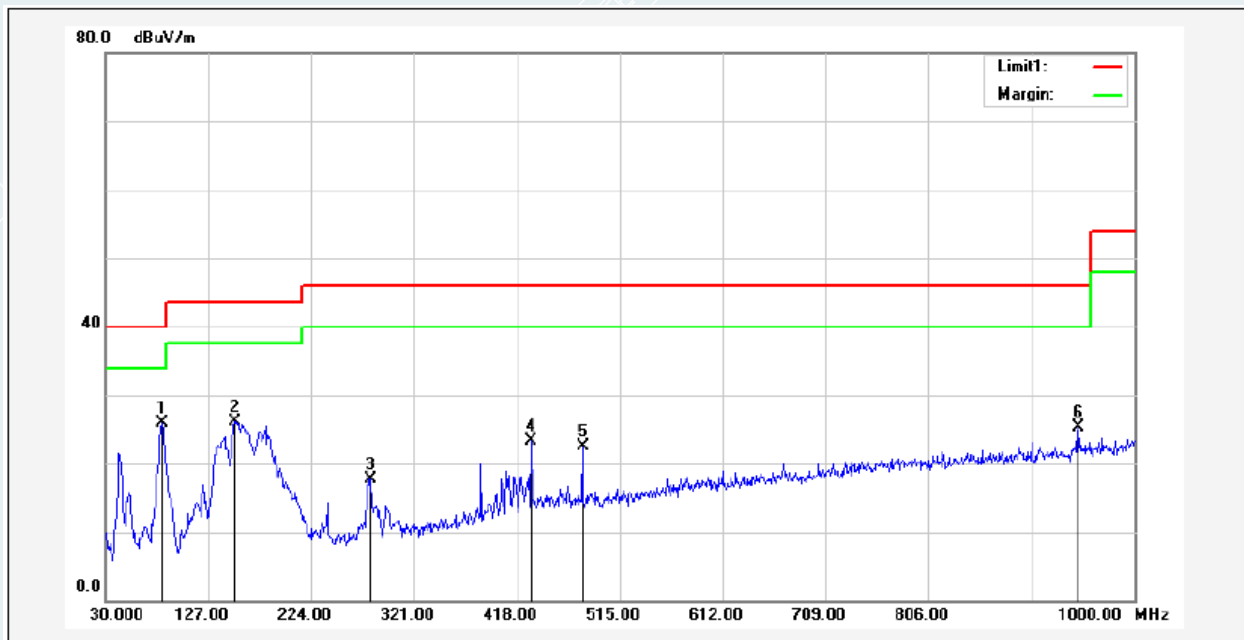

No.	Frequency (MHz)	Reading (dBuV)	Correction factor(dB/m)	Result (dBuV/m)	Limit (dBuV/m)	Margin (dB)	Degree (deg.)	Height (cm)	Detector type
1*	83.3500	59.58	-33.65	25.93	40.00	-14.07	189	200	QP
2	152.2200	54.95	-28.84	26.11	43.50	-17.39	78	200	QP
3	280.2600	46.89	-29.11	17.78	46.00	-28.22	256	200	QP
4	431.5800	47.71	-24.41	23.30	46.00	-22.70	91	100	QP
5	480.0800	45.74	-23.33	22.41	46.00	-23.59	360	170	QP
6	947.6200	42.56	-17.24	25.32	46.00	-20.68	288	100	QP

EUT Name:	Hub M3	Test Mode:	Mode 1
Model:	HM-G01E	Sample No:	E20230331478001-0006
Power supply:	AC 120V/60Hz	Environmental Conditions:	24.3°C/54%RH/101.0kPa
Test Engineer:	Huang Xinlong	Test Date:	2023-12-18
Frequency	Lowest Frequency (2405MHz)	Polarity:	Vertical

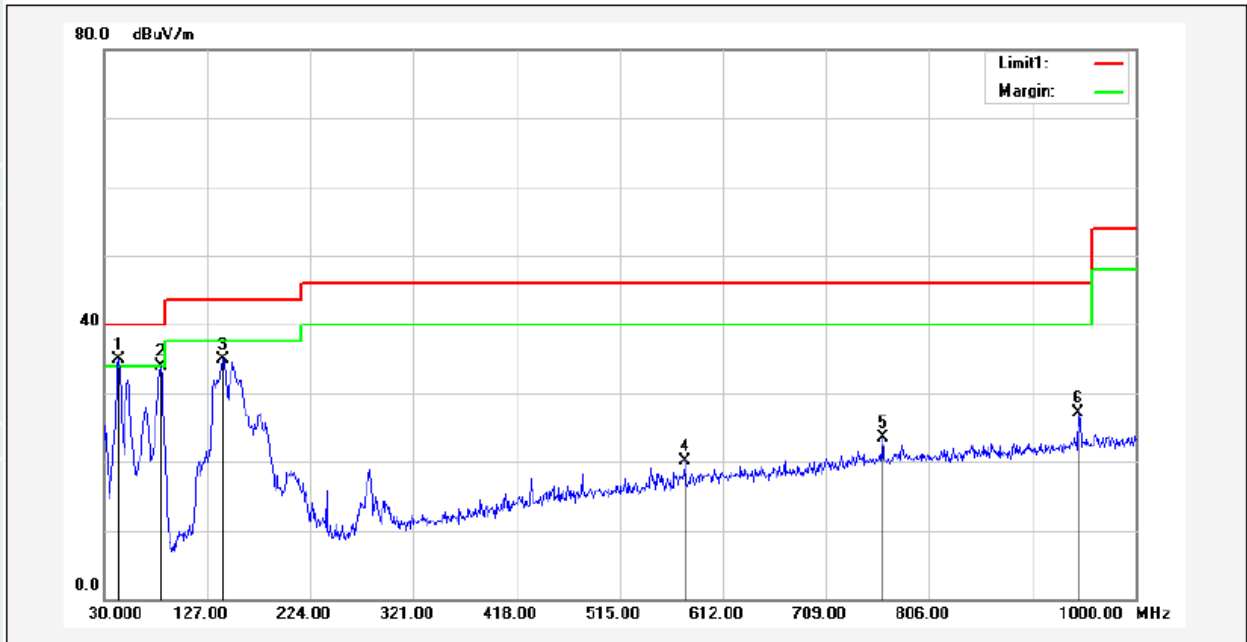

No.	Frequency (MHz)	Reading (dBuV)	Correction factor(dB/m)	Result (dBuV/m)	Limit (dBuV/m)	Margin (dB)	Degree (deg.)	Height (cm)	Detector type
1*	43.5800	64.27	-29.39	34.88	40.00	-5.12	152	100	QP
2	83.3500	67.63	-33.65	33.98	40.00	-6.02	177	200	QP
3	141.5500	63.91	-28.94	34.97	43.50	-8.53	75	100	QP
4	576.1100	41.56	-21.51	20.05	46.00	-25.95	359	200	QP
5	762.3500	42.65	-19.08	23.57	46.00	-22.43	88	100	QP
6	945.6800	44.27	-17.26	27.01	46.00	-18.99	343	200	QP

Remark:

- 1 No emission found between lowest internal used/generated frequency to 30MHz.
- 2 Radiated emissions measured in frequency range from 9kHz to 1GHz were made with an instrument using Quasi-peak detector mode.
- 3 Data of measurement within this frequency range shown "--" in the table above means the reading of emissions are attenuated more than 20dB below the permissible limits or the field strength is too small to be measured.
- 4 The IF bandwidth of Receiver between 30MHz to 1GHz was 120kHz.

1GHz-18GHz:

According to C63.10, if the peak (or quasi-peak) measured value complies with the average limit, it is unnecessary to perform an average measurement, so AV emission value did not show in below table if the peak value complies with average limit.

Pre-scan all modes, the worst power supply is AC 120V/60Hz(DC 5V/2A power by Adapter). In the two power supply modes, only the worst power supply mode is recorded in this report.

EUT Name:	Hub M3	Test Mode:	Mode 1
Model:	HM-G01E	Sample No:	E20230331478001-0006
Power supply:	AC 120V/60Hz	Environmental Conditions:	23.5°C/47%RH/101.0kPa
Test Engineer:	Zhang Zishan	Test Date:	2023-11-29
Frequency	Lowest Frequency (2405MHz)	/	/

Suspected Data List

NO.	Freq. [MHz]	Reading [dB μ V/m]	Level [dB μ V/m]	Factor [dB]	Limit [dB μ V/m]	Margin [dB]	Height [cm]	Angle [°]	Polarity
1	1160.0000	56.66	37.53	-19.13	74.00	36.47	200	53	Horizontal
2	1993.0000	60.88	45.33	-15.55	74.00	28.67	100	123	Horizontal
3	2366.2000	62.61	48.41	-14.20	74.00	25.59	100	90	Horizontal
4	2830.2000	57.11	45.78	-11.33	74.00	28.22	100	267	Horizontal
5	4810.5000	56.24	53.92	-2.32	74.00	20.08	200	290	Horizontal
6	7213.5000	49.06	52.24	3.18	74.00	21.76	200	308	Horizontal

AV Final Data List

NO.	Freq. [MHz]	Factor [dB]	AV Reading [dB μ V/m]	AV Value [dB μ V/m]	AV Limit [dB μ V/m]	AV Margin [dB]	Height [cm]	Angle [°]	Polarity
1	2366.6110	-14.20	57.90	43.70	54.00	10.30	129	45	Horizontal
2	4809.0385	-2.32	47.61	45.29	54.00	8.71	200	301.5	Horizontal
3	7216.3225	3.18	35.36	38.54	54.00	15.46	195	289.7	Horizontal

Suspected Data List

NO.	Freq. [MHz]	Reading [dB μ V/m]	Level [dB μ V/m]	Factor [dB]	Limit [dB μ V/m]	Margin [dB]	Height [cm]	Angle [°]	Polarity
1	1498.4000	59.05	41.68	-17.37	74.00	32.32	100	105	Vertical
2	1999.2000	61.38	44.67	-16.71	74.00	29.33	100	206	Vertical
3	2160.2000	59.44	45.54	-13.90	74.00	28.46	100	20	Vertical
4	4810.5000	57.14	54.76	-2.38	74.00	19.24	100	35	Vertical
5	7213.5000	48.10	51.20	3.10	74.00	22.80	100	52	Vertical
6	17997.0000	39.09	52.56	13.47	74.00	21.44	200	220	Vertical

AV Final Data List

NO.	Freq. [MHz]	Factor [dB]	AV Reading [dB μ V/m]	AV Value [dB μ V/m]	AV Limit [dB μ V/m]	AV Margin [dB]	Height [cm]	Angle [°]	Polarity
1	4811.0565	-2.38	47.55	45.17	54.00	8.83	103	42	Vertical
2	7216.4225	3.10	37.10	40.20	54.00	13.80	168	63.2	Vertical
3	17997.5300	13.47	27.37	40.84	54.00	13.16	200	228.8	Vertical

EUT Name:	Hub M3	Test Mode:	Mode 1
Model:	HM-G01E	Sample No:	E20230331478001-0006
Power supply:	AC 120V/60Hz	Environmental Conditions:	23.5°C/47%RH/101.0kPa
Test Engineer:	Zhang Zishan	Test Date:	2023-11-29
Frequency	Middle Frequency (2440MHz)	/	/

Suspected Data List

NO.	Freq. [MHz]	Reading [dB μ V/m]	Level [dB μ V/m]	Factor [dB]	Limit [dB μ V/m]	Margin [dB]	Height [cm]	Angle [°]	Polarity
1	1599.8000	61.63	43.30	-18.33	74.00	30.70	100	218	Horizontal
2	1993.2000	60.45	44.90	-15.55	74.00	29.10	100	133	Horizontal
3	2827.6000	57.70	46.37	-11.33	74.00	27.63	100	235	Horizontal
4	4881.0000	54.61	52.49	-2.12	74.00	21.51	200	223	Horizontal
5	7318.5000	48.38	51.43	3.05	74.00	22.57	200	309	Horizontal
6	12117.0000	39.86	53.55	13.69	74.00	20.45	200	71	Horizontal

AV Final Data List

NO.	Freq. [MHz]	Factor [dB]	AV Reading [dB μ V/m]	AV Value [dB μ V/m]	AV Limit [dB μ V/m]	AV Margin [dB]	Height [cm]	Angle [°]	Polarity
1	4881.0710	-2.12	45.69	43.57	54.00	10.43	178	231	Horizontal
2	7318.6075	3.05	35.78	38.83	54.00	15.17	179	336.5	Horizontal
	12119.2750	13.69	27.06	40.75	54.00	13.25	200	26.8	

Suspected Data List

NO.	Freq. [MHz]	Reading [dB μ V/m]	Level [dB μ V/m]	Factor [dB]	Limit [dB μ V/m]	Margin [dB]	Height [cm]	Angle [°]	Polarity
1	1499.6000	59.38	42.04	-17.34	74.00	31.96	200	221	Vertical
2	1999.2000	60.83	44.12	-16.71	74.00	29.88	100	186	Vertical
3	2163.2000	58.86	44.97	-13.89	74.00	29.03	100	323	Vertical
4	4881.0000	56.18	53.64	-2.54	74.00	20.36	100	138	Vertical
5	7318.5000	49.34	52.45	3.11	74.00	21.55	100	53	Vertical
6	12141.0000	39.63	53.54	13.91	74.00	20.46	200	103	Vertical

AV Final Data List

NO.	Freq. [MHz]	Factor [dB]	AV Reading [dB μ V/m]	AV Value [dB μ V/m]	AV Limit [dB μ V/m]	AV Margin [dB]	Height [cm]	Angle [°]	Polarity
1	4880.9290	-2.54	43.75	41.21	54.00	12.79	100	126.3	Vertical
2	7318.6075	3.11	39.76	42.87	54.00	11.13	104	41.2	Vertical
3	12120.2650	13.91	26.83	40.74	54.00	13.26	112	117.3	Vertical

EUT Name:	Hub M3	Test Mode:	Mode 1
Model:	HM-G01E	Sample No:	E20230331478001-0006
Power supply:	AC 120V/60Hz	Environmental Conditions:	23.5°C/47%RH/101.0kPa
Test Engineer:	Zhang Zishan	Test Date:	2023-11-29
Frequency	Highest Frequency(2475MHz)	/	/

Suspected Data List

NO.	Freq. [MHz]	Reading [dBμV/m]	Level [dBμV/m]	Factor [dB]	Limit [dBμV/m]	Margin [dB]	Height [cm]	Angle [°]	Polarity
1	1721.0000	60.51	42.95	-17.56	74.00	31.05	100	237	Horizontal
2	2163.0000	57.90	43.26	-14.64	74.00	30.74	100	74	Horizontal
3	2513.2000	58.94	46.31	-12.63	74.00	27.69	100	115	Horizontal
4	2907.2000	54.08	43.25	-10.83	74.00	30.75	200	359	Horizontal
5	4950.0000	55.02	53.67	-1.35	74.00	20.33	100	0	Horizontal
6	11379.0000	42.00	53.57	11.57	74.00	20.43	100	200	Horizontal

AV Final Data List

NO.	Freq. [MHz]	Factor [dB]	AV Reading [dBμV/m]	AV Value [dBμV/m]	AV Limit [dBμV/m]	AV Margin [dB]	Height [cm]	Angle [°]	Polarity
1	4951.0750	-1.35	45.07	43.72	54.00	10.28	161	360	Horizontal
2	11374.3850	11.57	28.21	39.78	54.00	14.22	123	157.6	Horizontal

Suspected Data List

NO.	Freq. [MHz]	Reading [dBμV/m]	Level [dBμV/m]	Factor [dB]	Limit [dBμV/m]	Margin [dB]	Height [cm]	Angle [°]	Polarity
1	1197.2000	60.99	41.92	-19.07	74.00	32.08	200	158	Vertical
2	1494.4000	60.21	42.76	-17.45	74.00	31.24	100	312	Vertical
3	2514.2000	58.26	45.29	-12.97	74.00	28.71	100	211	Vertical
4	4950.0000	57.24	55.49	-1.75	74.00	18.51	100	290	Vertical
5	7426.5000	48.69	52.26	3.57	74.00	21.74	100	34	Vertical
6	11731.5000	40.83	52.99	12.16	74.00	21.01	200	15	Vertical

AV Final Data List

NO.	Freq. [MHz]	Factor [dB]	AV Reading [dBμV/m]	AV Value [dBμV/m]	AV Limit [dBμV/m]	AV Margin [dB]	Height [cm]	Angle [°]	Polarity
1	4950.8600	-1.75	48.52	46.77	54.00	7.23	136	286.8	Vertical
2	7423.5975	3.57	36.85	40.42	54.00	13.58	103	23.3	Vertical
3	11734.5525	12.16	27.60	39.76	54.00	14.24	200	348.5	Vertical

18GHz-26.5GHz:

According to C63.10, if the peak (or quasi-peak) measured value complies with the average limit, it is unnecessary to perform an average measurement, so AV emission value did not show in below table if the peak value complies with average limit.

Note: Pre-scan all modes, the worst power supply is AC 120V/60Hz(DC 5V/2A power by Adapter). In the two power supply modes, only the worst case(Highest Frequency :2475MHz) in the worst power supply is recorded, in this report.

EUT Name:	Hub M3	Test Mode:	Mode 1
Model:	HM-G01E	Sample No:	E20230331478001-0006
Power supply:	AC 120V/60Hz	Environmental Conditions:	23.5 °C/47%RH/101.0kPa
Test Engineer:	Zhang Zishan	Test Date:	2023-11-29
Frequency	Highest Frequency (2475MHz)	/	/

Suspected Data List

NO.	Freq. [MHz]	Reading [dBμV/m]	Level for 1m [dBμV/m]	Level for 3m [dBμV/m]	Factor [dB]	Limit [dBμV/m]	Margin [dB]	Height [cm]	Angle [°]	Polarity
1	18269.8750	56.99	45.42	35.88	-11.57	74	38.12	150	173	Horizontal
2	19699.5750	55.06	44.19	34.65	-10.87	74	39.35	100	211	Horizontal
3	21098.2500	54.47	44.18	34.64	-10.29	74	39.36	100	192	Horizontal
4	22237.6750	54.81	45.13	35.59	-9.68	74	38.41	100	50	Horizontal
5	23424.7000	54.05	45.31	35.77	-8.74	74	38.23	200	96	Horizontal
6	26105.6000	53.68	45.55	36.01	-8.13	74	37.99	200	128	Horizontal

Suspected Data List

NO.	Freq. [MHz]	Reading [dBμV/m]	Level for 1m [dBμV/m]	Level for 3m [dBμV/m]	Factor [dB]	Limit [dBμV/m]	Margin [dB]	Height [cm]	Angle [°]	Polarity
1	18357.4250	56.74	45.20	35.66	-11.54	74	38.34	200	315	Vertical
2	19428.0000	55.47	44.51	34.97	-10.96	74	39.03	100	12	Vertical
3	21417.4250	54.16	44.08	34.54	-10.08	74	39.46	100	276	Vertical
4	22915.5500	53.59	44.60	35.06	-8.99	74	38.94	100	104	Vertical
5	24103.8500	53.91	45.68	36.14	-8.23	74	37.86	200	309	Vertical
6	26116.6500	53.78	46.67	37.13	-8.11	74	36.87	200	322	Vertical

Remark:

- 1 Measuring frequencies from 1 GHz to the 10th harmonic of highest fundamental frequency.
- 2 Measurements above show only up to 6 maximum emissions noted, or would be lesser if no specific emissions from the EUT are recorded (ie: margin>20dB from the applicable limit) and considered that's already beyond the background noise floor.
- 3 Radiated emissions measured in frequency above 1000MHz were made with an instrument using Peak detector mode and average detector mode of the emission shown in Actual FS column.
- 4 Above 18G test distance is 1m, so the Level for 3m= Level for 1m + 20*log(1/3)

8. 6dB BANDWIDTH

9.1 LIMITS

Systems using digital modulation techniques may operate in the 902–928 MHz, 2400–2483.5 MHz, and 5725–5850 MHz bands. The minimum 6 dB bandwidth shall be at least 500 kHz.

9.2 TEST PROCEDURES

- a) Remove the antenna from the EUT, and then connect a low loss RF cable from antenna port to Automatic power measuring unit.
- b) Set resolution bandwidth (RBW) = 100kHz. Set the video bandwidth (VBW) ≥ 3 x RBW. Detector = Peak. Trace mode = max hold. Sweep = auto couple. Allow the trace to stabilize, record 6dB bandwidth value.
- c) Repeat above procedures until all frequencies measured were complete.

9.3 TEST SETUP

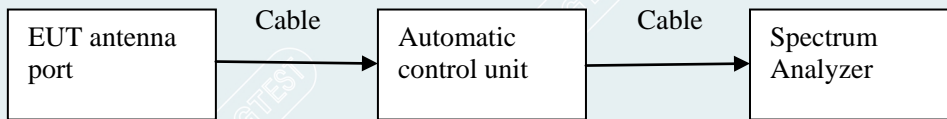

9.4 TEST RESULTS

Environment: 27.1 °C / 49% RH / 101.0 kPa
 Tested By: Huang Tianmei

Voltage: DC 5V
 Date: 2023-11-29

Ch Name	Frequency (MHz)	Bandwidth [kHz]	Limit[kHz]	Verdict
Lowest	2405	1630	≥500	PASS
Middle	2440	1630		PASS
Highest	2475	1630		PASS

----- The following blanks -----

Lowest Frequency (2405MHz)

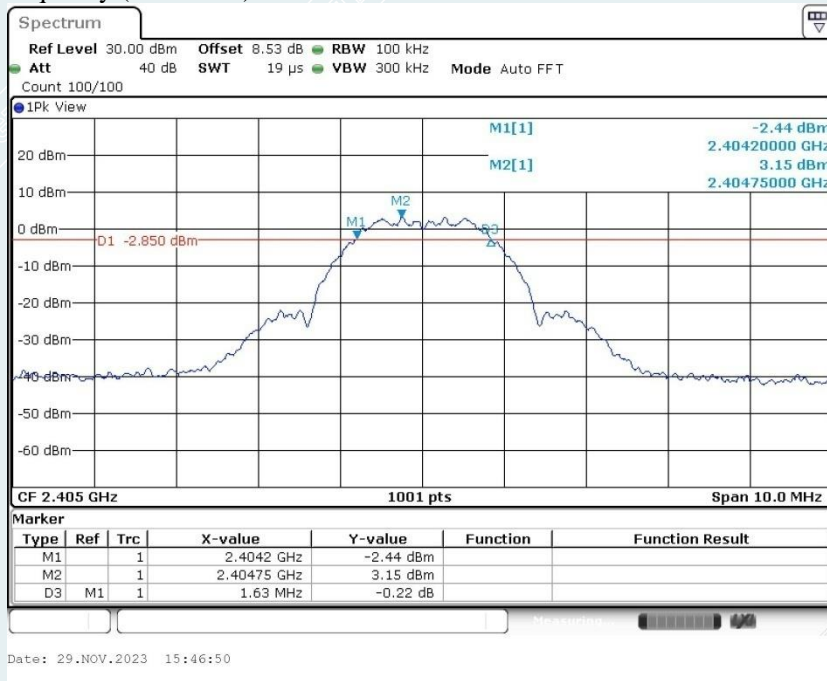

Middle Frequency (2440 MHz)

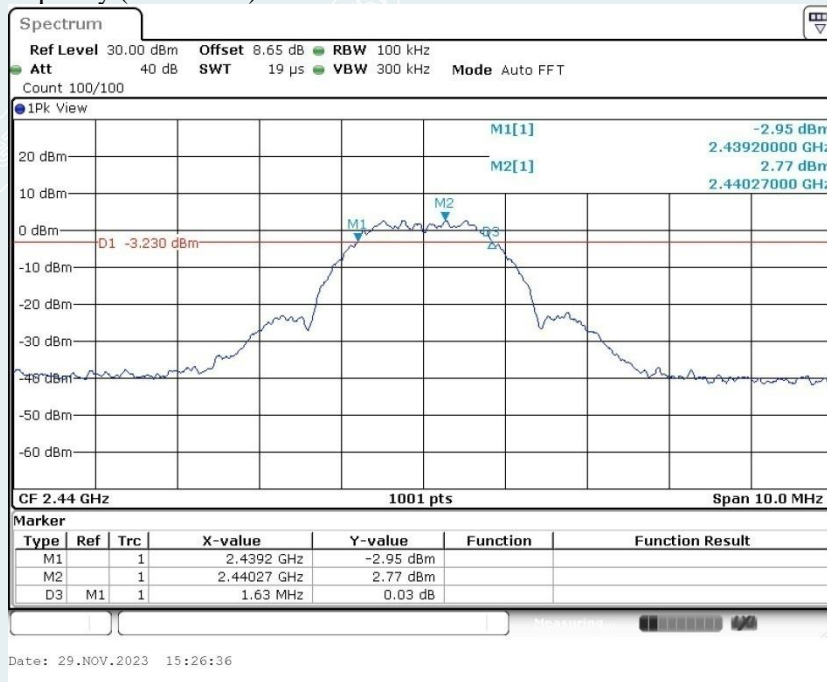

Highest Frequency (2475MHz)

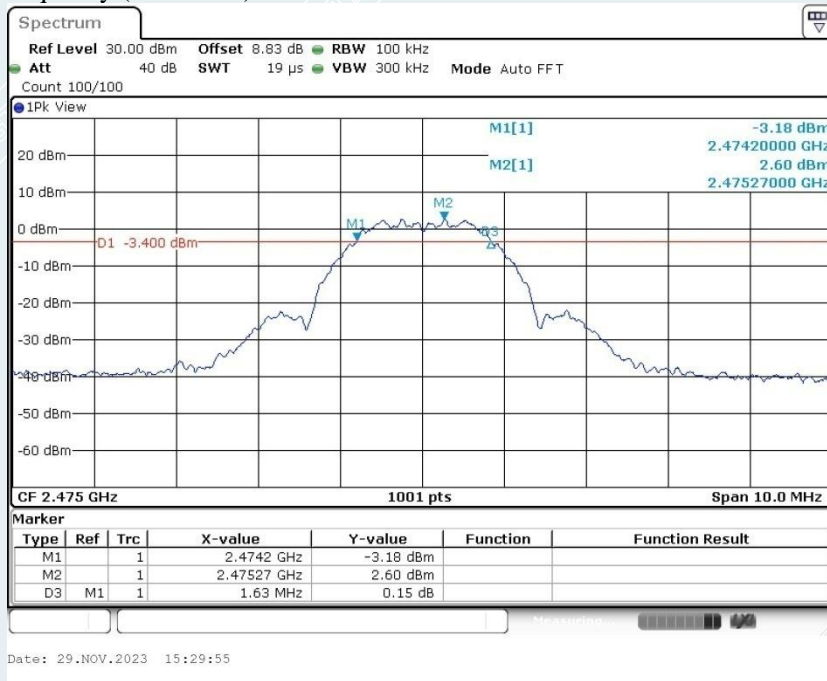

----- The following blanks -----

9. MAXIMUM PEAK OUTPUT POWER

10.1 LIMITS

The maximum Peak output power measurement is 1W

10.2 TEST PROCEDURES

- a) According to the test mode, the channel requirements set EUT to continuous transmission mode.
- b) Remove the antenna from the EUT and then connect a low loss RF cable from the antenna port to the power meter.

10.3 TEST SETUP

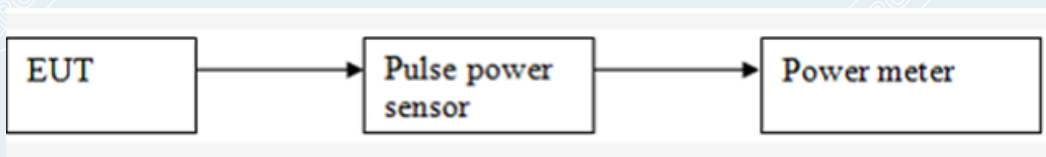

10.4 TEST RESULTS

Environment: 27.1 °C/49%RH/101.0kPa
 Tested By: Huang Tianmei

Voltage: DC 3V
 Date: 2023-11-29

ChName	Frequency (MHz)	Measured Channel Power (dBm)	Limit	Peak/Average	Result
Lowest	2405	6.72	1W (30dBm)	Peak	Pass
Middle	2440	6.46			Pass
Highest	2475	6.31			Pass

----- The following blanks -----

10. POWER SPECTRAL DENSITY

11.1 LIMITS

For digitally modulated systems, the power spectral density conducted from the intentional radiator to the antenna shall not be greater than 8 dBm in any 3 kHz band during any time interval of continuous transmission. This power spectral density shall be determined in accordance with the provisions of paragraph (b) of this section. The same method of determining the conducted output power shall be used to determine the power spectral density.

11.2 TEST PROCEDURES

- a) Remove the antenna from the EUT, and then connect a low loss RF cable from antenna port to the spectrum analyzer.
- b) Position the EUT was set without connection to measurement instrument. Turn on the EUT and connect its antenna terminal to measurement instrument via a low loss cable. Then set it to any one measured frequency within its operating range, and make sure the instrument is operated in its linear range.
- c) The following procedure shall be used if maximum peak conducted output power was used to determine compliance, and it is optional if the maximum conducted (average) output power was used to determine compliance:
 - 1) Set analyzer center frequency to DTS channel center frequency.
 - 2) Set the span to 1.5 times the DTS bandwidth.
 - 3) Set the RBW to $3 \text{ kHz} \leq \text{RBW} \leq 100 \text{ kHz}$.
 - 4) Set the VBW $\geq [3 \times \text{RBW}]$.
 - 5) Detector = peak
 - 6) Sweep time = auto couple.
 - 7) Trace mode = max hold.
 - 8) Allow trace to fully stabilize.
 - 9) Use the peak marker function to determine the maximum amplitude level within the RBW.
 - 10) If measured value exceeds requirement, then reduce RBW (but no less than 3 kHz) and repeat.
- d) Repeat above procedures until all frequencies measured were complete.

11.3 TEST SETUP

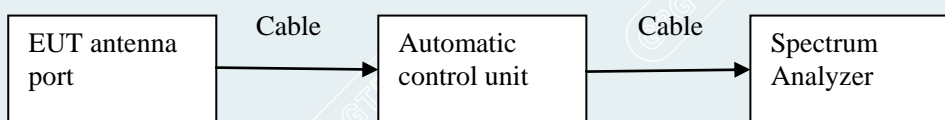

11.4 TEST RESULTS

Environment: 27.1°C/49%RH/101.0kPa
 Tested By: Huang Tianmei

Voltage: DC 3V
 Date: 2023-11-29

Ch Name	Frequency (MHz)	PSD (dBm/3kHz)	Limit (dBm/3kHz)	Result
Lowest	2405	-4.27	8.00	Pass
Middle	2440	-4.86	8.00	Pass
Highest	2475	-4.84	8.00	Pass

Lowest Frequency (2405MHz)

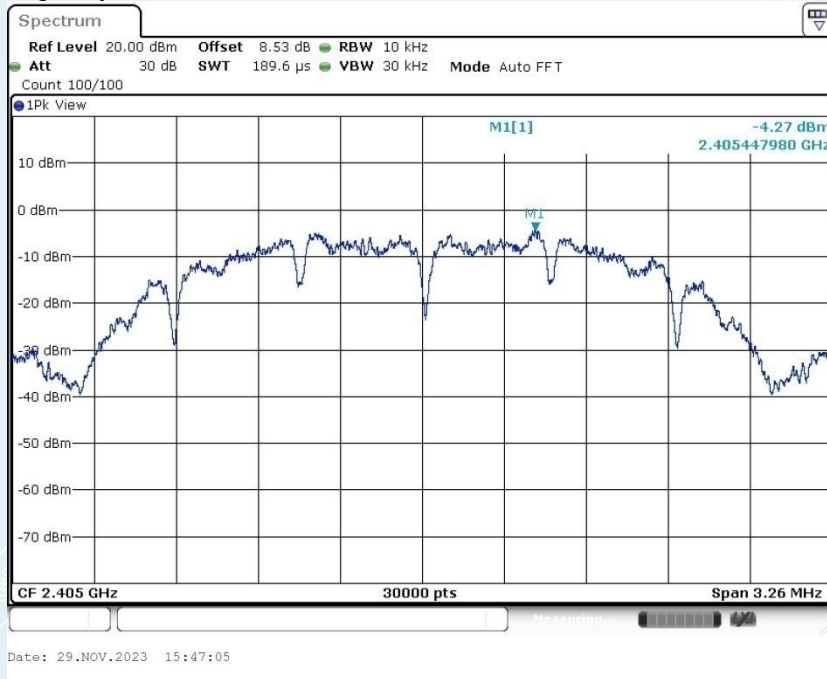

----- The following blanks -----

Middle Frequency (2440 MHz)

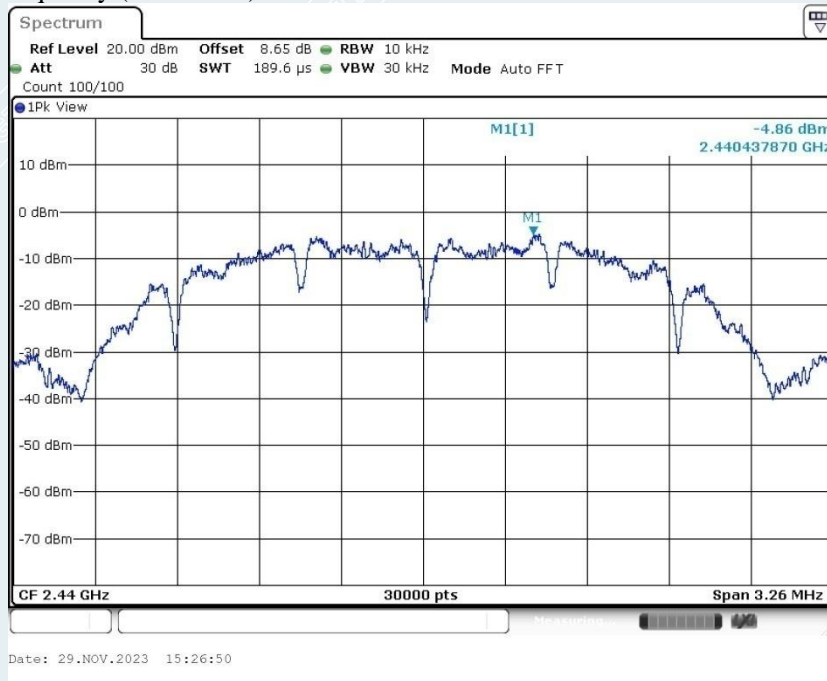

Highest Frequency (2475MHz)

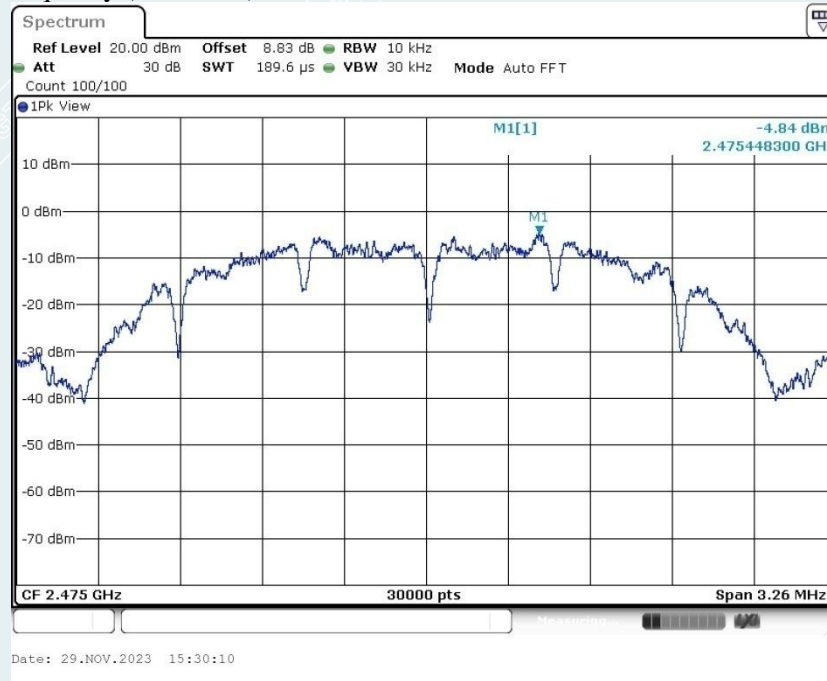

11. CONDUCTED BAND EDGES AND SPURIOUS EMISSIONS

12.1 LIMITS

(d) In any 100 kHz bandwidth outside the frequency band in which the spread spectrum or digitally modulated intentional radiator is operating, the radio frequency power that is produced by the intentional radiator shall be at least 20 dB below that in the 100 kHz bandwidth within the band that contains the highest level of the desired power, based on either an RF conducted or a radiated measurement, provided the transmitter demonstrates compliance with the peak conducted power limits. If the transmitter complies with the conducted power limits based on the use of RMS averaging over a time interval, as permitted under paragraph (b)(3) of this section, the attenuation required under this paragraph shall be 30 dB instead of 20 dB.

12.2 TEST PROCEDURES

Remove the antenna from the EUT and then connect a low attenuation cable from the antenna port to the spectrum.

- Remove the antenna from the EUT and then connect a low attenuation cable from the antenna port to the spectrum.
- Set the spectrum analyzer: RBW=100kHz; VBW=300kHz, Span=10MHz to 26.5GHz;Sweep=auto; Detector Function=Peak. Trace=Max, hold.
- Measure and record the results in the test report.
- The RF fundamental frequency should be excluded against the limit line in the operating frequency band.
- Measurements are made from 30MHz to 26.5GHz with the transmitter set to the lowest, middle, and highest channels.

12.3 TEST SETUP

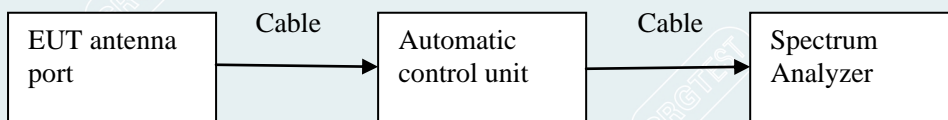

12.4 TEST RESULTS

Environment: 27.1 °C/49%RH/101.0kPa
Tested By: Huang Tianmei

Voltage: DC 5V
Date: 2023-11-29

Band edge

Test Mode	Antenna	Ch Name	Frequency [MHz]	Ref Level[dBm]	Result[dBm]	Limit[dBm]	Verdict
Thread	Ant3	Lowest	2405	3.10	-47.26	≤-16.9	PASS
		Highest	2475	2.54	-47.14	≤-17.46	PASS

Lowest Frequency (2405MHz)
2.35GHz-2.41GHz

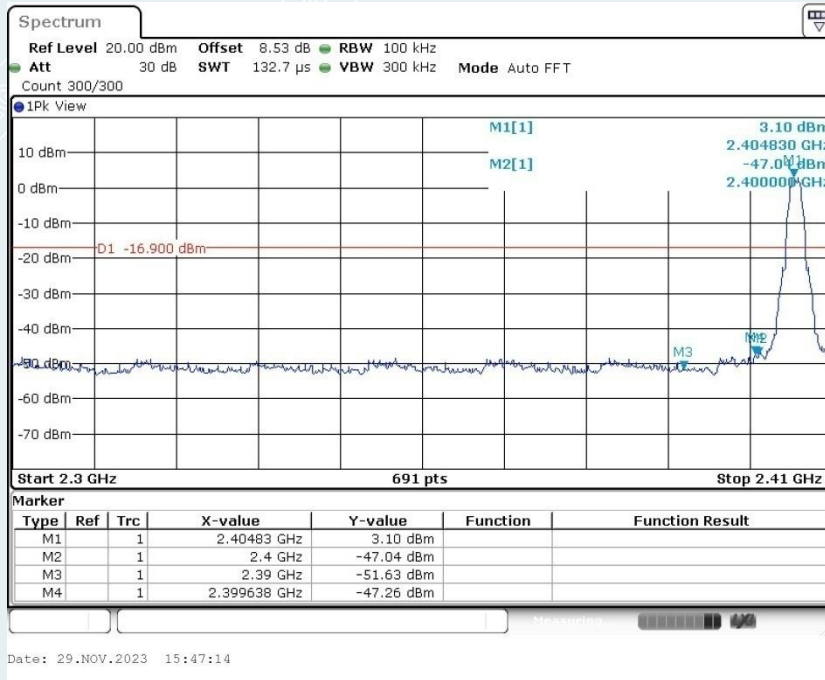

Highest Frequency (2475MHz)
2.47GHz-2.55GHz

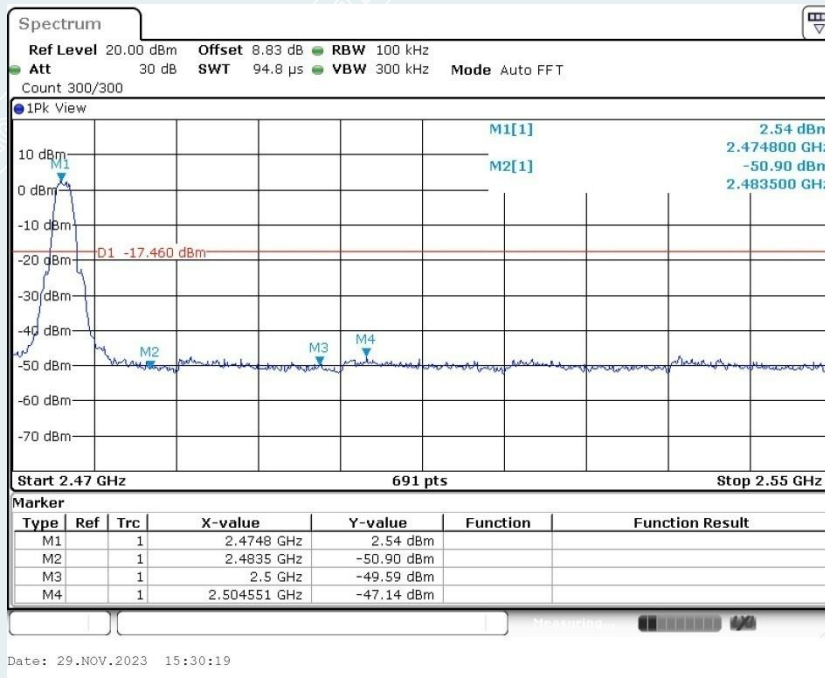

Conducted Spurious Emission

Test Mode	Antenna	Frequency [MHz]	Freq Range [MHz]	Ref Level [dBm]	Result[dBm]	Limit[dBm]	Verdict
Thread	Ant3	2405	Reference	3.18	3.18	---	PASS
			30~1000	3.18	-57.81	≤-16.82	PASS
			1000~26500	3.18	-53.71	≤-16.82	PASS
		2440	Reference	2.79	2.79	---	PASS
			30~1000	2.79	-57.91	≤-17.21	PASS
			1000~26500	2.79	-54.82	≤-17.21	PASS
		2475	Reference	2.65	2.65	---	PASS
			30~1000	2.65	-58.9	≤-17.35	PASS
			1000~26500	2.65	-54.65	≤-17.35	PASS

Lowest Frequency (2405MHz)



0.03GHz-1GHz

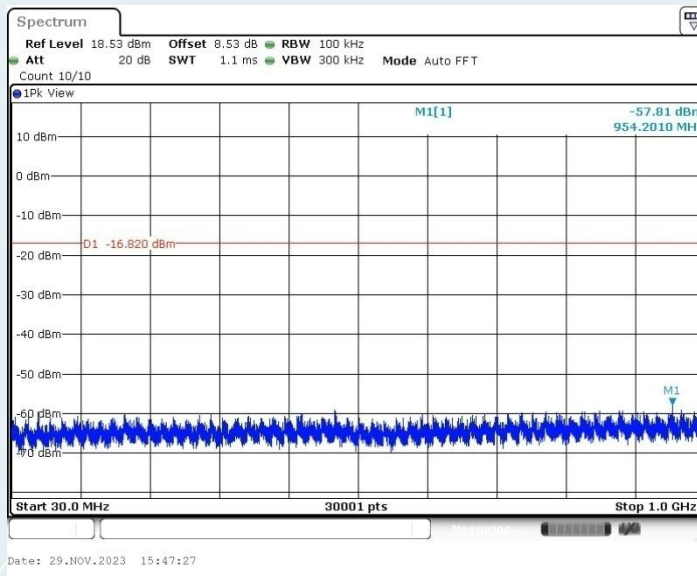

1GHz-26.5GHz

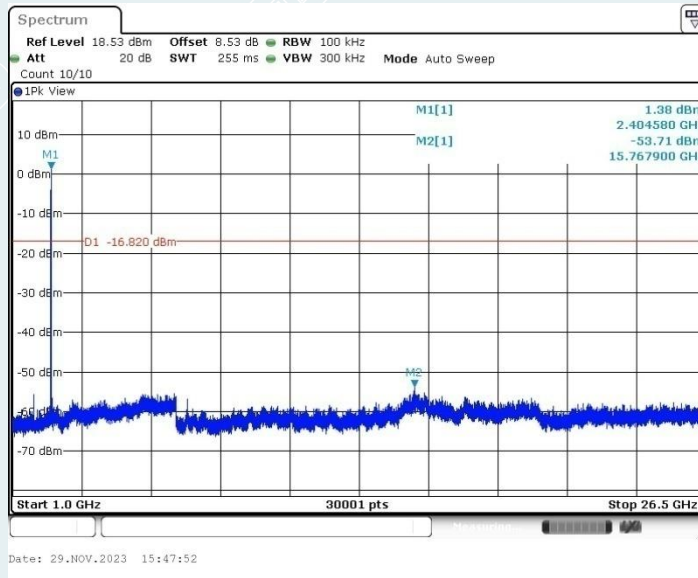

Middle Frequency (2440MHz)



0.03GHz-1GHz

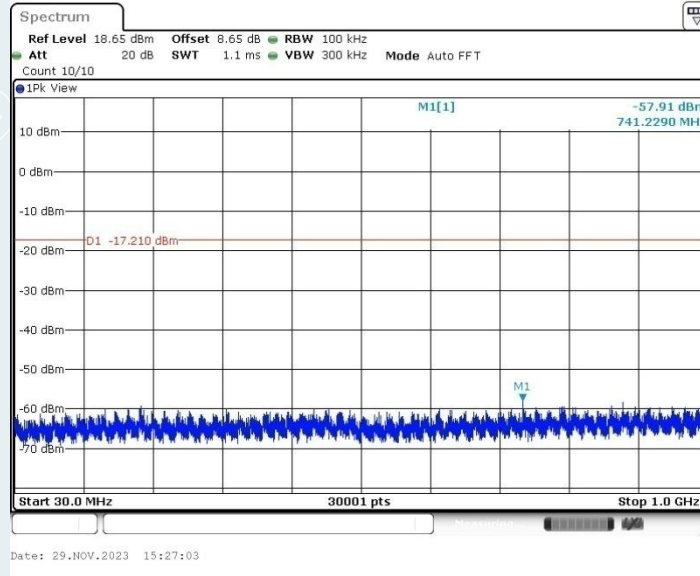

1GHz-26.5GHz

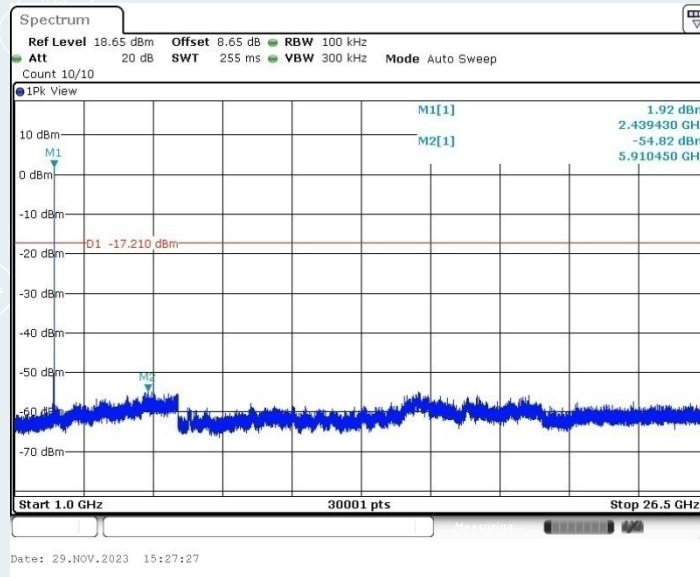

Highest Frequency (2475MHz)



0.03GHz-1GHz

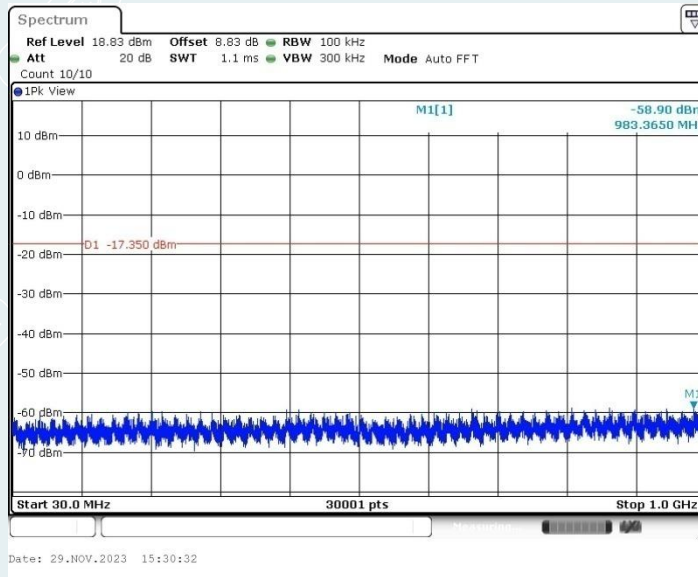

1GHz-26.5GHz

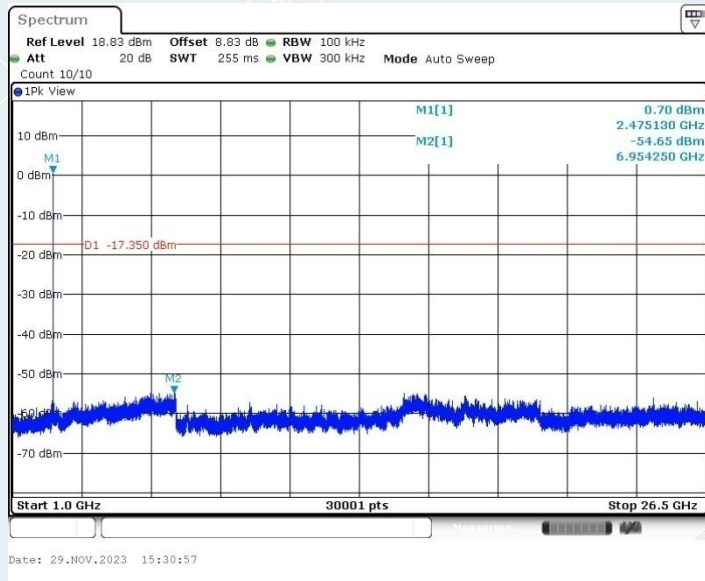

----- The following blanks -----

12. RESTRICTED BANDS OF OPERATION

13.1 LIMITS

Section 15.247(d) In addition, Radiated emissions which fall in the restricted bands, as defined in §15.205(a), must also comply with the radiated emission limits specified in §15.209(a) (see §15.205(c)).

MHz	MHz	MHz	GHz
0.090 - 0.110	16.42 - 16.423	399.9 - 410	4.5 - 5.15
¹ 0.495 - 0.505	16.69475 - 16.69525	608 - 614	5.35 - 5.46
2.1735 - 2.1905	16.80425 - 16.80475	960 - 1240	7.25 - 7.75
4.125 - 4.128	25.5 - 25.67	1300 - 1427	8.025 - 8.5
4.17725 - 4.17775	37.5 - 38.25	1435 - 1626.5	9.0 - 9.2
4.20725 - 4.20775	73 - 74.6	1645.5 - 1646.5	9.3 - 9.5
6.215 - 6.218	74.8 - 75.2	1660 - 1710	10.6 - 12.7
6.26775 - 6.26825	108 - 121.94	1718.8 - 1722.2	13.25 - 13.4
6.31175 - 6.31225	123 - 138	2200 - 2300	14.47 - 14.5
8.291 - 8.294	149.9 - 150.05	2310 - 2390	15.35 - 16.2
8.362 - 8.366	156.52475 - 156.52525	2483.5 - 2500	17.7 - 21.4
8.37625 - 8.38675	156.7 - 156.9	2655 - 2900	22.01 - 23.12
8.41425 - 8.41475	162.0125 - 167.17	3260 - 3267	23.6 - 24.0
12.29 - 12.293	167.72 - 173.2	3332 - 3339	31.2 - 31.8
12.51975 - 12.52025	240 - 285	3345.8 - 3358	36.43 - 36.5
12.57675 - 12.57725	322 - 335.4	3600 - 4400	
13.36 - 13.41			

Frequency (MHz)	Quasi-peak(μ V/m)	Measurement distance(m)	Quasi-peak(dB μ V/m)@distance 3m
0.009-0.490	2400/F(kHz)	300	128.5~93.8
0.490-1.705	24000/F(kHz)	30	73.8~63
1.705-30.0	30	30	69.5
30 ~ 88	100	3	40
88~216	150	3	43.5
216 ~ 960	200	3	46
Above 960	500	3	54

13.2 TEST PROCEDURES

- a) The EUT is placed on a turntable, which is 1.5m above the ground plane.
- b) The turntable shall be rotated for 360 degrees to determine the position of maximum emission level.
- c) EUT is set 3m away from the receiving antenna, which is varied from 1m to 4m to find out the highest emission.
- d) Set the spectrum analyzer in the following setting in order to capture the lower and upper band-edges of the emission:
 - a) For Peak detector: Set RBW=1MHz, RBW=3MHz, Sweep=AUTO.
 - b) For Avg detector: Set RBW=1MHz, Sweep=AUTO, the EUT is configured to transmit with duty cycle $\geq 98\%$, set $VBW \leq RBW/100$ (i.e., 10kHz) but not less than 10 Hz. If the EUT duty cycle is $< 98\%$, set $VBW \geq 1/T$, Where T is defined in section 2.8.
- e) Repeat the procedures until all the PEAK and AVERAGE versus polarization are measured.

13.3 TEST SETUP

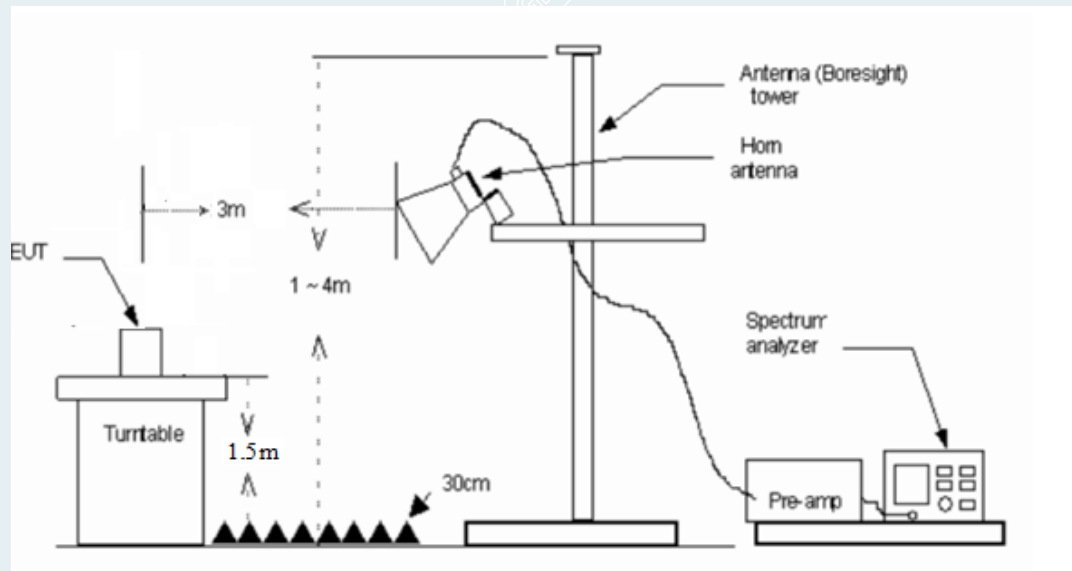

----- The following blanks -----

13.4 TEST RESULTS

Pre-scan all modes, the worst power supply is AC 120/60Hz(DC 5V/2A power by Adapter), in the two power supply modes, only the worst power supply mode is recorded in this report.

EUT Name:	Hub M3	Test Mode:	Mode 1
Model:	HM-G01E	Sample No:	E20230331478001-0006
Test Engineer:	Zhang Zishan	Test Voltage:	AC 120V/60Hz
Environmental Conditions:	23.5°C/47%RH/101.0kPa	Test Date:	2023-11-29

Lowest Channel

Frequency: 2405MHz

Detector mode: Peak

Polarity: Horizontal

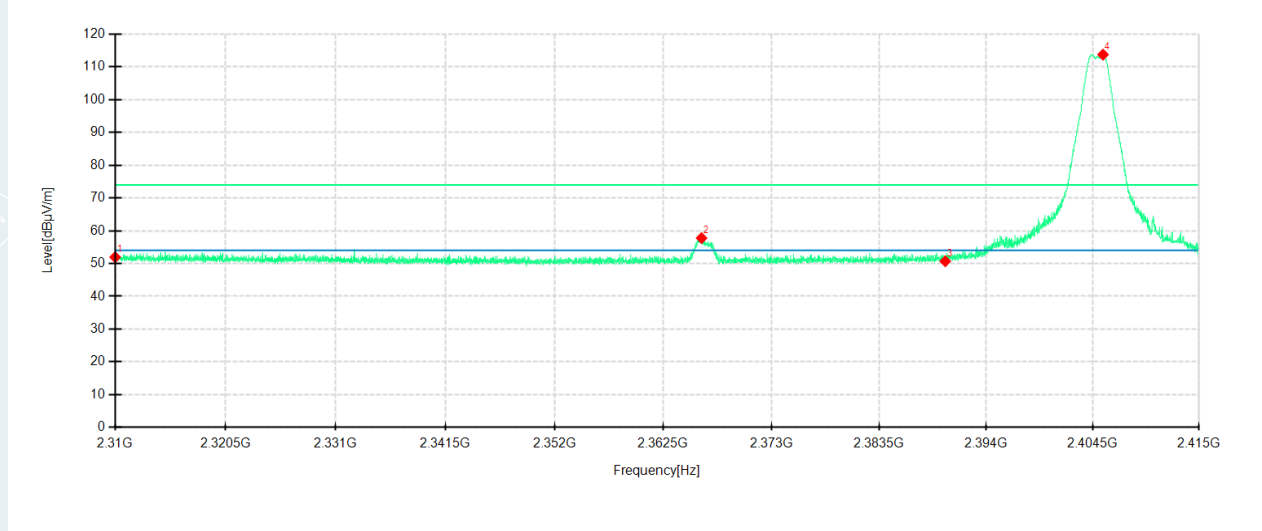

Detector mode: Peak

Polarity: Vertical

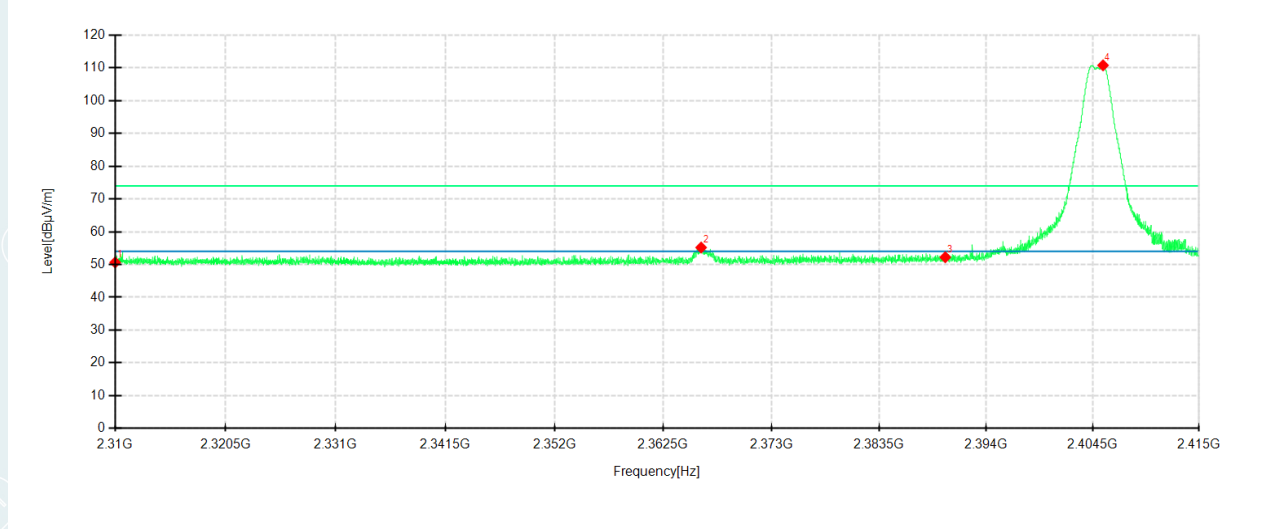

No.	Frequency MHz	Reading dB μ V/m	Level dB μ V/m	Factor dB	Limit dB μ V/m	Margin dB	Height cm	Angle °	Pole	Comment
1	2310.0000	46.36	51.95	5.59	74.00	22.05	200	20	Horizontal	/
2	2366.2275	53.17	57.77	4.60	74.00	16.23	100	88	Horizontal	/
3	2390.0000	45.91	50.71	4.80	74.00	23.29	100	88	Horizontal	
4	2405.5106	108.83	113.73	4.90	74.00	-39.73	100	19	Horizontal	No limit
1	2310.0000	45.75	50.64	4.89	74.00	23.36	200	340	Vertical	/
2	2366.1881	50.37	55.19	4.82	74.00	18.81	100	258	Vertical	/
3	2390.0000	47.01	52.23	5.22	74.00	21.77	200	37	Vertical	/
4	2405.5106	105.35	110.76	5.41	74.00	-36.76	100	158	Vertical	No limit

----- The following blanks -----

Lowest Channel

Frequency: 2405MHz

Detector mode: Average

Polarity: Horizontal

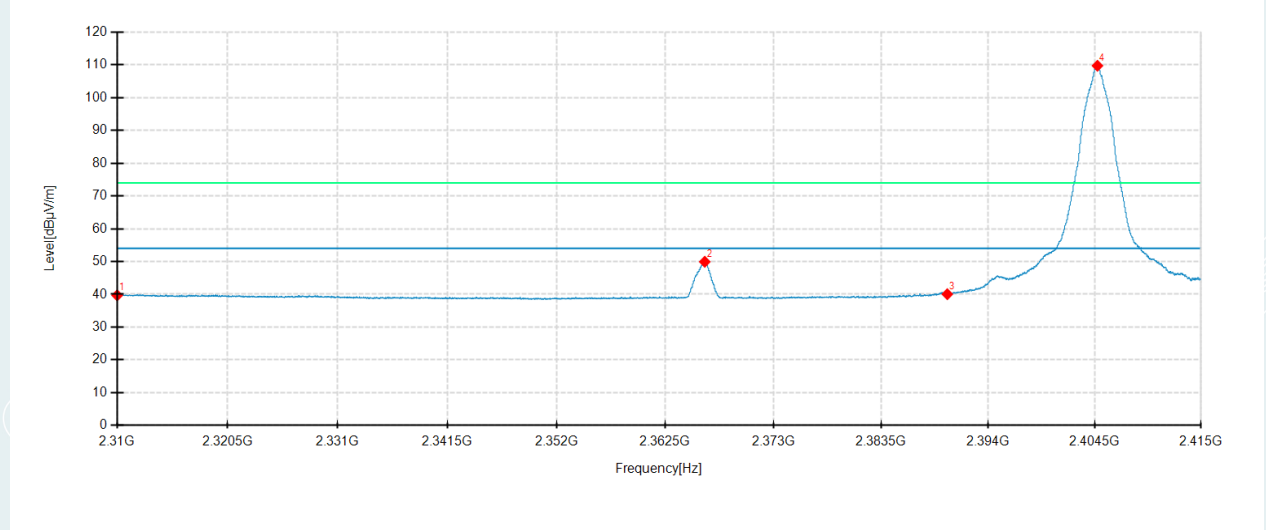

Detector mode: Average

Polarity: Vertical

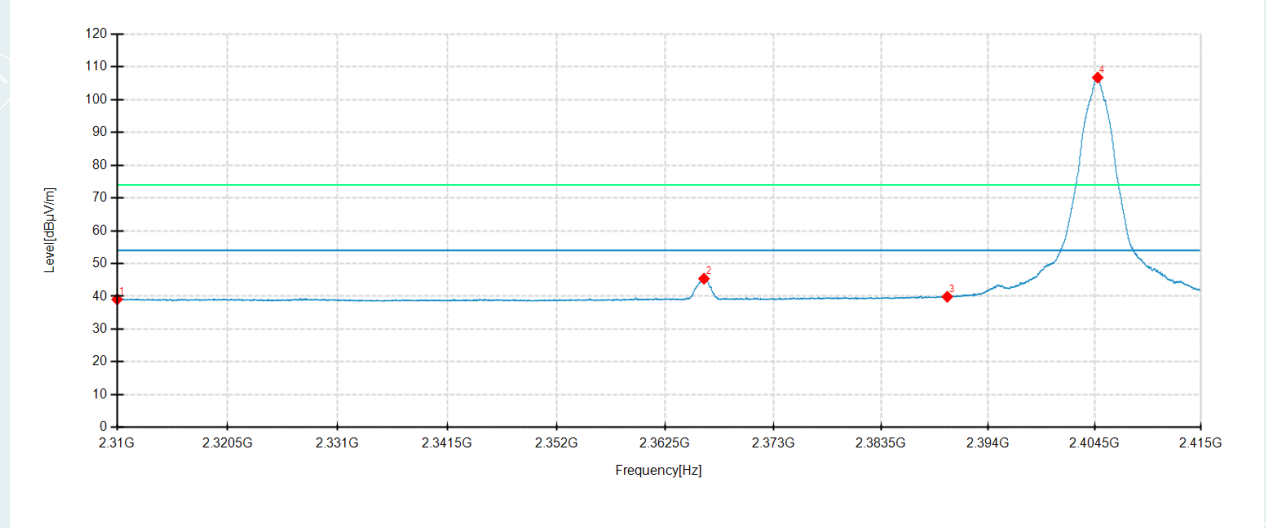

No.	Frequency MHz	Reading dBμV/m	Level dBμV/m	Factor dB	Limit dBuV/m	Margin dB	Height cm	Angle °	Pole	Comment
1	2310.0000	34.10	39.69	5.59	54.00	14.31	100	204	Horizontal	/
2	2366.3456	45.34	49.93	4.59	54.00	4.07	100	79	Horizontal	/
3	2390.0000	35.25	40.05	4.80	54.00	13.95	100	79	Horizontal	/
4	2404.7625	104.82	109.72	4.90	54.00	-55.72	100	29	Horizontal	No limit
1	2310.0000	34.20	39.09	4.89	54.00	14.91	200	272	Vertical	/
2	2366.2669	40.55	45.38	4.83	54.00	8.62	100	321	Vertical	/
3	2390.0000	34.65	39.87	5.22	54.00	14.13	100	203	Vertical	/
4	2404.7888	101.32	106.73	5.41	54.00	-52.73	100	154	Vertical	No limit

Highest Channel

Frequency: 2475MHz

Detector mode: Peak

Polarity: Horizontal

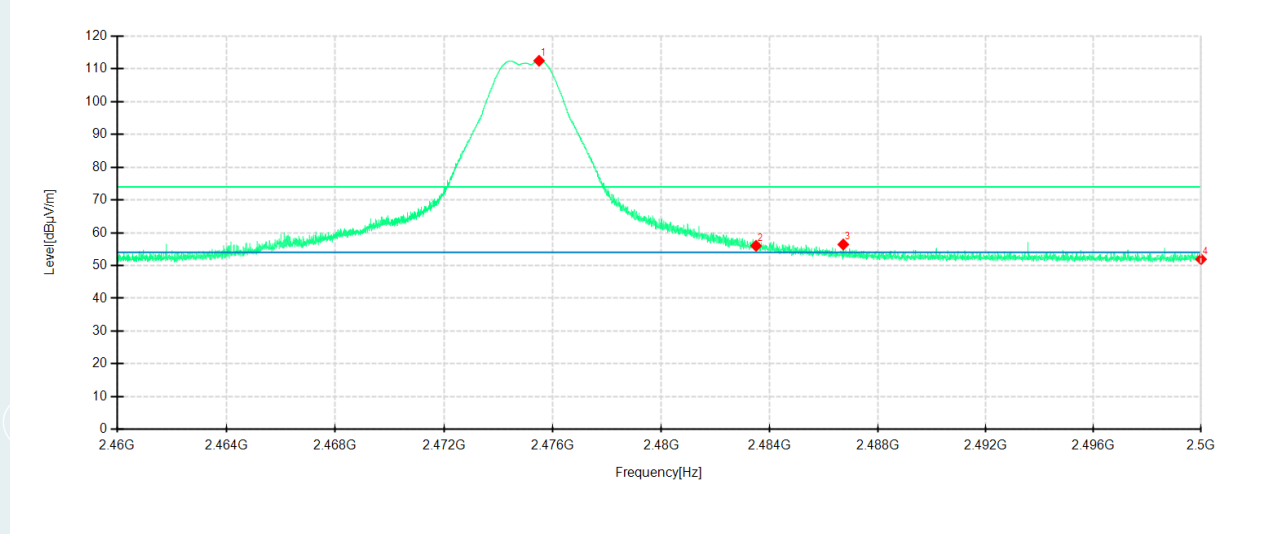

Detector mode: Peak

Polarity: Vertical

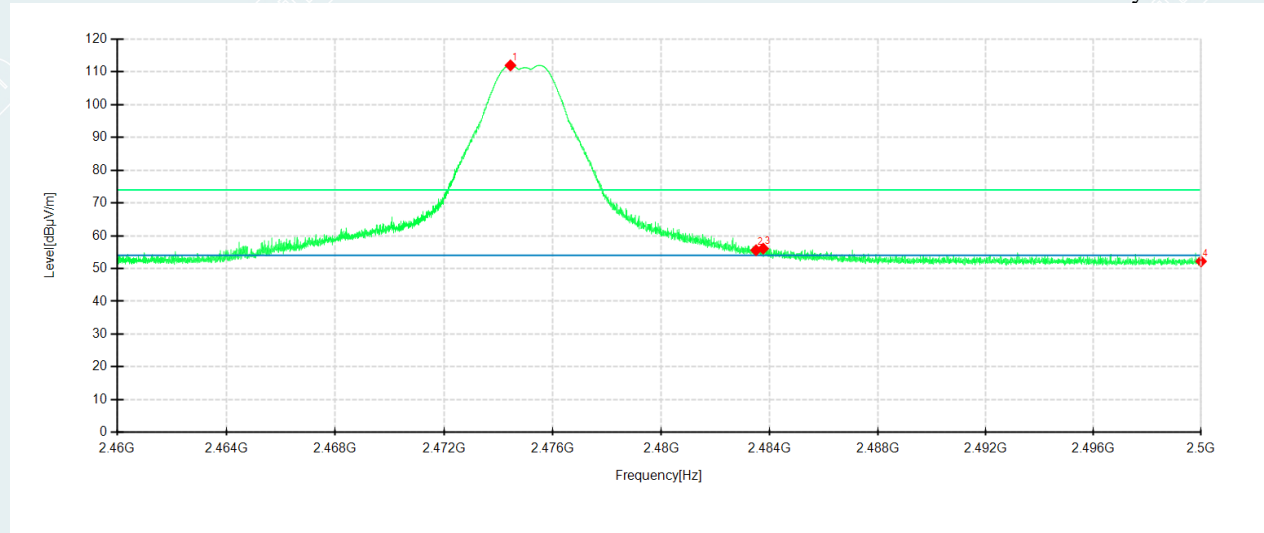

No.	Frequency MHz	Reading dBμV/m	Level dBμV/m	Factor dB	Limit dBuV/m	Margin dB	Height cm	Angle °	Pole	Comment
1	2475.4950	106.95	112.45	5.50	74.00	-38.45	100	138	Horizontal	No limit
2	2483.5000	50.39	56.02	5.63	74.00	17.98	100	38	Horizontal	/
3	2486.7250	50.74	56.42	5.68	74.00	17.58	100	88	Horizontal	/
4	2500.0000	46.02	51.92	5.90	74.00	22.08	100	88	Horizontal	/
1	2474.4400	106.28	111.97	5.69	74.00	-37.97	100	205	Vertical	No limit
2	2483.5000	49.90	55.60	5.70	74.00	18.40	100	205	Vertical	/
3	2483.7650	50.38	56.08	5.70	74.00	17.92	100	136	Vertical	/
4	2500.0000	46.50	52.20	5.70	74.00	21.80	100	69	Vertical	/

Highest Channel

Frequency: 2475MHz

Detector mode: Average

Polarity: Horizontal

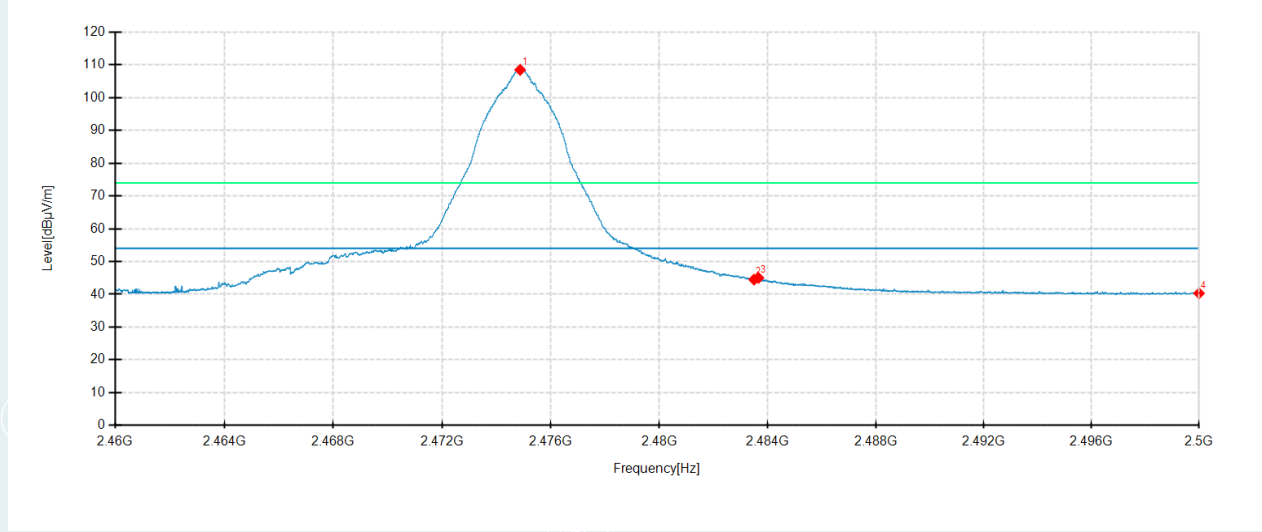

Detector mode: Average

Polarity: Vertical

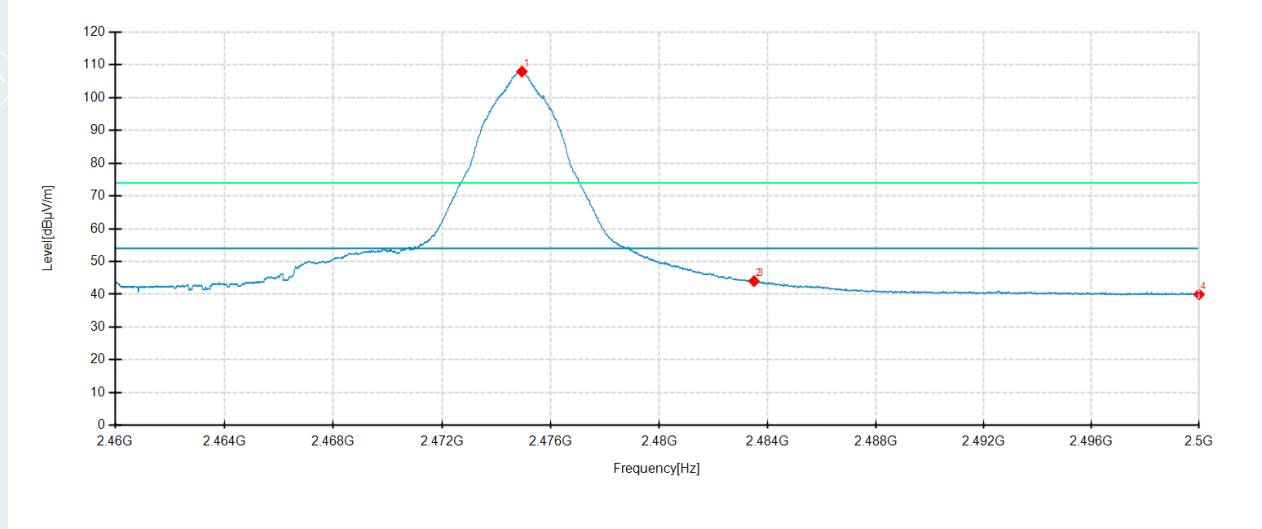

No.	Frequency MHz	Reading dBμV/m	Level dBμV/m	Factor dB	Limit dBuV/m	Margin dB	Height cm	Angle °	Pole	Comment
1	2474.8700	102.98	108.47	5.49	54.00	-54.47	100	139	Horizontal	No limit
2	2483.5000	38.86	44.49	5.63	54.00	9.51	100	106	Horizontal	/
3	2483.6650	39.37	45.01	5.64	54.00	8.99	100	106	Horizontal	/
4	2500.0000	34.41	40.31	5.90	54.00	13.69	100	55	Horizontal	/
1	2474.9350	102.25	107.94	5.69	54.00	-53.94	100	205	Vertical	No limit
2	2483.5000	38.31	44.01	5.70	54.00	9.99	100	205	Vertical	/
3	2483.5900	38.42	44.12	5.70	54.00	9.88	100	256	Vertical	/
4	2500.0000	34.28	39.98	5.70	54.00	14.02	200	320	Vertical	/

Remark: Max field strength in 3m distance. No any other emission which falls in restricted bands can be detected and be reported.

APPENDIX A. PHOTOGRAPH OF THE TEST CONNECTION DIAGRAM

Please refer to the attached document E20230331478001-30 FCC ISED-Test Photo.

APPENDIX B. PHOTOGRAPH OF THE EUT

Please refer to the attached document E20230331478001-29 EUT photo.

----- End of Report -----