



# FCC 47 CFR PART 15 SUBPART E

for

**ProDrone Remote Controller**

**Model: CME01-M2**

**Brand: N/A**

**Test Report Number:**

**C160317Z02-RP1-4**

**Issued Date: March 09, 2017**

Issued for

**Prodrone Technology (Shenzhen) Co.,Ltd**

**8th Floor, Beike Building, South High Technology Park, Nanshan District,  
Shenzhen**

Issued by:

**Compliance Certification Services (Shenzhen) Inc.**

No.10-1 Mingkeda Logistics park, No.18, Huanguan South Rd.,

Guan Lan Town, Baoan District, Shenzhen, China

TEL: 86-755-28055000

FAX: 86-755-28055221

E-Mail: [service@ccssz.com](mailto:service@ccssz.com)



TESTING CERT #2861.01

**Note:** This report shall not be reproduced except in full, without the written approval of Compliance Certification Services (Shenzhen) Inc. This document may be altered or revised by Compliance Certification Services (Shenzhen) Inc. personnel only, and shall be noted in the revision section of the document. The client should not use it to claim product endorsement by TAF, A2LA, NVLAP, NIST or any government agencies. The TEST RESULTS in the report only apply to the tested sample.



Revision History

Rev.	Issue Date	Revisions	Effect Page	Revised By
00	April 1, 2016	Initial Issue	ALL	Sinphy Xie
01	March 09, 2017	First Revision	P1-3, P24-26, P39-42	Sinphy Xie



**TABLE OF CONTENTS**

**1. TEST CERTIFICATION ..... 4**

**2. EUT DESCRIPTION..... 5**

**3. TEST METHODOLOGY..... 7**

    3.1 EUT CONFIGURATION..... 7

    3.2 EUT EXERCISE..... 7

    3.3 GENERAL TEST PROCEDURES ..... 7

    3.4 FCC PART 15.205 RESTRICTED BANDS OF OPERATIONS ..... 8

    3.5 DESCRIPTION OF TEST MODES ..... 9

**4. SETUP OF EQUIPMENT UNDER TEST ..... 10**

    4.1 DESCRIPTION OF SUPPORT UNITS..... 10

    4.2 CONFIGURATION OF SYSTEM UNDER TEST ..... 10

**5. FACILITIES AND ACCREDITATIONS ..... 11**

    5.1 FACILITIES..... 11

    5.2 EQUIPMENT..... 11

    5.3 ACCREDITATIONS ..... 11

    5.4 MEASUREMENT UNCERTAINTY..... 12

**6. FCC PART 15 REQUIREMENTS ..... 13**

    6.1 26dB EMISSION BANDWIDTH ..... 13

    6.2 6dB BANDWIDTH MEASUREMENT ..... 18

    6.3 ANTENNA GAIN ..... 23

    6.4 PEAK POWER ..... 24

    6.5 BAND EDGES MEASUREMENT..... 27

    6.6 PEAK POWER SPECTAL DENSITY ..... 30

    6.7 RADIATED UNDESIRABLE EMISSION..... 36

    6.8 CONDUCTED UNDESIRABLE EMISSION ..... 52

    6.9 POWERLINE CONDUCTED EMISSIONS..... 56

    6.10 FREQUENCY STABILITY..... 60



# 1. TEST CERTIFICATION

<b>Product</b>	ProDrone Remote Controller
<b>Model</b>	CME01-M2
<b>Brand</b>	N/A
<b>Tested</b>	March 17~31, 2016
<b>Applicant</b>	<b>Prodrone Technology (Shenzhen) Co.,Ltd</b> 8th Floor, Beike Building, South High Technology Park, Nanshan District, Shenzhen
<b>Manufacturer</b>	<b>Prodrone Technology (Shenzhen) Co.,Ltd</b> 8th Floor, Beike Building, South High Technology Park, Nanshan District, Shenzhen

APPLICABLE STANDARDS	
STANDARD	TEST RESULT
FCC 47 CFR Part 15 Subpart E	No non-compliance noted

**We hereby certify that:**

Compliance Certification Services (Shenzhen) Inc. tested the above equipment. The test data, data evaluation, test procedures, and equipment configurations shown in this report were made in accordance with the procedures given in **ANSI C63.10: 2013** and the energy emitted by the sample EUT tested as described in this report is in compliance with conducted and radiated emission limits of FCC Rules Part 15.407、FCC 14-30.

The TEST RESULTS of this report relate only to the tested sample identified in this report.

**Approved by:**

**Reviewed by:**

---

Sunday Hu  
Supervisor of EMC Dept.  
Compliance Certification Services (Shenzhen) Inc.

---

Ruby Zhang  
Supervisor of Report Dept.  
Compliance Certification Services (Shenzhen) Inc.



## 2. EUT DESCRIPTION

<b>Product</b>	ProDrone Remote Controller
<b>Model Number</b>	CME01-M2
<b>Brand</b>	N/A
<b>Model Discrepancy</b>	N/A
<b>Serial Number</b>	C160317Z02-RP1-4
<b>Received Date</b>	March 17, 2016
<b>Power Supply</b>	DC16.8V powered by adapter or DC7.4V powered by battery
<b>Adapter Manufacturer / Model No.</b>	ProDrone / CPD-BC00 INPUT: AC 100-240V~1.5A(max) 50/60Hz OUTPUT: DC16.8V, 4A , 67W AC Cable: Unshielded, 1.40m DC Cable: Unshielded, 0.35m
<b>Battery specification</b>	Model: 18650 Output: 5000mAh, 7.4VDC
<b>Frequency Range</b>	5745MHz ~ 5810MHz
<b>Transmit Power</b>	Antenna 1: 20.14dBm Antenna 2: 19.67dBm
<b>Modulation Technique</b>	OFDM (QPSK, BPSK, 16-QAM, 64-QAM)
<b>Number of Channels</b>	66 Channels
<b>Antenna Specification</b>	Dipole antenna with 2dBi gain (Max)
<b>Channels Spacing</b>	1MHz
<b>Temperature Range</b>	-10°C ~ +50°C

**Note:** 1. The sample selected for test was engineering sample that approximated to production product and was provided by manufacturer.



**Operation Frequency:**

<b>UNLICENSED NATIONAL INFORMATION INFRASTRUCTURE (U-NII)</b>			
<b>CHANNEL</b>	<b>MHz</b>	<b>CHANNEL</b>	<b>MHz</b>
1	5745	34	5778
2	5746	35	5779
3	5747	36	5780
4	5748	37	5781
5	5749	38	5782
6	5750	39	5783
7	5751	40	5784
8	5752	41	5785
9	5753	42	5786
10	5754	43	5787
11	5755	44	5788
12	5756	45	5789
13	5757	46	5790
14	5758	47	5791
15	5759	48	5792
16	5760	49	5793
17	5761	50	5794
18	5762	51	5785
19	5763	52	5796
20	5764	53	5797
21	5765	54	5788
22	5766	55	5799
23	5767	56	5800
24	5768	57	5801
25	5769	58	5802
26	5770	59	5803
27	5771	60	5804
28	5772	61	5805
29	5773	62	5806
30	5774	63	5807
31	5775	64	5808
32	5776	65	5809
33	5777	66	5810

*Remark:*

1. The sample selected for test was engineering sample that approximated to production product and was provided by manufacturer.
2. This submittal(s) (test report) is intended for FCC ID: 2AGKH-PD-RC01-0103 filing to comply with Section 15.407 of the FCC Part 15, Subpart E Rules and FCC 14-30.



### 3. TEST METHODOLOGY

Both conducted and radiated testing was performed according to the procedures in ANSI C63.10 Radiated testing was performed at an antenna to EUT distance 3 meters.

The tests documented in this report were performed in accordance with ANSI C63.10: 2013 and FCC CFR 47 Part 15.207, 15.209, 15.407 and FCC 14-30.

Radio testing was performed according to KDB DA 02-2138、KDB 789033 D02、KDB 905462 D06;

#### 3.1 EUT CONFIGURATION

The EUT configuration for testing is installed for RF field strength measurement to meet the Commissions requirement, and is operated in a manner intended to generate the maximum emission in a continuous normal application.

#### 3.2 EUT EXERCISE

The EUT is operated in the engineering mode to fix the TX frequency for the purposes of measurement.

According to its specifications, the EUT must comply with the requirements of Section 15.407 under the FCC Rules Part 15 Subpart E.

#### 3.3 GENERAL TEST PROCEDURES

##### Conducted Emissions

The EUT is placed on the turntable, which is positioned at 0.8 m above the ground plane. According to the requirements in Section 13.1.4.1 of ANSI C63.10, the conducted emission from the EUT is measured in the frequency range between 0.15 MHz and 30MHz, using the CISPR Quasi-Peak detector mode.

##### Radiated Emissions

The EUT is placed on the turntable, which is 0.8 m (below 1GHz) or 1.5m (above 1GHz) above the ground plane. The turntable is then rotated for 360 degrees to determine the proper orientation for the maximum emission level. The EUT is set 3m away from the receiving antenna, which is varied from 1m to 4m to find out the highest emission level. And, each emission is to be maximized by changing the horizontal and vertical polarization of the receiving antenna. In order to find out the maximum emissions, exploratory radiated emission measurements were made according to the requirements in Section 13.1.4.1 of ANSI C63.10.



### 3.4 FCC PART 15.205 RESTRICTED BANDS OF OPERATIONS

(a) Except as shown in paragraph (d) of this section, only spurious emissions are permitted in any of the frequency bands listed below:

MHz	MHz	MHz	GHz
0.090 - 0.110	16.42 - 16.423	399.9 - 410	4.5 - 5.15
<sup>1</sup> 0.495 - 0.505	16.69475 - 16.69525	608 - 614	5.35 - 5.46
2.1735 - 2.1905	16.80425 - 16.80475	960 - 1240	7.25 - 7.75
4.125 - 4.128	25.5 - 25.67	1300 - 1427	8.025 - 8.5
4.17725 - 4.17775	37.5 - 38.25	1435 - 1626.5	9.0 - 9.2
4.20725 - 4.20775	73 - 74.6	1645.5 - 1646.5	9.3 - 9.5
6.215 - 6.218	74.8 - 75.2	1660 - 1710	10.6 - 12.7
6.26775 - 6.26825	108 - 121.94	1718.8 - 1722.2	13.25 - 13.4
6.31175 - 6.31225	123 - 138	2200 - 2300	14.47 - 14.5
8.291 - 8.294	149.9 - 150.05	2310 - 2390	15.35 - 16.2
8.362 - 8.366	156.52475 -	2483.5 - 2500	17.7 - 21.4
8.37625 - 8.38675	156.52525	2655 - 2900	22.01 - 23.12
8.41425 - 8.41475	156.7 - 156.9	3260 - 3267	23.6 - 24.0
12.29 - 12.293	162.0125 - 167.17	3332 - 3339	31.2 - 31.8
12.51975 - 12.52025	167.72 - 173.2	3345.8 - 3358	36.43 - 36.5
12.57675 - 12.57725	240 - 285	3600 - 4400	( <sup>2</sup> )
13.36 - 13.41	322 - 335.4		

<sup>1</sup> Until February 1, 1999, this restricted band shall be 0.490-0.510 MHz.

<sup>2</sup> Above 38.6

(b) Except as provided in paragraphs (d) and (e), the field strength of emissions appearing within these frequency bands shall not exceed the limits shown in Section 15.209. At frequencies equal to or less than 1000 MHz, compliance with the limits in Section 15.209 shall be demonstrated using measurement instrumentation employing a CISPR quasi-peak detector. Above 1000 MHz, compliance with the emission limits in Section 15.209 shall be demonstrated based on the average value of the measured emissions. The provisions in Section 15.35 apply to these measurements.





### 3.5 DESCRIPTION OF TEST MODES

The EUT is a 2x2 configuration spatial, two antenna can transmitting, but at the same time only one antenna which link better can work.

Software used to control the EUT for staying in continuous transmitting mode was programmed.

Test Item	Test mode	Worse mode
Conducted Emission	<b>Mode 1:</b> Charge	<input checked="" type="checkbox"/>
Radiated Emission	<b>Mode 1:</b> TX Antenna 1 <b>Mode 2:</b> TX Antenna 2	<input checked="" type="checkbox"/>

After verification, all tests were carried out with the worst case test modes as shown below except radiated spurious emission below 1GHz, which worst case was in normal link mode only.

Channel Low (5745MHz), Channel Mid (5785MHz) and Channel High (5810MHz) with 6Mbps data rate were chosen for full testing.



## 4. SETUP OF EQUIPMENT UNDER TEST

### 4.1 DESCRIPTION OF SUPPORT UNITS

The EUT has been tested as an independent unit together with other necessary accessories or support units. The following support units or accessories were used to form a representative test configuration during the tests.

No.	Equipment	Model No.	Serial No.	FCC ID	Brand	Data Cable	Power Cord
1	Notebook	B475	WB04861612	DoC	LENOVO	N/A	Unshielded, 1.80m

**Note:**

Grounding was established in accordance with the manufacturer’s requirements and conditions for the intended use.

### 4.2 CONFIGURATION OF SYSTEM UNDER TEST

See test photographs attached in Appendix II for the actual connections between EUT and support equipment.



## **5. FACILITIES AND ACCREDITATIONS**

### **5.1 FACILITIES**

All measurement facilities used to collect the measurement data are located at **No.10-1 Mingkeda Logistics park, No.18, Huanguan South Rd., Guan Lan Town, Baoan District, Shenzhen, China**

The sites are constructed in conformance with the requirements of ANSI C63.10, ANSI C63.7 and CISPR Publication 22.

### **5.2 EQUIPMENT**

Radiated emissions are measured with one or more of the following types of linearly polarized antennas: tuned dipole, biconical, log periodic, bi-log, and/or ridged waveguide, horn. Spectrum analyzers with pre-selectors and quasi-peak detectors are used to perform radiated measurements.

Conducted emissions are measured with Line Impedance Stabilization Networks and EMI Test Receivers.

Calibrated wideband preamplifiers, coaxial cables, and coaxial attenuators are also used for making measurements.

All receiving equipment conforms to CISPR Publication 16-1, "Radio Interference Measuring Apparatus and Measurement Methods."

### **5.3 ACCREDITATIONS**

Our laboratories are accredited and approved by the following accreditation body according to ISO/IEC 17025.

<b>USA</b>	<b>A2LA</b>
<b>China</b>	<b>CNAS</b>

The measuring facility of laboratories has been authorized or registered by the following approval agencies.

<b>USA</b>	<b>FCC</b>
<b>Japan</b>	<b>VCCI(C-4815, R-4320, T-2317, G-10624)</b>
<b>Canada</b>	<b>INDUSTRY CANADA</b>

Copies of granted accreditation certificates are available for downloading from our web site, <http://www.ccssz.com>



## 5.4 MEASUREMENT UNCERTAINTY

Parameter	Uncertainty
RF frequency	+/-1 * 10 <sup>-5</sup>
RF power conducted	+/- 1,5 dB
RF power radiated	+/- 6 dB
Spurious emissions, conducted	+/- 3 dB
Spurious emissions, radiated	+/- 6 dB
Humidity	+/- 5 %
Temperature	+/- 1°C
Time	+/-10 %

**Remark:** This uncertainty represents an expanded uncertainty expressed at approximately the 95% confidence level using a coverage factor of  $k=2$ .



## 6. FCC PART 15 REQUIREMENTS

### 6.1 26dB EMISSION BANDWIDTH

#### 6.1.1 LIMIT

According to §15.303(c), for purposes of this subpart the emission bandwidth shall be determined by measuring the width of the signal between two points, one below the carrier center frequency and one above the carrier center frequency, that are 26 dB down relative to the maximum level of the modulated carrier. Compliance with the emissions limits is based on the use of measurement instrumentation employing a peak detector function with an instrument resolutions bandwidth approximately equal to 1.0 percent of the emission bandwidth of the device under measurement.

#### 6.1.2 MEASUREMENT EQUIPMENT USED

Name of Equipment	Manufacturer	Model	Serial Number	Last Calibration	Due Calibration
Spectrum Analyzer	Agilent	N9010A	MY52221469	10/25/2015	10/24/2016

*Remark: Each piece of equipment is scheduled for calibration once a year.*

#### 6.1.3 TEST CONFIGURATION

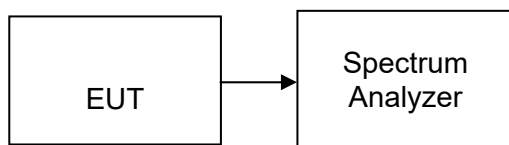

#### 6.1.4 TEST PROCEDURE

1. Place the EUT on the table and set it in the transmitting mode.
2. Remove the antenna from the EUT and then connect a low-loss RF cable from the antenna port to the spectrum analyzer.
3. Set the spectrum analyzer as RBW > 1%EBW, VBW > RBW, Span >26dB bandwidth, Detector = Peak, and Sweep = auto.
4. Mark the peak frequency and -26dB (upper and lower) frequency.
5. Repeat until all the rest channels were investigated.



### 6.1.5 TEST RESULTS

*No non-compliance noted*

#### Test Data

##### Antenna 1

5745 ~ 5810MHz

Channel	Frequency (MHz)	Bandwidth(B) (MHz)
Low	5745	2.411
Mid	5777	2.738
High	5810	2.754

##### Antenna 2

5745 ~ 5810MHz

Channel	Frequency (MHz)	Bandwidth(B) (MHz)
Low	5745	2.431
Mid	5777	2.710
High	5810	2.738



### Test Plot Antenna 1

#### 26dB Bandwidth (CH Low)

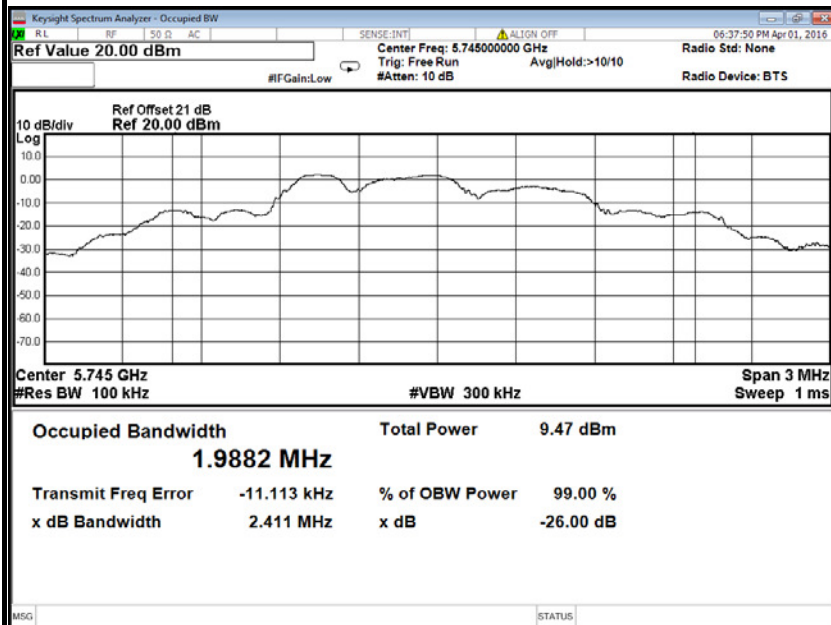

#### 26dB Bandwidth (CH Mid)

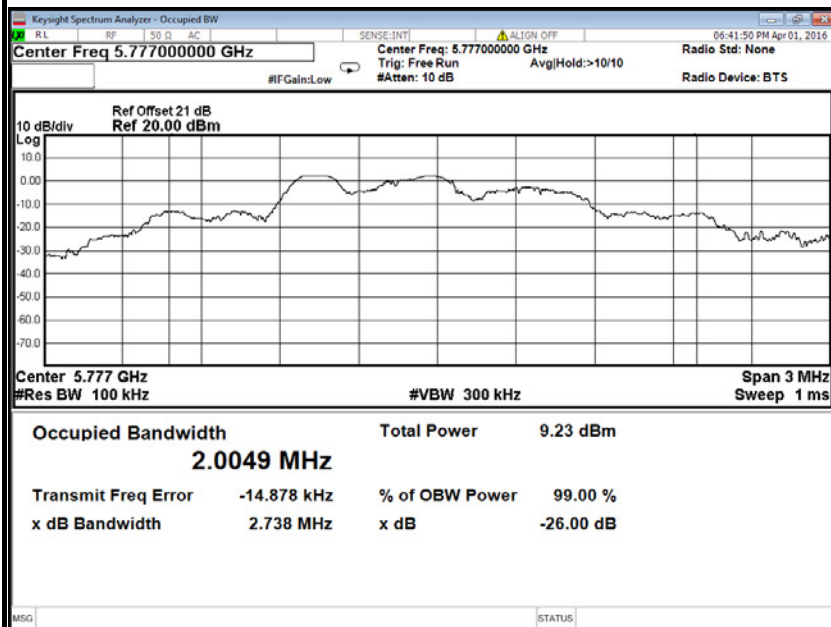



### 26dB Bandwidth (CH High)

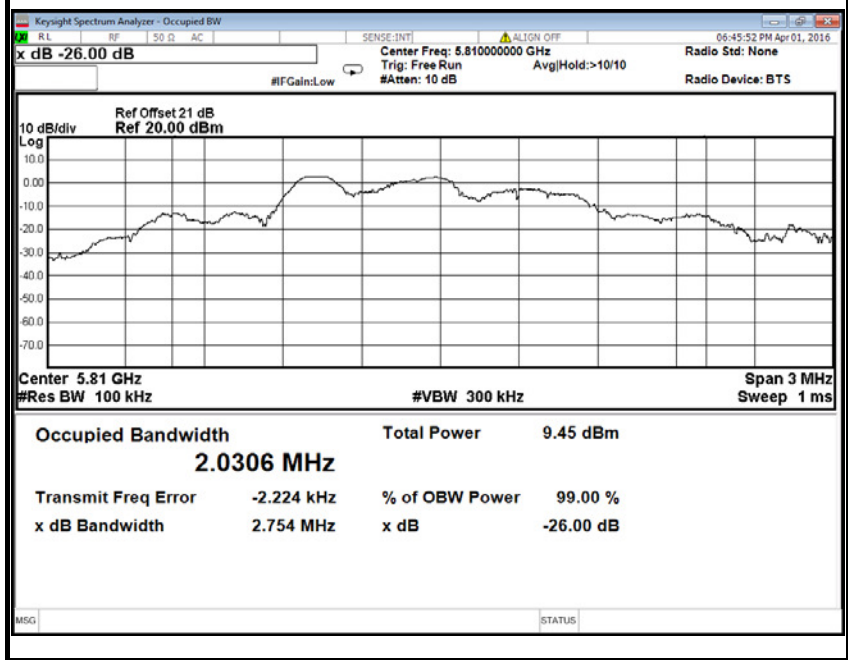

### Antenna 2

### 26dB Bandwidth (CH Low)

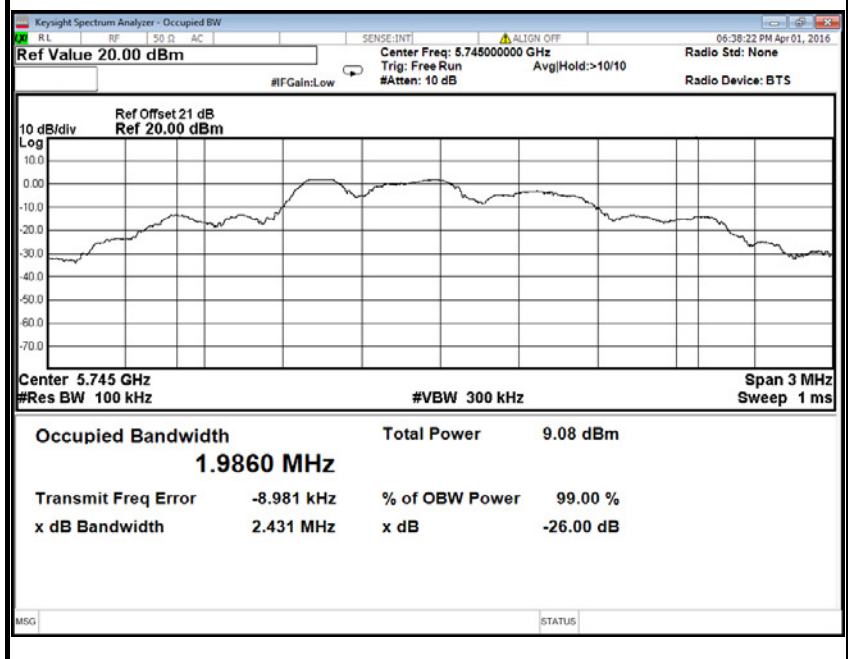



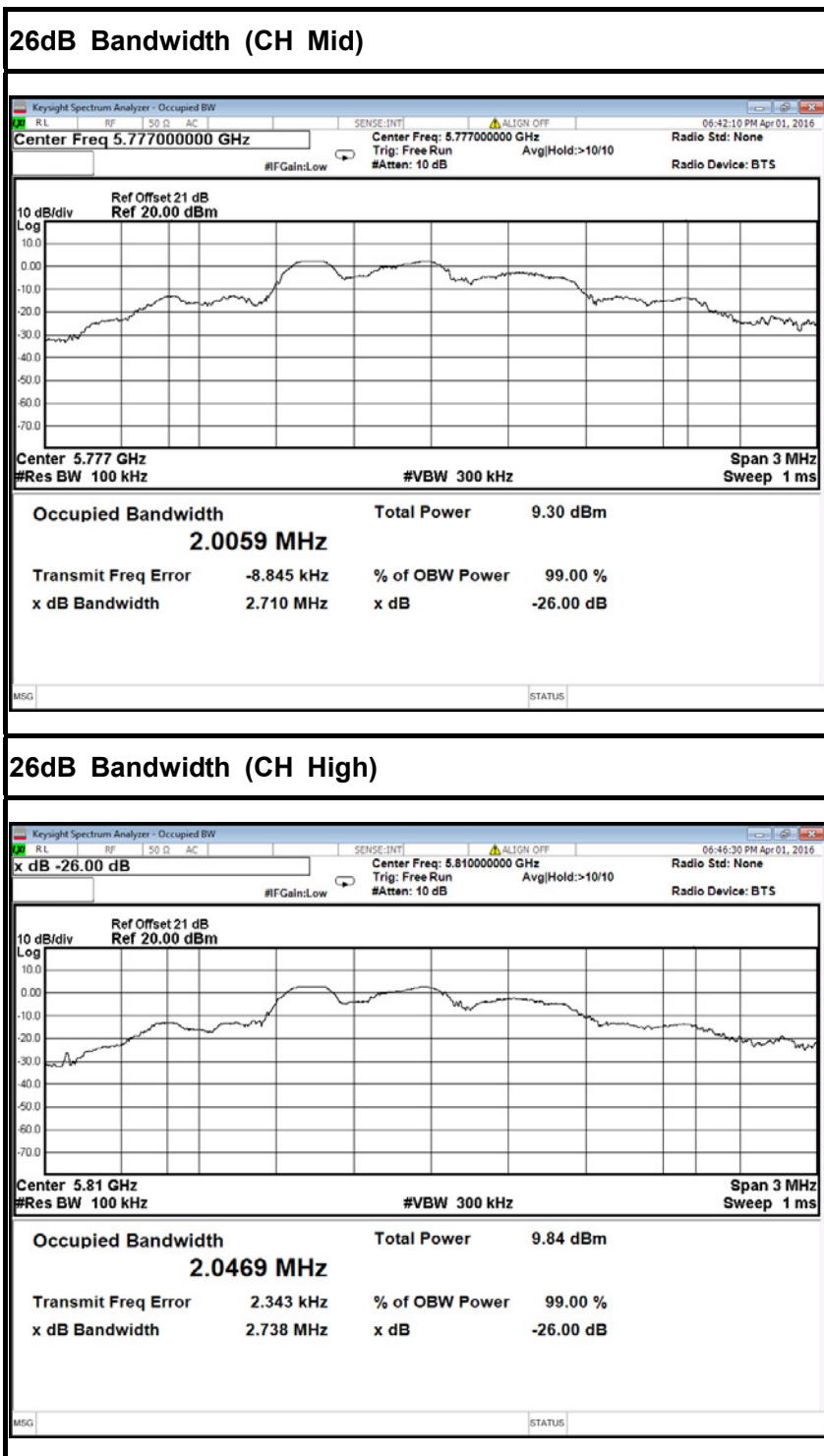



## 6.2 6dB BANDWIDTH MEASUREMENT

### 6.2.1 LIMITS

According to §15.407(e), Within the 5.725-5.85 GHz band, the minimum 6 dB bandwidth of U-NII devices shall be at least 500 kHz.

### 6.2.2 TEST INSTRUMENTS

Name of Equipment	Manufacturer	Model	Serial Number	Last Calibration	Calibration Due
Spectrum Analyzer	Agilent	N9010A	MY52221469	10/25/2015	10/24/2016

### 6.2.3 TEST PROCEDURES (please refer to measurement standard)

#### 8.1 Option 1:

- a) Set RBW = 100 kHz.
- b) Set the video bandwidth (VBW)  $\geq 3 \times$  RBW.
- c) Detector = Peak.
- d) Trace mode = max hold.
- e) Sweep = auto couple.
- f) Allow the trace to stabilize.
- g) Measure the maximum width of the emission that is constrained by the frequencies associated with the two outermost amplitude points (upper and lower frequencies) that are attenuated by 6 dB relative to the maximum level measured in the fundamental emission.

### 6.2.4 TEST SETUP

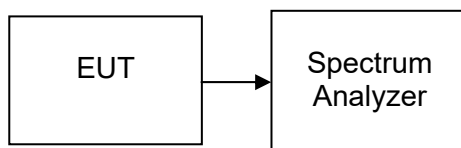



### 6.2.5 TEST RESULTS

*No non-compliance noted*

#### Test Data

##### Antenna 1

5745 ~ 5810MHz

Channel	Frequency (MHz)	Bandwidth(B) (MHz)	Limit (kHz)	Test Result
Low	5745	0.985	>500	PASS
Mid	5777	0.991		PASS
High	5810	1.016		PASS

##### Antenna 2

5745 ~ 5810MHz

Channel	Frequency (MHz)	Bandwidth(B) (MHz)	Limit (kHz)	Test Result
Low	5745	0.987	>500	PASS
Mid	5777	0.986		PASS
High	5810	1.016		PASS



Antenna 1

5745 ~ 5810MHz

6dB Bandwidth (CH Low)

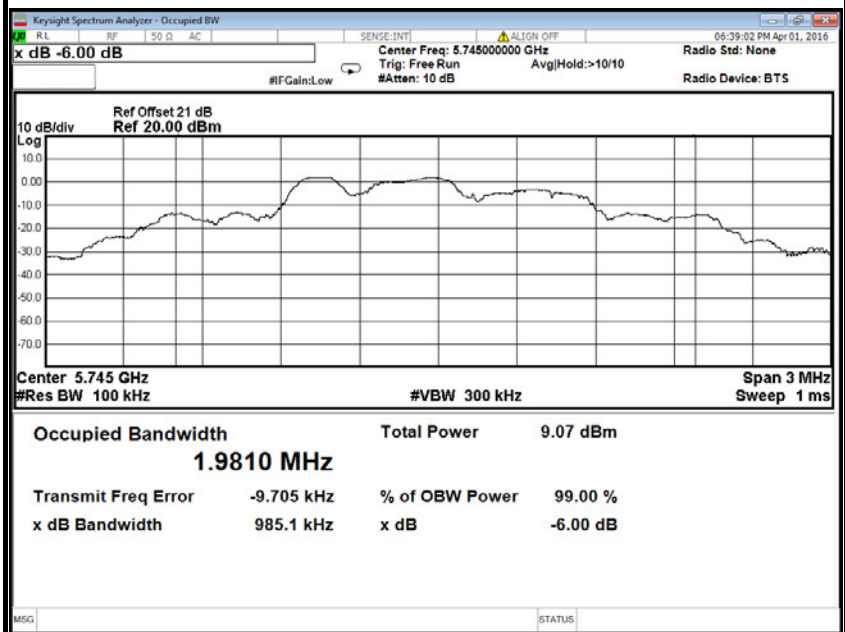

6dB Bandwidth (CH Mid)

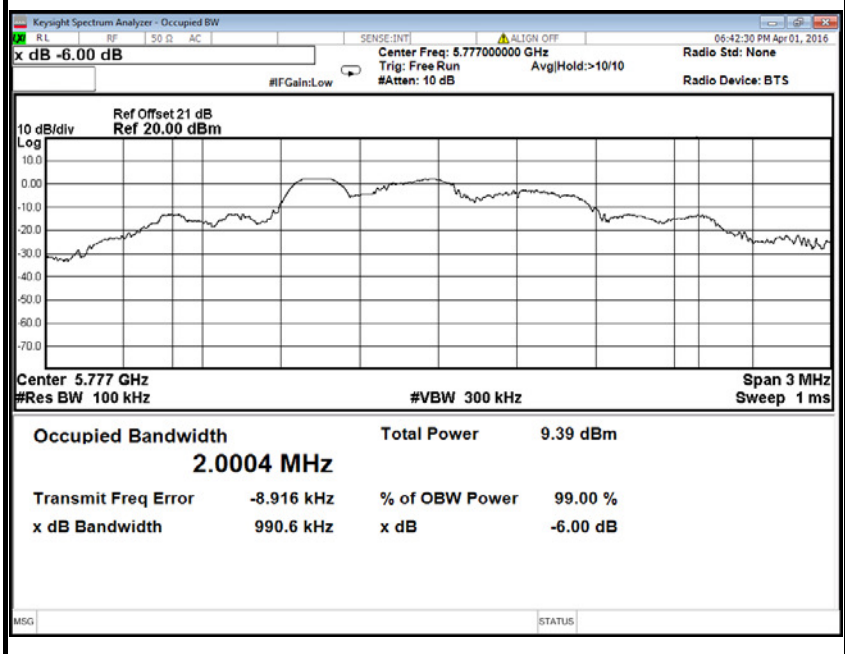

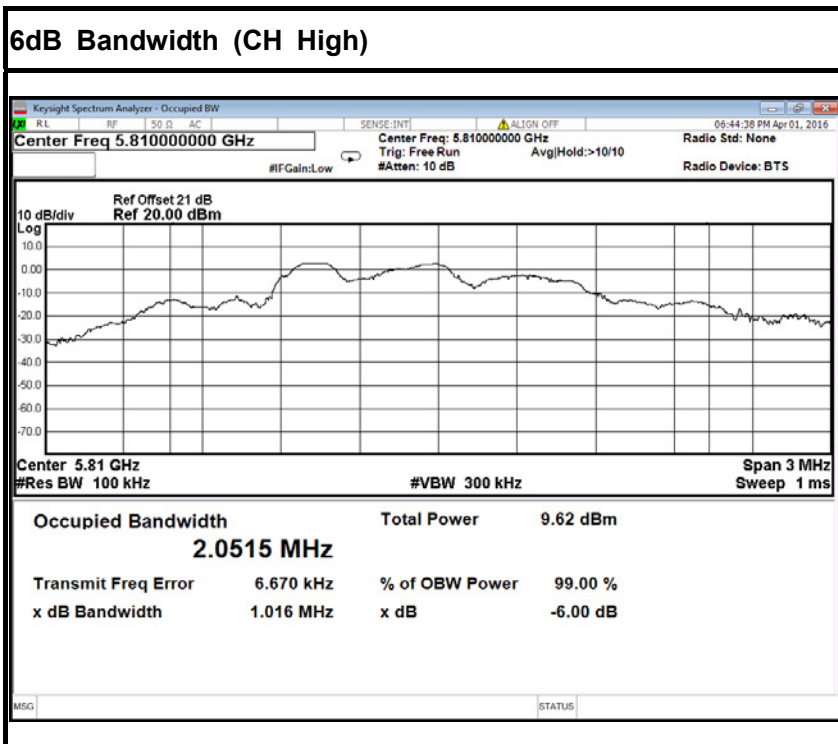

### Antenna 2

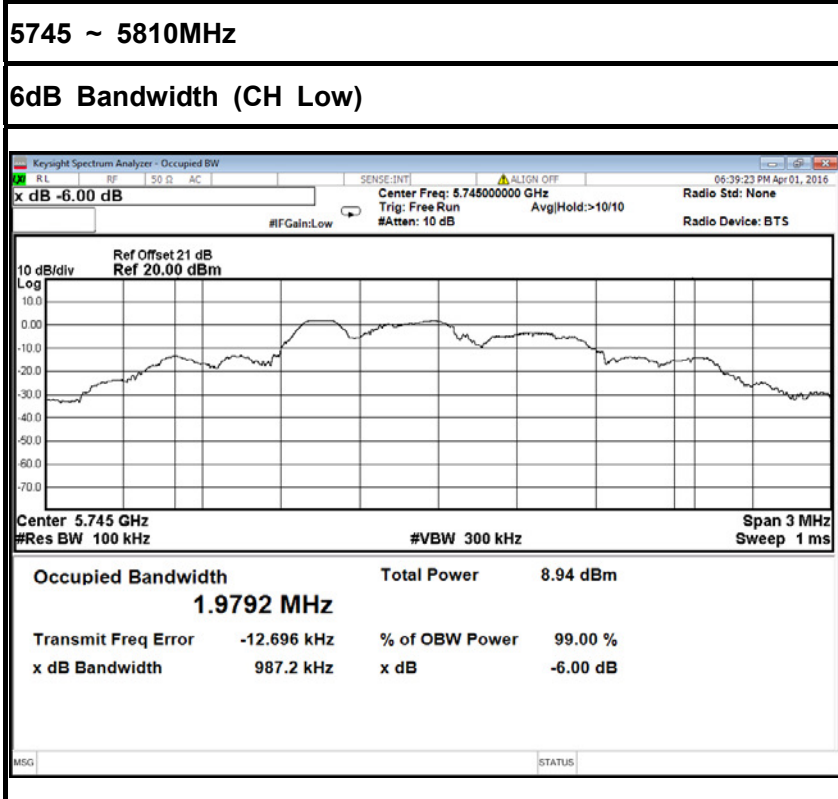

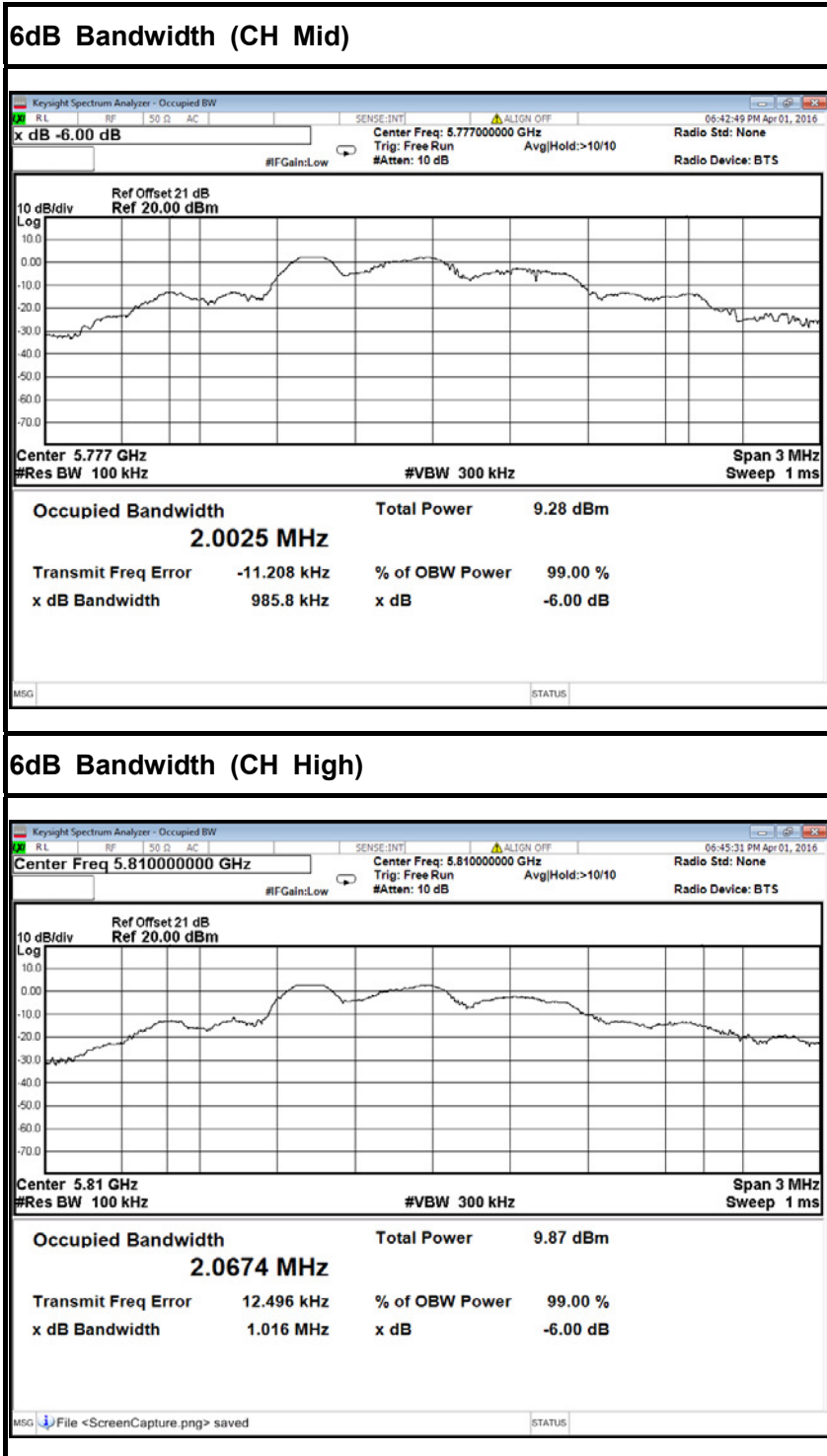



## 6.3 ANTENNA GAIN

### MEASUREMENT

The antenna gain of the complete system is calculated by the difference of radiated power in EIRP and the conducted power of the module. For normal WLAN devices, the OFDM mode is used.

### MEASUREMENT PARAMETERS

Measurement parameter	
Detector	Peak
Sweep time	Auto
Resolution bandwidth	3 MHz
Video bandwidth	3 MHz
Trace-Mode	Max hold

### LIMITS

FCC	IC
Antenna Gain	
6 dBi	

### TEST RESULTS

#### Antenna 1

T <sub>nom</sub>	V <sub>nom</sub>	Lowest channel 5745MHz	Highest channel 5810MHz
Conducted power [dBm] Measured with OFDM modulation		20.21	18.17
Radiated power [dBm] Measured with OFDM modulation		18.70	13.70
Gain [dBi] Calculated		-1.51	-4.47
Measurement uncertainty		± 1.5 dB (cond.) / ± 3 dB (rad.)	



## 6.4 OUTPUT POWER

### 6.4.1 LIMIT

#### According to §15.407(a)& FCC R&O FCC 14 - 30,

- (1) (i) For an outdoor access point operating in the band 5.15 – 5.25 GHz, the maximum conducted output power over the frequency band of operation shall not exceed 1 W provided the maximum antenna gain does not exceed 6 dBi. In addition, the maximum power spectral density shall not exceed 17 dBm in any 1 megahertz band. If transmitting antennas of directional gain greater than 6 dBi are used, both the maximum conducted output power and the maximum power spectral density shall be reduced by the amount in dB that the directional gain of the antenna exceeds 6 dBi. The maximum e.i.r.p. at any elevation angle above 30 degrees as measured from the horizon must not exceed 125 mW (21 dBm).
- (2) (ii) For an indoor access point operating in the band 5.15 – 5.25 GHz, the maximum conducted output power over the frequency band of operation shall not exceed 1 W provided the maximum antenna gain does not exceed 6 dBi. In addition, the maximum power spectral density shall not exceed 17 dBm in any 1 megahertz band. If transmitting antennas of directional gain greater than 6 dBi are used, both the maximum conducted output power and the maximum power spectral density shall be reduced by the amount in dB that the directional gain of the antenna exceeds 6 dBi.
- (3) For the band 5.725-5.85 GHz, the maximum conducted output power over the frequency band of operation shall not exceed 1 W. In addition, the maximum power spectral density shall not exceed 30dBm in any 500 kHz band. If transmitting antennas of directional gain greater than 6 dBi are used, both the maximum conducted output power and the maximum power spectral density shall be reduced by the amount in dB that the directional gain of the antenna exceeds 6 dBi. However, fixed point-to-point U-NII devices operating in this band may employ transmitting antennas with directional gain greater than 6 dBi without any corresponding reduction in transmitter conducted power. Fixed, point-to-point operations exclude the use of point-to-multipoint systems, omnidirectional applications, and multiple collocated transmitters transmitting the same information. The operator of the U-NII device, or if the equipment is professionally installed, the installer, is responsible for ensuring that systems employing high gain directional antennas are used exclusively for fixed, point-to-point operations.

*If transmitting antennas of directional gain greater than 6dBi are used, both the peak transmit power and the peak power spectral density shall be reduced by the amount in dB that the directional gain of the antenna exceeds 6dBi.*





### 6.4.2 MEASUREMENT EQUIPMENT USED

Name of Equipment	Manufacturer	Model	Serial Number	Last Calibration	Calibration Due
Power Meter	Anritsu	ML2495A	1204003	02/21/2016	02/20/2017
Power Sensor	Anritsu	MA2411B	1126150	02/21/2016	02/20/2017

**Remark:** Each piece of equipment is scheduled for calibration once a year.

### 6.4.3 TEST CONFIGURATIONS

The EUT was connected to the Power meter through a 50Ω RF cable.

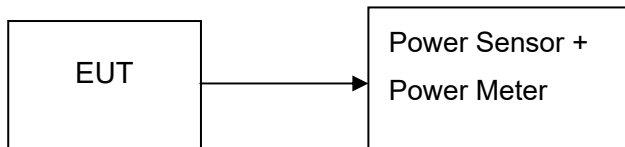

### 6.4.4 TEST PROCEDURE

The EUT was connected to the Power meter through a 50Ω RF cable. Measure the average power of the transmitter using a wideband RF power meter.

### 6.4.5 TEST RESULTS

No non-compliance noted



### 6.4.6 TEST DATA

#### Antenna 1

5745 ~ 5810MHz

Channel	Frequency (MHz)	Output Power (dBm)	AVG Output Power (W)	Limit (dBm)	Result
Low	5745	20.11	0.10257	30.00	PASS
Mid	5777	18.72	0.07447		PASS
High	5810	18.20	0.06607		PASS

#### Antenna 2

5745 ~ 5810MHz

Channel	Frequency (MHz)	Output Power (dBm)	AVG Output Power (W)	Limit (dBm)	Result
Low	5745	18.64	0.07311	30.00	PASS
Mid	5777	18.99	0.07925		PASS
High	5810	18.05	0.06383		PASS



## 6.5 BAND EDGES MEASUREMENT

### 6.5.1 LIMIT

According to §15.407(b)

- (1) The provisions of Section 15.205 of this part apply to intentional radiators operating under this section.
- (2) When measuring the emission limits, the nominal carrier frequency shall be adjusted as close to the upper and lower frequency block edges as the design of the equipment permits.

### 6.5.2 MEASUREMENT EQUIPMENT USED

Radiated Emission Test Site 966(2)					
Name of Equipment	Manufacturer	Model Number	Serial Number	Last Calibration	Due Calibration
EMI TEST RECEIVER	Agilent	E44446A	US44300399	02/21/2016	02/20/2017
EMI TEST RECEIVER	ROHDE&SCHWARZ	ESCI	100783	02/21/2016	02/20/2017
Amplifier	MITEQ	AM-1604-3000	1123808	02/21/2016	02/20/2017
High Noise Amplifier	Agilent	8449B	3008A01838	02/21/2016	02/20/2017
Board-Band Horn Antenna	Schwarzbeck	BBHA 9170	9170-497	02/21/2016	02/20/2017
Bilog Antenna	SCHAFFNER	CBL6143	5082	02/21/2016	02/20/2017
Horn Antenna	SCHWARZBECK	BBHA9120	D286	02/21/2016	02/20/2017
Loop Antenna	COM-POWER	AL-130	121044	02/21/2016	02/20/2017
Turn Table	N/A	N/A	N/A	N.C.R	N.C.R
Controller	Sunol Sciences	SC104V	022310-1	N.C.R	N.C.R
Controller	CT	N/A	N/A	N.C.R	N.C.R
Temp. / Humidity Meter	Anymetre	JR913	N/A	02/21/2016	02/20/2017
Antenna Tower	SUNOL	TLT2	N/A	N.C.R	N.C.R
Test S/W	FARAD	LZ-RF / CCS-SZ-3A2			

- NOTE:**
1. The calibration interval of the above test instruments is 12 months and the calibrations are traceable to NML/ROC and NIST/USA.
  2. The FCC Site Registration number is 101879.
  3. N.C.R = No Calibration Required.



### 6.5.3 TEST CONFIGURATION

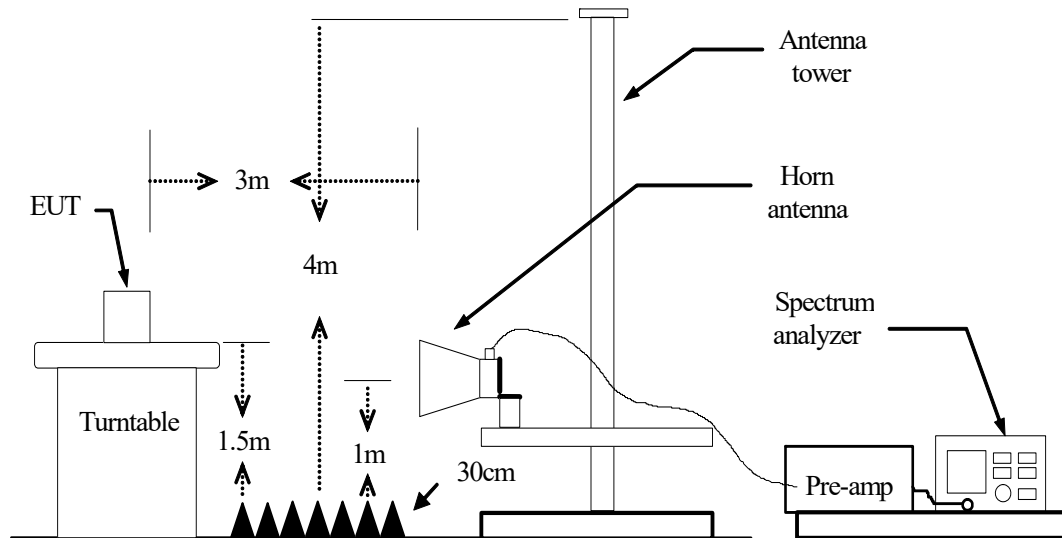

### 6.5.4 TEST PROCEDURE

1. The EUT is placed on a turntable, which is 1.5m above the ground plane.
2. The turntable shall be rotated for 360 degrees to determine the position of maximum emission level.
3. EUT is set 3m away from the receiving antenna, which is varied from 1m to 4m to find out the highest emission.
4. Set the spectrum analyzer in the following setting in order to capture the lower and upper band-edges of the emission:
  - (a) PEAK: RBW=1 / VBW=3MHz / Sweep=AUTO
  - (b) AVERAGE: RBW=1MHz / VBW=10Hz / Sweep=AUTO / Detector=Peak
5. Repeat the procedures until all the PEAK and AVERAGE versus POLARIZATION are measured.



### 6.5.5 TEST RESULT

#### **Antenna 1**

##### **5745 ~ 5810MHz**

1. Operating Frequency: 5745-5810MHz
2. CH Low: 5745MHz, CH High: 5810MHz
3. 26dB bandwidth: CH Low: 2.411MHz, CH High: 2.754MHz
4. Frequency Range: 5743.7945MHz, 5811.3770MHz

#### **Antenna 2**

##### **5745 ~ 5810MHz**

1. Operating Frequency: 5745-5810MHz
2. CH Low: 5745MHz, CH High: 5810MHz
3. 26dB bandwidth: CH Low: 2.431MHz, CH High: 2.738MHz
4. Frequency Range: 5743.7845MHz, 5811.369MHz

Because the mentioned conditions, the test is not applicable.



## 6.6 PEAK POWER SPECTAL DENSITY

### 6.6.1 LIMIT

#### According to §15.407(a) & FCC R&O FCC 14-30

- (1) (i) For an outdoor access point operating in the band 5.15 – 5.25 GHz, the maximum conducted output power over the frequency band of operation shall not exceed 1 W provided the maximum antenna gain does not exceed 6 dBi. In addition, the maximum power spectral density shall not exceed 17 dBm in any 1 megahertz band. If transmitting antennas of directional gain greater than 6 dBi are used, both the maximum conducted output power and the maximum power spectral density shall be reduced by the amount in dB that the directional gain of the antenna exceeds 6 dBi. The maximum e.i.r.p. at any elevation angle above 30 degrees as measured from the horizon must not exceed 125 mW (21 dBm).
- (2) (ii) For an indoor access point operating in the band 5.15 – 5.25 GHz, the maximum conducted output power over the frequency band of operation shall not exceed 1 W provided the maximum antenna gain does not exceed 6 dBi. In addition, the maximum power spectral density shall not exceed 17 dBm in any 1 megahertz band. If transmitting antennas of directional gain greater than 6 dBi are used, both the maximum conducted output power and the maximum power spectral density shall be reduced by the amount in dB that the directional gain of the antenna exceeds 6 dBi.
- (3) For the band 5.725-5.85 GHz, the maximum conducted output power over the frequency band of operation shall not exceed 1 W. In addition, the maximum power spectral density shall not exceed 30dBm in any 500 kHz band. If transmitting antennas of directional gain greater than 6 dBi are used, both the maximum conducted output power and the maximum power spectral density shall be reduced by the amount in dB that the directional gain of the antenna exceeds 6 dBi. However, fixed point-to-point U-NII devices operating in this band may employ transmitting antennas with directional gain greater than 6 dBi without any corresponding reduction in transmitter conducted power. Fixed, point-to-point operations exclude the use of point-to-multipoint systems, omnidirectional applications, and multiple collocated transmitters transmitting the same information. The operator of the U-NII device, or if the equipment is professionally installed, the installer, is responsible for ensuring that systems employing high gain directional antennas are used exclusively for fixed, point-to-point operations.

*If transmitting antennas of directional gain greater than 6dBi are used, both the peak transmit power and the peak power spectral density shall be reduced by the amount in dB that the directional gain of the antenna exceeds 6dBi.*

### 6.6.2 MEASUREMENT EQUIPMENT USED

Name of Equipment	Manufacturer	Model	Serial Number	Last Calibration	Due Calibration
Spectrum Analyzer	Agilent	N9010A	MY52221469	10/25/2015	10/24/2016

**Remark:** Each piece of equipment is scheduled for calibration once a year.



### 6.6.3 TEST CONFIGURATION

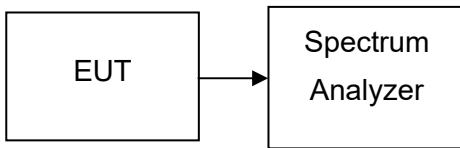

### 6.6.4 TEST PROCEDURE

1. Place the EUT on the table and set it in transmitting mode.  
Remove the antenna from the EUT and then connect a low loss RF cable from the antenna port to the spectrum analyzer.
2. For devices operating in the bands 5.725-5.85 GHz, Set the spectrum analyzer as RBW= 1MHz, VBW = 3MHz, Span = 30MHz, Sweep=1ms
3. Record the max. reading.
4. Repeat the above procedure until the measurements for all frequencies are completed



### 6.6.5 TEST RESULTS

#### Test Data

##### Antenna 1

5745 ~ 5810MHz

Channel	Frequency (MHz)	PPSD (dBm)	factor	Limit (dBm)	Margain	Result
Low	5745	17.271	-3.01	30	-15.739	PASS
Mid	5777	16.882	-3.01		-16.128	PASS
High	5810	16.559	-3.01		-16.451	PASS

##### Antenna 2

5745 ~ 5810MHz

Channel	Frequency (MHz)	PPSD (dBm)	factor	Limit (dBm)	Margain	Result
Low	5745	17.261	-3.01	30	-15.749	PASS
Mid	5777	16.891	-3.01		-16.119	PASS
High	5810	16.543	-3.01		-16.467	PASS

Remark: factor =  $10 \cdot \log_{10}(500/\text{RBW})$





### Test Plot

#### Antenna 1



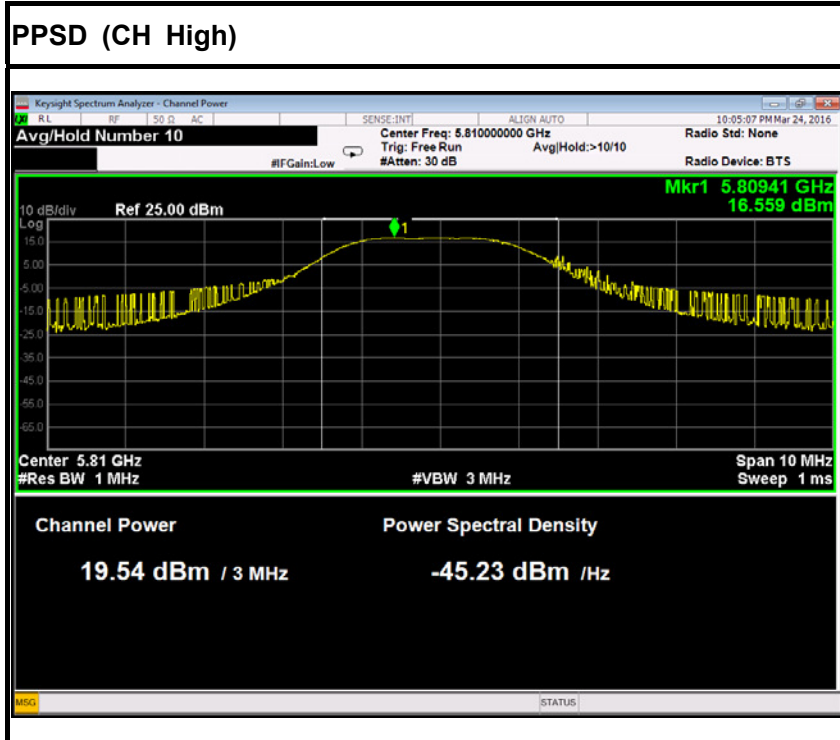

### Antenna 2

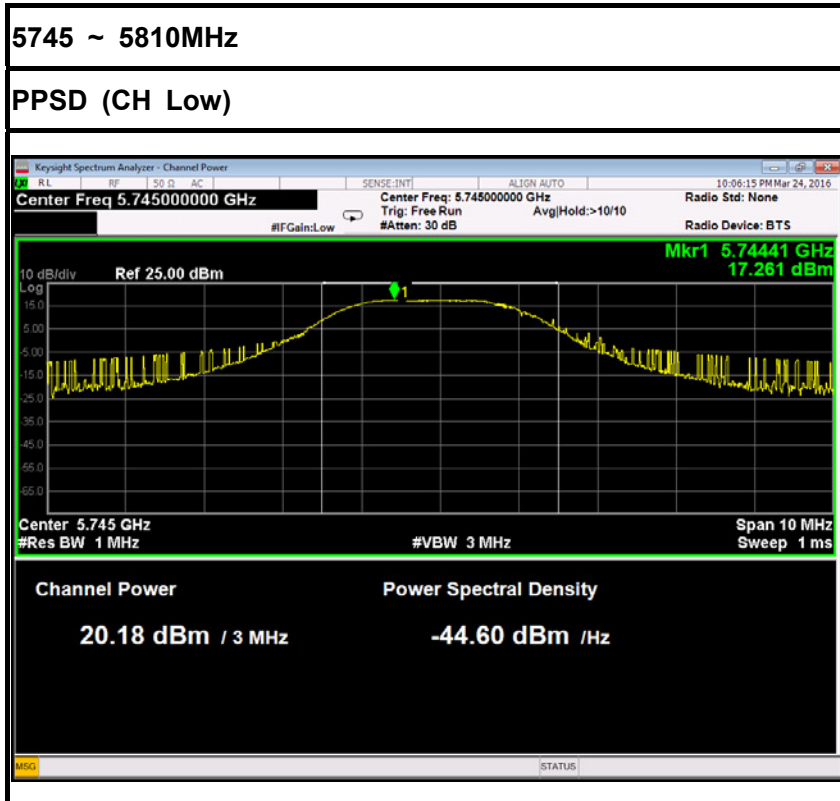

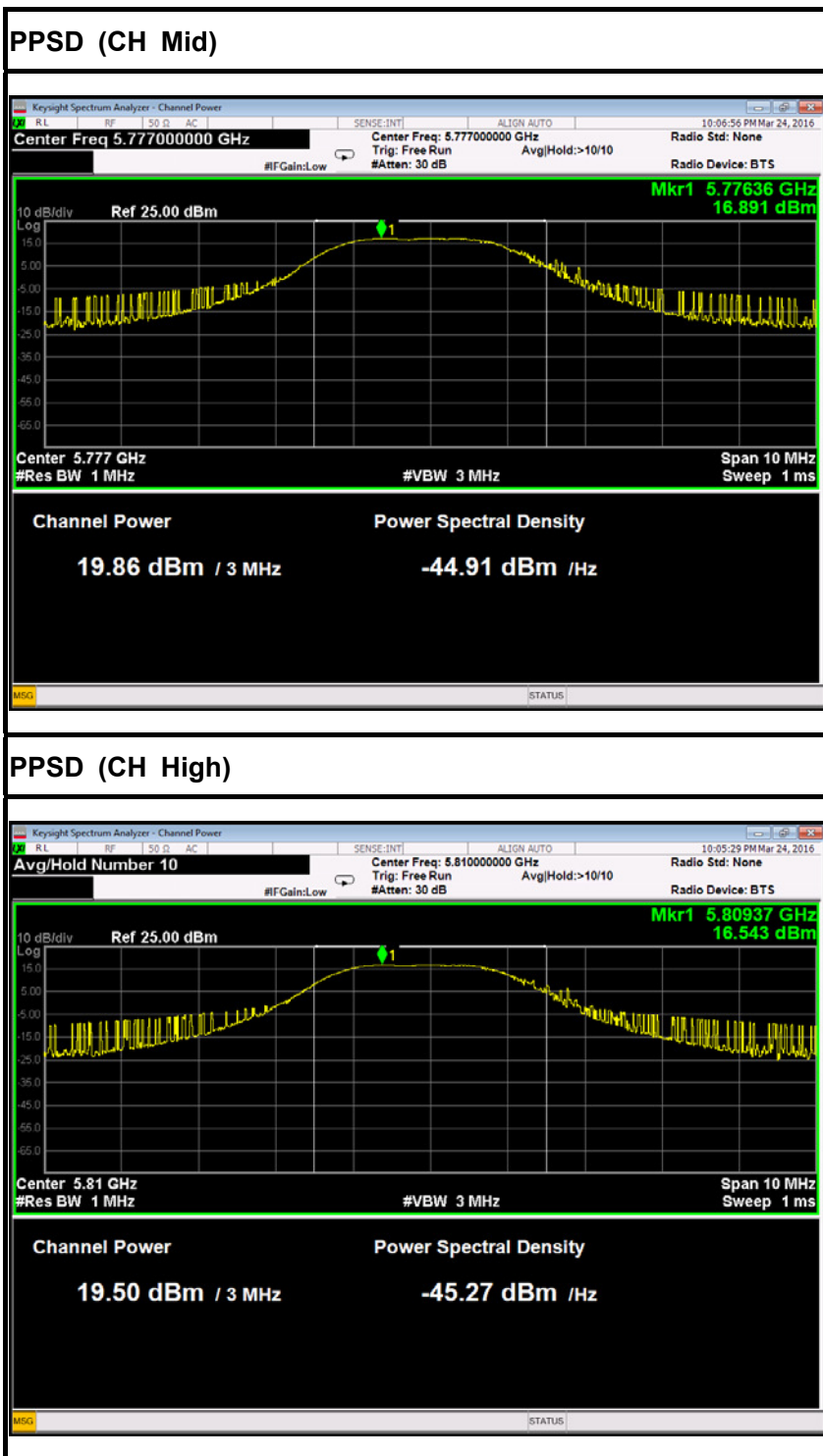



## 6.7 RADIATED UNDESIRABLE EMISSION

### 6.7.1 LIMIT

1. According to §15.209(a), except as provided elsewhere in this Subpart, the emissions from an intentional radiator shall not exceed the field strength levels specified in the following table:

Frequency (MHz)	Field Strength ( $\mu\text{V/m}$ )	Measurement Distance (m)
30-88	100*	3
88-216	150*	3
216-960	200*	3
Above 960	500	3

**Remark:** Except as provided in paragraph (g), fundamental emissions from intentional radiators operating under this Section shall not be located in the frequency bands 54-72 MHz, 76-88 MHz, 174-216 MHz or 470-806 MHz. However, operation within these frequency bands is permitted under other sections of this Part, e.g., Sections 15.231 and 15.241.

2. In the emission table above, the tighter limit applies at the band edges.

Frequency (MHz)	Field Strength ( $\mu\text{V/m}$ at 3-meter)	Field Strength (dB $\mu\text{V/m}$ at 3-meter)
30-88	100	40
88-216	150	43.5
216-960	200	46
Above 960	500	54



### 6.7.2 TEST INSTRUMENTS

Radiated Emission Test Site 966(2)						
Name of Equipment	Manufacturer	Model Number	Serial Number	Last Calibration	Due Calibration	
PSA Series Spectrum Analyzer	Agilent	E4446A	US44300399	02/21/2016	02/20/2017	
EMI TEST RECEIVER	ROHDE&SCHWARZ	ESCI	100783	02/21/2016	02/20/2017	
Amplifier	MITEQ	AM-1604-3000	1123808	02/21/2016	02/20/2017	
High Noise Amplifier	Agilent	8449B	3008A01838	02/21/2016	02/20/2017	
Board-Band Horn Antenna	Schwarzbeck	BBHA 9170	9170-497	02/21/2016	02/20/2017	
Bilog Antenna	SCHAFFNER	CBL6143	5082	02/21/2016	02/20/2017	
Horn Antenna	SCHWARZBECK	BBHA9120	D286	02/21/2016	02/20/2017	
Loop Antenna	COM-POWER	AL-130	121044	02/21/2016	02/20/2017	
Turn Table	N/A	N/A	N/A	N.C.R	N.C.R	
Controller	Sunol Sciences	SC104V	022310-1	N.C.R	N.C.R	
Controller	CT	N/A	N/A	N.C.R	N.C.R	
Temp. / Humidity Meter	Anymetre	JR913	N/A	02/21/2016	02/20/2017	
Antenna Tower	SUNOL	TLT2	N/A	N.C.R	N.C.R	
Test S/W	FARAD	LZ-RF / CCS-SZ-3A2				

### 6.7.3 TEST CONFIGURATION

#### Below 30MHz

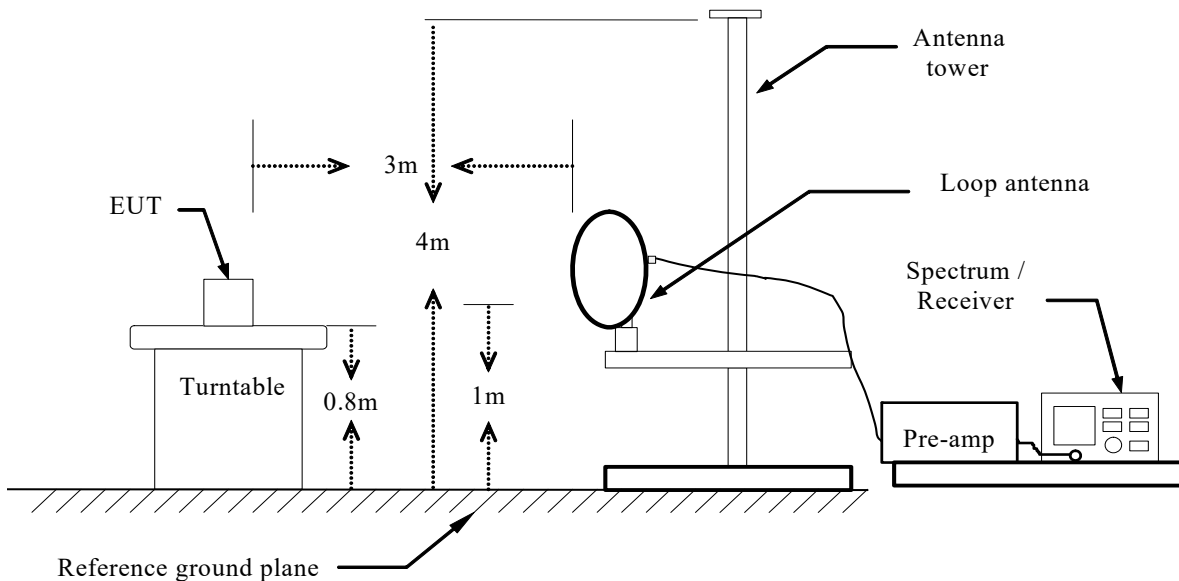



**Below 1 GHz**

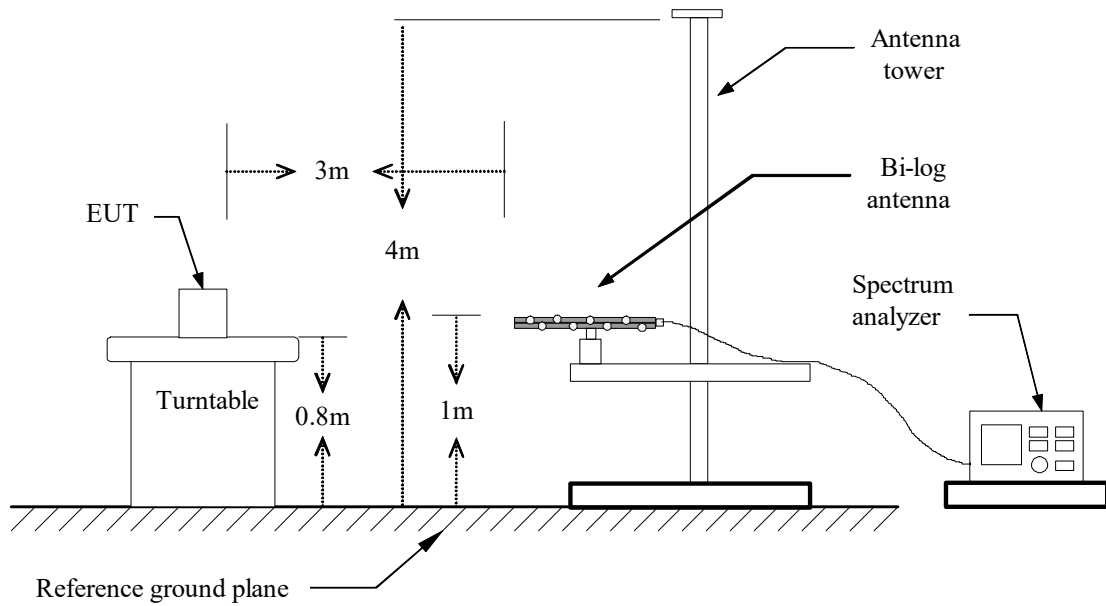

**Above 1 GHz**

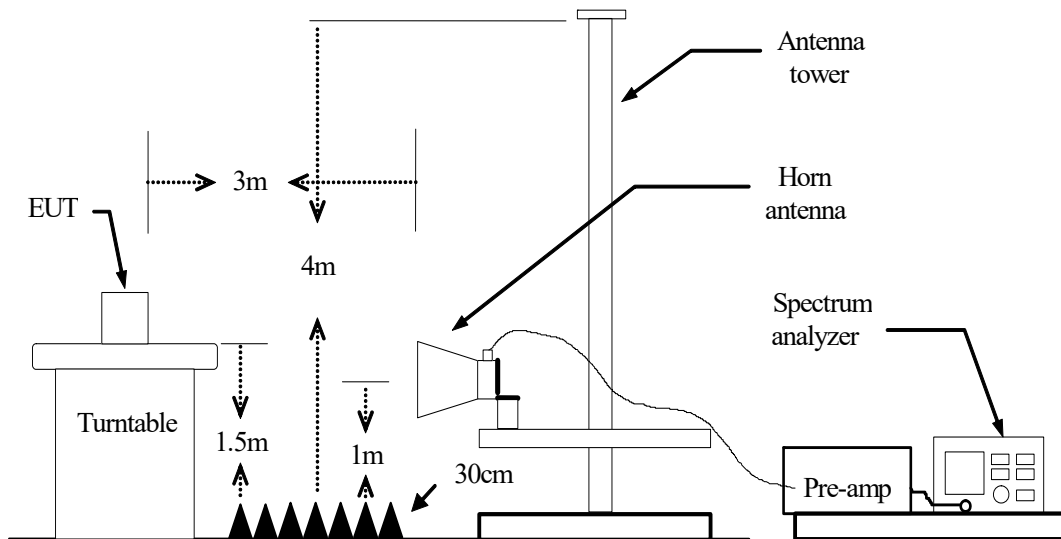

For the actual test configuration, please refer to the related item – Photographs of the TEST CONFIGURATION.



### 6.7.4 MEASURING SETTING

The following table is the setting of spectrum analyzer and receiver.

Spectrum Parameter	Setting
Attenuation	Auto
Start Frequency	1000 MHz
Stop Frequency	10th carrier harmonic
RB / VB (Emission in restricted band)	1MHz / 1MHz for Peak, 1 MHz / 10Hz for Average
RB / VB (Emission in non-restricted band)	1MHz / 1MHz for Peak, 1 MHz / 10Hz for Average

Receiver Parameter	Setting
Attenuation	Auto
Start ~ Stop Frequency	9kHz~150kHz / RB 200Hz for QP/AVG
Start ~ Stop Frequency	150kHz~30MHz / RB 9kHz for QP/AVG
Start ~ Stop Frequency	30MHz~1000MHz / RB 100kHz for QP

### 6.7.5 TEST PROCEDURE

#### 1) Sequence of testing 9 kHz to 30 MHz

##### Setup:

- The equipment was set up to simulate a typical usage like described in the user manual or described by manufacturer.
- If the EUT is a tabletop system, a rotatable table with 0.8 m height is used.
- If the EUT is a floor standing device, it is placed on the ground.
- Auxiliary equipment and cables were positioned to simulate normal operation conditions.
- The AC power port of the EUT (if available) is connected to a power outlet below the turntable.
- The measurement distance is 3 meter.
- The EUT was set into operation.

##### Pre measurement:

- The turntable rotates from 0° to 315° using 45° steps.
- The antenna height is 0.8 meter.
- At each turntable position the analyzer sweeps with peak detection to find the maximum of all emissions



**Final measurement:**

--- Identified emissions during the pre measurement the software maximizes by rotating the turntable position (0° to 360°) and by rotating the elevation axes (0° to 360°).

--- The final measurement will be done in the position (turntable and elevation) causing the highest emissions with QPK detector.

--- The final levels, frequency, measuring time, bandwidth, turntable position, correction factor, margin to the limit and limit will be recorded. Also a plot with the graph of the pre measurement and the limit will be stored.

**2) Sequence of testing 30 MHz to 1 GHz**

**Setup:**

--- The equipment was set up to simulate a typical usage like described in the user manual or described by manufacturer.

--- If the EUT is a tabletop system, a table with 0.8 m height is used, which is placed on the ground plane.

--- If the EUT is a floor standing device, it is placed on the ground plane with insulation between both.

--- Auxiliary equipment and cables were positioned to simulate normal operation conditions

--- The AC power port of the EUT (if available) is connected to a power outlet below the turntable.

--- The measurement distance is 3 meter.

--- The EUT was set into operation.

**Pre measurement:**

--- The turntable rotates from 0° to 315° using 45° steps.

--- The antenna is polarized vertical and horizontal.

--- The antenna height changes from 1 to 3 meter.

--- At each turntable position, antenna polarization and height the analyzer sweeps three times in peak to find the maximum of all emissions.





**Final measurement:**

- The final measurement will be performed with minimum the six highest peaks.
- According to the maximum antenna and turntable positions of premeasurement the software maximize the peaks by changing turntable position ( $\pm 45^\circ$ ) and antenna movement between 1 and 4 meter.
- The final measurement will be done with QP detector with an EMI receiver.
- The final levels, frequency, measuring time, bandwidth, antenna height, antenna polarization, turntable angle, correction factor, margin to the limit and limit will be recorded. Also a plot with the graph of the premeasurement with marked maximum final measurements and the limit will be stored.

**3) Sequence of testing 1 GHz to 18 GHz**

**Setup:**

- The equipment was set up to simulate a typical usage like described in the user manual or described by manufacturer.
- If the EUT is a tabletop system, a rotatable table with 1.5 m height is used.
- If the EUT is a floor standing device, it is placed on the ground plane with insulation between both.
- Auxiliary equipment and cables were positioned to simulate normal operation conditions
- The AC power port of the EUT (if available) is connected to a power outlet below the turntable.
- The measurement distance is 3 meter.
- The EUT was set into operation.

**Pre measurement:**

- The turntable rotates from  $0^\circ$  to  $315^\circ$  using  $45^\circ$  steps.
- The antenna is polarized vertical and horizontal.
- The antenna height scan range is 1 meter to 2.5 meter.
- At each turntable position and antenna polarization the analyzer sweeps with peak detection to find the maximum of all emissions.



**Final measurement:**

- The final measurement will be performed with minimum the six highest peaks.
- According to the maximum antenna and turntable positions of premeasurement the software maximize the peaks by changing turntable position ( $\pm 45^\circ$ ) and antenna movement between 1 and 4 meter. This procedure is repeated for both antenna polarizations.
- The final measurement will be done in the position (turntable, EUT-table and antenna polarization) causing the highest emissions with Peak and Average detector.
- The final levels, frequency, measuring time, bandwidth, turntable position, EUT-table position, antenna polarization, correction factor, margin to the limit and limit will be recorded. Also a plot with the graph of the pre measurement with marked maximum final measurements and the limit will be stored.

**4) Sequence of testing above 18 GHz**

**Setup:**

- The equipment was set up to simulate a typical usage like described in the user manual or described by manufacturer.
- If the EUT is a tabletop system, a rotatable table with 1.5 m height is used.
- If the EUT is a floor standing device, it is placed on the ground plane with insulation between both.
- Auxiliary equipment and cables were positioned to simulate normal operation conditions
- The AC power port of the EUT (if available) is connected to a power outlet below the turntable.
- The measurement distance is 1 meter.
- The EUT was set into operation.

**Pre measurement:**

- The antenna is moved spherical over the EUT in different polarisations of the antenna.

**Final measurement:**

- The final measurement will be performed at the position and antenna orientation for all detected emissions that were found during the premeasurements with Peak and Average detector.
- The final levels, frequency, measuring time, bandwidth, correction factor, margin to the limit and limit will be recorded. Also a plot with the graph of the premeasurement and the limit will be stored.



**6.7.6 DATA SAMPLE**

**Below 1GHz**

Frequency (MHz)	Reading (dBuV)	Correct Factor (dB/m)	Result (dBuV/m)	Limit (dBuV/m)	Margin (dB)	Antenna Pole (V/H)	Remark
XXX.XXXX	36.37	-12.20	24.17	40.00	-15.83	V	QP

Frequency (MHz) = Emission frequency in MHz  
 Reading (dBuV) = Uncorrected Analyzer / Receiver reading  
 Correct Factor (dB/m) = Antenna factor + Cable loss – Amplifier gain  
 Result (dBuV/m) = Reading (dBuV) + Corr. Factor (dB/m)  
 Limit (dBuV/m) = Limit stated in standard  
 Margin (dB) = Result (dBuV/m) – Limit (dBuV/m)  
 Q.P. = Quasi-peak Reading

**Above 1GHz**

Frequency (MHz)	Reading (dBuV)	Correction Factor (dB/m)	Result (dBuV/m)	Limit (dBuV/m)	Margin (dB)	Antenna Pole (V/H)	Remark
XXXX.XXXX	62.09	-11.42	50.67	74.00	-23.33	V	Peak
XXXX.XXXX	49.78	-11.42	38.36	54.00	-15.64	V	AVG

Frequency (MHz) = Emission frequency in MHz  
 Reading (dBuV) = Uncorrected Analyzer / Receiver reading  
 Correction Factor (dB/m) = Antenna factor + Cable loss – Amplifier gain  
 Result (dBuV/m) = Reading (dBuV) + Corr. Factor (dB/m)  
 Limit (dBuV/m) = Limit stated in standard  
 Margin (dB) = Result (dBuV/m) – Limit (dBuV/m)  
 Peak = Peak Reading  
 AVG = Average Reading

**Calculation Formula**

Margin (dB) = Result (dBuV/m) – Limits (dBuV/m)  
 Result (dBuV/m) = Reading (dBuV) + Correction Factor

**6.7.7 TEST RESULTS****Below 1 GHz**Test Mode: TXTested by: Jack ChenAmbient temperature: 24°C Relative humidity: 52% RHDate: March 22, 2016

Frequency (MHz)	Reading (dBuV)	Correction Factor (dB/m)	Result (dBuV/m)	Limit (dBuV/m)	Margin (dB)	Antenna Pole (V/H)	Remark
68.8000	54.08	-25.49	28.59	40.00	-11.41	V	QP
91.4333	54.63	-24.59	30.04	43.50	-13.46	V	QP
175.5000	51.83	-22.94	28.89	43.50	-14.61	V	QP
199.7500	52.62	-22.73	29.89	43.50	-13.61	V	QP
666.9665	44.01	-12.20	31.81	46.00	-14.19	V	QP
859.3500	51.22	-10.63	40.59	46.00	-5.41	V	QP
73.6500	58.49	-26.06	32.43	40.00	-7.57	H	QP
96.2831	55.61	-24.07	31.54	43.50	-11.96	H	QP
159.3333	56.40	-22.49	33.91	43.50	-9.59	H	QP
175.5000	57.65	-22.94	34.71	43.50	-8.79	H	QP
191.6665	54.38	-22.84	31.54	43.50	-11.96	H	QP
228.8500	53.34	-21.68	31.66	46.00	-14.34	H	QP

**Remark:**

1. No emission found between lowest internal used/generated frequency to 30MHz (9kHz~30MHz)
2. Radiated emissions measured in frequency range from 30 MHz to 1000MHz were made with an instrument using peak/quasi-peak detector mode.
3. Quasi-peak test would be performed if the peak result were greater than the quasi-peak limit.
4. Data of measurement within this frequency range shown " --- " in the table above means the reading of emissions are attenuated more than 20dB below the permissible limits or the field strength is too small to be measured.
5. Measurements above show only up to 6 maximum emissions noted, or would be lesser, with " N/A " remark, if no specific emissions from the EUT are recorded (ie: margin>20dB from the applicable limit) and considered that's already beyond the background noise floor.
6. Margin (dB) = Remark result (dBuV/m) – Quasi-peak limit (dBuV/m).



**Above 1 GHz**

**Antenna 1**

Test Mode: TX / 5745MHz /(CH Low)(1-6G)

Tested by: Jack Chen

Ambient temperature: 24°C Relative humidity: 52% RH

Date: March 23, 2016

Frequency (MHz)	Reading (dBuV)	Correction Factor (dB/m)	Result (dBuV/m)	Limit (dBuV/m)	Margin (dB)	Antenna Pole (V/H)	Remark
3365.000	43.20	-0.75	42.45	74.00	-31.55	V	peak
3670.000	42.34	0.20	42.54	74.00	-31.46	V	peak
4115.000	42.47	1.99	44.46	74.00	-29.54	V	peak
4865.000	41.63	4.54	46.17	74.00	-27.83	V	peak
5040.000	48.31	5.05	53.36	74.00	-20.64	V	peak
5040.000	28.76	5.05	33.81	54.00	-20.19	V	AVG
5400.000	48.57	5.69	54.26	74.00	-19.74	V	peak
5400.000	26.46	5.69	32.15	54.00	-21.85	V	AVG
3215.000	43.44	-1.00	42.44	74.00	-31.56	H	Peak
3850.000	42.00	0.96	42.96	74.00	-31.04	H	Peak
4120.000	42.58	2.01	44.59	74.00	-29.41	H	Peak
4915.000	41.51	4.70	46.21	74.00	-27.79	H	peak
5040.000	56.16	5.05	61.21	74.00	-12.79	H	peak
5040.000	32.76	5.05	37.81	54.00	-16.19	H	AVG
5400.000	53.35	5.69	59.04	74.00	-14.96	H	peak
5400.000	29.93	5.69	35.62	54.00	-18.38	H	AVG

**Remark:**

1. Measuring frequencies from 1 GHz to the 10th harmonic of highest fundamental frequency.
2. Radiated emissions measured in frequency above 1000MHz were made with an instrument using peak/average detector mode.
3. Average test would be performed if the peak result were greater than the average limit.
4. Data of measurement within this frequency range shown " --- " in the table above means the reading of emissions are attenuated more than 20dB below the permissible limits or the field strength is too small to be measured.
5. Measurements above show only up to 6 maximum emissions noted, or would be lesser, with " N/A " remark, if no specific emissions from the EUT are recorded (ie: margin>20dB from the applicable limit) and considered that's already beyond the background noise floor.
6. Margin (dB) = Remark result (dBuV/m) – Average limit (dBuV/m).



Test Mode: TX / 5745MHz /(CH Low)(6-18G)

Tested by: Jack Chen

Ambient temperature: 24°C Relative humidity: 52% RH

Date: March 23, 2016

Frequency (MHz)	Reading (dBuV)	Correction Factor (dB/m)	Result (dBuV/m)	Limit (dBuV/m)	Margin (dB)	Antenna Pole (V/H)	Remark
11316.000	30.28	14.94	45.22	74.00	-28.78	V	peak
11484.000	51.04	14.87	65.91	74.00	-8.09	V	peak
11484.000	32.20	14.87	47.07	54.00	-6.93	V	AVG
12756.000	29.70	17.14	46.84	74.00	-27.16	V	peak
13104.000	29.40	18.22	47.62	74.00	-26.38	V	peak
13944.000	28.02	20.43	48.45	74.00	-25.55	V	peak
14832.000	29.50	21.06	50.56	74.00	-23.44	V	peak
9300.000	31.04	9.96	41.00	74.00	-33.00	H	Peak
10524.000	30.43	13.60	44.03	74.00	-29.97	H	Peak
11484.000	51.35	14.87	66.22	74.00	-7.78	H	Peak
11484.000	32.51	14.87	47.38	54.00	-6.62	H	AVG
13140.000	29.18	18.32	47.50	74.00	-26.50	H	peak
14196.000	28.36	20.69	49.05	74.00	-24.95	H	peak
14976.000	29.38	21.15	50.53	74.00	-23.47	H	peak

**Remark:**

1. Measuring frequencies from 1 GHz to the 10th harmonic of highest fundamental frequency.
2. Radiated emissions measured in frequency above 1000MHz were made with an instrument using peak/average detector mode.
3. Average test would be performed if the peak result were greater than the average limit.
4. Data of measurement within this frequency range shown " --- " in the table above means the reading of emissions are attenuated more than 20dB below the permissible limits or the field strength is too small to be measured.
5. Measurements above show only up to 6 maximum emissions noted, or would be lesser, with " N/A " remark, if no specific emissions from the EUT are recorded (ie: margin>20dB from the applicable limit) and considered that's already beyond the background noise floor.
6. Margin (dB) = Remark result (dBuV/m) – Average limit (dBuV/m)



Test Mode: TX / 5777MHz / (CH Mid)

Tested by: Jack Chen

Ambient temperature: 24°C    Relative humidity: 52% RH

Date: March 23, 2016

Frequency (MHz)	Reading (dBuV)	Correction Factor (dB/m)	Result (dBuV/m)	Limit (dBuV/m)	Margin (dB)	Antenna Pole (V/H)	Remark
9996.000	31.30	11.97	43.27	74.00	-30.73	V	peak
11556.000	50.35	14.84	65.19	74.00	-8.81	V	peak
11556.000	31.51	14.84	46.35	54.00	-7.65	V	AVG
12228.000	30.95	15.39	46.34	74.00	-27.66	V	peak
12984.000	30.53	17.90	48.43	74.00	-25.57	V	peak
14592.000	29.40	20.92	50.32	74.00	-23.68	V	peak
15000.000	30.04	21.16	51.20	74.00	-22.80	V	peak
10512.000	30.96	13.57	44.53	74.00	-29.47	H	Peak
11556.000	50.56	14.84	65.40	74.00	-8.60	H	Peak
11556.000	31.69	14.84	46.53	54.00	-7.47	H	AVG
12660.000	29.64	16.82	46.46	74.00	-27.54	H	peak
12972.000	29.58	17.86	47.44	74.00	-26.56	H	peak
14028.000	28.52	20.60	49.12	74.00	-24.88	H	peak
15012.000	29.81	21.11	50.92	74.00	-23.08	H	peak

**Remark:**

1. Measuring frequencies from 1 GHz to the 10th harmonic of highest fundamental frequency.
2. Radiated emissions measured in frequency above 1000MHz were made with an instrument using peak/average detector mode.
3. Average test would be performed if the peak result were greater than the average limit.
4. Data of measurement within this frequency range shown " --- " in the table above means the reading of emissions are attenuated more than 20dB below the permissible limits or the field strength is too small to be measured.
5. Measurements above show only up to 6 maximum emissions noted, or would be lesser, with " N/A " remark, if no specific emissions from the EUT are recorded (ie: margin>20dB from the applicable limit) and considered that's already beyond the background noise floor.
6. Margin (dB) = Remark result (dBuV/m) – Average limit (dBuV/m).

Test Mode: TX / 5810MHz / (CH High)Tested by: Jack ChenAmbient temperature: 24°C Relative humidity: 52% RHDate: March 23, 2016

Frequency (MHz)	Reading (dBuV)	Correction Factor (dB/m)	Result (dBuV/m)	Limit (dBuV/m)	Margin (dB)	Antenna Pole (V/H)	Remark
9960.000	31.37	11.86	43.23	74.00	-30.77	V	peak
10944.000	30.01	14.91	44.92	74.00	-29.08	V	peak
11616.000	51.04	14.81	65.85	74.00	-8.15	V	peak
11616.000	32.20	14.81	47.01	54.00	-6.99	V	AVG
12360.000	30.08	15.83	45.91	74.00	-28.09	V	peak
13080.000	29.50	18.16	47.66	74.00	-26.34	V	peak
14256.000	29.17	20.73	49.90	74.00	-24.10	V	peak
10404.000	30.86	13.23	44.09	74.00	-29.91	H	Peak
10788.000	30.49	14.42	44.91	74.00	-29.09	H	Peak
11616.000	53.97	14.81	68.78	74.00	-5.22	H	Peak
11616.000	34.14	14.81	48.95	54.00	-5.05	H	AVG
12480.000	30.22	16.23	46.45	74.00	-27.55	H	peak
12984.000	29.73	17.90	47.63	74.00	-26.37	H	peak
14100.000	28.71	20.64	49.35	74.00	-24.65	H	peak

**Remark:**

1. Measuring frequencies from 1 GHz to the 10th harmonic of highest fundamental frequency.
2. Radiated emissions measured in frequency above 1000MHz were made with an instrument using peak/average detector mode.
3. Average test would be performed if the peak result were greater than the average limit.
4. Data of measurement within this frequency range shown " --- " in the table above means the reading of emissions are attenuated more than 20dB below the permissible limits or the field strength is too small to be measured.
5. Measurements above show only up to 6 maximum emissions noted, or would be lesser, with " N/A " remark, if no specific emissions from the EUT are recorded (ie: margin>20dB from the applicable limit) and considered that's already beyond the background noise floor.
6. Margin (dB) = Remark result (dBuV/m) – Average limit (dBuV/m).





**Antenna 2**

**Test Mode:** TX / 5745MHz /(CH Low)

**Tested by:** Jack Chen

**Ambient temperature:** 24°C **Relative humidity:** 52% RH

**Date:** March 23, 2016

Frequency (MHz)	Reading (dBuV)	Correction Factor (dB/m)	Result (dBuV/m)	Limit (dBuV/m)	Margin (dB)	Antenna Pole (V/H)	Remark
10524.000	30.28	13.60	43.88	74.00	-30.12	V	peak
11484.000	48.69	14.87	63.56	74.00	-10.44	V	peak
11484.000	29.85	14.87	44.72	54.00	-9.28	V	AVG
12360.000	30.21	15.83	46.04	74.00	-27.96	V	peak
12816.000	30.45	17.34	47.79	74.00	-26.21	V	peak
14232.000	28.84	20.71	49.55	74.00	-24.45	V	peak
15012.000	29.85	21.11	50.96	74.00	-23.04	V	peak
10056.000	31.32	12.15	43.47	74.00	-30.53	H	Peak
10488.000	30.24	13.49	43.73	74.00	-30.27	H	Peak
11484.000	49.08	14.87	63.95	74.00	-10.05	H	Peak
11484.000	30.25	14.87	45.12	54.00	-8.88	H	AVG
12948.000	29.92	17.78	47.70	74.00	-26.30	H	peak
14340.000	29.05	20.78	49.83	74.00	-24.17	H	peak
14976.000	29.62	21.15	50.77	74.00	-23.23	H	peak

**Remark:**

1. Measuring frequencies from 1 GHz to the 10th harmonic of highest fundamental frequency.
2. Radiated emissions measured in frequency above 1000MHz were made with an instrument using peak/average detector mode.
3. Average test would be performed if the peak result were greater than the average limit.
4. Data of measurement within this frequency range shown " --- " in the table above means the reading of emissions are attenuated more than 20dB below the permissible limits or the field strength is too small to be measured.
5. Measurements above show only up to 6 maximum emissions noted, or would be lesser, with " N/A " remark, if no specific emissions from the EUT are recorded (ie: margin>20dB from the applicable limit) and considered that's already beyond the background noise floor.
6. Margin (dB) = Remark result (dBuV/m) – Average limit (dBuV/m).



Test Mode: TX / 5777MHz /(CH Mid)

Tested by: Jack Chen

Ambient temperature: 24°C Relative humidity: 52% RH

Date: March 23, 2016

Frequency (MHz)	Reading (dBuV)	Correction Factor (dB/m)	Result (dBuV/m)	Limit (dBuV/m)	Margin (dB)	Antenna Pole (V/H)	Remark
11556.000	49.06	14.84	63.90	74.00	-10.10	V	peak
11556.000	30.22	14.84	45.06	54.00	-8.94	V	AVG
12708.000	29.58	16.98	46.56	74.00	-27.44	V	peak
13536.000	28.32	19.36	47.68	74.00	-26.32	V	peak
14292.000	29.24	20.75	49.99	74.00	-24.01	V	peak
15156.000	30.61	20.45	51.06	74.00	-22.94	V	peak
16836.000	29.61	22.28	51.89	74.00	-22.11	V	peak
10512.000	30.36	13.57	43.93	74.00	-30.07	H	Peak
11556.000	53.13	14.84	67.97	74.00	-6.03	H	Peak
11556.000	34.29	14.84	49.13	54.00	-4.87	H	AVG
12924.000	29.69	17.70	47.39	74.00	-26.61	H	peak
13596.000	28.19	19.52	47.71	74.00	-26.29	H	peak
14124.000	28.34	20.65	48.99	74.00	-25.01	H	peak
14856.000	29.84	21.08	50.92	74.00	-23.08	H	peak

**Remark:**

1. Measuring frequencies from 1 GHz to the 10th harmonic of highest fundamental frequency.
2. Radiated emissions measured in frequency above 1000MHz were made with an instrument using peak/average detector mode.
3. Average test would be performed if the peak result were greater than the average limit.
4. Data of measurement within this frequency range shown " --- " in the table above means the reading of emissions are attenuated more than 20dB below the permissible limits or the field strength is too small to be measured.
5. Measurements above show only up to 6 maximum emissions noted, or would be lesser, with " N/A " remark, if no specific emissions from the EUT are recorded (ie: margin>20dB from the applicable limit) and considered that's already beyond the background noise floor.
6. Margin (dB) = Remark result (dBuV/m) – Average limit (dBuV/m).

Test Mode: TX / 5810MHz / (CH High)Tested by: Jack ChenAmbient temperature: 24°CRelative humidity: 52% RHDate: March 23, 2016

Frequency (MHz)	Reading (dBuV)	Correction Factor (dB/m)	Result (dBuV/m)	Limit (dBuV/m)	Margin (dB)	Antenna Pole (V/H)	Remark
10032.000	31.13	12.08	43.21	74.00	-30.79	V	peak
11028.000	30.10	15.07	45.17	74.00	-28.83	V	peak
11616.000	48.56	14.81	63.37	74.00	-10.63	V	peak
11616.000	29.72	14.81	44.53	54.00	-9.47	V	AVG
12912.000	29.78	17.66	47.44	74.00	-26.56	V	peak
14136.000	28.59	20.66	49.25	74.00	-24.75	V	peak
14940.000	29.77	21.13	50.90	74.00	-23.10	V	peak
10644.000	29.98	13.98	43.96	74.00	-30.04	H	Peak
10884.000	29.87	14.72	44.59	74.00	-29.41	H	Peak
11616.000	52.37	14.81	67.18	74.00	-6.82	H	Peak
11616.000	33.53	14.81	48.34	54.00	-5.66	H	AVG
12636.000	29.67	16.75	46.42	74.00	-27.58	H	peak
14316.000	28.88	20.76	49.64	74.00	-24.36	H	peak
14964.000	29.62	21.14	50.76	74.00	-23.24	H	peak

**Remark:**

1. Measuring frequencies from 1 GHz to the 10th harmonic of highest fundamental frequency.
2. Radiated emissions measured in frequency above 1000MHz were made with an instrument using peak/average detector mode.
3. Average test would be performed if the peak result were greater than the average limit.
4. Data of measurement within this frequency range shown " --- " in the table above means the reading of emissions are attenuated more than 20dB below the permissible limits or the field strength is too small to be measured.
5. Measurements above show only up to 6 maximum emissions noted, or would be lesser, with " N/A " remark, if no specific emissions from the EUT are recorded (ie: margin>20dB from the applicable limit) and considered that's already beyond the background noise floor.
6. Margin (dB) = Remark result (dBuV/m) – Average limit (dBuV/m).



### 6.8 CONDUCTED UNDESIRABLE EMISSION

#### 6.8.1 LIMIT

According to 15.407(b) ,

- (1) For transmitters operating in the 5.15-5.25 GHz band: all emissions outside of the 5.15-5.35 GHz band shall not exceed an EIRP of -27 dBm/MHz.
- (2) For transmitters operating in the 5.725–5.850 GHz band: all emissions within the frequency range from the band edge to 10 MHz above or below the band edge shall not exceed an EIRP of –17 dBm/MHz; for frequencies 10 MHz or greater above or below the band edge, emissions shall not exceed an EIRP of –27 dBm/MHz.
- (3) The provisions of §15.205 apply to intentional radiators operating under this section.

#### 6.8.2 MEASUREMENT EQUIPMENT USED

Name of Equipment	Manufacturer	Model	Serial Number	Last Calibration	Due Calibration
Spectrum Analyzer	Agilent	N9010A	MY52221469	10/25/2015	10/24/2016

*Remark: Each piece of equipment is scheduled for calibration once a year.*

#### 6.8.3 TEST CONFIGURATION

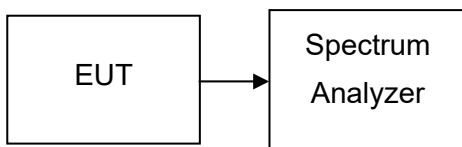

#### 6.8.4 TEST PROCEDURE

Conducted RF measurements of the transmitter output were made to confirm that the EUT antenna port conducted emissions meet the specified limit and to identify any spurious signals that require further investigation or measurements on the radiated emissions site.

The transmitter output is connected to the spectrum analyzer. The resolution bandwidth is set to 1 MHz. The video bandwidth is set to 1 MHz. Peak detection measurements are compared to the average EIRP limit, adjusted for the maximum antenna gain. If necessary, additional average detection measurements are made.

Measurements are made over the 30 MHz to 40 GHz range with the transmitter set to the lowest, middle, and highest channels.



### 6.8.5 TEST RESULTS

No non-compliance noted

#### Test Plot

#### Antenna 1

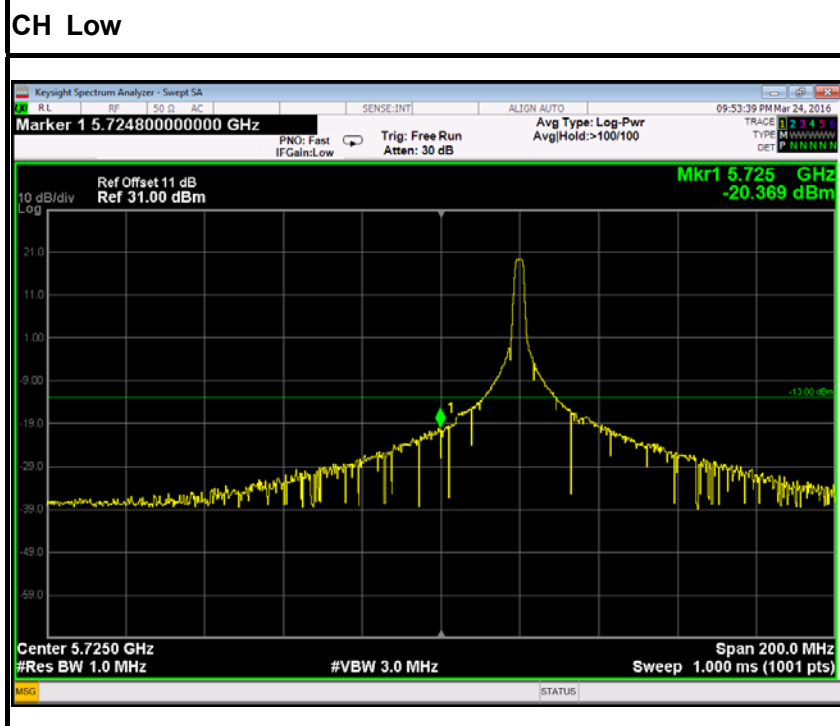
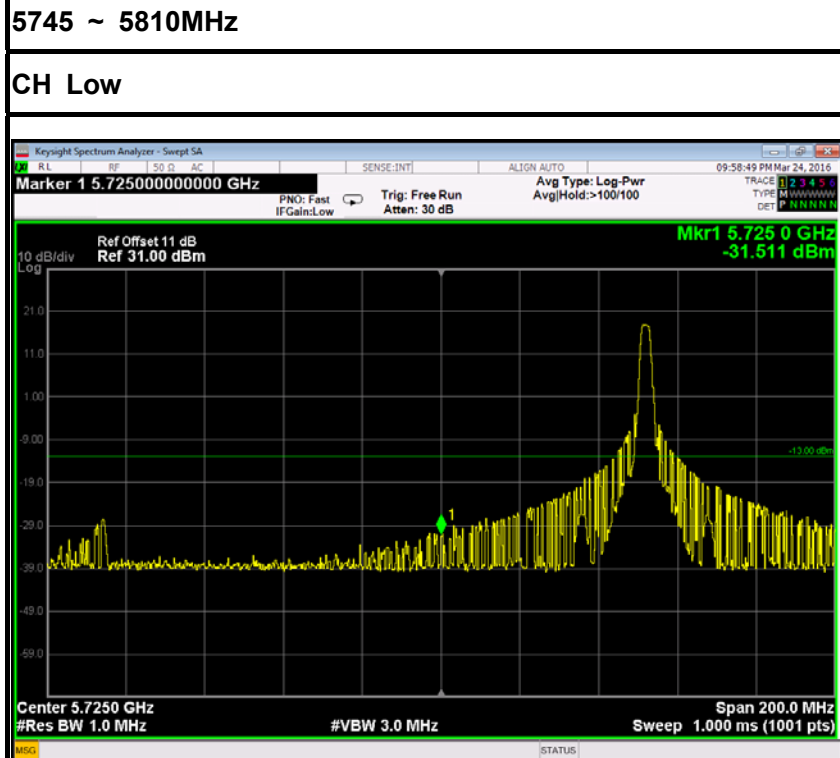

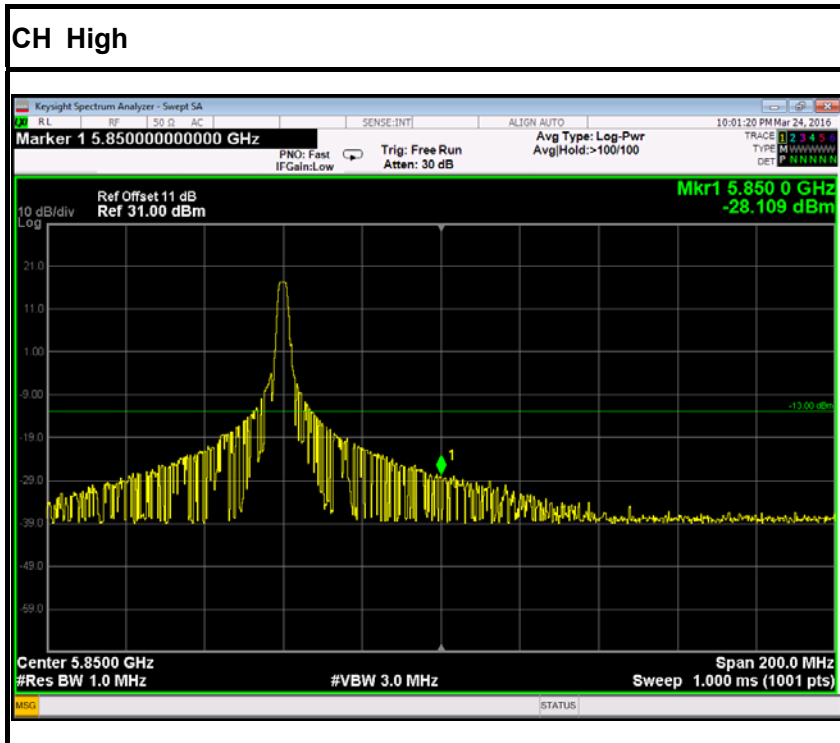

### Antenna 2

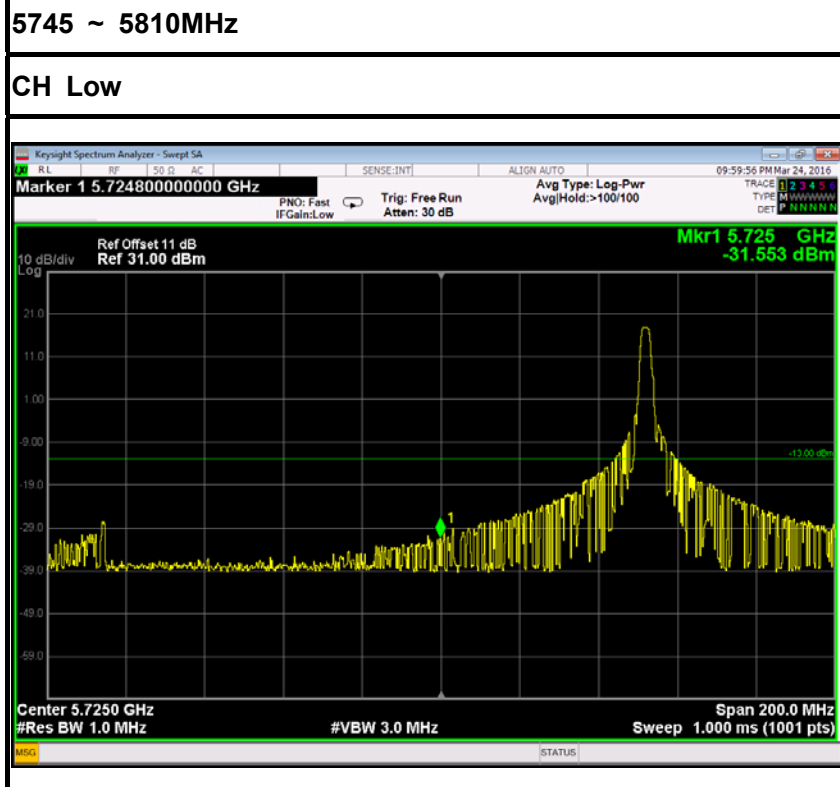

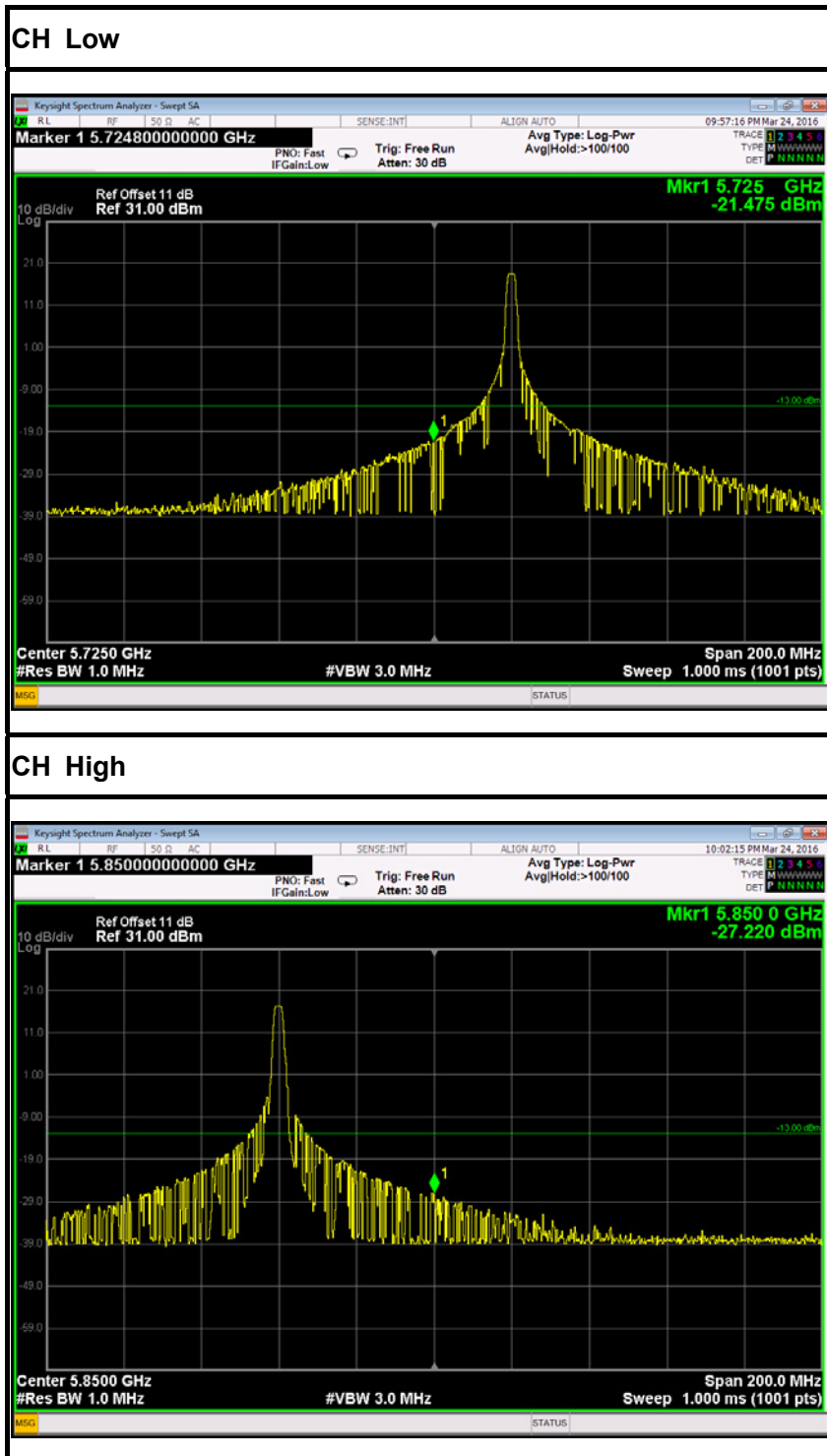



## 6.9 POWERLINE CONDUCTED EMISSIONS

### 6.9.1 LIMIT

According to §15.207(a), except as shown in paragraphs (b) and (c) of this section, for an intentional radiator that is designed to be connected to the public utility (AC) power line, the radio frequency voltage that is conducted back onto the AC power line on any frequency or frequencies within the band 150 kHz to 30 MHz shall not exceed the limits in the following table, as measured using a 50  $\mu$ H/50 ohms line impedance stabilization network (LISN). Compliance with the provisions of this paragraph shall be based on the measurement of the radio frequency voltage between each power line and ground at the power terminal. The lower limit applies at the boundary between the frequency ranges.

Frequency Range (MHz)	Limits (dB $\mu$ V)	
	Quasi-peak	Average
0.15 to 0.50	66 to 56*	56 to 46*
0.50 to 5	56	46
5 to 30	60	50

\* Decreases with the logarithm of the frequency.

### 6.9.2 TEST INSTRUMENTS

Conducted Emission Test Site					
Name of Equipment	Manufacturer	Model Number	Serial Number	Last Calibration	Due Calibration
EMI TEST RECEIVER	ROHDE&SCHWARZ	ESCI	100783	02/28/2015	02/27/2016
LISN(EUT)	ROHDE&SCHWARZ	ENV216	101543-WX	02/28/2015	02/27/2016
LISN	EMCO	3825/2	8901-1459	02/28/2015	02/27/2016
Temp. / Humidity Meter	VICTOR	HTC-1	N/A	02/28/2015	02/27/2016
Test S/W	FARAD	EZ-EMC/ CCS-3A1-CE			

**NOTE:** 1. The calibration interval of the above test instruments is 12 months and the calibrations are traceable to NML/ROC and NIST/USA.

2. N.C.R = No Calibration Request.





### 6.9.3 TEST CONFIGURATION

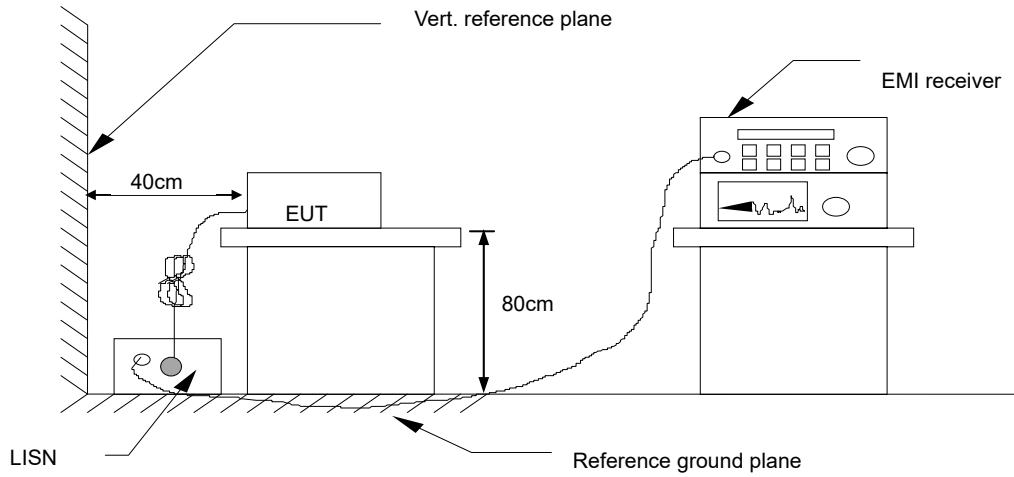

### 6.9.4 TEST PROCEDURE

1. The EUT was placed on a table, which is 0.8m above ground plane.
2. Maximum procedure was performed on the six highest emissions to ensure EUT compliance.
3. Repeat above procedures until all frequency measured were complete.

### 6.9.5 DATA SAMPLE

Frequency (MHz)	QuasiPeak Reading (dBuV)	Average Reading (dBuV)	Correction Factor (dB)	QuasiPeak Result (dBuV)	Average Result (dBuV)	QuasiPeak Limit (dBuV)	Average Limit (dBuV)	QuasiPeak Margin (dB)	Average Margin (dB)	Remark (Pass/Fail)
X.XXXX	32.69	25.65	11.52	44.21	37.17	65.78	55.79	-21.57	-18.62	Pass

Factor = Insertion loss of LISN + Cable Loss  
Result = Quasi-peak Reading/ Average Reading + Factor  
Limit = Limit stated in standard  
Margin = Result (dBuV) – Limit (dBuV)



### 6.9.6 TEST RESULTS

#### Test Data

<b>Model No.</b>	CME01-M2	<b>RBW,VBW</b>	9 kHz
<b>Environmental Conditions</b>	26°C, 60% RH	<b>Test Mode</b>	Mode 1
<b>Tested by</b>	Jack Chen	<b>Line</b>	L1
<b>Test Date</b>	March 21, 2016		

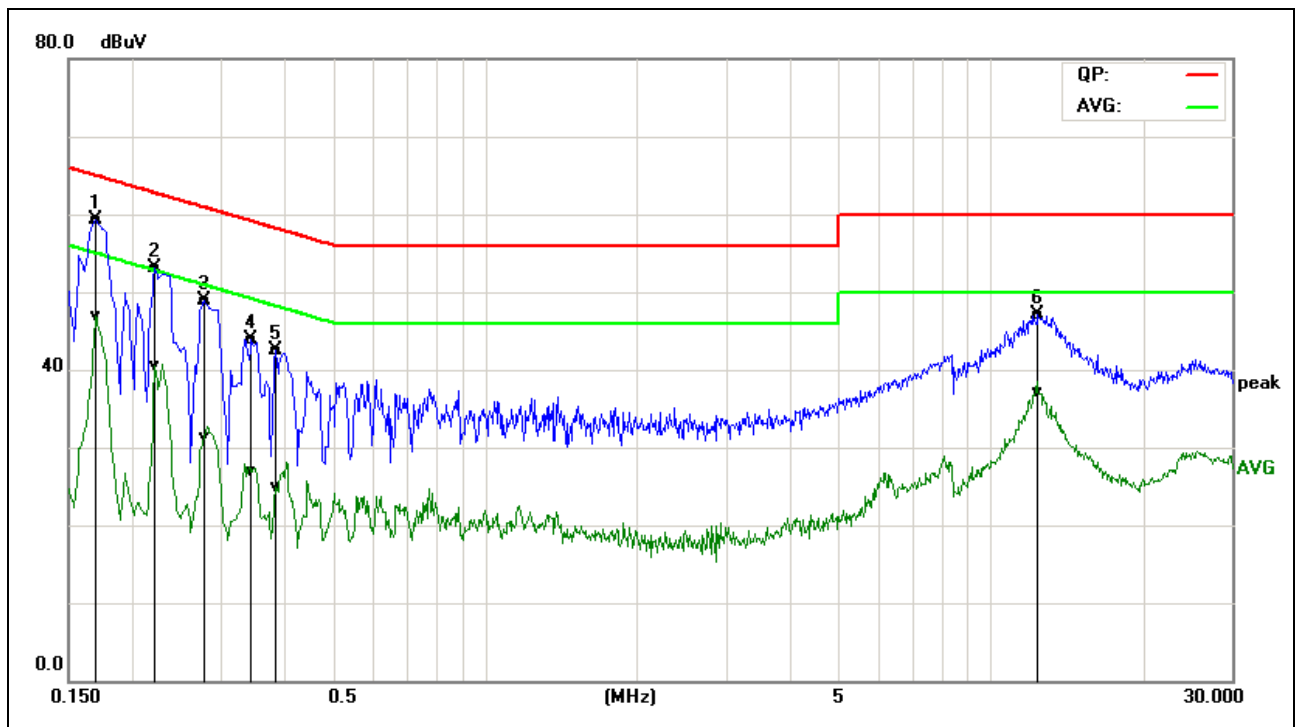

Frequency (MHz)	QuasiPeak Reading (dBuV)	Average Reading (dBuV)	Correction Factor (dB)	QuasiPeak Result (dBuV)	Average Result (dBuV)	QuasiPeak Limit (dBuV)	Average Limit (dBuV)	QuasiPeak Margin (dB)	Average Margin (dB)	Remark (Pass/Fail)
0.1700	49.59	37.20	9.62	59.21	46.82	64.96	54.96	-5.75	-8.14	Pass
0.2220	43.42	30.77	9.69	53.11	40.46	62.74	52.74	-9.63	-12.28	Pass
0.2779	39.27	21.59	9.69	48.96	31.28	60.88	50.88	-11.92	-19.60	Pass
0.3460	34.29	17.19	9.69	43.98	26.88	59.06	49.06	-15.08	-22.18	Pass
0.3860	32.77	15.20	9.68	42.45	24.88	58.15	48.15	-15.70	-23.27	Pass
12.4340	37.12	27.31	9.89	47.01	37.20	60.00	50.00	-12.99	-12.80	Pass



<b>Model No.</b>	CME01-M2	<b>RBW,VBW</b>	9 kHz
<b>Environmental Conditions</b>	26°C, 60% RH	<b>Test Mode</b>	Mode 1
<b>Tested by</b>	Jack Chen	<b>Line</b>	L2
<b>Test Date</b>	March 21, 2016		

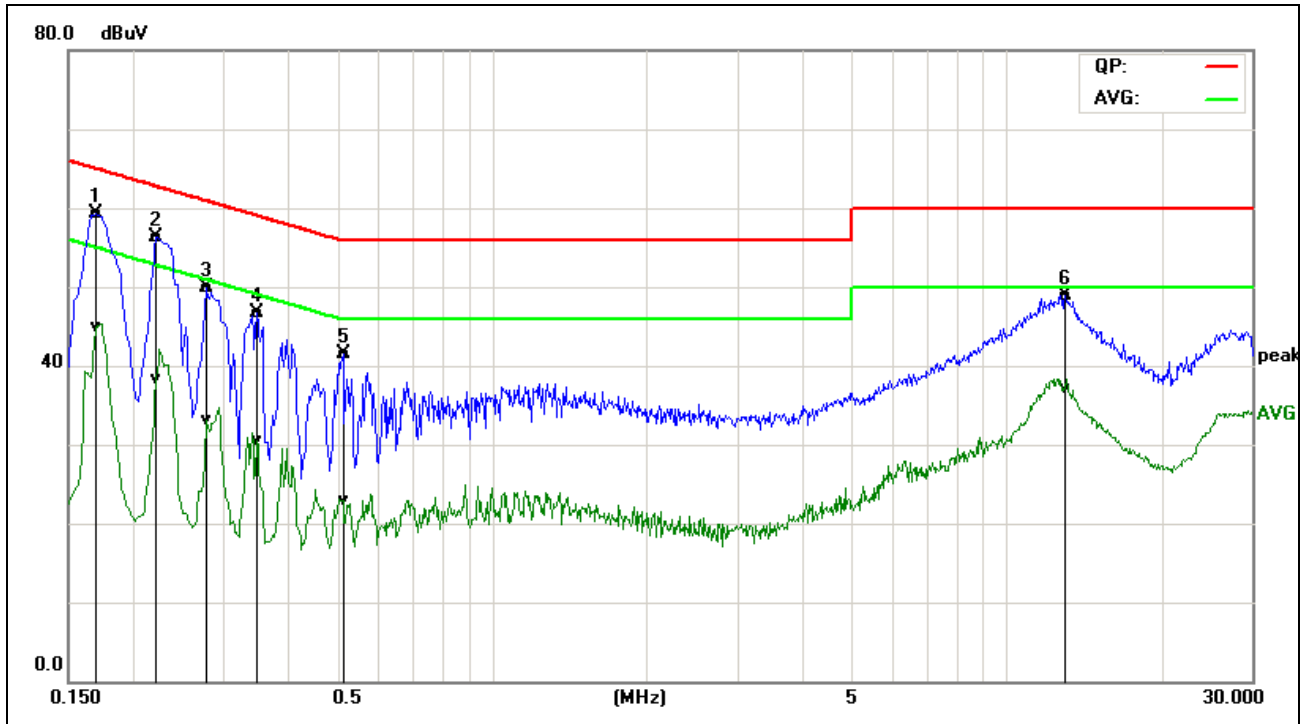

Frequency (MHz)	QuasiPeak Reading (dBuV)	Average Reading (dBuV)	Correction Factor (dB)	QuasiPeak Result (dBuV)	Average Result (dBuV)	QuasiPeak Limit (dBuV)	Average Limit (dBuV)	QuasiPeak Margin (dB)	Average Margin (dB)	Remark (Pass/Fail)
0.1700	49.44	35.06	9.78	59.22	44.84	64.96	54.96	-5.74	-10.12	Pass
0.2220	46.59	28.54	9.78	56.37	38.32	62.74	52.74	-6.37	-14.42	Pass
0.2779	40.07	23.41	9.76	49.83	33.17	60.88	50.88	-11.05	-17.71	Pass
0.3500	37.00	20.71	9.73	46.73	30.44	58.96	48.96	-12.23	-18.52	Pass
0.5140	31.73	13.14	9.68	41.41	22.82	56.00	46.00	-14.59	-23.18	Pass
13.0180	39.19	27.35	9.77	48.96	37.12	60.00	50.00	-11.04	-12.88	Pass



## 6.10 FREQUENCY STABILITY

### 6.10.1 LIMIT

According to §15.407(g), manufacturers of U-NII devices are responsible for ensuring frequency stability such that an emission is maintained within the band of operation under all conditions of normal operation as specified in the operational description.

### 6.10.2 TEST INSTRUMENTS

Name of Equipment	Manufacturer	Model Number	Serial Number	Last Calibration	Due Calibration
Spectrum Analyzer	Agilent	N9010A	MY52221469	10/25/2015	10/24/2016
DC Power Supply	DAZHENG	PS-605D	20018978	N.C.R	N.C.R
AC POWER SOURCE	UMART	HPA1010	N/A	N.C.R	N.C.R
Power Meter	Anritsu	ML2495A	1204003	02/21/2016	02/20/2017
Power Sensor	Anritsu	MA2411B	1126150	02/21/2016	02/20/2017
Temperature Chamber	TERCHY	MHG-800N	E21104	02/21/2016	02/20/2017
Temp. / Humidity Meter	Anymetre	JR913	N/A	02/21/2016	02/20/2017

### 6.10.3 TEST CONFIGURATION

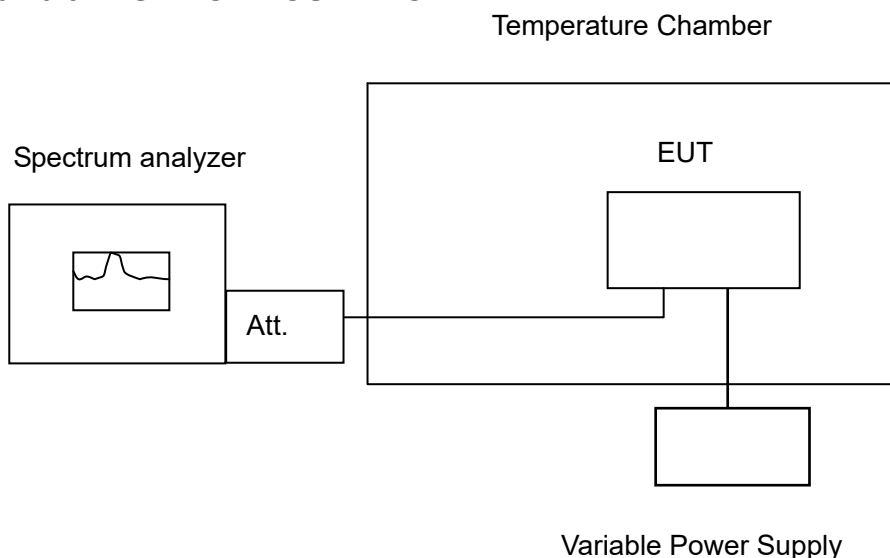

**Remark:** Measurement setup for testing on Antenna connector



#### **6.10.4 TEST PROCEDURE**

The equipment under test was connected to an external AC or DC power supply and input rated voltage. RF output was connected to a frequency counter or spectrum analyzer via feed through attenuators. The EUT was placed inside the temperature chamber. Set the spectrum analyzer RBW low enough to obtain the desired frequency resolution and measure EUT 20°C operating frequency as reference frequency. Turn EUT off and set the chamber temperature to -20°C. After the temperature stabilized for approximately 30 minutes recorded the frequency. Repeat step measure with 10°C increased per stage until the highest temperature of +50°C reached.

#### **6.10.5 TEST RESULTS**

*No non-compliance noted.*



**Test Data**  
**Antenna 1**

**5745 ~ 5805MHz**

**(Low)**

Environment Temperature ( °C )	Volage (V)	Measured Frequency (MHz)	limit Range	Test Result
50	7.40	5744.965430	5725-5825	PASS
40	7.40	5744.959707	5725-5825	PASS
30	7.40	5744.952241	5725-5825	PASS
20	7.40	5744.979654	5725-5825	PASS
10	7.40	5744.982962	5725-5825	PASS
0	7.40	5744.956371	5725-5825	PASS
-10	7.40	5744.954846	5725-5825	PASS
-20	7.40	5744.989655	5725-5825	PASS

Environment Temperature ( °C )	Volage (V)	Measured Frequency (MHz)	limit Range	Test Result
20	6.66	5744.967688	5725-5825	PASS
	7.40	5744.979654	5725-5825	PASS
	8.14	5744.981768	5725-5825	PASS

**5745 ~ 5825MHz**

**(High)**

Environment Temperature ( °C )	Volage (V)	Measured Frequency (MHz)	limit Range	Test Result
50	7.40	5809.976639	5725-5825	PASS
40	7.40	5809.998164	5725-5825	PASS
30	7.40	5809.954581	5725-5825	PASS
20	7.40	5810.998973	5725-5825	PASS
10	7.40	5809.987696	5725-5825	PASS
0	7.40	5809.999776	5725-5825	PASS
-10	7.40	5809.985841	5725-5825	PASS
-20	7.40	5809.971159	5725-5825	PASS

Environment Temperature ( °C )	Volage (V)	Measured Frequency (MHz)	limit Range	Test Result
20	6.66	5809.999106	5725-5825	PASS
	7.40	5810.998973	5725-5825	PASS
	8.14	5809.985034	5725-5825	PASS



**Antenna 2**

5745 ~ 5805MHz

(Low)

Environment Temperature ( °C )	Volage (V)	Measured Frequency (MHz)	limit Range	Test Result
50	7.40	5744.965841	5725-5825	PASS
40	7.40	5744.978476	5725-5825	PASS
30	7.40	5744.954836	5725-5825	PASS
20	7.40	5744.989917	5725-5825	PASS
10	7.40	5744.992853	5725-5825	PASS
0	7.40	5744.985905	5725-5825	PASS
-10	7.40	5744.976472	5725-5825	PASS
-20	7.40	5744.990460	5725-5825	PASS

Environment Temperature ( °C )	Volage (V)	Measured Frequency (MHz)	limit Range	Test Result
20	6.66	5744.959211	5725-5825	PASS
	7.40	5744.989917	5725-5825	PASS
	8.14	5744.971552	5725-5825	PASS

5745 ~ 5825MHz

(High)

Environment Temperature ( °C )	Volage (V)	Measured Frequency (MHz)	limit Range	Test Result
50	7.40	5809.961433	5725-5825	PASS
40	7.40	5809.962454	5725-5825	PASS
30	7.40	5809.990345	5725-5825	PASS
20	7.40	5810.978973	5725-5825	PASS
10	7.40	5809.989653	5725-5825	PASS
0	7.40	5809.968545	5725-5825	PASS
-10	7.40	5809.950469	5725-5825	PASS
-20	7.40	5809.969799	5725-5825	PASS

Environment Temperature ( °C )	Volage (V)	Measured Frequency (MHz)	limit Range	Test Result
20	6.66	5809.971726	5725-5825	PASS
	7.40	5810.978973	5725-5825	PASS
	8.14	5809.961610	5725-5825	PASS