

FCC Radio Test Report

FCC ID: 2AKID-WF40A

Original Grant

Report No. : TB-FCC150658
Applicant : Parts Express Int'l. Inc.
Equipment Under Test (EUT)
EUT Name : WF40A Multi-Room Wi-Fi 2x20W Amplifier with IR Remote
Model No. : WF40A
Series No. : WFA28
Brand Name : Dayton Audio
Receipt Date : 2016-11-20
Test Date : 2016-11-21 to 2016-12-05
Issue Date : 2016-12-06
Standards : FCC Part 15, Subpart C (15.247:2016)
Test Method : ANSI C63.10: 2013
Conclusions : **PASS**

In the configuration tested, the EUT complied with the standards specified above,
The EUT technically complies with the FCC and IC requirements

Test/Witness Engineer :

Iwan Su

Approved & Authorized

:

Ray Ho

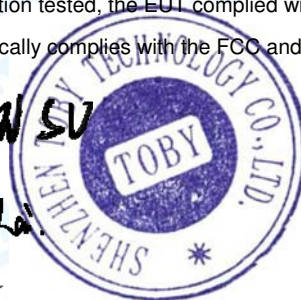

This report details the results of the testing carried out on one sample. The results contained in this test report do not relate to other samples of the same product. The manufacturer should ensure that all products in series production are in conformity with the product sample detailed in the report.

Contents

CONTENTS.....	2
1. GENERAL INFORMATION ABOUT EUT	4
1.1 Client Information.....	4
1.2 General Description of EUT (Equipment Under Test)	4
1.3 Block Diagram Showing the Configuration of System Tested.....	5
1.4 Description of Support Units	6
1.5 Description of Test Mode.....	6
1.6 Description of Test Software Setting	7
1.7 Measurement Uncertainty	8
1.7 Test Facility.....	8
2. TEST SUMMARY.....	9
3. TEST EQUIPMENT.....	10
4. CONDUCTED EMISSION TEST	11
4.1 Test Standard and Limit.....	11
4.2 Test Setup.....	11
4.3 Test Procedure.....	11
4.4 EUT Operating Mode	12
4.5 Test Data.....	12
5. RADIATED EMISSION TEST	17
5.1 Test Standard and Limit.....	17
5.2 Test Setup.....	18
5.3 Test Procedure.....	19
5.4 EUT Operating Condition	20
5.5 Test Data.....	20
6. RESTRICTED BANDS REQUIREMENT	51
6.1 Test Standard and Limit.....	51
6.2 Test Setup.....	51
6.3 Test Procedure.....	51
6.4 EUT Operating Condition	52
6.5 Test Data.....	52
7. BANDWIDTH TEST	75
7.1 Test Standard and Limit.....	75
7.2 Test Setup.....	75
7.3 Test Procedure.....	75
7.4 EUT Operating Condition	75
7.5 Test Data.....	76
8. PEAK OUTPUT POWER TEST.....	92

8.1 Test Standard and Limit.....	92
8.2 Test Setup.....	92
8.3 Test Procedure.....	92
8.4 EUT Operating Condition	92
8.5 Test Data.....	93
9. POWER SPECTRAL DENSITY TEST	96
9.1 Test Standard and Limit.....	96
9.2 Test Setup.....	96
9.3 Test Procedure.....	96
9.4 EUT Operating Condition	96
9.5 Test Data.....	97
10. ANTENNA REQUIREMENT.....	106
10.1 Standard Requirement.....	106
10.2 Antenna Connected Construction.....	106

1. General Information about EUT

1.1 Client Information

Applicant : Parts Express Int'l. Inc.
Address : 705 Pleasant Valley Dr., Springboro, Ohio 45066-1158, USA
Manufacturer : HIGH HIT ELECTRONICS (SHENZHEN) CO., LTD.
Address : BUILDING 25, AREA C, BUYONG INDUSTRIAL RD., SHA JING TOWN, BAO AN ZONE, SHENZHEN CITY, GUANGDONG PROVINCE, CHINA

1.2 General Description of EUT (Equipment Under Test)

EUT Name	:	WF40A Multi-Room Wi-Fi 2x20W Amplifier with IR Remote	
Models No.	:	WF40A, WFA28	
Model Difference	:	All these models are identical in the same PCB layout and electrical circuit, the only difference is model name for commercial.	
Product Description	:	Operation Frequency:	802.11b/g/n(HT20): 2412MHz~2462MHz 802.11n(HT40): 2422MHz~2452MHz
		Number of Channel:	802.11b/g/n(HT20):11 channels <i>see note(3)</i> 802.11n(HT40): 7 channels <i>see note(3)</i>
		RF Output Power:	802.11b: 18.42 dBm 802.11g: 17.58 dBm 802.11n (HT20): 18.71 dBm 802.11n (HT40): 18.61 dBm
		Antenna Gain:	0 dBi PIFA Antenna
		Modulation Type:	802.11b: DSSS(CCK, QPSK, BPSK) 802.11g: OFDM 802.11n: OFDM
		Bit Rate of Transmitter:	802.11b:11/5.5/2/1 Mbps 802.11g:54/48/36/24/18/12/9/6 Mbps 802.11n:up to 150Mbps
Power Supply	:	DC Voltage Supply from AC Adapter	
Power Rating	:	Input: AC 100-240 V 50/60Hz 1A Output: DC15.0 V-----2400mA	
Connecting I/O Port(S)	:	Please refer to the User's Manual	

Note:

(1) This Test Report is FCC Part 15.247 for 802.11b/g/n, the test procedure follows the FCC KDB 558074 D01 DTS Meas Guidance v03r05 and KDB 662911 D01 Multiple Transmitter

Output v02r01.

- (2) For a more detailed features description, please refer to the manufacturer's specifications or the User's Manual.
- (3) Channel List:

Channel	Frequency (MHz)	Channel	Frequency (MHz)	Channel	Frequency (MHz)
01	2412	05	2432	09	2452
02	2417	06	2437	10	2457
03	2422	07	2442	11	2462
04	2427	08	2447		

Note: CH 01~CH 11 for 802.11b/g/n(HT20)
CH 03~CH 09 for 802.11n(HT40)

- (4) Antenna information

Mode	TX Antenna (s)		Remark	
802.11b	1		The worst case is ANT 1 TX	
802.11g	1		The worst case is ANT 1 TX	
802.11n(HT20)	2		ANT 1+ANT 2 TX	
802.11n(HT40)	2		ANT 1+ANT 2 TX	
Antenna	Brand	Model Name	Type	Antenna Gain(dBi)
ANT1	N/A	N/A	PIFA	0
ANT2	N/A	N/A	PIFA	0

Note:For MIMO mode: Directional gain=Gain(Ant1)+Gain(Ant1)=3.01 dBi in 2.4G 802.11 n(HT20/HT40) has MIMO mode.

1.3 Block Diagram Showing the Configuration of System Tested

TX Mode

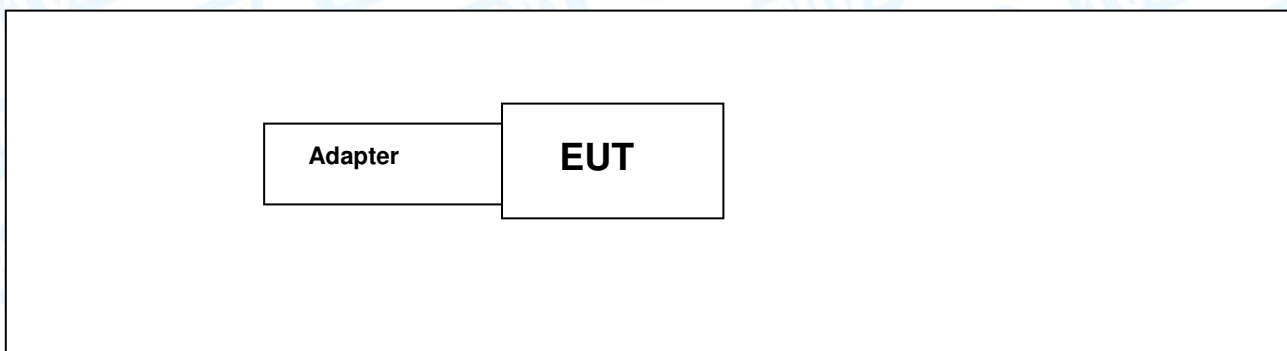

1.4 Description of Support Units

The EUT has been test as an independent unit

1.5 Description of Test Mode

To investigate the maximum EMI emission characteristics generates from EUT, the test system was pre-scanning tested base on the consideration of following EUT operation mode or test configuration mode which possible have effect on EMI emission level. Each of these EUT operation mode(s) or test configuration mode(s) mentioned follow was evaluated respectively.

For Conducted Test	
Final Test Mode	Description
Mode 1	TX B Mode

For Radiated Test	
Final Test Mode	Description
Mode 2	TX Mode B Mode Channel 01/06/11
Mode 3	TX Mode G Mode Channel 01/06/11
Mode 4	TX Mode N(HT20) Mode Channel 01/06/11
Mode 4	TX Mode N(HT40) Mode Channel 03/06/09

Note:

- For all test, we have verified the construction and function in typical operation. And all the test modes were carried out with the EUT in transmitting operation in maximum power with all kinds of data rate.
According to ANSI C63.10 standards, the measurements are performed at the highest, middle, lowest available channels, and the worst case data rate as follows:
802.11b Mode: CCK (1 Mbps)
802.11g Mode: OFDM (6 Mbps)
802.11n (HT20) Mode: MCS 0 (6.5 Mbps)
802.11n (HT40) Mode: MCS 0 (13 Mbps)
- During the testing procedure, the continuously transmitting with the maximum power mode was programmed by the customer.
- The EUT is considered a mobile unit; in normal use it was positioned on X-plane. The worst case was found positioned on X-plane. Therefore only the test data of this X-plane was used for radiated emission measurement test.

1.6 Description of Test Software Setting

During testing channel & Power controlling software provided by the customer was used to control the operating channel as well as the output power level. The RF output power selection is for the setting of RF output power expected by the customer and is going to be fixed on the firmware of the final end product power parameters of WLAN.

Test Software:				
QATool_Dbg				
Test Mode: Continuously transmitting				
Mode	Data Rate	Channel	Parameters	
			ANT 1	ANT 2
802.11b	CCK/ 1Mbps	01	18	18
	CCK/ 1Mbps	06	18	18
	CCK/ 1Mbps	11	18	18
802.11g	OFDM/ 6Mbps	01	23	23
	OFDM/ 6Mbps	06	23	23
	OFDM/ 6Mbps	11	23	23
802.11n(20)	MCS 0	01	20	20
	MCS 0	06	20	20
	MCS 0	11	20	20
802.11n(40)	MCS 0	03	20	20
	MCS 0	06	20	20
	MCS 0	09	20	20

Note: TX signal at 802.11b/g mode only could transmit at Ant.1 or Ant. 2. All the test mode have pretest with two Antenna, but the worst case is ANT 1. The report only show the worst case.

1.7 Measurement Uncertainty

The reported uncertainty of measurement $y \pm U$, where expanded uncertainty U is based on a standard uncertainty multiplied by a coverage factor of $k=2$, providing a level of confidence of approximately 95 %.

Test Item	Parameters	Expanded Uncertainty (U_{Lab})
Conducted Emission	Level Accuracy: 9kHz~150kHz	± 3.42 dB
	150kHz to 30MHz	± 3.42 dB
Radiated Emission	Level Accuracy: 9kHz to 30 MHz	± 4.60 dB
Radiated Emission	Level Accuracy: 30MHz to 1000 MHz	± 4.40 dB
Radiated Emission	Level Accuracy: Above 1000MHz	± 4.20 dB

1.7 Test Facility

The testing report were performed by the Shenzhen Toby Technology Co., Ltd., in their facilities located at 1A/F., Bldg.6, Yusheng Industrial Zone, The National Road No.107 Xixiang Section 467, Xixiang, Bao'an, Shenzhen, Guangdong, China. At the time of testing, the following bodies accredited the Laboratory:

CNAS (L5813)

The Laboratory has been accredited by CNAS to ISO/IEC 17025: 2005 General Requirements for the Competence of Testing and Calibration Laboratories for the competence in the field of testing. And the Registration No.: CNAS L5813.

FCC List No.: (811562)

The Laboratory is listed in the United States of American Federal Communications Commission (FCC), and the registration number is 811562.

IC Registration No.: (11950A-1)

The Laboratory has been registered by Certification and Engineering Bureau of Industry Canada for radio equipment testing. The site registration: Site# 11950A-1.

2. Test Summary

FCC Part 15 Subpart C(15.247)/ RSS 247 Issue 1				
Standard Section		Test Item	Judgment	Remark
FCC	IC			
15.203	/	Antenna Requirement	PASS	N/A
15.207	RSS-GEN 7.2.4	Conducted Emission	PASS	N/A
15.205	RSS-GEN 7.2.2	Restricted Bands	PASS	N/A
15.247(a)(2)	RSS 247 5.2 (1)	6dB Bandwidth	PASS	N/A
15.247(b)	RSS 247 5.4 (4)	Peak Output Power	PASS	N/A
15.247(e)	RSS 247 5.2 (2)	Power Spectral Density	PASS	N/A
15.247(d)& 15.209	RSS 247 5.5	Transmitter Radiated Spurious Emission	PASS	N/A

Note: “/” for no requirement for this test item.
N/A is an abbreviation for Not Applicable.

3. Test Equipment

Conducted Emission Test					
Equipment	Manufacturer	Model No.	Serial No.	Last Cal.	Cal. Due Date
EMI Test Receiver	Rohde & Schwarz	ESCI	100321	Jul. 22, 2016	Jul. 21, 2017
RF Switching Unit	Compliance Direction Systems Inc	RSU-A4	34403	Jul. 22, 2016	Jul. 21, 2017
AMN	SCHWARZBECK	NNBL 8226-2	8226-2/164	Jul. 22, 2016	Jul. 21, 2017
LISN	Rohde & Schwarz	ENV216	101131	Jul. 22, 2016	Jul. 21, 2017
Radiation Emission Test					
Equipment	Manufacturer	Model No.	Serial No.	Last Cal.	Cal. Due Date
Spectrum Analyzer	Agilent	E4407B	MY45106456	Jul. 22, 2016	Jul. 21, 2017
EMI Test Receiver	Rohde & Schwarz	ESPI	100010/007	Jul. 22, 2016	Jul. 21, 2017
Bilog Antenna	ETS-LINDGREN	3142E	00117537	Mar. 20, 2016	Mar. 19, 2017
Bilog Antenna	ETS-LINDGREN	3142E	00117542	Mar. 20, 2016	Mar. 19, 2017
Horn Antenna	ETS-LINDGREN	3117	00143207	Mar. 19, 2016	Mar. 18, 2017
Horn Antenna	ETS-LINDGREN	3117	00143209	Mar. 19, 2016	Mar. 18, 2017
Pre-amplifier	Sonoma	310N	185903	Mar. 20, 2016	Mar. 19, 2017
Pre-amplifier	HP	8447B	3008A00849	Mar. 26, 2016	Mar. 25, 2017
Loop Antenna	Laplace instrument	RF300	0701	Mar. 19, 2016	Mar. 18, 2017
Cable	HUBER+SUHNER	100	SUCOFLEX	Mar. 26, 2016	Mar. 25, 2017
Positioning Controller	ETS-LINDGREN	2090	N/A	N/A	N/A
Antenna Conducted Emission					
Equipment	Manufacturer	Model No.	Serial No.	Last Cal.	Cal. Due Date
Spectrum Analyzer	Agilent	E4407B	MY45106456	Jul. 22, 2016	Jul. 21, 2017
Spectrum Analyzer	Rohde & Schwarz	ESCI	100321	Jul. 22, 2016	Jul. 21, 2017
Power Meter	Anritsu	ML2495A	25406005	Jul. 22, 2016	Jul. 21, 2017
Power Sensor	Anritsu	ML2411B	25406005	Jul. 22, 2016	Jul. 21, 2017

4. Conducted Emission Test

4.1 Test Standard and Limit

4.1.1 Test Standard

FCC Part 15.207

4.1.2 Test Limit

Conducted Emission Test Limit

Frequency	Maximum RF Line Voltage (dB μ V)	
	Quasi-peak Level	Average Level
150kHz~500kHz	66 ~ 56 *	56 ~ 46 *
500kHz~5MHz	56	46
5MHz~30MHz	60	50

Notes:

(1) *Decreasing linearly with logarithm of the frequency.

(2) The lower limit shall apply at the transition frequencies.

(3) The limit decrease in line with the logarithm of the frequency in the range of 0.15 to 0.50MHz.

4.2 Test Setup

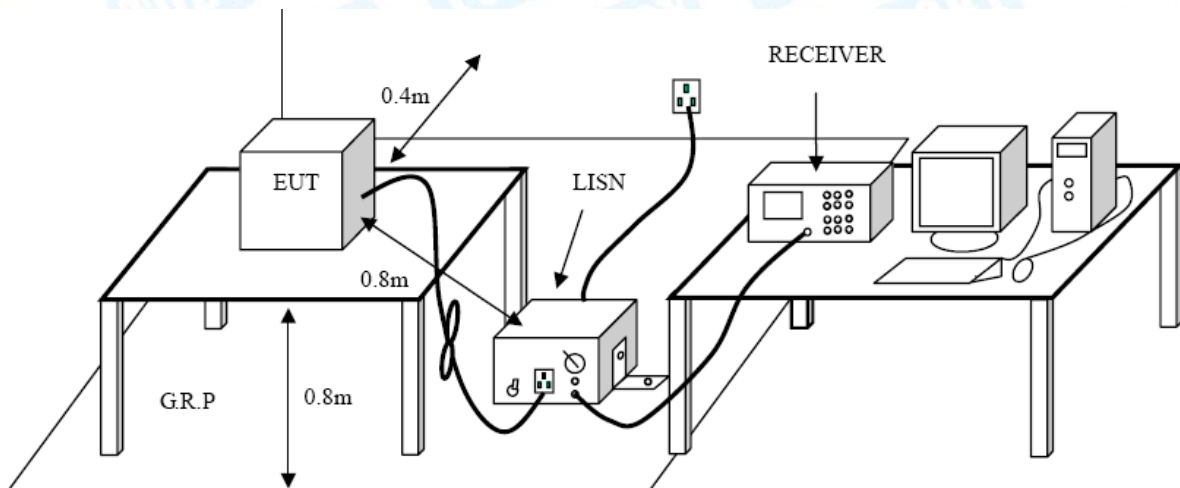

4.3 Test Procedure

The EUT was placed 0.8 meters from the horizontal ground plane with EUT being connected to the power mains through a line impedance stabilization network (LISN). All other support equipments powered from additional LISN(s). The LISN provide 50 Ohm/ 50uH of coupling impedance for the measuring instrument.

Interconnecting cables that hang closer than 40 cm to the ground plane shall be folded back

and forth in the center forming a bundle 30 to 40 cm long.

I/O cables that are not connected to a peripheral shall be bundled in the center. The end of the cable may be terminated, if required, using the correct terminating impedance. The overall length shall not exceed 1 m.

LISN at least 80 cm from nearest part of EUT chassis.

The bandwidth of EMI test receiver is set at 9kHz, and the test frequency band is from 0.15MHz to 30MHz.

4.4 EUT Operating Mode

Please refer to the description of test mode.

4.5 Test Data

Please see the next page.

EUT:	WF40A Multi-Room Wi-Fi 2x20W Amplifier with IR Remote	Model Name :	WF40A
Temperature:	25 °C	Relative Humidity:	55%
Test Voltage:	AC 120V/60 Hz		
Terminal:	Line		
Test Mode:	TX B Mode		
Remark:	Only worse case is reported		

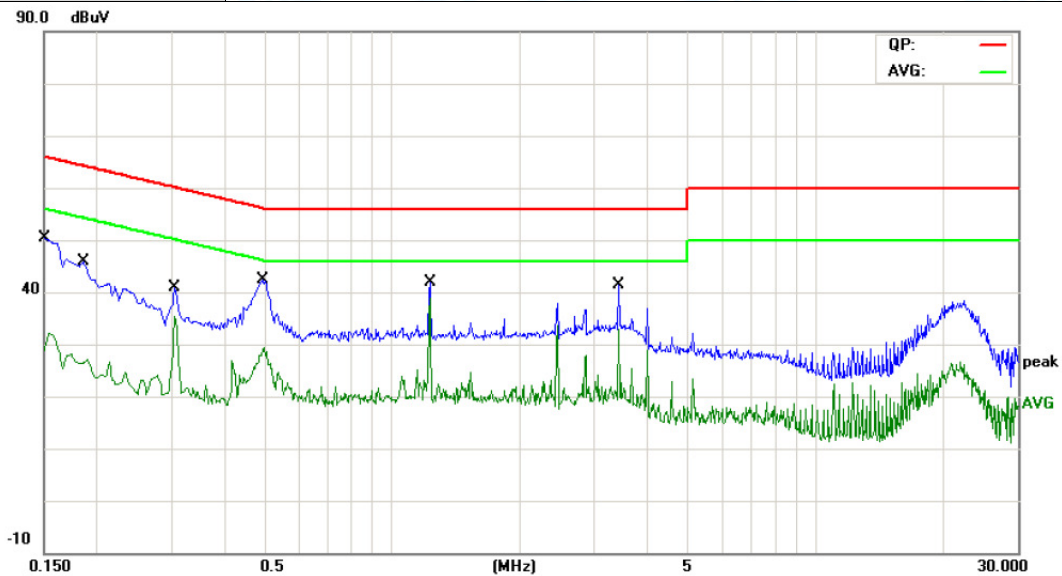

No.	Mk.	Freq. MHz	Reading Level dBuV	Correct Factor dB	Measure- ment dBuV	Limit dBuV	Over dB	Detector
1		0.1500	36.56	10.12	46.68	65.99	-19.31	QP
2		0.1500	18.22	10.12	28.34	55.99	-27.65	AVG
3		0.1860	29.39	10.12	39.51	64.21	-24.70	QP
4		0.1860	13.08	10.12	23.20	54.21	-31.01	AVG
5		0.3060	27.68	10.08	37.76	60.08	-22.32	QP
6		0.3060	25.20	10.08	35.28	50.08	-14.80	AVG
7		0.4940	29.71	10.02	39.73	56.10	-16.37	QP
8		0.4940	17.83	10.02	27.85	46.10	-18.25	AVG
9		1.2260	29.44	10.14	39.58	56.00	-16.42	QP
10	*	1.2260	28.37	10.14	38.51	46.00	-7.49	AVG
11		3.4260	25.22	10.06	35.28	56.00	-20.72	QP
12		3.4260	20.29	10.06	30.35	46.00	-15.65	AVG

Emission Level= Read Level+ Correct Factor

EUT:	WF40A Multi-Room Wi-Fi 2x20W Amplifier with IR Remote	Model Name :	WF40A
Temperature:	25 °C	Relative Humidity:	55%
Test Voltage:	AC 120V/60 Hz		
Terminal:	Neutral		
Test Mode:	TX B Mode		
Remark:	Only worse case is reported		

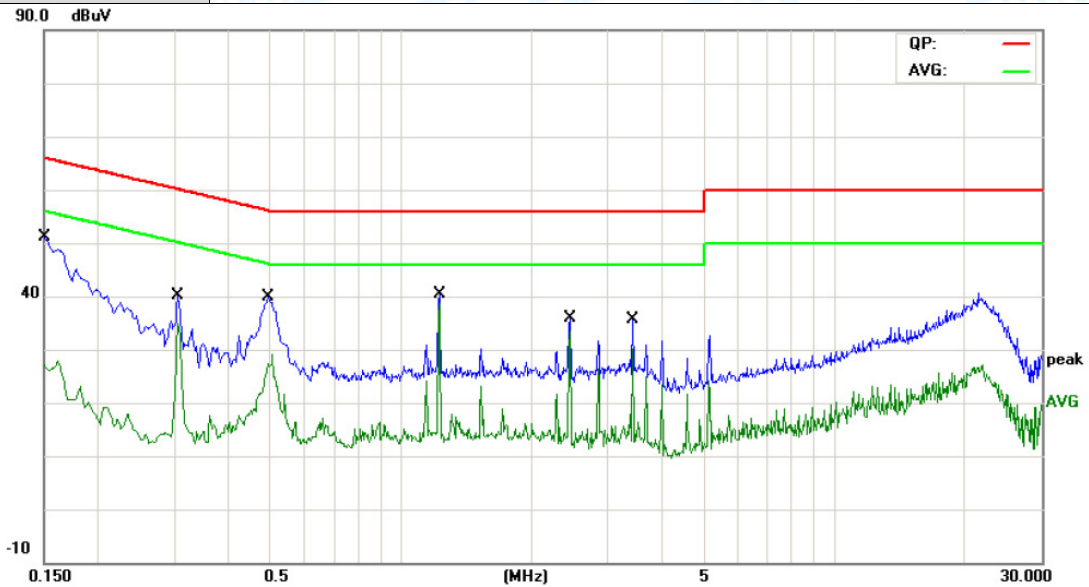

No.	Mk.	Freq. MHz	Reading Level dBuV	Correct Factor dB	Measure- ment dBuV	Limit dBuV	Over dB	Detector
1		0.1500	35.85	10.12	45.97	65.99	-20.02	QP
2		0.1500	13.92	10.12	24.04	55.99	-31.95	AVG
3		0.3060	25.03	10.08	35.11	60.08	-24.97	QP
4		0.3060	24.13	10.08	34.21	50.08	-15.87	AVG
5		0.4940	27.57	10.02	37.59	56.10	-18.51	QP
6		0.4940	17.07	10.02	27.09	46.10	-19.01	AVG
7		1.2260	28.58	10.14	38.72	56.00	-17.28	QP
8	*	1.2260	28.03	10.14	38.17	46.00	-7.83	AVG
9		2.4500	23.98	10.06	34.04	56.00	-21.96	QP
10		2.4500	23.08	10.06	33.14	46.00	-12.86	AVG
11		3.4260	23.40	10.06	33.46	56.00	-22.54	QP
12		3.4260	20.40	10.06	30.46	46.00	-15.54	AVG

Emission Level= Read Level+ Correct Factor

EUT:	WF40A Multi-Room Wi-Fi 2x20W Amplifier with IR Remote	Model Name :	WF40A
Temperature:	25 °C	Relative Humidity:	55%
Test Voltage:	AC 240V/60 Hz		
Terminal:	Line		
Test Mode:	TX B Mode		
Remark:	Only worse case is reported		

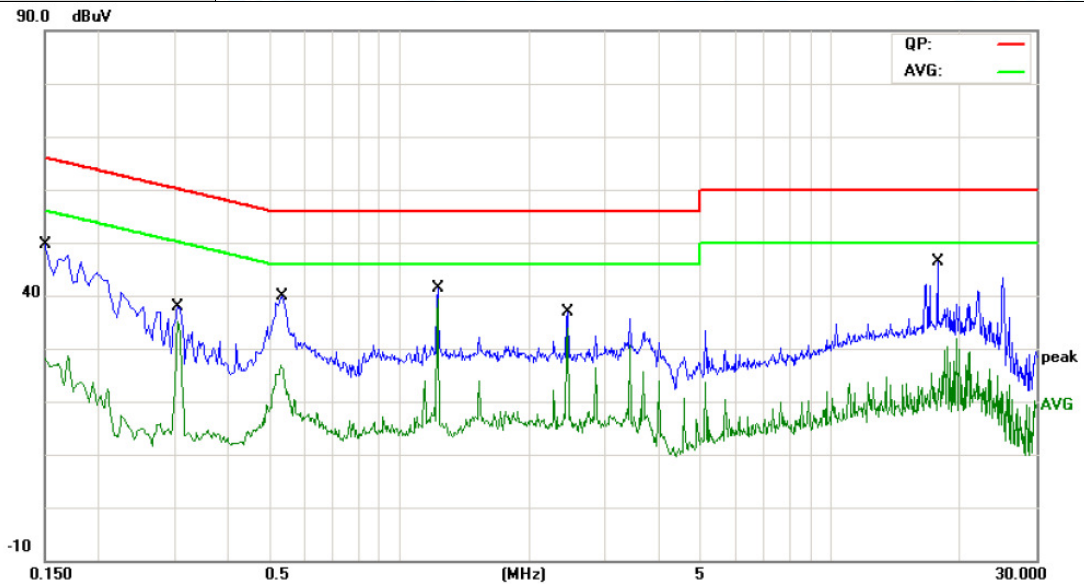

No. Mk.	Freq. MHz	Reading Level dBuV	Correct Factor dB	Measure- ment dBuV	Limit dBuV	Over dB	Detector
1	0.1500	34.26	10.12	44.38	65.99	-21.61	QP
2	0.1500	15.66	10.12	25.78	55.99	-30.21	AVG
3	0.3060	25.82	10.08	35.90	60.08	-24.18	QP
4	0.3060	25.17	10.08	35.25	50.08	-14.83	AVG
5	0.5340	26.74	10.02	36.76	56.00	-19.24	QP
6	0.5340	15.57	10.02	25.59	46.00	-20.41	AVG
7	1.2260	28.64	10.14	38.78	56.00	-17.22	QP
8 *	1.2260	28.08	10.14	38.22	46.00	-7.78	AVG
9	2.4500	24.15	10.06	34.21	56.00	-21.79	QP
10	2.4500	22.64	10.06	32.70	46.00	-13.30	AVG
11	17.7220	18.54	10.06	28.60	60.00	-31.40	QP
12	17.7220	7.73	10.06	17.79	50.00	-32.21	AVG

Emission Level= Read Level+ Correct Factor

EUT:	WF40A Multi-Room Wi-Fi 2x20W Amplifier with IR Remote	Model Name :	WF40A
Temperature:	25 °C	Relative Humidity:	55%
Test Voltage:	AC 240V/60 Hz		
Terminal:	Neutral		
Test Mode:	TX B Mode		
Remark:	Only worse case is reported		

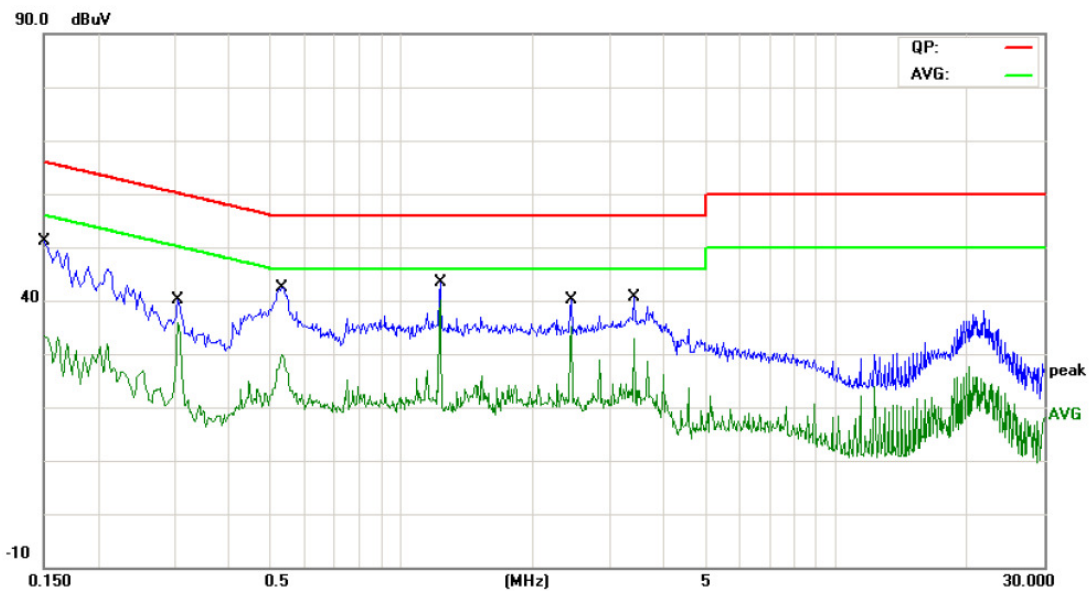

No. Mk.	Freq. MHz	Reading Level dBuV	Correct Factor dB	Measurement dBuV	Limit dBuV	Over dB	Detector
1	0.1500	35.07	10.12	45.19	65.99	-20.80	QP
2	0.1500	20.40	10.12	30.52	55.99	-25.47	AVG
3	0.3060	23.84	10.08	33.92	60.08	-26.16	QP
4	0.3060	16.28	10.08	26.36	50.08	-23.72	AVG
5	0.5299	30.70	10.02	40.72	56.00	-15.28	QP
6	0.5299	20.07	10.02	30.09	46.00	-15.91	AVG
7	1.2260	31.13	10.14	41.27	56.00	-14.73	QP
8 *	1.2260	29.56	10.14	39.70	46.00	-6.30	AVG
9	2.4500	28.58	10.06	38.64	56.00	-17.36	QP
10	2.4500	25.94	10.06	36.00	46.00	-10.00	AVG
11	3.4220	27.58	10.06	37.64	56.00	-18.36	QP
12	3.4220	23.47	10.06	33.53	46.00	-12.47	AVG

Emission Level= Read Level+ Correct Factor

5. Radiated Emission Test

5.1 Test Standard and Limit

5.1.1 Test Standard

FCC Part 15.209

5.1.2 Test Limit

Radiated Emission Limits (9kHz~1000MHz)

Frequency (MHz)	Field Strength (microvolt/meter)	Measurement Distance (meters)
0.009~0.490	2400/F(KHz)	300
0.490~1.705	24000/F(KHz)	30
1.705~30.0	30	30
30~88	100	3
88~216	150	3
216~960	200	3
Above 960	500	3

Radiated Emission Limit (Above 1000MHz)

Frequency (MHz)	Class A (dBuV/m)(at 3 M)		Class B (dBuV/m)(at 3 M)	
	Peak	Average	Peak	Average
Above 1000	80	60	74	54

Note:

- (1) The tighter limit applies at the band edges.
- (2) Emission Level (dBuV/m)=20log Emission Level(uV/m)

5.2 Test Setup

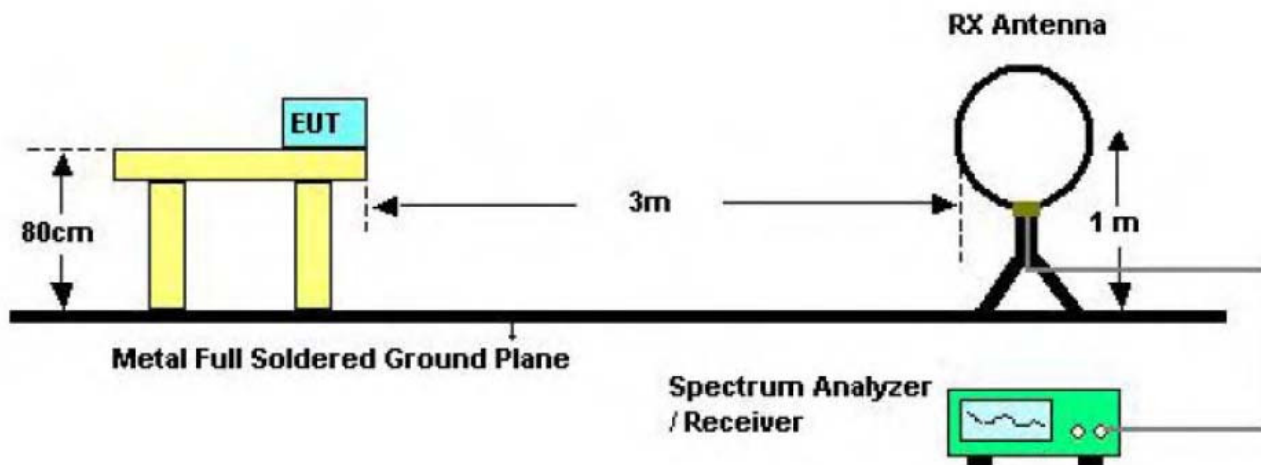

Below 30MHz Test Setup

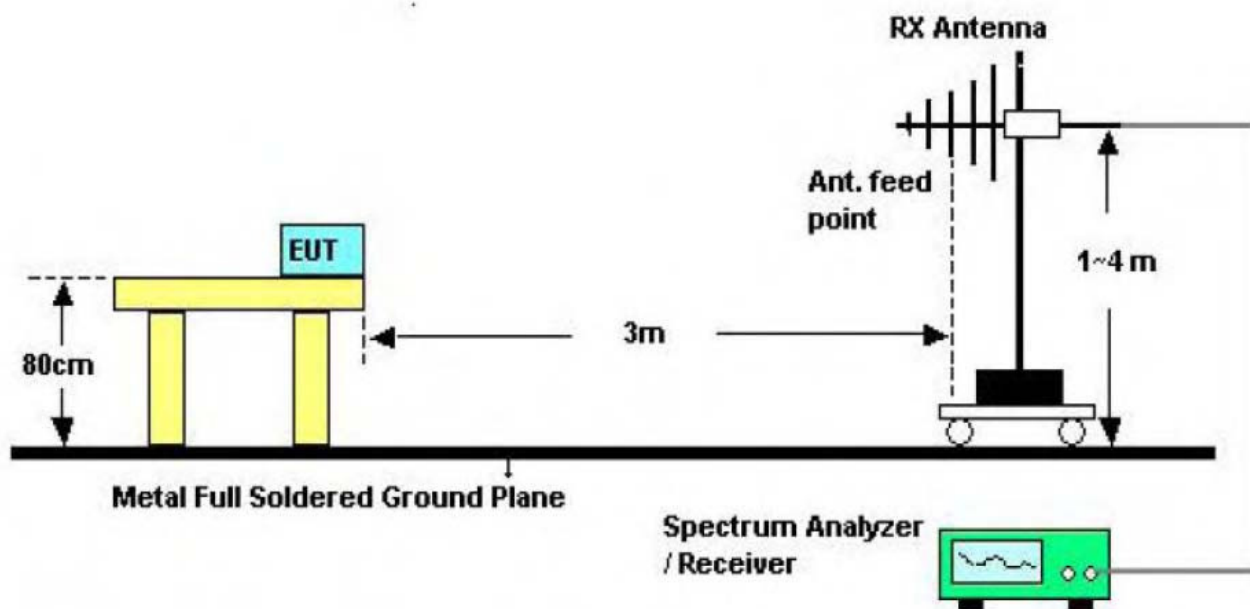

Below 1000MHz Test Setup

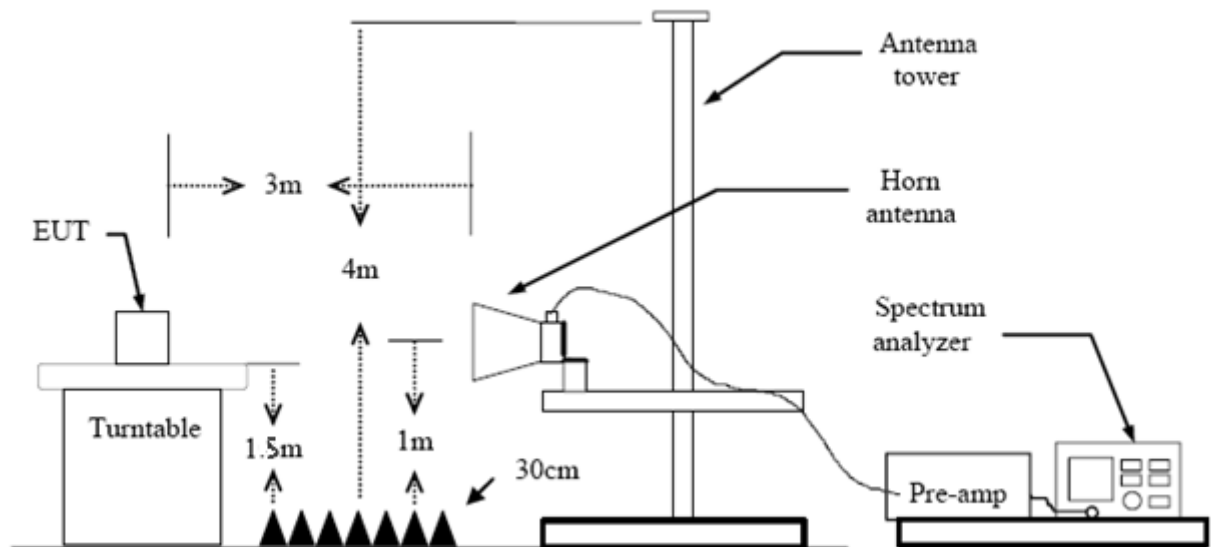

Above 1GHz Test Setup

5.3 Test Procedure

- (1) Measurements at frequency above 1GHz. The EUT was placed on a rotating 1.5m high above the ground. RF absorbers covered the ground plane with a minimum area of 3.0m by 3.0m between the EUT and measurement receiver antenna. The RF absorber shall not exceed 30cm in high above the conducting floor. The table was rotated 360 degrees to determine the position of the highest radiation.
- (2) The Test antenna shall vary between 1m and 4m, Both Horizontal and Vertical antenna are set to make measurement.
- (3) The initial step in collecting conducted emission data is a spectrum analyzer peak detector mode pre-scanning the measurement frequency range. Significant peaks are then marked and then Quasi Peak detector mode re-measured.
- (4) If the Peak Mode measured value compliance with and lower than Quasi Peak Mode Limit Bellow 1 GHz, the EUT shall be deemed to meet QP Limits and then no additional QP Mode measurement performed. But the Peak Value and average value both need to comply with applicable limit above 1 GHz.
- (5) Testing frequency range below 1GHz the measuring instrument use VBW=120 kHz with Quasi-peak detection.
- (6) Testing frequency range above 1GHz the measuring instrument use RBW=1 MHz and VBW=3 MHz with Peak Detector for Peak Values, and use RBW=1 MHz and VBW=10 Hz with Peak Detector for Average Values.
- (7) For the actual test configuration, please see the test setup photo.

5.4 EUT Operating Condition

The Equipment Under Test was set to Continual Transmitting in maximum power.

5.5 Test Data

Remark: During testing above 1GHz the measuring instrument use RBW=1 MHz and VBW=3 MHz with Peak Detector for Peak Values, and use RBW=1 MHz and VBW=10 Hz with Peak Detector for Average Values.

Test data please refer the following pages.

9 KHz~30 MHz

From 9 KHz to 30 MHz: Conclusion: PASS

Note: The amplitude of spurious emissions which are attenuated by more than 20dB below the permissible value has no need to be reported.

30MHz~1GHz

EUT:	WF40A Multi-Room Wi-Fi 2x20W Amplifier with IR Remote	Model:	WF40A
Temperature:	25 °C	Relative Humidity:	55%
Test Voltage:	AC 120V/60 Hz		
Ant. Pol.	Horizontal		
Test Mode:	TX B Mode 2412MHz		
Remark:	Only worse case is reported		

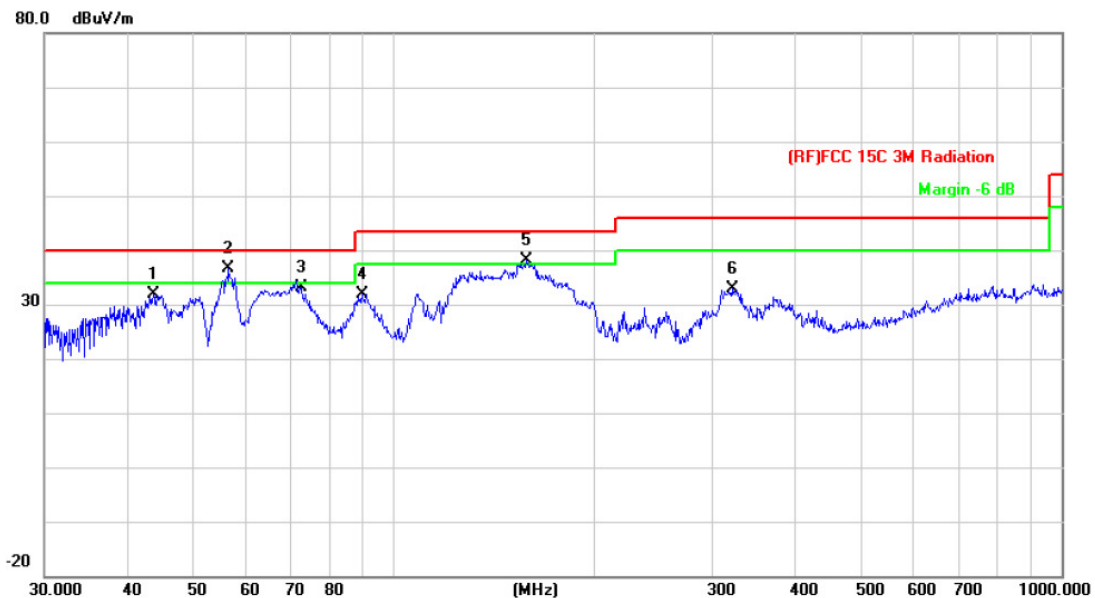

No.	Mk.	Freq. MHz	Reading Level dBuV	Correct Factor dB/m	Measure- ment dBuV/m	Limit dBuV/m	Over dB	Detector
1		43.6584	53.81	-21.83	31.98	40.00	-8.02	peak
2	*	56.5929	61.13	-24.58	36.55	40.00	-3.45	peak
3		72.5916	56.83	-23.60	33.23	40.00	-6.77	peak
4		89.5899	54.64	-22.75	31.89	43.50	-11.61	peak
5	!	158.1123	58.54	-20.42	38.12	43.50	-5.38	peak
6		321.0605	48.61	-15.85	32.76	46.00	-13.24	peak

*:Maximum data x:Over limit !:over margin

Emission Level= Read Level+ Correct Factor

EUT:	WF40A Multi-Room Wi-Fi 2x20W Amplifier with IR Remote	Model:	WF40A
Temperature:	25 °C	Relative Humidity:	55%
Test Voltage:	AC 120V/60 Hz		
Ant. Pol.	Vertical		
Test Mode:	TX B Mode 2412MHz		
Remark:	Only worse case is reported		

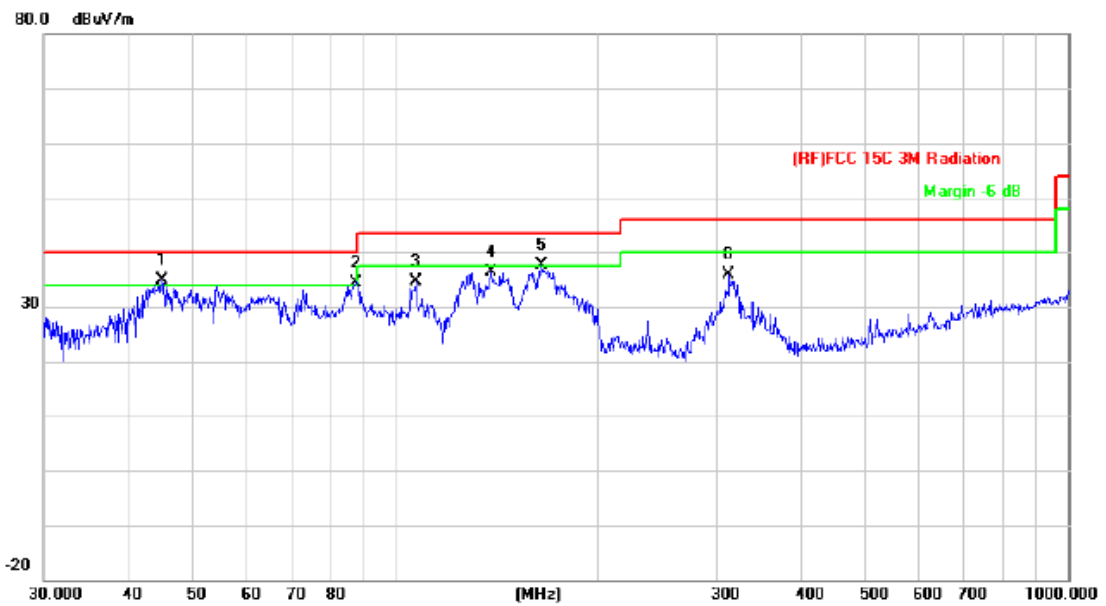

No.	Mk.	Freq.	Reading Level	Correct Factor	Measurement	Limit	Over	Detector
		MHz	dBuV	dB/m	dBuV/m	dBuV/m	dB	
1	*	44.9004	57.27	-22.35	34.92	40.00	-5.08	peak
2	!	87.1115	57.41	-22.91	34.50	40.00	-5.50	peak
3		107.1337	56.47	-21.86	34.61	43.50	-8.89	peak
4		138.3873	58.33	-21.88	36.45	43.50	-7.05	peak
5	!	164.9071	58.29	-20.59	37.70	43.50	-5.80	peak
6		313.2760	52.09	-16.14	35.95	46.00	-10.05	peak

*:Maximum data x:Over limit !:over margin

Emission Level= Read Level+ Correct Factor

EUT:	WF40A Multi-Room Wi-Fi 2x20W Amplifier with IR Remote	Model:	WF40A
Temperature:	25 °C	Relative Humidity:	55%
Test Voltage:	AC 120V/60 Hz		
Ant. Pol.	Horizontal		
Test Mode:	TX B Mode 2437MHz		
Remark:	Only worse case is reported		

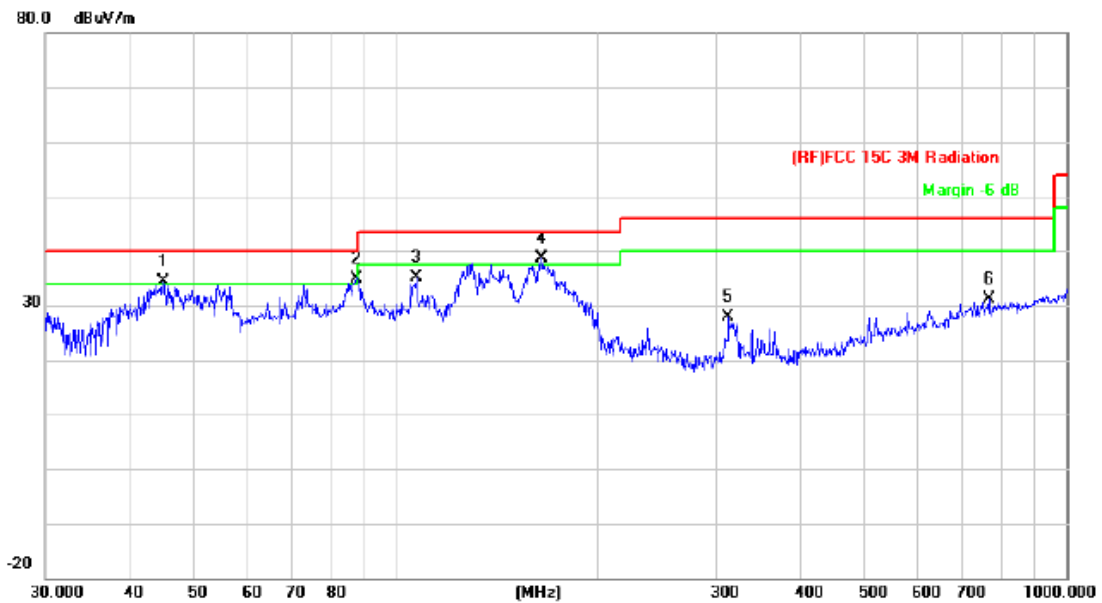

No.	Mk.	Freq. MHz	Reading Level dBuV	Correct Factor dB/m	Measure- ment dBuV/m	Limit dBuV/m	Over dB	Detector
1	!	44.9004	56.77	-22.35	34.42	40.00	-5.58	peak
2	!	87.1115	57.91	-22.91	35.00	40.00	-5.00	peak
3		107.1337	56.97	-21.86	35.11	43.50	-8.39	peak
4	*	164.9071	59.29	-20.59	38.70	43.50	-4.80	peak
5		313.2760	44.09	-16.14	27.95	46.00	-18.05	peak
6		766.0570	36.76	-5.72	31.04	46.00	-14.96	peak

*:Maximum data x:Over limit !:over margin

Emission Level= Read Level+ Correct Factor

EUT:	WF40A Multi-Room Wi-Fi 2x20W Amplifier with IR Remote	Model:	WF40A
Temperature:	25 °C	Relative Humidity:	55%
Test Voltage:	AC 120V/60 Hz		
Ant. Pol.	Vertical		
Test Mode:	TX B Mode 2437MHz		
Remark:	Only worse case is reported		

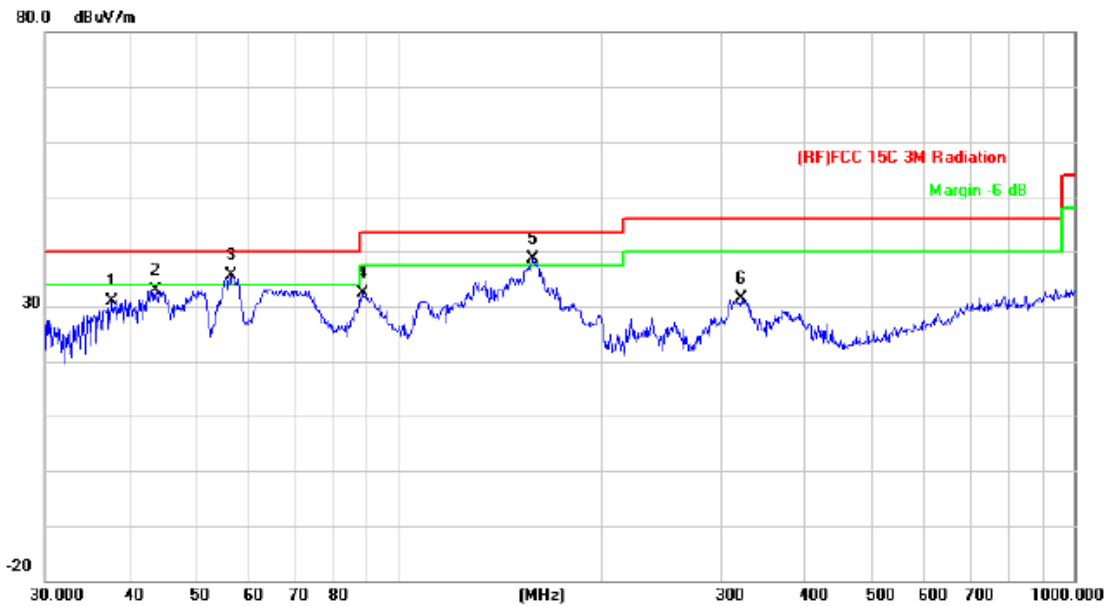

No.	Mk.	Freq. MHz	Reading Level dBuV	Correct Factor dB/m	Measurement dBuV/m	Limit dBuV/m	Over dB	Detector
1		37.6798	49.79	-18.87	30.92	40.00	-9.08	peak
2		43.6584	54.81	-21.83	32.98	40.00	-7.02	peak
3	*	56.5929	60.13	-24.58	35.55	40.00	-4.45	peak
4		88.3421	55.10	-22.84	32.26	43.50	-11.24	peak
5	!	158.1123	59.04	-20.42	38.62	43.50	-4.88	peak
6		321.0605	47.11	-15.85	31.26	46.00	-14.74	peak

*:Maximum data x:Over limit !:over margin

Emission Level= Read Level+ Correct Factor

EUT:	WF40A Multi-Room Wi-Fi 2x20W Amplifier with IR Remote	Model:	WF40A
Temperature:	25 °C	Relative Humidity:	55%
Test Voltage:	AC 120V/60 Hz		
Ant. Pol.	Horizontal		
Test Mode:	TX B Mode 2462MHz		
Remark:	Only worse case is reported		

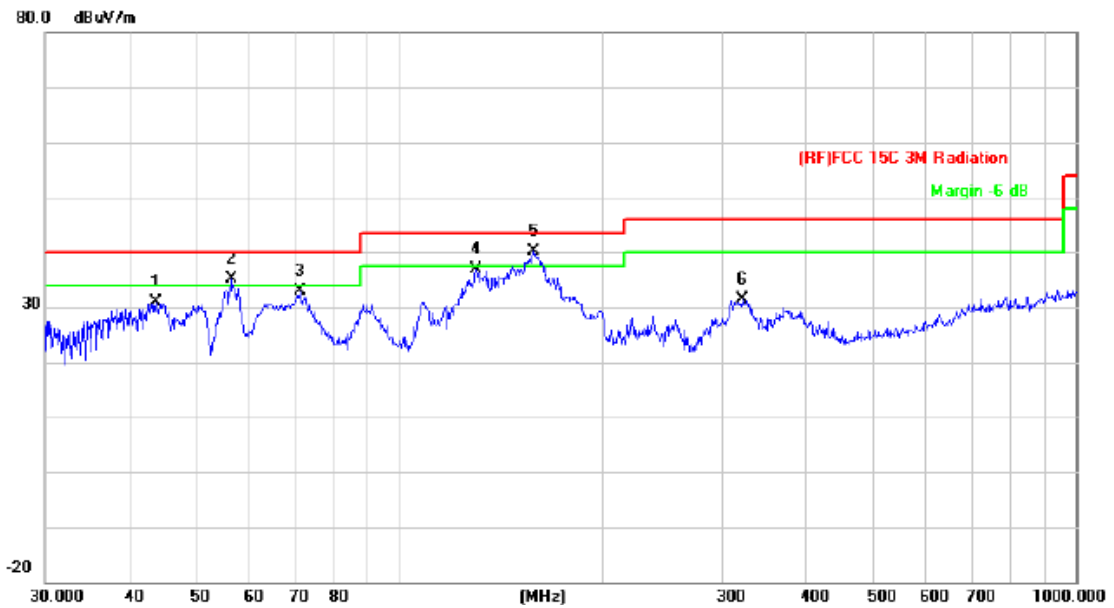

No.	Mk.	Freq. MHz	Reading Level dBuV	Correct Factor dB/m	Measure- ment dBuV/m	Limit dBuV/m	Over dB	Detector
1		43.6584	52.81	-21.83	30.98	40.00	-9.02	peak
2	!	56.5929	59.63	-24.58	35.05	40.00	-4.95	peak
3		71.3298	56.45	-23.64	32.81	40.00	-7.19	peak
4		129.9225	59.01	-22.08	36.93	43.50	-6.57	peak
5	*	158.1123	60.54	-20.42	40.12	43.50	-3.38	peak
6		321.0605	47.11	-15.85	31.26	46.00	-14.74	peak

*:Maximum data x:Over limit !:over margin

Emission Level= Read Level+ Correct Factor

EUT:	WF40A Multi-Room Wi-Fi 2x20W Amplifier with IR Remote	Model:	WF40A
Temperature:	25 °C	Relative Humidity:	55%
Test Voltage:	AC 120V/60 Hz		
Ant. Pol.	Vertical		
Test Mode:	TX B Mode 2462MHz		
Remark:	Only worse case is reported		

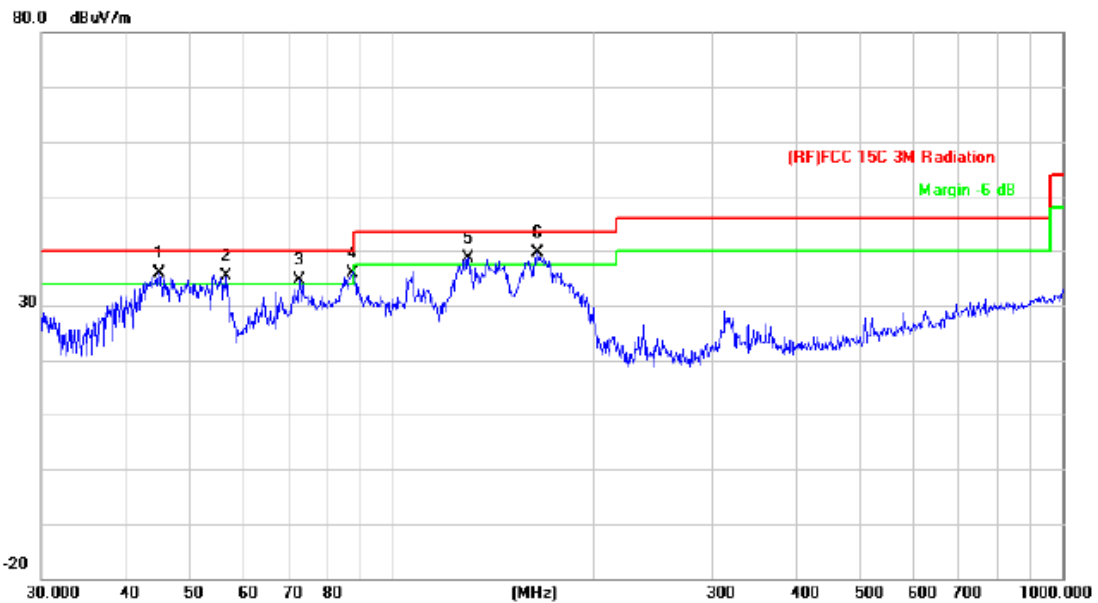

No.	Mk.	Freq.	Reading Level	Correct Factor	Measurement	Limit	Over	
		MHz	dBuV	dB/m	dBuV/m	dBuV/m	dB	Detector
1	!	44.9004	58.27	-22.35	35.92	40.00	-4.08	peak
2	!	56.5929	60.07	-24.58	35.49	40.00	-4.51	peak
3	!	72.5916	58.19	-23.60	34.59	40.00	-5.41	peak
4	!	87.1115	58.91	-22.91	36.00	40.00	-4.00	peak
5	!	129.9225	60.66	-22.08	38.58	43.50	-4.92	peak
6	*	164.9073	60.29	-20.59	39.70	43.50	-3.80	peak

*:Maximum data x:Over limit !:over margin

Emission Level= Read Level+ Correct Factor

Above 1GHz

EUT:	WF40A Multi-Room Wi-Fi 2x20W Amplifier with IR Remote	Model:	WF40A
Temperature:	25 °C	Relative Humidity:	55%
Test Voltage:	AC 120V/60 Hz		
Ant. Pol.	Horizontal		
Test Mode:	TX B Mode 2412MHz ANT 1		
Remark:	No report for the emission which more than 10 dB below the prescribed limit.		

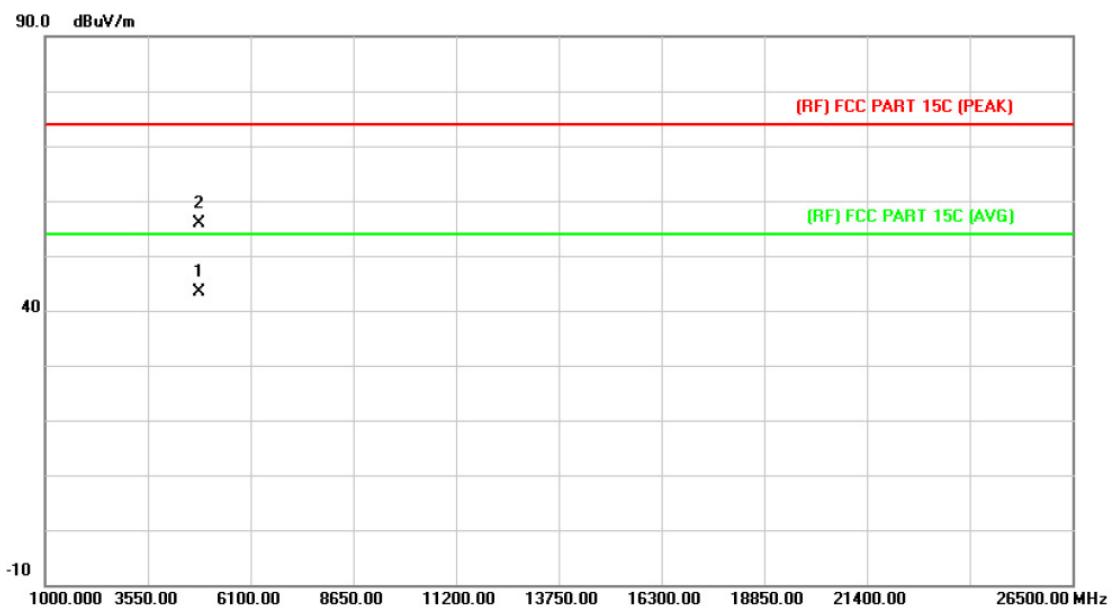

No.	Mk.	Freq. MHz	Reading Level dBuV	Correct Factor dB/m	Measure- ment dBuV/m	Limit dBuV/m	Over dB	Detector
1	*	4824.460	29.90	13.56	43.46	54.00	-10.54	AVG
2		4824.664	42.34	13.56	55.90	74.00	-18.10	peak

Emission Level= Read Level+ Correct Factor

EUT:	WF40A Multi-Room Wi-Fi 2x20W Amplifier with IR Remote	Model:	WF40A
Temperature:	25 °C	Relative Humidity:	55%
Test Voltage:	AC 120V/60 Hz		
Ant. Pol.	Vertical		
Test Mode:	TX B Mode 2412MHz ANT 1		
Remark:	No report for the emission which more than 10 dB below the prescribed limit.		

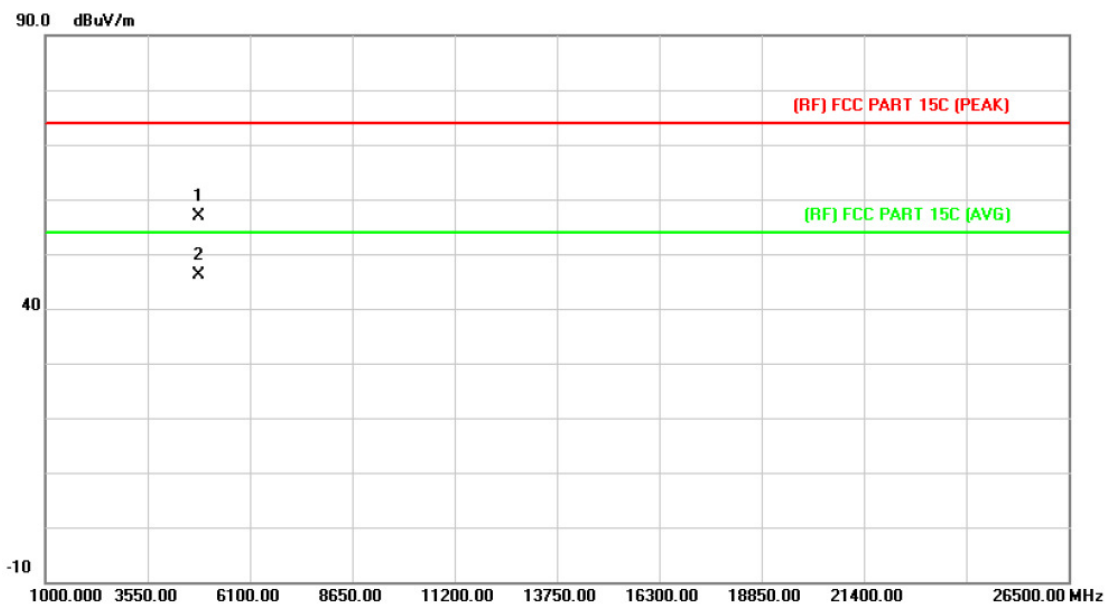

No.	Mk.	Freq. MHz	Reading Level dBuV	Correct Factor dB/m	Measure- ment dBuV/m	Limit dBuV/m	Over dB	Detector
1		4823.480	43.39	13.56	56.95	74.00	-17.05	peak
2	*	4823.768	32.45	13.56	46.01	54.00	-7.99	AVG

Emission Level= Read Level+ Correct Factor

EUT:	WF40A Multi-Room Wi-Fi 2x20W Amplifier with IR Remote	Model:	WF40A
Temperature:	25 °C	Relative Humidity:	55%
Test Voltage:	AC 120V/60 Hz		
Ant. Pol.	Horizontal		
Test Mode:	TX B Mode 2437MHz ANT 1		
Remark:	No report for the emission which more than 10 dB below the prescribed limit.		

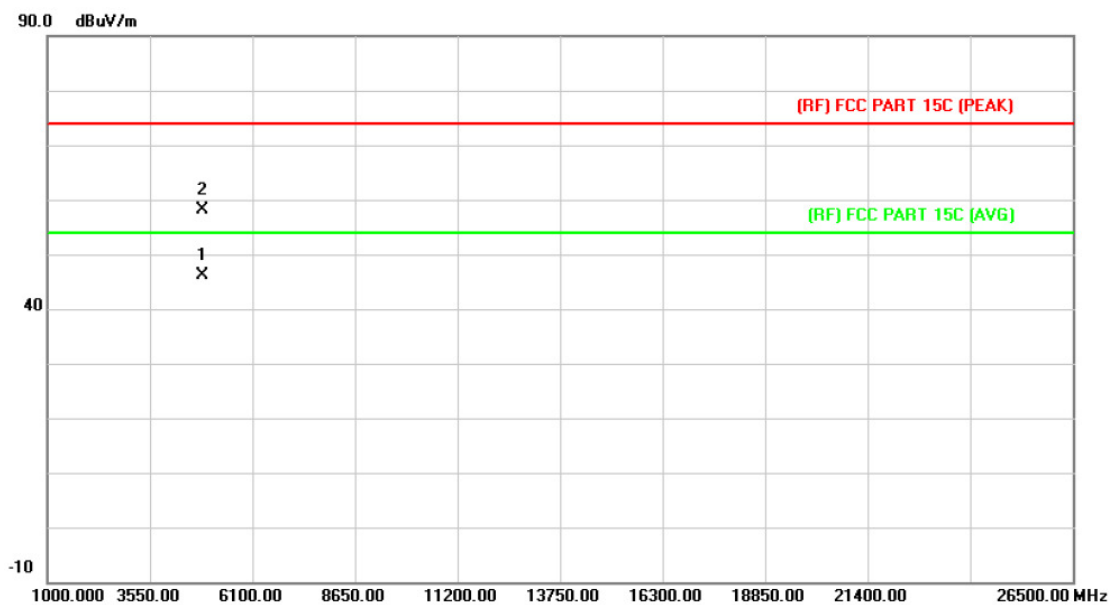

No.	Mk.	Freq.	Reading Level	Correct Factor	Measurement	Limit	Over	Detector
		MHz	dBuV	dB/m	dBuV/m	dBuV/m	dB	
1	*	4873.559	32.27	13.86	46.13	54.00	-7.87	AVG
2		4874.612	44.30	13.86	58.16	74.00	-15.84	peak

Emission Level= Read Level+ Correct Factor

EUT:	WF40A Multi-Room Wi-Fi 2x20W Amplifier with IR Remote	Model:	WF40A
Temperature:	25 °C	Relative Humidity:	55%
Test Voltage:	AC 120V/60 Hz		
Ant. Pol.	Vertical		
Test Mode:	TX B Mode 2437MHz ANT 1		
Remark:	No report for the emission which more than 10 dB below the prescribed limit.		

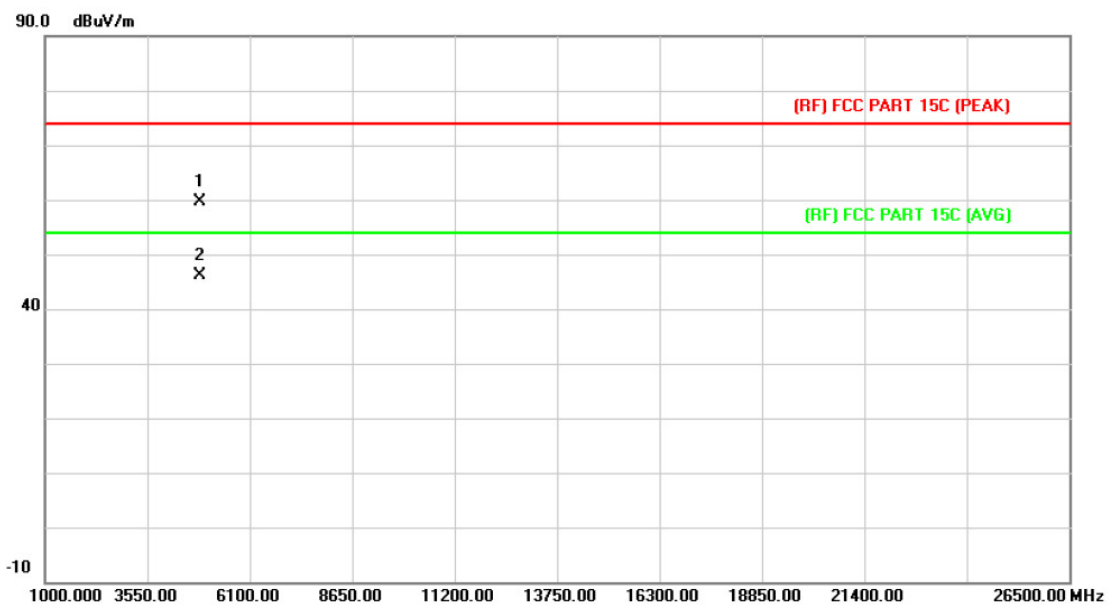

No.	Mk.	Freq.	Reading Level	Correct Factor	Measurement	Limit	Over	Detector
		MHz	dBuV	dB/m	dBuV/m	dBuV/m	dB	
1		4873.519	45.78	13.86	59.64	74.00	-14.36	peak
2	*	4875.967	32.32	13.87	46.19	54.00	-7.81	AVG

Emission Level= Read Level+ Correct Factor

EUT:	WF40A Multi-Room Wi-Fi 2x20W Amplifier with IR Remote	Model:	WF40A
Temperature:	25 °C	Relative Humidity:	55%
Test Voltage:	AC 120V/60 Hz		
Ant. Pol.	Horizontal		
Test Mode:	TX B Mode 2462MHz ANT 1		
Remark:	No report for the emission which more than 10 dB below the prescribed limit.		

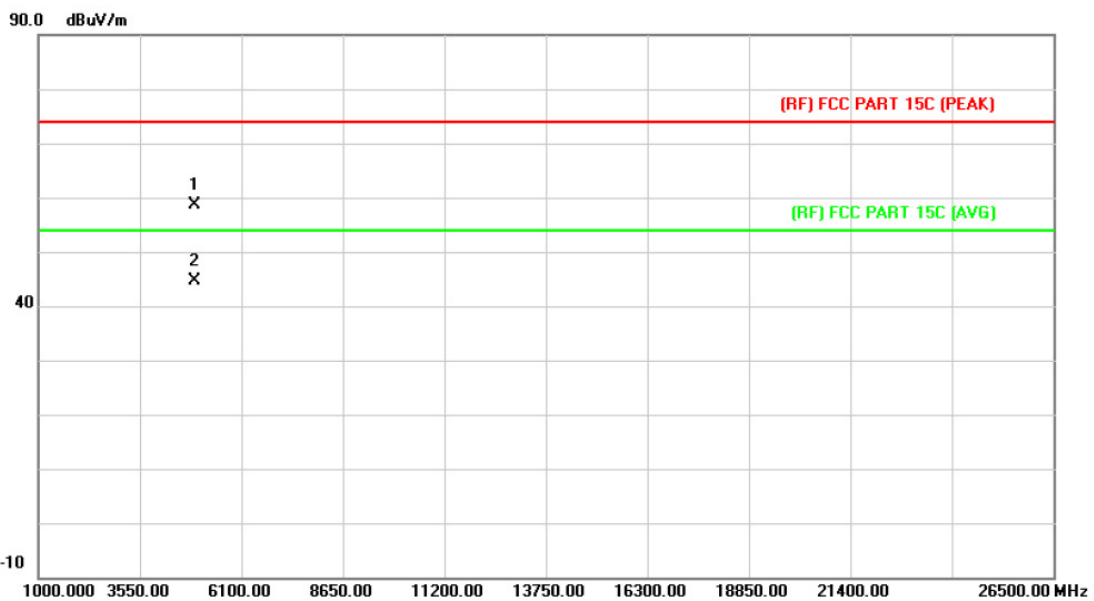

No.	Mk.	Freq. MHz	Reading Level dBuV	Correct Factor dB/m	Measure- ment dBuV/m	Limit dBuV/m	Over dB	Detector
1		4924.334	44.55	14.15	58.70	74.00	-15.30	peak
2	*	4924.574	30.40	14.15	44.55	54.00	-9.45	AVG

Emission Level= Read Level+ Correct Factor

EUT:	WF40A Multi-Room Wi-Fi 2x20W Amplifier with IR Remote	Model:	WF40A
Temperature:	25 °C	Relative Humidity:	55%
Test Voltage:	AC 120V/60 Hz		
Ant. Pol.	Vertical		
Test Mode:	TX B Mode 2462MHz ANT 1		
Remark:	No report for the emission which more than 10 dB below the prescribed limit.		

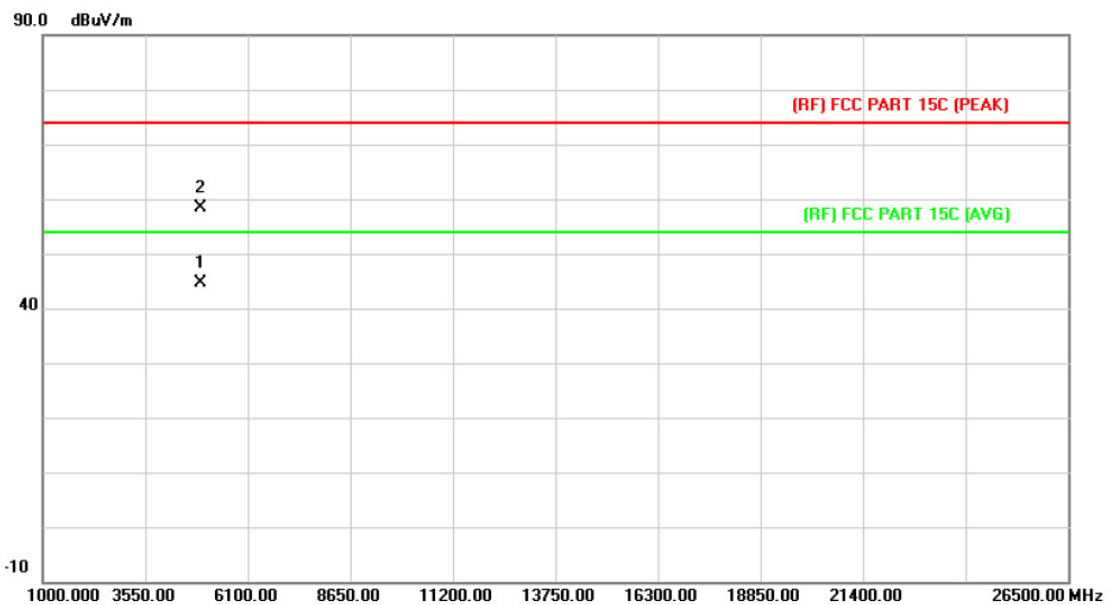

No.	Mk.	Freq. MHz	Reading Level dBuV	Correct Factor dB/m	Measure- ment dBuV/m	Limit dBuV/m	Over dB	Detector
1	*	4923.670	30.56	14.15	44.71	54.00	-9.29	AVG
2		4924.558	44.19	14.15	58.34	74.00	-15.66	peak

Emission Level= Read Level+ Correct Factor

EUT:	WF40A Multi-Room Wi-Fi 2x20W Amplifier with IR Remote	Model:	WF40A
Temperature:	25 °C	Relative Humidity:	55%
Test Voltage:	AC 120V/60 Hz		
Ant. Pol.	Horizontal		
Test Mode:	TX G Mode 2412MHz ANT 1		
Remark:	No report for the emission which more than 10 dB below the prescribed limit.		

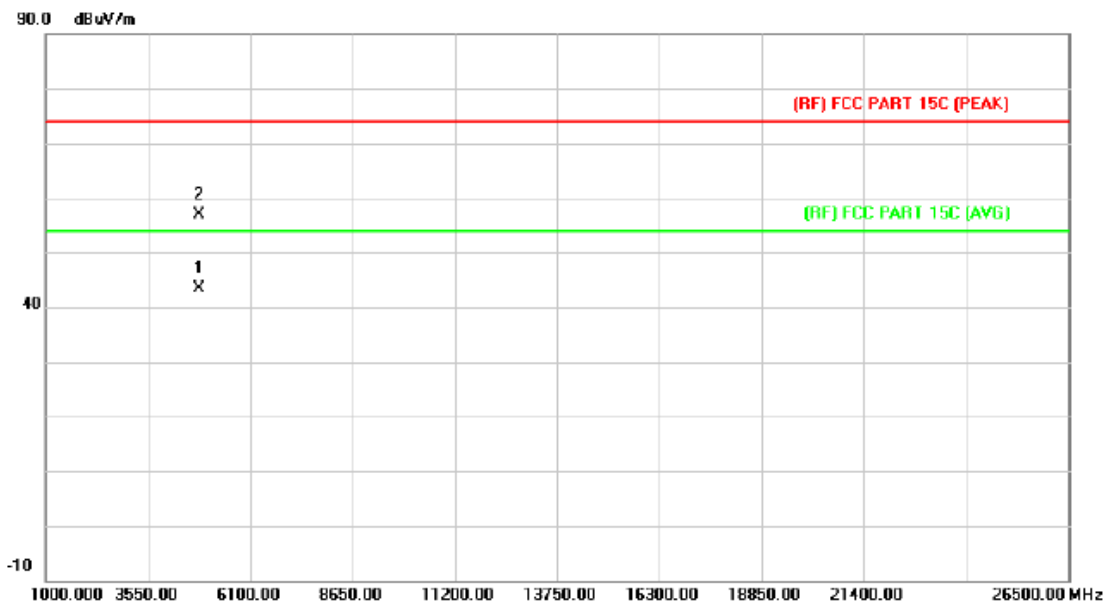

No.	Mk.	Freq. MHz	Reading Level dBuV	Correct Factor dB/m	Measure- ment dBuV/m	Limit dBuV/m	Over dB	Detector
1	*	4823.848	29.72	13.56	43.28	54.00	-10.72	AVG
2		4824.088	43.44	13.56	57.00	74.00	-17.00	peak

Emission Level= Read Level+ Correct Factor

EUT:	WF40A Multi-Room Wi-Fi 2x20W Amplifier with IR Remote	Model:	WF40A
Temperature:	25 °C	Relative Humidity:	55%
Test Voltage:	AC 120V/60 Hz		
Ant. Pol.	Vertical		
Test Mode:	TX G Mode 2412MHz ANT 1		
Remark:	No report for the emission which more than 10 dB below the prescribed limit.		

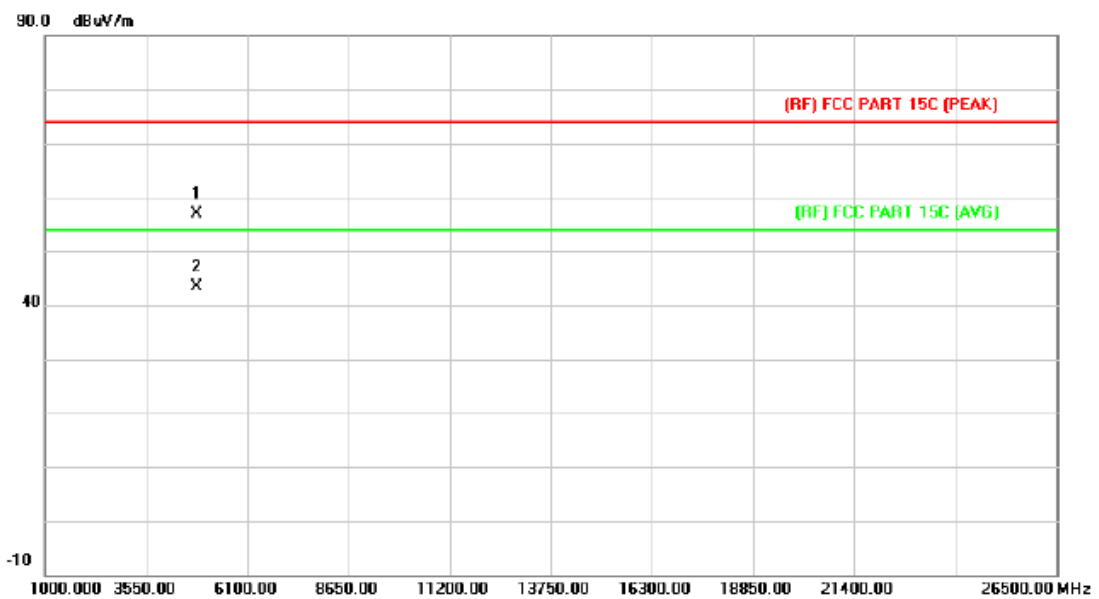

No. Mk.	Freq. MHz	Reading Level dBuV	Correct Factor dB/m	Measure- ment dBuV/m	Limit dBuV/m	Over dB	Detector
1	4823.176	43.42	13.56	56.98	74.00	-17.02	peak
2 *	4824.488	29.88	13.56	43.44	54.00	-10.56	AVG

Emission Level= Read Level+ Correct Factor

EUT:	WF40A Multi-Room Wi-Fi 2x20W Amplifier with IR Remote	Model:	WF40A
Temperature:	25 °C	Relative Humidity:	55%
Test Voltage:	AC 120V/60 Hz		
Ant. Pol.	Horizontal		
Test Mode:	TX G Mode 2437MHz ANT 1		
Remark:	No report for the emission which more than 10 dB below the prescribed limit.		

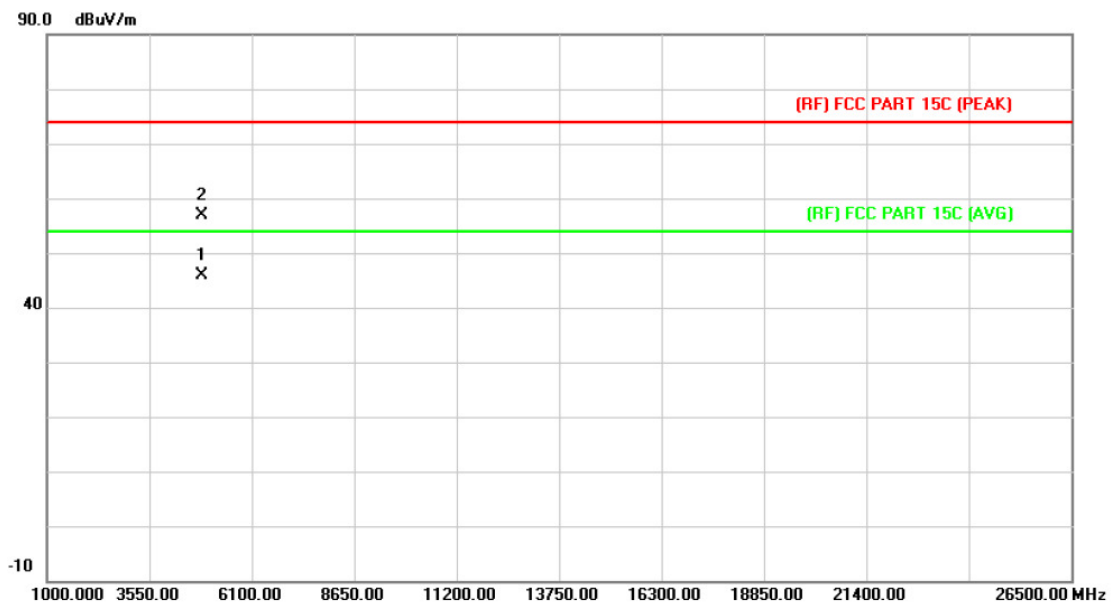

No.	Mk.	Freq. MHz	Reading Level dBuV	Correct Factor dB/m	Measure- ment dBuV/m	Limit dBuV/m	Over dB	Detector
1	*	4873.665	32.11	13.86	45.97	54.00	-8.03	AVG
2		4875.662	43.10	13.87	56.97	74.00	-17.03	peak

Emission Level= Read Level+ Correct Factor

EUT:	WF40A Multi-Room Wi-Fi 2x20W Amplifier with IR Remote	Model:	WF40A
Temperature:	25 °C	Relative Humidity:	55%
Test Voltage:	AC 120V/60 Hz		
Ant. Pol.	Vertical		
Test Mode:	TX G Mode 2437MHz ANT 1		
Remark:	No report for the emission which more than 10 dB below the prescribed limit.		

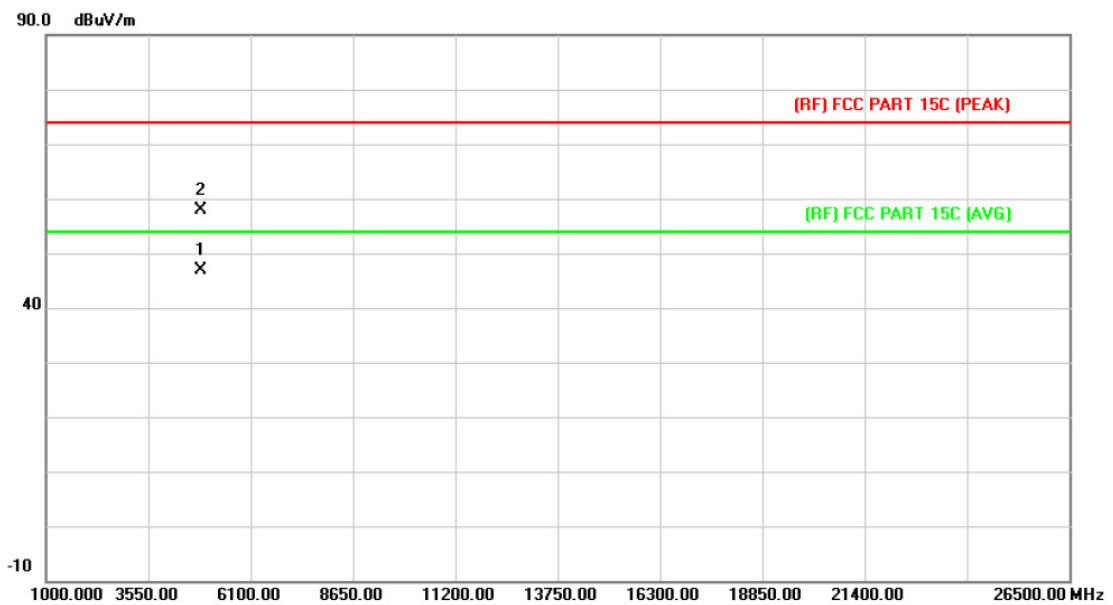

No.	Mk.	Freq. MHz	Reading Level dBuV	Correct Factor dB/m	Measure- ment dBuV/m	Limit dBuV/m	Over dB	Detector
1	*	4873.998	32.93	13.86	46.79	54.00	-7.21	AVG
2		4875.649	44.11	13.87	57.98	74.00	-16.02	peak

Emission Level= Read Level+ Correct Factor

EUT:	WF40A Multi-Room Wi-Fi 2x20W Amplifier with IR Remote	Model:	WF40A
Temperature:	25 °C	Relative Humidity:	55%
Test Voltage:	AC 120V/60 Hz		
Ant. Pol.	Horizontal		
Test Mode:	TX G Mode 2462MHz ANT 1		
Remark:	No report for the emission which more than 10 dB below the prescribed limit.		

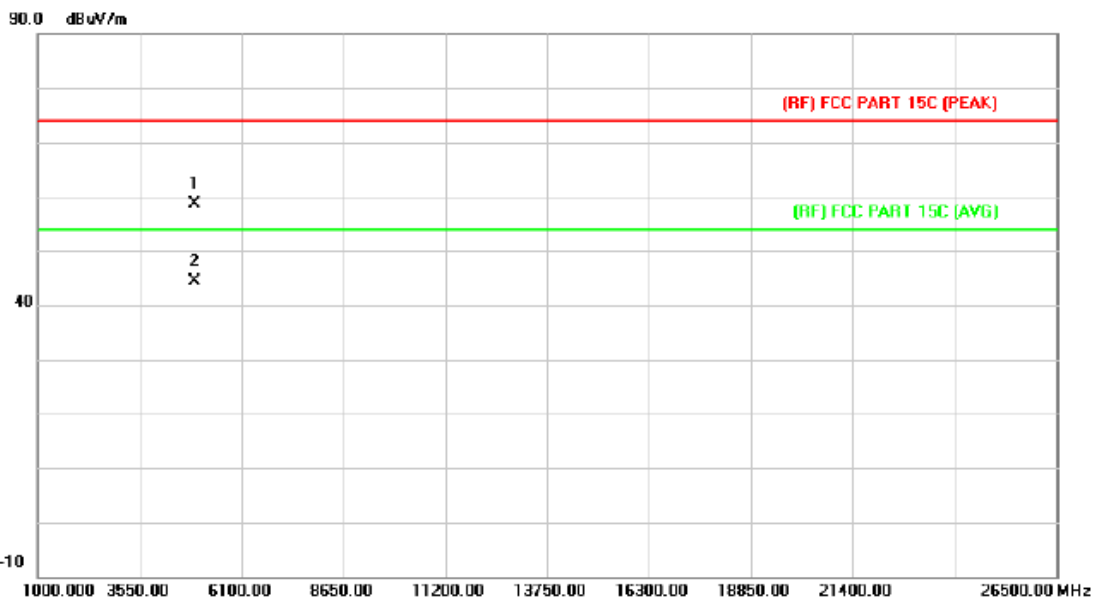

No. Mk.	Freq. MHz	Reading Level dBuV	Correct Factor dB/m	Measure- ment dBuV/m	Limit dBuV/m	Over dB	Detector
1	4923.486	44.40	14.15	58.55	74.00	-15.45	peak
2 *	4924.330	30.23	14.15	44.38	54.00	-9.62	AVG

Emission Level= Read Level+ Correct Factor

EUT:	WF40A Multi-Room Wi-Fi 2x20W Amplifier with IR Remote	Model:	WF40A
Temperature:	25 °C	Relative Humidity:	55%
Test Voltage:	AC 120V/60 Hz		
Ant. Pol.	Vertical		
Test Mode:	TX G Mode 2462MHz ANT 1		
Remark:	No report for the emission which more than 10 dB below the prescribed limit.		

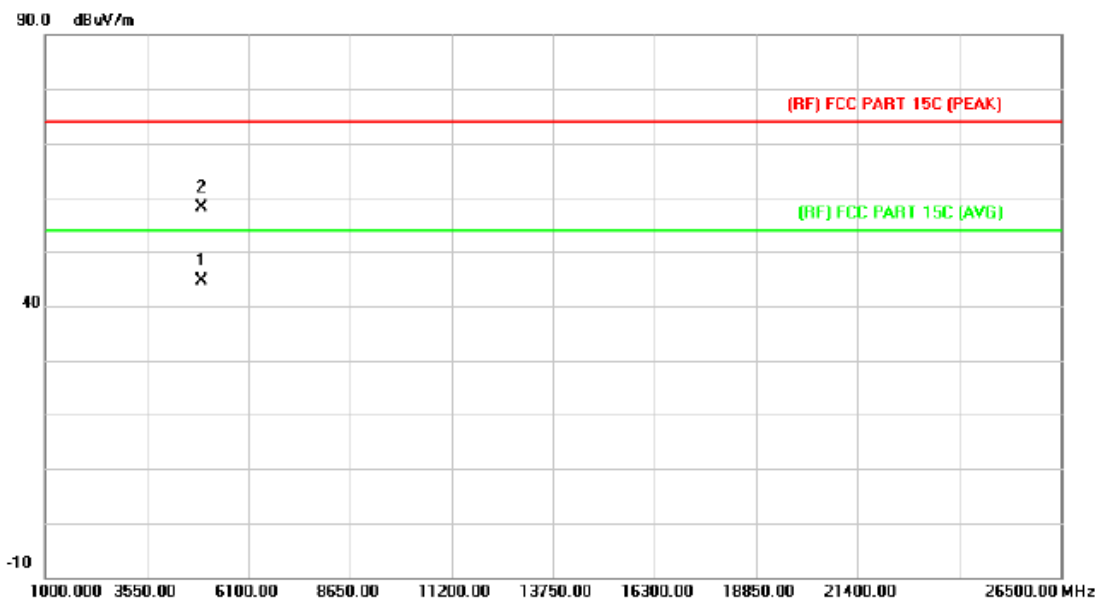

No.	Mk.	Freq.	Reading Level	Correct Factor	Measurement	Limit	Over	Detector
		MHz	dBuV	dB/m	dBuV/m	dBuV/m	dB	
1	*	4924.054	30.50	14.15	44.65	54.00	-9.35	AVG
2		4924.516	44.00	14.15	58.15	74.00	-15.85	peak

Emission Level= Read Level+ Correct Factor

EUT:	WF40A Multi-Room Wi-Fi 2x20W Amplifier with IR Remote	Model:	WF40A
Temperature:	25 °C	Relative Humidity:	55%
Test Voltage:	AC 120V/60 Hz		
Ant. Pol.	Horizontal		
Test Mode:	TX N(HT20) Mode 2412MHz ANT1+2		
Remark:	No report for the emission which more than 10 dB below the prescribed limit.		

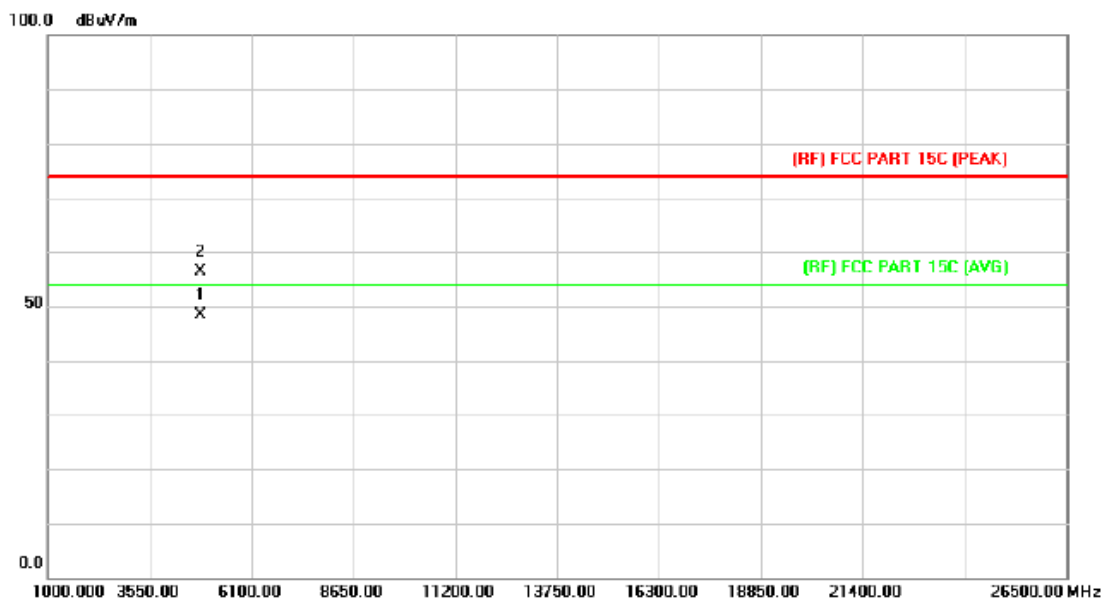

No.	Mk.	Freq. MHz	Reading Level dBuV	Correct Factor dB/m	Measure- ment dBuV/m	Limit dBuV/m	Over dB	Detector
1	*	4823.892	34.92	13.56	48.48	54.00	-5.52	AVG
2		4824.345	42.94	13.56	56.50	74.00	-17.50	peak

Emission Level= Read Level+ Correct Factor

EUT:	WF40A Multi-Room Wi-Fi 2x20W Amplifier with IR Remote	Model:	WF40A
Temperature:	25 °C	Relative Humidity:	55%
Test Voltage:	AC 120V/60 Hz		
Ant. Pol.	Vertical		
Test Mode:	TX N(HT20) Mode 2412MHz ANT 1+2		
Remark:	No report for the emission which more than 10 dB below the prescribed limit.		

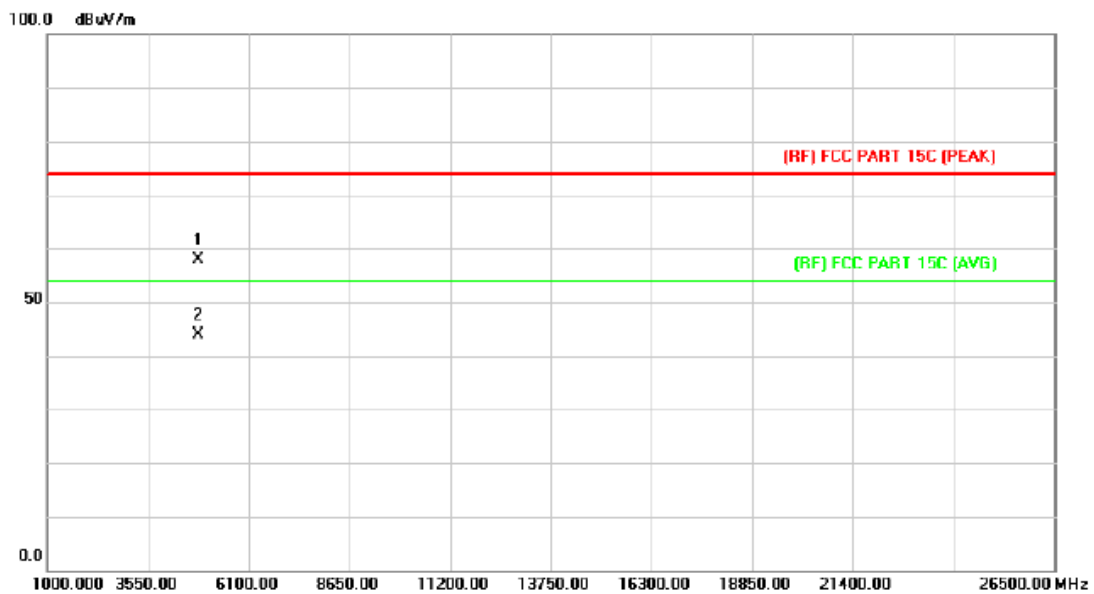

No.	Mk.	Freq. MHz	Reading Level dBuV	Correct Factor dB/m	Measure- ment dBuV/m	Limit dBuV/m	Over dB	Detector
1		4823.154	44.20	13.56	57.76	74.00	-16.24	peak
2	*	4823.922	30.28	13.56	43.84	54.00	-10.16	AVG

Emission Level= Read Level+ Correct Factor

EUT:	WF40A Multi-Room Wi-Fi 2x20W Amplifier with IR Remote	Model:	WF40A
Temperature:	25 °C	Relative Humidity:	55%
Test Voltage:	AC 120V/60 Hz		
Ant. Pol.	Horizontal		
Test Mode:	TX N(HT20) Mode 2437MHz ANT 1+2		
Remark:	No report for the emission which more than 10 dB below the prescribed limit.		

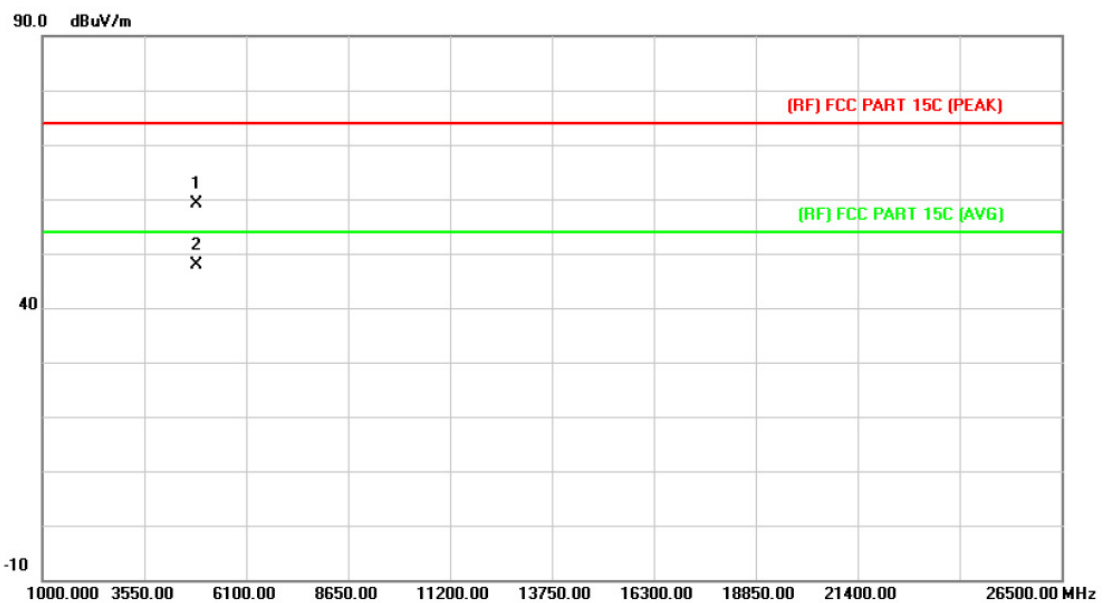

No.	Mk.	Freq. MHz	Reading Level dBuV	Correct Factor dB/m	Measure- ment dBuV/m	Limit dBuV/m	Over dB	Detector
1		4874.009	45.30	13.86	59.16	74.00	-14.84	peak
2	*	4875.495	34.07	13.87	47.94	54.00	-6.06	AVG

Emission Level= Read Level+ Correct Factor

EUT:	WF40A Multi-Room Wi-Fi 2x20W Amplifier with IR Remote	Model:	WF40A
Temperature:	25 °C	Relative Humidity:	55%
Test Voltage:	AC 120V/60 Hz		
Ant. Pol.	Vertical		
Test Mode:	TX N(HT20) Mode 2437MHz ANT 1+2		
Remark:	No report for the emission which more than 10 dB below the prescribed limit.		

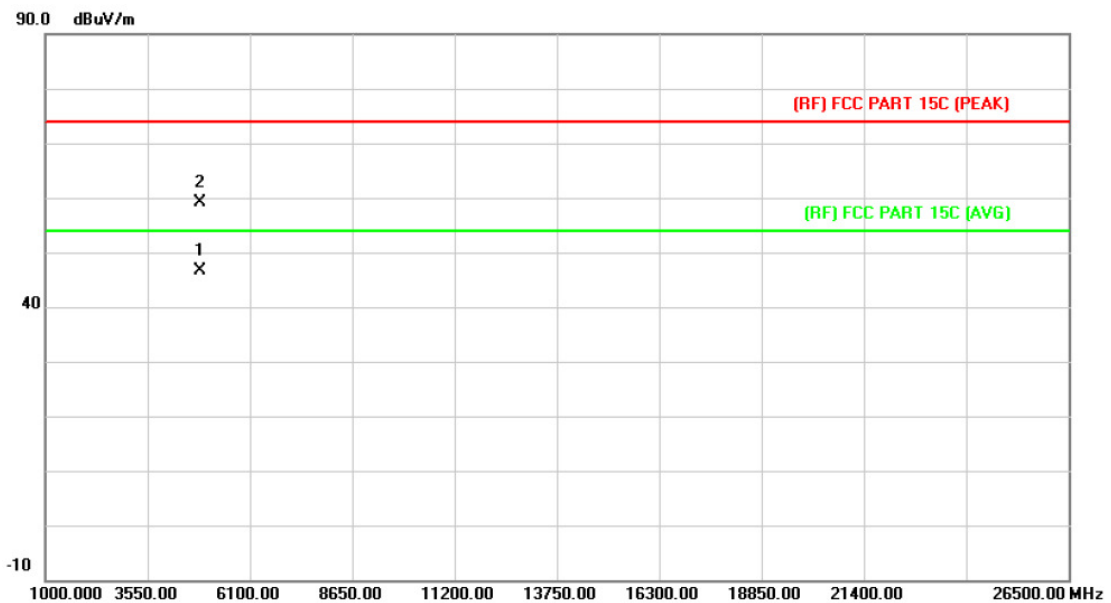

No.	Mk.	Freq. MHz	Reading Level dBuV	Correct Factor dB/m	Measure- ment dBuV/m	Limit dBuV/m	Over dB	Detector
1	*	4873.654	32.73	13.86	46.59	54.00	-7.41	AVG
2		4874.619	45.15	13.86	59.01	74.00	-14.99	peak

Emission Level= Read Level+ Correct Factor

EUT:	WF40A Multi-Room Wi-Fi 2x20W Amplifier with IR Remote	Model:	WF40A
Temperature:	25 °C	Relative Humidity:	55%
Test Voltage:	AC 120V/60 Hz		
Ant. Pol.	Horizontal		
Test Mode:	TX N(HT20) Mode 2462MHz ANT 1+2		
Remark:	No report for the emission which more than 10 dB below the prescribed limit.		

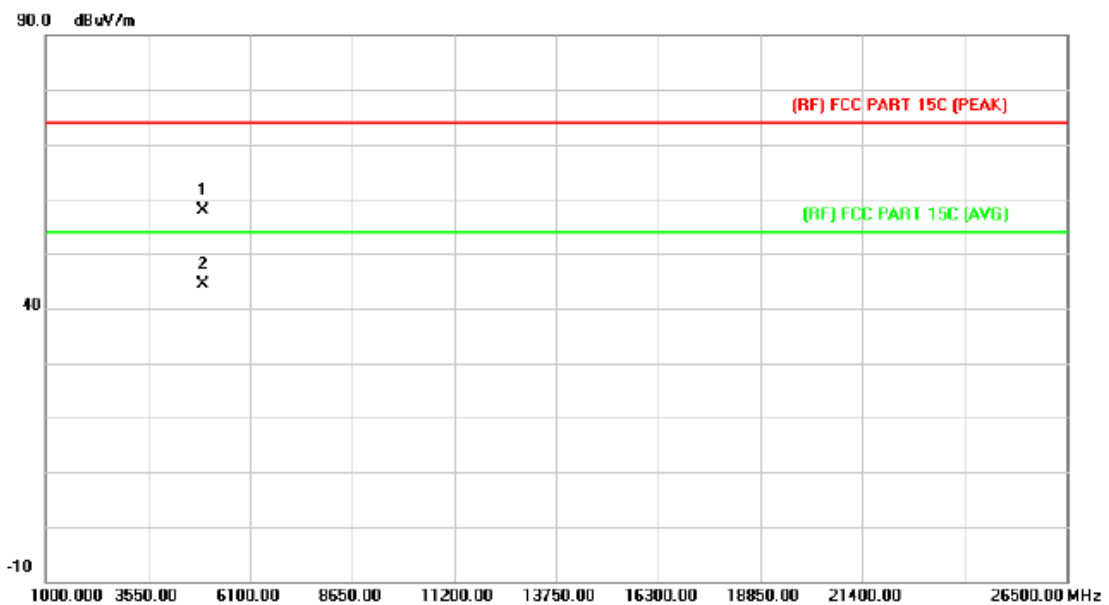

No.	Mk.	Freq. MHz	Reading Level dBuV	Correct Factor dB/m	Measurement dBuV/m	Limit dBuV/m	Over dB	Detector
1		4923.174	43.79	14.15	57.94	74.00	-16.06	peak
2	*	4923.770	30.13	14.15	44.28	54.00	-9.72	AVG

Emission Level= Read Level+ Correct Factor

EUT:	WF40A Multi-Room Wi-Fi 2x20W Amplifier with IR Remote	Model:	WF40A
Temperature:	25 °C	Relative Humidity:	55%
Test Voltage:	AC 120V/60 Hz		
Ant. Pol.	Vertical		
Test Mode:	TX N(HT20) Mode 2462MHz ANT 1+2		
Remark:	No report for the emission which more than 10 dB below the prescribed limit.		

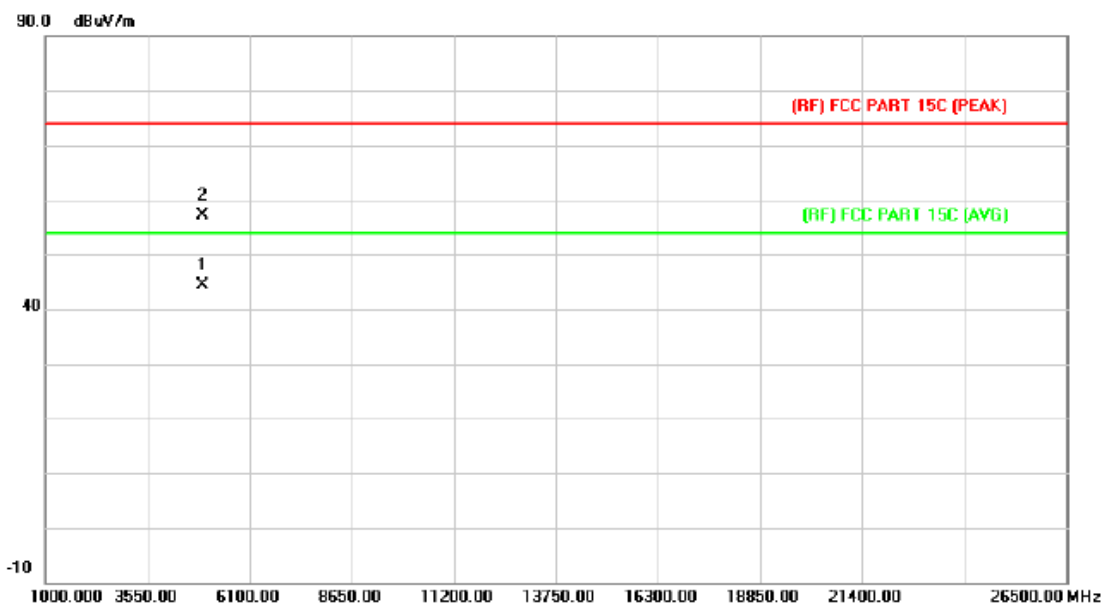

No.	Mk.	Freq. MHz	Reading Level dBuV	Correct Factor dB/m	Measure- ment dBuV/m	Limit dBuV/m	Over dB	Detector
1	*	4924.098	30.30	14.15	44.45	54.00	-9.55	AVG
2		4924.916	42.98	14.15	57.13	74.00	-16.87	peak

Emission Level= Read Level+ Correct Factor

EUT:	WF40A Multi-Room Wi-Fi 2x20W Amplifier with IR Remote	Model:	WF40A
Temperature:	25 °C	Relative Humidity:	55%
Test Voltage:	AC 120V/60 Hz		
Ant. Pol.	Horizontal		
Test Mode:	TX N(HT40) Mode 2422MHz ANT 1+2		
Remark:	No report for the emission which more than 10 dB below the prescribed limit.		

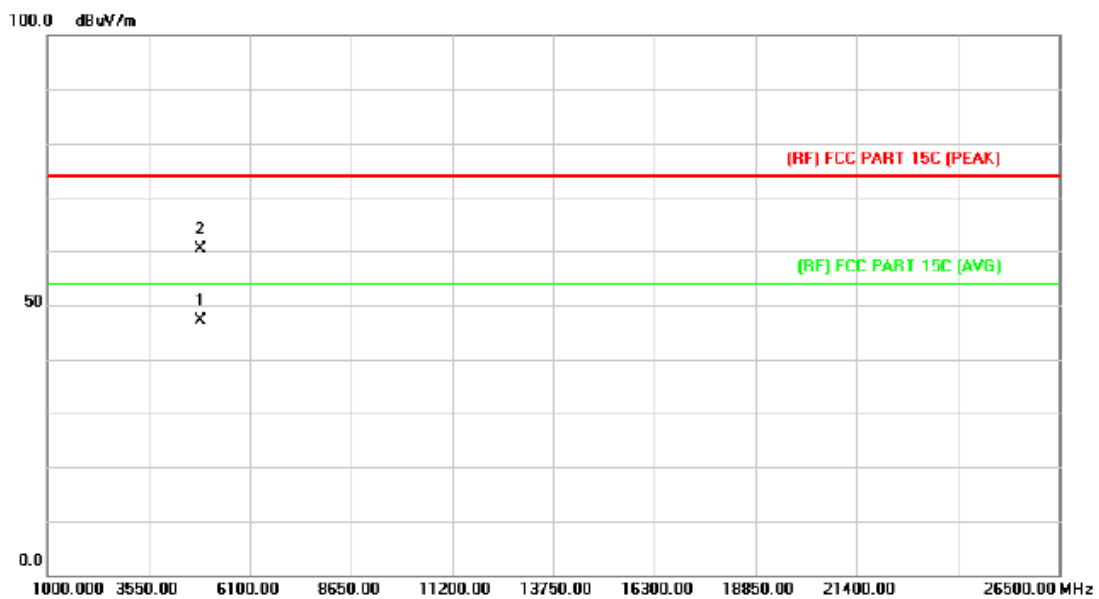

No.	Mk.	Freq. MHz	Reading Level dBuV	Correct Factor dB/m	Measure- ment dBuV/m	Limit dBuV/m	Over dB	Detector
1	*	4843.466	33.45	13.68	47.13	54.00	-6.87	AVG
2		4843.547	46.76	13.68	60.44	74.00	-13.56	peak

Emission Level= Read Level+ Correct Factor

EUT:	WF40A Multi-Room Wi-Fi 2x20W Amplifier with IR Remote	Model:	WF40A
Temperature:	25 °C	Relative Humidity:	55%
Test Voltage:	AC 120V/60 Hz		
Ant. Pol.	Vertical		
Test Mode:	TX N(HT40) Mode 2422MHz ANT 1+2		
Remark:	No report for the emission which more than 10 dB below the prescribed limit.		

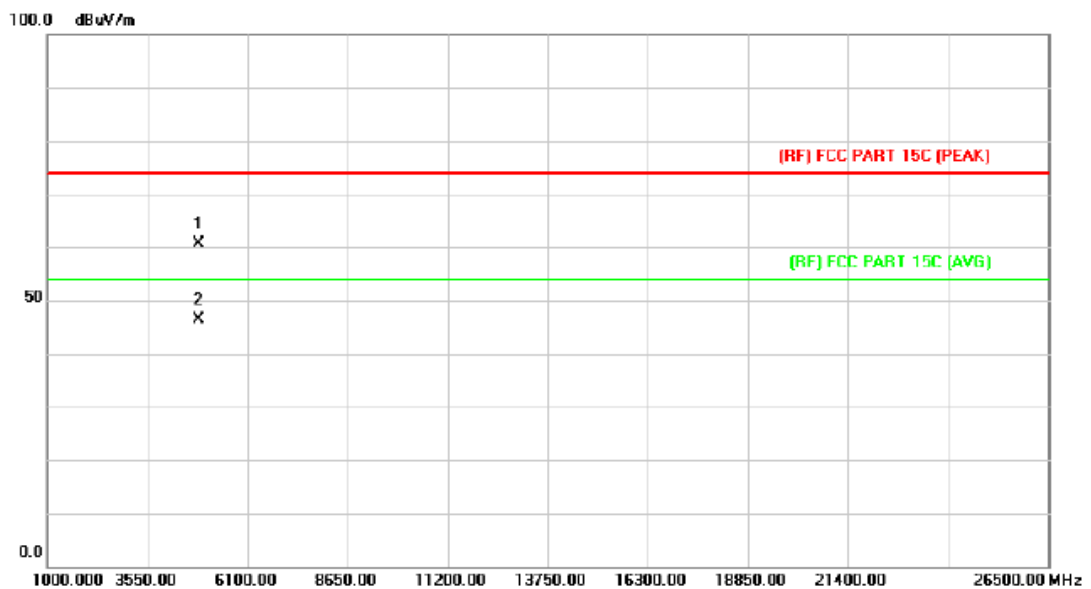

No.	Mk.	Freq. MHz	Reading Level dBuV	Correct Factor dB/m	Measure- ment dBuV/m	Limit dBuV/m	Over dB	Detector
1		4843.256	46.86	13.68	60.54	74.00	-13.46	peak
2	*	4843.751	32.59	13.68	46.27	54.00	-7.73	AVG

Emission Level= Read Level+ Correct Factor

EUT:	WF40A Multi-Room Wi-Fi 2x20W Amplifier with IR Remote	Model:	WF40A
Temperature:	25 °C	Relative Humidity:	55%
Test Voltage:	AC 120V/60 Hz		
Ant. Pol.	Horizontal		
Test Mode:	TX N(HT40) Mode 2437MHz ANT 1+2		
Remark:	No report for the emission which more than 10 dB below the prescribed limit.		

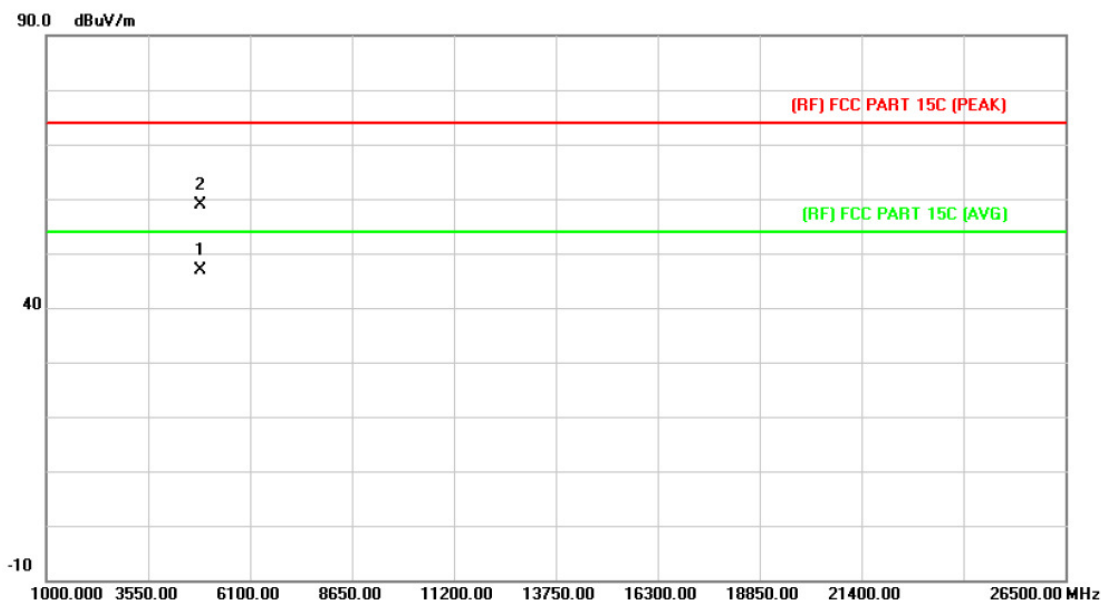

No.	Mk.	Freq. MHz	Reading Level dBuV	Correct Factor dB/m	Measure- ment dBuV/m	Limit dBuV/m	Over dB	Detector
1	*	4873.119	33.12	13.86	46.98	54.00	-7.02	AVG
2		4874.124	45.11	13.86	58.97	74.00	-15.03	peak

Emission Level= Read Level+ Correct Factor

EUT:	WF40A Multi-Room Wi-Fi 2x20W Amplifier with IR Remote	Model:	WF40A
Temperature:	25 °C	Relative Humidity:	55%
Test Voltage:	AC 120V/60 Hz		
Ant. Pol.	Vertical		
Test Mode:	TX N(HT40) Mode 2437MHz ANT 1+2		
Remark:	No report for the emission which more than 10 dB below the prescribed limit.		

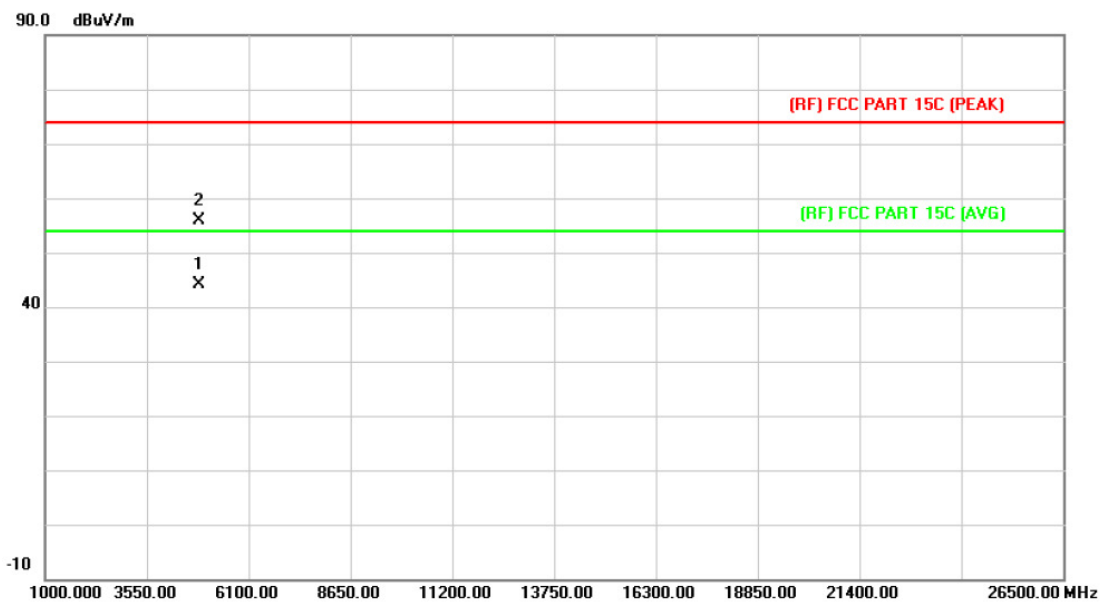

No.	Mk.	Freq. MHz	Reading Level dBuV	Correct Factor dB/m	Measure- ment dBuV/m	Limit dBuV/m	Over dB	Detector
1	*	4873.994	30.30	13.86	44.16	54.00	-9.84	AVG
2		4874.351	42.08	13.86	55.94	74.00	-18.06	peak

Emission Level= Read Level+ Correct Factor

EUT:	WF40A Multi-Room Wi-Fi 2x20W Amplifier with IR Remote	Model:	WF40A
Temperature:	25 °C	Relative Humidity:	55%
Test Voltage:	AC 120V/60 Hz		
Ant. Pol.	Horizontal		
Test Mode:	TX N(HT40) Mode 2452MHz ANT 1+2		
Remark:	No report for the emission which more than 10 dB below the prescribed limit.		

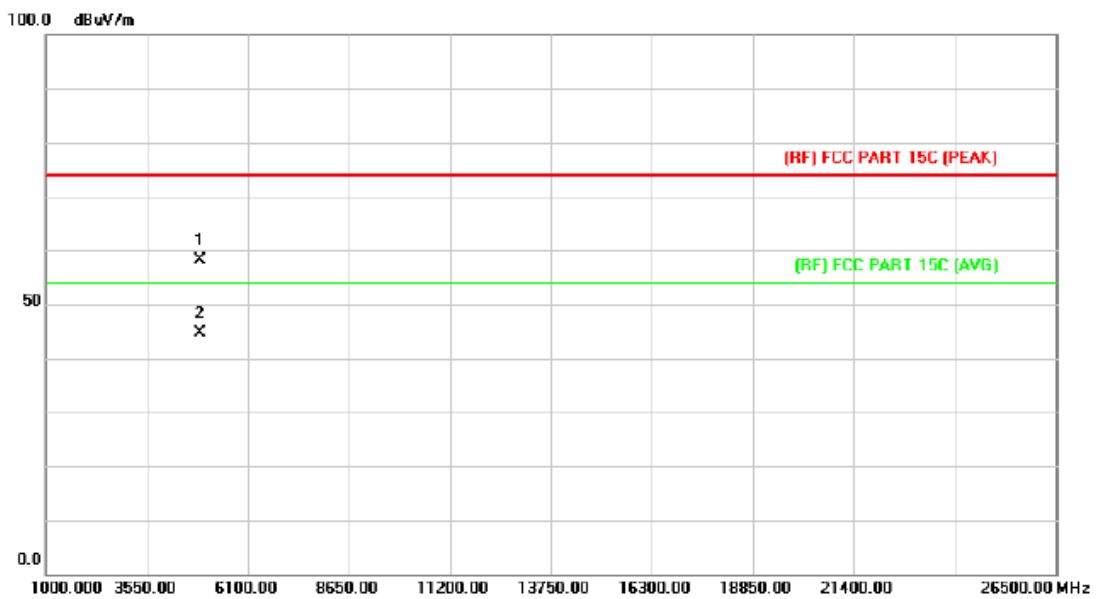

No.	Mk.	Freq. MHz	Reading Level dBuV	Correct Factor dB/m	Measure- ment dBuV/m	Limit dBuV/m	Over dB	Detector
1		4903.628	44.04	14.03	58.07	74.00	-15.93	peak
2	*	4904.585	30.49	14.03	44.52	54.00	-9.48	AVG

Emission Level= Read Level+ Correct Factor

EUT:	WF40A Multi-Room Wi-Fi 2x20W Amplifier with IR Remote	Model:	WF40A
Temperature:	25 °C	Relative Humidity:	55%
Test Voltage:	AC 120V/60 Hz		
Ant. Pol.	Vertical		
Test Mode:	TX N(HT40) Mode 2452MHz ANT 1+2		
Remark:	No report for the emission which more than 10 dB below the prescribed limit.		

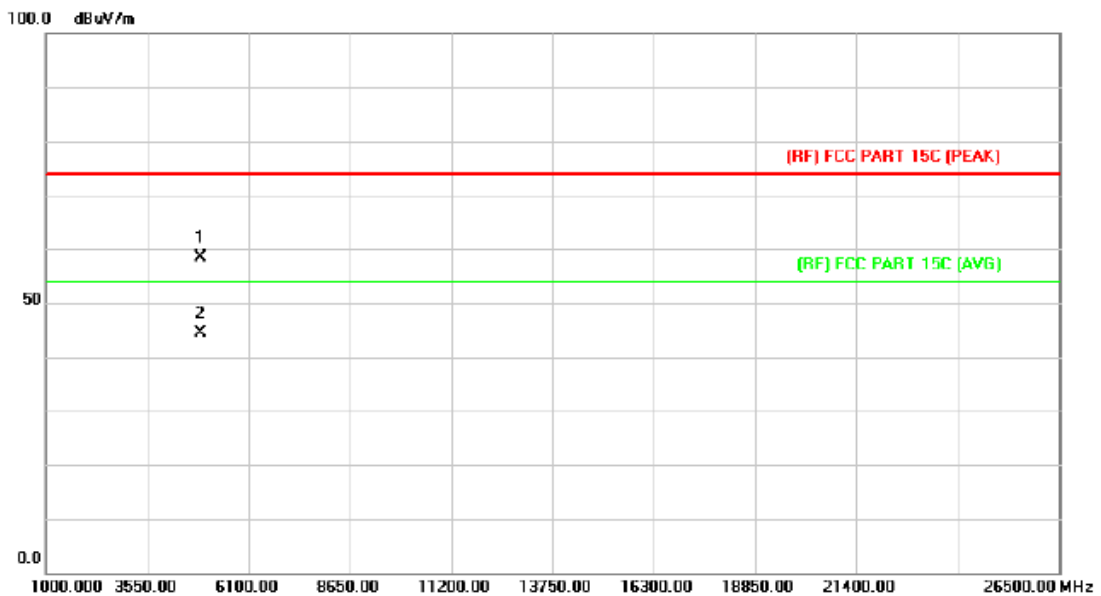

No.	Mk.	Freq. MHz	Reading Level dBuV	Correct Factor dB/m	Measure- ment dBuV/m	Limit dBuV/m	Over dB	Detector
1		4903.505	44.32	14.03	58.35	74.00	-15.65	peak
2	*	4905.095	30.36	14.04	44.40	54.00	-9.60	AVG

Emission Level= Read Level+ Correct Factor

6. Restricted Bands Requirement

6.1 Test Standard and Limit

6.1.1 Test Standard

FCC Part 15.209 FCC Part 15.205

6.1.2 Test Limit

Restricted Frequency Band (MHz)	Class B (dBuV/m)(at 3 M)	
	Peak	Average
2310 ~2390	74	54
2483.5 ~2500	74	54

6.2 Test Setup

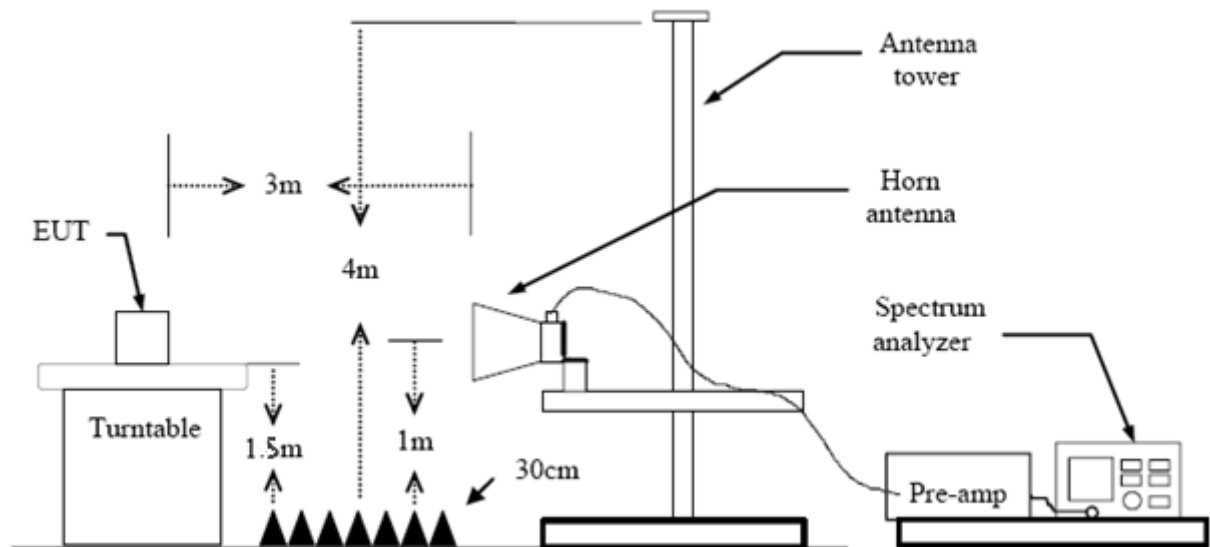

6.3 Test Procedure

- (1) The measuring distance of 3m shall be used for measurements at frequency up to 1GHz and above 1 GHz. The EUT was placed on a rotating 0.8m high above ground, the table was rotated 360 degrees to determine the position of the highest radiation.
- (2) Measurements at frequency above 1GHz. The EUT was placed on a rotating 1.5m high above the ground. RF absorbers covered the ground plane with a minimum area of 3.0m by 3.0m between the EUT and measurement receiver antenna. The RF absorber shall not exceed 30cm in high above the conducting floor. The table was rotated 360 degrees to determine the position of the highest radiation.

- (3) The Test antenna shall vary between 1m and 4m, Both Horizontal and Vertical antenna are set to make measurement.
- (4) The initial step in collecting conducted emission data is a spectrum analyzer peak detector mode pre-scanning the measurement frequency range. Significant peaks are then marked and then Quasi Peak detector mode re-measured.
- (5) If the Peak Mode measured value compliance with and lower than Quasi Peak Mode Limit Bellow 1 GHz, the EUT shall be deemed to meet QP Limits and then no additional QP Mode measurement performed. But the Peak Value and average value both need to comply with applicable limit above 1 GHz.
- (6) Testing frequency range below 1GHz the measuring instrument use VBW=120 kHz with Quasi-peak detection.
- (7) Testing frequency range above 1GHz the measuring instrument use RBW=1 MHz and VBW=3 MHz with Peak Detector for Peak Values, and use RBW=1 MHz and VBW=10 Hz with Peak Detector for Average Values.
- (8) For the actual test configuration, please see the test setup photo.

6.4 EUT Operating Condition

The Equipment Under Test was set to Continual Transmitting in maximum power.

6.5 Test Data

Please see the next page.

(1) Radiation Test

EUT:	WF40A Multi-Room Wi-Fi 2x20W Amplifier with IR Remote	Model:	WF40A
Temperature:	25 °C	Relative Humidity:	55%
Test Voltage:	AC 120V/60 Hz		
Ant. Pol.	Horizontal		
Test Mode:	TX B Mode 2412MHz ANT1		
Remark:	N/A		

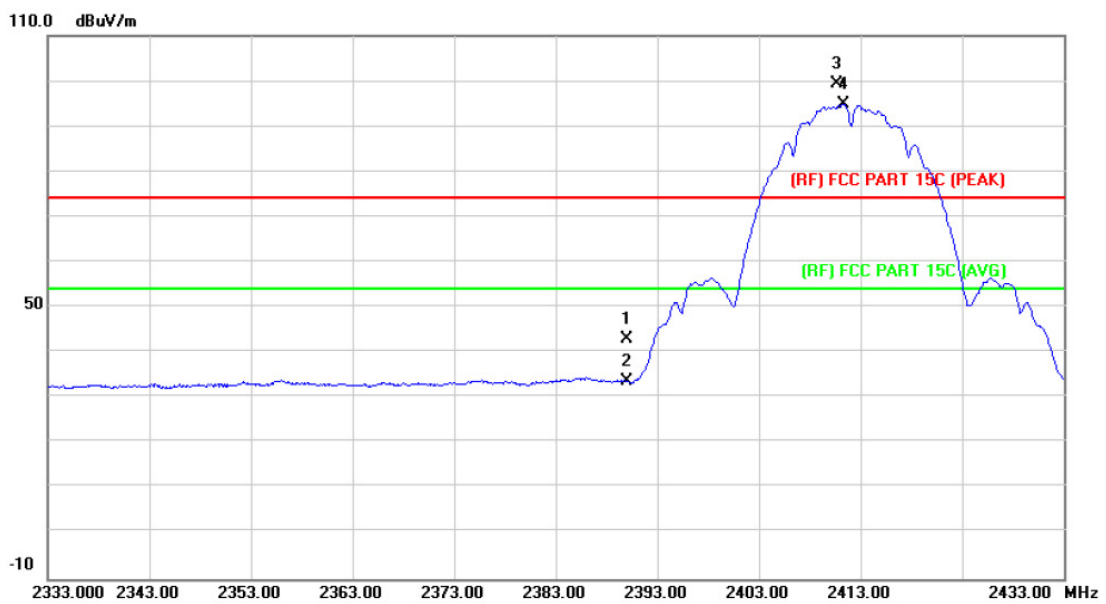

No.	Mk.	Freq. MHz	Reading Level dBuV	Correct Factor dB/m	Measure- ment dBuV/m	Limit dBuV/m	Over dB	Detector
1		2390.000	42.13	0.77	42.90	74.00	-31.10	peak
2		2390.000	32.83	0.77	33.60	54.00	-20.40	AVG
3	X	2410.700	98.55	0.86	99.41	Fundamental Frequency		peak
4	*	2411.300	94.08	0.86	94.94	Fundamental Frequency		AVG

Emission Level= Read Level+ Correct Factor

EUT:	WF40A Multi-Room Wi-Fi 2x20W Amplifier with IR Remote	Model:	WF40A
Temperature:	25 °C	Relative Humidity:	55%
Test Voltage:	AC 120V/60 Hz		
Ant. Pol.	Vertical		
Test Mode:	TX B Mode 2412MHz ANT 1		
Remark:	N/A		

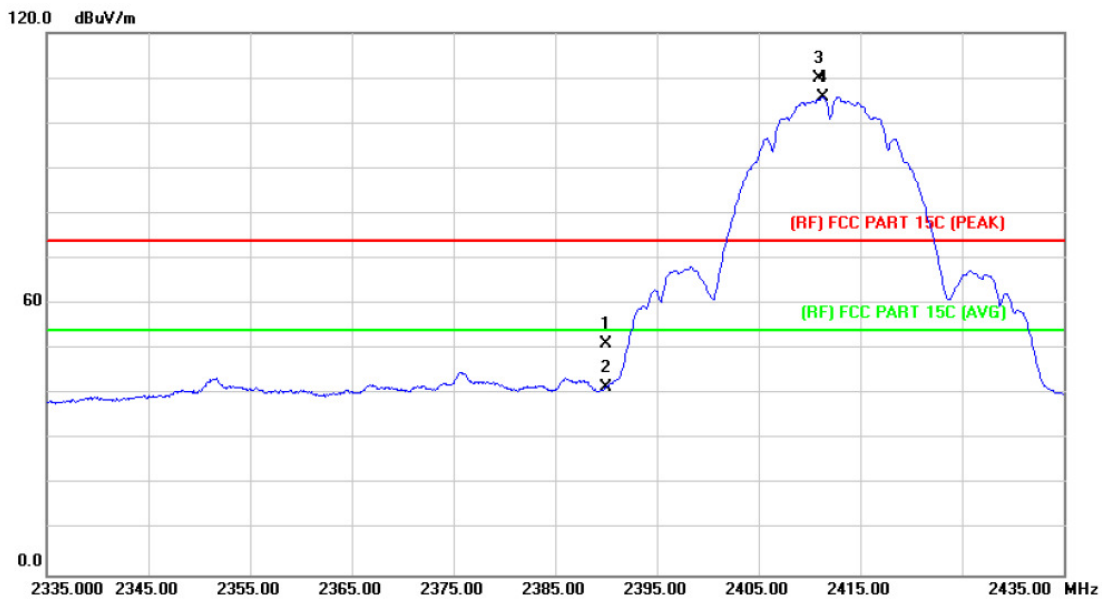

No.	Mk.	Freq. MHz	Reading Level dBuV	Correct Factor dB/m	Measure- ment dBuV/m	Limit dBuV/m	Over dB	Detector
1		2390.000	50.25	0.77	51.02	74.00	-22.98	peak
2		2390.000	40.68	0.77	41.45	54.00	-12.55	AVG
3	X	2410.900	109.07	0.86	109.93	Fundamental Frequency		peak
4	*	2411.300	104.94	0.86	105.80	Fundamental Frequency		AVG

Emission Level= Read Level+ Correct Factor

EUT:	WF40A Multi-Room Wi-Fi 2x20W Amplifier with IR Remote	Model:	WF40A
Temperature:	25 °C	Relative Humidity:	55%
Test Voltage:	AC 120V/60 Hz		
Ant. Pol.	Horizontal		
Test Mode:	TX B Mode 2462MHz ANT 1		
Remark:	N/A		

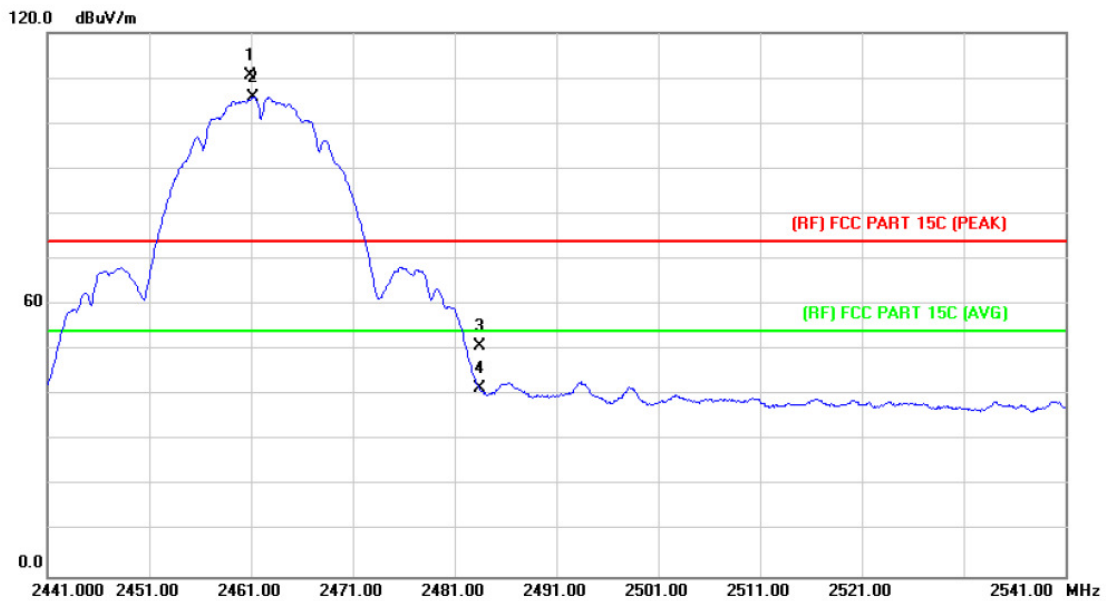

No.	Mk.	Freq. MHz	Reading Level dBuV	Correct Factor dB/m	Measurement dBuV/m	Limit dBuV/m	Over dB	Detector
1	X	2460.900	109.36	1.06	110.42	Fundamental Frequency		peak
2	*	2461.200	104.81	1.07	105.88	Fundamental Frequency		AVG
3		2483.500	49.70	1.17	50.87	74.00	-23.13	peak
4		2483.500	40.41	1.17	41.58	54.00	-12.42	AVG

Emission Level= Read Level+ Correct Factor

EUT:	WF40A Multi-Room Wi-Fi 2x20W Amplifier with IR Remote	Model:	WF40A
Temperature:	25 °C	Relative Humidity:	55%
Test Voltage:	AC 120V/60 Hz		
Ant. Pol.	Vertical		
Test Mode:	TX B Mode 2462MHz ANT 1		
Remark:	N/A		

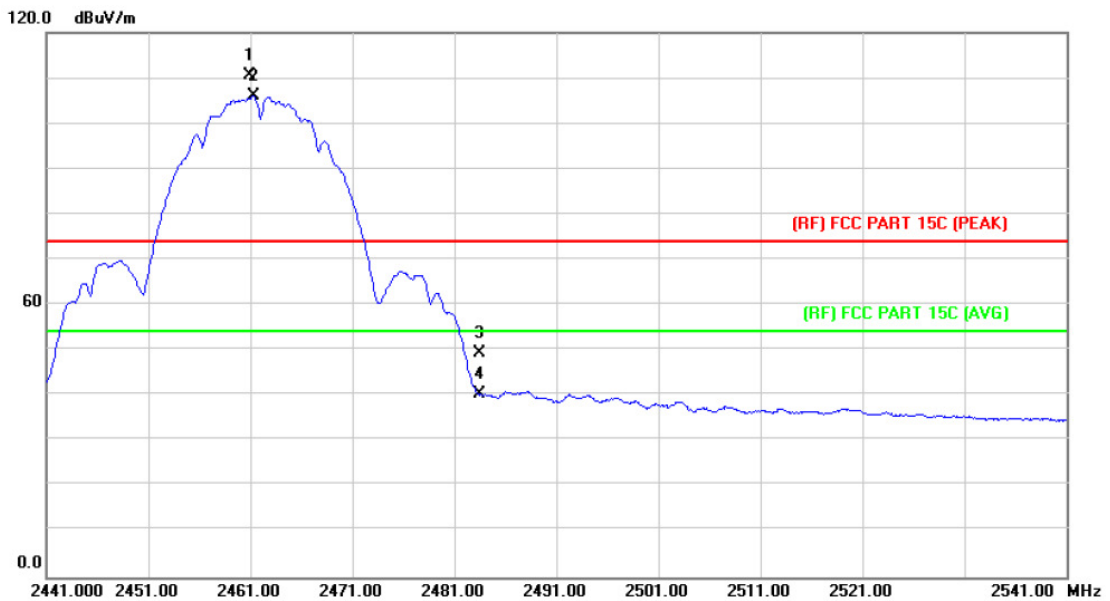

No.	Mk.	Freq. MHz	Reading Level dBuV	Correct Factor dB/m	Measurement dBuV/m	Limit dBuV/m	Over dB	Detector
1	X	2460.900	109.41	1.06	110.47	Fundamental Frequency		peak
2	*	2461.300	104.93	1.07	106.00	Fundamental Frequency		AVG
3		2483.500	48.23	1.17	49.40	74.00	-24.60	peak
4		2483.500	39.04	1.17	40.21	54.00	-13.79	AVG

Emission Level= Read Level+ Correct Factor

EUT:	WF40A Multi-Room Wi-Fi 2x20W Amplifier with IR Remote	Model:	WF40A
Temperature:	25 °C	Relative Humidity:	55%
Test Voltage:	AC 120V/60 Hz		
Ant. Pol.	Horizontal		
Test Mode:	TX G Mode 2412MHz ANT 1		
Remark:	N/A		

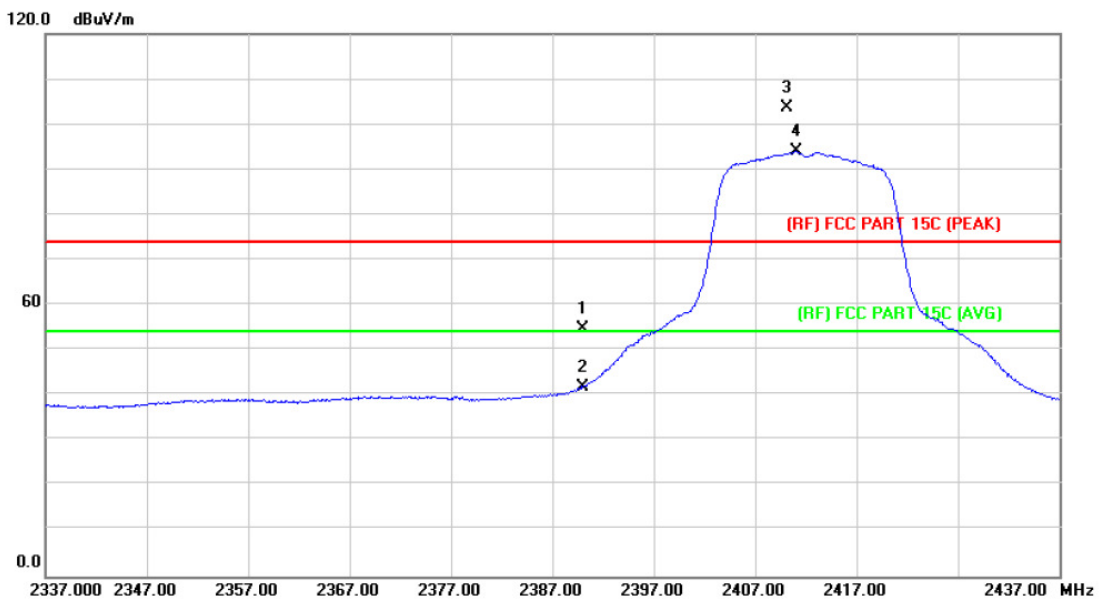

No.	Mk.	Freq. MHz	Reading Level dBuV	Correct Factor dB/m	Measure- ment dBuV/m	Limit dBuV/m	Over dB	Detector
1		2390.000	53.94	0.77	54.71	74.00	-19.29	peak
2		2390.000	41.20	0.77	41.97	54.00	-12.03	AVG
3	X	2410.200	102.87	0.85	103.72	Fundamental Frequency		peak
4	*	2411.100	93.06	0.86	93.92	Fundamental Frequency		AVG

Emission Level= Read Level+ Correct Factor

EUT:	WF40A Multi-Room Wi-Fi 2x20W Amplifier with IR Remote	Model:	WF40A
Temperature:	25 °C	Relative Humidity:	55%
Test Voltage:	AC 120V/60 Hz		
Ant. Pol.	Vertical		
Test Mode:	TX G Mode 2412MHz ANT 1		
Remark:	N/A		

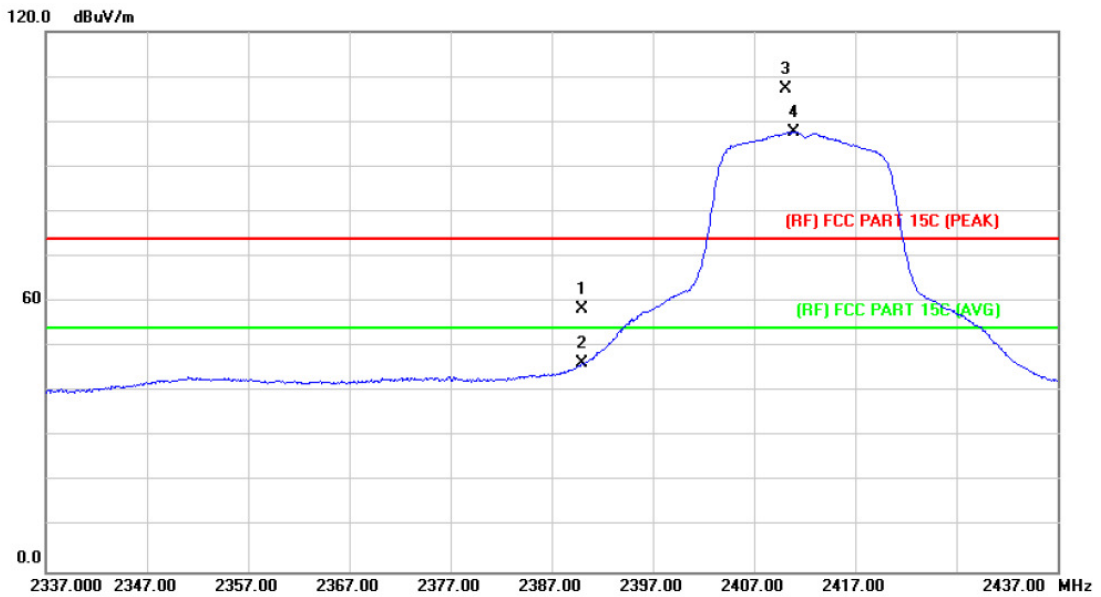

No.	Mk.	Freq. MHz	Reading Level dBuV	Correct Factor dB/m	Measurement dBuV/m	Limit dBuV/m	Over dB	Detector
1		2390.000	57.44	0.77	58.21	74.00	-15.79	peak
2		2390.000	45.50	0.77	46.27	54.00	-7.73	AVG
3	X	2410.100	106.30	0.85	107.15	Fundamental Frequency		peak
4	*	2410.900	96.93	0.86	97.79	Fundamental Frequency		AVG

Emission Level= Read Level+ Correct Factor

EUT:	WF40A Multi-Room Wi-Fi 2x20W Amplifier with IR Remote	Model:	WF40A
Temperature:	25 °C	Relative Humidity:	55%
Test Voltage:	AC 120V/60 Hz		
Ant. Pol.	Horizontal		
Test Mode:	TX G Mode 2462MHz ANT 1		
Remark:	N/A		

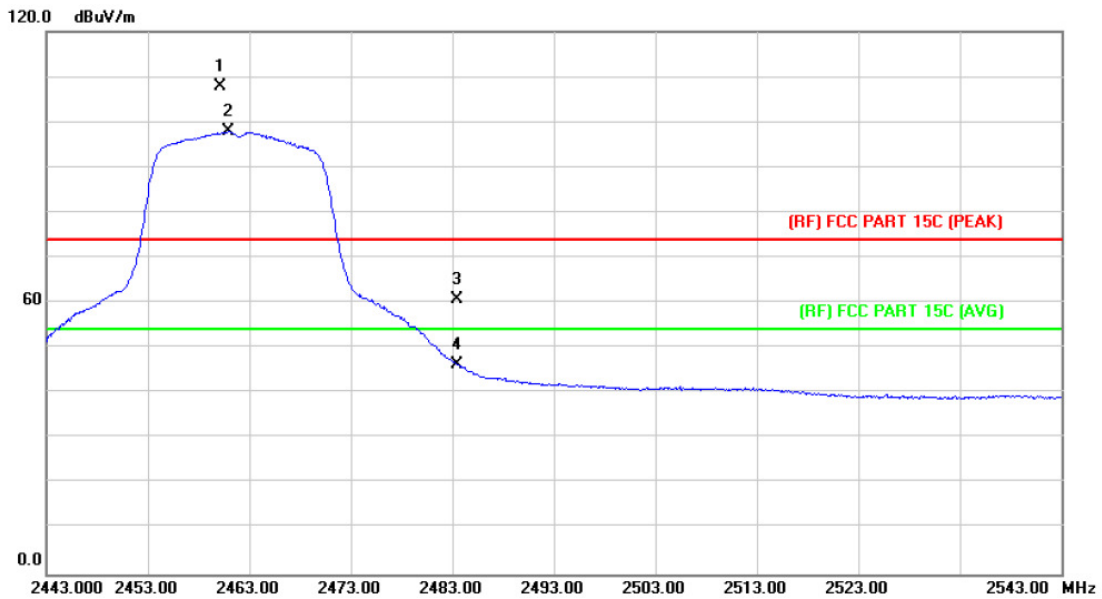

No.	Mk.	Freq. MHz	Reading Level dBuV	Correct Factor dB/m	Measure- ment dBuV/m	Limit dBuV/m	Over dB	Detector
1	X	2460.200	106.88	1.06	107.94	Fundamental Frequency		peak
2	*	2460.900	96.82	1.06	97.88	Fundamental Frequency		AVG
3		2483.500	59.65	1.17	60.82	74.00	-13.18	peak
4		2483.500	45.28	1.17	46.45	54.00	-7.55	AVG

Emission Level= Read Level+ Correct Factor

EUT:	WF40A Multi-Room Wi-Fi 2x20W Amplifier with IR Remote	Model:	WF40A
Temperature:	25 °C	Relative Humidity:	55%
Test Voltage:	AC 120V/60 Hz		
Ant. Pol.	Vertical		
Test Mode:	TX G Mode 2462MHz ANT 1		
Remark:	N/A		

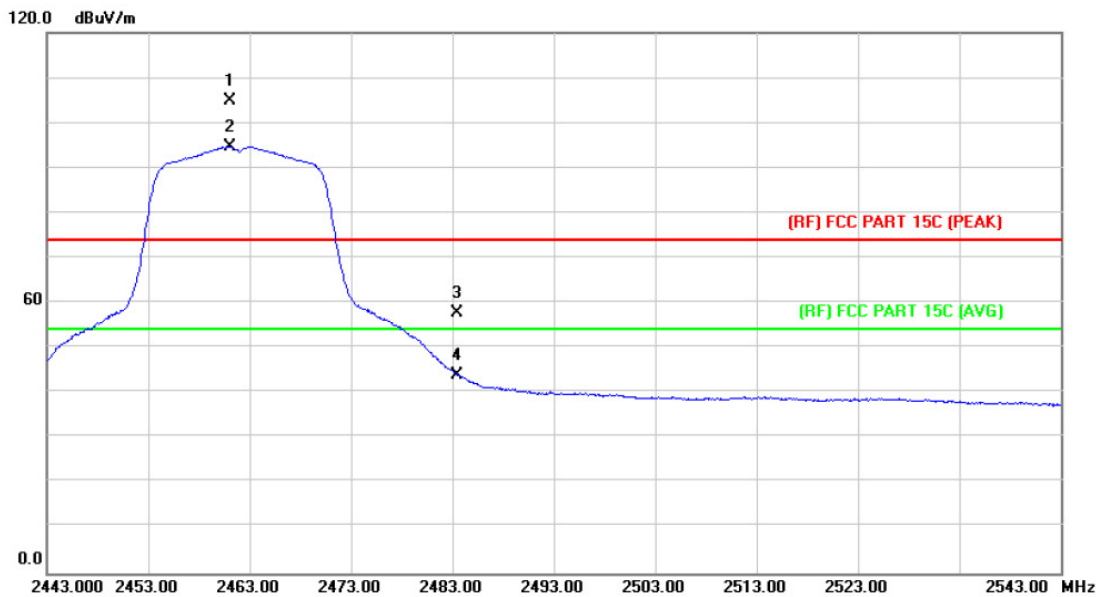

No.	Mk.	Freq. MHz	Reading Level dBuV	Correct Factor dB/m	Measure- ment dBuV/m	Limit dBuV/m	Over dB	Detector
1	X	2461.000	103.92	1.06	104.98	Fundamental Frequency		peak
2	*	2461.000	93.73	1.06	94.79	Fundamental Frequency		AVG
3		2483.500	56.71	1.17	57.88	74.00	-16.12	peak
4		2483.500	42.86	1.17	44.03	54.00	-9.97	AVG

Emission Level= Read Level+ Correct Factor

EUT:	WF40A Multi-Room Wi-Fi 2x20W Amplifier with IR Remote	Model:	WF40A
Temperature:	25 °C	Relative Humidity:	55%
Test Voltage:	AC 120V/60 Hz		
Ant. Pol.	Horizontal		
Test Mode:	TX N(HT20) Mode 2412MHz ANT 1+2		
Remark:	N/A		

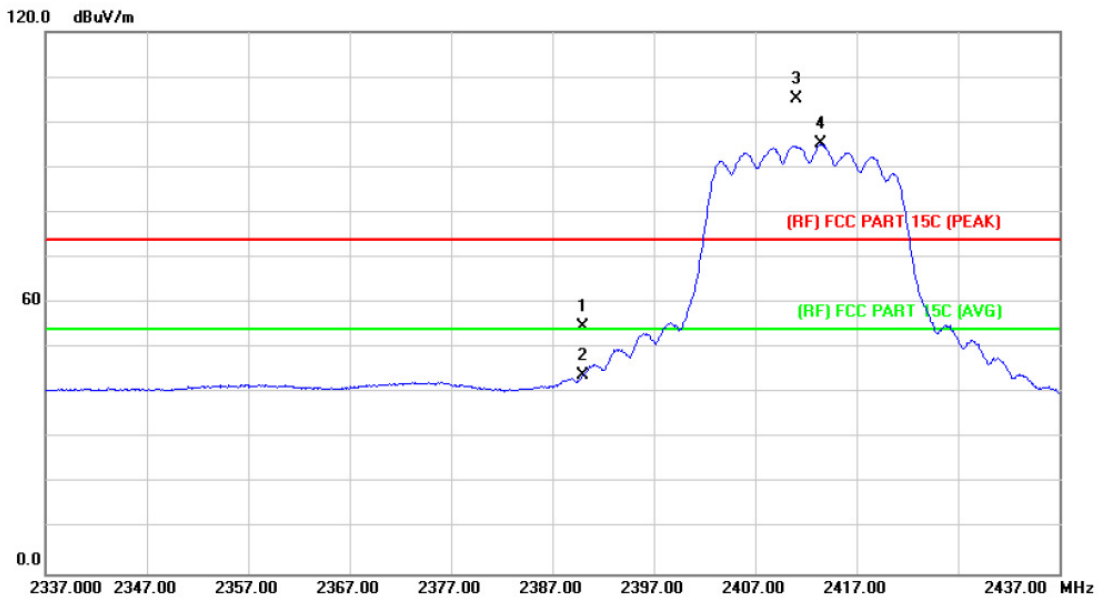

No.	Mk.	Freq. MHz	Reading Level dBuV	Correct Factor dB/m	Measurement dBuV/m	Limit dBuV/m	Over dB	Detector
1		2390.000	53.93	0.77	54.70	74.00	-19.30	peak
2		2390.000	43.11	0.77	43.88	54.00	-10.12	AVG
3	X	2411.100	104.44	0.86	105.30	Fundamental Frequency		peak
4	*	2413.400	94.34	0.86	95.20	Fundamental Frequency		AVG

Emission Level= Read Level+ Correct Factor

EUT:	WF40A Multi-Room Wi-Fi 2x20W Amplifier with IR Remote	Model:	WF40A
Temperature:	25 °C	Relative Humidity:	55%
Test Voltage:	AC 120V/60 Hz		
Ant. Pol.	Vertical		
Test Mode:	TX N(HT20) Mode 2412MHz ANT 1+2		
Remark:	N/A		

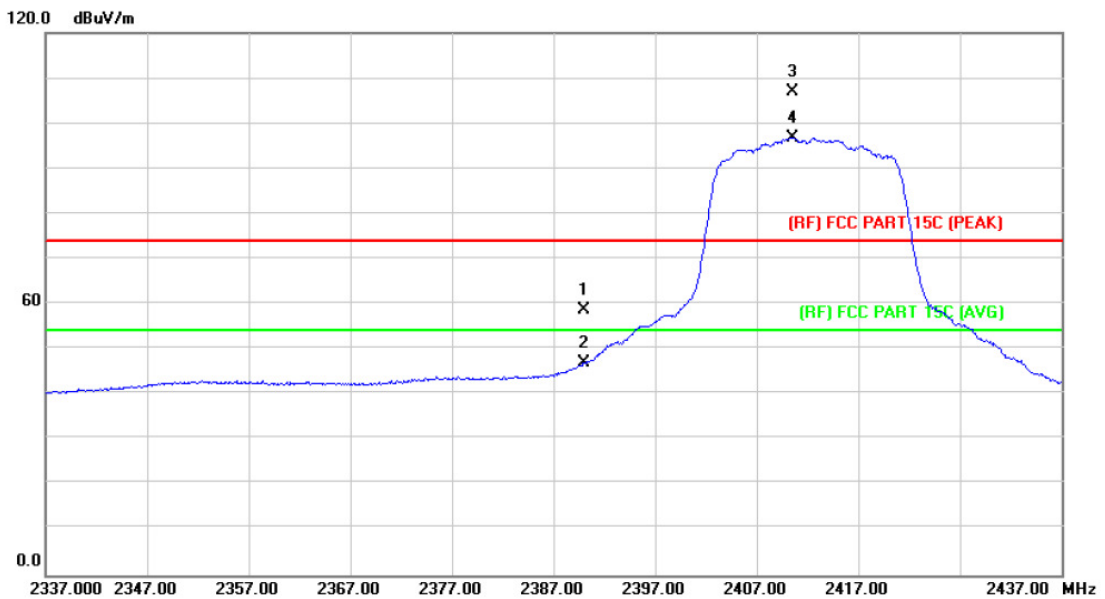

No.	Mk.	Freq. MHz	Reading Level dBuV	Correct Factor dB/m	Measurement dBuV/m	Limit dBuV/m	Over dB	Detector
1		2390.000	57.86	0.77	58.63	74.00	-15.37	peak
2		2390.000	46.17	0.77	46.94	54.00	-7.06	AVG
3	X	2410.600	105.97	0.86	106.83	Fundamental Frequency		peak
4	*	2410.600	96.01	0.86	96.87	Fundamental Frequency		AVG

Emission Level= Read Level+ Correct Factor

EUT:	WF40A Multi-Room Wi-Fi 2x20W Amplifier with IR Remote	Model:	WF40A
Temperature:	25 °C	Relative Humidity:	55%
Test Voltage:	AC 120V/60 Hz		
Ant. Pol.	Horizontal		
Test Mode:	TX N(HT20) Mode 2462MHz ANT 1+2		
Remark:	N/A		

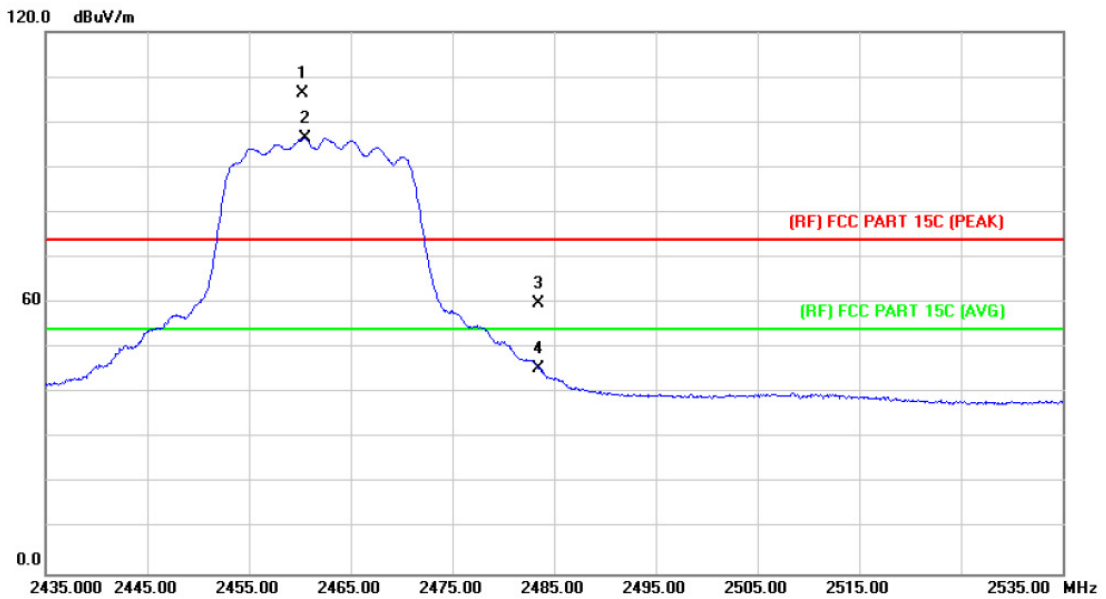

No.	Mk.	Freq. MHz	Reading Level dBuV	Correct Factor dB/m	Measurement dBuV/m	Limit dBuV/m	Over dB	Detector
1	X	2460.300	105.44	1.06	106.50	Fundamental Frequency		peak
2	*	2460.500	95.43	1.06	96.49	Fundamental Frequency		AVG
3		2483.500	58.53	1.17	59.70	74.00	-14.30	peak
4		2483.500	44.40	1.17	45.57	54.00	-8.43	AVG

Emission Level= Read Level+ Correct Factor

EUT:	WF40A Multi-Room Wi-Fi 2x20W Amplifier with IR Remote	Model:	WF40A
Temperature:	25 °C	Relative Humidity:	55%
Test Voltage:	AC 120V/60 Hz		
Ant. Pol.	Vertical		
Test Mode:	TX N(HT20) Mode 2462MHz ANT 1+2		
Remark:	N/A		

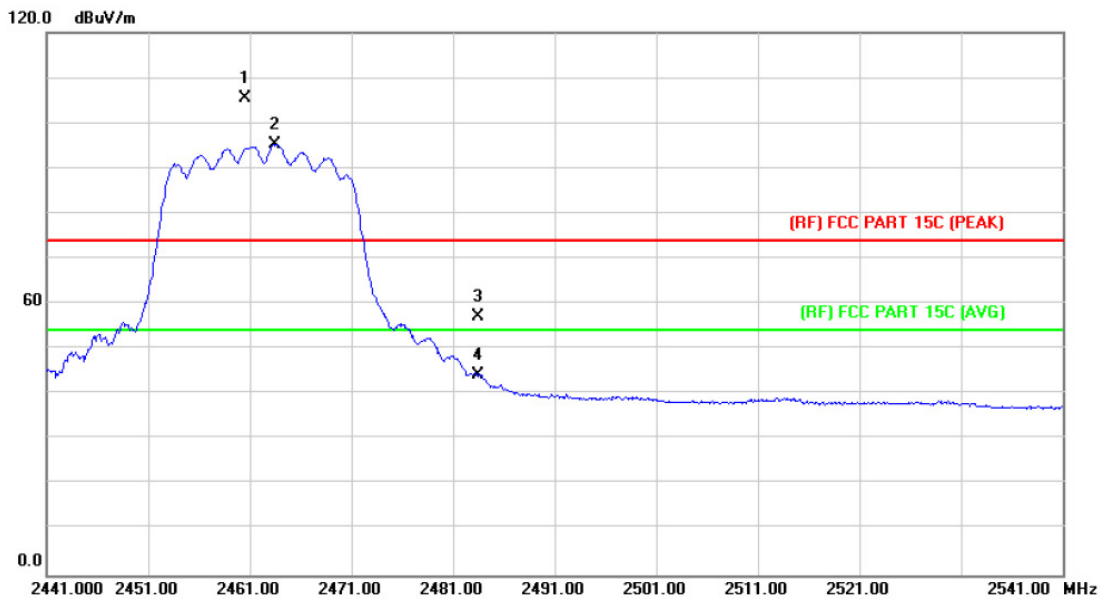

No.	Mk.	Freq. MHz	Reading Level dBuV	Correct Factor dB/m	Measure- ment dBuV/m	Limit dBuV/m	Over dB	Detector
1	X	2460.500	104.48	1.06	105.54	Fundamental Frequency		peak
2	*	2463.400	94.20	1.08	95.28	Fundamental Frequency		AVG
3		2483.500	55.97	1.17	57.14	74.00	-16.86	peak
4		2483.500	42.94	1.17	44.11	54.00	-9.89	AVG

Emission Level= Read Level+ Correct Factor

EUT:	WF40A Multi-Room Wi-Fi 2x20W Amplifier with IR Remote	Model:	WF40A
Temperature:	25 °C	Relative Humidity:	55%
Test Voltage:	AC 120V/60 Hz		
Ant. Pol.	Horizontal		
Test Mode:	TX N(HT40) Mode 2422MHz ANT 1+2		
Remark:	N/A		

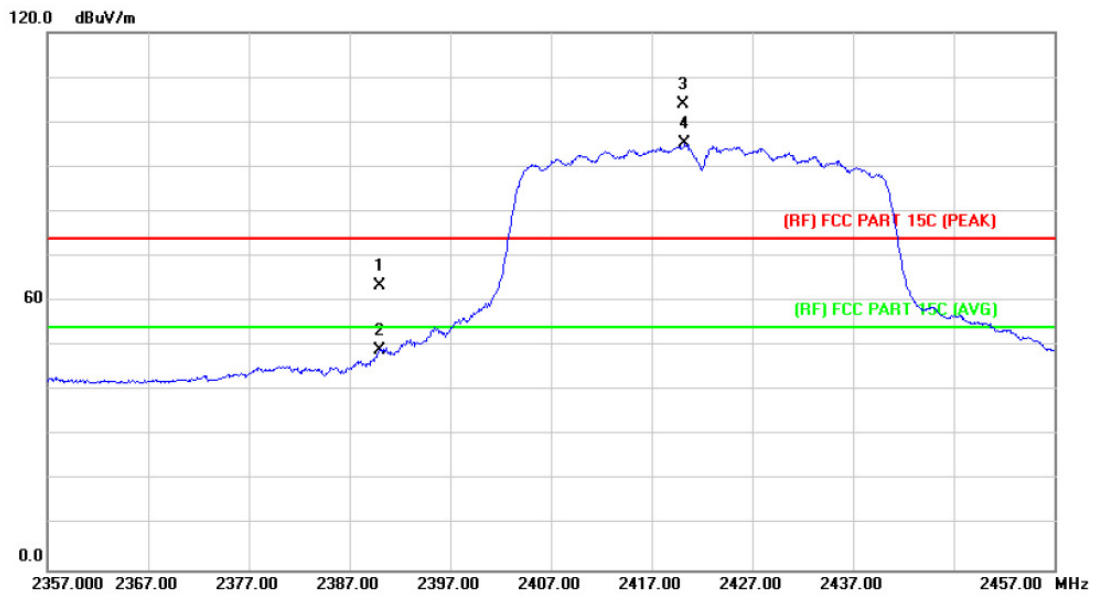

No.	Mk.	Freq. MHz	Reading Level dBuV	Correct Factor dB/m	Measure- ment dBuV/m	Limit dBuV/m	Over dB	Detector
1		2390.000	62.82	0.77	63.59	74.00	-10.41	peak
2		2390.000	48.34	0.77	49.11	54.00	-4.89	AVG
3	X	2420.200	103.17	0.89	104.06	Fundamental Frequency		peak
4	*	2420.300	94.29	0.89	95.18	Fundamental Frequency		AVG

Emission Level= Read Level+ Correct Factor

EUT:	WF40A Multi-Room Wi-Fi 2x20W Amplifier with IR Remote	Model:	WF40A
Temperature:	25 °C	Relative Humidity:	55%
Test Voltage:	AC 120V/60 Hz		
Ant. Pol.	Vertical		
Test Mode:	TX N(HT40) Mode 2422MHz ANT 1+2		
Remark:	N/A		

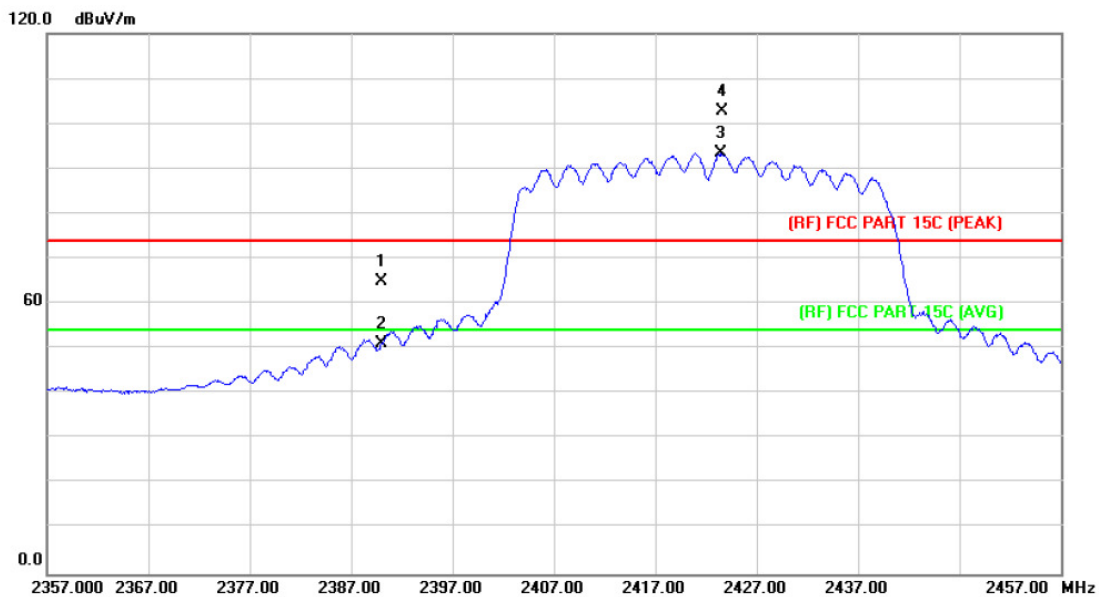

No.	Mk.	Freq. MHz	Reading Level dBuV	Correct Factor dB/m	Measurement dBuV/m	Limit dBuV/m	Over dB	Detector
1		2390.000	64.08	0.77	64.85	74.00	-9.15	peak
2		2390.000	50.44	0.77	51.21	74.00	-22.79	peak
3	X	2423.400	92.45	0.91	93.36	Fundamental Frequency		peak
4	*	2423.600	101.83	0.91	102.74	Fundamental Frequency		peak

Emission Level= Read Level+ Correct Factor

EUT:	WF40A Multi-Room Wi-Fi 2x20W Amplifier with IR Remote	Model:	WF40A
Temperature:	25 °C	Relative Humidity:	55%
Test Voltage:	AC 120V/60 Hz		
Ant. Pol.	Horizontal		
Test Mode:	TX N(HT40) Mode 2452MHz ANT 1+2		
Remark:	N/A		

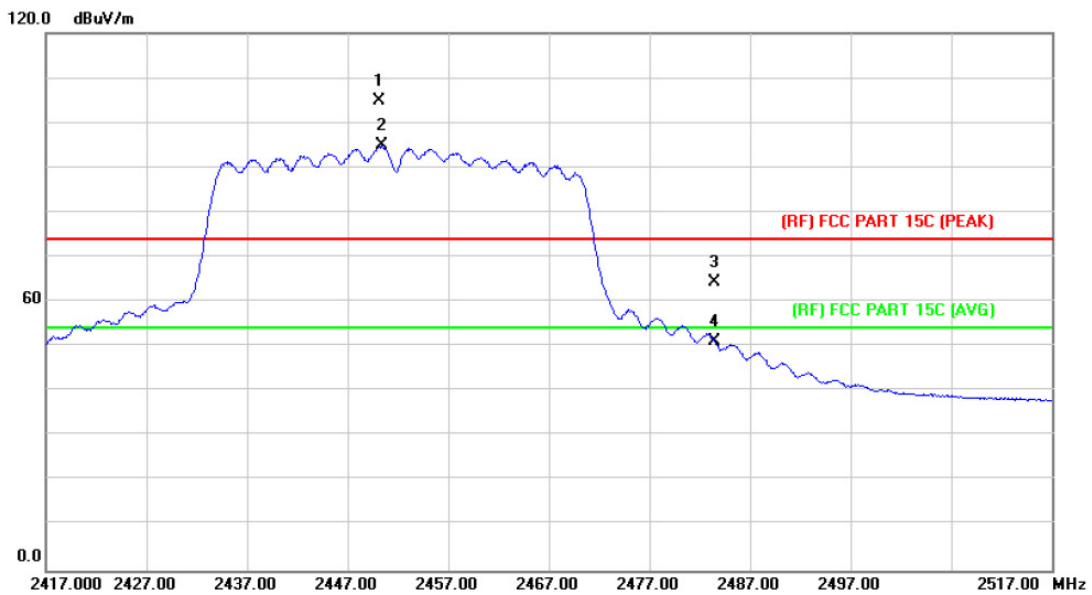

No.	Mk.	Freq. MHz	Reading Level dBuV	Correct Factor dB/m	Measurement dBuV/m	Limit dBuV/m	Over dB	Detector
1	X	2450.200	103.89	1.02	104.91	Fundamental Frequency		peak
2	*	2450.400	93.91	1.02	94.93	Fundamental Frequency		AVG
3		2483.500	63.22	1.17	64.39	74.00	-9.61	peak
4		2483.500	49.87	1.17	51.04	54.00	-2.96	AVG

Emission Level= Read Level+ Correct Factor

EUT:	WF40A Multi-Room Wi-Fi 2x20W Amplifier with IR Remote	Model:	WF40A
Temperature:	25 °C	Relative Humidity:	55%
Test Voltage:	AC 120V/60 Hz		
Ant. Pol.	Vertical		
Test Mode:	TX N(HT40) Mode 2452MHz ANT 1+2		
Remark:	N/A		

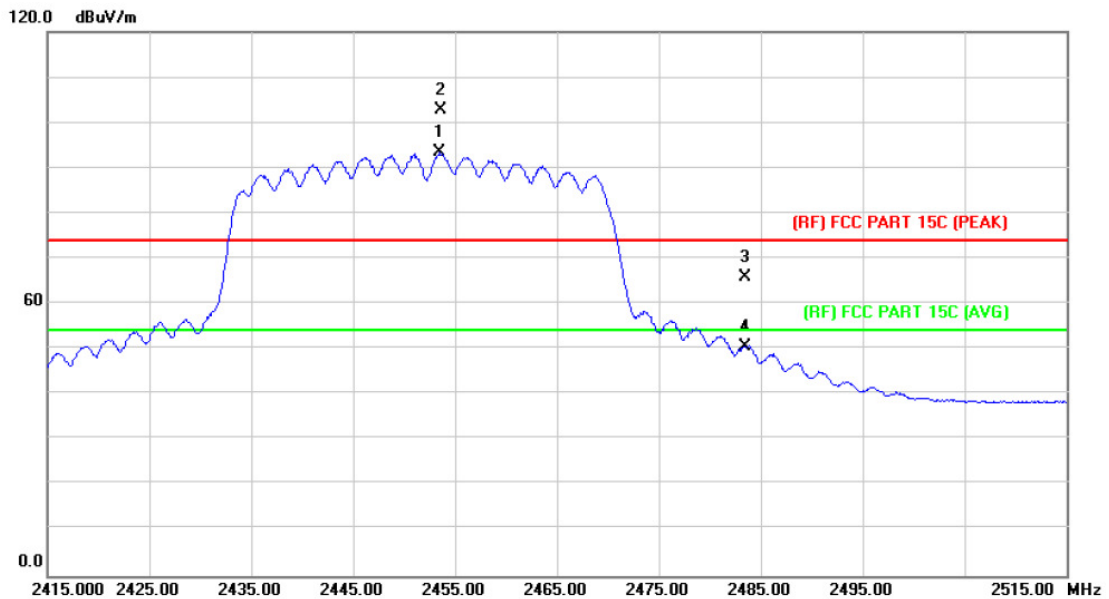

No.	Mk.	Freq. MHz	Reading Level dBuV	Correct Factor dB/m	Measure- ment dBuV/m	Limit dBuV/m	Over dB	Detector
1	*	2453.500	92.33	1.04	93.37	Fundamental Frequency		AVG
2	X	2453.600	101.81	1.04	102.85	Fundamental Frequency		peak
3		2483.500	64.73	1.17	65.90	74.00	-8.10	peak
4		2483.500	49.51	1.17	50.68	54.00	-3.32	AVG

Emission Level= Read Level+ Correct Factor

(2) Conducted Test

EUT:	WF40A Multi-Room Wi-Fi 2x20W Amplifier with IR Remote	Model:	WF40A
Temperature:	25 °C	Relative Humidity:	55%
Test Voltage:	AC 120V/60 Hz		
Test Mode:	TX B Mode 2412MHz / TX B Mode 2462MHz ANT 1		
Remark:	The EUT is programed in continuously transmitting mode		

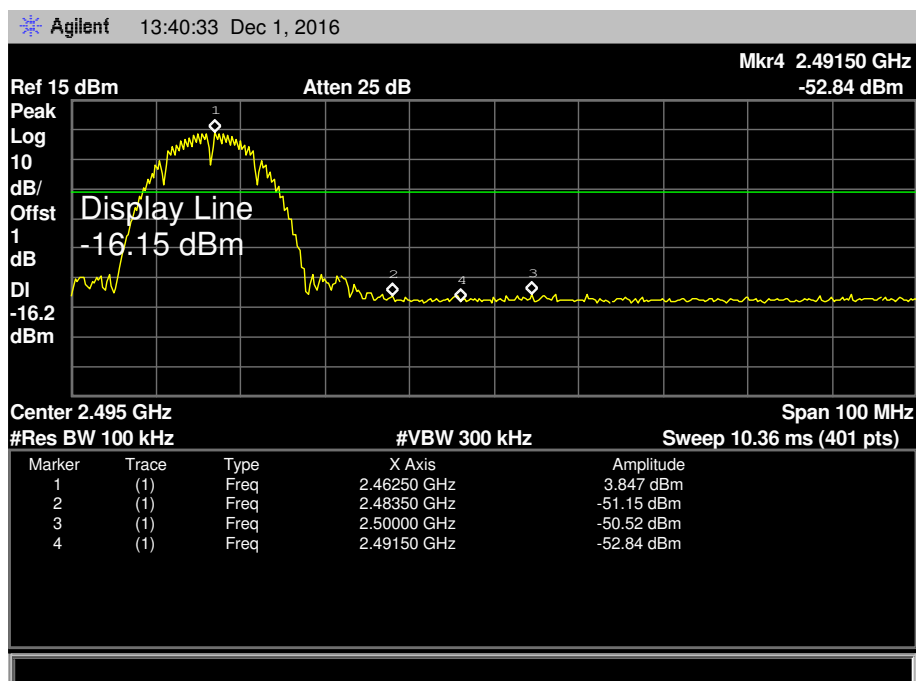
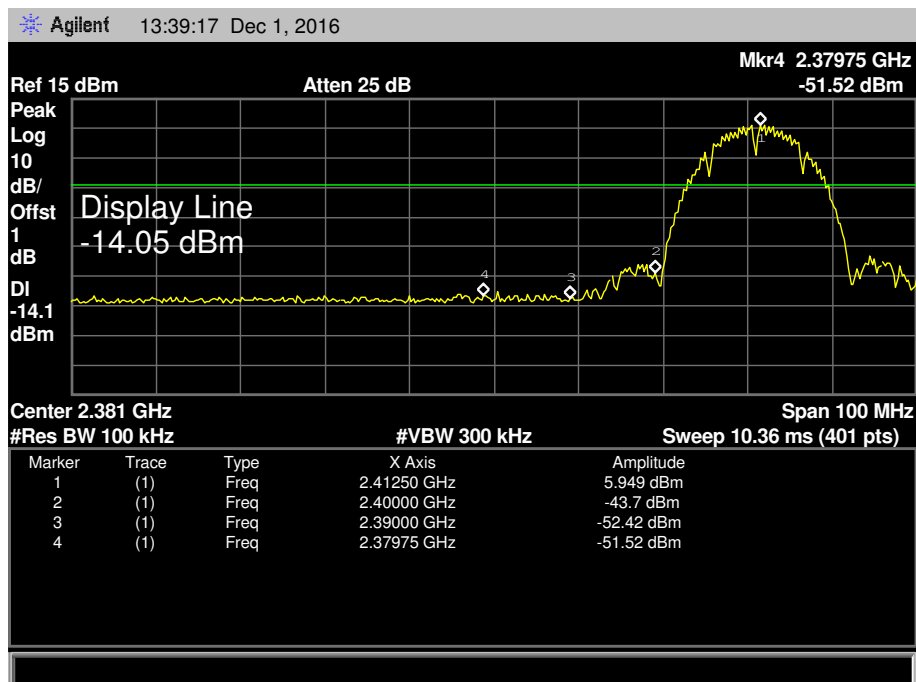

EUT:	WF40A Multi-Room Wi-Fi 2x20W Amplifier with IR Remote	Model:	WF40A
Temperature:	25 °C	Relative Humidity:	55%
Test Voltage:	AC 120V/60 Hz		
Test Mode:	TX G Mode 2412MHz / TX G Mode 2462MHz ANT 1		
Remark:	The EUT is programed in continuously transmitting mode		

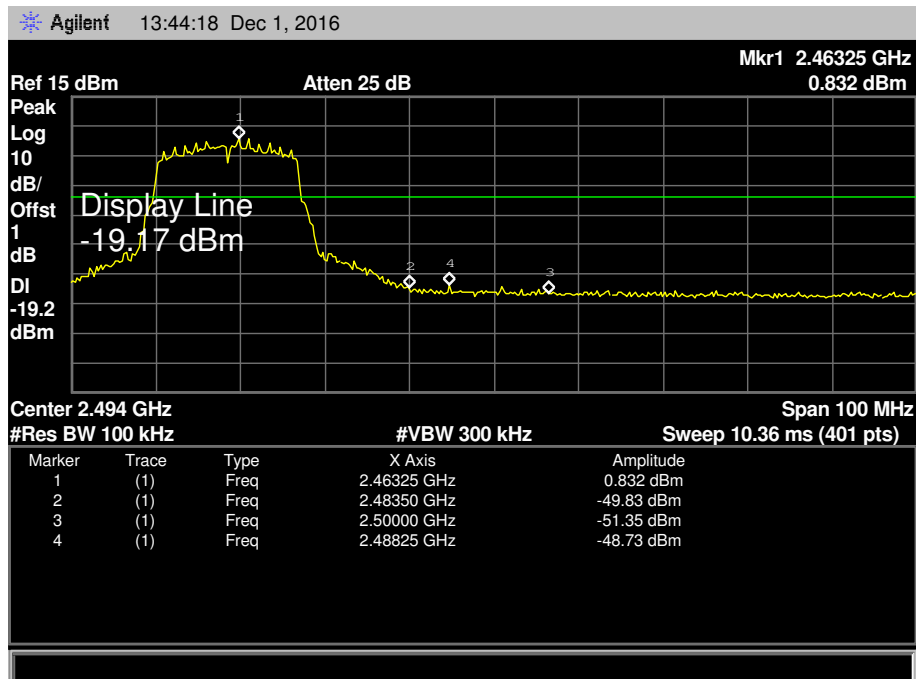
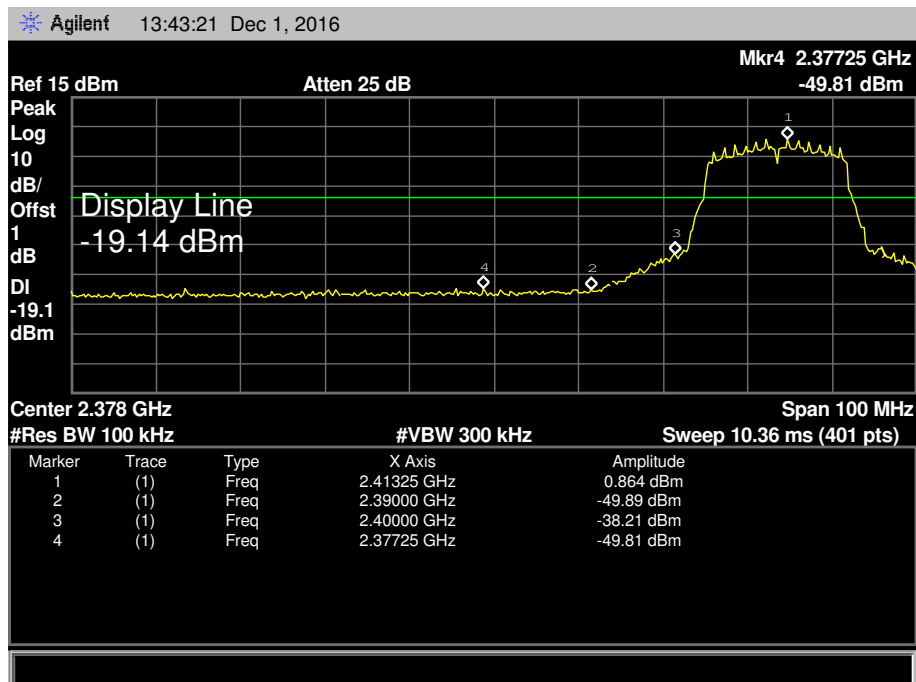

EUT:	WF40A Multi-Room Wi-Fi 2x20W Amplifier with IR Remote	Model:	WF40A
Temperature:	25 °C	Relative Humidity:	55%
Test Voltage:	AC 120V/60 Hz		
Test Mode:	TX N(HT20) Mode 2412MHz / TX N(HT20) Mode 2462MHz ANT 1		
Remark:	The EUT is programed in continuously transmitting mode		

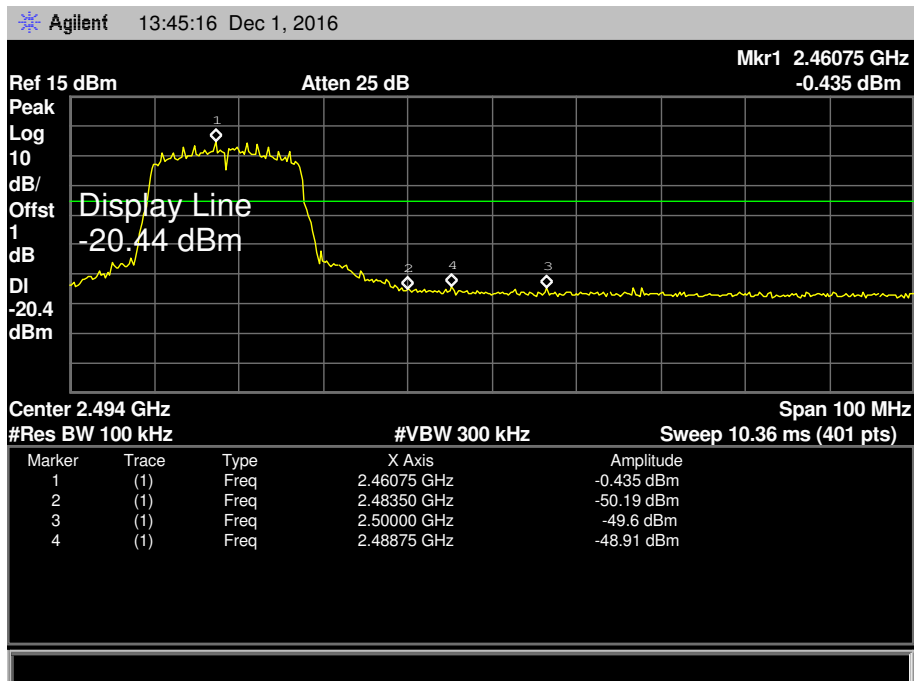
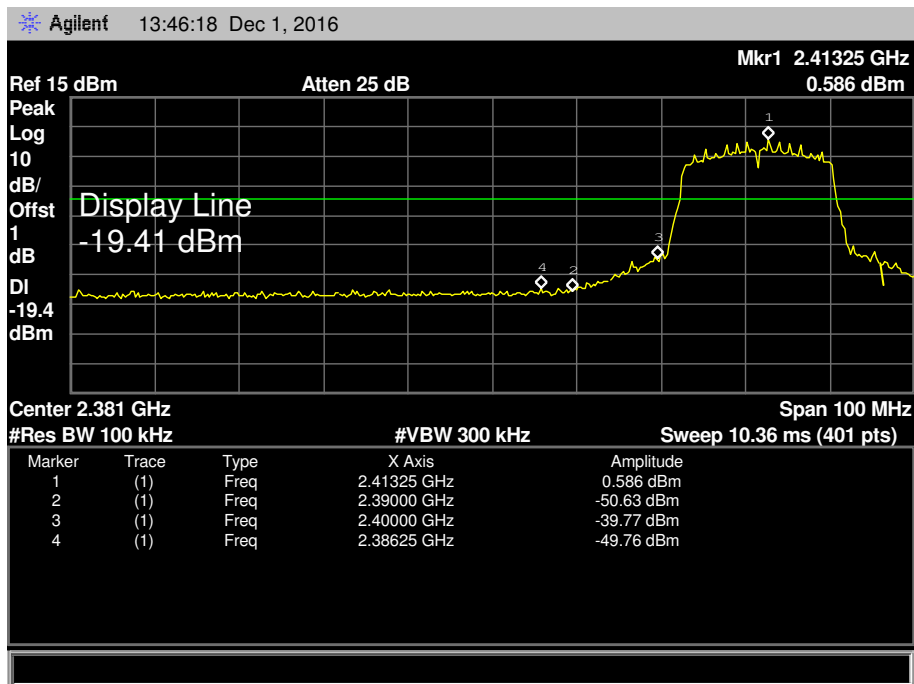

EUT:	WF40A Multi-Room Wi-Fi 2x20W Amplifier with IR Remote	Model:	WF40A
Temperature:	25 °C	Relative Humidity:	55%
Test Voltage:	AC 120V/60 Hz		
Test Mode:	TX N(HT20) Mode 2412MHz / TX N(HT20) Mode 2462MHz ANT 2		
Remark:	The EUT is programed in continuously transmitting mode		

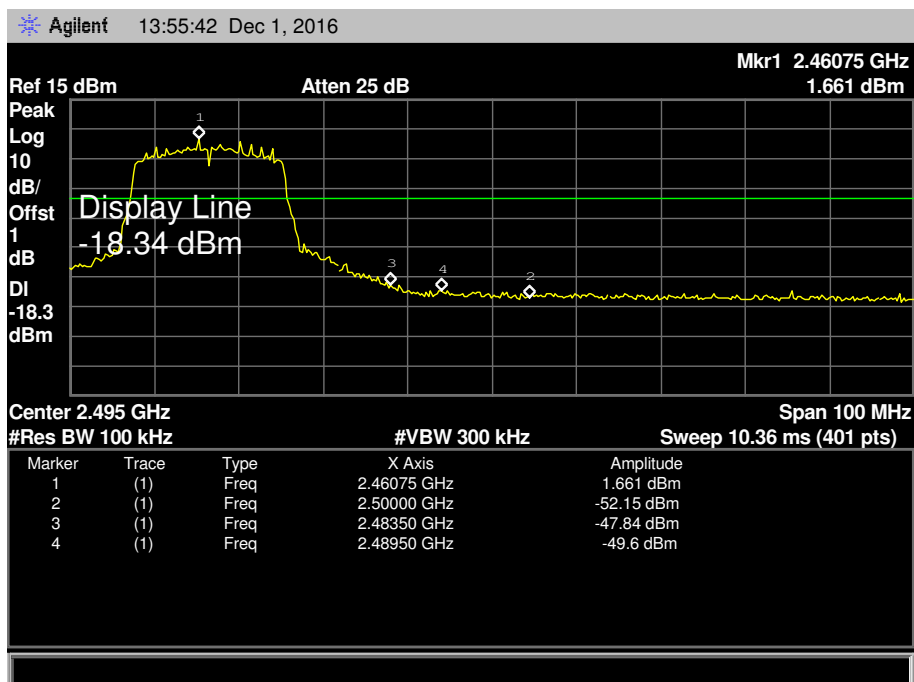
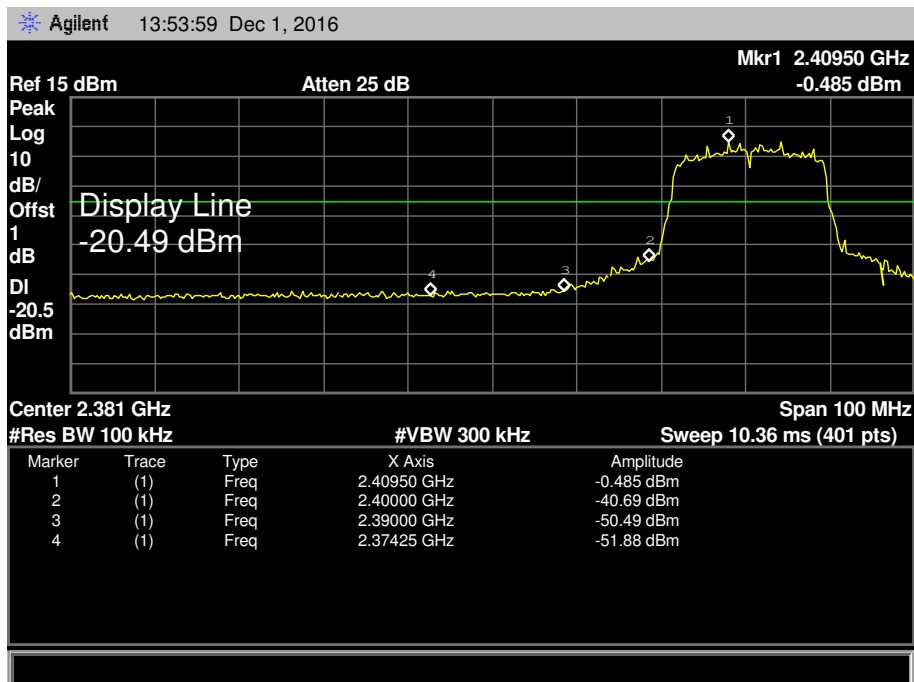

EUT:	WF40A Multi-Room Wi-Fi 2x20W Amplifier with IR Remote	Model:	WF40A
Temperature:	25 °C	Relative Humidity:	55%
Test Voltage:	AC 120V/60 Hz		
Test Mode:	TX N(HT40) Mode 2422MHz / TX N(HT40) Mode 2452MHz ANT 1		
Remark:	The EUT is programed in continuously transmitting mode		

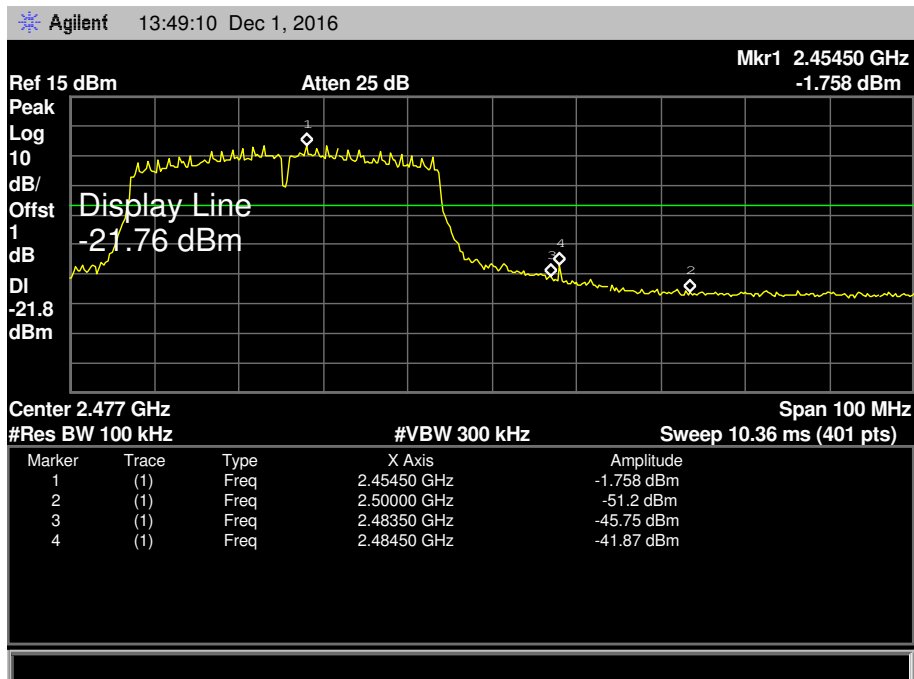
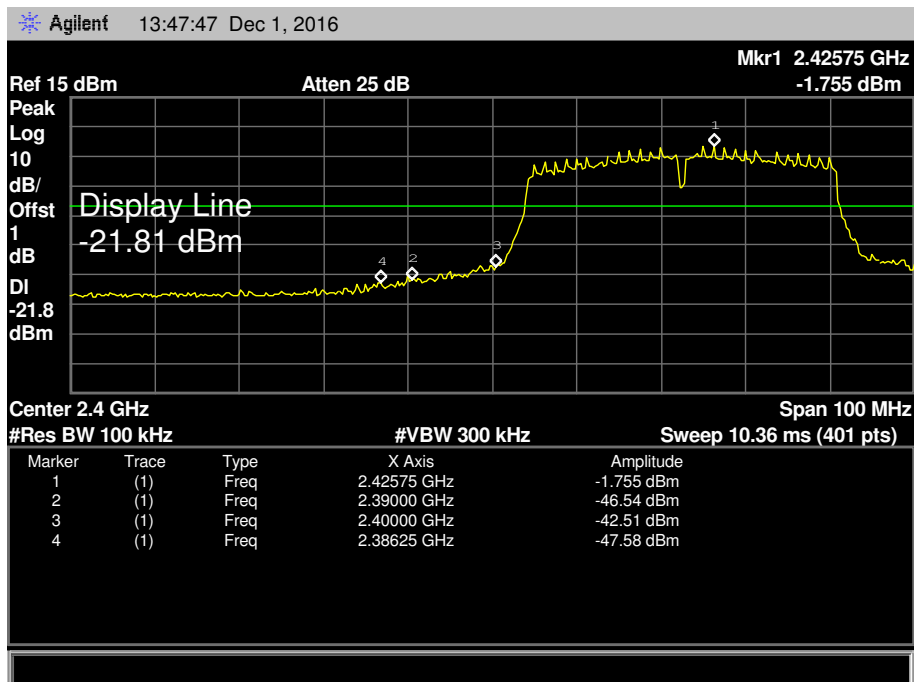

EUT:	WF40A Multi-Room Wi-Fi 2x20W Amplifier with IR Remote	Model:	WF40A
Temperature:	25 °C	Relative Humidity:	55%
Test Voltage:	AC 120V/60 Hz		
Test Mode:	TX N(HT40) Mode 2422MHz / TX N(HT40) Mode 2452MHz ANT 2		
Remark:	The EUT is programed in continuously transmitting mode		

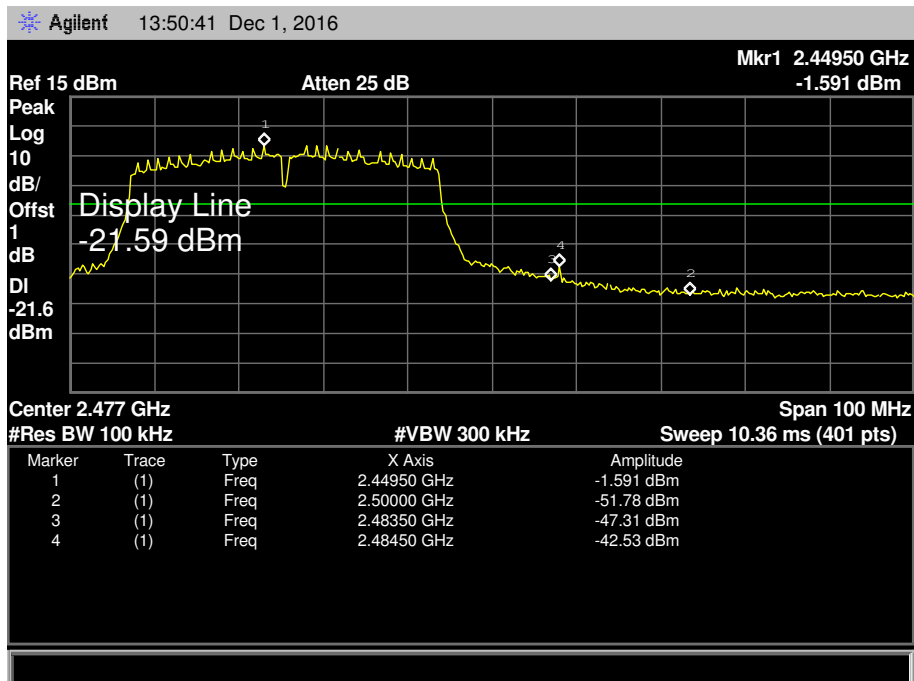
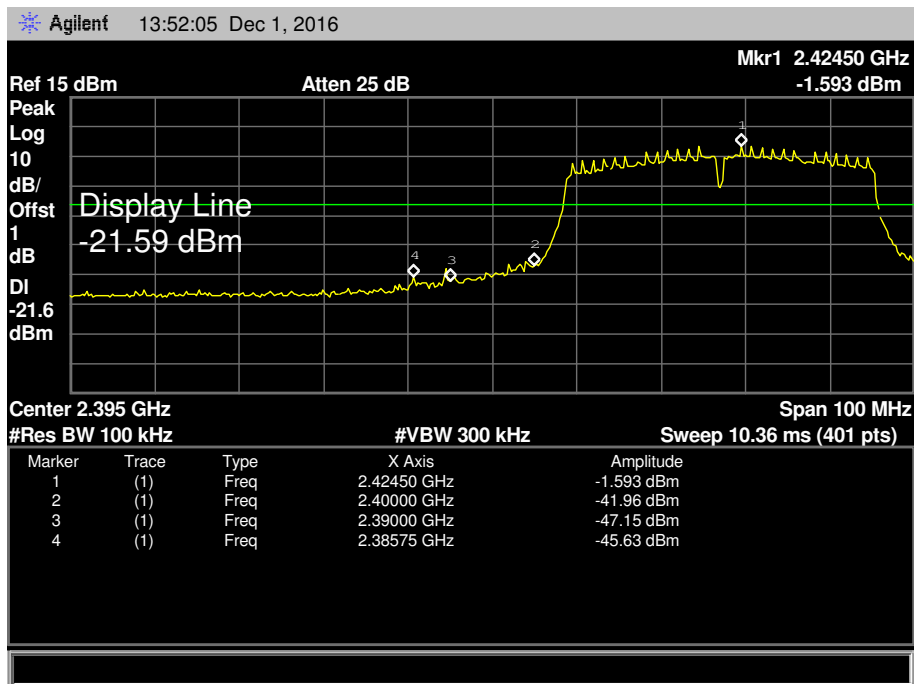

7. Bandwidth Test

7.1 Test Standard and Limit

- 7.1.1 Test Standard
FCC Part 15.247 (a)(2)
- 7.1.2 Test Limit

FCC Part 15 Subpart C(15.247)/RSS-210		
Test Item	Limit	Frequency Range(MHz)
Bandwidth	≥ 500 KHz (6dB bandwidth)	2400~2483.5

7.2 Test Setup

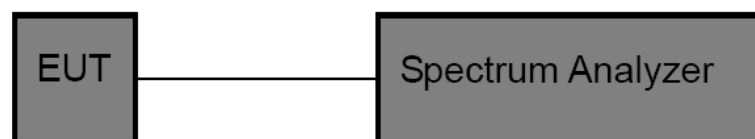

7.3 Test Procedure

- (1) The EUT was directly connected to the spectrum analyzer and antenna output port as show in the block diagram above.
- (2) The bandwidth is measured at an amplitude level reduced 6dB from the reference level. The reference level is the level of the highest amplitude signal observed from the transmitter at the fundamental frequency. Once the reference level is established, the equipment is conditioned with typical modulating signal to produce the worst –case (i.e the widest) bandwidth.
- (3)Measure the channel separation the spectrum analyzer was set to Resolution Bandwidth:100 kHz, and Video Bandwidth:300 kHz, Detector: Peak, Sweep Time set auto.

7.4 EUT Operating Condition

The EUT was set to continuously transmitting in each mode and low, middle and high channel for the test.

7.5 Test Data

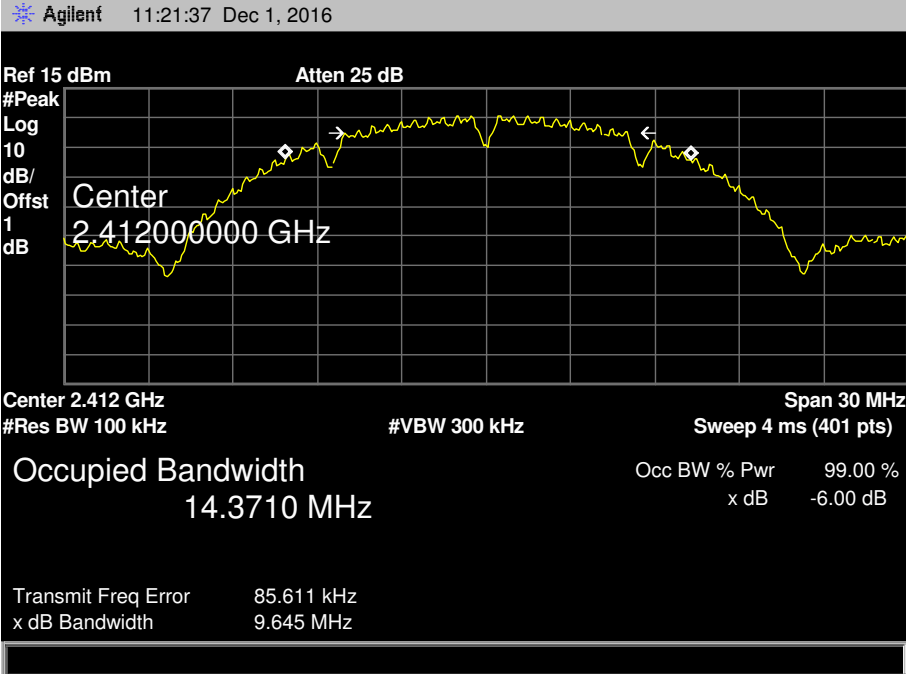
EUT:	WF40A Multi-Room Wi-Fi 2x20W Amplifier with IR Remote	Model:	WF40A
Temperature:	25 °C	Relative Humidity:	55%
Test Voltage:	AC 120V/60 Hz		
Test Mode:	TX 802.11B Mode ANT 1		
Channel frequency (MHz)	6dB Bandwidth (MHz)	99% Bandwidth (MHz)	Limit (MHz)
2412	9.645	14.3710	≥0.5
2437	9.640	14.3084	
2462	9.757	14.2526	
802.11B Mode (Antenna 1)			
2412 MHz			
			

802.11B Mode (Antenna 1)

2437 MHz

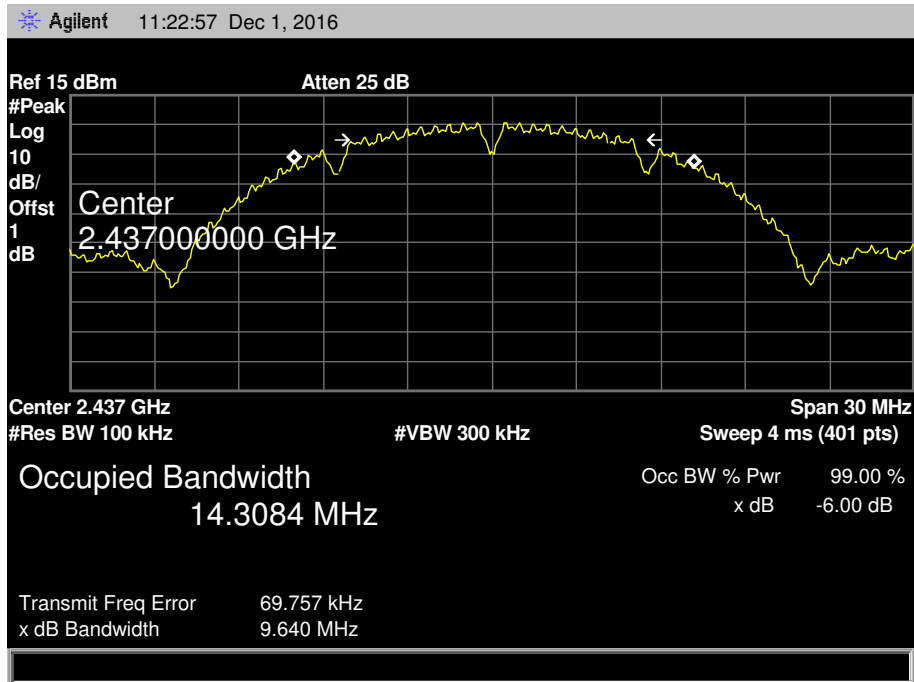

802.11B Mode (Antenna 1)

2462 MHz

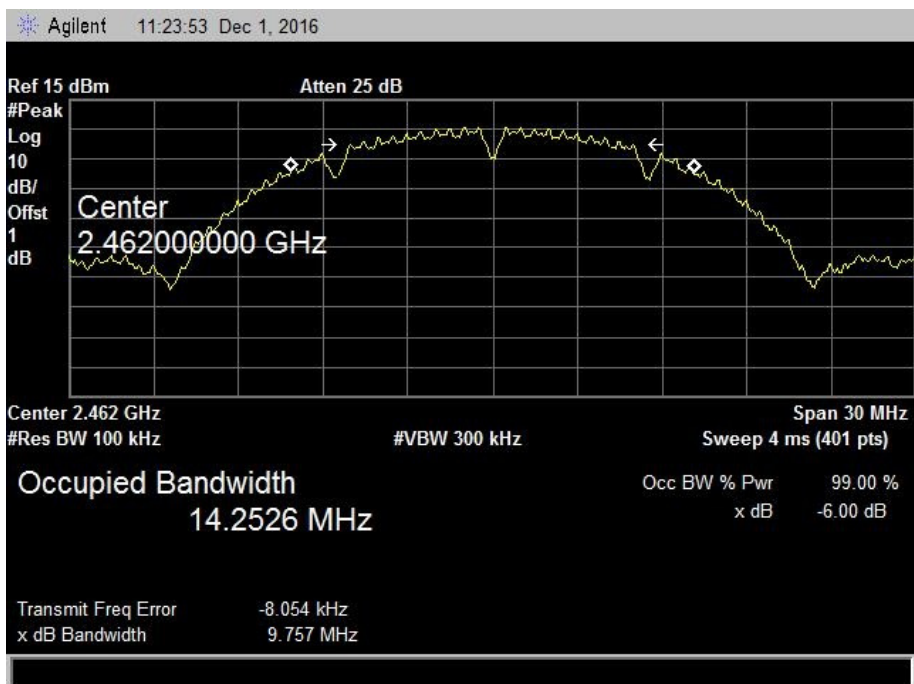

EUT:	WF40A Multi-Room Wi-Fi 2x20W Amplifier with IR Remote	Model:	WF40A
Temperature:	25 °C	Relative Humidity:	55%
Test Voltage:	AC 120V/60 Hz		
Test Mode:	TX 802.11B Mode ANT 2		
Channel frequency (MHz)	6dB Bandwidth (MHz)	99% Bandwidth (MHz)	Limit (MHz)
2412	9.039	14.2278	>=0.5
2437	9.556	14.1723	
2462	9.634	14.2025	

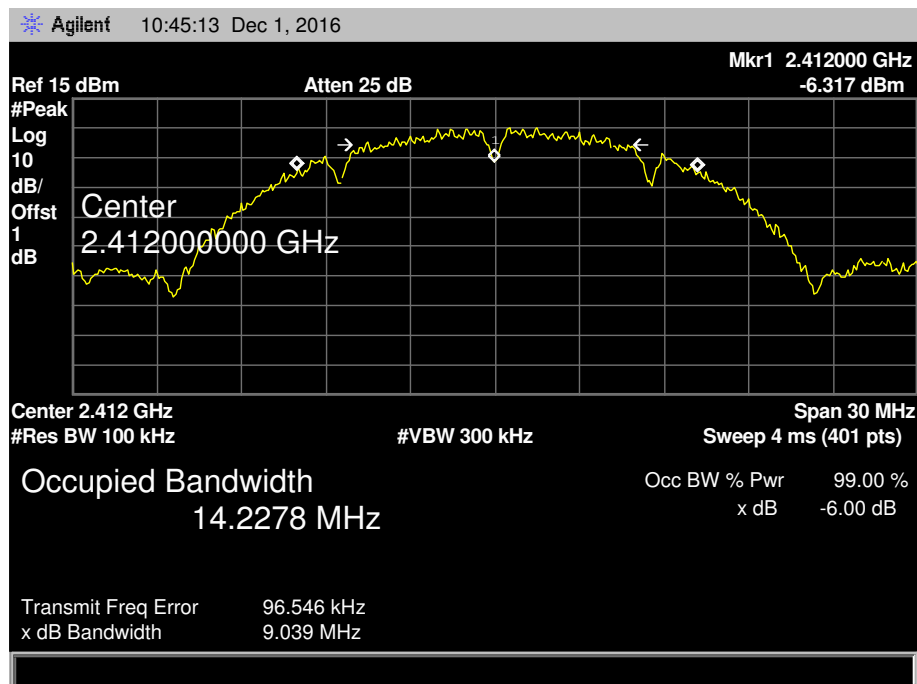
802.11B Mode (Antenna 2)
2412 MHz

802.11B Mode (Antenna 2)

2437 MHz

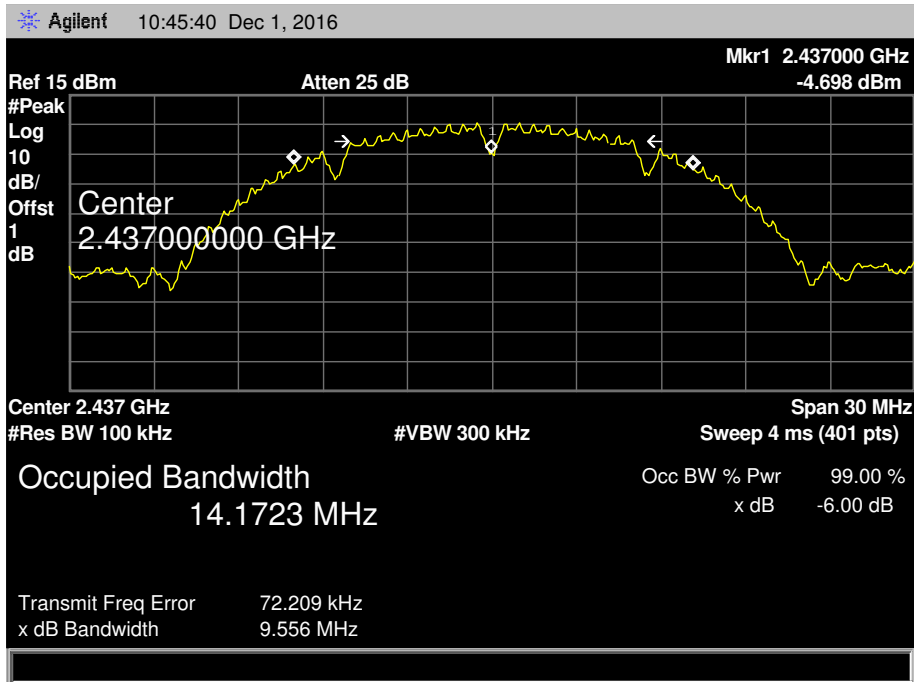

802.11B Mode (Antenna 2)

2462 MHz

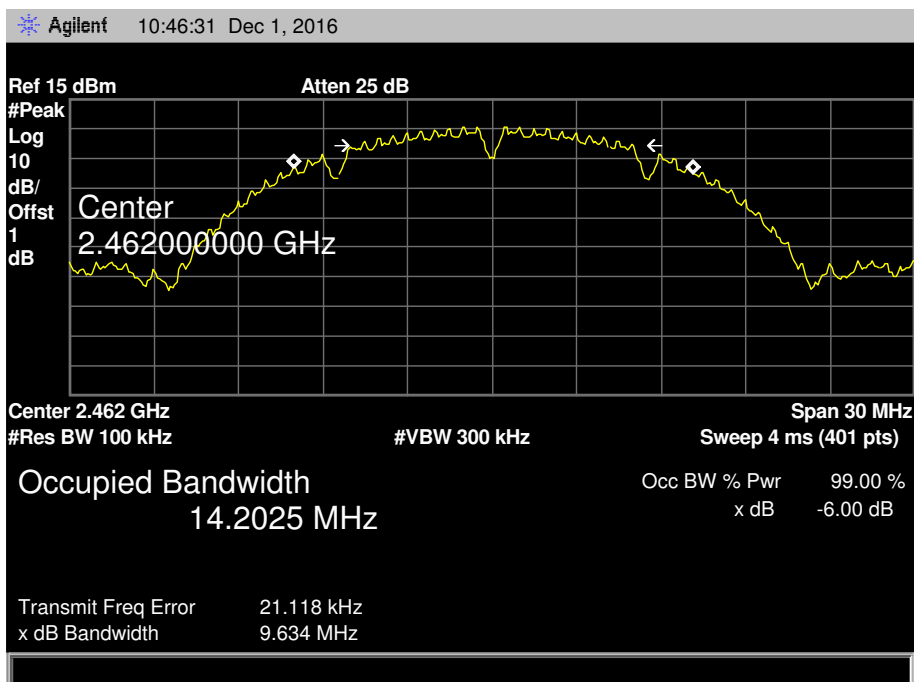

EUT:	WF40A Multi-Room Wi-Fi 2x20W Amplifier with IR Remote	Model:	WF40A
Temperature:	25 °C	Relative Humidity:	55%
Test Voltage:	AC 120V/60 Hz		
Test Mode:	TX 802.11G Mode ANT 1		
Channel frequency (MHz)	6dB Bandwidth (MHz)	99% Bandwidth (MHz)	Limit (MHz)
2412	15.171	16.3058	>=0.5
2437	15.183	16.2994	
2462	15.129	16.2917	

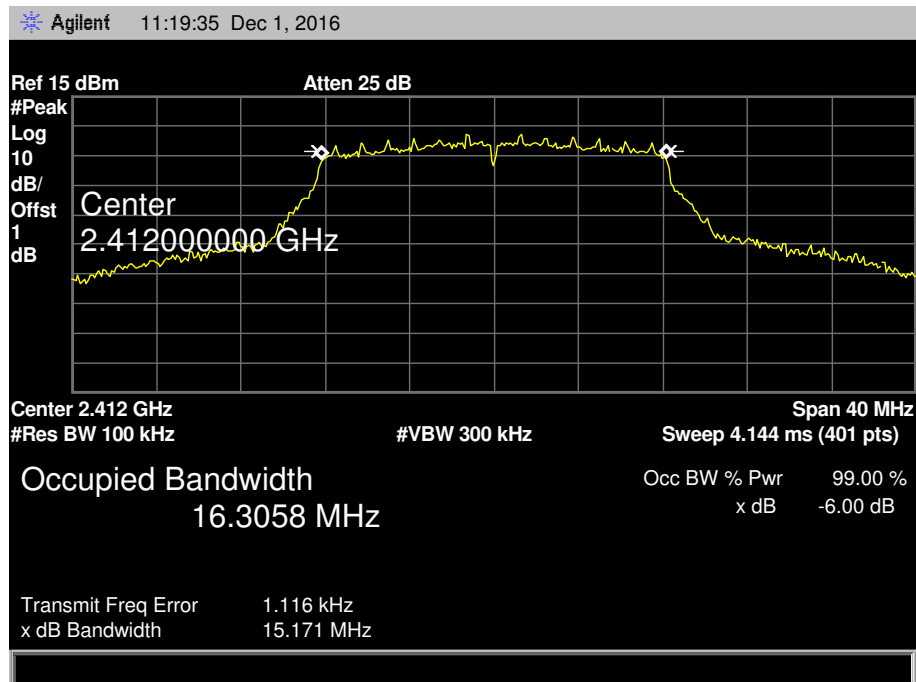
802.11G Mode (Antenna 1)
2412 MHz

802.11G Mode (Antenna 1)

2437 MHz

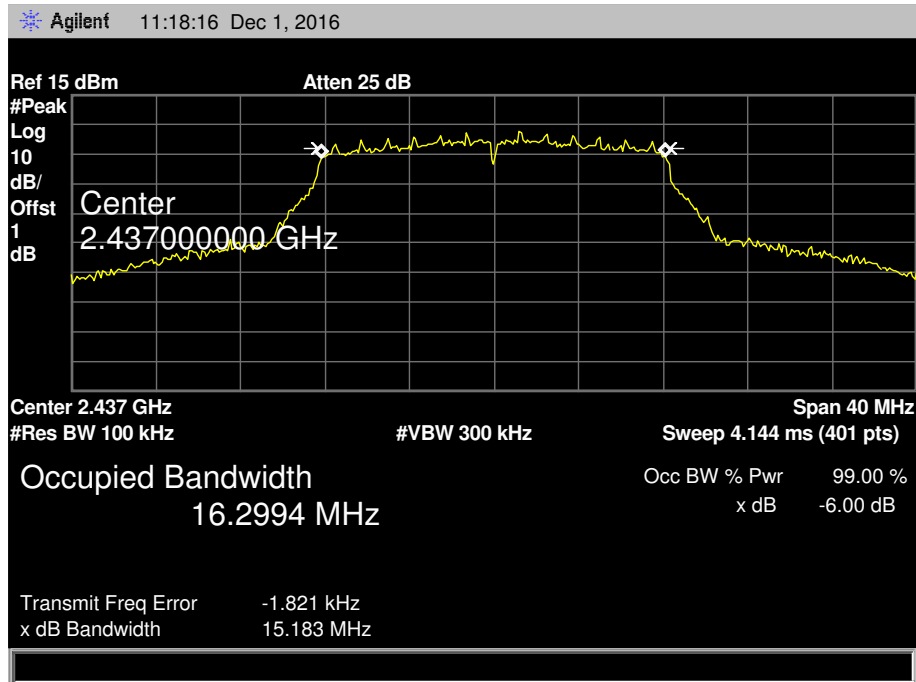

802.11G Mode (Antenna 1)

2462 MHz

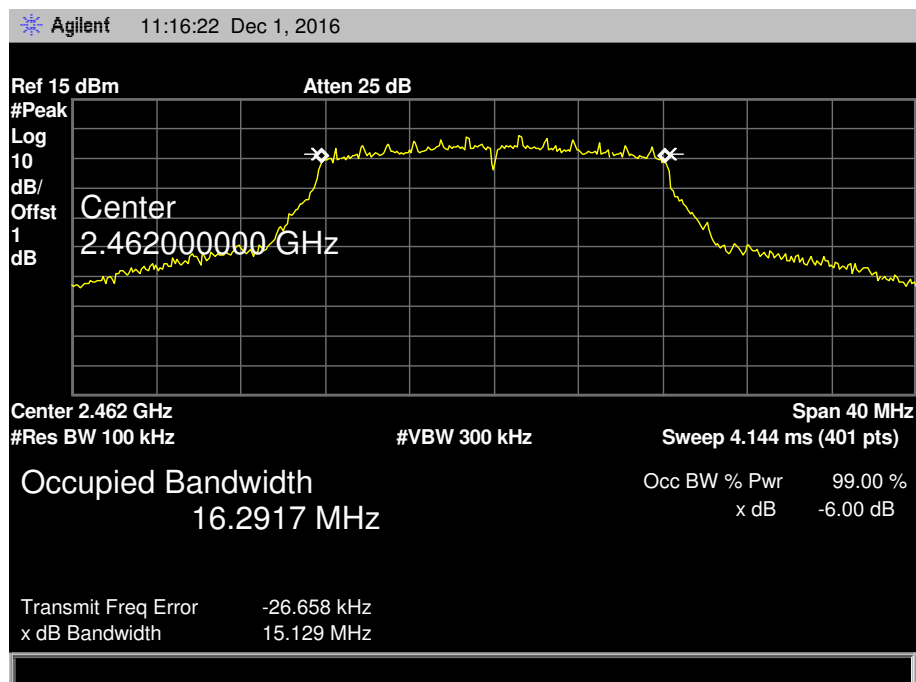

EUT:	WF40A Multi-Room Wi-Fi 2x20W Amplifier with IR Remote	Model:	WF40A
Temperature:	25 °C	Relative Humidity:	55%
Test Voltage:	AC 120V/60 Hz		
Test Mode:	TX 802.11G Mode ANT 2		
Channel frequency (MHz)	6dB Bandwidth (MHz)	99% Bandwidth (MHz)	Limit (MHz)
2412	13.967	16.3073	≥0.5
2437	15.380	16.3285	
2462	15.128	16.2940	

802.11G Mode (Antenna 2)

2412 MHz

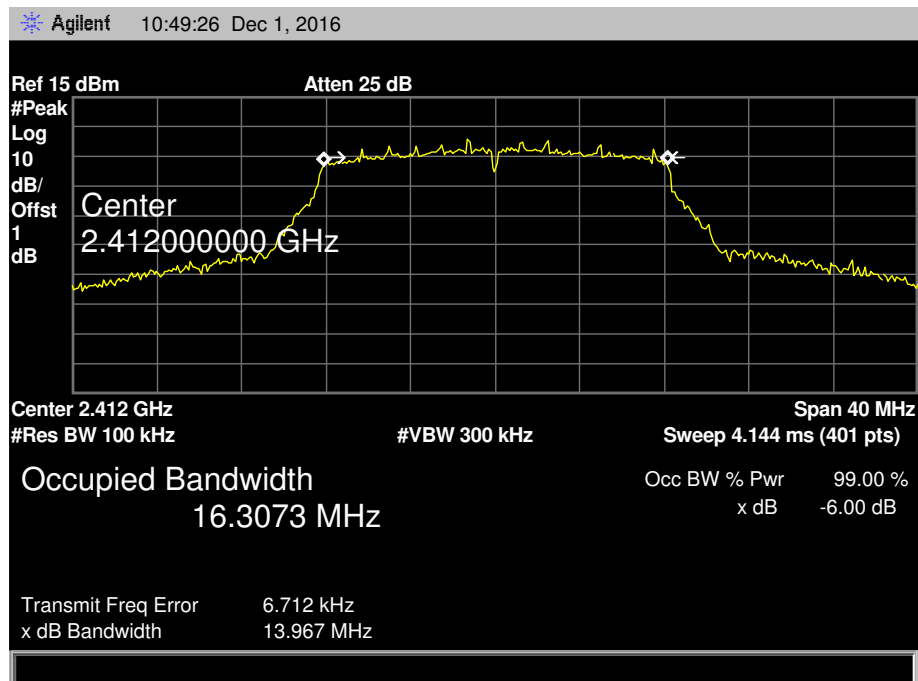

802.11G Mode (Antenna 2)

2437 MHz

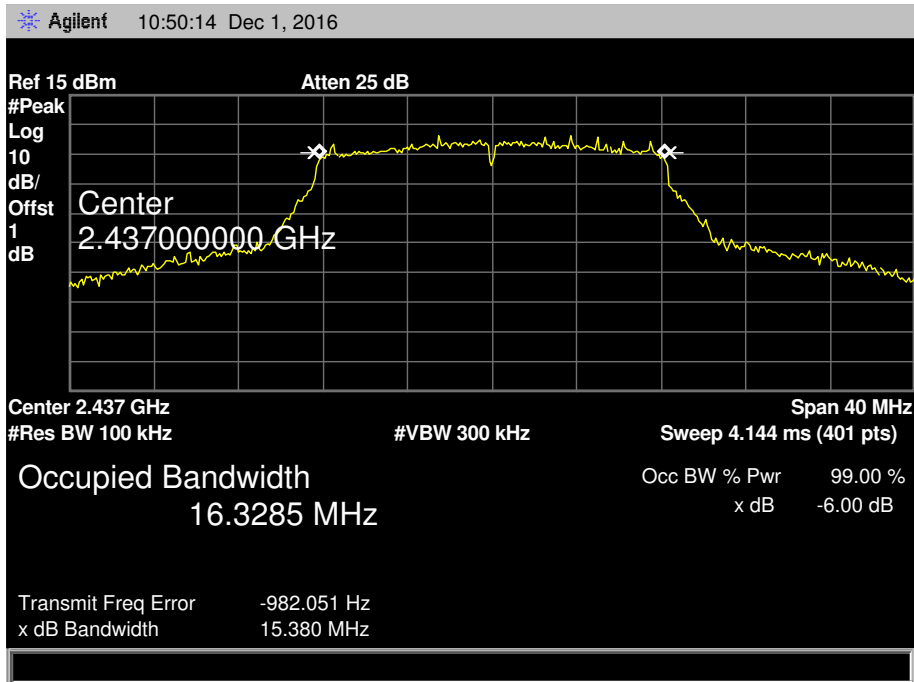

802.11G Mode (Antenna 2)

2462 MHz

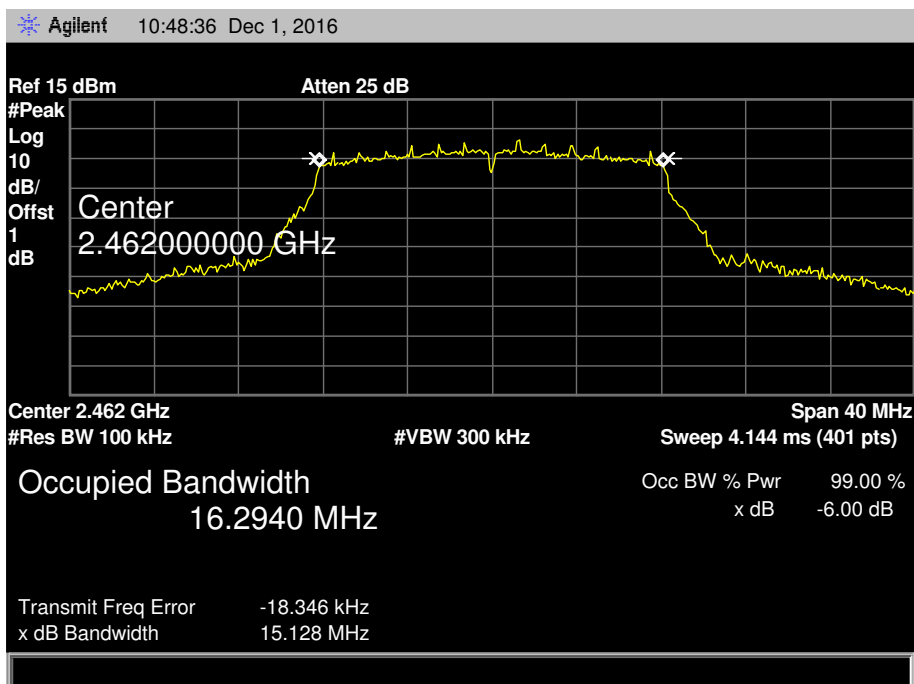

EUT:	WF40A Multi-Room Wi-Fi 2x20W Amplifier with IR Remote	Model:	WF40A
Temperature:	25 °C	Relative Humidity:	55%
Test Voltage:	AC 120V/60 Hz		
Test Mode:	TX 802.11N(HT20) Mode ANT 1		
Channel frequency (MHz)	6dB Bandwidth (MHz)	99% Bandwidth (MHz)	Limit (MHz)
2412	15.176	17.4300	>=0.5
2437	15.179	17.4307	
2462	15.079	17.4409	
802.11N(HT20) Mode (Antenna 1)			
2412 MHz			
<p>Agilent 11:12:34 Dec 1, 2016</p> <p>Ref 15 dBm Atten 25 dB</p> <p>#Peak Log</p> <p>10 dB/Offst</p> <p>1 dB</p> <p>Center 2.412000000 GHz</p> <p>Center 2.412 GHz Span 40 MHz</p> <p>#Res BW 100 kHz #VBW 300 kHz Sweep 4.144 ms (401 pts)</p> <p>Occupied Bandwidth Occ BW % Pwr 99.00 %</p> <p>17.4300 MHz x dB -6.00 dB</p> <p>Transmit Freq Error 10.883 kHz</p> <p>x dB Bandwidth 15.176 MHz</p>			

802.11N(HT20) Mode

2437 MHz

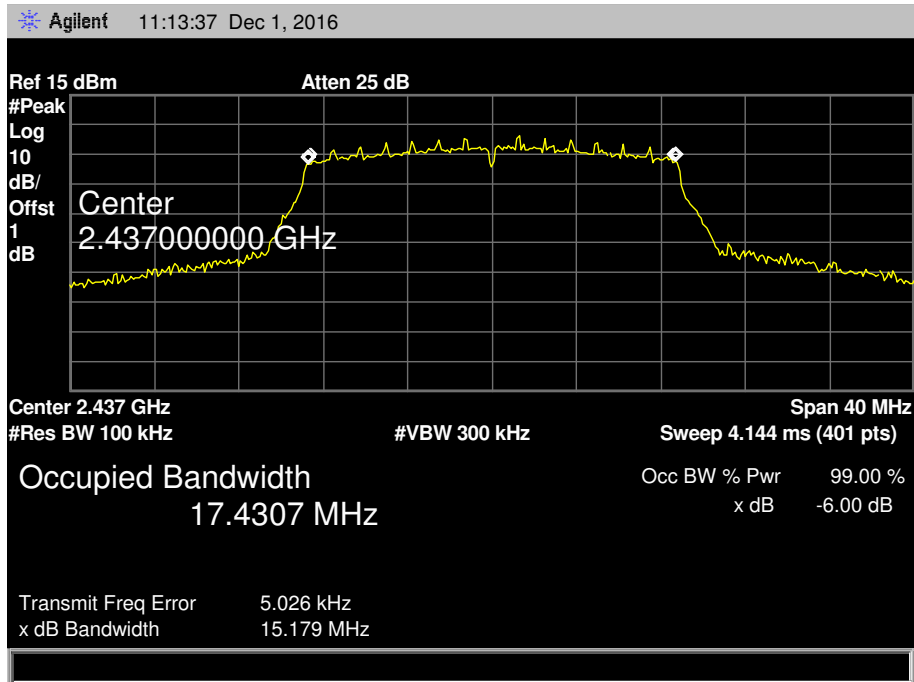

802.11N(HT20) Mode

2462 MHz

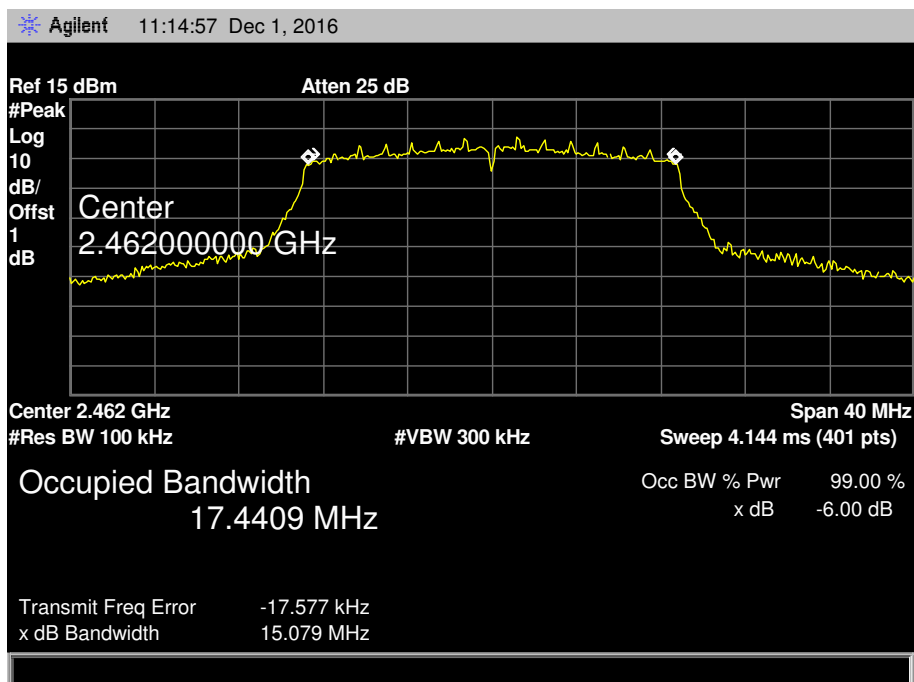

EUT:	WF40A Multi-Room Wi-Fi 2x20W Amplifier with IR Remote	Model:	WF40A
Temperature:	25 °C	Relative Humidity:	55%
Test Voltage:	AC 120V/60 Hz		
Test Mode:	TX 802.11N(HT20) Mode ANT 2		
Channel frequency (MHz)	6dB Bandwidth (MHz)	99% Bandwidth (MHz)	Limit (MHz)
2412	15.184	17.4465	>=0.5
2437	15.137	17.4598	
2462	14.580	17.4752	

802.11N(HT20) Mode (Antenna 2)

2412 MHz

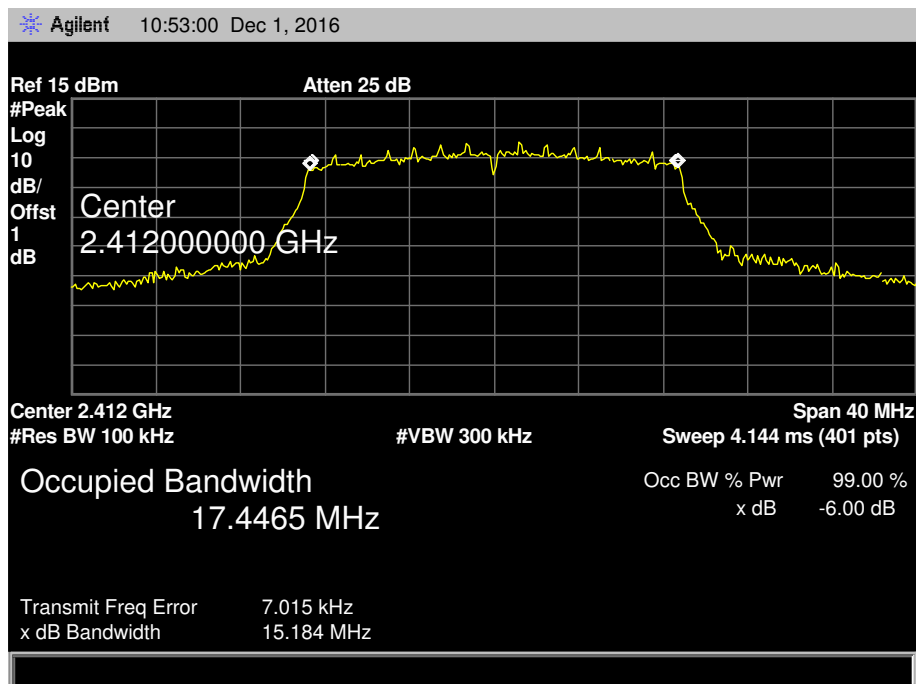

802.11N(HT20) Mode (Antenna 2)

2437 MHz

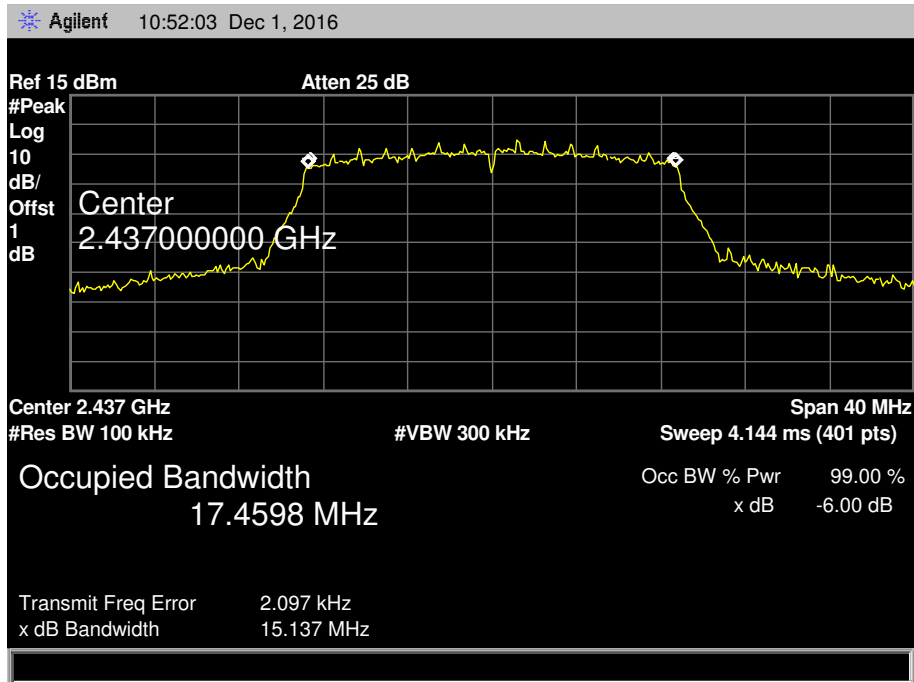

802.11N(HT20) Mode (Antenna 2)

2462 MHz

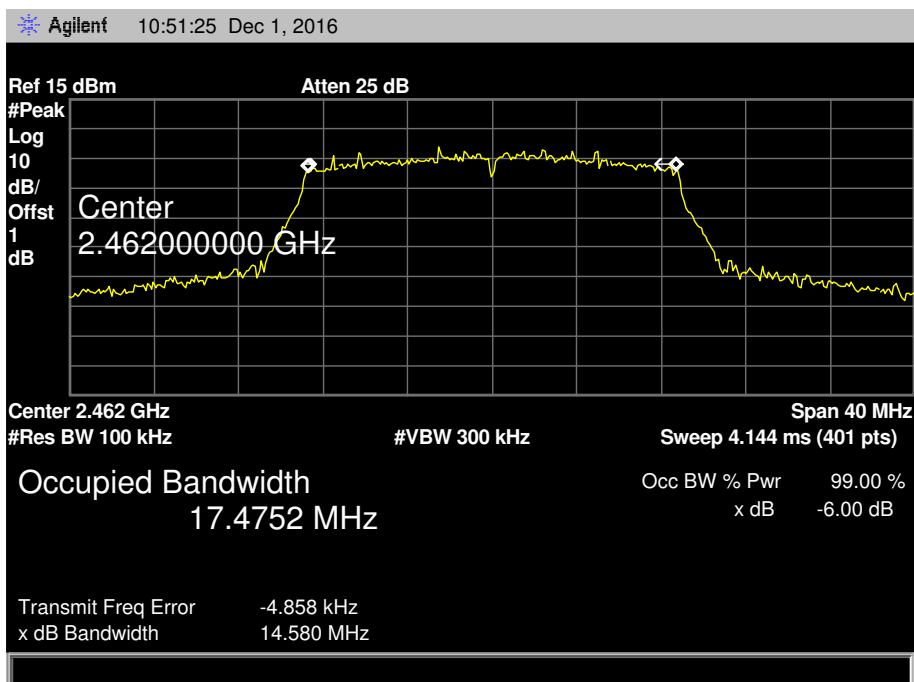

EUT:	WF40A Multi-Room Wi-Fi 2x20W Amplifier with IR Remote	Model:	WF40A
Temperature:	25 °C	Relative Humidity:	55%
Test Voltage:	AC 120V/60 Hz		
Test Mode:	TX 802.11N(HT40) Mode ANT 1		
Channel frequency (MHz)	6dB Bandwidth (MHz)	99% Bandwidth (MHz)	Limit (MHz)
2422	35.330	35.5856	>=0.5
2437	35.207	35.5766	
2452	35.081	35.5763	

802.11N(HT40) Mode (Antenna 1)

2422 MHz

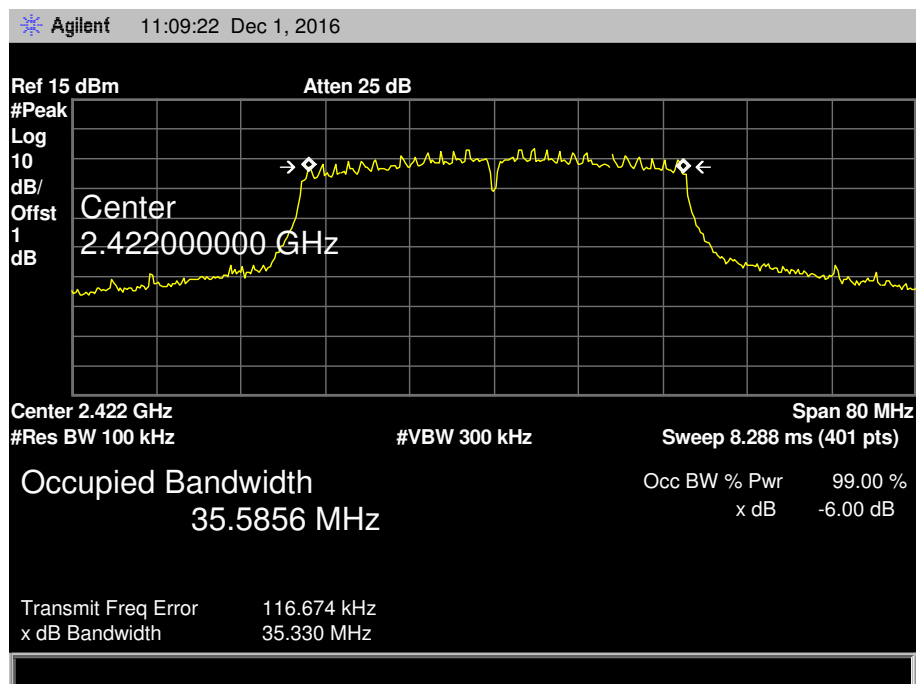

802.11N(HT40) Mode (Antenna 1)

2437 MHz

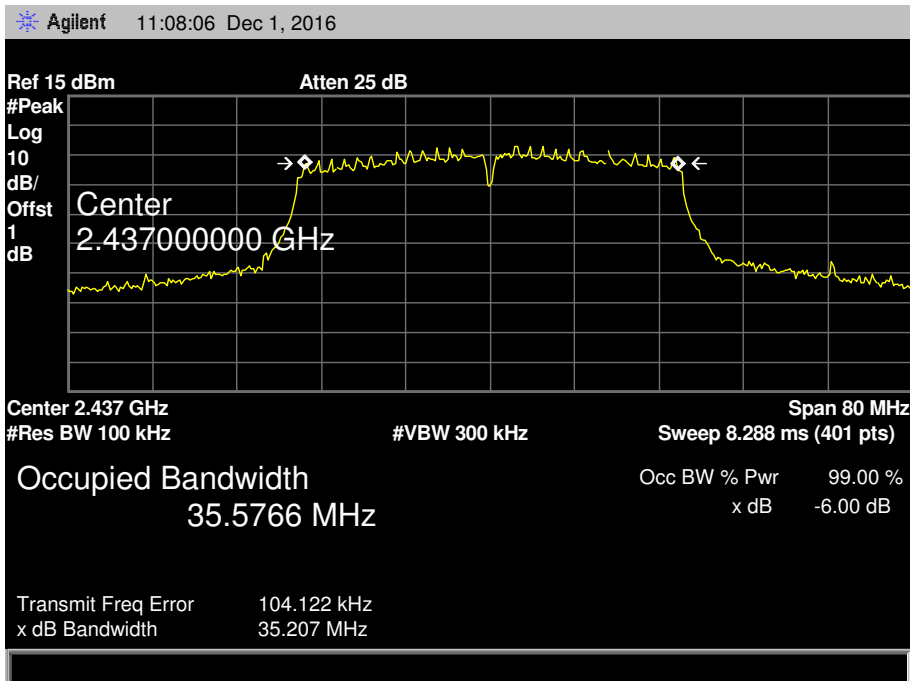

802.11N(HT40) Mode (Antenna 1)

2452 MHz

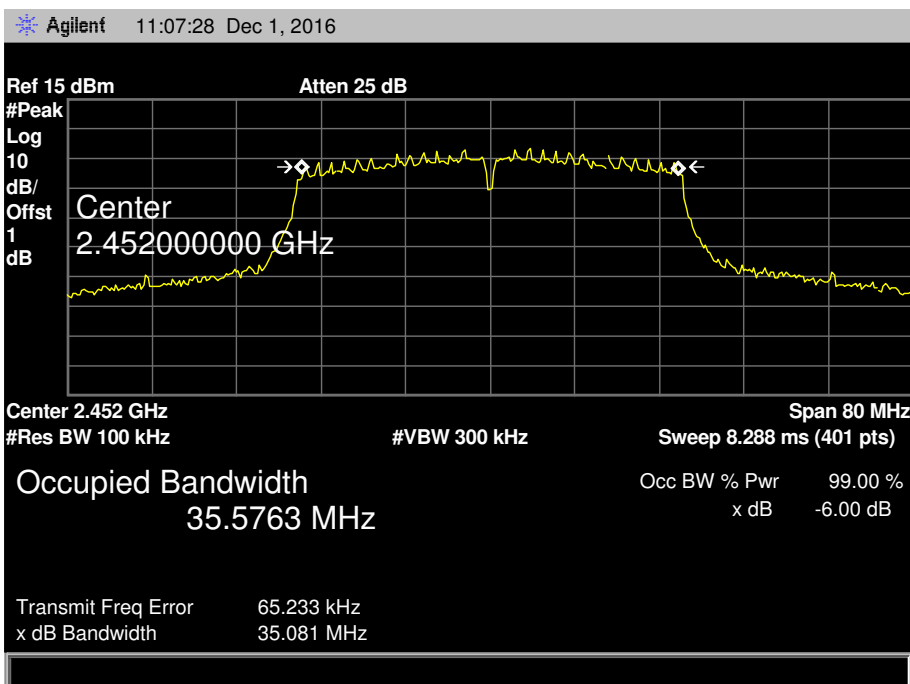

EUT:	WF40A Multi-Room Wi-Fi 2x20W Amplifier with IR Remote	Model:	WF40A
Temperature:	25 °C	Relative Humidity:	55%
Test Voltage:	AC 120V/60 Hz		
Test Mode:	TX 802.11N(HT40) Mode ANT 2		
Channel frequency (MHz)	6dB Bandwidth (MHz)	99% Bandwidth (MHz)	Limit (MHz)
2422	35.342	35.5918	>=0.5
2437	34.059	35.6434	
2452	35.300	35.5848	

802.11N(HT20) Mode (Antenna 2)

2422 MHz

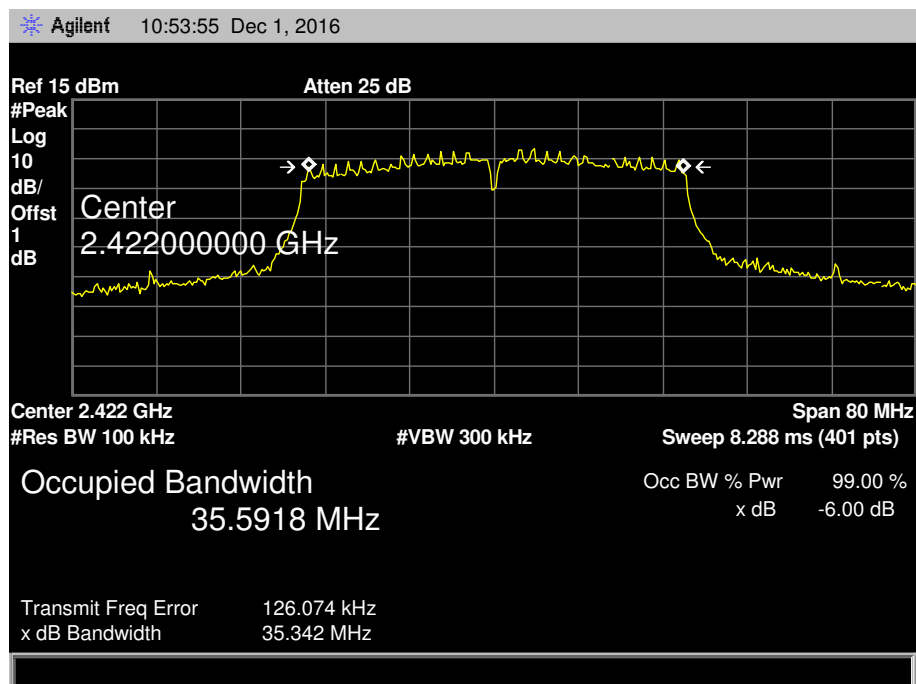

802.11N(HT40) Mode (Antenna 2)

2437 MHz

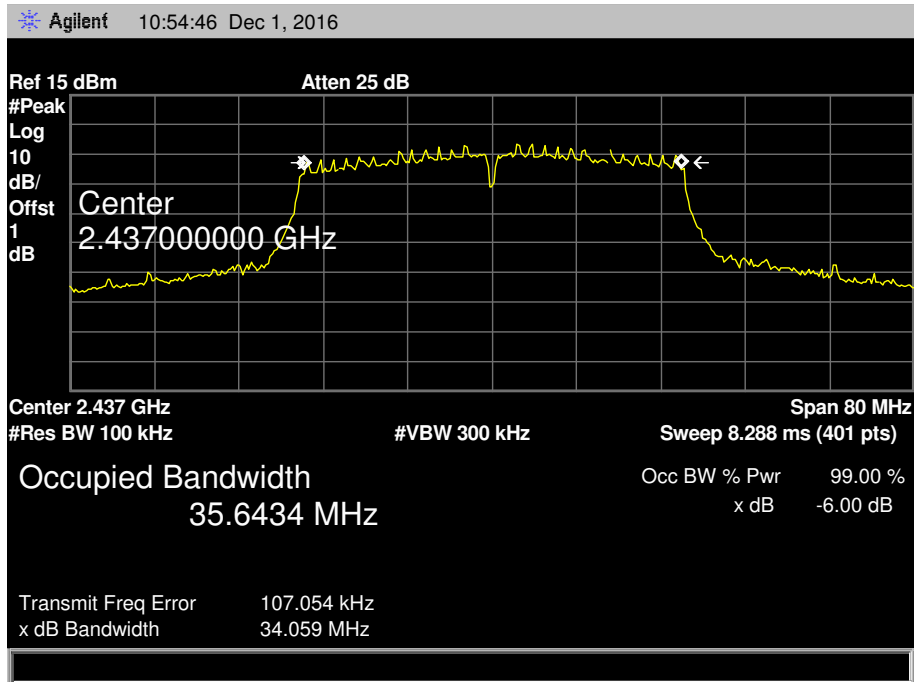

802.11N(HT40) Mode (Antenna 2)

2452 MHz

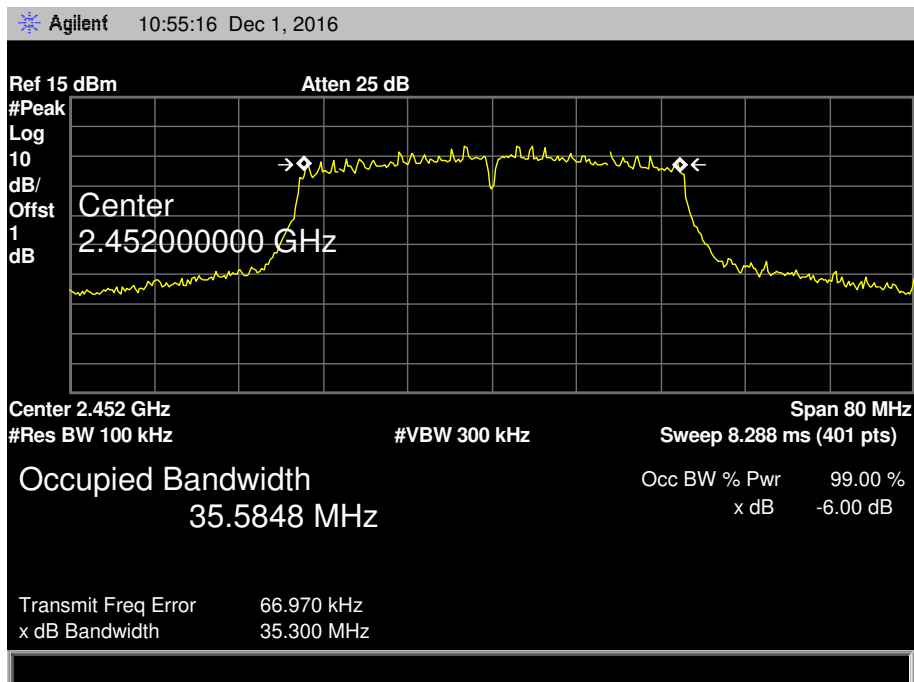

8. Peak Output Power Test

8.1 Test Standard and Limit

8.1.1 Test Standard

FCC Part 15.247 (b)

8.1.2 Test Limit

FCC Part 15 Subpart C(15.247)/RSS-210		
Test Item	Limit	Frequency Range(MHz)
Peak Output Power	1 Watt or 30 dBm	2400~2483.5

8.2 Test Setup

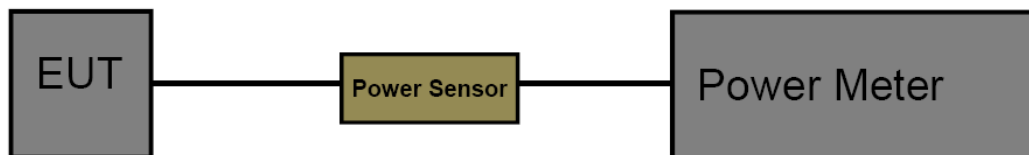

8.3 Test Procedure

The measurement is according to section 9.1.2 of KDB 558074 D01 DTS Meas Guidance v03r05 and KDB 662911 D01 Multiple Transmitter Output v02r01.

The EUT was connected to RF power meter via a broadband power sensor as show the block above. The power sensor video bandwidth is greater than or equal to the DTS bandwidth of the equipment.

8.4 EUT Operating Condition

The EUT was set to continuously transmitting in the max power during the test.

8.5 Test Data

Conducted Power					
802.11b Power					
Channel	Frequency	Conducted Power (dBm)			Max. Limit (dBm)
		Ant. 1	Ant. 2	Total	
1	2412 MHz	18.36	18.31	---	30
6	2437 MHz	18.23	18.23	---	
11	2462 MHz	18.42	18.31	---	
802.11g Power					
Channel	Frequency	Conducted Power (dBm)			Max. Limit (dBm)
		Ant. 1	Ant. 2	Total	
1	2412 MHz	17.38	17.29	---	30
6	2437 MHz	17.36	17.43	---	
11	2462 MHz	17.28	17.58	---	
802.11n(HT20) Power					
Channel	Frequency	Conducted Power (dBm)			Max. Limit (dBm)
		Ant. 1	Ant. 2	Total	
1	2412 MHz	15.86	15.53	18.71	30
6	2437 MHz	15.86	15.46	18.67	
11	2462 MHz	15.41	15.24	18.34	
802.11n(HT40) Power					
Channel	Frequency	Conducted Power (dBm)			Max. Limit (dBm)
		Ant. 1	Ant. 2	Total	
3	2422 MHz	15.57	15.62	18.61	30
6	2437 MHz	15.40	15.52	18.47	
9	2452 MHz	15.25	15.36	18.32	

Test Mode	Duty cycle
802.11 b	>98%
802.11 g	
802.11 n(HT20)	
802.11 n(HT40)	

Please see the next plots.

802.11 b 2412MHz

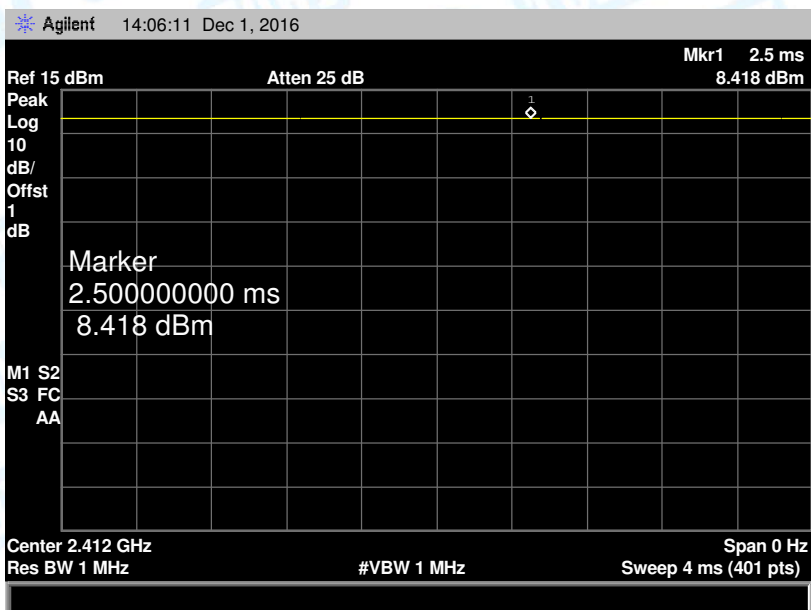

802.11 g 2412MHz

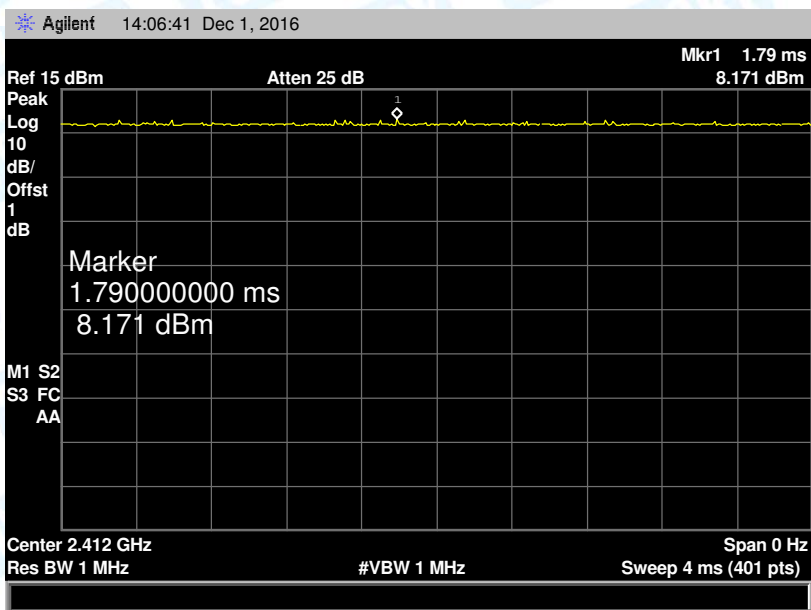

802.11 n(HT20) 2412MHz

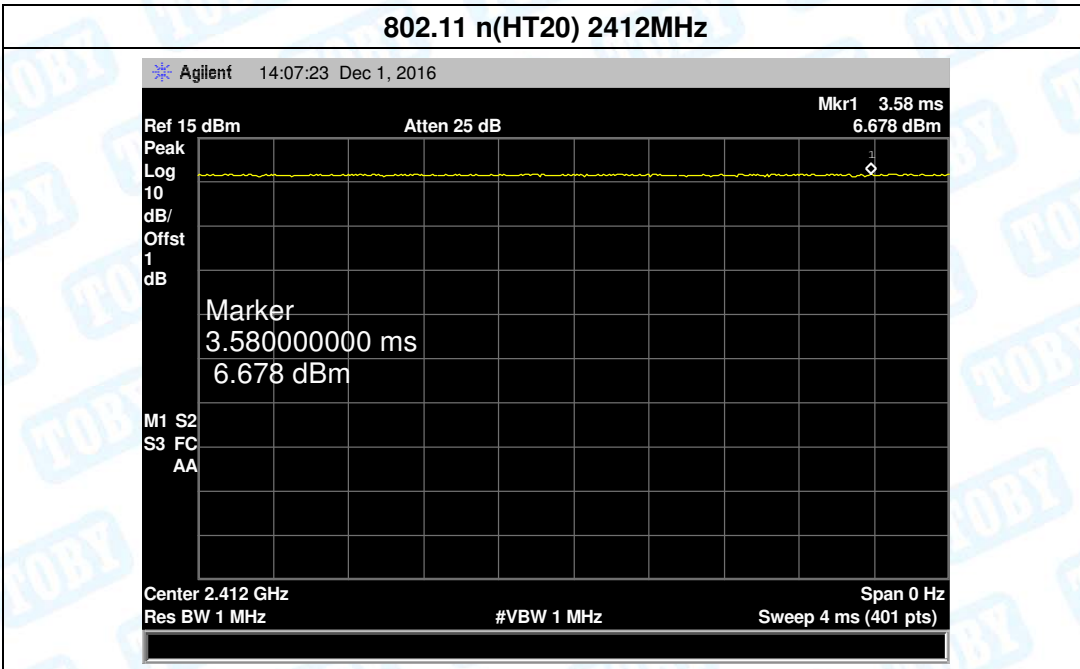

802.11 n(HT40) 2412MHz

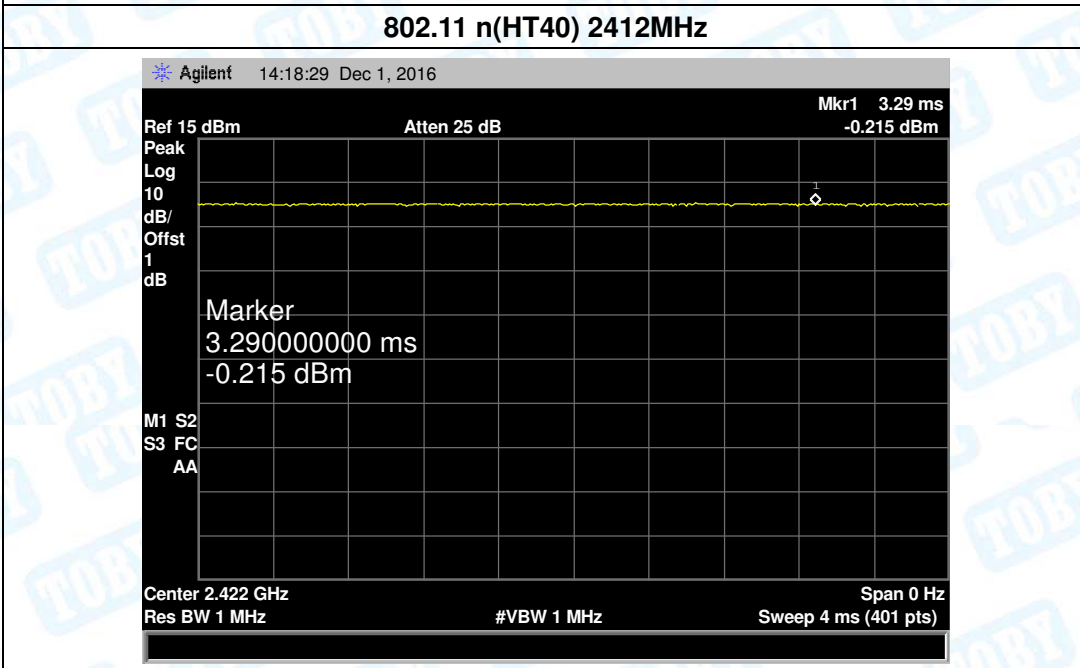

9. Power Spectral Density Test

9.1 Test Standard and Limit

- 9.1.1 Test Standard
FCC Part 15.247 (e)
- 9.1.2 Test Limit

FCC Part 15 Subpart C(15.247)		
Test Item	Limit	Frequency Range(MHz)
Power Spectral Density	8dBm(in any 3 kHz)	2400~2483.5

9.2 Test Setup

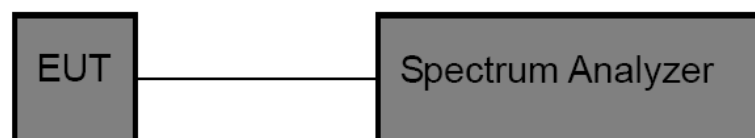

9.3 Test Procedure

The EUT was directly connected to the Spectrum Analyzer and antenna output port as show in the block diagram above. The measurement according to section 10.2 of KDB 558074 D01 DTS Meas Guidance v03r05 and KDB 662911 D01 Multiple Transmitter Output v02r01.

- (1) The EUT was directly connected to the spectrum analyzer and antenna output port as show in the block diagram above.
- (2) Set analyser center frequency to DTS channel center frequency.
- (3) Set the span to 1.5 times the DTS bandwidth.
- (4) Set the RBW to: 3 kHz
- (5) Set the VBW to: 10 kHz
- (6) Detector: peak
- (7) Sweep time: auto
- (8) Allow trace to fully stabilize. Then use the peak marker function to determine the maximum amplitude level.

9.4 EUT Operating Condition

The EUT was set to continuously transmitting in each mode and low, middle and high channel for the test.

9.5 Test Data

802.11b Mode					
Channel	Frequency	Conducted Power (dBm/3KHz)			Max. Limit (dBm/3KHz)
		Ant. 1	Ant. 2	Total	
1	2412 MHz	-7.623	-6.267	---	8
6	2437 MHz	-8.136	-7.052	---	
11	2462 MHz	-8.965	-8.044	---	
802.11g Mode					
Channel	Frequency	Conducted Power (dBm/3KHz)			Max. Limit (dBm/3KHz)
		Ant. 1	Ant. 2	Total	
1	2412 MHz	-13.17	-14.26	---	8
6	2437 MHz	-13.94	-14.23	---	
11	2462 MHz	-12.06	-13.48	---	
802.11n(HT20) Mode					
Channel	Frequency	Conducted Power (dBm/3KHz)			Max. Limit (dBm/3KHz)
		Ant. 1	Ant. 2	Total	
1	2412 MHz	-16.18	-16.99	-13.56	8
6	2437 MHz	-15.73	-15.84	-12.77	
11	2462 MHz	-15.18	-15.97	-12.55	
802.11n(HT40) Mode					
Channel	Frequency	Conducted Power (dBm/3KHz)			Max. Limit (dBm/3KHz)
		Ant. 1	Ant. 2	Total	
3	2422 MHz	-18.46	-18.39	-15.41	8
6	2437 MHz	-16.68	-17.75	-14.17	
9	2452 MHz	-17.05	-16.92	-13.97	
Test plots please refer to below pages:					

802.11 b 2412 MHz (ANT 1)

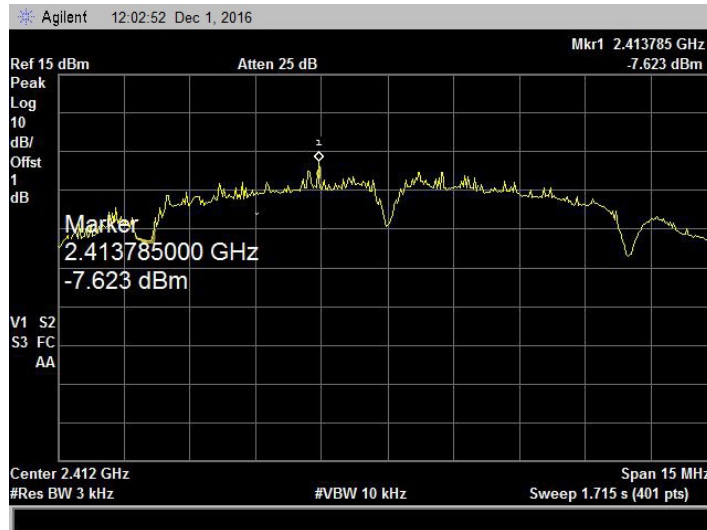

802.11 b 2437 MHz (ANT 1)

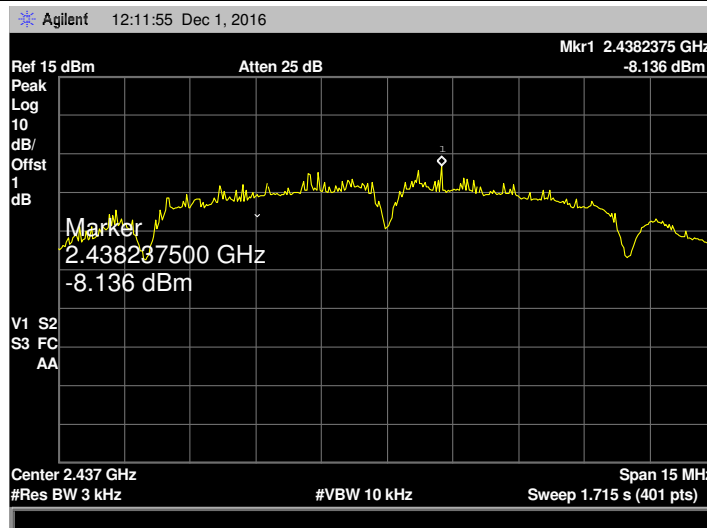

802.11 b 2462MHz (ANT 1)

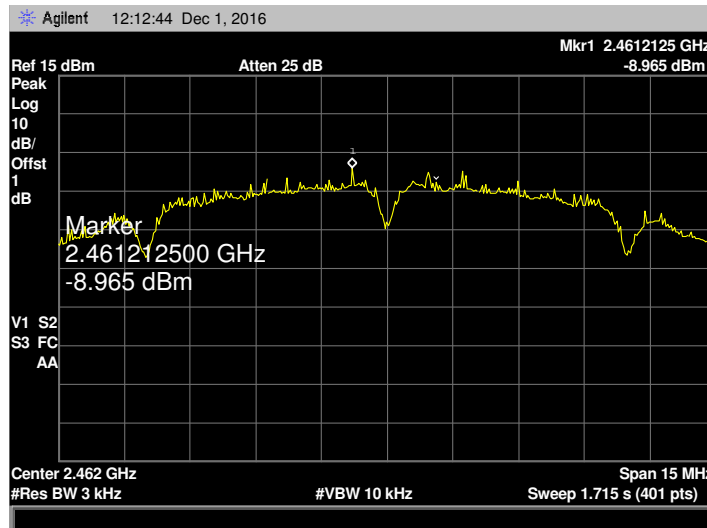

802.11 b 2412 MHz (ANT 2)

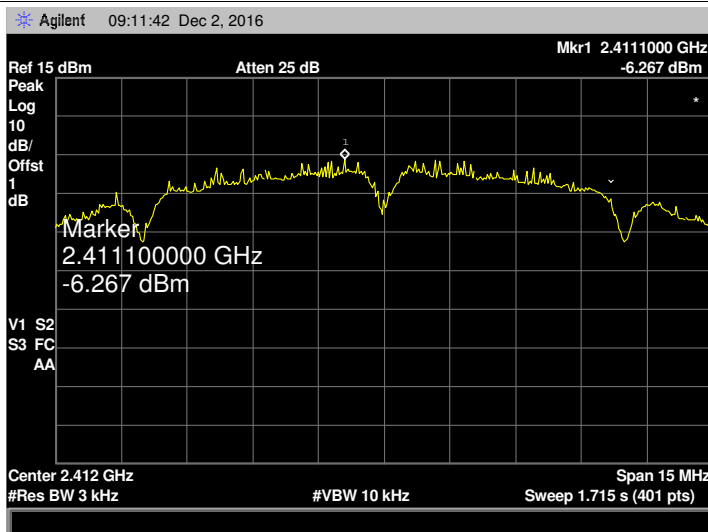

802.11 b 2437 MHz (ANT 2)

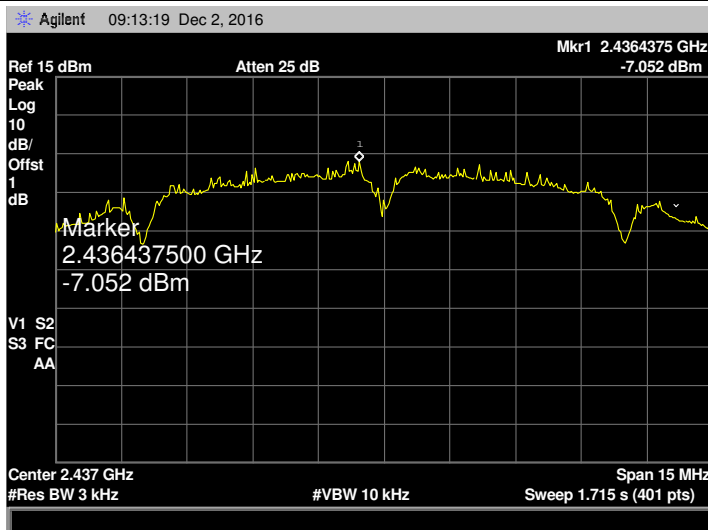

802.11 b 2462MHz (ANT 2)

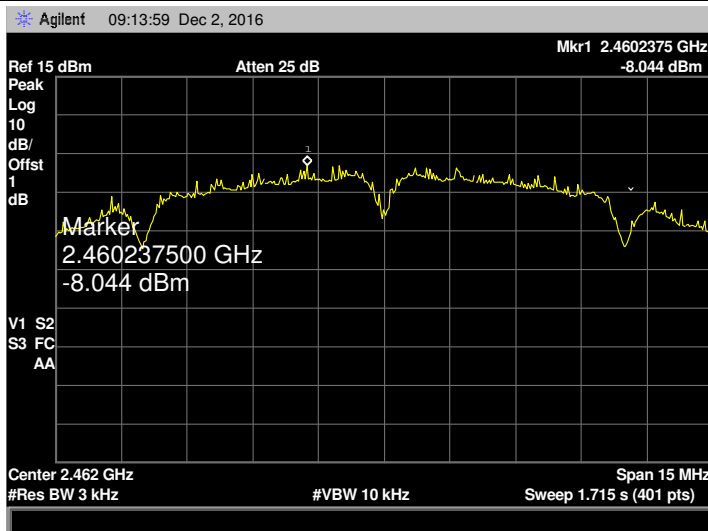

802.11 g 2412 MHz (ANT 1)

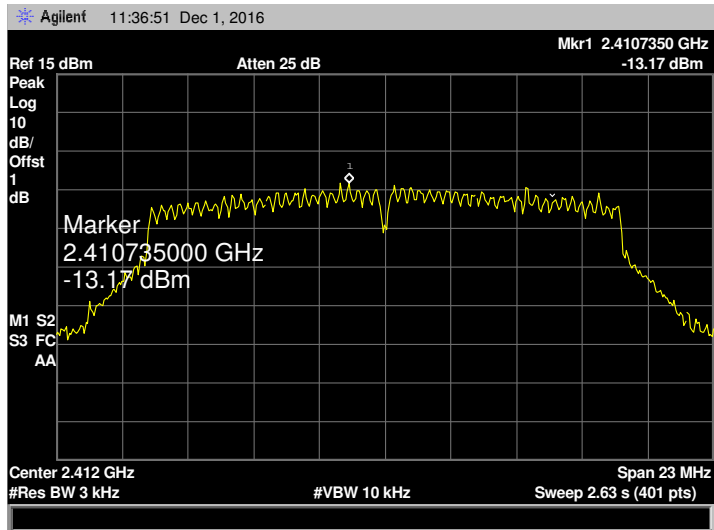

802.11 g 2437 MHz (ANT 1)

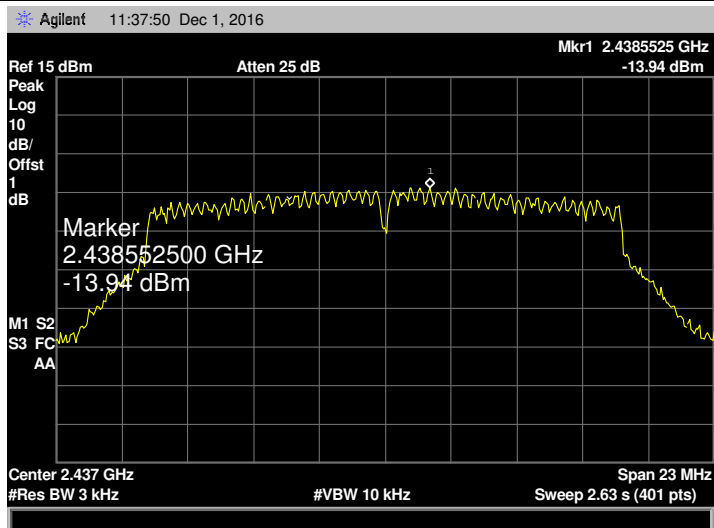

802.11 g 2462MHz (ANT 1)

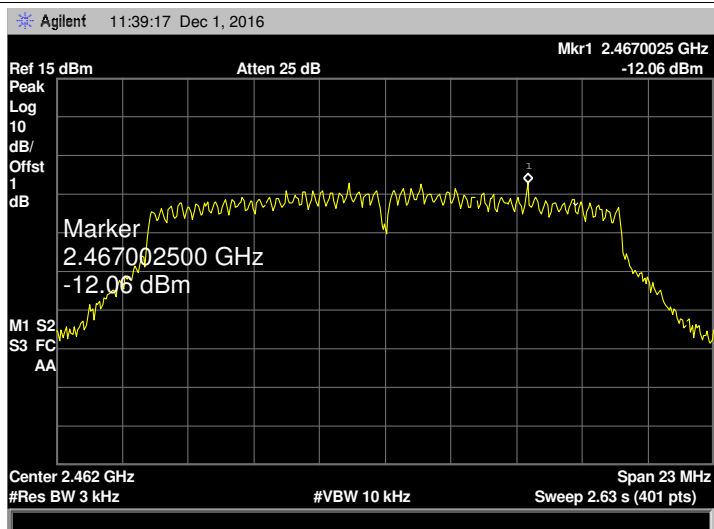

802.11 g 2412 MHz (ANT 2)

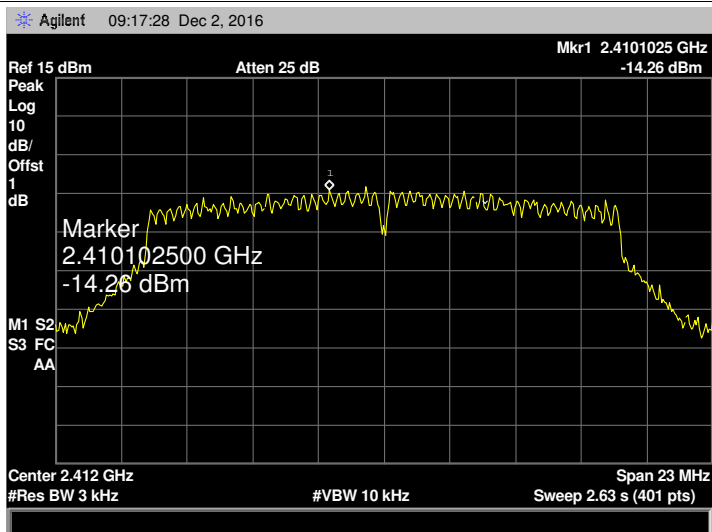

802.11 g 2437 MHz (ANT 2)

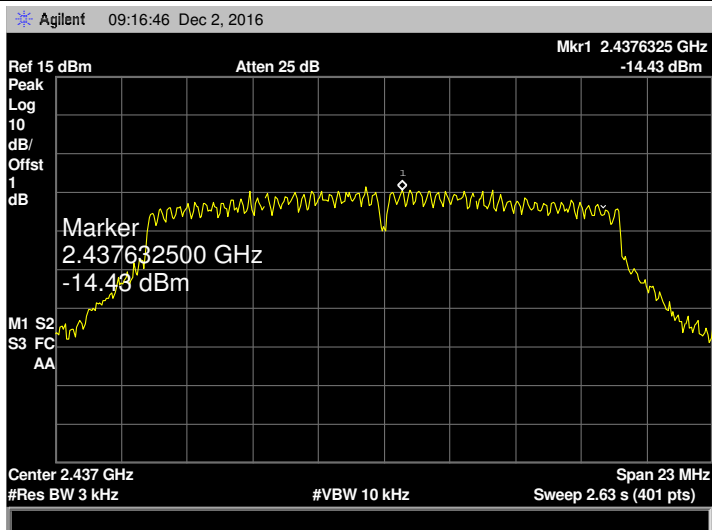

802.11 g 2462 MHz (ANT 2)

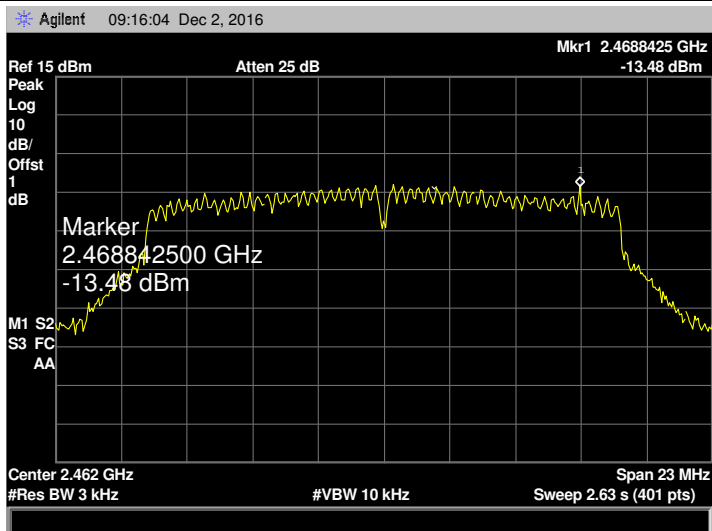

802.11 n(HT20) 2412 MHz (ANT 1)

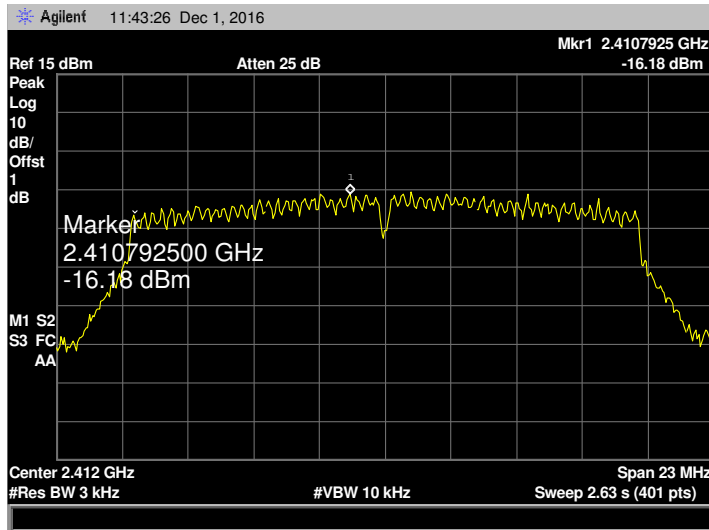

802.11 n(HT20) 2437 MHz (ANT 1)

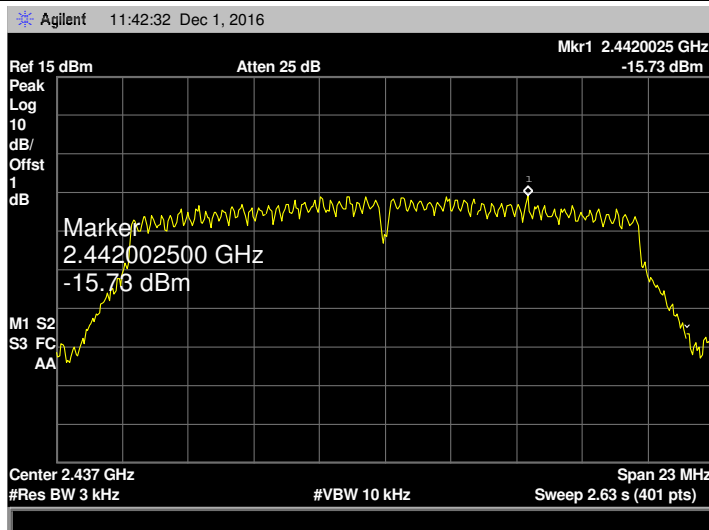

802.11 n(HT20) 2462MHz (ANT 1)

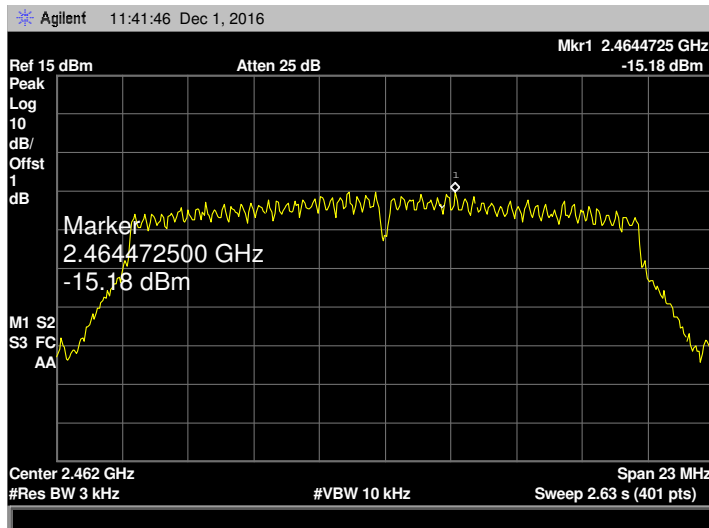

802.11 n(HT20) 2412 MHz (ANT 2)

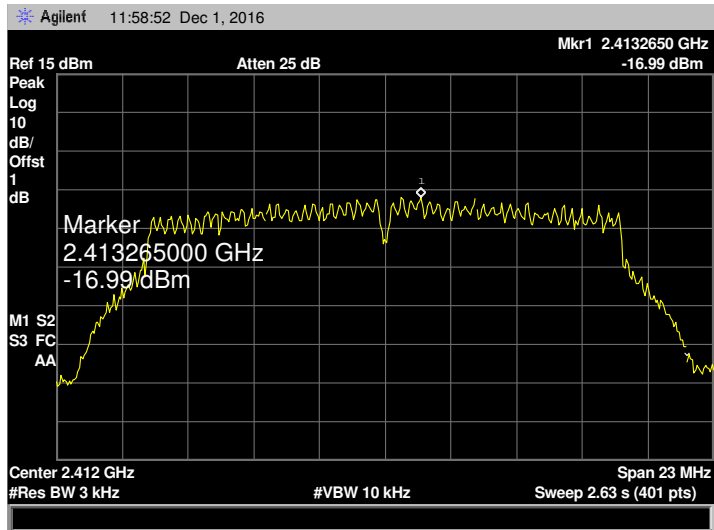

802.11 n(HT20) 2437 MHz (ANT 2)

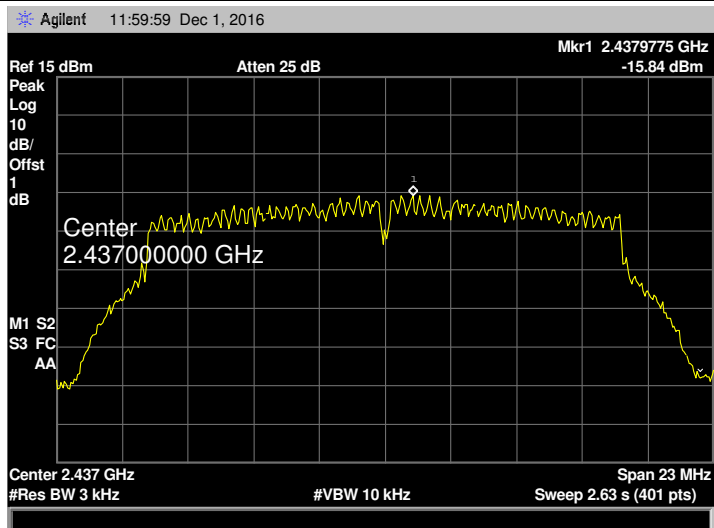

802.11 n(HT20) 2462MHz (ANT 2)

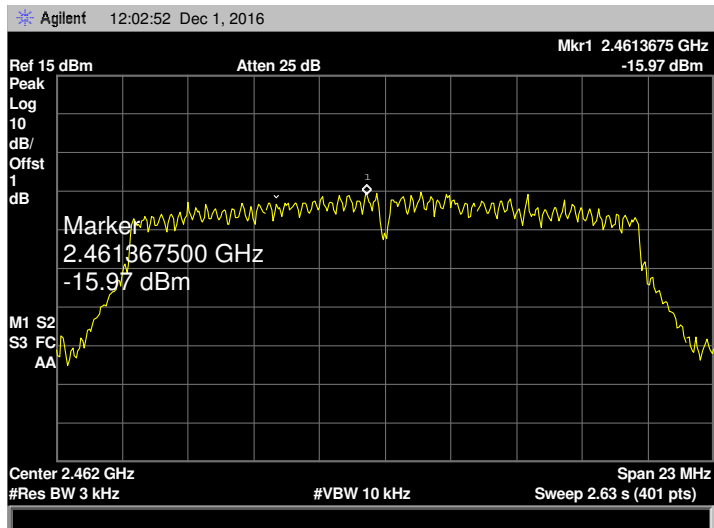

802.11 n(HT40) 2422 MHz (ANT 1)

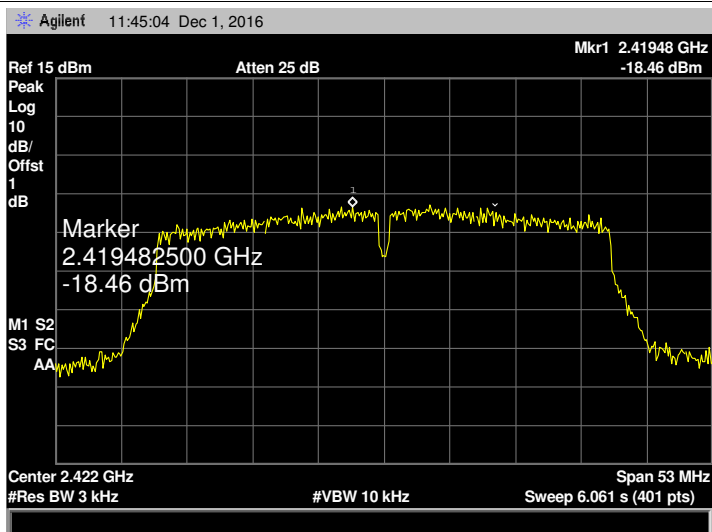

802.11 n(HT40) 2437 MHz (ANT 1)

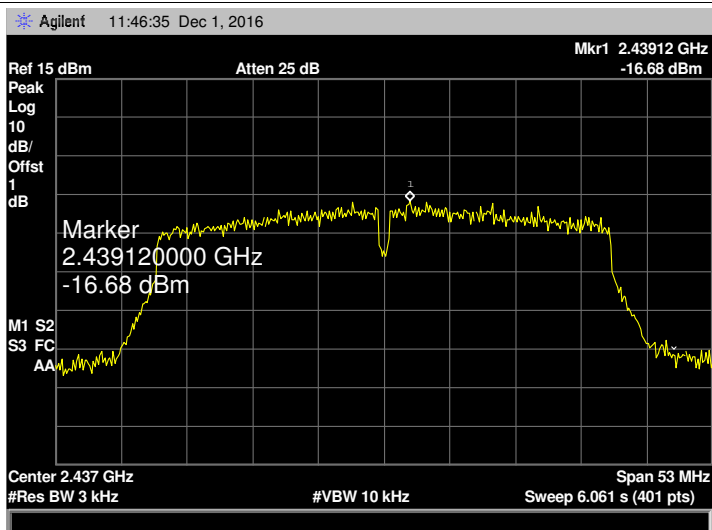

802.11 n(HT40) 2452MHz (ANT 1)

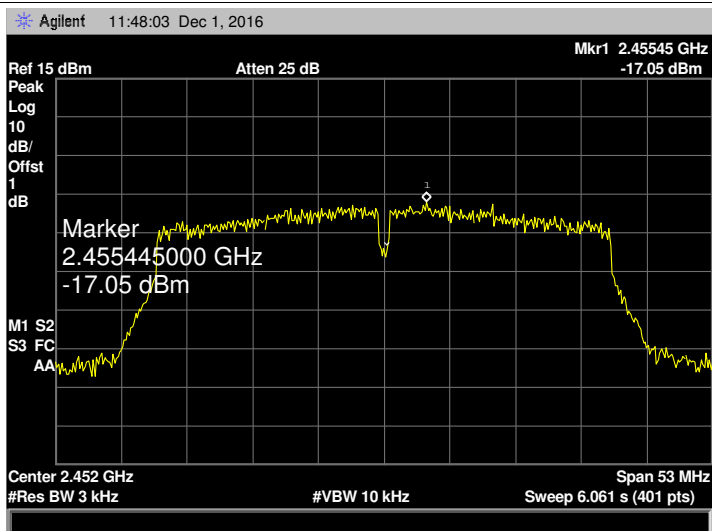

802.11 n(HT40) 2422 MHz (ANT 2)

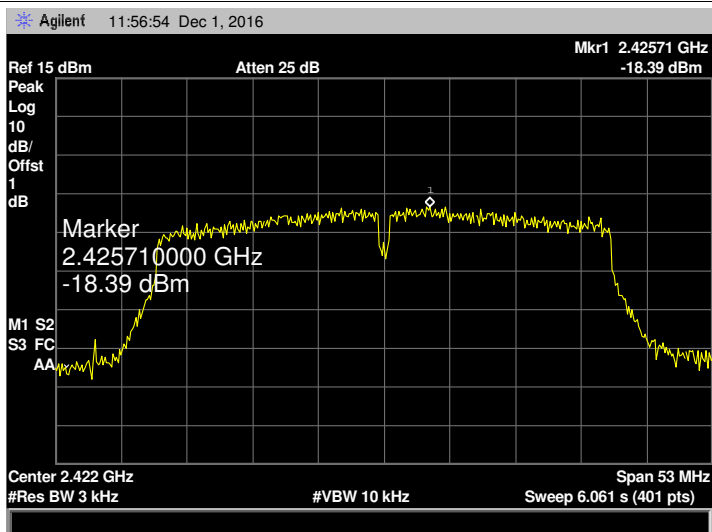

802.11 n(HT40) 2437 MHz (ANT 2)

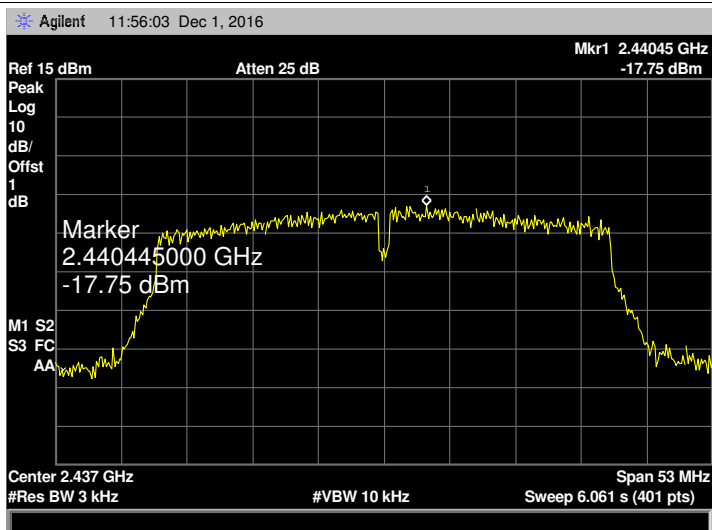

802.11 n(HT40) 2452MHz (ANT 2)

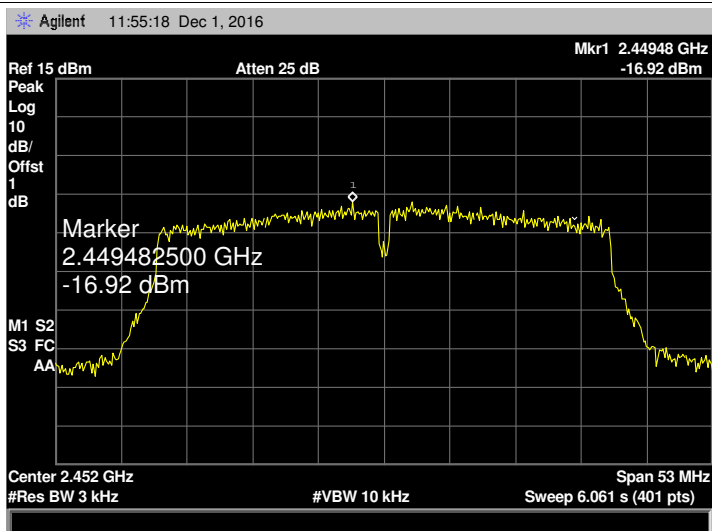

10. Antenna Requirement

10.1 Standard Requirement

10.1.1 Standard

FCC Part 15.203

10.1.2 Requirement

An intentional radiator shall be designed to ensure that no antenna other than that furnished by the responsible party shall be used with the device. The use of a permanently attached antenna or of an antenna that uses a unique coupling to the intentional radiator shall be considered sufficient to comply with the provisions of this Section. The manufacturer may design the unit so that a broken antenna can be replaced by the user, but the use of a standard antenna jack or electrical connector is prohibited.

10.2 Antenna Connected Construction

The directional gains of the antenna used for transmitting is 0 dBi, and the antenna de-signed with permanent attachment and no consideration of replacement. Please see the EUT photo for details.

Result

The EUT antenna is a PIFA Antenna. It complies with the standard requirement.

Antenna Type
<input type="checkbox"/> Permanent attached antenna
<input checked="" type="checkbox"/> Unique connector antenna
<input type="checkbox"/> Professional installation antenna

-----END OF REPORT-----