

FCC Test Report

Product Name : LoRa Module
Trade Name : Kiwi Technology Inc.
Model No. : TLM922S-P01A
FCC ID. : 2AKIBTLM922S

Applicant : Kiwi Technology Inc.
Address : 4F, No. 158, Sec. 1, Wenxing Rd., Zhubei City,
Hsinchu County, Taiwan

Date of Receipt : Jul. 19, 2017
Issued Date : Aug. 28, 2017
Report No. : 1770259R-RFUSP23V00
Report Version : V1.0



The test results relate only to the samples tested.

The test report shall not be reproduced except in full without the written approval of DEKRA Testing and Certification Co., Ltd.

Test Report Certification

Issued Date : Aug. 28, 2017

Report No. : 1770259R-RFUSP23V00



Product Name : LoRa Module

Applicant : Kiwi Technology Inc.

Address : 4F, No. 158, Sec. 1, Wenxing Rd., Zhubei City, Hsinchu County, Taiwan

Manufacturer : Kiwi Technology Inc.

Model No. : TLM922S-P01A

FCC ID. : 2AKIBTLM922S

EUT Voltage : DC 5V

Testing Voltage : DC 5V

Trade Name : Kiwi Technology Inc.

Applicable Standard : FCC CFR Title 47 Part 15 Subpart C Section 15.247: 2015
ANSI C63.10: 2013

Laboratory Name : Hsin Chu Laboratory

Address : No.372-2, Sec. 4, Zhongxing Rd., Zhudong Township, Hsinchu County 310, Taiwan, R.O.C.
TEL: +886-3-582-8001 / FAX: +886-3-582-8958

Test Result : Complied

Documented By : Lyla Yang
(Lyla Yang / Engineering Adm. Specialist)

Tested By : Scott Chang
(Scott Chang / Engineer)

Approved By : Roy Wang
(Roy Wang / Director)

Revision History

Report No.	Version	Description	Issued Date
1770259R-RFUSP23V00	V1.0	Initial issue of report	Aug. 28, 2017

Laboratory Information

We, **DEKRA Testing and Certification Co., Ltd.**, are an independent RF consultancy that was established the whole facility in our laboratories. The test facility has been accredited/accepted (audited or listed) by the following related bodies in compliance with ISO 17025 specified testing scopes:

Taiwan R.O.C. : TAF, Accreditation Number: 3024
USA : FCC, Registration Number: 0007939127
Canada : IC, Submission No: 181665 /
IC Registration Number: 22397-1 / 22397-2 / 22397-3

The related certificate for our laboratories about the test site and management system can be downloaded from DEKRA Testing and Certification Co., Ltd. Web Site :

<http://www.dekra.com.tw/english/about/certificates.aspx?bval=5>

The address and introduction of DEKRA Testing and Certification Co., Ltd. laboratories can be founded in our Web site : http://www.dekra.com.tw/index_en.aspx

If you have any comments, Please don't hesitate to contact us. Our test sites as below:

- 1 No. 75-2, 3rd Lin, WangYe Keng, Yonghxing Tsuen, Qionglin Shiang, Hsinchu County 307, Taiwan (R.O.C.)
TEL:+886-3-592-8858 / FAX:+886-3-592-8859 E-Mail : info.tw@dekra.com
- 2 No.372, Sec. 4, Zhongxing Rd., Zhudong Township, Hsinchu County 31061, Taiwan
TEL: +886-3-582-8001 / FAX: +886-3-582-8958 E-Mail : info.tw@dekra.com
- 3 No.372-2, Sec. 4, Zhongxing Rd., Zhudong Township, Hsinchu County 31061, Taiwan
TEL: +886-3-582-8001 / FAX: +886-3-582-8958 E-Mail : info.tw@dekra.com

TABLE OF CONTENTS

Description	Page
1. General Information.....	7
1.1. EUT Description	7
1.2. Test Mode	8
1.3. Tested System Details	9
1.4. Configuration of tested System	9
1.5. EUT Exercise Software	9
1.6. Test Facility.....	10
2. Conducted Emission	11
2.1. Test Equipment.....	11
2.2. Test Setup	11
2.3. Limits	12
2.4. Test Procedure	12
2.5. Test Specification.....	12
2.6. Uncertainty	12
2.7. Test Result.....	13
3. Peak Power Output	14
3.1. Test Equipment.....	14
3.2. Test Setup	14
3.3. Test procedures	15
3.4. Limits	15
3.5. Test Specification.....	15
3.6. Test Result.....	16
4. Radiated Emission	17
4.1. Test Equipment.....	17
4.2. Test Setup	17
4.3. Limits	18
4.4. Test Procedure	18
4.5. Test Specification.....	18
4.6. Test Result.....	19
5. RF antenna conducted test	37
5.1. Test Equipment.....	37
5.2. Test Setup	37
5.3. Limits	38
5.4. Test Procedure	38
5.5. Test Specification.....	38
5.6. Test Result.....	39
6. Band Edge.....	43
6.1. Test Equipment.....	43
6.2. Test Setup	43
6.3. Limits	43
6.4. Test Procedure	44

6.5.	Test Specification.....	44
6.6.	Test Result.....	45
7.	Number of hopping frequency	61
7.1.	Test Equipment.....	61
7.2.	Test Setup	61
7.3.	Limits	62
7.4.	Test Procedures	62
7.5.	Test Specification.....	62
7.6.	Test Result.....	63
8.	Carrier Frequency Separation	64
8.1.	Test Equipment.....	64
8.2.	Test Setup	64
8.3.	Limits	64
8.4.	Test Procedures	65
8.5.	Test Specification.....	65
8.6.	Test Result.....	66
9.	Occupied Bandwidth	68
9.1.	Test Equipment.....	68
9.2.	Test Setup	68
9.3.	Limits	69
9.4.	Test Procedures	69
9.5.	Test Specification.....	69
9.6.	Test Result.....	70
10.	Dwell Time.....	72
10.1.	Test Equipment.....	72
10.2.	Test Setup	72
10.3.	Limits	73
10.4.	Test Procedures	73
10.5.	Test Specification.....	73
10.6.	Test Result.....	74
Attachment 1		77
	Test Setup Photograph	77
Attachment 2		81
	EUT External Photograph.....	81
Attachment 3		85
	EUT Internal Photograph.....	85

1. General Information

1.1. EUT Description

Product Name	LoRa Module
Trade Name	Kiwi Technology Inc.
Model No.	TLM922S-P01A
Frequency Range	902.3~914.9MHz
Channel Number	64 Channels
Type of Modulation	FHSS

Antenna Information			
Manufacturer	Part No.	Antenna Type	Peak Gain
1. ARISTOTLE	RFA-WAVE-C55-U-B70	Dipole Antenna	2dBi
2. GSC Technology Corp	SP-12G0228GT01-03	Omni Fiberglass Antenna	8dBi

Working Frequency of Each Channel							
Channel	Frequency	Channel	Frequency	Channel	Frequency	Channel	Frequency
Channel 00	902.3 MHz	Channel 16	905.5 MHz	Channel 32	908.7 MHz	Channel 48	911.9 MHz
Channel 01	902.5 MHz	Channel 17	905.7 MHz	Channel 33	908.9 MHz	Channel 49	912.1 MHz
Channel 02	902.7 MHz	Channel 18	905.9 MHz	Channel 34	909.1 MHz	Channel 50	912.3 MHz
Channel 03	902.9 MHz	Channel 19	906.1 MHz	Channel 35	909.3 MHz	Channel 51	912.5 MHz
Channel 04	903.1MHz	Channel 20	906.3 MHz	Channel 36	909.5 MHz	Channel 52	912.7 MHz
Channel 05	903.3 MHz	Channel 21	906.5 MHz	Channel 37	909.7 MHz	Channel 53	912.9 MHz
Channel 06	903.5 MHz	Channel 22	906.7 MHz	Channel 38	909.9 MHz	Channel 54	913.1 MHz
Channel 07	903.7 MHz	Channel 23	906.9 MHz	Channel 39	910.1 MHz	Channel 55	913.3 MHz
Channel 08	903.9 MHz	Channel 24	907.1 MHz	Channel 40	910.3 MHz	Channel 56	913.5 MHz
Channel 09	904.1 MHz	Channel 25	907.3 MHz	Channel 41	910.5 MHz	Channel 57	913.7 MHz
Channel 10	904.3 MHz	Channel 26	907.5 MHz	Channel 42	910.7 MHz	Channel 58	913.9 MHz
Channel 11	904.5 MHz	Channel 27	907.7 MHz	Channel 43	910.9 MHz	Channel 59	914.1 MHz
Channel 12	904.7 MHz	Channel 28	907.9 MHz	Channel 44	911.1 MHz	Channel 60	914.3 MHz
Channel 13	904.9 MHz	Channel 29	908.1 MHz	Channel 45	911.3 MHz	Channel 61	914.5 MHz
Channel 14	905.1 MHz	Channel 30	908.3 MHz	Channel 46	911.5 MHz	Channel 62	914.7 MHz
Channel 15	905.3 MHz	Channel 31	908.5 MHz	Channel 47	911.7 MHz	Channel 63	914.9 MHz

Note:

1. This device is a LoRa Module including 902.3~914.9 MHz transmitting.
2. Regards to the frequency band operation; the lowest 、 middle and highest frequency of channel were selected to perform the test, and then shown on this report.
3. This device is module.

1.2. Test Mode

DEKRA has verified the construction and function in typical operation. All the test modes were carried out with the EUT in transmitting operation, which was shown in this test report and defined as follows:

Test Mode	
TX	Mode 1: Tx_ANT1 Mode 2: Tx_ANT2

Emission	Mode 1	Mode 2
Conducted Emission	No	No
Peak Power Output	Yes	No
Radiated Emission	Yes	Yes
RF antenna conducted test	Yes	No
Band Edge	Yes	Yes
Number of hopping Frequency	Yes	No
Carrier Frequency Separation	Yes	No
Occupied Bandwidth	Yes	No
Dwell Time	Yes	No

1.3. Tested System Details

The types for all equipment, plus descriptions of all cables used in the tested system (including inserted cards) are:

Product	Manufacturer	Model No.	Serial No.	FCC ID	Power Cord
1. Notebook PC	ACER	MS2296	LUSCV021391 150332C2000	DoC	Non-Shielded, 2.5m one ferrite core bonded.

1.4. Configuration of tested System

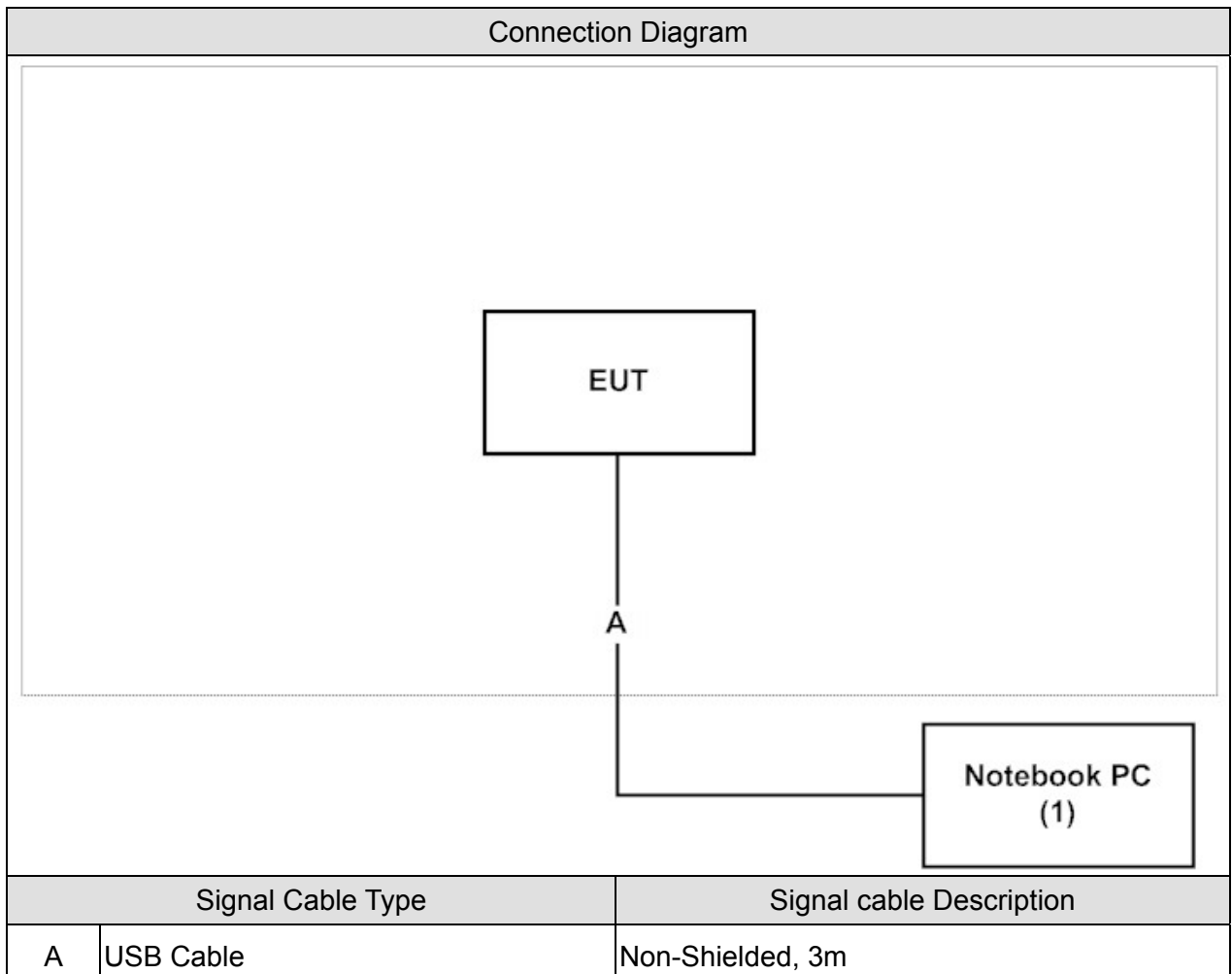

1.5. EUT Exercise Software

1	Setup the EUT as shown in Section 1.4.
2	Execute the test program “Kiwi –tec TML922S FCC test Program”.
3	Configure the test mode, the test channel, and the data rate.
4	Press “Start TX” to start the continuous transmitting.
5	Verify that the EUT works properly.

1.6. Test Facility

Ambient conditions in the laboratory:

Items	Test Item	Required (IEC 68-1)	Actual	Test Site
Temperature (°C)	FCC PART 15 C 15.207 Conducted Emission (FHSS)	15 - 35	23	--
Humidity (%RH)		25 - 75	50	
Barometric pressure (mbar)		860 - 1060	950-1000	
Temperature (°C)	FCC PART 15 C 15.247 Peak Power Output (FHSS)	15 - 35	24	3
Humidity (%RH)		25 - 75	45	
Barometric pressure (mbar)		860 - 1060	950-1000	
Temperature (°C)	FCC PART 15 C 15.247 Radiated Emission (FHSS)	15 - 35	25	2
Humidity (%RH)		25 - 75	54	
Barometric pressure (mbar)		860 - 1060	950-1000	
Temperature (°C)	FCC PART 15 C 15.247 Band Edge (FHSS)	15 - 35	25	2
Humidity (%RH)		25 - 75	50	
Barometric pressure (mbar)		860 - 1060	950-1000	
Temperature (°C)	FCC PART 15 C 15.247 Number of hopping Frequency (FHSS)	15 - 35	24	3
Humidity (%RH)		25 - 75	45	
Barometric pressure (mbar)		860 - 1060	950-1000	
Temperature (°C)	FCC PART 15 C 15.247 Carrier Frequency Separation (FHSS)	15 - 35	24	3
Humidity (%RH)		25 - 75	45	
Barometric pressure (mbar)		860 - 1060	950-1000	
Temperature (°C)	FCC PART 15 C 15.247 Occupied Bandwidth (FHSS)	15 - 35	24	3
Humidity (%RH)		25 - 75	45	
Barometric pressure (mbar)		860 - 1060	950-1000	
Temperature (°C)	FCC PART 15 C 15.247 RF antenna conducted test (FHSS)	15 - 35	24	3
Humidity (%RH)		25 - 75	45	
Barometric pressure (mbar)		860 - 1060	950-1000	
Temperature (°C)	FCC PART 15 C 15.247 Dwell Time (FHSS)	15 - 35	24	3
Humidity (%RH)		25 - 75	45	
Barometric pressure (mbar)		860 - 1060	950-1000	

Note: Test Site information refers to Laboratory Information.

2. Conducted Emission

2.1. Test Equipment

The following test equipment are used during the test:

Conducted Emission / SR2-H

Instrument	Manufacturer	Model No.	Serial No.	Cal. Date	Next Cal. Date
Artificial Mains Network	R&S	ENV4200	848411/010	2017/02/06	2018/02/05
Test Receiver	R&S	ESCS 30	836858/022	2017/04/12	2018/04/11
LISN	R&S	ENV216	100092	2017/07/31	2018/07/30

2.2. Test Setup

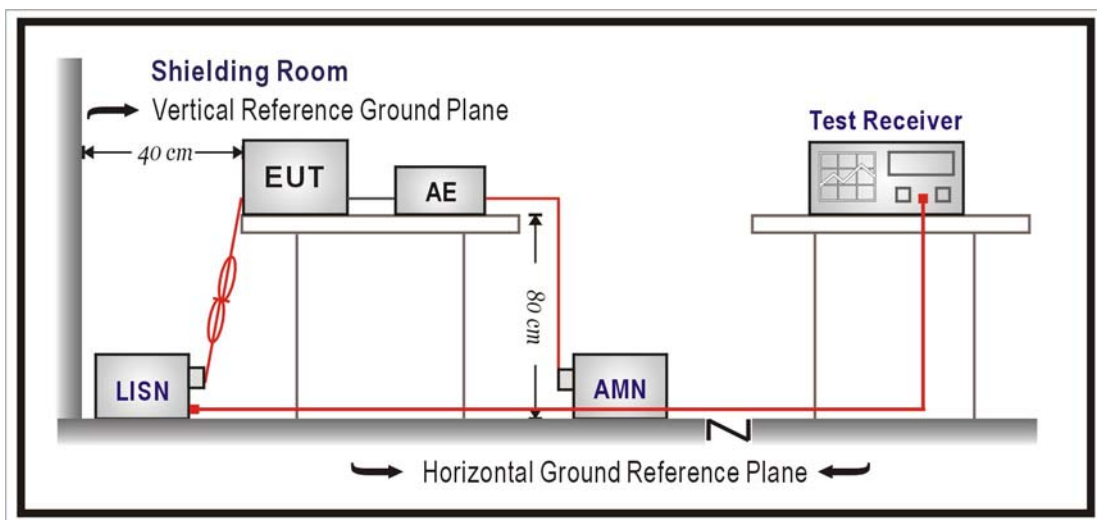

2.3. Limits

FCC Part 15 Subpart C Paragraph 15.207 Limits (dBuV)		
Frequency MHz	QP	AV
0.15 - 0.50	66 - 56	56 - 46
0.50 - 5.0	56	46
5.0 - 30	60	50

Remarks: In the above table, the tighter limit applies at the band edges.

2.4. Test Procedure

The EUT and simulators are connected to the main power through a line impedance stabilization network (L.I.S.N.). This provides a 50 ohm /50uH coupling impedance for the measuring equipment. The peripheral devices are also connected to the main power through a LISN that provides a 50ohm /50uH coupling impedance with 50ohm termination. (Please refer to the block diagram of the test setup and photographs.)

Both sides of A.C. line are checked for maximum conducted interference. In order to find the maximum emission, the relative positions of equipment and all of the interface cables must be changed according to ANSI C63.10:2009 on conducted measurement.

Conducted emissions were investigated over the frequency range from 0.15MHz to 30MHz using a receiver bandwidth of 9 kHz.

2.5. Test Specification

According to FCC Part 15 Subpart C Paragraph 15.207: 2015

2.6. Uncertainty

The measurement uncertainty is defined as ± 2.26 dB.

2.7. Test Result

This device is module, Don't need test.

3. Peak Power Output

3.1. Test Equipment

The following test equipment is used during the test:

Peak Power Output / SR10-H

Instrument	Manufacturer	Model No.	Serial No.	Cal. Date	Next Cal. Date
High Speed Peak Power Meter Dual Input	Anritsu	ML2496A	1602004	2017/01/20	2018/01/19
Pulse Power Sensor	Anritsu	MA2411B	1531043	2017/01/20	2018/01/19
Pulse Power Sensor	Anritsu	MA2411B	1531044	2017/01/20	2018/01/19

3.2. Test Setup

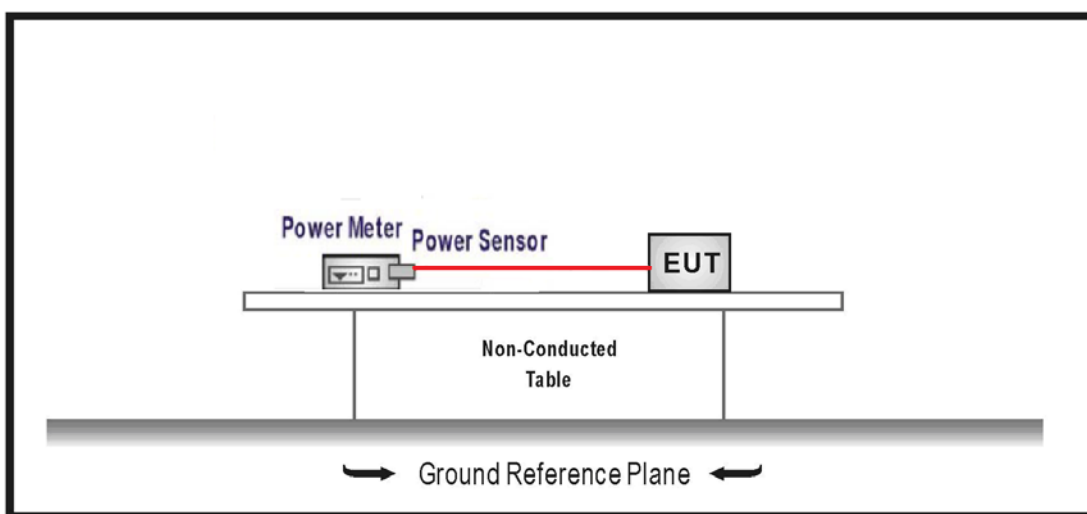

3.3. Test procedures

The EUT was setup according to ANSI C63.10:2013 and tested according to FHSS test procedure of FCC Public Notice DA 00-705 for compliance to FCC 47CFR 15.247 requirements

3.4. Limits

For frequency hopping systems operating in the 902-928 MHz band: 1 Watt for systems employing at least 50 hopping channels; and, 0.25 Watts for systems employing less than 50 hopping channels.

For frequency hopping systems in the 2400-2483.5 MHz band employing at least 75 hopping channels, and all frequency hopping systems in the 5725-5850 MHz band: 1Watt.

For all other frequency hopping systems in the 2400-2483.5 MHz band: 0.125 Watt.

3.5. Test Specification

According to FCC Part 15 Subpart C Paragraph 15.247: 2015.

3.6. Test Result

Product	LoRa Module		
Test Item	Peak Power Output		
Test Mode	Mode 1: Tx_ANT1		
Date of Test	2017/03/21	Test Site	SR10-H

Frequency (MHz)	Measure Level (dBm)	Limit (dBm)	Result
902.3	19.15	30	Pass
908.5	19.17	30	Pass
914.9	19.13	30	Pass

4. Radiated Emission

4.1. Test Equipment

The following test equipment are used during the test:

Radiated Emission / CB4-H

Instrument	Manufacturer	Model No.	Serial No.	Cal. Date	Next Cal. Date
Signal Analyzer	R&S	FSVA40	101455	2016/11/28	2017/11/27
Signal & Spectrum Analyzer	R&S	FSV40	101049	2017/01/23	2018/01/22
EXA Signal Analyzer	Keysight	N9010A	MY51440132	2017/03/13	2018/03/12
Bilog Antenna	Teseq	CBL6112D	23191	2017/06/28	2018/06/27 </td
Horn Antenna	Schwarzbeck	BBHA 9120D	639	2017/06/14	2018/06/13
Horn Antenna	Schwarzbeck	BBHA 9170	203	2016/08/29	2017/08/28
Pre-Amplifier	RF Bay Inc.	LNA-1330	12162511	2017/03/09	2018/03/08
Pre-Amplifier	EMCI	EMCI 1830I	980366	2017/01/23	2018/01/22
Pre-Amplifier	MITEQ	JS44-45-8P	2014754	2016/12/26	2017/12/25

4.2. Test Setup

Under 1GHz Test Setup:

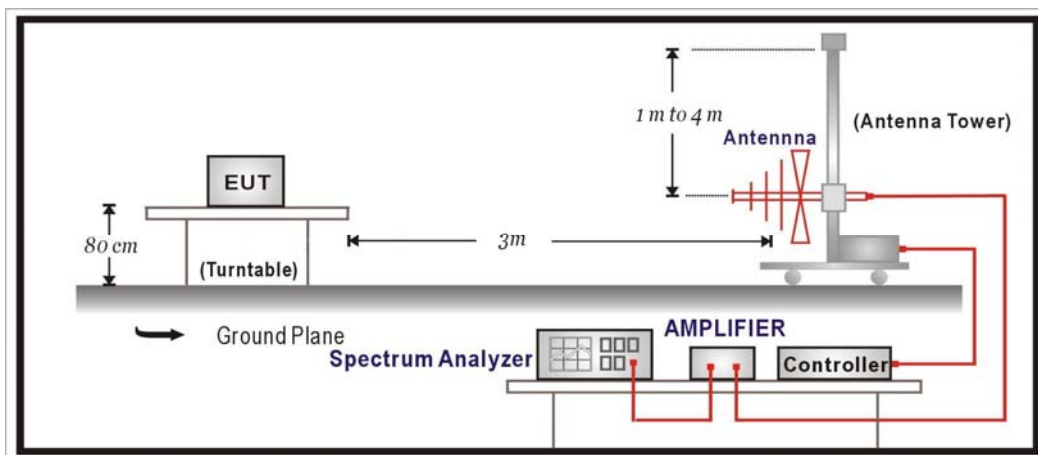

Above 1GHz Test Setup:

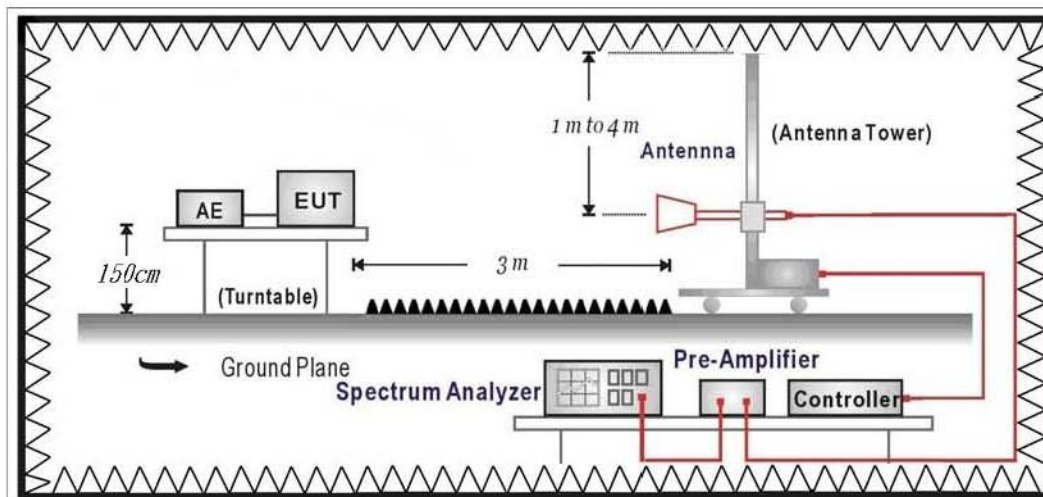

4.3. Limits

Emissions radiated outside of the specified frequency bands, except for harmonics, shall be attenuated by at least 20dB below the level of the fundamental or to the general radiated emission limits in paragraph 15.209, whichever is the lesser attenuation.

FCC Part 15 Subpart C Paragraph 15.209 Limits		
Frequency MHz	uV/m	dBuV/m
30 - 88	100	40
88 - 216	150	43.5
216 - 960	200	46
Above 960	500	54

Remarks : 1. RF Voltage (dBuV) = 20 log RF Voltage (uV)

2. In the Above Table, the tighter limit applies at the band edges.

3. Distance refers to the distance in meters between the measuring instrument antenna and the closed point of any part of the device or system.

4.4. Test Procedure

The EUT was setup according to ANSI C63.10:2013 and tested according to FHSS test procedure of FCC Public Notice DA 00-705 for compliance to FCC 47CFR 15.247 requirements.

The EUT and its simulators are placed on a turn table which is 0.8 or 1.5 meter above ground. The turn table can rotate 360 degrees to determine the position of the maximum emission level.

The antenna can move up and down between 1 meter and 4 meters to find out the maximum emission level.

Both horizontal and vertical polarization of the antenna are set on measurement. In order to find the maximum emission, all of the interface cables must be manipulated according to ANSI C63.10:2013 on radiated measurement.

On any frequency or frequencies below or equal to 1000 MHz, the limits shown are based on measuring equipment employing a quasi-peak detector function and on any frequency or frequencies above 1000 MHz the radiated limits shown are based upon the use of measurement instrumentation employing an average detector function. When average radiated emission measurement are included emission measurement below 1000 MHz, there also is a limit on the radio frequency emissions, as measured using instrumentation with a peak detector function, corresponding to 20 dB above the maximum permitted average limit. The bandwidth below 1GHz setting on the field strength meter is 120 kHz and above 1GHz is 1MHz.

4.5. Test Specification

According to FCC Part 15 Subpart C Paragraph 15.247: 2015

4.6. Test Result

30MHz-1GHz Spurious

Site : CB4-H	Time : 2017/08/09
Limit : FCC_CLASS_B_03M_QP	Margin : 6
Probe : CB4_FCC_EFS_S2_30M-1GHz_1116 - HORIZONTAL	Power : DC 5V
EUT : LoRa Module	Note : Mode 1: Tx_ANT1_908.5MHz

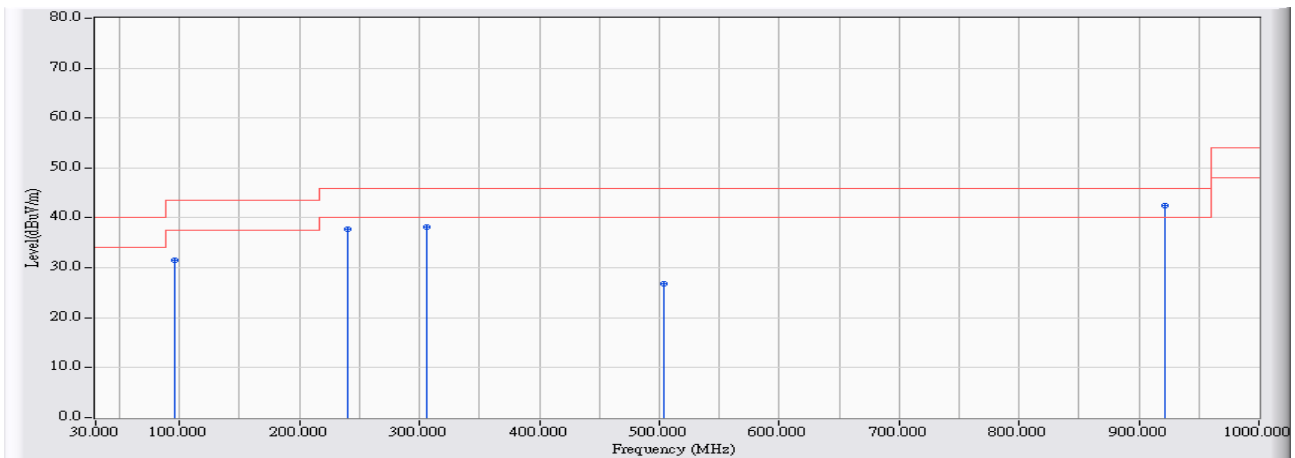

	Frequency (MHz)	Correct Factor (dB)	Reading Level (dBuV)	Measure Level (dBuV/m)	Margin (dB)	Limit (dBuV/m)	Detector Type
1	96.147	-23.166	54.748	31.582	-11.918	43.500	QUASPEAK
2	239.887	-21.344	59.136	37.792	-8.208	46.000	QUASPEAK
3	306.519	-19.861	58.053	38.192	-7.808	46.000	QUASPEAK
4	503.895	-15.355	42.192	26.837	-19.163	46.000	QUASPEAK
5	* 921.050	-10.885	53.297	42.411	-3.589	46.000	QUASPEAK

Note:

1. All Reading Levels are Quasi-Peak value.
2. “ * ”, means this data is the worst emission level.
3. Measurement Level = Reading Level + Correct Factor

Site : CB4-H	Time : 2017/08/09
Limit : FCC_CLASS_B_03M_QP	Margin : 6
Probe : CB4_FCC_EFS_S2_30M-1GHz_1116 - VERTICAL	Power : DC 5V
EUT : LoRa Module	Note : Mode 1: Tx_ANT1_908.5MHz

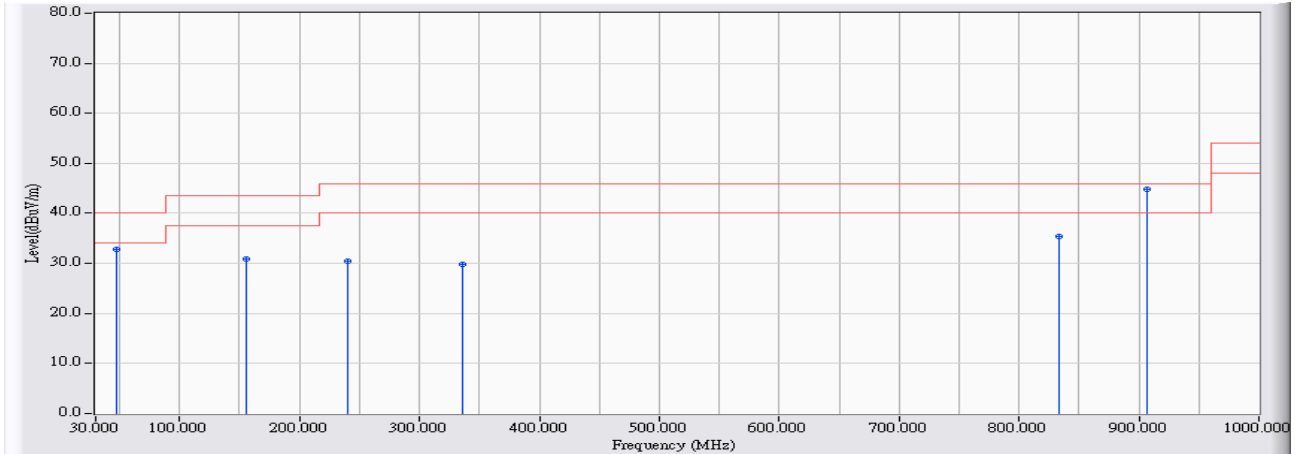

	Frequency (MHz)	Correct Factor (dB)	Reading Level (dBuV)	Measure Level (dBuV/m)	Margin (dB)	Limit (dBuV/m)	Detector Type
1	47.749	-20.987	53.712	32.725	-7.275	40.000	QUASPEAK
2	155.893	-22.302	53.221	30.919	-12.581	43.500	QUASPEAK
3	239.887	-21.344	51.763	30.419	-15.581	46.000	QUASPEAK
4	335.907	-19.147	48.859	29.713	-16.287	46.000	QUASPEAK
5	833.953	-11.895	47.275	35.379	-10.621	46.000	QUASPEAK
6	* 906.210	-11.064	55.793	44.728	-1.272	46.000	QUASPEAK

Note:

1. All Reading Levels are Quasi-Peak value.
2. “ * ”, means this data is the worst emission level.
3. Measurement Level = Reading Level + Correct Factor

Site : CB4-H	Time : 2017/08/09
Limit : FCC_CLASS_B_03M_QP	Margin : 6
Probe : CB4_FCC_EFS_S2_30M-1GHz_1116 - HORIZONTAL	Power : DC 5V
EUT : LoRa Module	Note : Mode 2: Tx_ANT2_908.5MHz

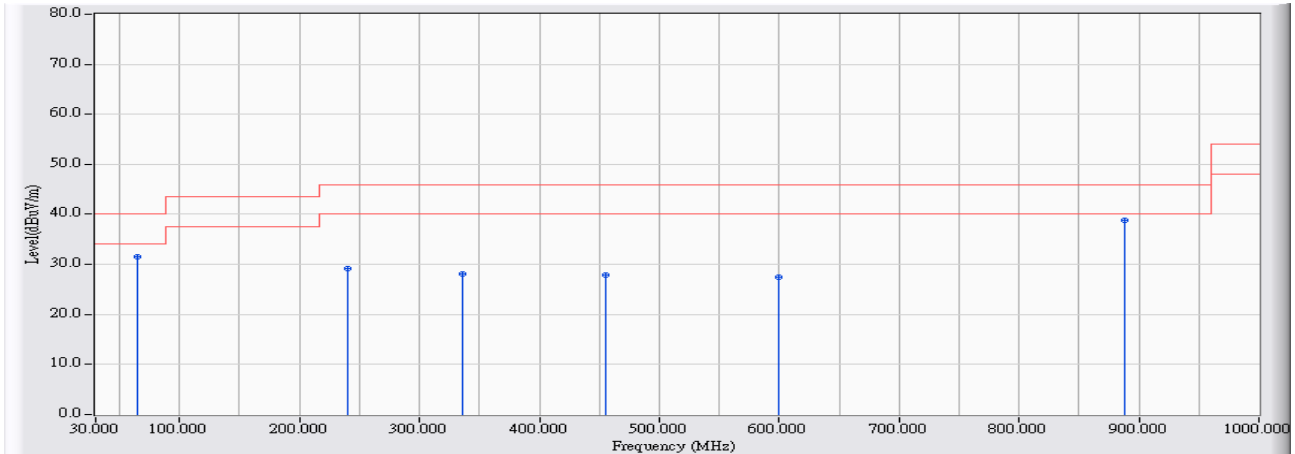

	Frequency (MHz)	Correct Factor (dB)	Reading Level (dBuV)	Measure Level (dBuV/m)	Margin (dB)	Limit (dBuV/m)	Detector Type
1	64.723	-24.671	56.299	31.628	-8.372	40.000	QUASIPeAK
2	239.887	-21.344	50.514	29.170	-16.830	46.000	QUASIPeAK
3	335.907	-19.147	47.292	28.146	-17.854	46.000	QUASIPeAK
4	455.205	-16.269	44.161	27.892	-18.108	46.000	QUASIPeAK
5	599.915	-14.335	41.852	27.516	-18.484	46.000	QUASIPeAK
6	* 888.073	-11.281	50.202	38.921	-7.079	46.000	QUASIPeAK

Note:

1. All Reading Levels are Quasi-Peak value.
2. “ * ”, means this data is the worst emission level.
3. Measurement Level = Reading Level + Correct Factor

Site : CB4-H	Time : 2017/08/09
Limit : FCC_CLASS_B_03M_QP	Margin : 6
Probe : CB4_FCC_EFS_S2_30M-1GHz_1116 - VERTICAL	Power : DC 5V
EUT : LoRa Module	Note : Mode 2: Tx_ANT2_908.5MHz

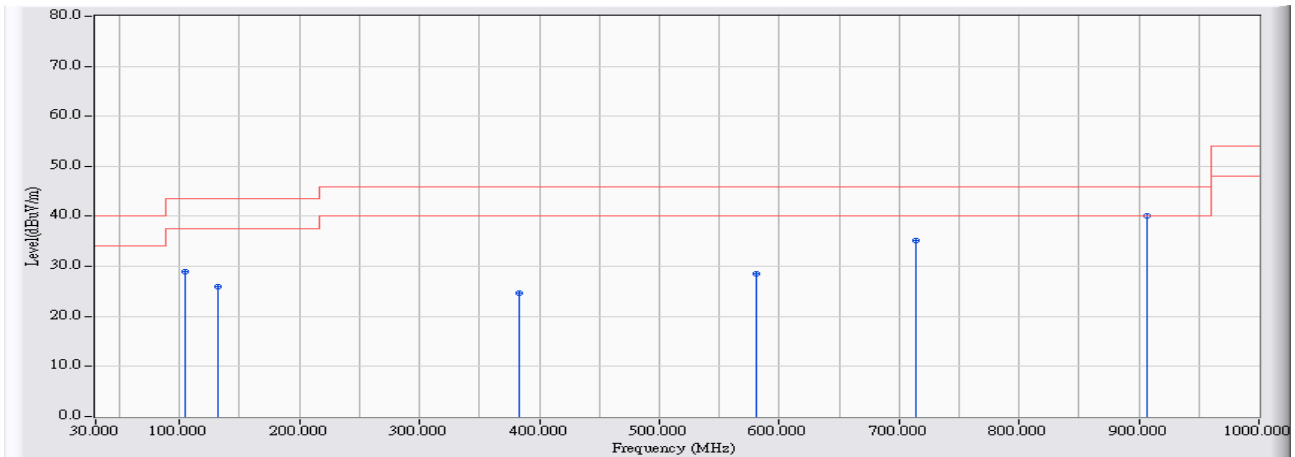

	Frequency (MHz)	Correct Factor (dB)	Reading Level (dBuV)	Measure Level (dBuV/m)	Margin (dB)	Limit (dBuV/m)	Detector Type
1	104.683	-21.960	50.979	29.018	-14.482	43.500	QUASPEAK
2	131.840	-21.268	47.179	25.910	-17.590	43.500	QUASPEAK
3	382.948	-17.783	42.346	24.562	-21.438	46.000	QUASPEAK
4	580.808	-14.563	43.192	28.629	-17.371	46.000	QUASPEAK
5	713.685	-13.283	48.418	35.136	-10.864	46.000	QUASPEAK
6	* 906.792	-11.065	51.100	40.034	-5.966	46.000	QUASPEAK

Note:

1. All Reading Levels are Quasi-Peak value.
2. “ * ”, means this data is the worst emission level.
3. Measurement Level = Reading Level + Correct Factor

Harmonic & Spurious:

Site : CB4-H	Time : 2017/08/04
Limit : FCC_SpartC_15.209_03M_PK	Margin : 6
Probe : CB4_FCC_A115_EFS_1-18GHz_1116 - HORIZONTAL	Power : DC 5V
EUT : LoRa Module	Note : Mode 1: Tx_ANT1_902.3MHz

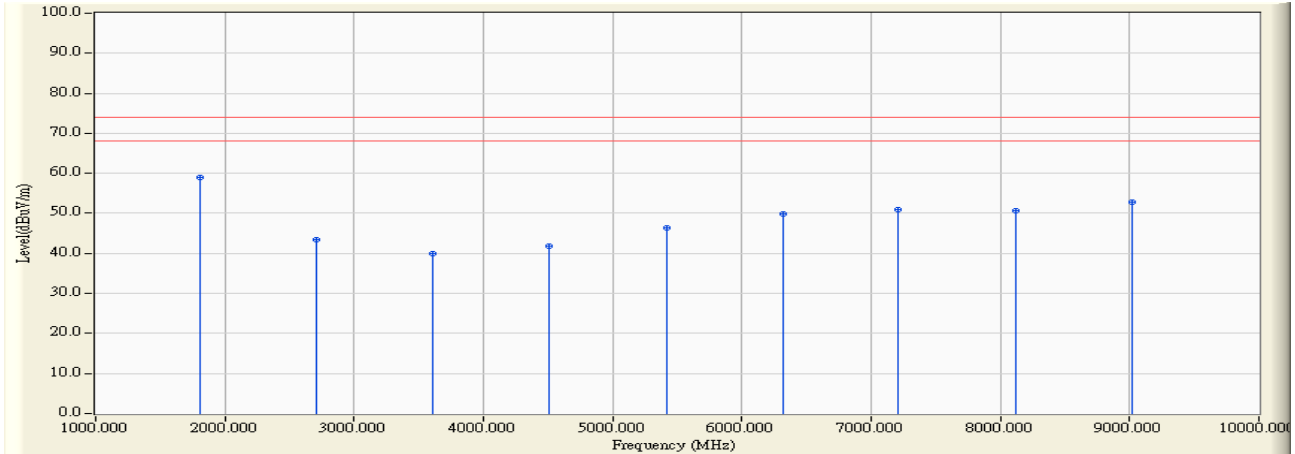

		Frequency (MHz)	Correct Factor (dB)	Reading Level (dBuV)	Measure Level (dBuV/m)	Margin (dB)	Limit (dBuV/m)	Detector Type
1	*	1804.420	-3.151	62.010	58.859	-15.141	74.000	PEAK
2		2706.720	0.834	42.730	43.564	-30.436	74.000	PEAK
3		3609.500	3.316	36.710	40.026	-33.974	74.000	PEAK
4		4510.120	6.802	34.910	41.713	-32.287	74.000	PEAK
5		5413.970	9.619	36.860	46.478	-27.522	74.000	PEAK
6		6316.140	14.129	35.730	49.859	-24.141	74.000	PEAK
7		7208.630	17.864	33.030	50.895	-23.105	74.000	PEAK
8		8122.720	19.458	31.250	50.708	-23.292	74.000	PEAK
9		9022.770	21.208	31.700	52.908	-21.092	74.000	PEAK

Note:

1. All Readings below 1GHz are Quasi-Peak, above 1GHz are performed with peak and/or average measurements as necessary.
2. Peak measurements: RBW = 1MHz, VBW = 1MHz, Sweep: Auto.
3. Average measurements: RBW = 1MHz, VBW = 10 Hz, Sweep: Auto.
4. “ * ”, means this data is the worst emission level.
5. “ # ”, means the frequency is out of the restricted band.
6. Measurement Level = Reading Level + Correct Factor.
7. The average measurement was not performed when the peak measured data under the limit of average detection.

Site : CB4-H	Time : 2017/08/04
Limit : FCC_SpartC_15.209_03M_PK	Margin : 6
Probe : CB4_FCC_A115_EFS_1-18GHz_1116 - VERTICAL	Power : DC 5V
EUT : LoRa Module	Note : Mode 1: Tx_ANT1_902.3MHz

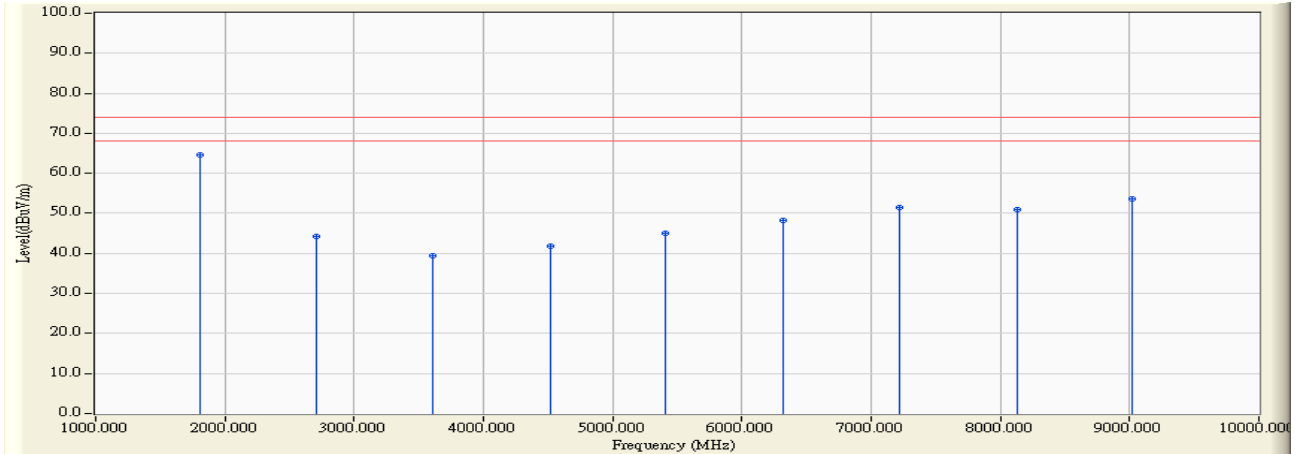

		Frequency (MHz)	Correct Factor (dB)	Reading Level (dBuV)	Measure Level (dBuV/m)	Margin (dB)	Limit (dBuV/m)	Detector Type
1	*	1804.370	-3.151	67.830	64.679	-9.321	74.000	PEAK
2		2706.850	0.834	43.530	44.365	-29.635	74.000	PEAK
3		3611.320	3.323	36.140	39.462	-34.538	74.000	PEAK
4		4516.470	6.836	34.950	41.785	-32.215	74.000	PEAK
5		5413.460	9.617	35.420	45.037	-28.963	74.000	PEAK
6		6316.330	14.130	34.150	48.280	-25.720	74.000	PEAK
7		7218.480	17.890	33.670	51.561	-22.439	74.000	PEAK
8		8126.720	19.465	31.580	51.046	-22.954	74.000	PEAK
9		9022.500	21.207	32.530	53.738	-20.262	74.000	PEAK

Note:

1. All Readings below 1GHz are Quasi-Peak, above 1GHz are performed with peak and/or average measurements as necessary.
2. Peak measurements: RBW = 1MHz, VBW = 1MHz, Sweep: Auto.
3. Average measurements: RBW = 1MHz, VBW = 10 Hz, Sweep: Auto.
4. “ * ”, means this data is the worst emission level.
5. “ # ”, means the frequency is out of the restricted band.
6. Measurement Level = Reading Level + Correct Factor.
7. The average measurement was not performed when the peak measured data under the limit of average detection.

Site : CB4-H	Time : 2017/08/04
Limit : FCC_SpartC_15.209_03M_PK	Margin : 6
Probe : CB4_FCC_A115_EFS_1-18GHz_1116 - HORIZONTAL	Power : DC 5V
EUT : LoRa Module	Note : Mode 1: Tx_ANT1_908.5MHz

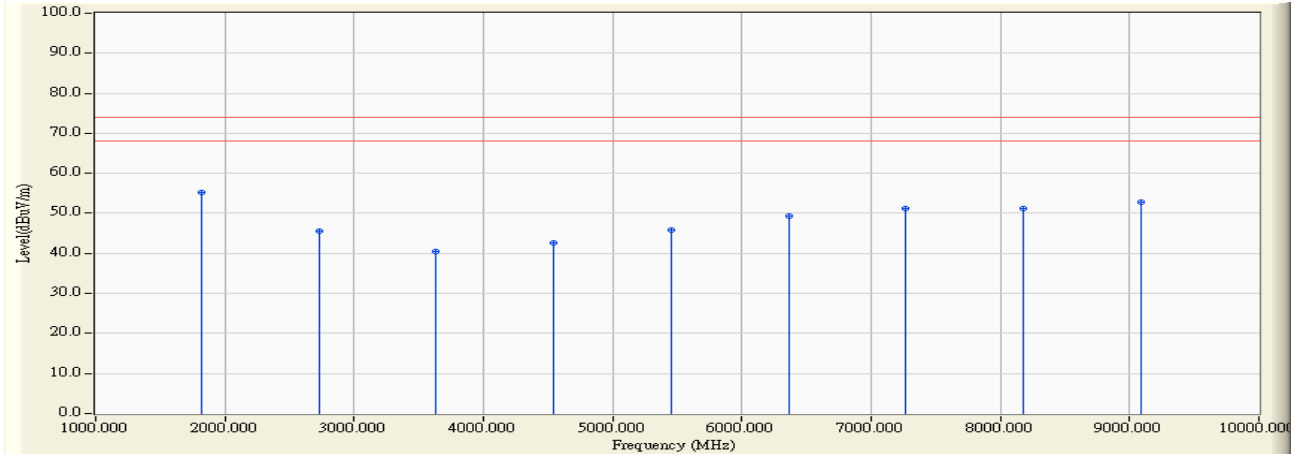

		Frequency (MHz)	Correct Factor (dB)	Reading Level (dBuV)	Measure Level (dBuV/m)	Margin (dB)	Limit (dBuV/m)	Detector Type
1	*	1816.880	-3.110	58.340	55.230	-18.770	74.000	PEAK
2		2725.400	0.907	44.750	45.657	-28.343	74.000	PEAK
3		3625.840	3.371	36.978	40.349	-33.651	74.000	PEAK
4		4541.920	6.962	35.750	42.712	-31.288	74.000	PEAK
5		5450.970	9.645	36.220	45.866	-28.134	74.000	PEAK
6		6359.750	14.473	34.960	49.433	-24.567	74.000	PEAK
7		7267.540	18.010	33.330	51.340	-22.660	74.000	PEAK
8		8176.300	19.557	31.720	51.277	-22.723	74.000	PEAK
9		9084.800	21.267	31.520	52.787	-21.213	74.000	PEAK

Note:

1. All Readings below 1GHz are Quasi-Peak, above 1GHz are performed with peak and/or average measurements as necessary.
2. Peak measurements: RBW = 1MHz, VBW = 1MHz, Sweep: Auto.
3. Average measurements: RBW = 1MHz, VBW = 10 Hz, Sweep: Auto.
4. “ * ”, means this data is the worst emission level.
5. “ # ”, means the frequency is out of the restricted band.
6. Measurement Level = Reading Level + Correct Factor.
7. The average measurement was not performed when the peak measured data under the limit of average detection.

Site : CB4-H	Time : 2017/08/04
Limit : FCC_SpartC_15.209_03M_PK	Margin : 6
Probe : CB4_FCC_A115_EFS_1-18GHz_1116 - VERTICAL	Power : DC 5V
EUT : LoRa Module	Note : Mode 1: Tx_ANT1_908.5MHz

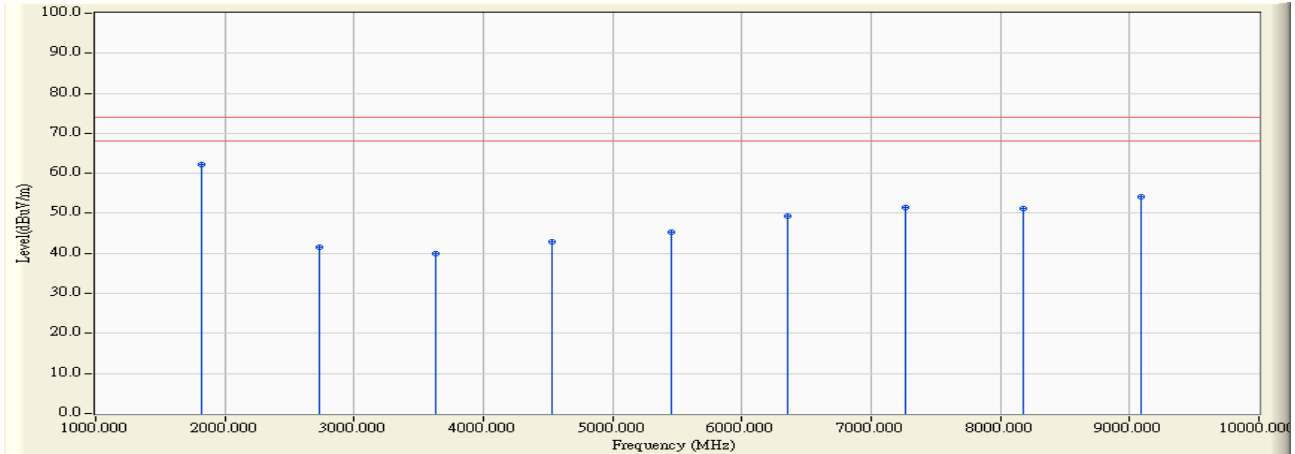

		Frequency (MHz)	Correct Factor (dB)	Reading Level (dBuV)	Measure Level (dBuV/m)	Margin (dB)	Limit (dBuV/m)	Detector Type
1	*	1816.820	-3.110	65.240	62.130	-11.870	74.000	PEAK
2		2725.320	0.907	40.580	41.487	-32.513	74.000	PEAK
3		3632.040	3.391	36.600	39.991	-34.009	74.000	PEAK
4		4535.160	6.930	35.890	42.819	-31.181	74.000	PEAK
5		5450.960	9.645	35.730	45.376	-28.624	74.000	PEAK
6		6359.500	14.471	34.890	49.361	-24.639	74.000	PEAK
7		7267.880	18.010	33.330	51.341	-22.659	74.000	PEAK
8		8176.300	19.557	31.780	51.337	-22.663	74.000	PEAK
9		9084.350	21.267	32.890	54.157	-19.843	74.000	PEAK

Note:

1. All Readings below 1GHz are Quasi-Peak, above 1GHz are performed with peak and/or average measurements as necessary.
2. Peak measurements: RBW = 1MHz, VBW = 1MHz, Sweep: Auto.
3. Average measurements: RBW = 1MHz, VBW = 10 Hz, Sweep: Auto.
4. “ * ”, means this data is the worst emission level.
5. “ # ”, means the frequency is out of the restricted band.
6. Measurement Level = Reading Level + Correct Factor.
7. The average measurement was not performed when the peak measured data under the limit of average detection.

Site : CB4-H	Time : 2017/08/08
Limit : FCC_SpartC_15.209_03M_PK	Margin : 6
Probe : CB4_FCC_A115_EFS_1-18GHz_1116 - HORIZONTAL	Power : DC 5V
EUT : LoRa Module	Note : Mode 1: Tx_ANT1_914.9MHz

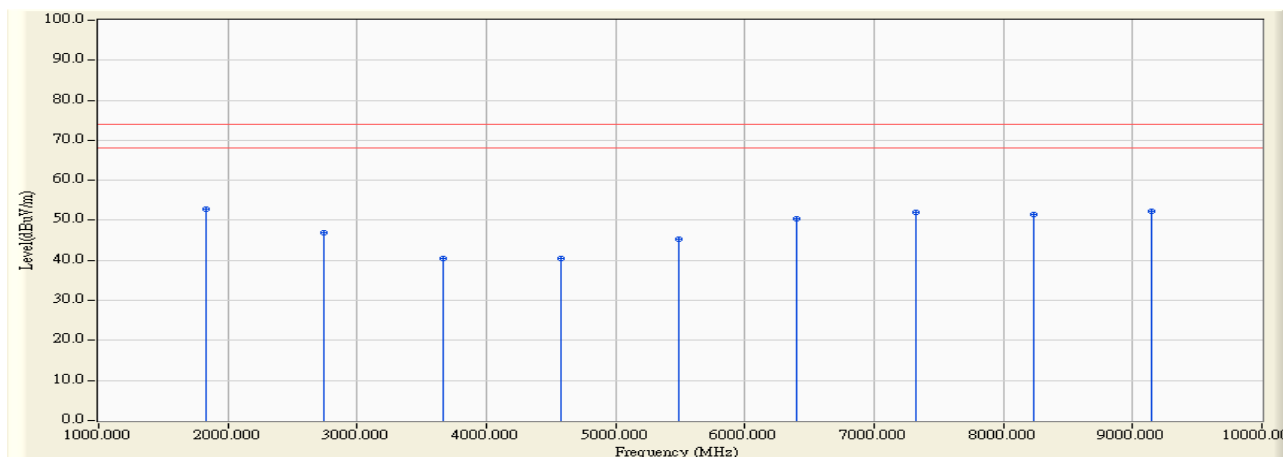

		Frequency (MHz)	Correct Factor (dB)	Reading Level (dBuV)	Measure Level (dBuV/m)	Margin (dB)	Limit (dBuV/m)	Detector Type
1	*	1829.915	-3.071	55.980	52.908	-21.092	74.000	PEAK
2		2744.860	0.983	46.030	47.012	-26.988	74.000	PEAK
3		3660.785	3.487	36.910	40.397	-33.603	74.000	PEAK
4		4574.625	7.126	33.240	40.366	-33.634	74.000	PEAK
5		5489.525	9.675	35.690	45.366	-28.634	74.000	PEAK
6		6403.515	14.817	35.480	50.298	-23.702	74.000	PEAK
7		7319.305	18.121	33.860	51.981	-22.019	74.000	PEAK
8		8232.550	19.661	31.780	51.441	-22.559	74.000	PEAK
9		9145.125	21.325	30.930	52.255	-21.745	74.000	PEAK

Note:

1. All Readings below 1GHz are Quasi-Peak, above 1GHz are performed with peak and/or average measurements as necessary.
2. Peak measurements: RBW = 1MHz, VBW = 1MHz, Sweep: Auto.
3. Average measurements: RBW = 1MHz, VBW = 10 Hz, Sweep: Auto.
4. “ * ”, means this data is the worst emission level.
5. “ # ”, means the frequency is out of the restricted band.
6. Measurement Level = Reading Level + Correct Factor.
7. The average measurement was not performed when the peak measured data under the limit of average detection.

Site : CB4-H	Time : 2017/08/08
Limit : FCC_SpartC_15.209_03M_PK	Margin : 6
Probe : CB4_FCC_A115_EFS_1-18GHz_1116 - VERTICAL	Power : DC 5V
EUT : LoRa Module	Note : Mode 1: Tx_ANT1_914.9MHz

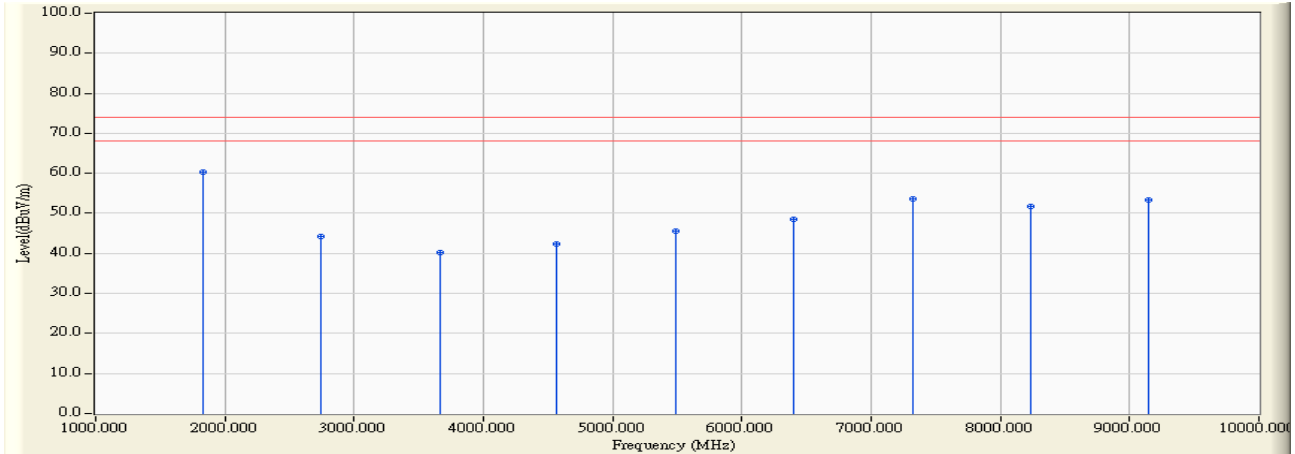

		Frequency (MHz)	Correct Factor (dB)	Reading Level (dBuV)	Measure Level (dBuV/m)	Margin (dB)	Limit (dBuV/m)	Detector Type
1	*	1829.900	-3.071	63.450	60.378	-13.622	74.000	PEAK
2		2744.800	0.983	43.330	44.312	-29.688	74.000	PEAK
3		3659.700	3.483	36.660	40.143	-33.857	74.000	PEAK
4		4569.550	7.100	35.330	42.430	-31.570	74.000	PEAK
5		5489.250	9.675	35.800	45.475	-28.525	74.000	PEAK
6		6404.460	14.825	33.580	48.405	-25.595	74.000	PEAK
7		7319.030	18.121	35.620	53.740	-20.260	74.000	PEAK
8		8232.755	19.661	32.180	51.841	-22.159	74.000	PEAK
9		9149.300	21.329	32.130	53.459	-20.541	74.000	PEAK

Note:

1. All Readings below 1GHz are Quasi-Peak, above 1GHz are performed with peak and/or average measurements as necessary.
2. Peak measurements: RBW = 1MHz, VBW = 1MHz, Sweep: Auto.
3. Average measurements: RBW = 1MHz, VBW = 10 Hz, Sweep: Auto.
4. “ * ”, means this data is the worst emission level.
5. “ # ”, means the frequency is out of the restricted band.
6. Measurement Level = Reading Level + Correct Factor.
7. The average measurement was not performed when the peak measured data under the limit of average detection.

Site : CB4-H	Time : 2017/08/08
Limit : FCC_SpartC_15.209_03M_AV	Margin : 6
Probe : CB4_FCC_A115_EFS_1-18GHz_1116 - VERTICAL	Power : DC 5V
EUT : LoRa Module	Note : Mode 1: Tx_ANT1_914.9MHz

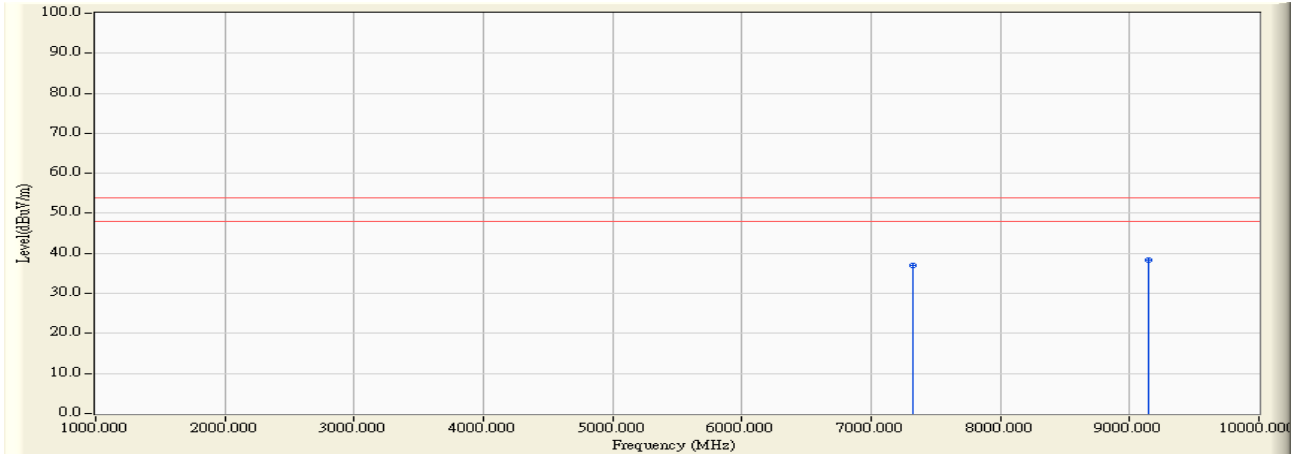

		Frequency (MHz)	Correct Factor (dB)	Reading Level (dBuV)	Measure Level (dBuV/m)	Margin (dB)	Limit (dBuV/m)	Detector Type
1		7319.300	18.121	18.750	36.871	-17.129	54.000	AVERAGE
2	*	9149.100	21.328	17.110	38.439	-15.561	54.000	AVERAGE

Note:

1. All Readings below 1GHz are Quasi-Peak, above 1GHz are performed with peak and/or average measurements as necessary.
2. Peak measurements: RBW = 1MHz, VBW = 1MHz, Sweep: Auto.
3. Average measurements: RBW = 1MHz, VBW = 10 Hz, Sweep: Auto.
4. “ * ”, means this data is the worst emission level.
5. “ # ”, means the frequency is out of the restricted band.
6. Measurement Level = Reading Level + Correct Factor.
7. The average measurement was not performed when the peak measured data under the limit of average detection.

Site : CB4-H	Time : 2017/08/11
Limit : FCC_SpartC_15.209_03M_PK	Margin : 6
Probe : CB4_FCC_EFS_B432_1-18GHz_3M_1116 - HORIZONTAL	Power : DC 5V
EUT : LoRa Module	Note : Mode 2: Tx_ANT2_902.3MHz

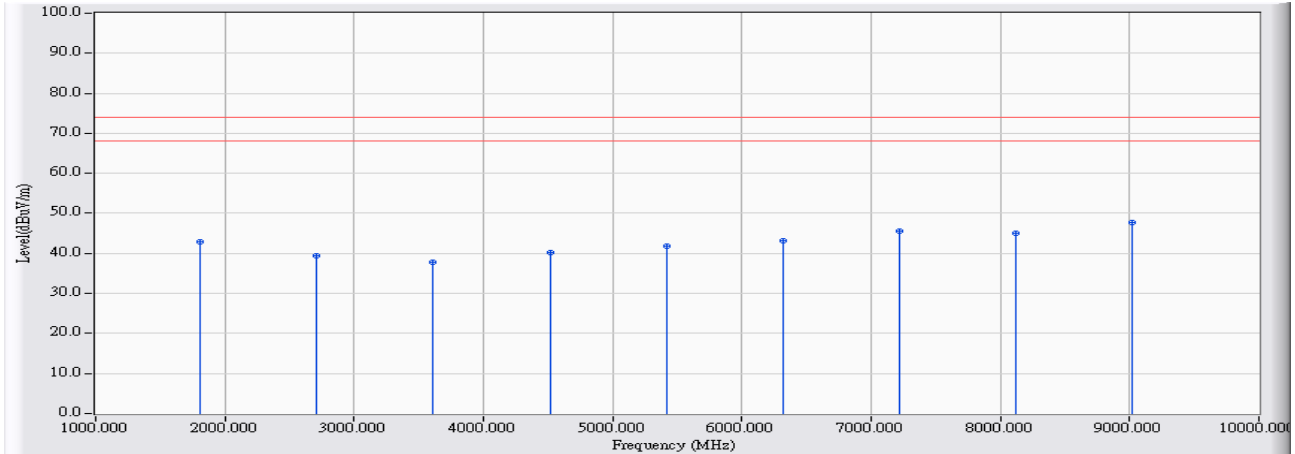

	Frequency (MHz)	Correct Factor (dB)	Reading Level (dBuV)	Measure Level (dBuV/m)	Margin (dB)	Limit (dBuV/m)	Detector Type
1	1804.520	-11.239	54.140	42.901	-31.099	74.000	PEAK
2	2706.800	-7.932	47.390	39.458	-34.542	74.000	PEAK
3	3606.890	-5.410	43.210	37.799	-36.201	74.000	PEAK
4	4513.670	-0.714	41.050	40.337	-33.663	74.000	PEAK
5	5413.900	0.306	41.440	41.747	-32.253	74.000	PEAK
6	6317.500	3.551	39.530	43.080	-30.920	74.000	PEAK
7	7217.700	6.766	38.890	45.657	-28.343	74.000	PEAK
8	8121.660	7.757	37.280	45.037	-28.963	74.000	PEAK
9	* 9023.790	10.532	37.110	47.642	-26.358	74.000	PEAK

Note:

1. All Readings below 1GHz are Quasi-Peak, above 1GHz are performed with peak and/or average measurements as necessary.
2. Peak measurements: RBW = 1MHz, VBW = 1MHz, Sweep: Auto.
3. Average measurements: RBW = 1MHz, VBW = 10 Hz, Sweep: Auto.
4. “ * ”, means this data is the worst emission level.
5. “ # ”, means the frequency is out of the restricted band.
6. Measurement Level = Reading Level + Correct Factor.
7. The average measurement was not performed when the peak measured data under the limit of average detection.

Site : CB4-H	Time : 2017/08/11
Limit : FCC_SpartC_15.209_03M_PK	Margin : 6
Probe : CB4_FCC_EFS_B432_1-18GHz_3M_1116 - VERTICAL	Power : DC 5V
EUT : LoRa Module	Note : Mode 2: Tx_ANT2_902.3MHz

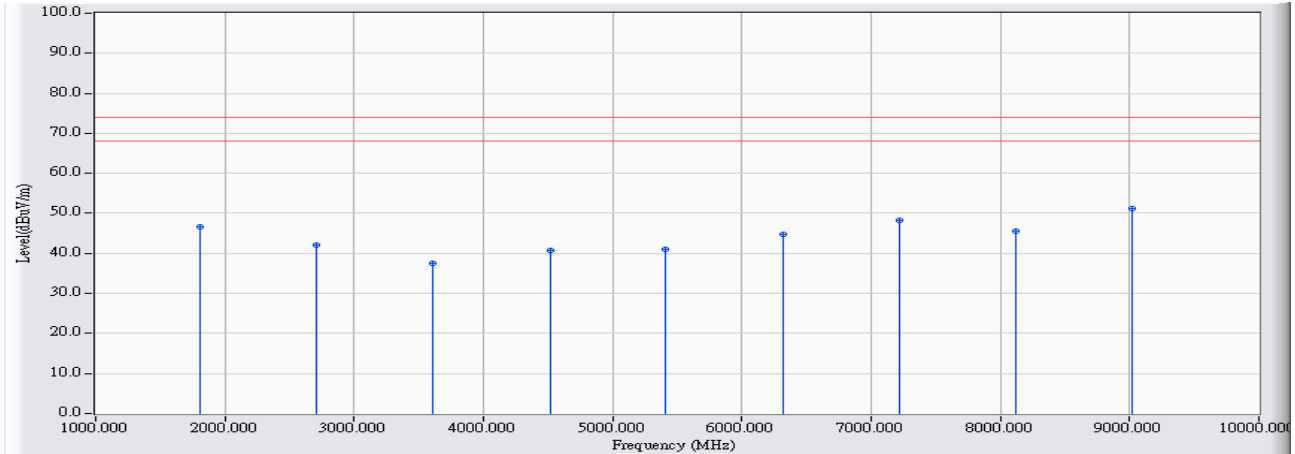

	Frequency (MHz)	Correct Factor (dB)	Reading Level (dBuV)	Measure Level (dBuV/m)	Margin (dB)	Limit (dBuV/m)	Detector Type
1	1804.500	-11.239	57.930	46.691	-27.309	74.000	PEAK
2	2706.820	-7.932	49.980	42.049	-31.951	74.000	PEAK
3	3610.230	-5.391	42.950	37.558	-36.442	74.000	PEAK
4	4513.690	-0.714	41.570	40.857	-33.143	74.000	PEAK
5	5413.090	0.307	40.620	40.927	-33.073	74.000	PEAK
6	6316.250	3.544	41.100	44.644	-29.356	74.000	PEAK
7	7218.500	6.776	41.580	48.356	-25.644	74.000	PEAK
8	8119.600	7.754	37.860	45.614	-28.386	74.000	PEAK
9	* 9023.400	10.530	40.620	51.150	-22.850	74.000	PEAK

Note:

1. All Readings below 1GHz are Quasi-Peak, above 1GHz are performed with peak and/or average measurements as necessary.
2. Peak measurements: RBW = 1MHz, VBW = 1MHz, Sweep: Auto.
3. Average measurements: RBW = 1MHz, VBW = 10 Hz, Sweep: Auto.
4. “ * ”, means this data is the worst emission level.
5. “ # ”, means the frequency is out of the restricted band.
6. Measurement Level = Reading Level + Correct Factor.
7. The average measurement was not performed when the peak measured data under the limit of average detection.

Site : CB4-H	Time : 2017/08/11
Limit : FCC_SpartC_15.209_03M_PK	Margin : 6
Probe : CB4_FCC_EFS_B432_1-18GHz_3M_1116 - HORIZONTAL	Power : DC 5V
EUT : LoRa Module	Note : Mode 2: Tx_ANT2_908.5MHz

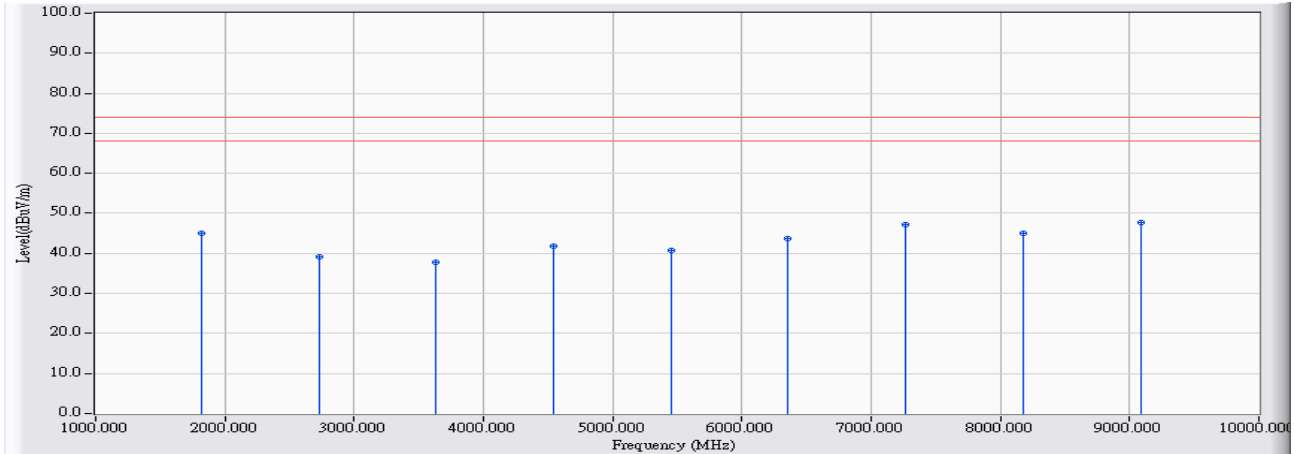

	Frequency (MHz)	Correct Factor (dB)	Reading Level (dBuV)	Measure Level (dBuV/m)	Margin (dB)	Limit (dBuV/m)	Detector Type
1	1816.890	-11.202	56.120	44.919	-29.081	74.000	PEAK
2	2725.660	-7.861	46.950	39.089	-34.911	74.000	PEAK
3	3636.300	-5.244	43.070	37.826	-36.174	74.000	PEAK
4	4543.500	-0.547	42.330	41.783	-32.217	74.000	PEAK
5	5453.100	0.294	40.430	40.724	-33.276	74.000	PEAK
6	6358.900	3.764	39.870	43.634	-30.366	74.000	PEAK
7	7268.360	7.073	40.120	47.194	-26.806	74.000	PEAK
8	8177.050	7.836	37.310	45.146	-28.854	74.000	PEAK
9	* 9084.600	10.799	36.830	47.628	-26.372	74.000	PEAK

Note:

1. All Readings below 1GHz are Quasi-Peak, above 1GHz are performed with peak and/or average measurements as necessary.
2. Peak measurements: RBW = 1MHz, VBW = 1MHz, Sweep: Auto.
3. Average measurements: RBW = 1MHz, VBW = 10 Hz, Sweep: Auto.
4. “ * ”, means this data is the worst emission level.
5. “ # ”, means the frequency is out of the restricted band.
6. Measurement Level = Reading Level + Correct Factor.
7. The average measurement was not performed when the peak measured data under the limit of average detection.

Site : CB4-H	Time : 2017/08/11
Limit : FCC_SpartC_15.209_03M_PK	Margin : 6
Probe : CB4_FCC_EFS_B432_1-18GHz_3M_1116 - VERTICAL	Power : DC 5V
EUT : LoRa Module	Note : Mode 2: Tx_ANT2_908.5MHz

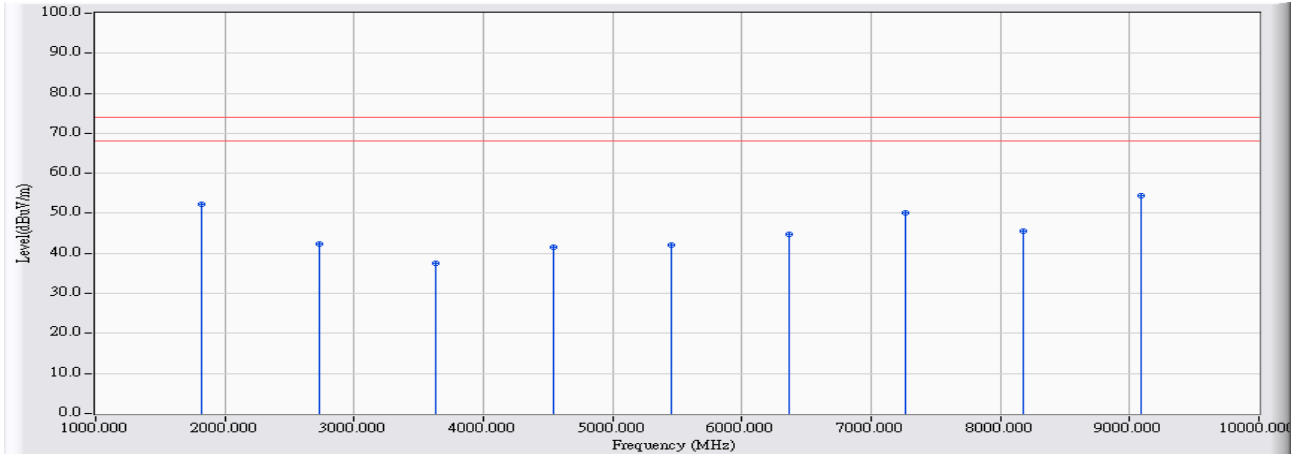

	Frequency (MHz)	Correct Factor (dB)	Reading Level (dBuV)	Measure Level (dBuV/m)	Margin (dB)	Limit (dBuV/m)	Detector Type
1	1816.933	-11.202	63.450	52.249	-21.751	74.000	PEAK
2	2725.640	-7.861	50.190	42.329	-31.671	74.000	PEAK
3	3633.400	-5.260	42.810	37.549	-36.451	74.000	PEAK
4	4542.600	-0.552	42.040	41.488	-32.512	74.000	PEAK
5	5451.030	0.296	41.750	42.045	-31.955	74.000	PEAK
6	6359.640	3.768	40.890	44.658	-29.342	74.000	PEAK
7	7267.600	7.072	43.130	50.202	-23.798	74.000	PEAK
8	8176.300	7.834	37.720	45.554	-28.446	74.000	PEAK
9	* 9084.500	10.797	43.540	54.338	-19.662	74.000	PEAK

Note:

1. All Readings below 1GHz are Quasi-Peak, above 1GHz are performed with peak and/or average measurements as necessary.
2. Peak measurements: RBW = 1MHz, VBW = 1MHz, Sweep: Auto.
3. Average measurements: RBW = 1MHz, VBW = 10 Hz, Sweep: Auto.
4. “ * ”, means this data is the worst emission level.
5. “ # ”, means the frequency is out of the restricted band.
6. Measurement Level = Reading Level + Correct Factor.
7. The average measurement was not performed when the peak measured data under the limit of average detection.

Site : CB4-H	Time : 2017/08/11
Limit : FCC_SpartC_15.209_03M_AV	Margin : 6
Probe : CB4_FCC_EFS_B432_1-18GHz_3M_1116 - VERTICAL	Power : DC 5V
EUT : LoRa Module	Note : Mode 2: Tx_ANT2_908.5MHz

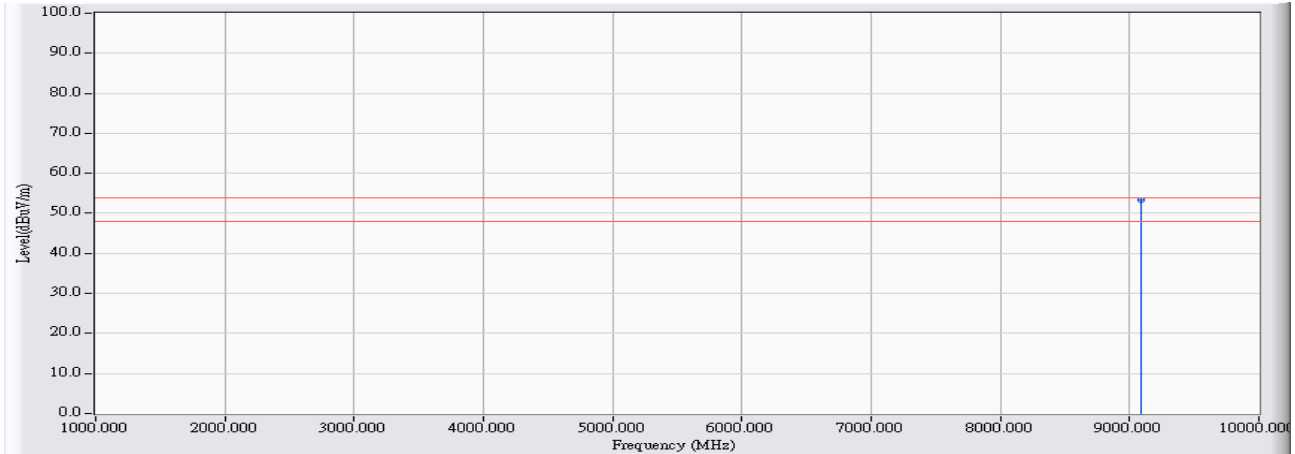

		Frequency (MHz)	Correct Factor (dB)	Reading Level (dBuV)	Measure Level (dBuV/m)	Margin (dB)	Limit (dBuV/m)	Detector Type
1	*	9084.500	10.797	42.630	53.428	-0.572	54.000	AVERAGE

Note:

1. All Readings below 1GHz are Quasi-Peak, above 1GHz are performed with peak and/or average measurements as necessary.
2. Peak measurements: RBW = 1MHz, VBW = 1MHz, Sweep: Auto.
3. Average measurements: RBW = 1MHz, VBW = 10 Hz, Sweep: Auto.
4. “ * ”, means this data is the worst emission level.
5. “ # ”, means the frequency is out of the restricted band.
6. Measurement Level = Reading Level + Correct Factor.
7. The average measurement was not performed when the peak measured data under the limit of average detection.

Site : CB4-H	Time : 2017/08/11
Limit : FCC_SpartC_15.209_03M_PK	Margin : 6
Probe : CB4_FCC_EFS_B432_1-18GHz_3M_1116 - HORIZONTAL	Power : DC 5V
EUT : LoRa Module	Note : Mode 2: Tx_ANT2_914.9MHz

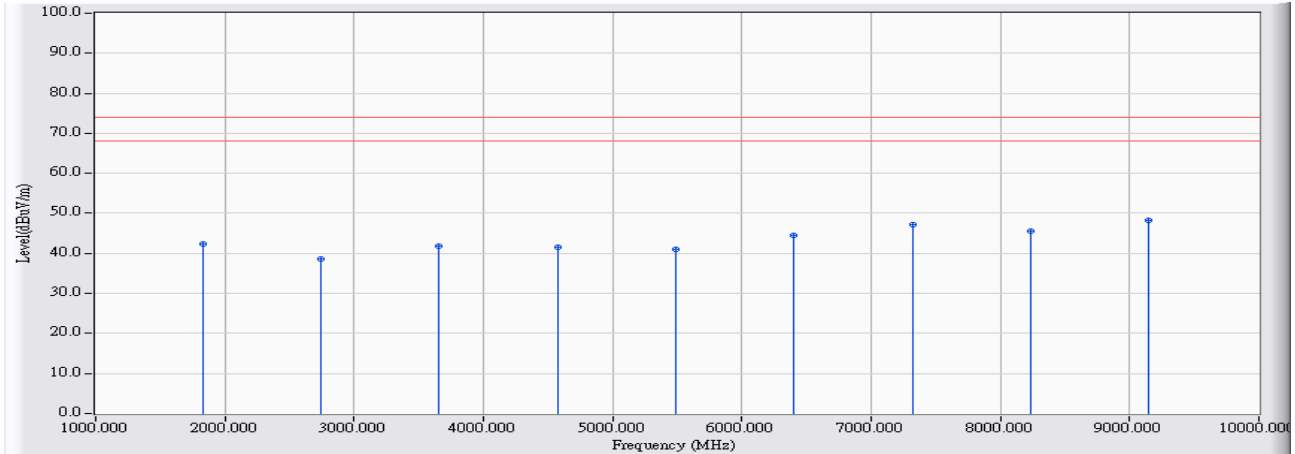

	Frequency (MHz)	Correct Factor (dB)	Reading Level (dBuV)	Measure Level (dBuV/m)	Margin (dB)	Limit (dBuV/m)	Detector Type
1	1829.750	-11.161	53.490	42.329	-31.671	74.000	PEAK
2	2744.300	-7.791	46.270	38.479	-35.521	74.000	PEAK
3	3657.800	-5.123	47.050	41.928	-32.072	74.000	PEAK
4	4572.900	-0.383	41.970	41.588	-12.412	54.000	PEAK
5	5490.500	0.285	40.830	41.115	-12.885	54.000	PEAK
6	6401.800	3.985	40.500	44.485	-9.515	54.000	PEAK
7	7319.100	7.188	39.980	47.169	-6.831	54.000	PEAK
8	8234.100	7.916	37.630	45.546	-8.454	54.000	PEAK
9	* 9148.100	11.076	37.220	48.296	-5.704	54.000	PEAK

Note:

1. All Readings below 1GHz are Quasi-Peak, above 1GHz are performed with peak and/or average measurements as necessary.
2. Peak measurements: RBW = 1MHz, VBW = 1MHz, Sweep: Auto.
3. Average measurements: RBW = 1MHz, VBW = 10 Hz, Sweep: Auto.
4. “ * ”, means this data is the worst emission level.
5. “ # ”, means the frequency is out of the restricted band.
6. Measurement Level = Reading Level + Correct Factor.
7. The average measurement was not performed when the peak measured data under the limit of average detection.

Site : CB4-H	Time : 2017/08/11
Limit : FCC_SpartC_15.209_03M_PK	Margin : 6
Probe : CB4_FCC_EFS_B432_1-18GHz_3M_1116 - VERTICAL	Power : DC 5V
EUT : LoRa Module	Note : Mode 2: Tx_ANT2_914.9MHz

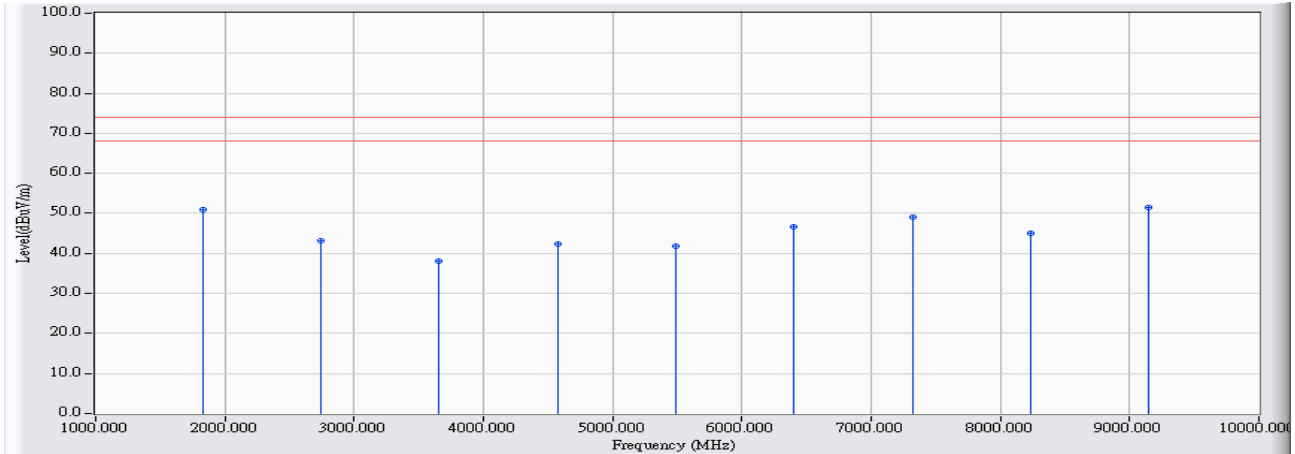

	Frequency (MHz)	Correct Factor (dB)	Reading Level (dBuV)	Measure Level (dBuV/m)	Margin (dB)	Limit (dBuV/m)	Detector Type
1	1829.700	-11.162	62.060	50.899	-23.101	74.000	PEAK
2	2744.450	-7.790	50.950	43.159	-30.841	74.000	PEAK
3	3659.600	-5.113	43.310	38.198	-35.802	74.000	PEAK
4	4573.420	-0.379	42.850	42.471	-31.529	74.000	PEAK
5	5489.400	0.285	41.510	41.794	-32.206	74.000	PEAK
6	6403.960	3.996	42.610	46.606	-27.394	74.000	PEAK
7	7319.400	7.190	41.740	48.930	-25.070	74.000	PEAK
8	8237.160	7.921	37.220	45.140	-28.860	74.000	PEAK
9	* 9148.530	11.078	40.340	51.418	-22.582	74.000	PEAK

Note:

1. All Readings below 1GHz are Quasi-Peak, above 1GHz are performed with peak and/or average measurements as necessary.
2. Peak measurements: RBW = 1MHz, VBW = 1MHz, Sweep: Auto.
3. Average measurements: RBW = 1MHz, VBW = 10 Hz, Sweep: Auto.
4. “ * ”, means this data is the worst emission level.
5. “ # ”, means the frequency is out of the restricted band.
6. Measurement Level = Reading Level + Correct Factor.
7. The average measurement was not performed when the peak measured data under the limit of average detection.

5. RF antenna conducted test

5.1. Test Equipment

The following test equipment is used during the test:

RF antenna conducted test / SR10-H

Instrument	Manufacturer	Model No.	Serial No.	Cal. Date	Next Cal. Date
Signal & Spectrum Analyzer	R&S	FSV40	101049	2017/01/23	2018/01/22
EXA Signal Analyzer	Keysight	N9010A	MY51440132	2017/03/13	2018/03/12
Spectrum Analyzer	Agilent	N9010A	US47140172	2017/07/26	2018/07/25

5.2. Test Setup

RF Conducted Measurement:

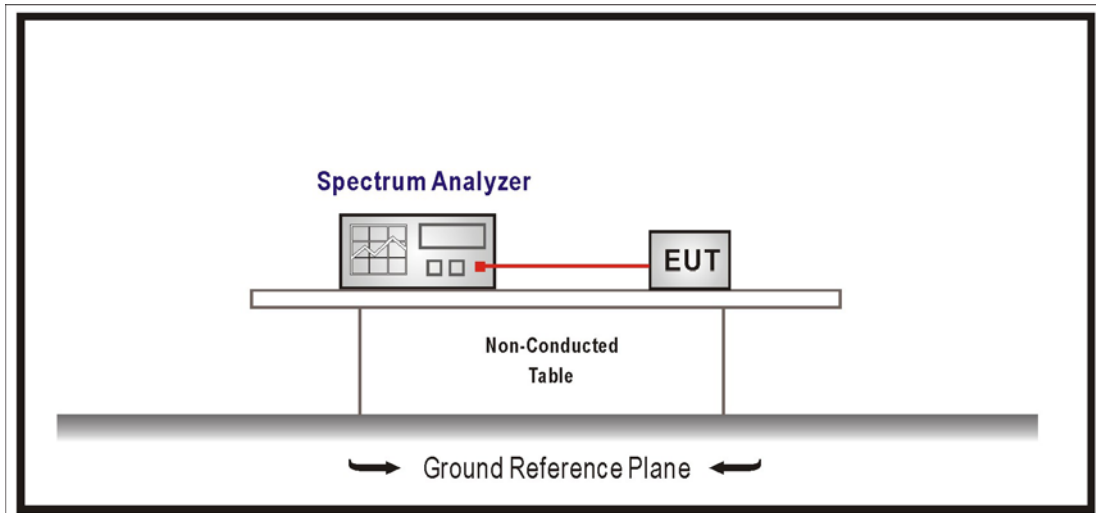

5.3. Limits

In any 100 kHz bandwidth outside the frequency band in which the spread spectrum intentional radiator is operating, the radio frequency power that is produced by the intentional radiator shall be at least 20 dB below that in the 100 kHz bandwidth within the band that contains the highest level of the desired power, based on an RF conducted or radiated measurement. Attenuation below the general limits specified in Section 15.209(a) is not required. In addition, radiated emissions which fall in the restricted bands, as defined in Section 15.205(a), must also comply with the radiated emission limits specified in Section 15.209(a) (see Section 15.205(c)).

5.4. Test Procedure

The EUT was setup according to ANSI C63.10:2013 and tested according to FHSS test procedure of FCC Public Notice DA 00-705 for compliance to FCC 47CFR 15.247 requirements

Set RBW = 100 kHz, Set VBW > RBW, scan up through 10th harmonic.

5.5. Test Specification

According to FCC Part 15 Subpart C Paragraph 15.247: 2015

5.6. Test Result

Product	LoRa Module		
Test Item	RF antenna conducted test		
Test Mode	Mode 1: Tx_ANT1		
Date of Test	2017/08/21	Test Site	SR10-H

Frequency (MHz)	Measure Level (dBc)	Limit (dBc)	Result
902.3	51.156	≥ 20	Pass
908.5	65.116	≥ 20	Pass
914.9	65.448	≥ 20	Pass

902.3 MHz

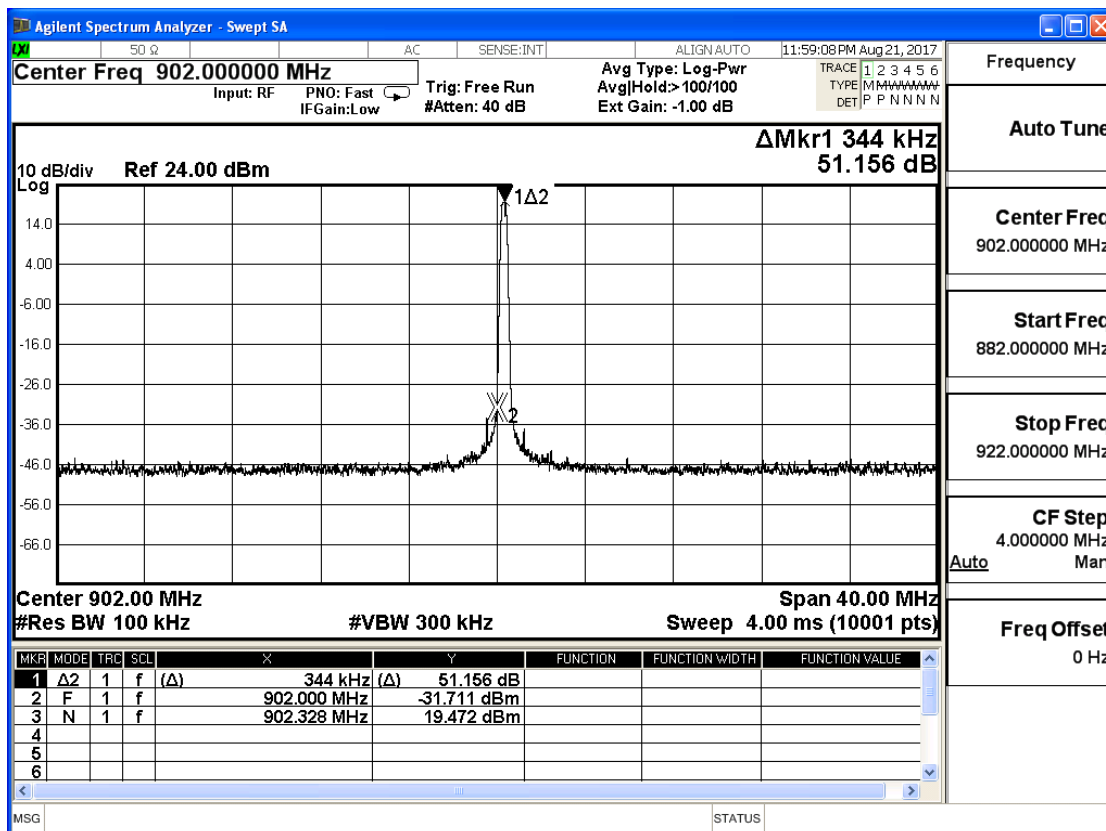

908.5 MHz

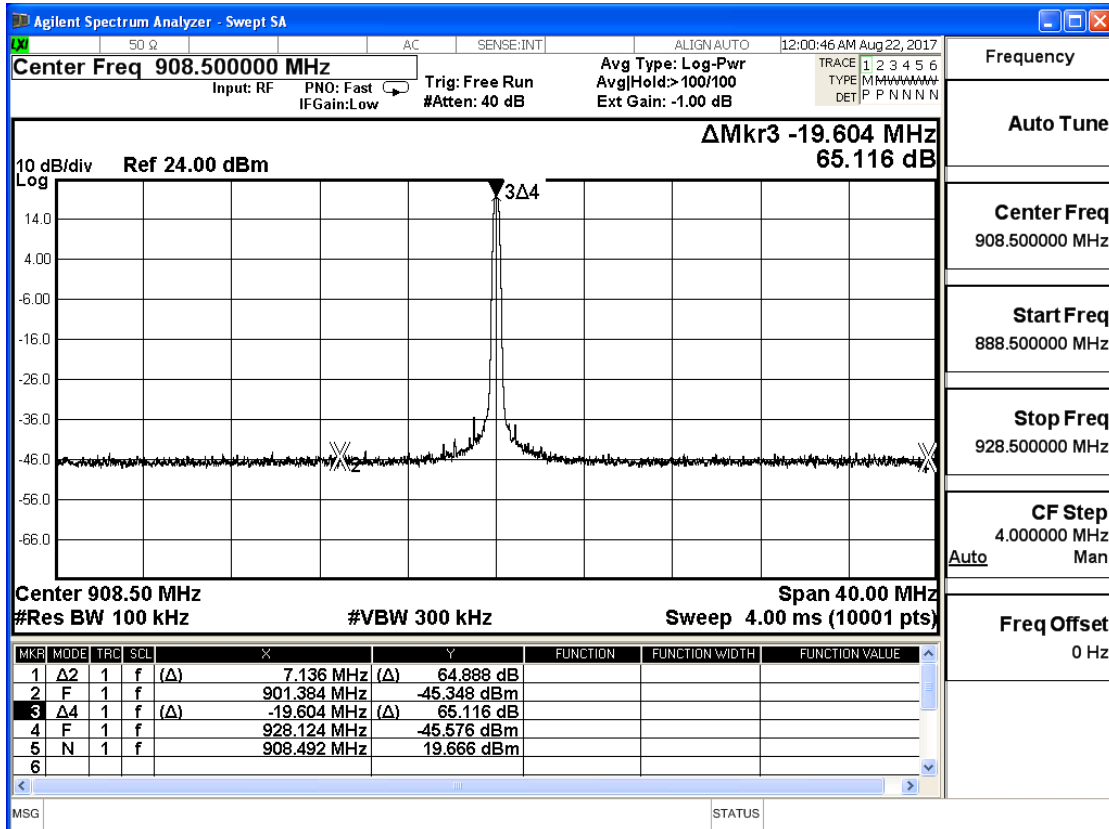

914.9 MHz

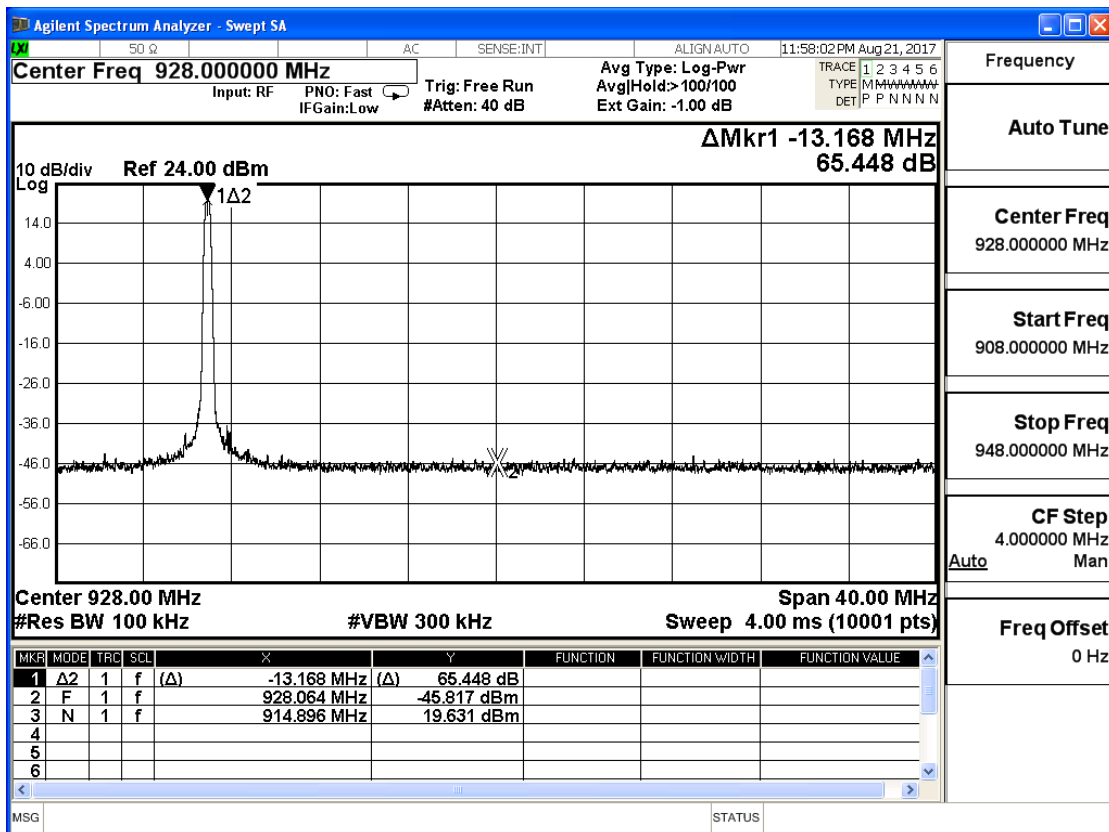

Product	LoRa Module		
Test Item	RF antenna conducted test		
Test Mode	Mode 1: Tx_ANT1		
Date of Test	2017/08/22	Test Site	SR10-H

902.3MHz (30MHz-25GHz)

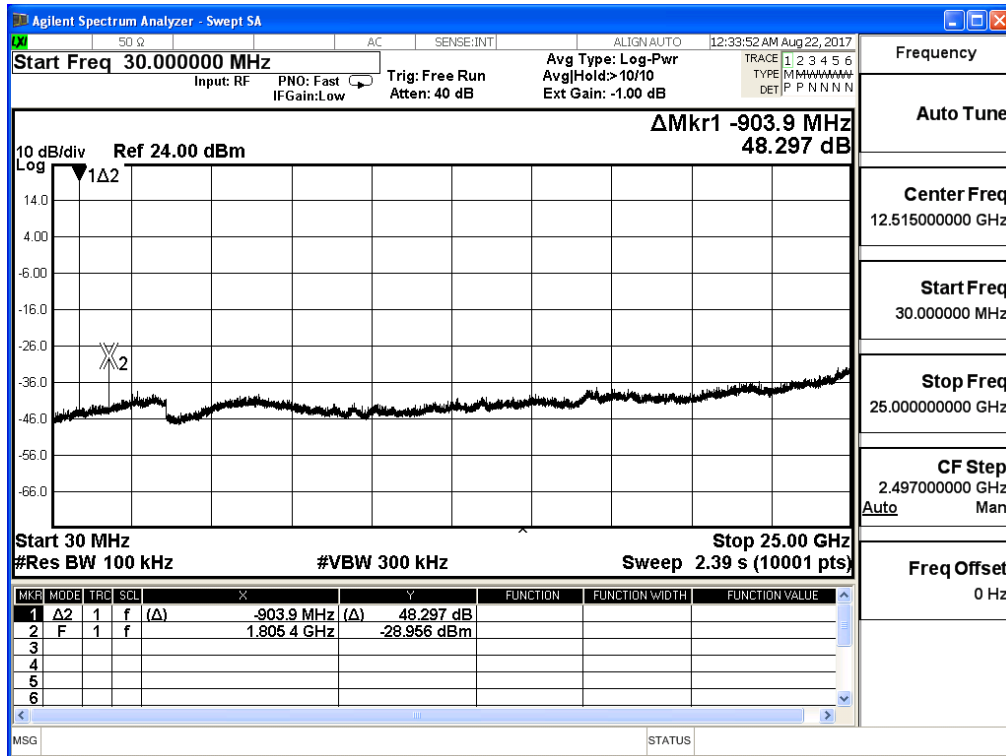

908.5MHz (30MHz-25GHz)

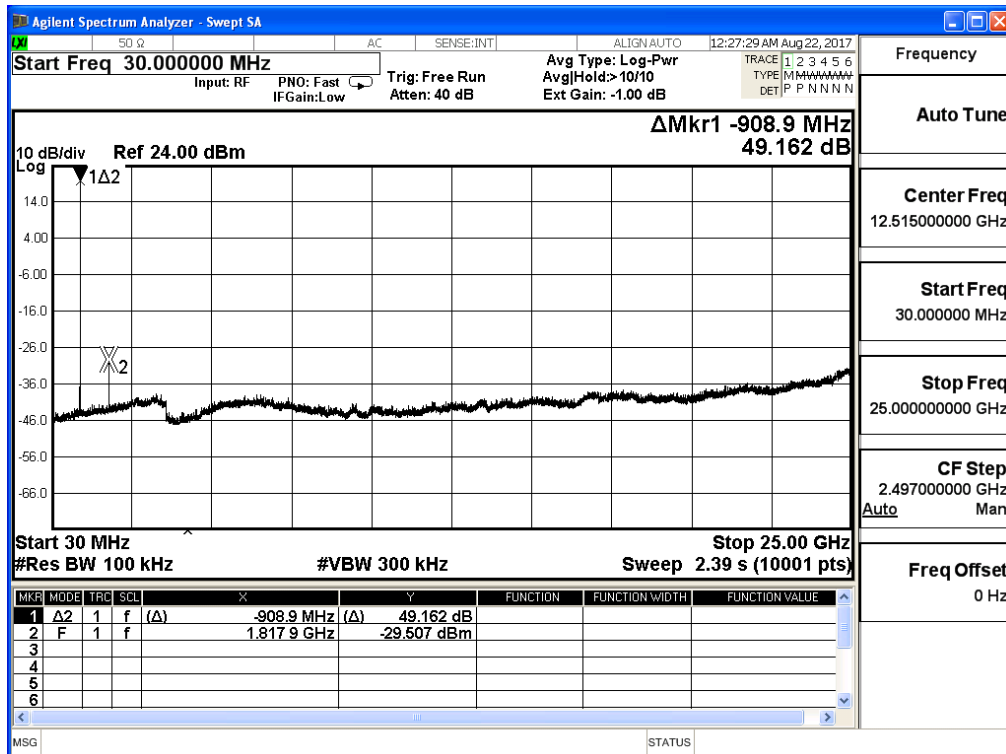

914.9MHz (30MHz-25GHz)

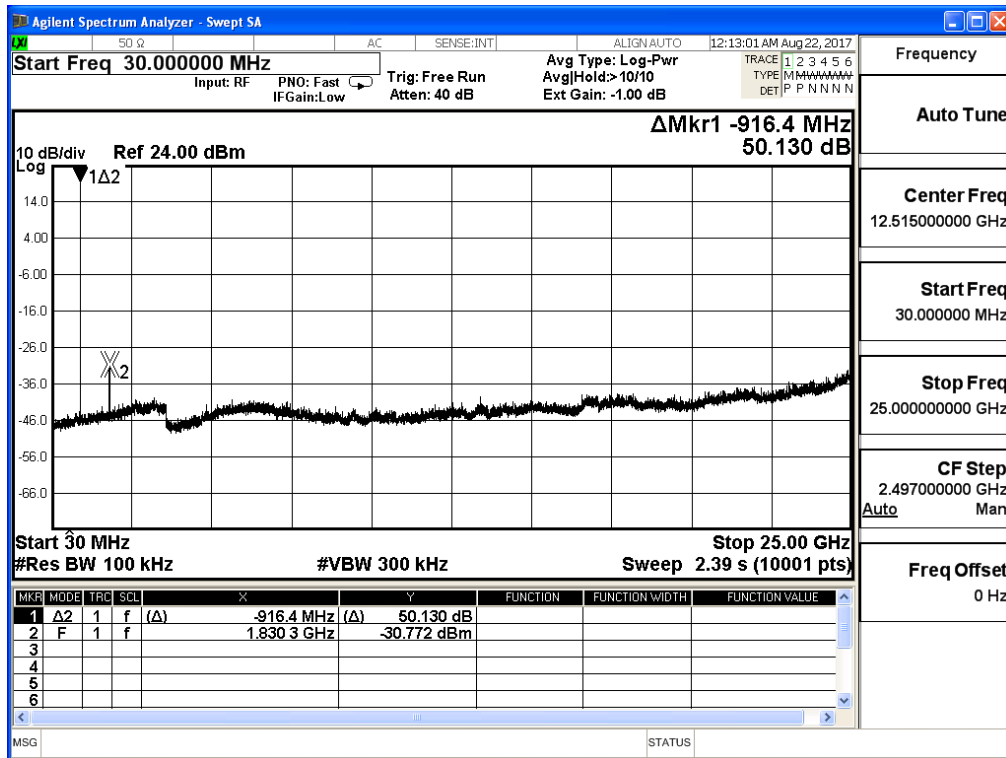

6. Band Edge

6.1. Test Equipment

The following test equipment are used during the test:

Band Edge / CB4-H

Instrument	Manufacturer	Model No.	Serial No.	Cal. Date	Next Cal. Date
Signal Analyzer	R&S	FSVA40	101455	2016/11/28	2017/11/27
Signal & Spectrum Analyzer	R&S	FSV40	101049	2017/01/23	2018/01/22
EXA Signal Analyzer	Keysight	N9010A	MY51440132	2017/03/13	2018/03/12
Bilog Antenna	Teseq	CBL6112D	23191	2017/06/28	2018/06/27
Horn Antenna	Schwarzbeck	BBHA 9120D	639	2017/06/14	2018/06/13
Horn Antenna	Schwarzbeck	BBHA 9170	203	2016/08/29	2017/08/28
Pre-Amplifier	RF Bay Inc.	LNA-1330	12162511	2017/03/09	2018/03/08
Pre-Amplifier	EMCI	EMCI 1830I	980366	2017/01/23	2018/01/22
Pre-Amplifier	MITEQ	JS44-45-8P	2014754	2016/12/26	2017/12/25

6.2. Test Setup

RF Radiated Measurement:

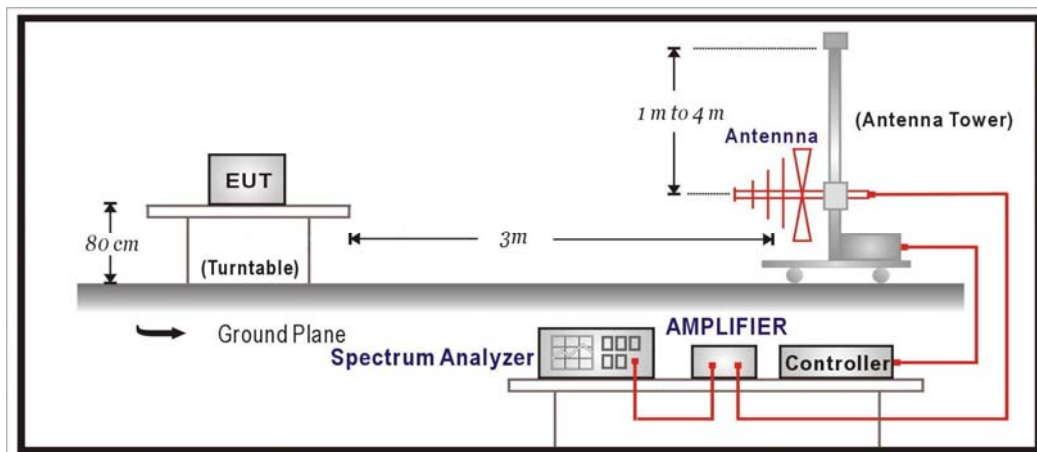

6.3. Limits

Emissions radiated outside of the specified frequency bands, except for harmonics, shall be attenuated by at least 20dB below the level of the fundamental or to the general radiated emission limits in paragraph 15.209, whichever is the lesser attenuation.

6.4. Test Procedure

The EUT was setup according to ANSI C63.10:2013 and tested according to FHSS test procedure of FCC Public Notice DA 00-705 for compliance to FCC 47CFR 15.247 requirements

The EUT and its simulators are placed on a turn table which is 0.8meter above ground. The turn table can rotate 360 degrees to determine the position of the maximum emission level. The EUT was positioned such that the distance from antenna to the EUT was 3 meters.

The antenna can move up and down between 1 meter and 4 meters to find out the maximum emission level.

Both horizontal and vertical polarization of the antenna are set on measurement. In order to find the maximum emission, all of the interface cables must be manipulated according to ANSI C63.10:2013 on radiated measurement.

6.5. Test Specification

According to FCC Part 15 Subpart C Paragraph 15.247: 2015

6.6. Test Result

Site : CB4-H	Time : 2017/08/26
Limit : FCC_SpartC_15.209_03M_PK	Margin : 6
Probe : CB4_FCC_EFS_S2_30M-1GHz_1116 - HORIZONTAL	Power : DC 5V
EUT : LoRa Module	Note : Mode 1: Tx_ANT1_902.3MHz

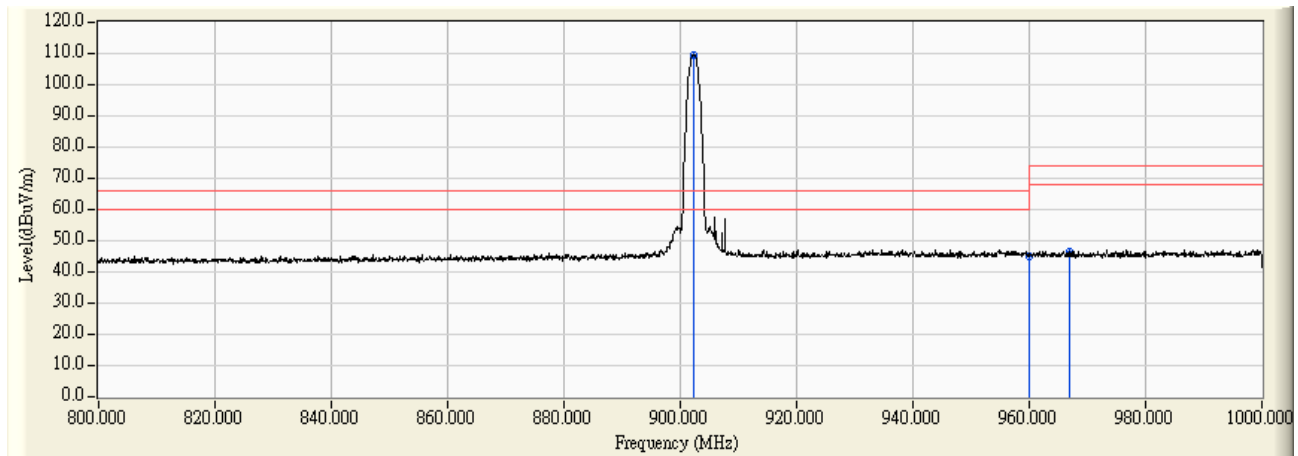

		Frequency (MHz)	Correct Factor (dB)	Reading Level (dBuV)	Measure Level (dBuV/m)	Margin (dB)	Limit (dBuV/m)	Detector Type
1	*	902.300	-9.711	119.183	109.472	43.452	66.020	PEAK
2		960.000	-8.864	54.048	45.184	-20.836	66.020	PEAK
3		966.800	-8.764	55.314	46.550	-27.450	74.000	PEAK

Note:

1. All readings above 1GHz are performed with peak and/or average measurements as necessary.
2. Peak measurements: RBW = 1MHz, VBW = 1MHz, Sweep: Auto.
3. Average measurements: RBW = 1MHz, VBW = 10 Hz, Sweep: Auto.
4. “ * ”, means this data is the worst emission level.
5. Measurement Level = Reading Level + Correct Factor.
6. The average measurement was not performed when the peak measured data under the limit of average detection. If the readings given are average, peak measurement should also be supplied.

Site : CB4-H	Time : 2017/08/26
Limit : FCC_SpartC_15.209_03M_AV	Margin : 6
Probe : CB4_FCC_EFS_S2_30M-1GHz_1116 - HORIZONTAL	Power : DC 5V
EUT : LoRa Module	Note : Mode 1: Tx_ANT1_902.3MHz

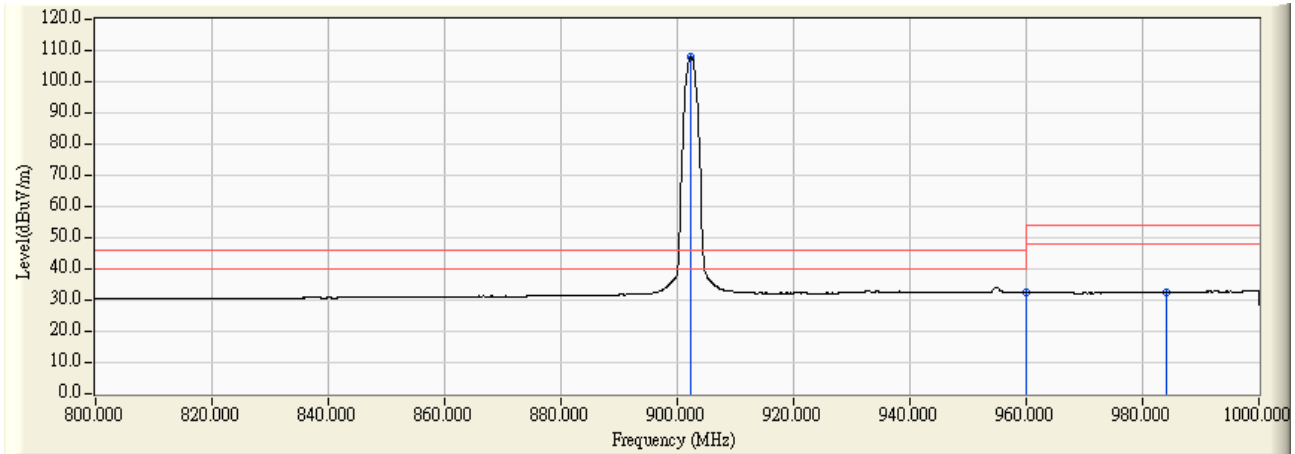

		Frequency (MHz)	Correct Factor (dB)	Reading Level (dBuV)	Measure Level (dBuV/m)	Margin (dB)	Limit (dBuV/m)	Detector Type
1	*	902.400	-9.705	117.510	107.804	61.784	46.020	AVERAGE
2		960.000	-8.864	41.411	32.547	-13.473	46.020	AVERAGE
3		984.000	-8.475	41.167	32.692	-21.308	54.000	AVERAGE

Note:

1. All readings above 1GHz are performed with peak and/or average measurements as necessary.
2. Peak measurements: RBW = 1MHz, VBW = 1MHz, Sweep: Auto.
3. Average measurements: RBW = 1MHz, VBW = 10 Hz, Sweep: Auto.
4. “ * ”, means this data is the worst emission level.
5. Measurement Level = Reading Level + Correct Factor.
6. The average measurement was not performed when the peak measured data under the limit of average detection. If the readings given are average, peak measurement should also be supplied.

Site : CB4-H	Time : 2017/08/26
Limit : FCC_SpartC_15.209_03M_PK	Margin : 6
Probe : CB4_FCC_EFS_S2_30M-1GHz_1116 - VERTICAL	Power : DC 5V
EUT : LoRa Module	Note : Mode 1: Tx_ANT1_902.3MHz

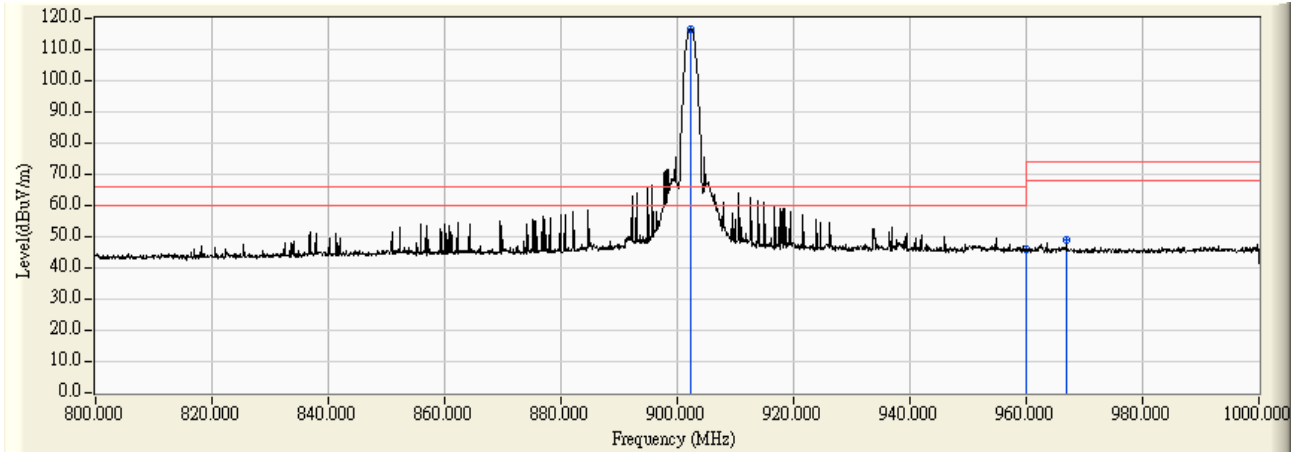

		Frequency (MHz)	Correct Factor (dB)	Reading Level (dBuV)	Measure Level (dBuV/m)	Margin (dB)	Limit (dBuV/m)	Detector Type
1	*	902.300	-9.711	126.333	116.622	50.602	66.020	PEAK
2		960.000	-8.864	54.884	46.020	-20.000	66.020	PEAK
3		966.900	-8.766	57.659	48.893	-25.107	74.000	PEAK

Note:

1. All readings above 1GHz are performed with peak and/or average measurements as necessary.
2. Peak measurements: RBW = 1MHz, VBW = 1MHz, Sweep: Auto.
3. Average measurements: RBW = 1MHz, VBW = 10 Hz, Sweep: Auto.
4. “ * ”, means this data is the worst emission level.
5. Measurement Level = Reading Level + Correct Factor.
6. The average measurement was not performed when the peak measured data under the limit of average detection. If the readings given are average, peak measurement should also be supplied.

Site : CB4-H	Time : 2017/08/26
Limit : FCC_SpartC_15.209_03M_AV	Margin : 6
Probe : CB4_FCC_EFS_S2_30M-1GHz_1116 - VERTICAL	Power : DC 5V
EUT : LoRa Module	Note : Mode 1: Tx_ANT1_902.3MHz

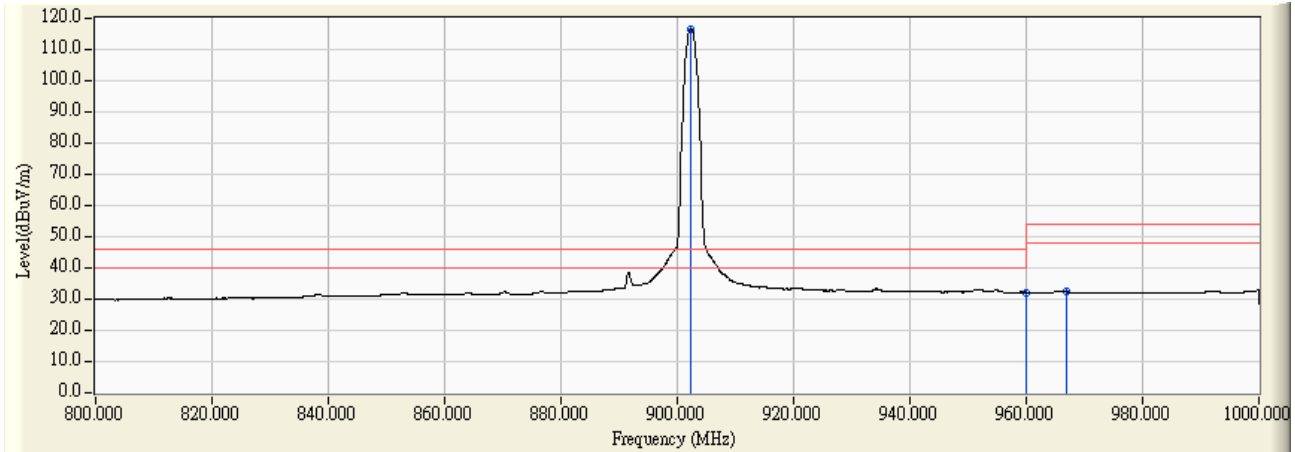

		Frequency (MHz)	Correct Factor (dB)	Reading Level (dBuV)	Measure Level (dBuV/m)	Margin (dB)	Limit (dBuV/m)	Detector Type
1	*	902.400	-9.705	126.167	116.461	70.441	46.020	AVERAGE
2		960.000	-8.864	41.080	32.216	-13.804	46.020	AVERAGE
3		966.800	-8.764	41.304	32.540	-21.460	54.000	AVERAGE

Note:

1. All readings above 1GHz are performed with peak and/or average measurements as necessary.
2. Peak measurements: RBW = 1MHz, VBW = 1MHz, Sweep: Auto.
3. Average measurements: RBW = 1MHz, VBW = 10 Hz, Sweep: Auto.
4. “ * ”, means this data is the worst emission level.
5. Measurement Level = Reading Level + Correct Factor.
6. The average measurement was not performed when the peak measured data under the limit of average detection. If the readings given are average, peak measurement should also be supplied.

Site : CB4-H	Time : 2017/08/26
Limit : FCC_SpartC_15.209_03M_PK	Margin : 6
Probe : CB4_FCC_EFS_S2_30M-1GHz_1116 - HORIZONTAL	Power : DC 5V
EUT : LoRa Module	Note : Mode 1: Tx_ANT1_914.9MHz

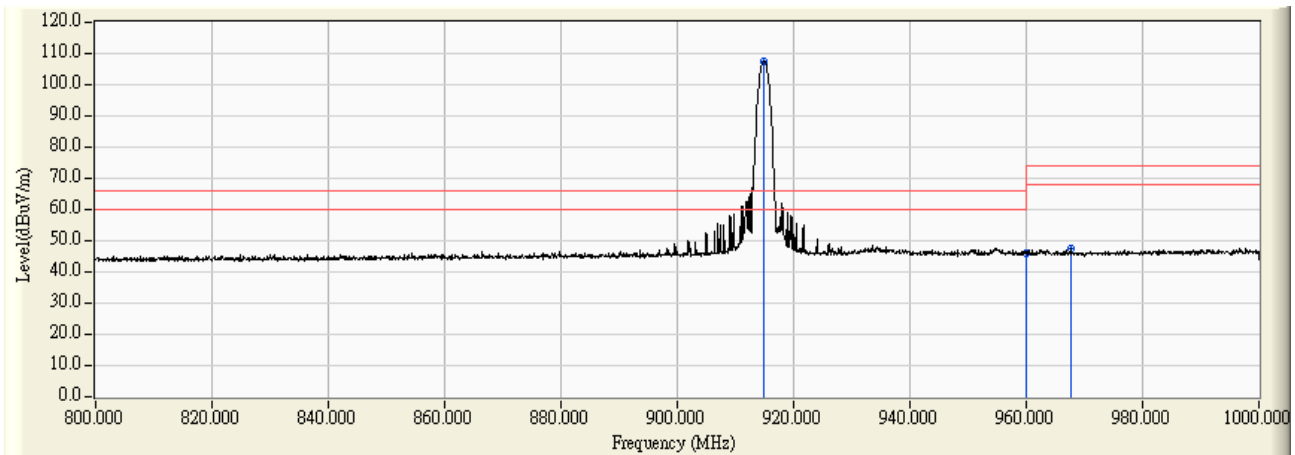

		Frequency (MHz)	Correct Factor (dB)	Reading Level (dBuV)	Measure Level (dBuV/m)	Margin (dB)	Limit (dBuV/m)	Detector Type
1	*	914.900	-9.545	116.889	107.344	41.324	66.020	PEAK
2		960.000	-8.864	55.049	46.185	-19.835	66.020	PEAK
3		967.700	-8.819	56.107	47.289	-26.711	74.000	PEAK

Note:

1. All readings above 1GHz are performed with peak and/or average measurements as necessary.
2. Peak measurements: RBW = 1MHz, VBW = 1MHz, Sweep: Auto.
3. Average measurements: RBW = 1MHz, VBW = 10 Hz, Sweep: Auto.
4. “ * ”, means this data is the worst emission level.
5. Measurement Level = Reading Level + Correct Factor.
6. The average measurement was not performed when the peak measured data under the limit of average detection. If the readings given are average, peak measurement should also be supplied.

Site : CB4-H	Time : 2017/08/26
Limit : FCC_SpartC_15.209_03M_AV	Margin : 6
Probe : CB4_FCC_EFS_S2_30M-1GHz_1116 - HORIZONTAL	Power : DC 5V
EUT : LoRa Module	Note : Mode 1: Tx_ANT1_914.9MHz

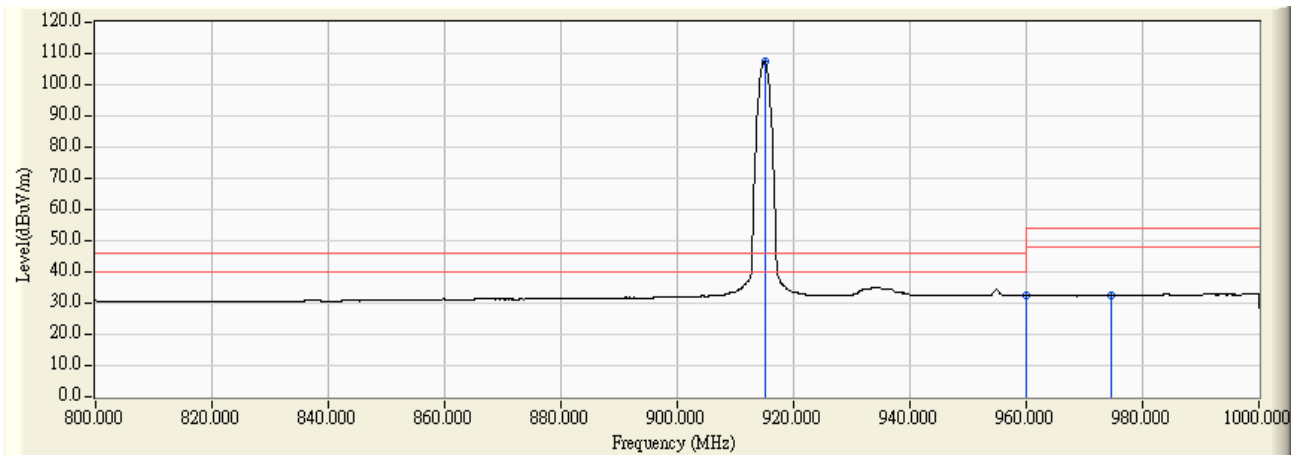

		Frequency (MHz)	Correct Factor (dB)	Reading Level (dBuV)	Measure Level (dBuV/m)	Margin (dB)	Limit (dBuV/m)	Detector Type
1	*	915.000	-9.539	116.875	107.335	61.315	46.020	AVERAGE
2		960.000	-8.864	41.297	32.433	-13.587	46.020	AVERAGE
3		974.700	-8.633	41.188	32.555	-21.445	54.000	AVERAGE

Note:

1. All readings above 1GHz are performed with peak and/or average measurements as necessary.
2. Peak measurements: RBW = 1MHz, VBW = 1MHz, Sweep: Auto.
3. Average measurements: RBW = 1MHz, VBW = 10 Hz, Sweep: Auto.
4. “ * ”, means this data is the worst emission level.
5. Measurement Level = Reading Level + Correct Factor.
6. The average measurement was not performed when the peak measured data under the limit of average detection. If the readings given are average, peak measurement should also be supplied.

Site : CB4-H	Time : 2017/08/26
Limit : FCC_SpartC_15.209_03M_PK	Margin : 6
Probe : CB4_FCC_EFS_S2_30M-1GHz_1116 - VERTICAL	Power : DC 5V
EUT : LoRa Module	Note : Mode 1: Tx_ANT1_914.9MHz

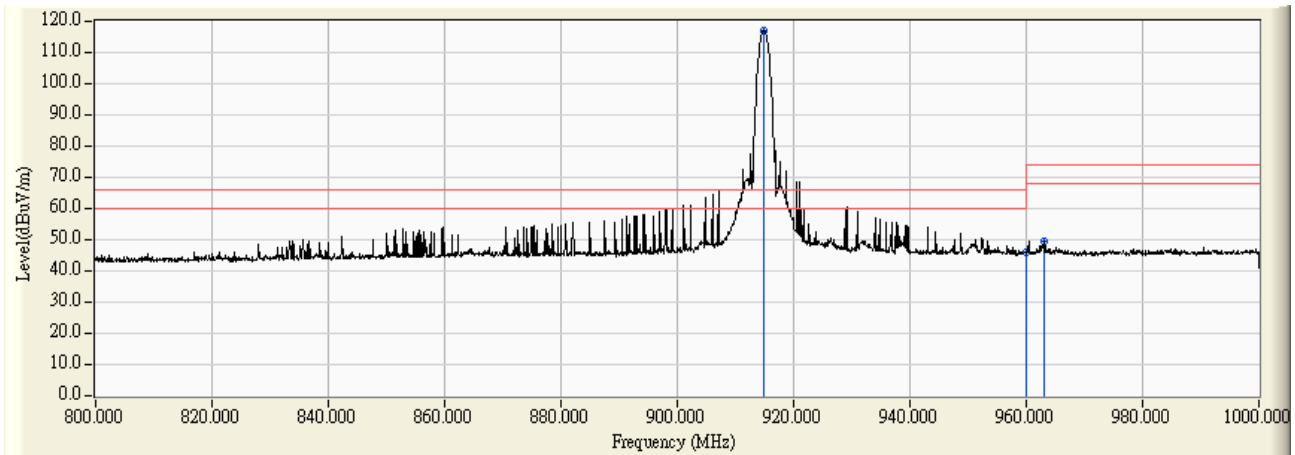

		Frequency (MHz)	Correct Factor (dB)	Reading Level (dBuV)	Measure Level (dBuV/m)	Margin (dB)	Limit (dBuV/m)	Detector Type
1	*	914.900	-9.545	126.436	116.891	50.871	66.020	PEAK
2		960.000	-8.864	54.782	45.918	-20.102	66.020	PEAK
3		963.000	-8.830	58.528	49.698	-24.302	74.000	PEAK

Note:

1. All readings above 1GHz are performed with peak and/or average measurements as necessary.
2. Peak measurements: RBW = 1MHz, VBW = 1MHz, Sweep: Auto.
3. Average measurements: RBW = 1MHz, VBW = 10 Hz, Sweep: Auto.
4. “ * ”, means this data is the worst emission level.
5. Measurement Level = Reading Level + Correct Factor.
6. The average measurement was not performed when the peak measured data under the limit of average detection. If the readings given are average, peak measurement should also be supplied.

Site : CB4-H	Time : 2017/08/26
Limit : FCC_SpartC_15.209_03M_AV	Margin : 6
Probe : CB4_FCC_EFS_S2_30M-1GHz_1116 - VERTICAL	Power : DC 5V
EUT : LoRa Module	Note : Mode 1: Tx_ANT1_914.9MHz

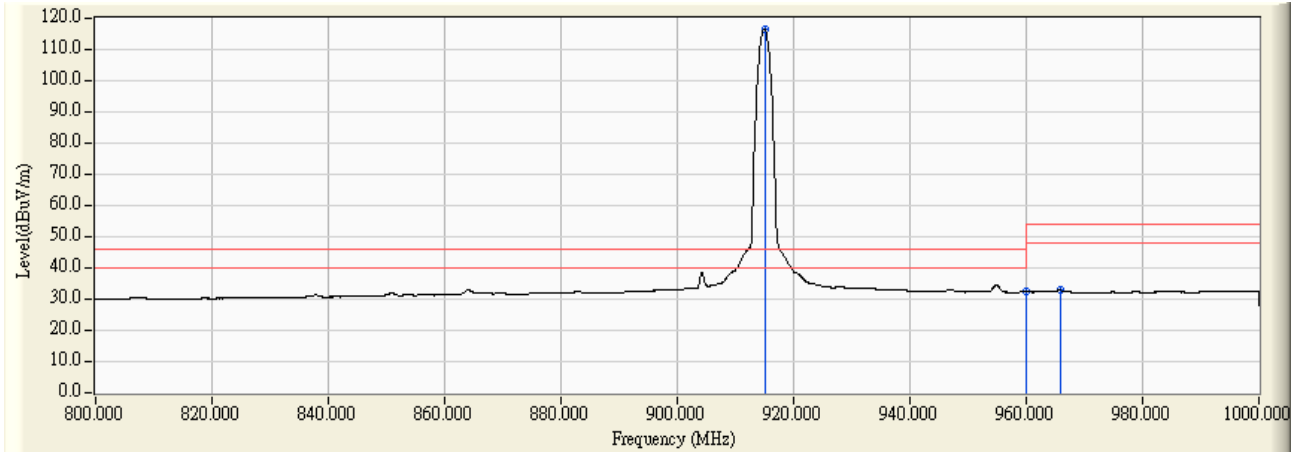

		Frequency (MHz)	Correct Factor (dB)	Reading Level (dBuV)	Measure Level (dBuV/m)	Margin (dB)	Limit (dBuV/m)	Detector Type
1	*	915.000	-9.539	126.141	116.601	70.581	46.020	AVERAGE
2		960.000	-8.864	41.230	32.366	-13.654	46.020	AVERAGE
3		965.800	-8.746	41.561	32.815	-21.185	54.000	AVERAGE

Note:

1. All readings above 1GHz are performed with peak and/or average measurements as necessary.
2. Peak measurements: RBW = 1MHz, VBW = 1MHz, Sweep: Auto.
3. Average measurements: RBW = 1MHz, VBW = 10 Hz, Sweep: Auto.
4. “ * ”, means this data is the worst emission level.
5. Measurement Level = Reading Level + Correct Factor.
6. The average measurement was not performed when the peak measured data under the limit of average detection. If the readings given are average, peak measurement should also be supplied.

Site : CB4-H	Time : 2017/08/26
Limit : FCC_SpartC_15.209_03M_PK	Margin : 6
Probe : CB4_FCC_EFS_S2_30M-1GHz_1116 - HORIZONTAL	Power : DC 5V
EUT : LoRa Module	Note : Mode 2: Tx_ANT2_902.3MHz

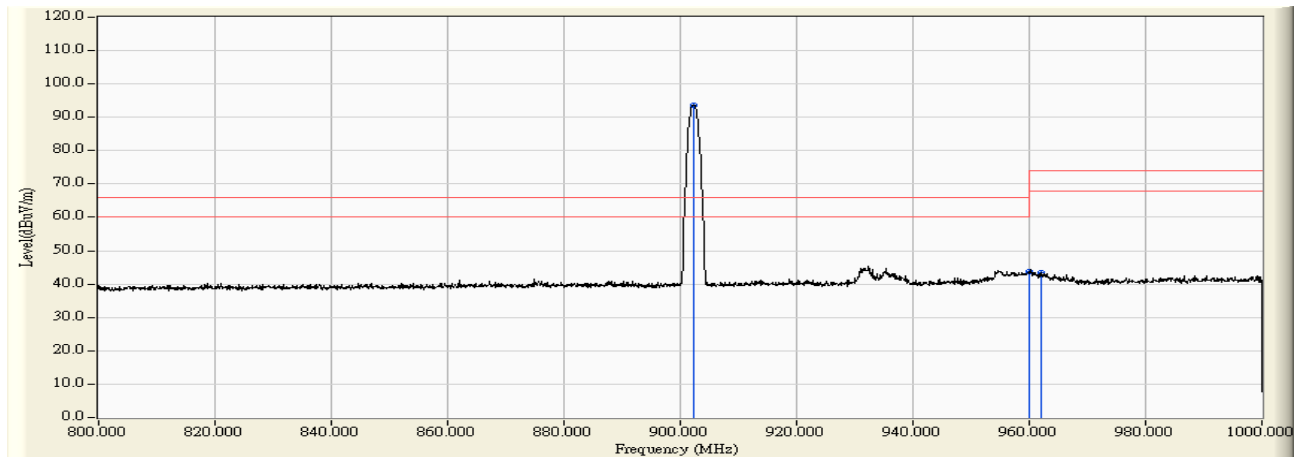

		Frequency (MHz)	Correct Factor (dB)	Reading Level (dBuV)	Measure Level (dBuV/m)	Margin (dB)	Limit (dBuV/m)	Detector Type
1	*	902.400	-9.705	103.380	93.674	27.654	66.020	PEAK
2		960.000	-8.864	52.761	43.897	-22.123	66.020	PEAK
3		962.100	-8.851	52.182	43.330	-30.670	74.000	PEAK

Note:

1. All readings above 1GHz are performed with peak and/or average measurements as necessary.
2. Peak measurements: RBW = 1MHz, VBW = 1MHz, Sweep: Auto.
3. Average measurements: RBW = 1MHz, VBW = 10 Hz, Sweep: Auto.
4. “ * ”, means this data is the worst emission level.
5. Measurement Level = Reading Level + Correct Factor.
6. The average measurement was not performed when the peak measured data under the limit of average detection. If the readings given are average, peak measurement should also be supplied.

Site : CB4-H	Time : 2017/08/26
Limit : FCC_SpartC_15.209_03M_AV	Margin : 6
Probe : CB4_FCC_EFS_S2_30M-1GHz_1116 - HORIZONTAL	Power : DC 5V
EUT : LoRa Module	Note : Mode 2: Tx_ANT2_902.3MHz

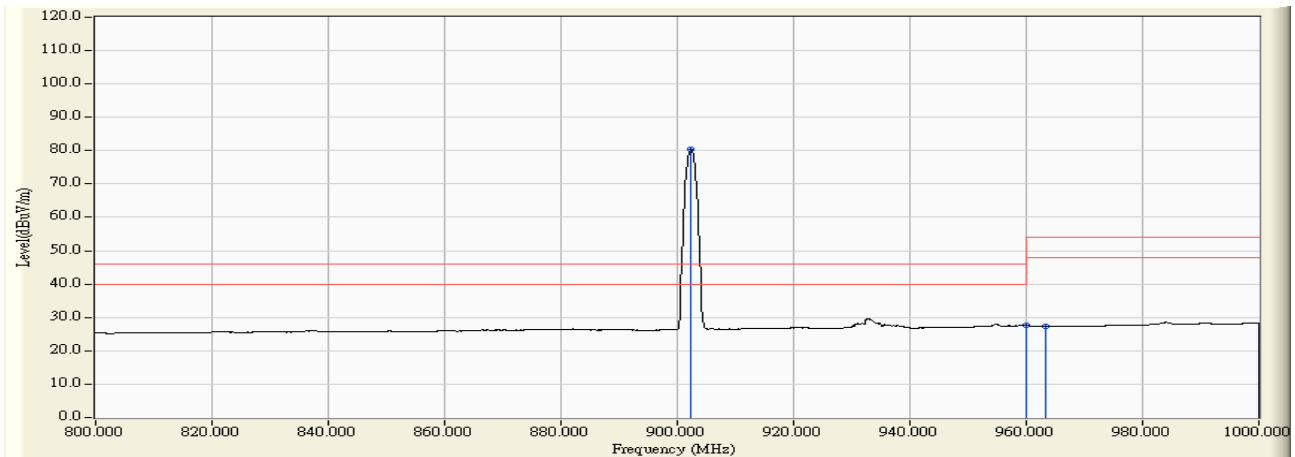

		Frequency (MHz)	Correct Factor (dB)	Reading Level (dBuV)	Measure Level (dBuV/m)	Margin (dB)	Limit (dBuV/m)	Detector Type
1	*	902.400	-9.705	90.064	80.358	34.338	46.020	AVERAGE
2		960.000	-8.864	36.557	27.693	-18.327	46.020	AVERAGE
3		963.300	-8.825	36.098	27.273	-26.727	54.000	AVERAGE

Note:

1. All readings above 1GHz are performed with peak and/or average measurements as necessary.
2. Peak measurements: RBW = 1MHz, VBW = 1MHz, Sweep: Auto.
3. Average measurements: RBW = 1MHz, VBW = 10 Hz, Sweep: Auto.
4. “ * ”, means this data is the worst emission level.
5. Measurement Level = Reading Level + Correct Factor.
6. The average measurement was not performed when the peak measured data under the limit of average detection. If the readings given are average, peak measurement should also be supplied.

Site : CB4-H	Time : 2017/08/26
Limit : FCC_SpartC_15.209_03M_PK	Margin : 6
Probe : CB4_FCC_EFS_S2_30M-1GHz_1116 - VERTICAL	Power : DC 5V
EUT : LoRa Module	Note : Mode 2: Tx_ANT2_902.3MHz

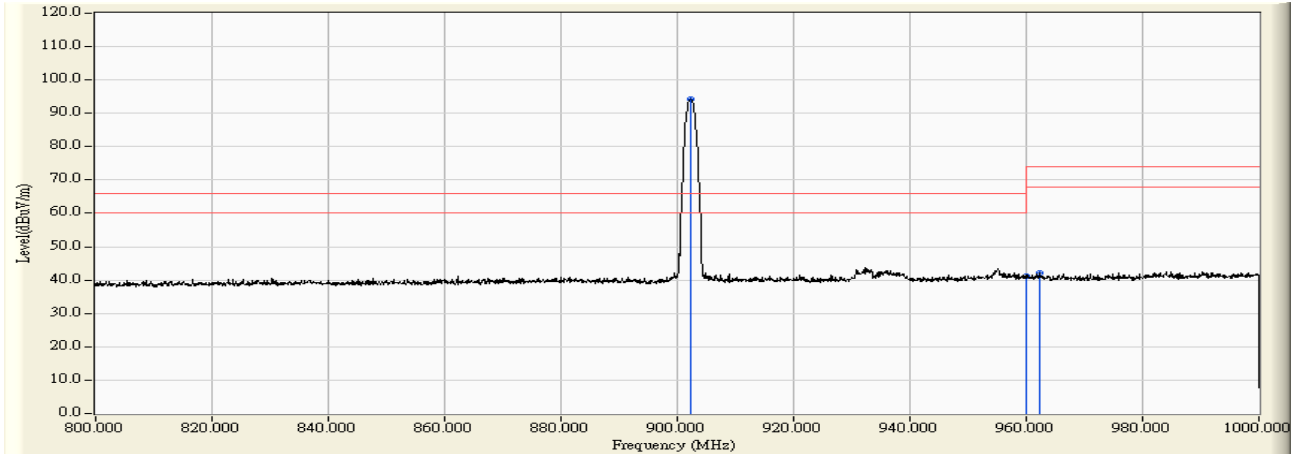

		Frequency (MHz)	Correct Factor (dB)	Reading Level (dBuV)	Measure Level (dBuV/m)	Margin (dB)	Limit (dBuV/m)	Detector Type
1	*	902.400	-9.705	103.927	94.221	28.201	66.020	PEAK
2		960.000	-8.864	50.183	41.319	-24.701	66.020	PEAK
3		962.400	-8.839	51.001	42.162	-31.838	74.000	PEAK

Note:

1. All readings above 1GHz are performed with peak and/or average measurements as necessary.
2. Peak measurements: RBW = 1MHz, VBW = 1MHz, Sweep: Auto.
3. Average measurements: RBW = 1MHz, VBW = 10 Hz, Sweep: Auto.
4. “ * ”, means this data is the worst emission level.
5. Measurement Level = Reading Level + Correct Factor.
6. The average measurement was not performed when the peak measured data under the limit of average detection. If the readings given are average, peak measurement should also be supplied.

Site : CB4-H	Time : 2017/08/26
Limit : FCC_SpartC_15.209_03M_AV	Margin : 6
Probe : CB4_FCC_EFS_S2_30M-1GHz_1116 - VERTICAL	Power : DC 5V
EUT : LoRa Module	Note : Mode 2: Tx_ANT2_902.3MHz

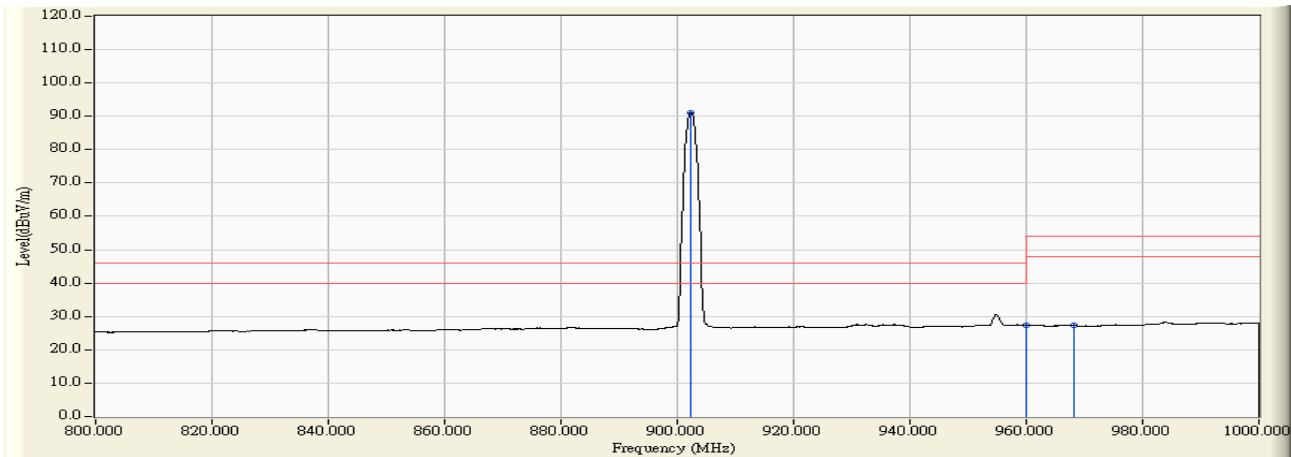

		Frequency (MHz)	Correct Factor (dB)	Reading Level (dBuV)	Measure Level (dBuV/m)	Margin (dB)	Limit (dBuV/m)	Detector Type
1	*	902.400	-9.705	100.768	91.062	45.042	46.020	AVERAGE
2		960.000	-8.864	36.249	27.385	-18.635	46.020	AVERAGE
3		968.100	-8.851	36.141	27.290	-26.710	54.000	AVERAGE

Note:

1. All readings above 1GHz are performed with peak and/or average measurements as necessary.
2. Peak measurements: RBW = 1MHz, VBW = 1MHz, Sweep: Auto.
3. Average measurements: RBW = 1MHz, VBW = 10 Hz, Sweep: Auto.
4. “ * ”, means this data is the worst emission level.
5. Measurement Level = Reading Level + Correct Factor.
6. The average measurement was not performed when the peak measured data under the limit of average detection. If the readings given are average, peak measurement should also be supplied.

Site : CB4-H	Time : 2017/08/26
Limit : FCC_SpartC_15.209_03M_PK	Margin : 6
Probe : CB4_FCC_EFS_S2_30M-1GHz_1116 - HORIZONTAL	Power : DC 5V
EUT : LoRa Module	Note : Mode 2: Tx_ANT2_914.9MHz

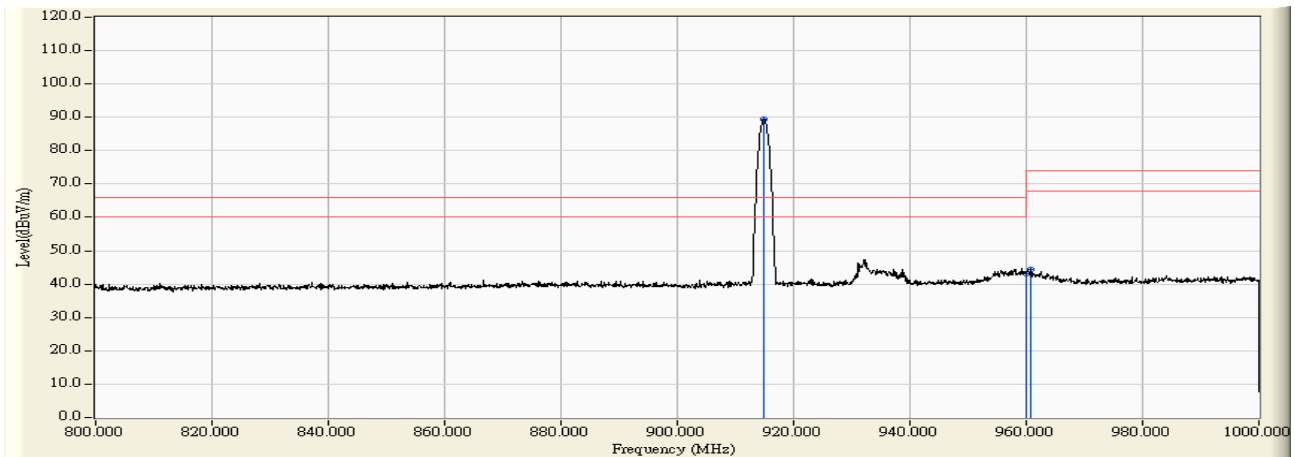

		Frequency (MHz)	Correct Factor (dB)	Reading Level (dBuV)	Measure Level (dBuV/m)	Margin (dB)	Limit (dBuV/m)	Detector Type
1	*	914.900	-9.545	98.951	89.406	23.386	66.020	PEAK
2		960.000	-8.864	52.028	43.164	-22.856	66.020	PEAK
3		960.800	-8.898	53.440	44.542	-29.458	74.000	PEAK

Note:

1. All readings above 1GHz are performed with peak and/or average measurements as necessary.
2. Peak measurements: RBW = 1MHz, VBW = 1MHz, Sweep: Auto.
3. Average measurements: RBW = 1MHz, VBW = 10 Hz, Sweep: Auto.
4. “ * ”, means this data is the worst emission level.
5. Measurement Level = Reading Level + Correct Factor.
6. The average measurement was not performed when the peak measured data under the limit of average detection. If the readings given are average, peak measurement should also be supplied.

Site : CB4-H	Time : 2017/08/26
Limit : FCC_SpartC_15.209_03M_AV	Margin : 6
Probe : CB4_FCC_EFS_S2_30M-1GHz_1116 - HORIZONTAL	Power : DC 5V
EUT : LoRa Module	Note : Mode 2: Tx_ANT2_914.9MHz

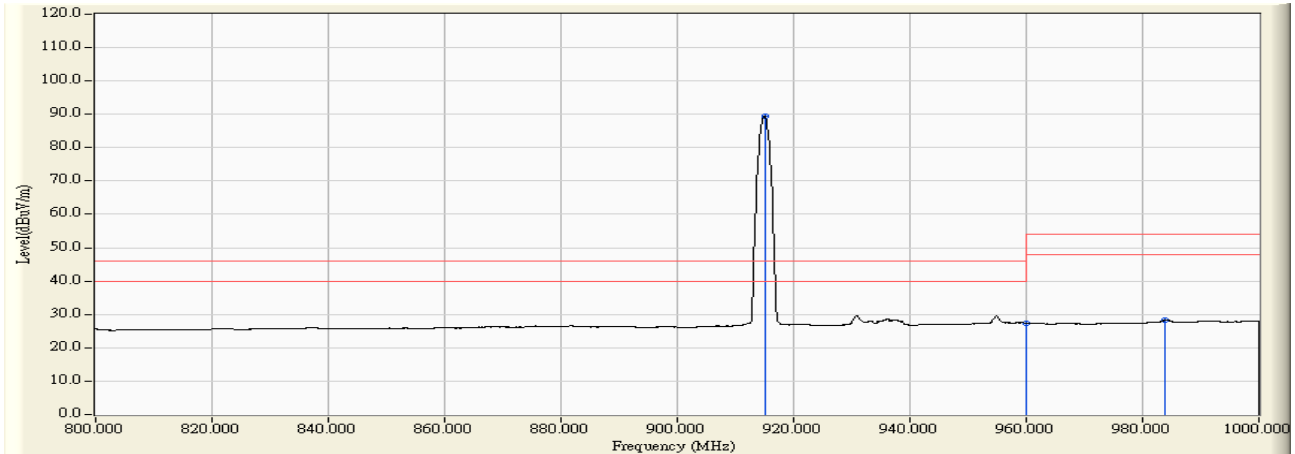

		Frequency (MHz)	Correct Factor (dB)	Reading Level (dBuV)	Measure Level (dBuV/m)	Margin (dB)	Limit (dBuV/m)	Detector Type
1	*	915.000	-9.539	98.936	89.396	43.376	46.020	AVERAGE
2		960.000	-8.864	36.284	27.420	-18.600	46.020	AVERAGE
3		983.800	-8.475	36.745	28.270	-25.730	54.000	AVERAGE

Note:

1. All readings above 1GHz are performed with peak and/or average measurements as necessary.
2. Peak measurements: RBW = 1MHz, VBW = 1MHz, Sweep: Auto.
3. Average measurements: RBW = 1MHz, VBW = 10 Hz, Sweep: Auto.
4. “ * ”, means this data is the worst emission level.
5. Measurement Level = Reading Level + Correct Factor.
6. The average measurement was not performed when the peak measured data under the limit of average detection. If the readings given are average, peak measurement should also be supplied.

Site : CB4-H	Time : 2017/08/26
Limit : FCC_SpartC_15.209_03M_PK	Margin : 6
Probe : CB4_FCC_EFS_S2_30M-1GHz_1116 - VERTICAL	Power : DC 5V
EUT : LoRa Module	Note : Mode 2: Tx_ANT2_914.9MHz

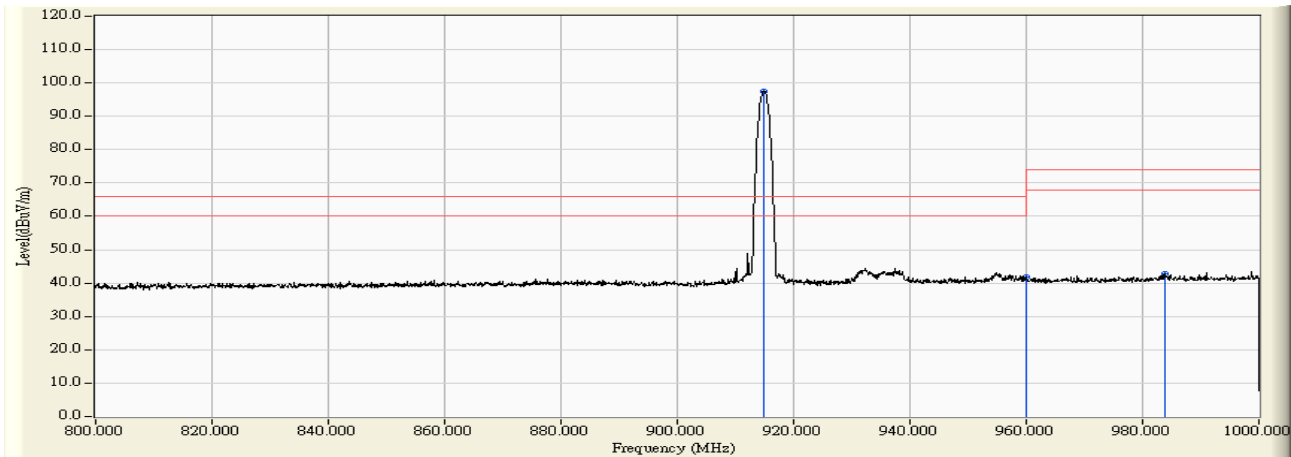

		Frequency (MHz)	Correct Factor (dB)	Reading Level (dBuV)	Measure Level (dBuV/m)	Margin (dB)	Limit (dBuV/m)	Detector Type
1	*	914.900	-9.545	107.182	97.637	31.617	66.020	PEAK
2		960.000	-8.864	50.563	41.699	-24.321	66.020	PEAK
3		983.800	-8.475	51.241	42.766	-31.234	74.000	PEAK

Note:

1. All readings above 1GHz are performed with peak and/or average measurements as necessary.
2. Peak measurements: RBW = 1MHz, VBW = 1MHz, Sweep: Auto.
3. Average measurements: RBW = 1MHz, VBW = 10 Hz, Sweep: Auto.
4. “ * ”, means this data is the worst emission level.
5. Measurement Level = Reading Level + Correct Factor.
6. The average measurement was not performed when the peak measured data under the limit of average detection. If the readings given are average, peak measurement should also be supplied.

Site : CB4-H	Time : 2017/08/26
Limit : FCC_SpartC_15.209_03M_AV	Margin : 6
Probe : CB4_FCC_EFS_S2_30M-1GHz_1116 - VERTICAL	Power : DC 5V
EUT : LoRa Module	Note : Mode 2: Tx_ANT2_914.9MHz

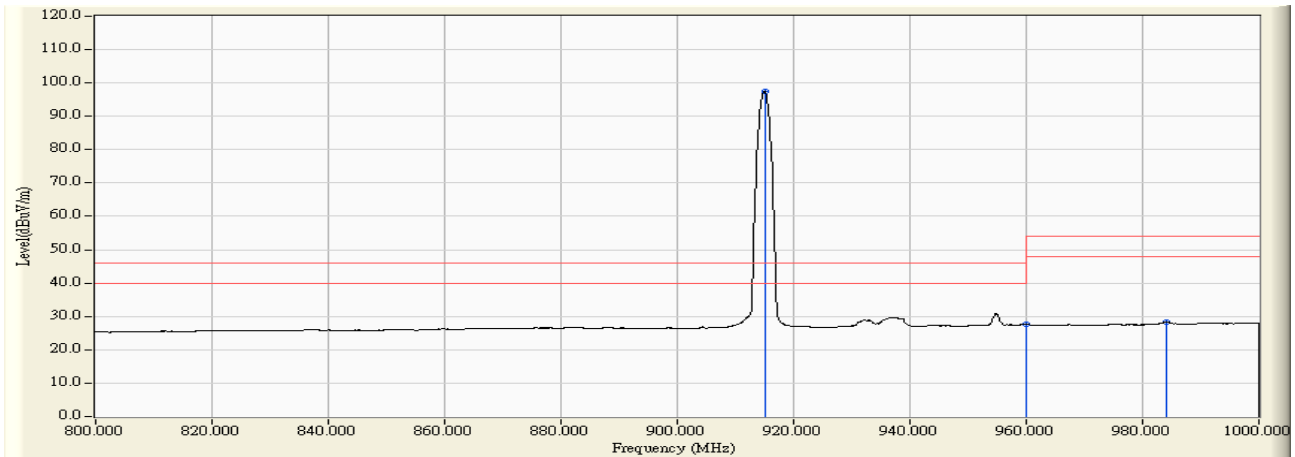

		Frequency (MHz)	Correct Factor (dB)	Reading Level (dBuV)	Measure Level (dBuV/m)	Margin (dB)	Limit (dBuV/m)	Detector Type
1	*	915.000	-9.539	107.003	97.463	51.443	46.020	AVERAGE
2		960.000	-8.864	36.467	27.603	-18.417	46.020	AVERAGE
3		984.000	-8.475	36.757	28.282	-25.718	54.000	AVERAGE

Note:

1. All readings above 1GHz are performed with peak and/or average measurements as necessary.
2. Peak measurements: RBW = 1MHz, VBW = 1MHz, Sweep: Auto.
3. Average measurements: RBW = 1MHz, VBW = 10 Hz, Sweep: Auto.
4. “ * ”, means this data is the worst emission level.
5. Measurement Level = Reading Level + Correct Factor.
6. The average measurement was not performed when the peak measured data under the limit of average detection. If the readings given are average, peak measurement should also be supplied.

7. Number of hopping frequency

7.1. Test Equipment

The following test equipment is used during the test:

Number of hopping Frequency / SR10-H

Instrument	Manufacturer	Model No.	Serial No.	Cal. Date	Next Cal. Date
Signal & Spectrum Analyzer	R&S	FSV40	101049	2017/01/23	2018/01/22
EXA Signal Analyzer	Keysight	N9010A	MY51440132	2017/03/13	2018/03/12
Spectrum Analyzer	Agilent	N9010A	US47140172	2017/07/26	2018/07/25

7.2. Test Setup

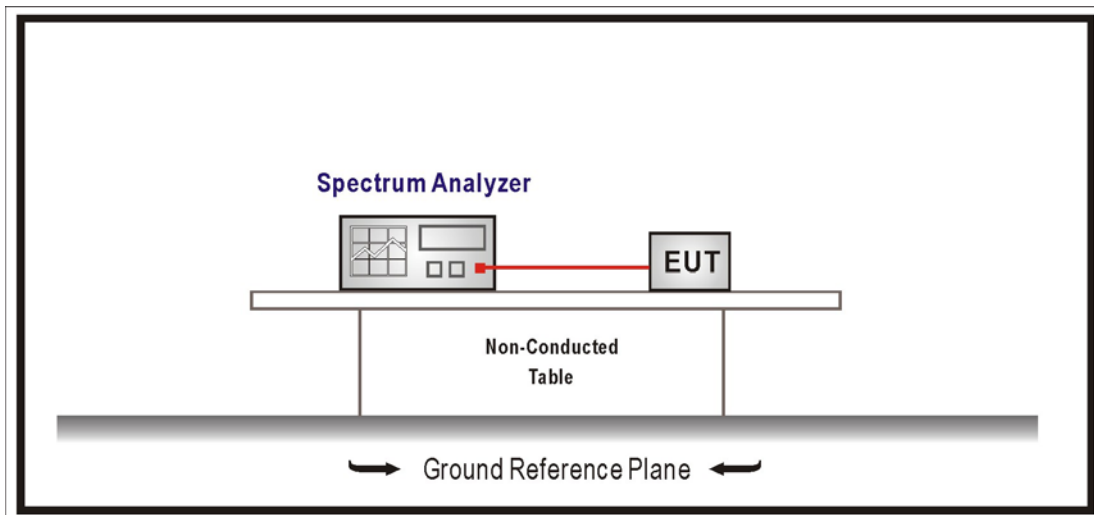

7.3. Limits

For frequency hopping systems operating in the 902-928 MHz band: if the 20 dB bandwidth of the hopping channel is less than 250 kHz, the system shall use at least 50 hopping frequencies and the average time of occupancy on any frequency shall not be greater than 0.4 seconds within a 20 second period; if the 20 dB bandwidth of the hopping channel is 250 kHz or greater, the system shall use at least 25 hopping frequencies and the average time of occupancy on any frequency shall not be greater than 0.4 seconds within a 10 second period. The maximum allowed 20 dB bandwidth of the hopping channel is 500 kHz.

For frequency hopping systems operating in the 2400-2483.5 MHz bands, which use fewer than 75 hopping frequencies, may employ intelligent hopping techniques to avoid interference to other transmissions. Frequency hopping systems may avoid or suppress transmissions on a particular hopping frequency provided that a minimum of 15 non-overlapping channels are used.

For frequency hopping systems operating in the 5725-5850 MHz band shall use at least 75 hopping frequencies.

7.4. Test Procedures

The EUT was setup according to ANSI C63.10: 2013 and tested according to FHSS test procedure of FCC Public Notice DA 00-705 for compliance to FCC 47CFR 15.247 requirements ,

Span = the frequency band of operation ,RBW \geq 1% of the span, VBW \geq RBW,

Sweep = auto, Detector function = peak, Trace = max hold.

7.5. Test Specification

According to FCC Part 15 Subpart C Paragraph 15.247: 2015

7.6. Test Result

Product	LoRa Module		
Test Item	Number of hopping frequency		
Test Mode	Mode 1: Tx_ANT1		
Date of Test	2017/08/21	Test Site	SR10-H

Frequency Range (MHz)	Measure Level (Channels)	Limit (Channels)	Result
902.3~914.9	64	≥ 50	Pass

902.3~914.9MHz

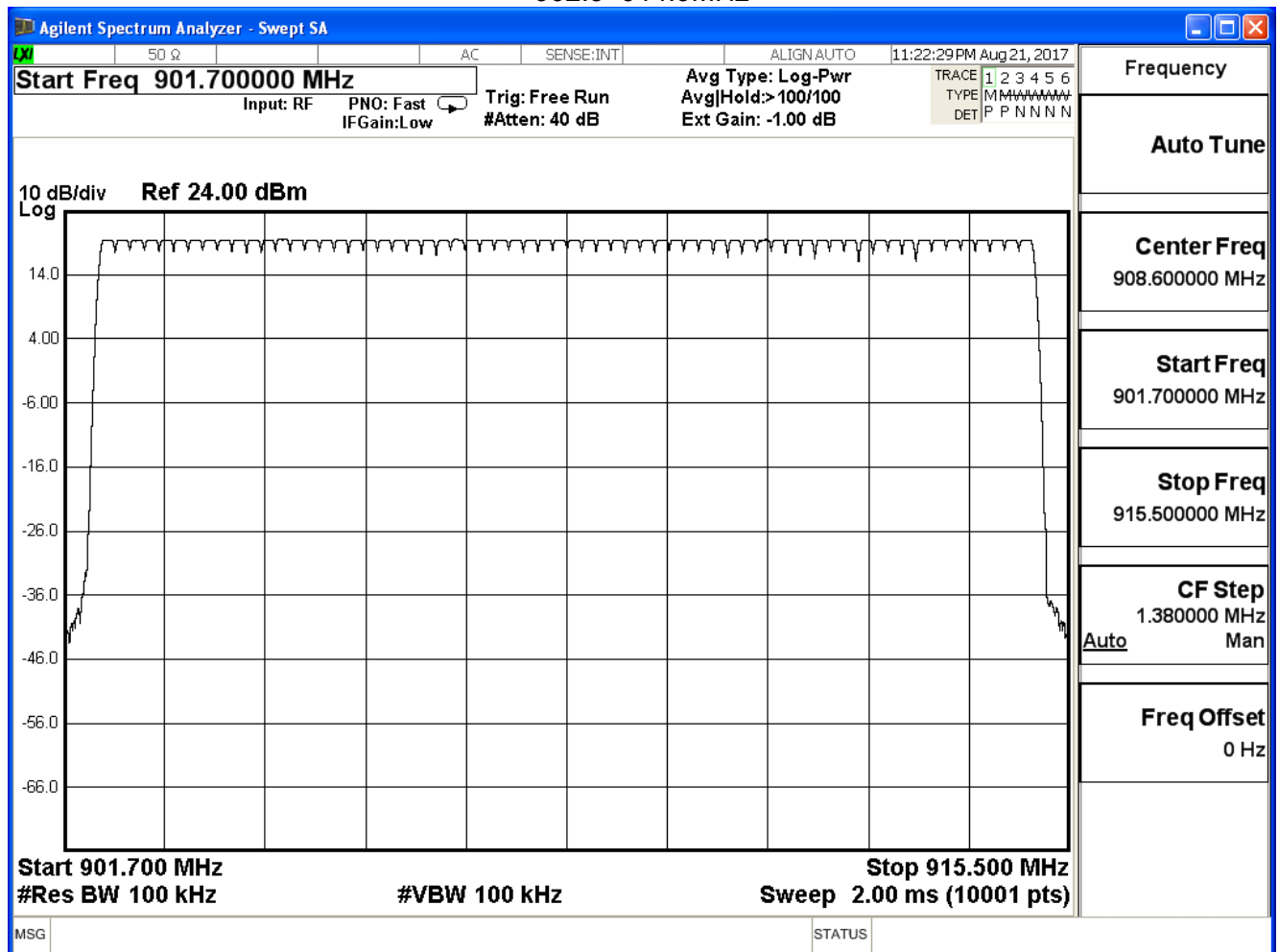

8. Carrier Frequency Separation

8.1. Test Equipment

The following test equipment is used during the test:

Carrier Frequency Separation / SR10-H

Instrument	Manufacturer	Model No.	Serial No.	Cal. Date	Next Cal. Date
Signal & Spectrum Analyzer	R&S	FSV40	101049	2017/01/23	2018/01/22
EXA Signal Analyzer	Keysight	N9010A	MY51440132	2017/03/13	2018/03/12
Spectrum Analyzer	Agilent	N9010A	US47140172	2017/07/26	2018/07/25

8.2. Test Setup

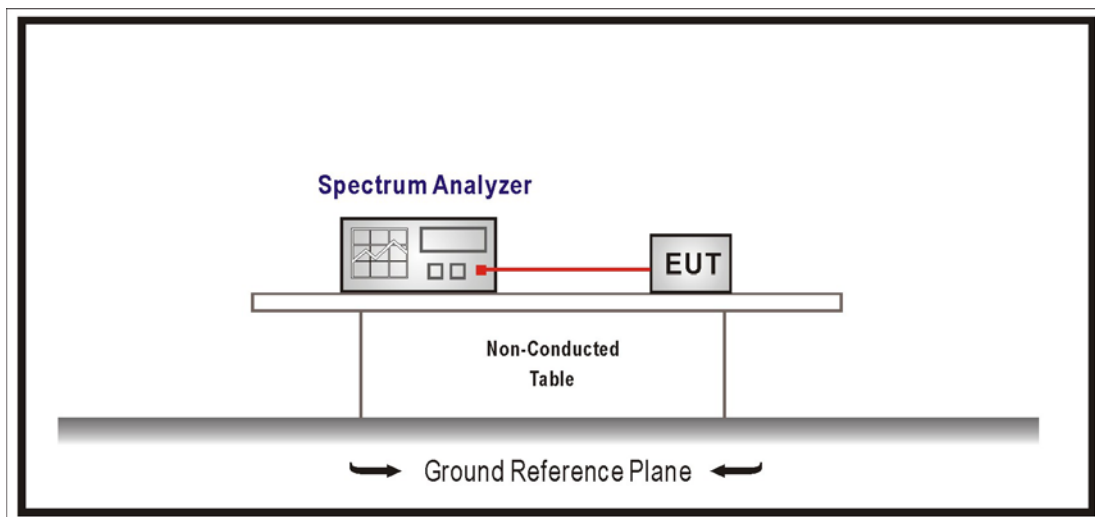

8.3. Limits

For frequency hopping systems shall have hopping channel carrier frequencies separated by a minimum of 25 kHz or two-thirds of the 20 dB bandwidth of the hopping channel, whichever is greater.

8.4. Test Procedures

The EUT was setup according to ANSI C63.10: 2013 and tested according to FHSS test procedure of FCC Public Notice DA 00-705 for compliance to FCC 47CFR 15.247 requirements

Span = wide enough to capture the peaks of two adjacent channels

Resolution Bandwidth (RBW) \geq 1% of the span, VBW \geq RBW

Sweep = auto, Detector function = peak, Trace = max hold

8.5. Test Specification

According to FCC Part 15 Subpart C Paragraph 15.247: 2015

8.6. Test Result

Product	LoRa Module		
Test Item	Carrier Frequency Separation		
Test Mode	Mode 1: Tx_ANT1		
Date of Test	2017/08/22	Test Site	SR10-H

Frequency (MHz)	Measure Level (MHz)	Limit (MHz)	Result
902.3	-0.153	0.738	Pass
908.5	-0.053	0.739	Pass
914.9	0.016	0.738	Pass

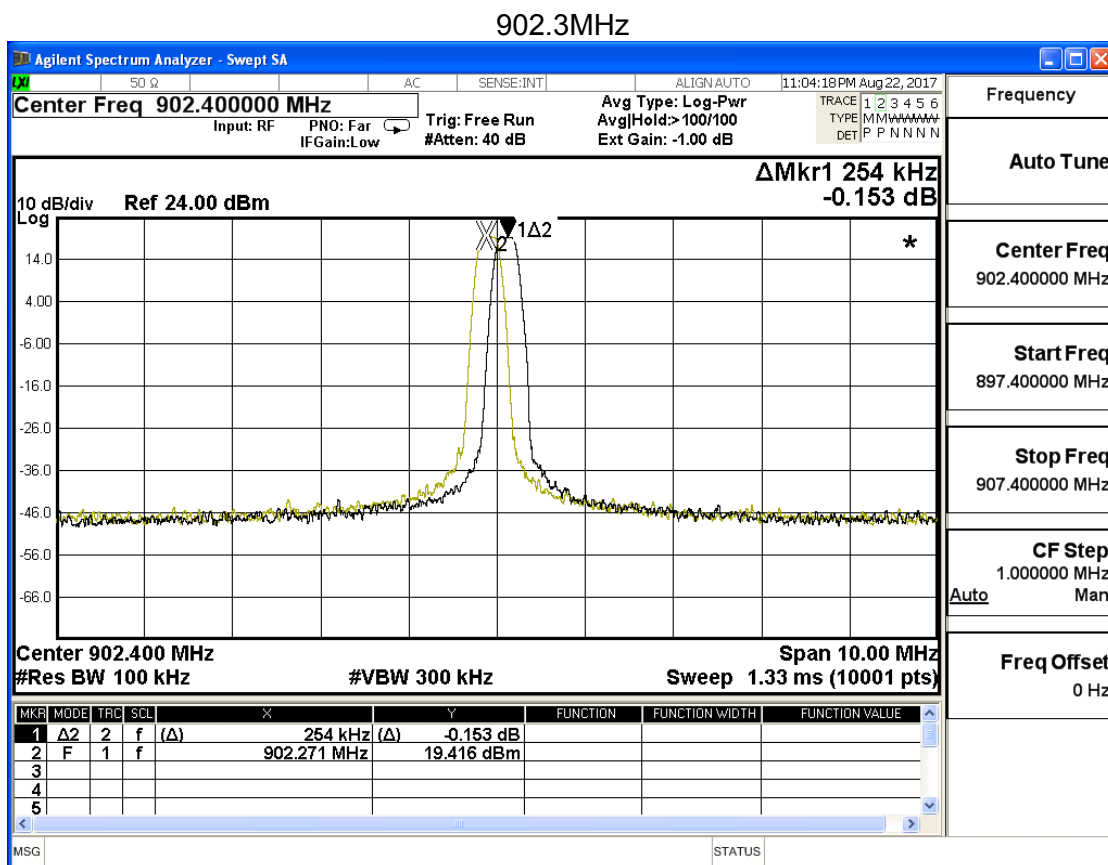

908.5MHz

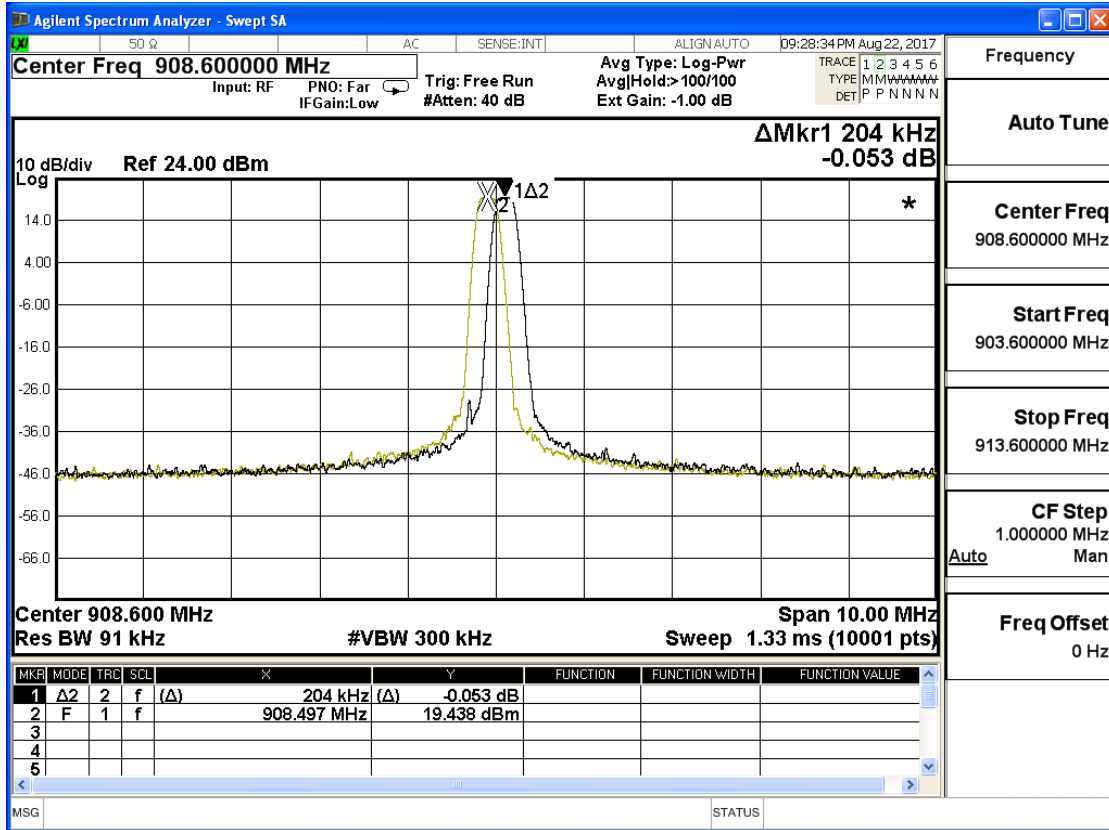

914.9MHz

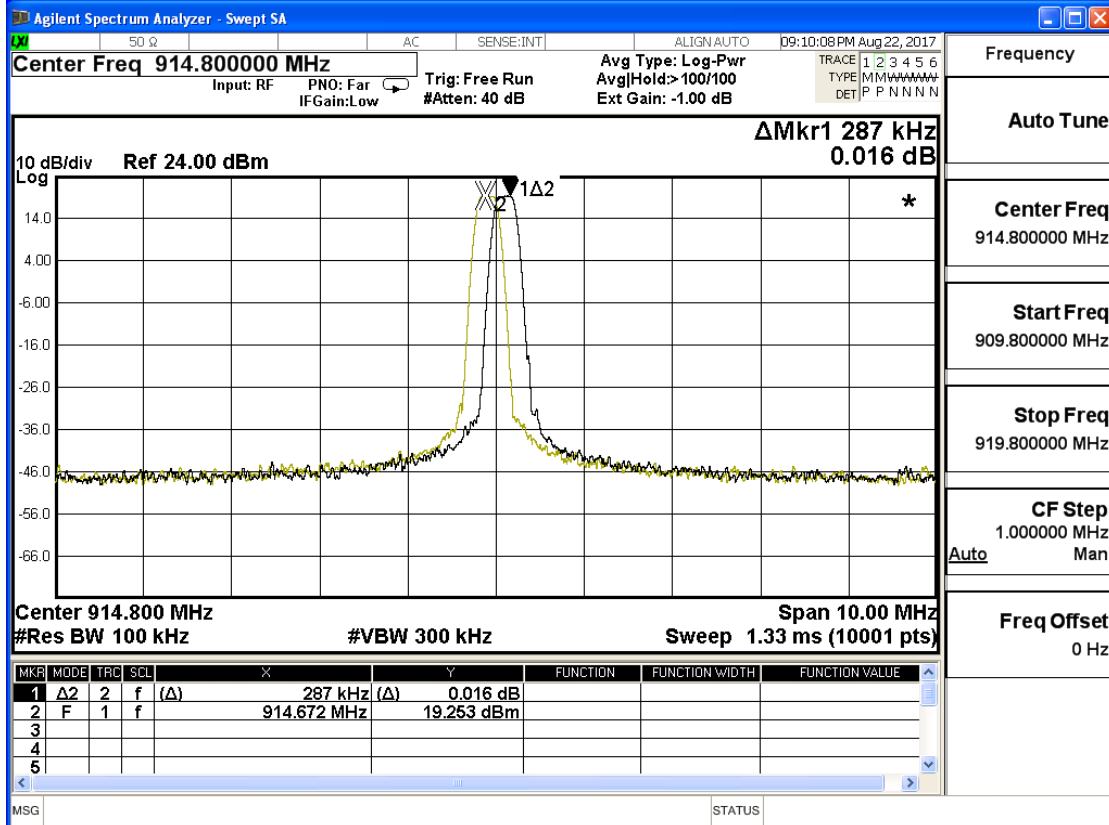

9. Occupied Bandwidth

9.1. Test Equipment

The following test equipment is used during the test:

Occupied Bandwidth / SR10-H

Instrument	Manufacturer	Model No.	Serial No.	Cal. Date	Next Cal. Date
Signal & Spectrum Analyzer	R&S	FSV40	101049	2017/01/23	2018/01/22
EXA Signal Analyzer	Keysight	N9010A	MY51440132	2017/03/13	2018/03/12
Spectrum Analyzer	Agilent	N9010A	US47140172	2017/07/26	2018/07/25

9.2. Test Setup

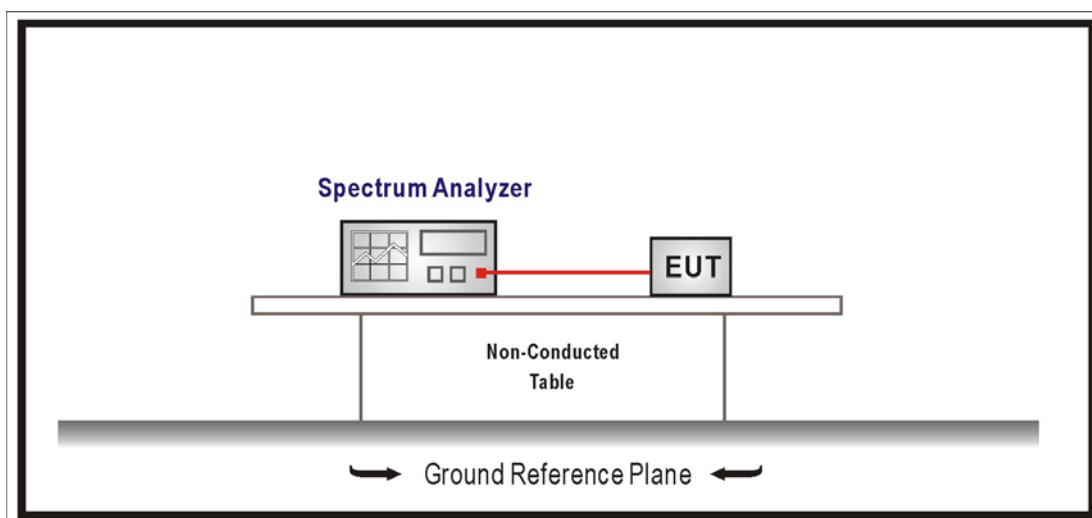

9.3. Limits

For frequency hopping systems operating in the 902-928 MHz band: if the 20 dB bandwidth of the hopping channel is less than 250 kHz, the system shall use at least 50 hopping frequencies and the average time of occupancy on any frequency shall not be greater than 0.4 seconds within a 20 second period; if the 20 dB bandwidth of the hopping channel is 250 kHz or greater, the system shall use at least 25 hopping frequencies and the average time of occupancy on any frequency shall not be greater than 0.4 seconds within a 10 second period. The maximum allowed 20 dB bandwidth of the hopping channel is 500 kHz.

For frequency hopping systems operating in the 5725-5850 MHz bands. The maximum 20 dB bandwidth of the hopping channel is 1 MHz.

For frequency hopping systems shall have hopping channel carrier frequencies separated by a minimum of 25 kHz or the 20 dB bandwidth of the hopping channel, whichever is greater.

9.4. Test Procedures

The EUT was setup according to ANSI C63.10: 2013 and tested according to FHSS test procedure of FCC Public Notice DA 00-705 for compliance to FCC 47CFR 15.247 requirements

Use the following spectrum analyzer settings:

Span = approximately 2 to 3 times the 20 dB bandwidth, centered on a hopping channel
RBW \geq 1% of the 20 dB bandwidth, VBW \geq RBW , Sweep = auto, Detector function = peak,
Trace = max hold , The EUT should be transmitting at its maximum data rate.

9.5. Test Specification

According to FCC Part 15 Subpart C Paragraph 15.247: 2015

9.6. Test Result

Product	LoRa Module		
Test Item	Occupied Bandwidth		
Test Mode	Mode 1: Tx_ANT1		
Date of Test	2017/08/22	Test Site	SR10-H

Frequency (MHz)	Measure Level (KHz)	Limit (MHz)	Result
902.3	138.0	--	Pass
908.5	138.8	--	Pass
914.9	137.8	--	Pass

902.3MHz

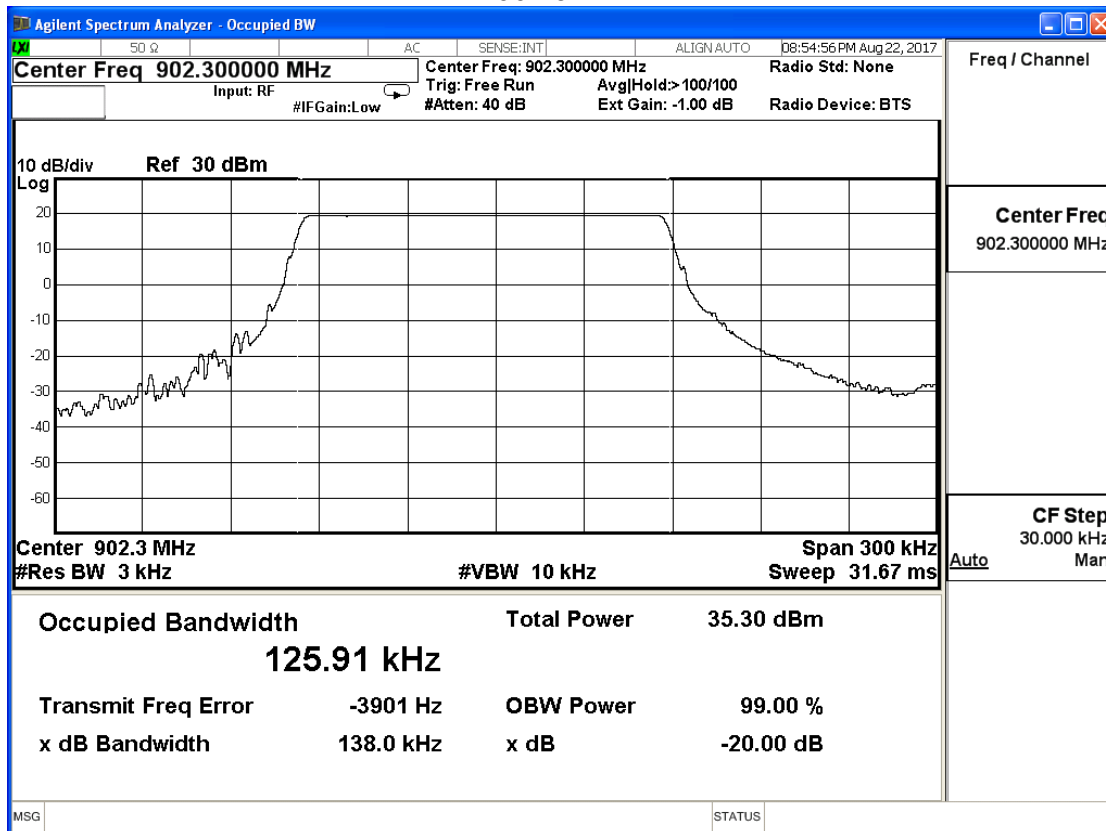

908.5MHz

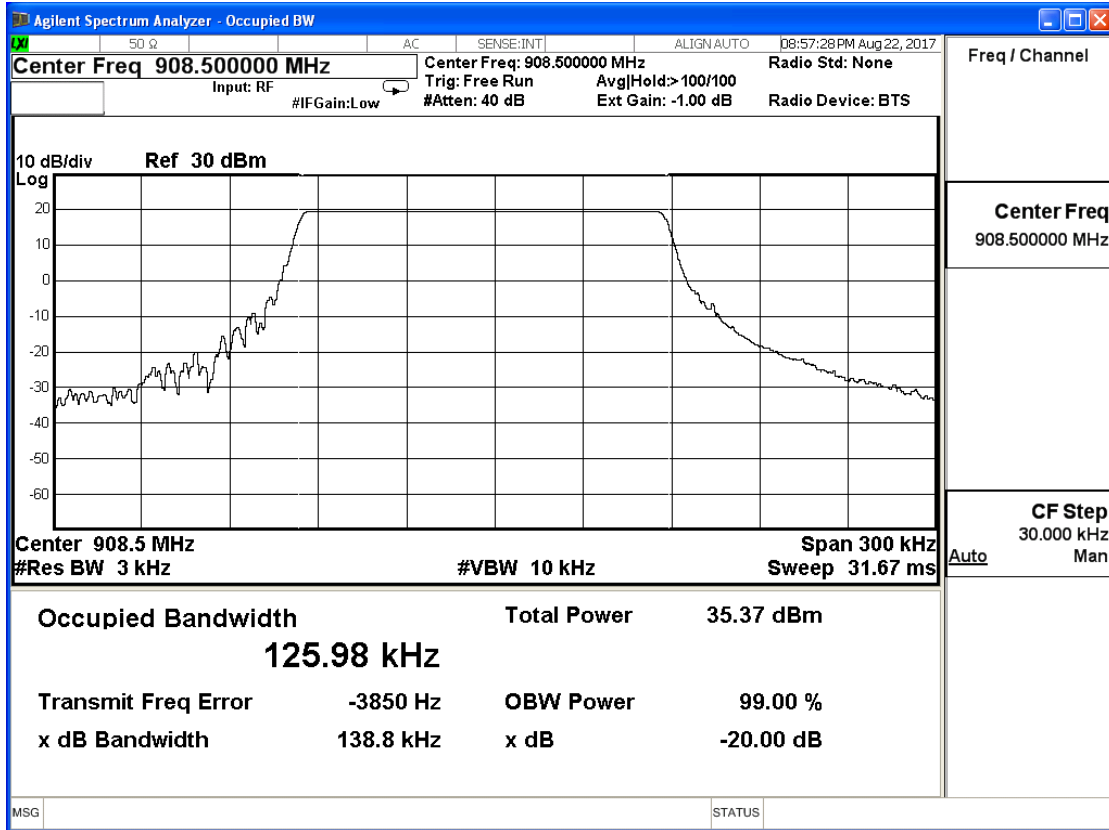

914.9MHz



10. Dwell Time

10.1. Test Equipment

The following test equipment is used during the test:

Dwell Time / SR10-H

Instrument	Manufacturer	Model No.	Serial No.	Cal. Date	Next Cal. Date
Signal & Spectrum Analyzer	R&S	FSV40	101049	2017/01/23	2018/01/22
EXA Signal Analyzer	Keysight	N9010A	MY51440132	2017/03/13	2018/03/12
Spectrum Analyzer	Agilent	N9010A	US47140172	2017/07/26	2018/07/25

10.2. Test Setup

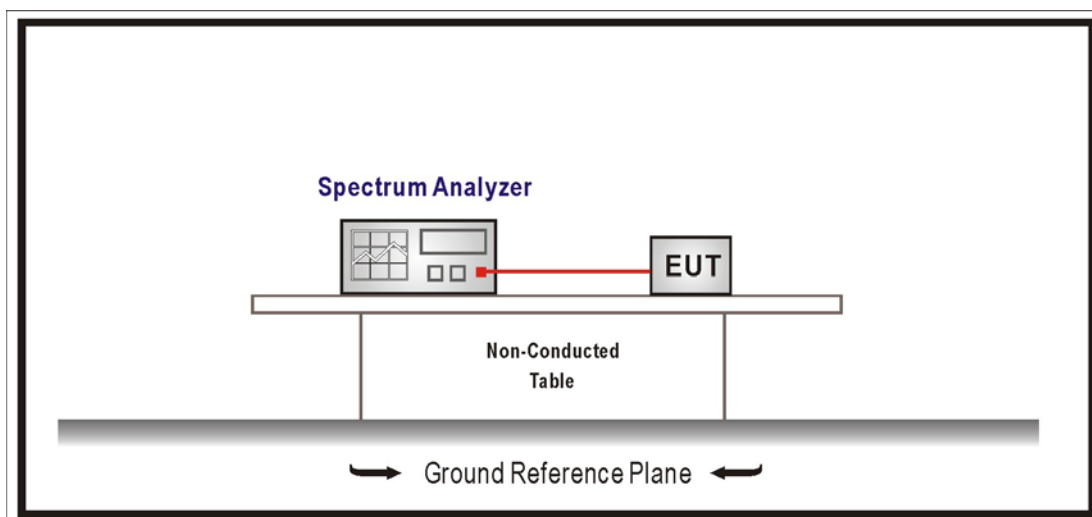

10.3. Limits

For frequency hopping systems operating in the 902-928 MHz band: if the 20 dB bandwidth of the hopping channel is less than 250 kHz, the system shall use at least 50 hopping frequencies and the average time of occupancy on any frequency shall not be greater than 0.4 seconds within a 20 second period; if the 20 dB bandwidth of the hopping channel is 250 kHz or greater, the system shall use at least 25 hopping frequencies and the average time of occupancy on any frequency shall not be greater than 0.4 seconds within a 10 second period. For frequency hopping systems operating in the 2400-2483.5 MHz bands. The average time of occupancy on any channel shall not be greater than 0.4 seconds within a period of 0.4 seconds multiplied by the number of hopping channels employed. For frequency hopping systems operating in the 5725-5850 MHz bands. The average time of occupancy on any frequency shall not be greater than 0.4 seconds within a 30 second period.

10.4. Test Procedures

The EUT was setup according to ANSI C63.10: 2013 and tested according to FHSS test procedure of FCC Public Notice DA 00-705 for compliance to FCC 47CFR 15.247 requirements

Span = zero span, centered on a hopping channel, RBW = 1 MHz, VBW \geq RBW,
Sweep = as necessary to capture the entire dwell time per hopping channel,
Detector function = peak, Trace = max hold.

10.5. Test Specification

According to FCC Part 15 Subpart C Paragraph 15.247: 2015

10.6. Test Result

Product	LoRa Module		
Test Item	Dwell Time		
Test Mode	Mode 1: Tx_ANT1		
Date of Test	2017/08/18	Test Site	SR10-H

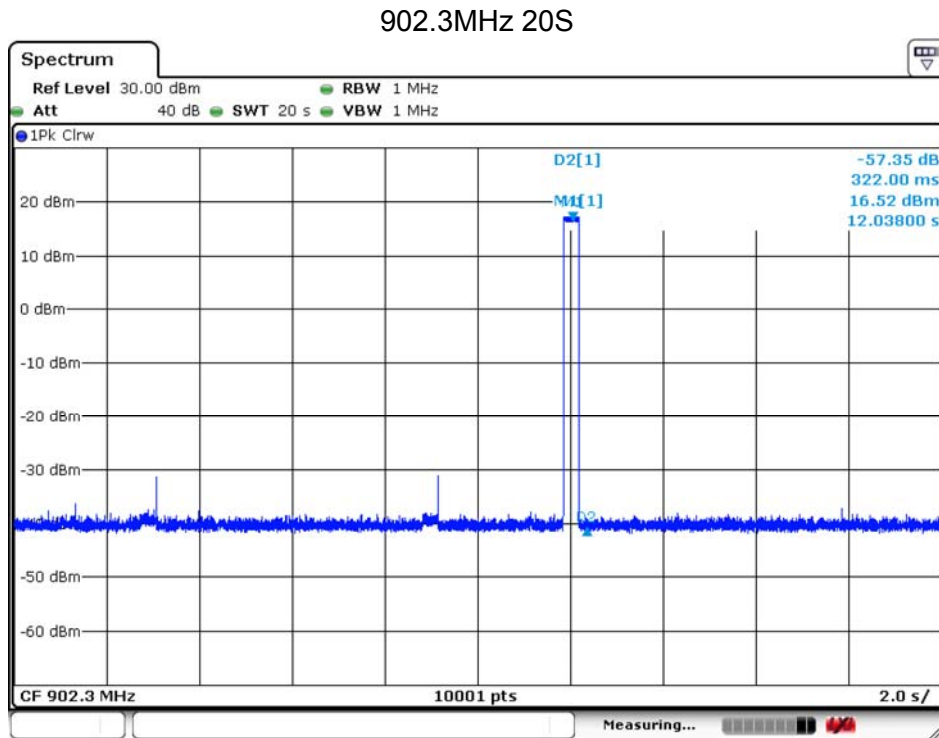

Date: 18.AUG.2017 17:15:34

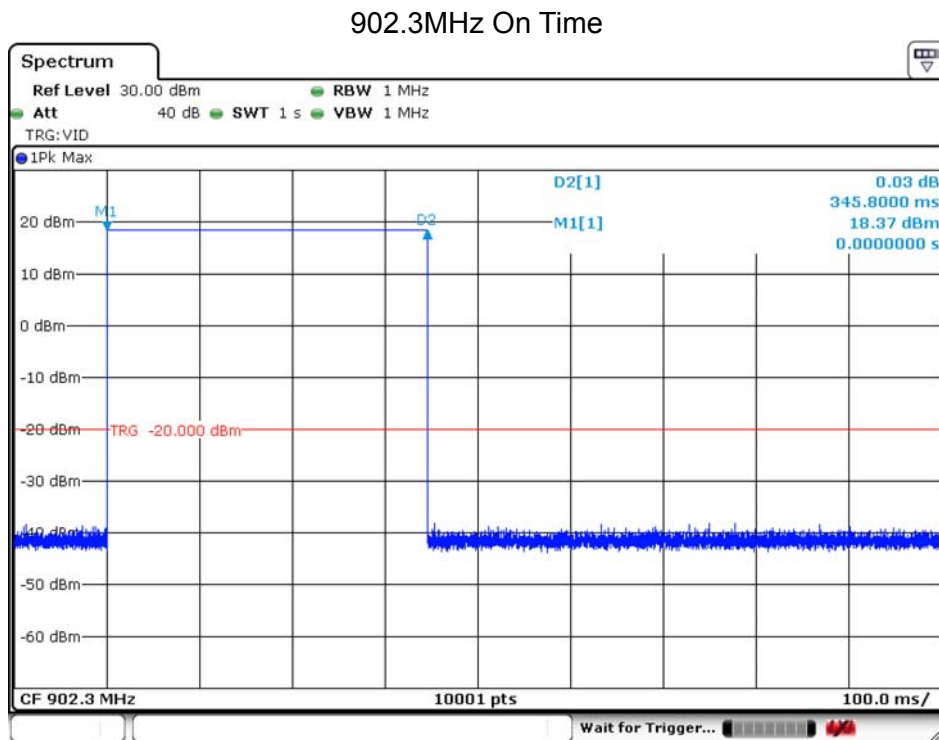

Date: 18.AUG.2017 17:04:52

908.5MHz 20S

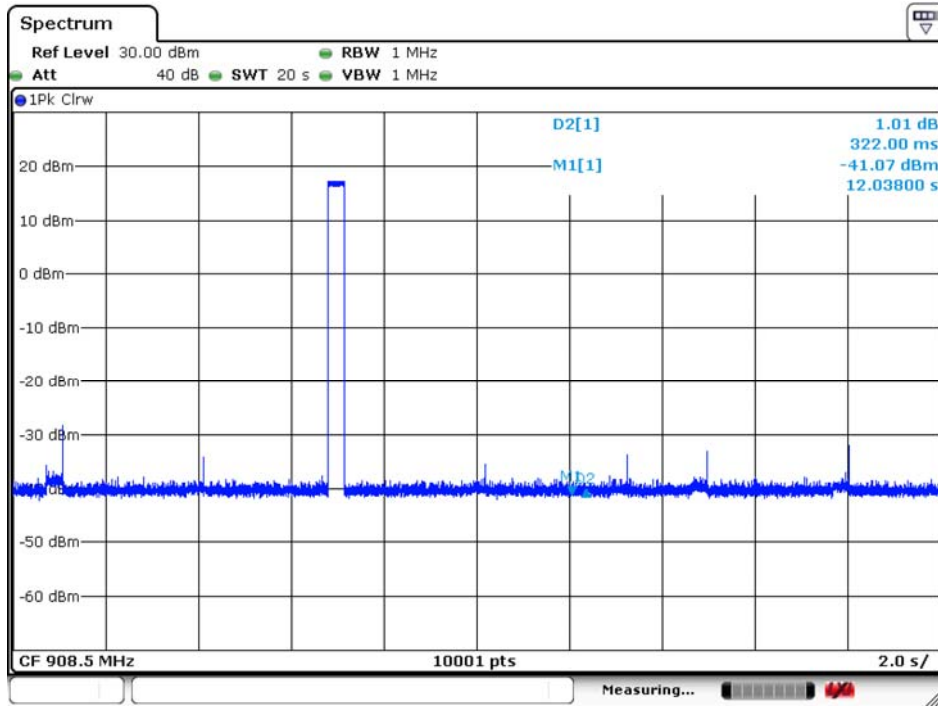

Date: 18.AUG.2017 17:29:06

908.5MHz On Time

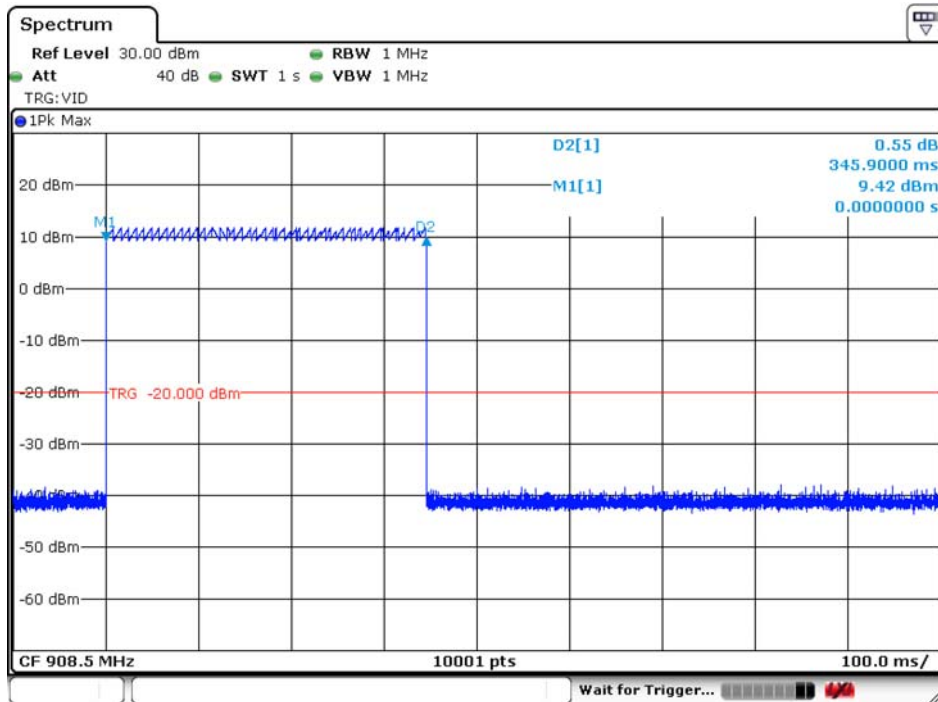

Date: 18.AUG.2017 17:06:20

914.9MHz 20S

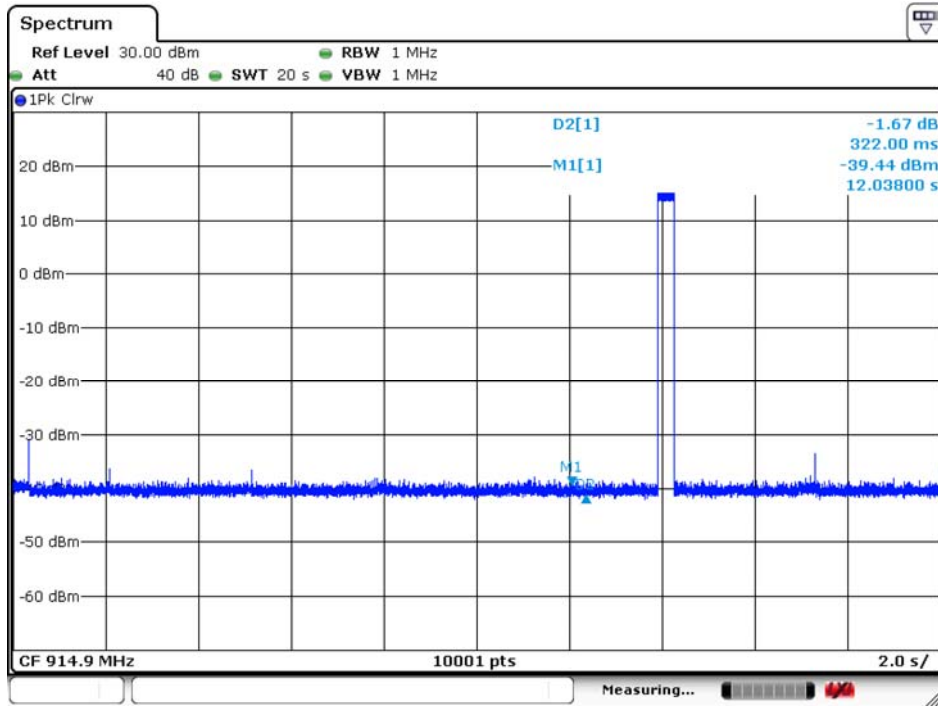

Date: 18.AUG.2017 17:41:09

914.9MHz On Time

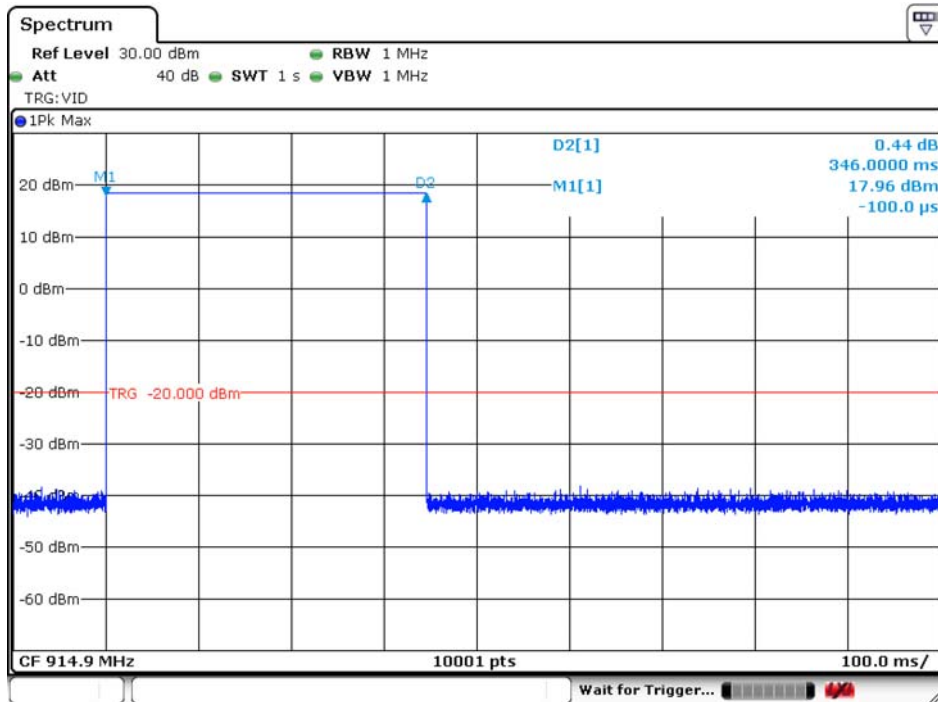

Date: 18.AUG.2017 17:07:24

Test Result	PASS
-------------	------