

V SEVEN

HB600S
WIRELESS STEREO HEADSET
USER GUIDE

 **Bluetooth**[®]



In the Box



HB600S Stereo Headset



V7 Link Bluetooth Dongle

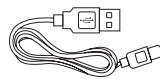

Type-C Charging Cable



Boom Mic

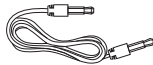

3.5mm Audio Cable



Storage Bag



User Guide

Overview

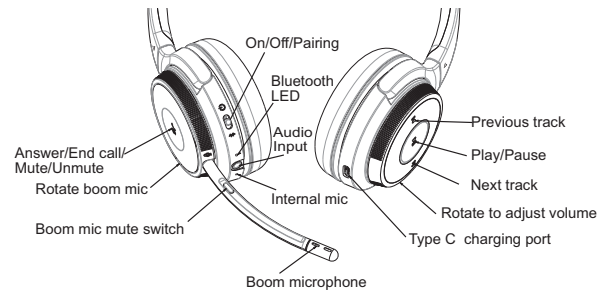

How to Wear

1. Insert the detachable Boom Microphone into the 2.5mm receptacle located on the headset.

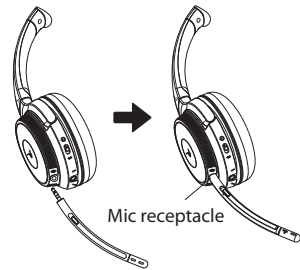

2. The boom microphone can move to accommodate a user's preference for right side or left side wear.



3. Position the microphone to your preference.

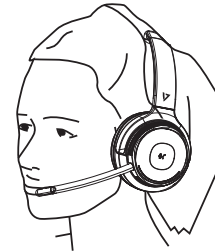

Operation

Power On

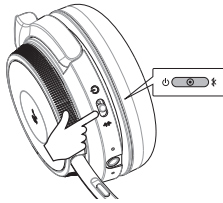

Slide the switch to the CENTER position

Power Off

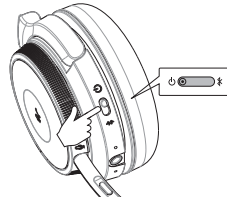

Slide the switch to the  position

Connecting to a PC

PC(w/V7's Bluetooth Dongle)

The V7 USB dongle and headset are pre-paired and ready for use. Plug in the USB dongle and power on the headset to enjoy voice and audio performance range of up to 30 meters (100') line-of sight. If using the PC's integrated Bluetooth, your range may be limited to 10 meters (33') and you may need to select 'V7 HB600S' for the audio playback device in the operating system's settings.

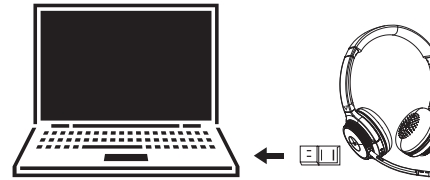

Connecting

How to connect with the first Bluetooth device.

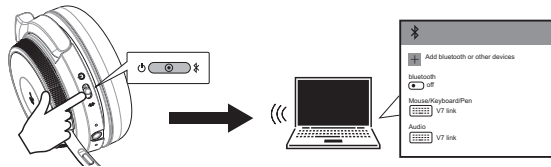

Slide the power switch to the "CENTER" position. The LED will flash red and blue when ready to connect.

Windows 10 PCs and Macs will automatically recognize and install drivers.

Connecting to the second Bluetooth device.

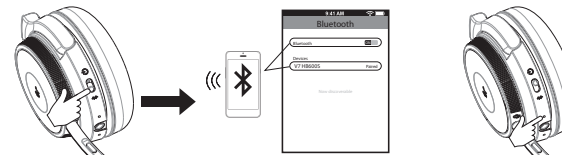

Slide the power switch to the "Bluetooth" position and hold until 'pairing' heard or the pairing LED flashes, then select V7 HB6005.

Activate "Bluetooth" in your device's settings and select "V7 HB6005".

The LED will flash blue to indicate the headphone is connected, and 'connected' is heard.

Calls with a Smartphone

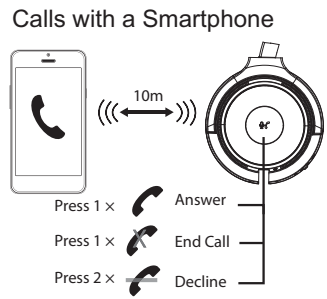

Siri/Cortana/Assistance

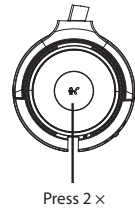

Charging the Headset

During charging the red LED will light. When fully charged, the LED will turn off. The headset remains on during charging.
To power off, the headset's power switch must be slid to the off position.

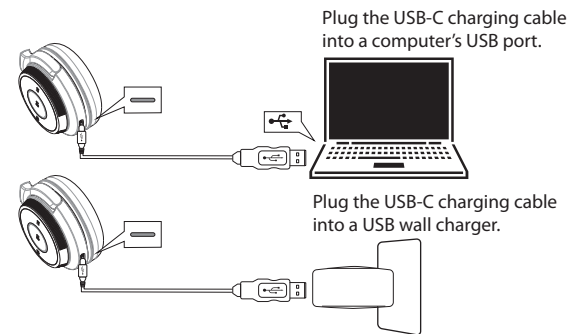

Using the charging stand

Plug the optional charging stand into a powered USB port on your PC, docking station or USB wall charger and then dock the headset. It takes approximately 3 hours to fully charge the headset.

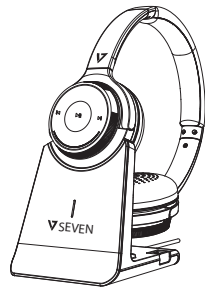

Other Operations

Muting the Boom Mic: Depress and hold the button for 2 seconds.

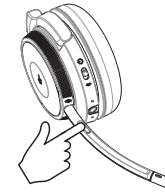

Muting the internal Mic: (When boom mic is not in use)
Depress and hold the call key 2 seconds.

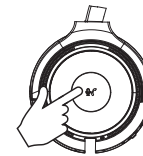

Battery Status: After the headset is powered on, press the call button briefly to hear the current battery status 100% -75%-50%-25%.

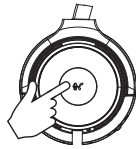

Clearing the pairing: While the headset is powered on, press and hold the previous and next track buttons simultaneously for 10 seconds. A pink LED will light for 2 seconds and the headset will then enter pairing mode.

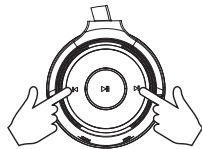

Product Specifications

Bluetooth version: Bluetooth V5.0
Bluetooth Profile: A2DPv1.3.1; AVRCPv1.6; HFPv1.7;
HSPv1.2; SPP v1.2; DID v1.3; HID v1.1; PXP v1.0.1;
FMP v1.0; BAS v1.0
Working Frequency: 2.402GHz-2.480GHz
Frequency Response: 99±3dB
Receiving sensitivity: >-89dBm
Battery type: Lithium polymer
Mic type and sensitivity: Virtual Microphone -42±3dB
Headphone Driver Size: 30mm
Battery capacity: 410mAh
DC Input: 5V_500MA
FCC ID: 2AKI8-19BF18
Charging voltage: 5V/2A
Bluetooth working range: Up to 30m
Talk time: Up to 18 hours
Charging time: Approximately 3 hours
Standby time: Approximately 175 hours
Compatibility: Windows 10, mac OS 10.14 or later,iOS and Android

WARNING

Headsets can deliver sounds at loud volumes and high-pitched tones. Avoid prolonged use of the headset at excessive sound pressure levels. Please read the safety guidelines below prior to using this headset.

Safety information

Use of a headset will impair your ability to hear other sounds. Use caution while using your headset when you are engaging in any activity that requires your full attention. This package contains small parts that may be hazardous to children and should be kept out of reach from children.

Do not attempt: To dismantle or service the product as this may cause a short circuits or other malfunction which could result in a fire or electric shock.

Avoid exposing your product to rain, moisture or other liquids to avoid damage to the product or injury to you. Keep all products, cords, and cables away from operating machinery. Avoid use while operating a motor vehicle.

Built-in battery care: Please observe the following if the product contains a battery. Your product is powered by a rechargeable battery.

The full performance of a new battery is achieved only after two or three complete charge and discharge cycles. The battery can be charged and discharged hundreds of times but will eventually wear out.

Always try to keep the battery between 15°C and 25°C (59°F and 77°F). A product with a hot or cold battery may not work temporarily, even when the battery is fully charged. Battery performance is particularly limited in temperatures well below freezing.

Battery warning!

CAUTION – The battery used in this product may present a risk of fire or chemical burn if mistreated. Do not attempt to open the product or replace the battery. This will void the warranty.

FCC Statement

Changes or modifications not expressly approved by the party responsible for compliance could void the user's authority to operate the equipment. This device complies with Part 15 of the FCC Rules. Operation is subject to the following two conditions: (1) This device may not cause harmful interference, and (2) this device must accept any interference received, including interference that may cause undesired operation.

Note: This equipment has been tested and found to comply with the limits for a Class B digital device, pursuant to Part 15 of the FCC Rules. These limits are designed to provide reasonable protection against harmful interference in a residential installation. This equipment generates, uses, and can radiate radio frequency energy, and if not installed and used in accordance with the instructions, may cause harmful interference to radio communications. However, there is no guarantee that interference will not occur in a particular installation. If this equipment does cause harmful interference to radio or television reception, which can be determined by turning the equipment off and on, the user is encouraged to try to correct the interference by one or more of the following measures:

- Reorient or relocate the receiving antenna.
- Increase the separation between the equipment and receiver.
- Connect the equipment into an outlet on a circuit different from that to which the receiver is connected.
- Consult the dealer or an experienced radio/TV technician for help.

Troubleshooting & Support

Headphones will not power on:

- Be sure the headphones are fully charged.

My mobile device is unable to find the Bluetooth headphones

- Confirm the headphones are in pairing mode (blue/red indicator lights flashing).
- Remove "V7 HB600S" from your phone's Bluetooth device list and try again.
- If the model still does not appear, restart the headset and phone, then try again.

After successfully pairing, the headphones disconnect

- Be sure the battery has adequate power and recharge.
- Headphones must be within 10m of most mobile devices.
- Connections may be affected by obstructions such as walls or other electronic devices. Try moving closer to the device you are connected to.

When answering a call, I cannot hear anything

- Ensure the mobile device is connected to the V7 HB600S headphones and not on phone's speaker or other audio option.
- Increase the volume on your mobile device.

There is no sound when listening to music

- Increase the volume on your headphones or the mobile device.
- Reestablish the Bluetooth wireless connection between the headphones and your mobile device.
- Check if the audio app has paused or stopped playback.

Headphones will not charge

- Confirm that the charging cable is operational or undamaged.
- Ensure that the USB charging cable is fully seated in the headphones and wall charger ports.
- Confirm that the USB port is outputting power. Some USB ports shut off when the PC is off.

If the sound is distorted when listening to music or there is no sound when answering a call via software under the connection via BT dongle to connect PC.

- Please click the call button twice or pull out BT dongle and turn off headset and re-plug in BT dongle and turn on headset again

Find support for the V7 HB600S at v7world.com