

FCC Report (Bluetooth)

Applicant: Shenzhen Hangshi Technology Co.,Ltd.

Address of Applicant: Hangshi Technology Park, Democracy West Industry Area, Shajing Town, Bao'an District, Shenzhen, China.

Manufacturer/ Factory: Shenzhen Hangshi Technology Co.,Ltd.

Address of Manufacturer/ Factory: Hangshi Technology Park, Democracy West Industry Area, Shajing Town, Bao'an District, Shenzhen, China.

Equipment Under Test (EUT)

Product Name: Bluetooth Keyboard

Model No.: HB197-3-L, HB197-2-L,HB198-2-L,HB198-3-L

FCC ID: 2AKHJHB197-3-L

Applicable standards: FCC CFR Title 47 Part 15 Subpart C Section 15.247

Date of sample receipt: July 07, 2018

Date of Test: July 07-24, 2018

Date of report issued: July 25, 2018

Test Result : PASS *

* In the configuration tested, the EUT complied with the standards specified above.

Authorized Signature:

Robinson Lo

Laboratory Manager

This results shown in this test report refer only to the sample(s) tested, this test report cannot be reproduced, except in full, without prior written permission of the company. The report would be invalid without specific stamp of test institute and the signatures of compiler and approver.

2 Version

| Version No. | Date | Description |
|-------------|---------------|-------------|
| 00 | July 25, 2018 | Original |
| | | |
| | | |
| | | |
| | | |

Prepared By:

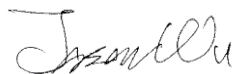

Date:

July 25, 2018

Project Engineer

Check By:

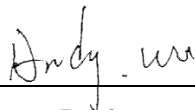

Date:

July 25, 2018

Reviewer

3 Contents

| | Page |
|---|-----------|
| 1 COVER PAGE | 1 |
| 2 VERSION | 2 |
| 3 CONTENTS | 3 |
| 4 TEST SUMMARY | 4 |
| 5 GENERAL INFORMATION | 5 |
| 5.1 GENERAL DESCRIPTION OF EUT | 5 |
| 5.2 TEST MODE | 7 |
| 5.3 DESCRIPTION OF SUPPORT UNITS | 7 |
| 5.4 TEST FACILITY | 7 |
| 5.5 TEST LOCATION | 7 |
| 5.6 ADDITIONAL INSTRUCTIONS | 8 |
| 6 TEST INSTRUMENTS LIST | 9 |
| 7 TEST RESULTS AND MEASUREMENT DATA | 11 |
| 7.1 ANTENNA REQUIREMENT | 11 |
| 7.2 CONDUCTED EMISSIONS | 12 |
| 7.3 CONDUCTED PEAK OUTPUT POWER | 21 |
| 7.4 20dB EMISSION BANDWIDTH | 23 |
| 7.5 CARRIER FREQUENCIES SEPARATION | 25 |
| 7.6 HOPPING CHANNEL NUMBER | 27 |
| 7.7 DWELL TIME | 28 |
| 7.8 PSEUDORANDOM FREQUENCY HOPPING SEQUENCE | 30 |
| 7.9 BAND EDGE | 31 |
| 7.9.1 <i>Conducted Emission Method</i> | 31 |
| 7.9.2 <i>Radiated Emission Method</i> | 33 |
| 7.10 SPURIOUS EMISSION | 35 |
| 7.10.1 <i>Conducted Emission Method</i> | 35 |
| 7.10.2 <i>Radiated Emission Method</i> | 37 |
| 8 TEST SETUP PHOTO | 51 |
| 9 EUT CONSTRUCTIONAL DETAILS | 53 |

4 Test Summary

| Test Item | Section in CFR 47 | Result |
|---|-------------------|--------|
| Antenna Requirement | 15.203/15.247 (c) | Pass |
| AC Power Line Conducted Emission | 15.207 | Pass |
| Conducted Peak Output Power | 15.247 (b)(1) | Pass |
| 20dB Occupied Bandwidth | 15.247 (a)(1) | Pass |
| Carrier Frequencies Separation | 15.247 (a)(1) | Pass |
| Hopping Channel Number | 15.247 (a)(1) | Pass |
| Dwell Time | 15.247 (a)(1) | Pass |
| Pseudorandom Frequency Hopping Sequence | 15.247(b)(4) | Pass |
| Radiated Emission | 15.205/15.209 | Pass |
| Band Edge | 15.247(d) | Pass |

Pass: The EUT complies with the essential requirements in the standard.

Remark: Test according to ANSI C63.10:2013

Measurement Uncertainty

| Test Item | Frequency Range | Measurement Uncertainty | Notes |
|----------------------------------|-----------------|-------------------------|-------|
| Radiated Emission | 9kHz ~ 30MHz | ± 4.34dB | (1) |
| Radiated Emission | 30MHz ~ 1000MHz | ± 4.24dB | (1) |
| Radiated Emission | 1GHz ~ 26.5GHz | ± 4.68dB | (1) |
| AC Power Line Conducted Emission | 0.15MHz ~ 30MHz | ± 3.45dB | (1) |

Note (1): The measurement uncertainty is for coverage factor of k=2 and a level of confidence of 95%.

5 General Information

5.1 General Description of EUT

| | |
|----------------------|--|
| Product Name: | Bluetooth Keyboard |
| Model No.: | HB197-3-L, HB197-2-L,HB198-2-L,HB198-3-L |
| Test Model No: | HB197-3-L |
| Serial No.: | HSHB1973L00005 |
| Test sample(s) ID: | GTS201807000080-1 |
| Sample(s) Status | Engineer sample |
| Hardware version: | V1.0 |
| Software version: | V1.0 |
| Operation Frequency: | 2402MHz~2480MHz |
| Channel numbers: | 79 |
| Channel separation: | 1MHz |
| Modulation type: | GFSK |
| Antenna Type: | PCB Antenna |
| Antenna gain: | 1.87dBi |
| Power supply: | DC3.7V |

| Operation Frequency each of channel | | | | | | | |
|-------------------------------------|-----------|---------|-----------|---------|-----------|---------|-----------|
| Channel | Frequency | Channel | Frequency | Channel | Frequency | Channel | Frequency |
| 1 | 2402MHz | 21 | 2422MHz | 41 | 2442MHz | 61 | 2462MHz |
| 2 | 2403MHz | 22 | 2423MHz | 42 | 2443MHz | 62 | 2463MHz |
| 3 | 2404MHz | 23 | 2424MHz | 43 | 2444MHz | 63 | 2464MHz |
| 4 | 2405MHz | 24 | 2425MHz | 44 | 2445MHz | 64 | 2465MHz |
| 5 | 2406MHz | 25 | 2426MHz | 45 | 2446MHz | 65 | 2466MHz |
| 6 | 2407MHz | 26 | 2427MHz | 46 | 2447MHz | 66 | 2467MHz |
| 7 | 2408MHz | 27 | 2428MHz | 47 | 2448MHz | 67 | 2468MHz |
| 8 | 2409MHz | 28 | 2429MHz | 48 | 2449MHz | 68 | 2469MHz |
| 9 | 2410MHz | 29 | 2430MHz | 49 | 2450MHz | 69 | 2470MHz |
| 10 | 2411MHz | 30 | 2431MHz | 50 | 2451MHz | 70 | 2471MHz |
| 11 | 2412MHz | 31 | 2432MHz | 51 | 2452MHz | 71 | 2472MHz |
| 12 | 2413MHz | 32 | 2433MHz | 52 | 2453MHz | 72 | 2473MHz |
| 13 | 2414MHz | 33 | 2434MHz | 53 | 2454MHz | 73 | 2474MHz |
| 14 | 2415MHz | 34 | 2435MHz | 54 | 2455MHz | 74 | 2475MHz |
| 15 | 2416MHz | 35 | 2436MHz | 55 | 2456MHz | 75 | 2476MHz |
| 16 | 2417MHz | 36 | 2437MHz | 56 | 2457MHz | 76 | 2477MHz |
| 17 | 2418MHz | 37 | 2438MHz | 57 | 2458MHz | 77 | 2478MHz |
| 18 | 2419MHz | 38 | 2439MHz | 58 | 2459MHz | 78 | 2479MHz |
| 19 | 2420MHz | 39 | 2440MHz | 59 | 2460MHz | 79 | 2480MHz |
| 20 | 2421MHz | 40 | 2441MHz | 60 | 2461MHz | | |

Note:

In section 15.31(m), regards to the operating frequency range over 10 MHz, the Lowest frequency, the middle frequency, and the highest frequency of channel were selected to perform the test, and the selected channel see below:

| Channel | Frequency |
|---------------------|-----------|
| The lowest channel | 2402MHz |
| The middle channel | 2441MHz |
| The Highest channel | 2480MHz |

5.2 Test mode

| | |
|--|---|
| Transmitting mode | Keep the EUT in continuously transmitting mode. |
| <i>Remark: During the test, the test voltage was tuned from 85% to 115% of the nominal rated supply voltage, and found that the worst case was under the nominal rated supply condition. So the report just shows that condition's data.</i> | |

5.3 Description of Support Units

| |
|--------------|
| <i>None.</i> |
|--------------|

5.4 Test Facility

| |
|---|
| <p>The test facility is recognized, certified, or accredited by the following organizations:</p> <ul style="list-style-type: none">● FCC —Registration No.: 381383 Global United Technology Services Co., Ltd., Shenzhen EMC Laboratory has been registered and fully described in a report filed with the (FCC) Federal Communications Commission. The acceptance letter from the FCC is maintained in files. Registration 381383, January 08, 2018.● Industry Canada (IC) —Registration No.: 9079A-2 The 3m Semi-anechoic chamber of Global United Technology Services Co., Ltd. has been registered by Certification and Engineering Bureau of Industry Canada for radio equipment testing with Registration No.: 9079A-2, August 15, 2016. |
|---|

5.5 Test Location

| |
|--|
| All tests were performed at: |
| Global United Technology Services Co., Ltd. Address: No. 301-309, 3/F., Jinyuan Business Building, No.2, Laodong Industrial Zone, Xixiang Road, Baoan District, Shenzhen, Guangdong, China 518102 Tel: 0755-27798480 Fax: 0755-27798960 |

5.6 Additional Instructions

EUT Software Settings:

| | | | |
|--------------------|--|-----------------|--------------------|
| Mode | Special software is used. The software provided by client to enable the EUT under transmission condition continuously at specific channel frequencies individually. | | |
| Test Software Name | Bluetooth RF Test Tool V2017.7.11 | | |
| Mode | Channel | Frequency (MHz) | Soft Set |
| GFSK | CH01 | 2402 | TX level : default |
| | CH40 | 2441 | |
| | CH79 | 2480 | |

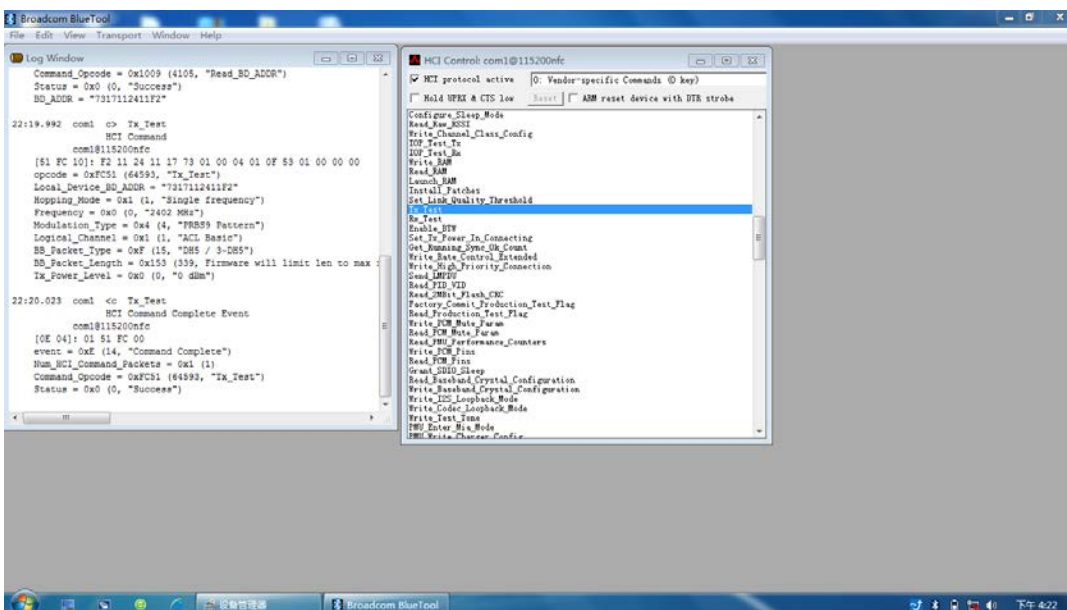

6 Test Instruments list

| Radiated Emission: | | | | | | |
|--------------------|-------------------------------------|--------------------------------|-----------------------------|---------------|---------------------|-------------------------|
| Item | Test Equipment | Manufacturer | Model No. | Inventory No. | Cal.Date (mm-dd-yy) | Cal.Due date (mm-dd-yy) |
| 1 | 3m Semi- Anechoic Chamber | ZhongYu Electron | 9.2(L)*6.2(W)* 6.4(H) | GTS250 | July. 03 2015 | July. 02 2020 |
| 2 | Control Room | ZhongYu Electron | 6.2(L)*2.5(W)* 2.4(H) | GTS251 | N/A | N/A |
| 3 | EMI Test Receiver | Rohde & Schwarz | ESU26 | GTS203 | June. 27 2018 | June. 26 2019 |
| 4 | Spectrum Analyzer | Agilent | N9010A | GTS533 | Mar 03 2018 | Mar 02 2019 |
| 5 | BiConiLog Antenna | SCHWARZBECK MESS-ELEKTRONIK | VULB9163 | GTS214 | June. 27 2018 | June. 26 2019 |
| 6 | Double -ridged waveguide horn | SCHWARZBECK MESS-ELEKTRONIK | BBHA 9120 D | GTS208 | June. 27 2018 | June. 26 2019 |
| 7 | Horn Antenna | ETS-LINDGREN | 3160 | GTS217 | June. 27 2018 | June. 26 2019 |
| 8 | EMI Test Software | AUDIX | E3 | N/A | N/A | N/A |
| 9 | Coaxial Cable | GTS | N/A | GTS213 | June. 27 2018 | June. 26 2019 |
| 10 | Coaxial Cable | GTS | N/A | GTS211 | June. 27 2018 | June. 26 2019 |
| 11 | Coaxial cable | GTS | N/A | GTS210 | June. 27 2018 | June. 26 2019 |
| 12 | Coaxial Cable | GTS | N/A | GTS212 | June. 27 2018 | June. 26 2019 |
| 13 | Amplifier(100kHz-3GHz) | HP | 8347A | GTS204 | June. 27 2018 | June. 26 2019 |
| 14 | Amplifier(2GHz-20GHz) | HP | 84722A | GTS206 | June. 27 2018 | June. 26 2019 |
| 15 | Amplifier (18-26GHz) | Rohde & Schwarz | AFS33-18002 650-30-8P-44 | GTS218 | June. 27 2018 | June. 26 2019 |
| 16 | Band filter | Amindeon | 82346 | GTS219 | June. 27 2018 | June. 26 2019 |
| 17 | Power Meter | Anritsu | ML2495A | GTS540 | June. 27 2018 | June. 26 2019 |
| 18 | Power Sensor | Anritsu | MA2411B | GTS541 | June. 27 2018 | June. 26 2019 |
| 19 | Wideband Radio Communication Tester | Rohde & Schwarz | CMW500 | GTS575 | June. 27 2018 | June. 26 2019 |
| 20 | Splitter | Agilent | 11636B | GTS237 | June. 27 2018 | June. 26 2019 |
| 21 | Loop Antenna | ZHINAN | ZN30900A | GTS534 | June. 27 2018 | June. 26 2019 |

| General used equipment: | | | | | | |
|-------------------------|---------------------------------|--------------|-----------|---------------|---------------------|-------------------------|
| Item | Test Equipment | Manufacturer | Model No. | Inventory No. | Cal.Date (mm-dd-yy) | Cal.Due date (mm-dd-yy) |
| 1 | Humidity/ Temperature Indicator | KTJ | TA328 | GTS243 | June. 27 2018 | June. 26 2019 |
| 2 | Barometer | ChangChun | DYM3 | GTS255 | June. 27 2018 | June. 26 2019 |

| Conducted Emission | | | | | | |
|--------------------|--------------------------|-------------------------|----------------------|---------------|---------------------|-------------------------|
| Item | Test Equipment | Manufacturer | Model No. | Inventory No. | Cal.Date (mm-dd-yy) | Cal.Due date (mm-dd-yy) |
| 1 | Shielding Room | ZhongYu Electron | 7.3(L)x3.1(W)x2.9(H) | GTS252 | May.16 2014 | May.15 2019 |
| 2 | EMI Test Receiver | R&S | ESCI 7 | GTS552 | June. 27 2018 | June. 26 2019 |
| 3 | Coaxial Switch | ANRITSU CORP | MP59B | GTS225 | June. 27 2018 | June. 26 2019 |
| 4 | Artificial Mains Network | SCHWARZBECK MESS | NSLK8127 | GTS226 | June. 27 2018 | June. 26 2019 |
| 5 | Coaxial Cable | GTS | N/A | GTS227 | N/A | N/A |
| 6 | EMI Test Software | AUDIX | E3 | N/A | N/A | N/A |
| 7 | Thermo meter | KTJ | TA328 | GTS233 | June. 27 2018 | June. 26 2019 |
| 8 | Absorbing clamp | Elektronik-Feinmechanik | MDS21 | GTS229 | June. 27 2018 | June. 26 2019 |

| RF Conducted Test: | | | | | | |
|--------------------|--|--------------|------------------|------------|---------------------|-------------------------|
| Item | Test Equipment | Manufacturer | Model No. | Serial No. | Cal.Date (mm-dd-yy) | Cal.Due date (mm-dd-yy) |
| 1 | MXA Signal Analyzer | Agilent | N9020A | GTS566 | June. 27 2018 | June. 26 2019 |
| 2 | EMI Test Receiver | R&S | ESCI 7 | GTS552 | June. 27 2018 | June. 26 2019 |
| 3 | Spectrum Analyzer | Agilent | E4440A | GTS533 | June. 27 2018 | June. 26 2019 |
| 4 | MXG vector Signal Generator | Agilent | N5182A | GTS567 | June. 27 2018 | June. 26 2019 |
| 5 | ESG Analog Signal Generator | Agilent | E4428C | GTS568 | June. 27 2018 | June. 26 2019 |
| 6 | USB RF Power Sensor | DARE | RPR3006W | GTS569 | June. 27 2018 | June. 26 2019 |
| 7 | RF Switch Box | Shongyi | RFSW3003328 | GTS571 | June. 27 2018 | June. 26 2019 |
| 8 | EMI Test Receiver | R&S | ESCI 7 | GTS552 | June. 27 2018 | June. 26 2019 |
| 9 | Programmable Constant Temp & Humi Test Chamber | WEWON | WHTH-150L-40-880 | GTS572 | June. 27 2018 | June. 26 2019 |

7 Test results and Measurement Data

7.1 Antenna requirement

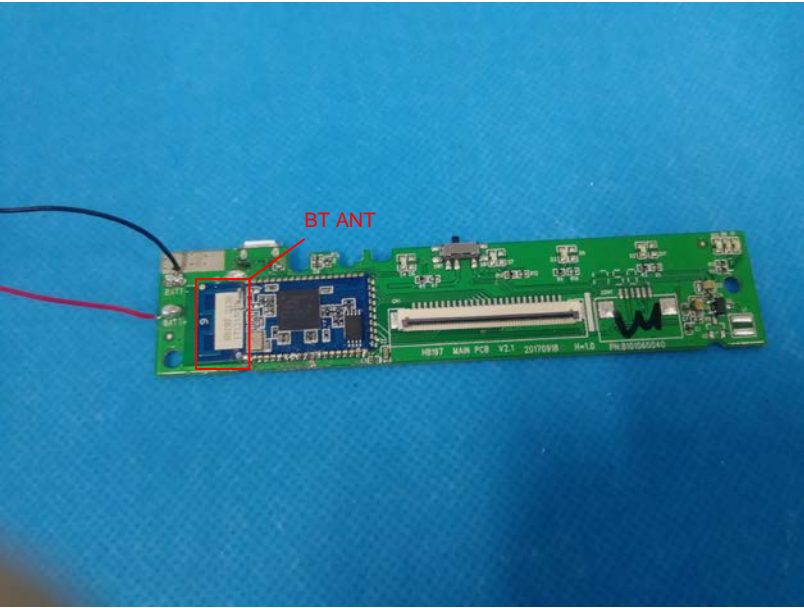
| | |
|--|-------------------------------------|
| Standard requirement: | FCC Part15 C Section 15.203 /247(c) |
| <p>15.203 requirement:</p> <p>An intentional radiator shall be designed to ensure that no antenna other than that furnished by the responsible party shall be used with the device. The use of a permanently attached antenna or of an antenna that uses a unique coupling to the intentional radiator, the manufacturer may design the unit so that a broken antenna can be replaced by the user, but the use of a standard antenna jack or electrical connector is prohibited.</p> <p>15.247(c) (1)(i) requirement:</p> <p>(i) Systems operating in the 2400-2483.5 MHz band that is used exclusively for fixed. Point-to-point operations may employ transmitting antennas with directional gain greater than 6dBi provided the maximum conducted output power of the intentional radiator is reduced by 1 dB for every 3 dB that the directional gain of the antenna exceeds 6dBi.</p> | |
| E.U.T Antenna: | |
| <p><i>The antenna is PCB antenna, the best case gain of the antenna is 1.87 dBi</i></p>  | |

7.2 Conducted Emissions

| Test Requirement: | FCC Part15 C Section 15.207 | | | | | | | | | | | | | | |
|-----------------------|--|-----------------------|--------------|--|------------|---------|----------|-----------|-----------|-------|----|----|------|----|----|
| Test Method: | ANSI C63.10:2013 | | | | | | | | | | | | | | |
| Test Frequency Range: | 150KHz to 30MHz | | | | | | | | | | | | | | |
| Class / Severity: | Class B | | | | | | | | | | | | | | |
| Receiver setup: | RBW=9KHz, VBW=30KHz, Sweep time=auto | | | | | | | | | | | | | | |
| Limit: | <table border="1"> <thead> <tr> <th rowspan="2">Frequency range (MHz)</th> <th colspan="2">Limit (dBuV)</th> </tr> <tr> <th>Quasi-peak</th> <th>Average</th> </tr> </thead> <tbody> <tr> <td>0.15-0.5</td> <td>66 to 56*</td> <td>56 to 46*</td> </tr> <tr> <td>0.5-5</td> <td>56</td> <td>46</td> </tr> <tr> <td>5-30</td> <td>60</td> <td>50</td> </tr> </tbody> </table> <p>* Decreases with the logarithm of the frequency.</p> | Frequency range (MHz) | Limit (dBuV) | | Quasi-peak | Average | 0.15-0.5 | 66 to 56* | 56 to 46* | 0.5-5 | 56 | 46 | 5-30 | 60 | 50 |
| Frequency range (MHz) | Limit (dBuV) | | | | | | | | | | | | | | |
| | Quasi-peak | Average | | | | | | | | | | | | | |
| 0.15-0.5 | 66 to 56* | 56 to 46* | | | | | | | | | | | | | |
| 0.5-5 | 56 | 46 | | | | | | | | | | | | | |
| 5-30 | 60 | 50 | | | | | | | | | | | | | |
| Test setup: | <p><i>Remark</i> E.U.T: Equipment Under Test LISN: Line Impedance Stabilization Network Test table height=0.8m</p> | | | | | | | | | | | | | | |
| Test procedure: | <ol style="list-style-type: none"> 1. The E.U.T and simulators are connected to the main power through a line impedance stabilization network (L.I.S.N.). This provides a 50ohm/50uH coupling impedance for the measuring equipment. 2. The peripheral devices are also connected to the main power through a LISN that provides a 50ohm/50uH coupling impedance with 50ohm termination. (Please refer to the block diagram of the test setup and photographs). 3. Both sides of A.C. line are checked for maximum conducted interference. In order to find the maximum emission, the relative positions of equipment and all of the interface cables must be changed according to ANSI C63.10:2013 on conducted measurement. | | | | | | | | | | | | | | |
| Test Instruments: | Refer to section 6.0 for details | | | | | | | | | | | | | | |
| Test mode: | Refer to section 5.2 for details | | | | | | | | | | | | | | |
| Test results: | Pass | | | | | | | | | | | | | | |

Measurement data:

Model No.: HB197-3-L

| | | | |
|------------|-------------------|-----------------|------|
| Test mode: | Transmitting mode | Phase Polarity: | Line |
| Temp.: | 26°C | Humidity: | 54% |

Data: 7

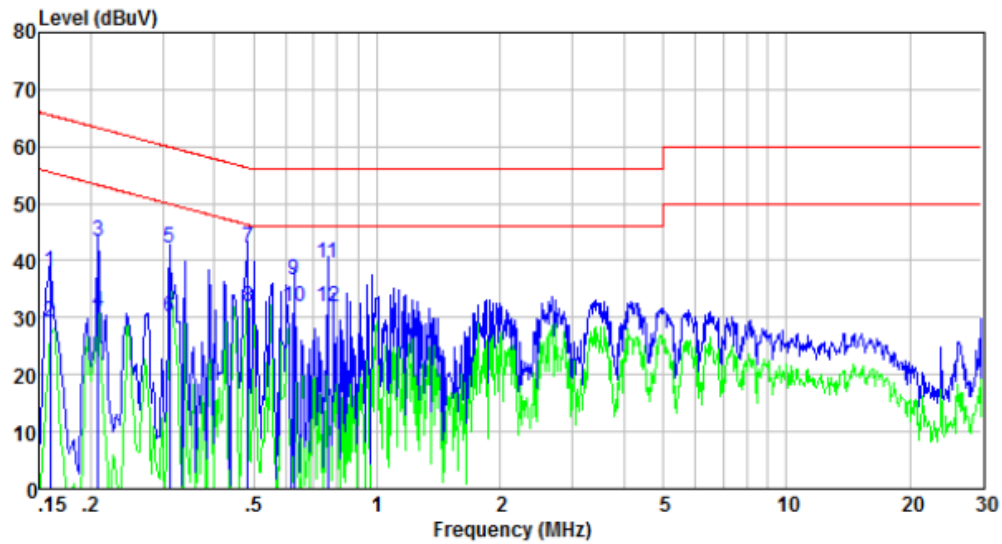

| Freq MHz | Reading level dBuV | LISN/ISN factor dB | Cable loss dB | level dBuV | Limit level dBuV | Over limit dB | Remark |
|-------------|--------------------------|--------------------------|---------------------|---------------|------------------------|---------------------|---------|
| 0.159 | 28.59 | 9.55 | 0.06 | 38.20 | 65.52 | -27.32 | QP |
| 0.159 | 19.59 | 9.55 | 0.06 | 29.20 | 55.52 | -26.32 | Average |
| 0.208 | 33.69 | 9.57 | 0.01 | 43.27 | 63.27 | -20.00 | QP |
| 0.208 | 21.29 | 9.57 | 0.01 | 30.87 | 53.27 | -22.40 | Average |
| 0.312 | 32.67 | 9.61 | 0.01 | 42.29 | 59.93 | -17.64 | QP |
| 0.312 | 20.37 | 9.61 | 0.01 | 29.99 | 49.93 | -19.94 | Average |
| 0.484 | 32.65 | 9.63 | 0.02 | 42.30 | 56.27 | -13.97 | QP |
| 0.484 | 22.25 | 9.63 | 0.02 | 31.90 | 46.27 | -14.37 | Average |
| 0.627 | 27.05 | 9.63 | 0.03 | 36.71 | 56.00 | -19.29 | QP |
| 0.627 | 22.35 | 9.63 | 0.03 | 32.01 | 46.00 | -13.99 | Average |
| 0.759 | 29.95 | 9.64 | 0.03 | 39.62 | 56.00 | -16.38 | QP |
| 0.759 | 22.35 | 9.64 | 0.03 | 32.02 | 46.00 | -13.98 | Average |

| | | | |
|------------|-------------------|-----------------|---------|
| Test mode: | Transmitting mode | Phase Polarity: | Neutral |
| Temp.: | 26°C | Humidity: | 54% |

Data: 9

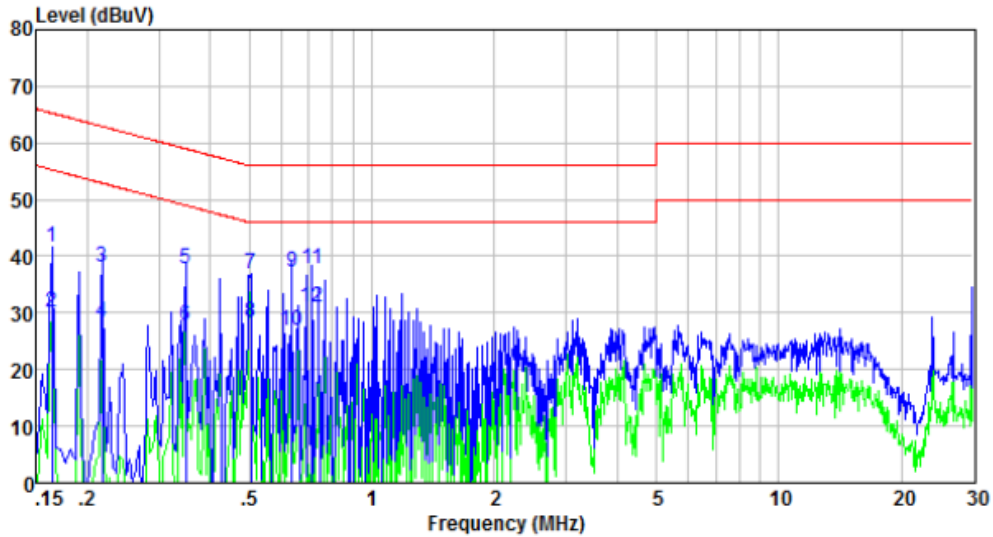

| Freq MHz | Reading level dBuV | LISN/ISN factor dB | Cable loss dB | level dBuV | Limit level dBuV | Over limit dB | Remark |
|-------------|--------------------------|--------------------------|---------------------|---------------|------------------------|---------------------|---------|
| 0.163 | 32.10 | 9.55 | 0.05 | 41.70 | 65.30 | -23.60 | QP |
| 0.163 | 20.60 | 9.55 | 0.05 | 30.20 | 55.30 | -25.10 | Average |
| 0.217 | 28.58 | 9.58 | 0.01 | 38.17 | 62.92 | -24.75 | QP |
| 0.217 | 18.68 | 9.58 | 0.01 | 28.27 | 52.92 | -24.65 | Average |
| 0.348 | 28.25 | 9.62 | 0.02 | 37.89 | 59.00 | -21.11 | QP |
| 0.348 | 18.25 | 9.62 | 0.02 | 27.89 | 49.00 | -21.11 | Average |
| 0.505 | 27.25 | 9.63 | 0.02 | 36.90 | 56.00 | -19.10 | QP |
| 0.505 | 18.55 | 9.63 | 0.02 | 28.20 | 46.00 | -17.80 | Average |
| 0.637 | 27.54 | 9.64 | 0.03 | 37.21 | 56.00 | -18.79 | QP |
| 0.637 | 17.14 | 9.64 | 0.03 | 26.81 | 46.00 | -19.19 | Average |
| 0.712 | 28.05 | 9.64 | 0.03 | 37.72 | 56.00 | -18.28 | QP |
| 0.712 | 21.25 | 9.64 | 0.03 | 30.92 | 46.00 | -15.08 | Average |

Model No.: HB197-2-L

| | | | |
|------------|-------------------|-----------------|------|
| Test mode: | Transmitting mode | Phase Polarity: | Line |
| Temp.: | 26°C | Humidity: | 54% |

Data: 13

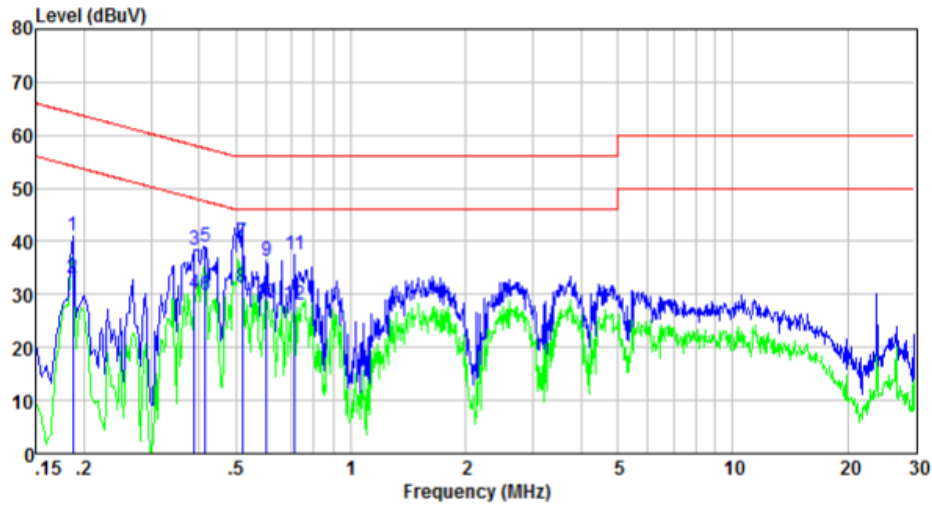

| Freq MHz | Reading level dBuV | LISN/ISN factor dB | Cable loss dB | level dBuV | Limit level dBuV | Over limit dB | Remark |
|-------------|--------------------------|--------------------------|---------------------|---------------|------------------------|---------------------|---------|
| 0.186 | 31.53 | 9.56 | 0.02 | 41.11 | 64.20 | -23.09 | QP |
| 0.186 | 23.59 | 9.56 | 0.02 | 33.17 | 54.20 | -21.03 | Average |
| 0.389 | 28.87 | 9.58 | 0.02 | 38.47 | 58.08 | -19.61 | QP |
| 0.389 | 20.49 | 9.58 | 0.02 | 30.09 | 48.08 | -17.99 | Average |
| 0.415 | 29.37 | 9.58 | 0.02 | 38.97 | 57.55 | -18.58 | QP |
| 0.415 | 20.19 | 9.58 | 0.02 | 29.79 | 47.55 | -17.76 | Average |
| 0.518 | 30.15 | 9.58 | 0.02 | 39.75 | 56.00 | -16.25 | QP |
| 0.518 | 21.67 | 9.58 | 0.02 | 31.27 | 46.00 | -14.73 | Average |
| 0.601 | 26.55 | 9.59 | 0.03 | 36.17 | 56.00 | -19.83 | QP |
| 0.601 | 18.66 | 9.59 | 0.03 | 28.28 | 46.00 | -17.72 | Average |
| 0.712 | 27.72 | 9.59 | 0.03 | 37.34 | 56.00 | -18.66 | QP |
| 0.712 | 18.39 | 9.59 | 0.03 | 28.01 | 46.00 | -17.99 | Average |

| | | | |
|------------|-------------------|-----------------|---------|
| Test mode: | Transmitting mode | Phase Polarity: | Neutral |
| Temp.: | 26°C | Humidity: | 54% |

Data: 11

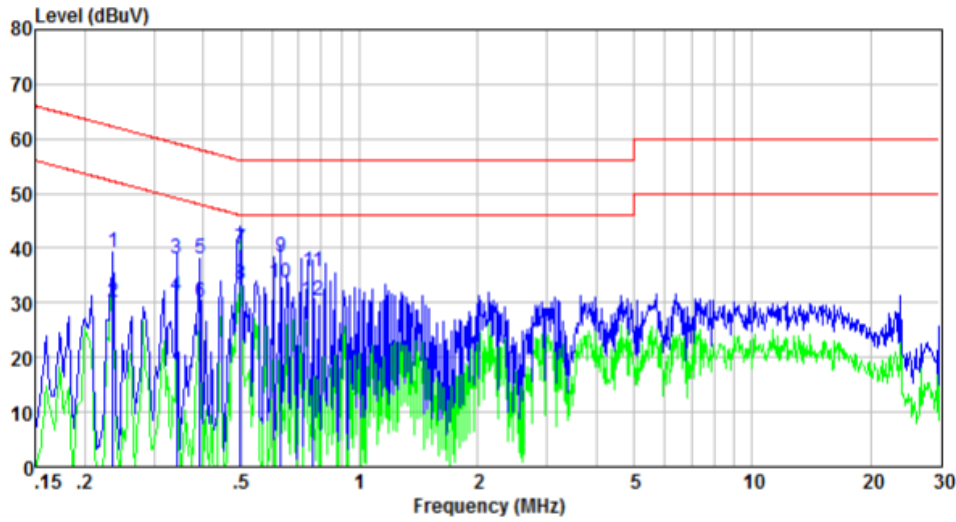

| Freq MHz | Reading level dBuV | LISN/ISN factor dB | Cable loss dB | level dBuV | Limit level dBuV | Over limit dB | Remark |
|-------------|--------------------------|--------------------------|---------------------|---------------|------------------------|---------------------|---------|
| 0.235 | 29.63 | 9.59 | 0.01 | 39.23 | 62.26 | -23.03 | QP |
| 0.235 | 20.63 | 9.59 | 0.01 | 30.23 | 52.26 | -22.03 | Average |
| 0.343 | 28.36 | 9.61 | 0.02 | 37.99 | 59.13 | -21.14 | QP |
| 0.343 | 21.78 | 9.61 | 0.02 | 31.41 | 49.13 | -17.72 | Average |
| 0.393 | 28.37 | 9.62 | 0.02 | 38.01 | 57.99 | -19.98 | QP |
| 0.393 | 20.39 | 9.62 | 0.02 | 30.03 | 47.99 | -17.96 | Average |
| 0.497 | 30.28 | 9.63 | 0.02 | 39.93 | 56.05 | -16.12 | QP |
| 0.497 | 23.59 | 9.63 | 0.02 | 33.24 | 46.05 | -12.81 | Average |
| 0.630 | 28.59 | 9.63 | 0.03 | 38.25 | 56.00 | -17.75 | QP |
| 0.630 | 23.87 | 9.63 | 0.03 | 33.53 | 46.00 | -12.47 | Average |
| 0.763 | 26.07 | 9.64 | 0.03 | 35.74 | 56.00 | -20.26 | QP |
| 0.763 | 20.67 | 9.64 | 0.03 | 30.34 | 46.00 | -15.66 | Average |

Model No.: HB198-2-L

| | | | |
|------------|-------------------|-----------------|------|
| Test mode: | Transmitting mode | Phase Polarity: | Line |
| Temp.: | 26°C | Humidity: | 54% |

Data: 17

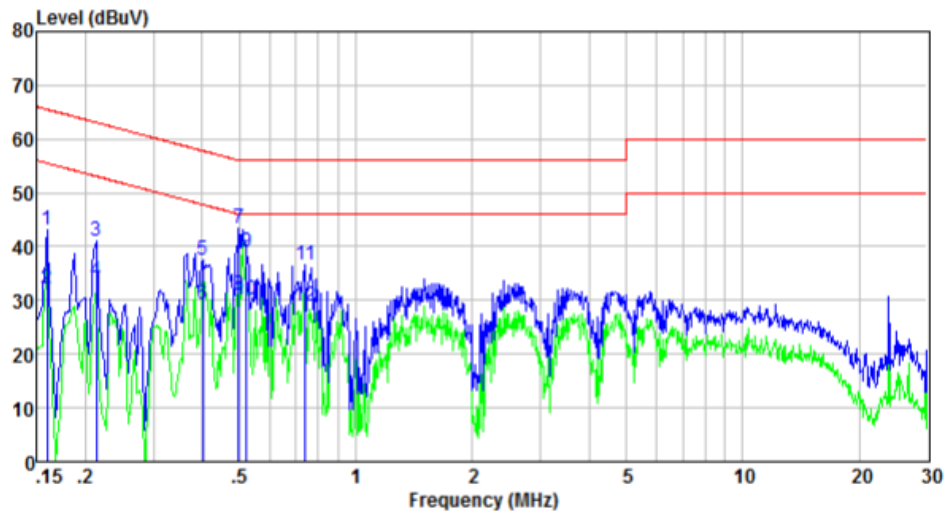

| Freq MHz | Reading level dBuV | LISN/ISN factor dB | Cable loss dB | level dBuV | Limit level dBuV | Over limit dB | Remark |
|-------------|--------------------------|--------------------------|---------------------|---------------|------------------------|---------------------|---------|
| 0.159 | 33.57 | 9.54 | 0.06 | 43.17 | 65.52 | -22.35 | QP |
| 0.159 | 22.68 | 9.54 | 0.06 | 32.28 | 55.52 | -23.24 | Average |
| 0.213 | 31.54 | 9.56 | 0.01 | 41.11 | 63.10 | -21.99 | QP |
| 0.213 | 23.94 | 9.56 | 0.01 | 33.51 | 53.10 | -19.59 | Average |
| 0.402 | 27.80 | 9.58 | 0.02 | 37.40 | 57.81 | -20.41 | QP |
| 0.402 | 19.56 | 9.58 | 0.02 | 29.16 | 47.81 | -18.65 | Average |
| 0.497 | 33.72 | 9.58 | 0.02 | 43.32 | 56.05 | -12.73 | QP |
| 0.497 | 21.36 | 9.58 | 0.02 | 30.96 | 46.05 | -15.09 | Average |
| 0.521 | 29.37 | 9.58 | 0.02 | 38.97 | 56.00 | -17.03 | QP |
| 0.521 | 20.59 | 9.58 | 0.02 | 30.19 | 46.00 | -15.81 | Average |
| 0.739 | 27.07 | 9.59 | 0.03 | 36.69 | 56.00 | -19.31 | QP |
| 0.739 | 19.36 | 9.59 | 0.03 | 28.98 | 46.00 | -17.02 | Average |

| | | | |
|------------|-------------------|-----------------|---------|
| Test mode: | Transmitting mode | Phase Polarity: | Neutral |
| Temp.: | 26°C | Humidity: | 54% |

Data: 15

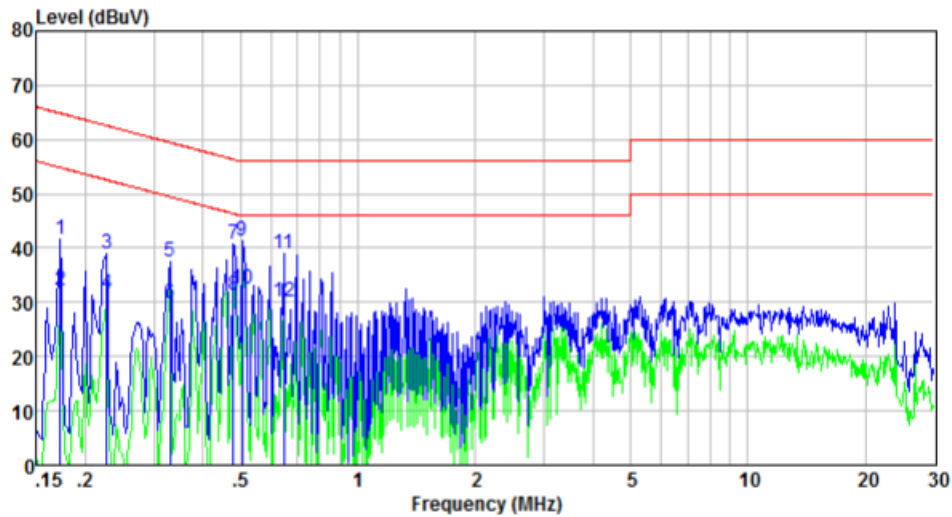

| Freq MHz | Reading level dBuV | LISN/ISN factor dB | Cable loss dB | level dBuV | Limit level dBuV | Over limit dB | Remark |
|-------------|--------------------------|--------------------------|---------------------|---------------|------------------------|---------------------|---------|
| 0.172 | 31.92 | 9.55 | 0.04 | 41.51 | 64.86 | -23.35 | QP |
| 0.172 | 22.65 | 9.55 | 0.04 | 32.24 | 54.86 | -22.62 | Average |
| 0.227 | 29.26 | 9.58 | 0.01 | 38.85 | 62.57 | -23.72 | QP |
| 0.227 | 21.96 | 9.58 | 0.01 | 31.55 | 52.57 | -21.02 | Average |
| 0.330 | 27.92 | 9.61 | 0.02 | 37.55 | 59.44 | -21.89 | QP |
| 0.330 | 20.27 | 9.61 | 0.02 | 29.90 | 49.44 | -19.54 | Average |
| 0.479 | 31.14 | 9.63 | 0.02 | 40.79 | 56.36 | -15.57 | QP |
| 0.479 | 21.54 | 9.63 | 0.02 | 31.19 | 46.36 | -15.17 | Average |
| 0.505 | 31.65 | 9.63 | 0.02 | 41.30 | 56.00 | -14.70 | QP |
| 0.505 | 22.86 | 9.63 | 0.02 | 32.51 | 46.00 | -13.49 | Average |
| 0.644 | 29.41 | 9.64 | 0.03 | 39.08 | 56.00 | -16.92 | QP |
| 0.644 | 20.47 | 9.64 | 0.03 | 30.14 | 46.00 | -15.86 | Average |

Model No.: HB198-3-L

| | | | |
|------------|-------------------|-----------------|------|
| Test mode: | Transmitting mode | Phase Polarity: | Line |
| Temp.: | 26°C | Humidity: | 54% |

Data: 21

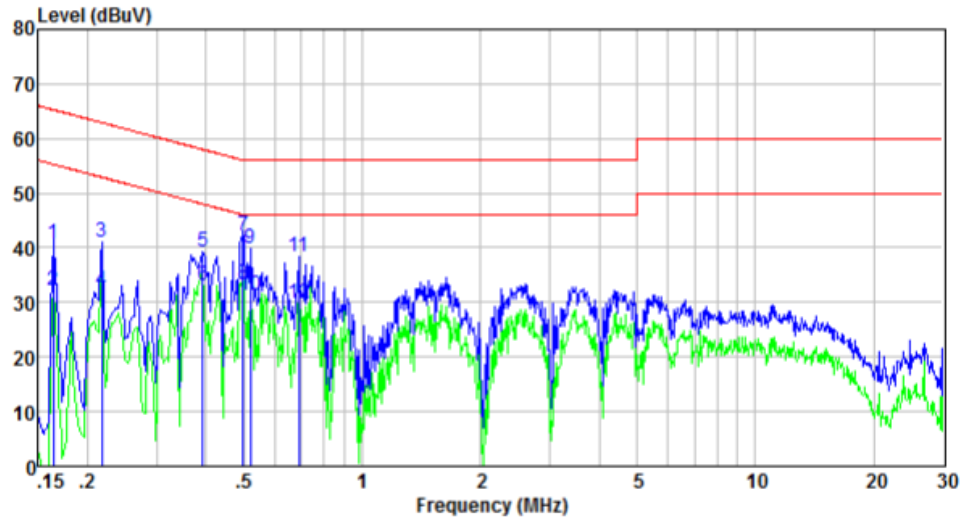

| Freq MHz | Reading level dBuV | LISN/ISN factor dB | Cable loss dB | level dBuV | Limit level dBuV | Over limit dB | Remark |
|-------------|--------------------------|--------------------------|---------------------|---------------|------------------------|---------------------|---------|
| 0.163 | 31.14 | 9.55 | 0.05 | 40.74 | 65.30 | -24.56 | QP |
| 0.163 | 22.68 | 9.55 | 0.05 | 32.28 | 55.30 | -23.02 | Average |
| 0.217 | 31.42 | 9.56 | 0.01 | 40.99 | 62.92 | -21.93 | QP |
| 0.217 | 22.64 | 9.56 | 0.01 | 32.21 | 52.92 | -20.71 | Average |
| 0.393 | 29.73 | 9.58 | 0.02 | 39.33 | 57.99 | -18.66 | QP |
| 0.393 | 23.42 | 9.58 | 0.02 | 33.02 | 47.99 | -14.97 | Average |
| 0.497 | 32.60 | 9.58 | 0.02 | 42.20 | 56.05 | -13.85 | QP |
| 0.497 | 23.64 | 9.58 | 0.02 | 33.24 | 46.05 | -12.81 | Average |
| 0.518 | 30.21 | 9.58 | 0.02 | 39.81 | 56.00 | -16.19 | QP |
| 0.518 | 21.68 | 9.58 | 0.02 | 31.28 | 46.00 | -14.72 | Average |
| 0.690 | 28.76 | 9.59 | 0.03 | 38.38 | 56.00 | -17.62 | QP |
| 0.690 | 20.18 | 9.59 | 0.03 | 29.80 | 46.00 | -16.20 | Average |

| | | | |
|------------|-------------------|-----------------|---------|
| Test mode: | Transmitting mode | Phase Polarity: | Neutral |
| Temp.: | 26°C | Humidity: | 54% |

Data: 19

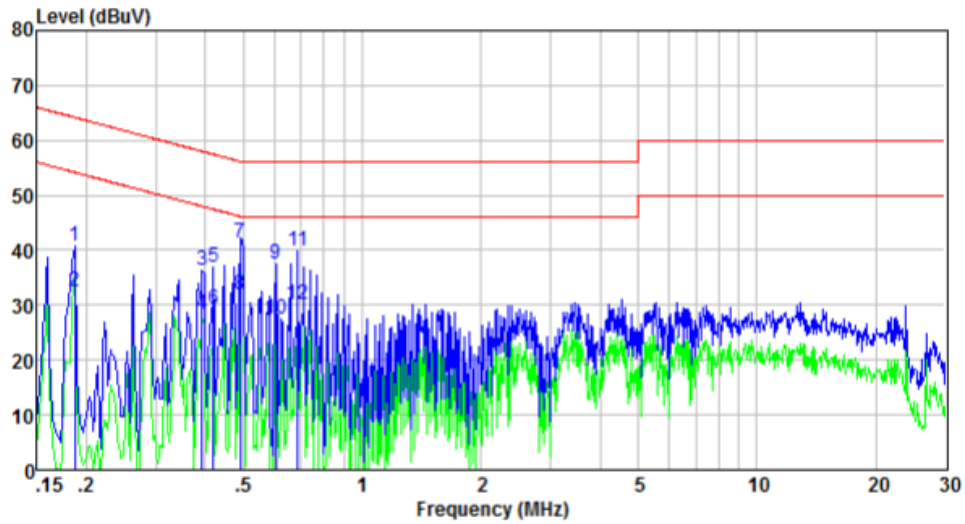

| Freq MHz | Reading level dBuV | LISN/ISN factor dB | Cable loss dB | level dBuV | Limit level dBuV | Over limit dB | Remark |
|-------------|--------------------------|--------------------------|---------------------|---------------|------------------------|---------------------|---------|
| 0.186 | 31.30 | 9.56 | 0.02 | 40.88 | 64.20 | -23.32 | QP |
| 0.186 | 22.79 | 9.56 | 0.02 | 32.37 | 54.20 | -21.83 | Average |
| 0.393 | 26.60 | 9.62 | 0.02 | 36.24 | 57.99 | -21.75 | QP |
| 0.393 | 18.69 | 9.62 | 0.02 | 28.33 | 47.99 | -19.66 | Average |
| 0.419 | 27.27 | 9.62 | 0.02 | 36.91 | 57.46 | -20.55 | QP |
| 0.419 | 19.65 | 9.62 | 0.02 | 29.29 | 47.46 | -18.17 | Average |
| 0.491 | 31.69 | 9.63 | 0.02 | 41.34 | 56.14 | -14.80 | QP |
| 0.491 | 22.37 | 9.63 | 0.02 | 32.02 | 46.14 | -14.12 | Average |
| 0.604 | 27.84 | 9.63 | 0.03 | 37.50 | 56.00 | -18.50 | QP |
| 0.604 | 17.69 | 9.63 | 0.03 | 27.35 | 46.00 | -18.65 | Average |
| 0.686 | 30.31 | 9.64 | 0.03 | 39.98 | 56.00 | -16.02 | QP |
| 0.686 | 20.36 | 9.64 | 0.03 | 30.03 | 46.00 | -15.97 | Average |

Notes:

1. An initial pre-scan was performed on the line and neutral lines with peak detector.
2. Quasi-Peak and Average measurement were performed at the frequencies with maximized peak emission.
3. Final Level = Receiver Read level + LISN Factor + Cable Loss

7.3 Conducted Peak Output Power

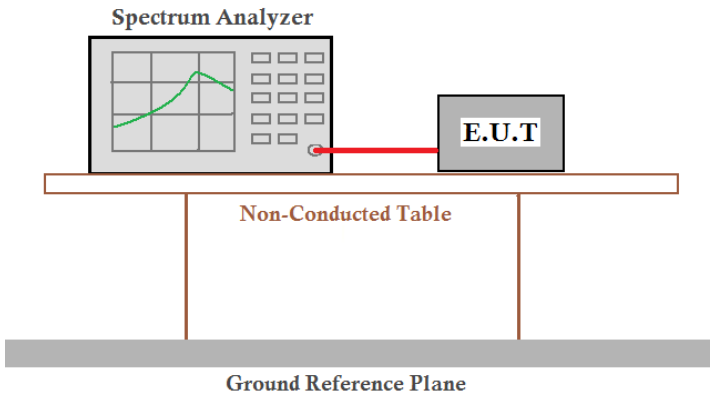
| | |
|-------------------|---|
| Test Requirement: | FCC Part15 C Section 15.247 (b)(3) |
| Test Method: | ANSI C63.10:2013 |
| Limit: | 30dBm(for GFSK),20.97dBm(for EDR) |
| Test setup: |  <p>The diagram illustrates the test setup. A Spectrum Analyzer is connected to an E.U.T. (Equipment Under Test) via a red cable. Both are placed on a Non-Conducted Table, which is supported by a Ground Reference Plane.</p> |
| Test Instruments: | Refer to section 6.0 for details |
| Test mode: | Refer to section 5.2 for details |
| Test results: | Pass |

Measurement Data

| Mode | Test channel | Peak Output Power (dBm) | Limit (dBm) | Result |
|------|--------------|-------------------------|-------------|--------|
| GFSK | Lowest | -5.938 | 30.00 | Pass |
| | Middle | -7.008 | | |
| | Highest | -8.029 | | |

Test plot as follows:

| | |
|------------|-----------|
| Test mode: | GFSK mode |
|------------|-----------|

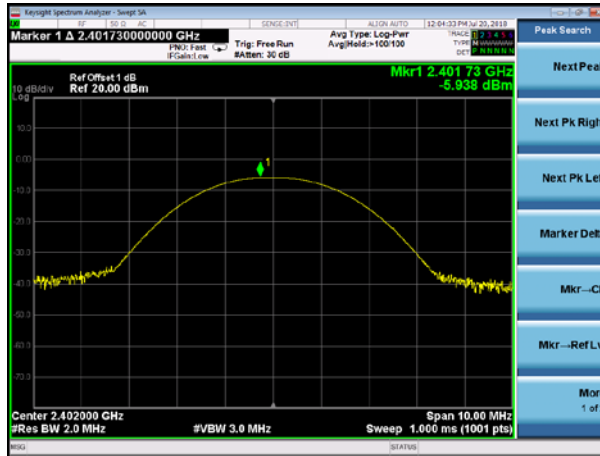

Lowest channel

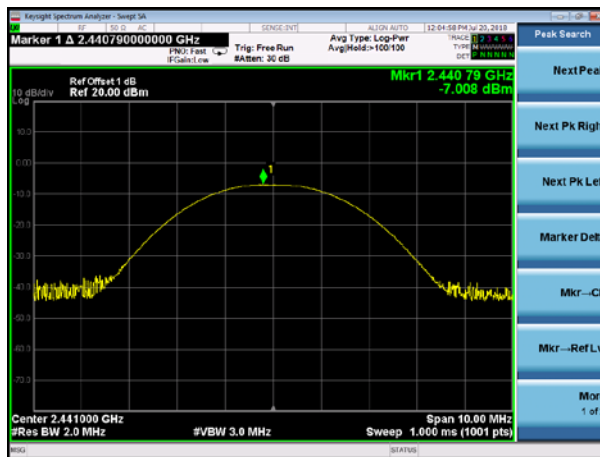

Middle channel

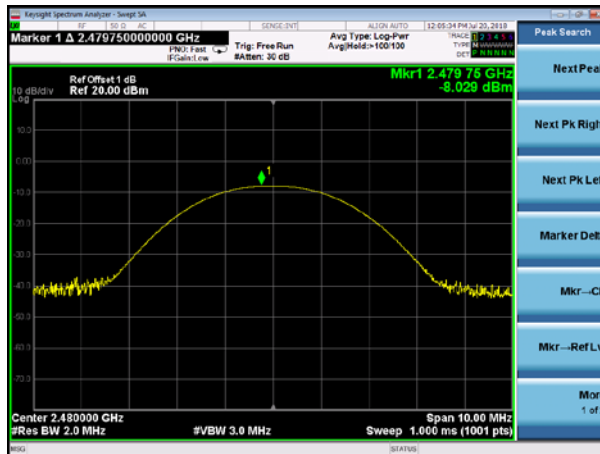

Highest channel

7.4 20dB Emission Bandwidth

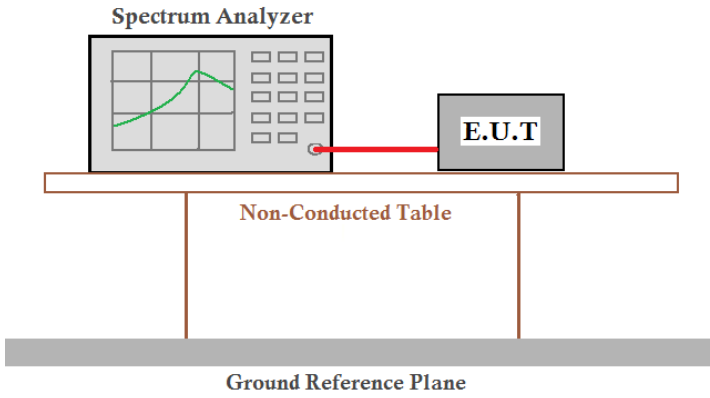
| | |
|-------------------|--|
| Test Requirement: | FCC Part15 C Section 15.247 (a)(2) |
| Test Method: | ANSI C63.10:2013 |
| Limit: | N/A |
| Test setup: |  <p>The diagram illustrates the test setup. A Spectrum Analyzer is connected to an E.U.T. (Equipment Under Test) via a red cable. Both are placed on a Non-Conducted Table, which is supported by two legs. Below the table is a Ground Reference Plane.</p> |
| Test Instruments: | Refer to section 6.0 for details |
| Test mode: | Refer to section 5.2 for details |
| Test results: | Pass |

Measurement Data

| Mode | Test channel | 20dB Emission Bandwidth (MHz) | Result |
|------|--------------|-------------------------------|--------|
| GFSK | Lowest | 1.039 | Pass |
| | Middle | 1.035 | |
| | Highest | 1.033 | |

Test plot as follows:

| | |
|------------|-----------|
| Test mode: | GFSK mode |
|------------|-----------|

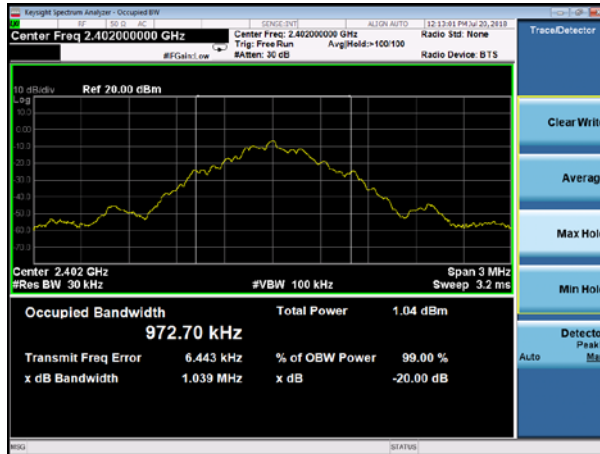

Lowest channel

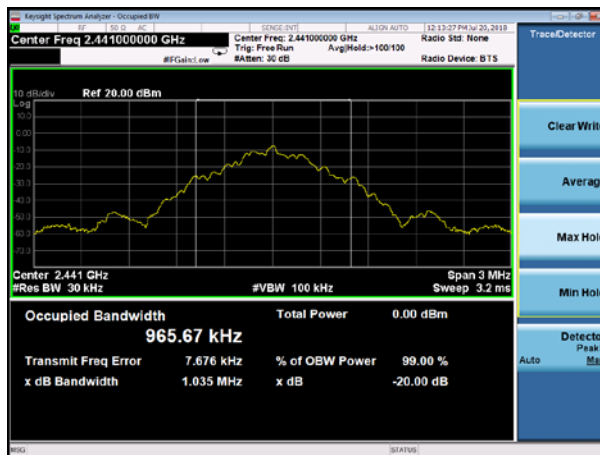

Middle channel



Highest channel

7.5 Carrier Frequencies Separation

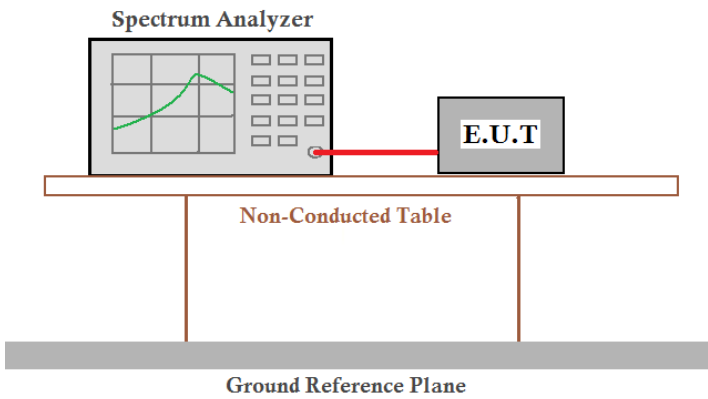
| | |
|-------------------|---|
| Test Requirement: | FCC Part15 C Section 15.247 (a)(1) |
| Test Method: | ANSI C63.10:2013 |
| Receiver setup: | RBW=100KHz, VBW=300KHz, detector=Peak |
| Limit: | GFSK, $\pi/4$ -DQPSK & 8DSK: 0.025MHz or 2/3 of the 20dB bandwidth (whichever is greater) |
| Test setup: |  |
| Test Instruments: | Refer to section 6.0 for details |
| Test mode: | Refer to section 5.2 for details |
| Test results: | Pass |

Measurement Data

| Mode | Test channel | Carrier Frequencies Separation (kHz) | Limit (kHz) | Result |
|------|--------------|--------------------------------------|-------------|--------|
| GFSK | Lowest | 1002 | 693 | Pass |
| | Middle | 1002 | 693 | Pass |
| | Highest | 999 | 693 | Pass |

Note: According to section 7.4

| Mode | 20dB bandwidth (kHz) (worse case) | Limit (kHz) (Carrier Frequencies Separation) |
|------|--------------------------------------|---|
| GFSK | 1039 | 693 |

Test plot as follows:

Modulation mode: **GFSK**

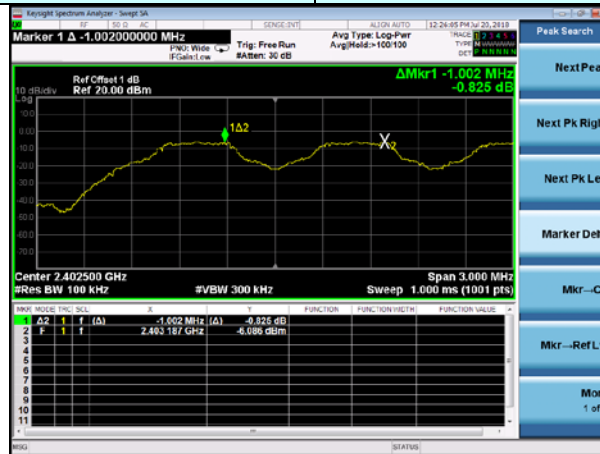

Lowest channel

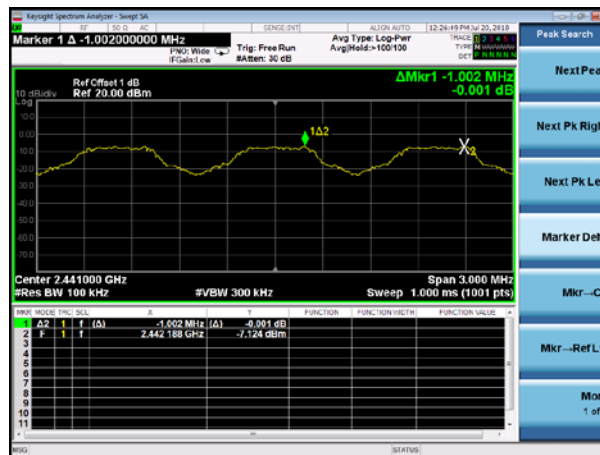

Middle channel



Highest channel

7.6 Hopping Channel Number

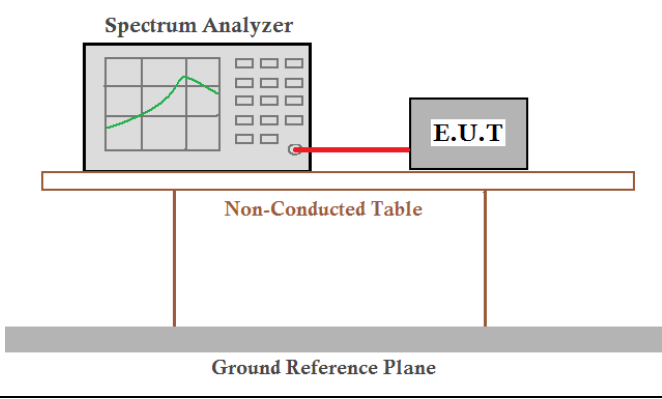
| | |
|-------------------|--|
| Test Requirement: | FCC Part15 C Section 15.247 (a)(1) |
| Test Method: | ANSI C63.10:2013 |
| Receiver setup: | RBW=100kHz, VBW=300kHz, Frequency range=2400MHz-2483.5MHz, Detector=Peak |
| Limit: | 15 channels |
| Test setup: |  |
| Test Instruments: | Refer to section 6.0 for details |
| Test mode: | Refer to section 5.2 for details |
| Test results: | Pass |

Measurement Data:

| Mode | Hopping channel numbers | Limit | Result |
|------|-------------------------|-------|--------|
| GFSK | 79 | 15 | Pass |

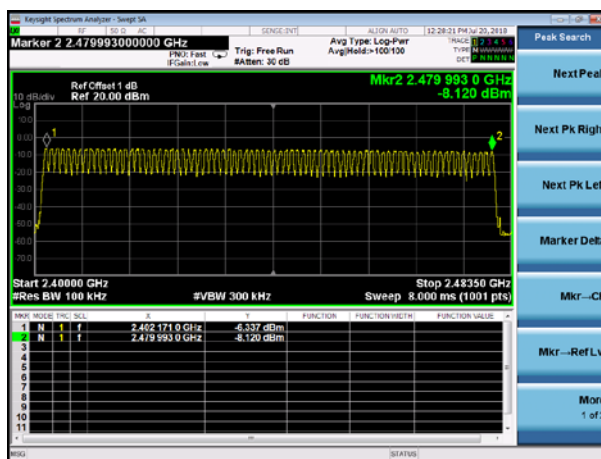

7.7 Dwell Time

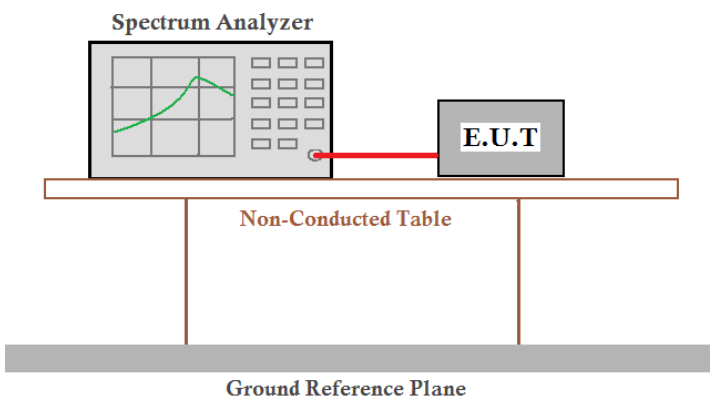
| | |
|-------------------|--|
| Test Requirement: | FCC Part15 C Section 15.247 (a)(1) |
| Test Method: | ANSI C63.10:2013 |
| Receiver setup: | RBW=1MHz, VBW=1MHz, Span=0Hz, Detector=Peak |
| Limit: | 0.4 Second |
| Test setup: |  |
| Test Instruments: | Refer to section 6.0 for details |
| Test mode: | Refer to section 5.2 for details |
| Test results: | Pass |

Measurement Data

| Frequency | Packet | Dwell time(ms) | Limit(ms) | Result |
|-----------|--------|----------------|-----------|--------|
| 2441MHz | DH1 | 135.68 | 400 | Pass |
| 2441MHz | DH3 | 269.28 | 400 | Pass |
| 2441MHz | DH5 | 312.5 | 400 | Pass |

The test period: $T = 0.4 \text{ Second/Channel} \times 79 \text{ Channel} = 31.6 \text{ s}$

Test channel: 2441MHz as blow

$$\text{DH1 time slot} = 0.424(\text{ms}) \times (1600 / (2 \times 79)) \times 31.6 = 135.68\text{ms}$$

$$\text{DH3 time slot} = 1.683(\text{ms}) \times (1600 / (4 \times 79)) \times 31.6 = 269.28\text{ms}$$

$$\text{DH5 time slot} = 2.930(\text{ms}) \times (1600 / (6 \times 79)) \times 31.6 = 312.5\text{ms}$$

Test plot as follows:

Test channel: 2441MHz

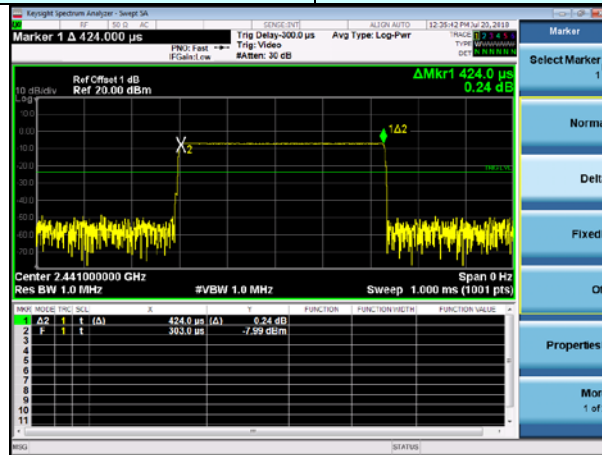

DH1

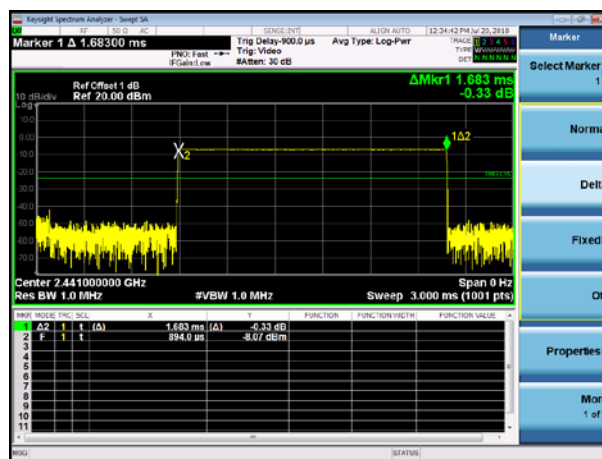

DH3

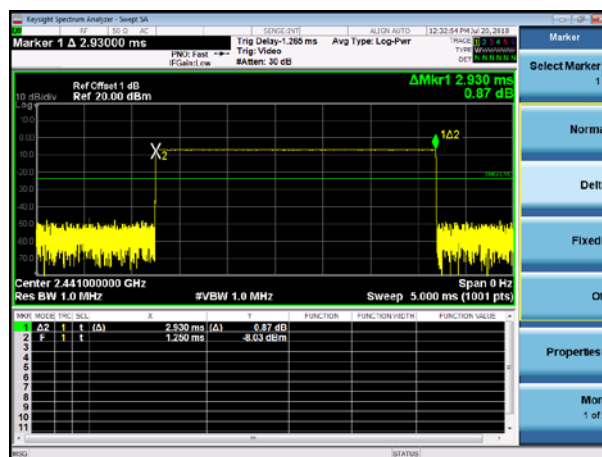

DH5

7.8 Pseudorandom Frequency Hopping Sequence

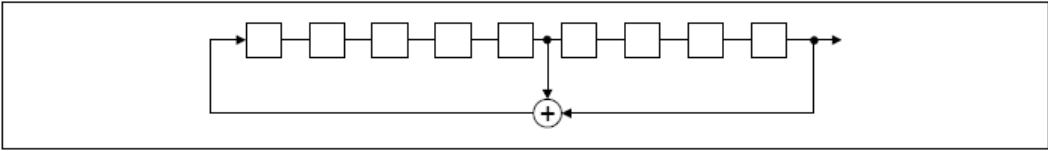
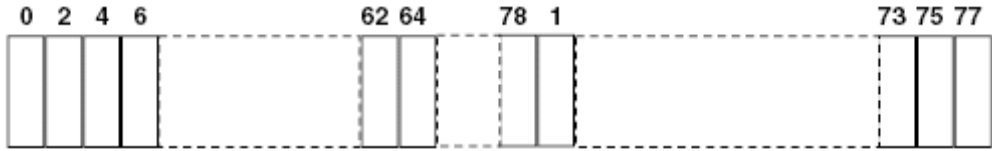
| | |
|--|--|
| Test Requirement: | FCC Part15 C Section 15.247 (a)(1) requirement: |
| <p><i>Frequency hopping systems shall have hopping channel carrier frequencies separated by a minimum of 25 kHz or the 20 dB bandwidth of the hopping channel, whichever is greater.</i></p> <p><i>Alternatively. Frequency hopping systems operating in the 2400-2483.5 MHz band may have hopping channel carrier frequencies that are separated by 25 kHz or two-thirds of the 20 dB bandwidth of the hopping channel, whichever is greater, provided the systems operate with an output power no greater than 125 mW. The system shall hop to channel frequencies that are selected at the system hopping rate from a Pseudorandom ordered list of hopping frequencies. Each frequency must be used equally on the average by each transmitter. The system receivers shall have input bandwidths that match the hopping channel bandwidths of their corresponding transmitters and shall shift frequencies in synchronization with the transmitted signals.</i></p> | |
| EUT Pseudorandom Frequency Hopping Sequence | |
| <p><i>The pseudorandom sequence may be generated in a nine-stage shift register whose 5th and 9th stage outputs are added in a modulo-two addition stage. And the result is fed back to the input of the first stage. The sequence begins with the first ONE of 9 consecutive ONEs; i.e. the shift register is initialized with nine ones.</i></p> <ul style="list-style-type: none"> • Number of shift register stages: 9 • Length of pseudo-random sequence: $2^9 - 1 = 511$ bits • Longest sequence of zeros: 8 (non-inverted signal) | |
|  | |
| <p><i>Linear Feedback Shift Register for Generation of the PRBS sequence</i></p> | |
| <p><i>An example of Pseudorandom Frequency Hopping Sequence as follow:</i></p> | |
|  | |
| <p><i>Each frequency used equally on the average by each transmitter.</i></p> <p><i>The system receivers have input bandwidths that match the hopping channel bandwidths of their corresponding transmitters and shift frequencies in synchronization with the transmitted signals.</i></p> | |

7.9 Band Edge

7.9.1 Conducted Emission Method

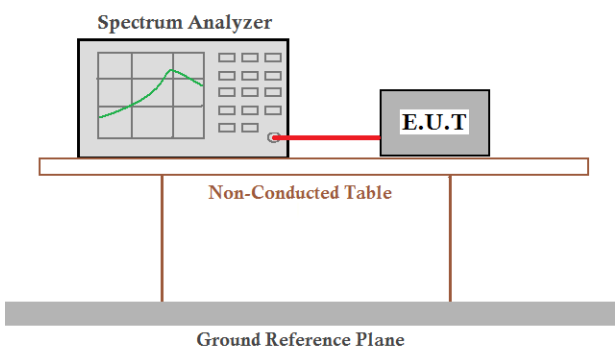
| | |
|-------------------|---|
| Test Requirement: | FCC Part15 C Section 15.247 (d) |
| Test Method: | ANSI C63.10:2013 |
| Receiver setup: | RBW=100kHz, VBW=300kHz, Detector=Peak |
| Limit: | In any 100 kHz bandwidth outside the frequency band in which the spread spectrum intentional radiator is operating, the radio frequency power that is produced by the intentional radiator shall be at least 20 dB below that in the 100 kHz bandwidth within the band that contains the highest level of the desired power, based on either an RF conducted or a radiated measurement. |
| Test setup: |  <p>The diagram illustrates the test setup. A Spectrum Analyzer is connected to an E.U.T. (Equipment Under Test) via a red cable. Both are placed on a Non-Conducted Table, which is supported by two legs. Below the table is a Ground Reference Plane.</p> |
| Test Instruments: | Refer to section 6.0 for details |
| Test mode: | Refer to section 5.2 for details |
| Test results: | Pass |

Test plot as follows:

GFSK Mode:

Test channel: Lowest channel

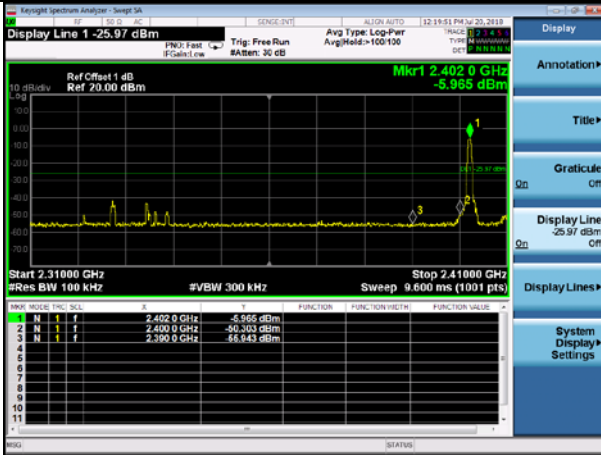

No-hopping mode

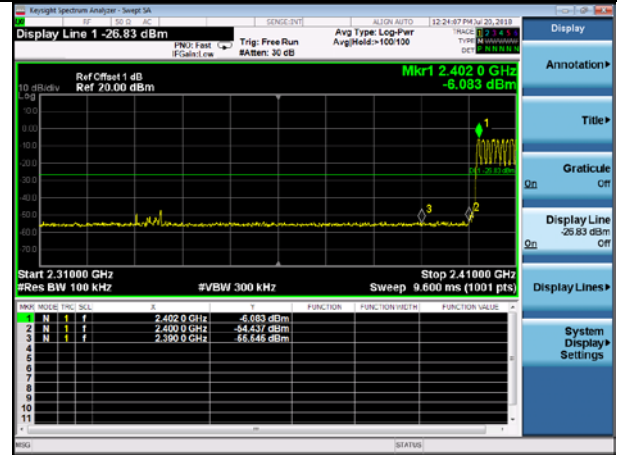

Hopping mode

Test channel: Highest channel

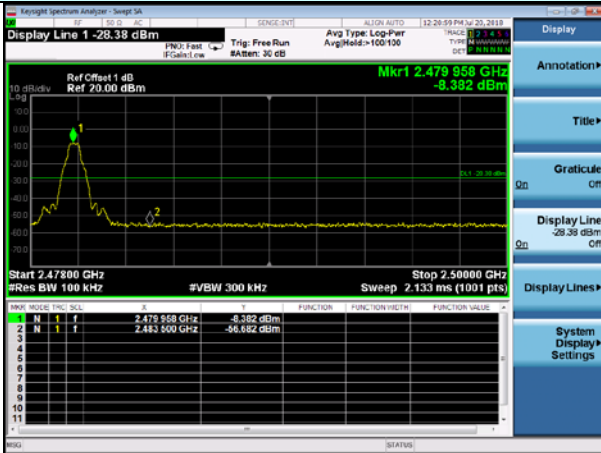

No-hopping mode

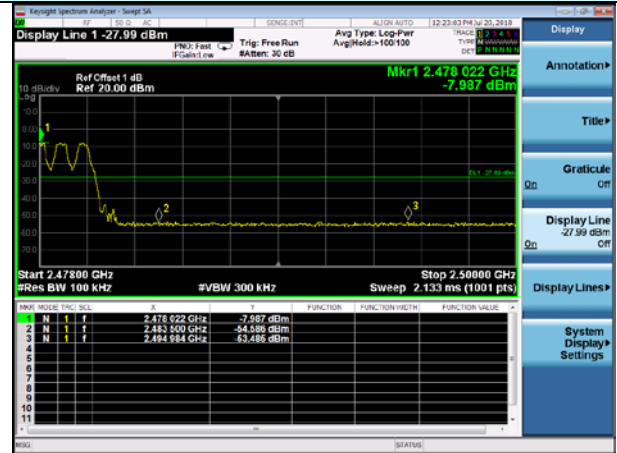

Hopping mode

7.9.2 Radiated Emission Method

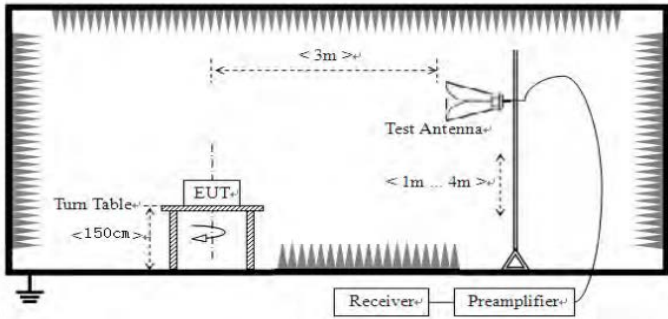
| | | | | | |
|-----------------------|---|----------|--------------------|------|---------------|
| Test Requirement: | FCC Part15 C Section 15.209 and 15.205 | | | | |
| Test Method: | ANSI C63.10:2013 | | | | |
| Test Frequency Range: | All restriction band have been tested, and 2.3GHz to 2.5GHz band is the worse case | | | | |
| Test site: | Measurement Distance: 3m | | | | |
| Receiver setup: | Frequency | Detector | RBW | VBW | Remark |
| | Above 1GHz | Peak | 1MHz | 3MHz | Peak Value |
| | | Peak | 1MHz | 10Hz | Average Value |
| Limit: | Frequency | | Limit (dBuV/m @3m) | | Remark |
| | Above 1GHz | | 54.00 | | Average Value |
| | | | 74.00 | | Peak Value |
| Test setup: |  | | | | |
| Test Procedure: | <ol style="list-style-type: none"> 1. The EUT was placed on the top of a rotating table 1.5 meters above the ground at a 3 meter camber. The table was rotated 360 degrees to determine the position of the highest radiation. 2. The EUT was set 3 meters away from the interference-receiving antenna, which was mounted on the top of a variable-height antenna tower. 3. The antenna height is varied from one meter to four meters above the ground to determine the maximum value of the field strength. Both horizontal and vertical polarizations of the antenna are set to make the measurement. 4. For each suspected emission, the EUT was arranged to its worst case and then the antenna was tuned to heights from 1 meter to 4 meters and the rota table was turned from 0 degrees to 360 degrees to find the maximum reading. 5. The test-receiver system was set to Peak Detect Function and Specified Bandwidth with Maximum Hold Mode. 6. If the emission level of the EUT in peak mode was 10dB lower than the limit specified, then testing could be stopped and the peak values of the EUT would be reported. Otherwise the emissions that did not have 10dB margin would be re-tested one by one using peak, quasi-peak or average method as specified and then reported in a data sheet. | | | | |
| Test Instruments: | Refer to section 6.0 for details | | | | |
| Test mode: | Refer to section 5.2 for details | | | | |
| Test results: | Pass | | | | |

| | |
|---------------|--------|
| Test channel: | Lowest |
|---------------|--------|

Peak value:

| Frequency (MHz) | Read Level (dBuV) | Antenna Factor (dB/m) | Cable Loss (dB) | Preamp Factor (dB) | Level (dBuV/m) | Limit Line (dBuV/m) | Over Limit (dB) | Polarization |
|-----------------|-------------------|-----------------------|-----------------|--------------------|----------------|---------------------|-----------------|--------------|
| 2310.00 | 40.63 | 26.91 | 3.56 | 35.87 | 35.23 | 74.00 | -38.77 | Horizontal |
| 2390.00 | 40.47 | 27.11 | 3.64 | 36.08 | 35.14 | 74.00 | -38.86 | Horizontal |
| 2310.00 | 40.99 | 26.91 | 3.56 | 35.87 | 35.59 | 74.00 | -38.41 | Vertical |
| 2390.00 | 40.43 | 27.11 | 3.64 | 36.08 | 35.10 | 74.00 | -38.90 | Vertical |

Average value:

| Frequency (MHz) | Read Level (dBuV) | Antenna Factor (dB/m) | Cable Loss (dB) | Preamp Factor (dB) | Level (dBuV/m) | Limit Line (dBuV/m) | Over Limit (dB) | Polarization |
|-----------------|-------------------|-----------------------|-----------------|--------------------|----------------|---------------------|-----------------|--------------|
| 2310.00 | 27.05 | 26.91 | 3.56 | 35.87 | 21.65 | 54.00 | -32.35 | Horizontal |
| 2390.00 | 26.88 | 27.11 | 3.64 | 36.08 | 21.55 | 54.00 | -32.45 | Horizontal |
| 2310.00 | 27.12 | 26.91 | 3.56 | 35.87 | 21.72 | 54.00 | -32.28 | Vertical |
| 2390.00 | 26.78 | 27.11 | 3.64 | 36.08 | 21.45 | 54.00 | -32.55 | Vertical |

| | |
|---------------|---------|
| Test channel: | Highest |
|---------------|---------|

Peak value:

| Frequency (MHz) | Read Level (dBuV) | Antenna Factor (dB/m) | Cable Loss (dB) | Preamp Factor (dB) | Level (dBuV/m) | Limit Line (dBuV/m) | Over Limit (dB) | Polarization |
|-----------------|-------------------|-----------------------|-----------------|--------------------|----------------|---------------------|-----------------|--------------|
| 2483.50 | 47.63 | 27.36 | 3.68 | 36.33 | 42.34 | 74.00 | -31.66 | Horizontal |
| 2500.00 | 41.27 | 27.40 | 3.68 | 36.37 | 35.98 | 74.00 | -38.02 | Horizontal |
| 2483.50 | 41.19 | 27.36 | 3.68 | 36.33 | 35.90 | 74.00 | -38.10 | Vertical |
| 2500.00 | 42.50 | 27.40 | 3.68 | 36.37 | 37.21 | 74.00 | -36.79 | Vertical |

Average value:

| Frequency (MHz) | Read Level (dBuV) | Antenna Factor (dB/m) | Cable Loss (dB) | Preamp Factor (dB) | Level (dBuV/m) | Limit Line (dBuV/m) | Over Limit (dB) | Polarization |
|-----------------|-------------------|-----------------------|-----------------|--------------------|----------------|---------------------|-----------------|--------------|
| 2483.50 | 28.20 | 27.36 | 3.68 | 36.33 | 22.91 | 54.00 | -31.09 | Horizontal |
| 2500.00 | 27.91 | 27.40 | 3.68 | 36.37 | 22.62 | 54.00 | -31.38 | Horizontal |
| 2483.50 | 27.97 | 27.36 | 3.68 | 36.33 | 22.68 | 54.00 | -31.32 | Vertical |
| 2500.00 | 27.89 | 27.40 | 3.68 | 36.37 | 22.60 | 54.00 | -31.40 | Vertical |

Remark:

1. Final Level = Receiver Read level + Antenna Factor + Cable Loss – Preamplifier Factor
2. The emission levels of other frequencies are very lower than the limit and not show in test report.

7.10 Spurious Emission

7.10.1 Conducted Emission Method

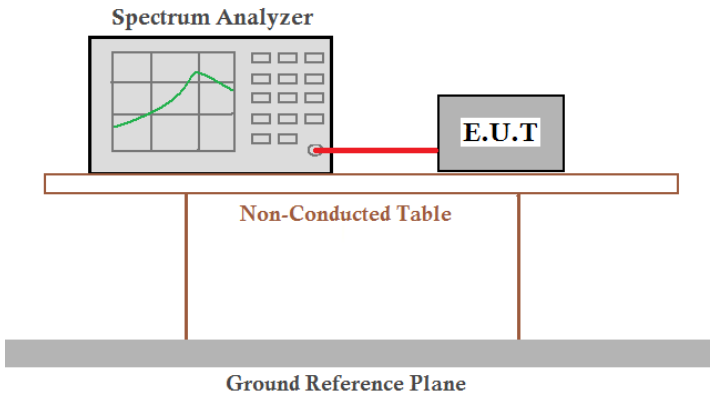
| | |
|-------------------|---|
| Test Requirement: | FCC Part15 C Section 15.247 (d) |
| Test Method: | ANSI C63.10:2013 and KDB558074 D01 Meas Guidance V04 |
| Limit: | In any 100 kHz bandwidth outside the frequency band in which the spread spectrum intentional radiator is operating, the radio frequency power that is produced by the intentional radiator shall be at least 20 dB below that in the 100 kHz bandwidth within the band that contains the highest level of the desired power, based on either an RF conducted or a radiated measurement. |
| Test setup: |  <p>The diagram illustrates the test setup. A Spectrum Analyzer is connected to an E.U.T. (Equipment Under Test) via a red cable. Both are placed on a Non-Conducted Table, which is supported by two legs. Below the table is a Ground Reference Plane.</p> |
| Test Instruments: | Refer to section 6.0 for details |
| Test mode: | Refer to section 5.2 for details |
| Test results: | Pass |

Test channel: Lowest channel

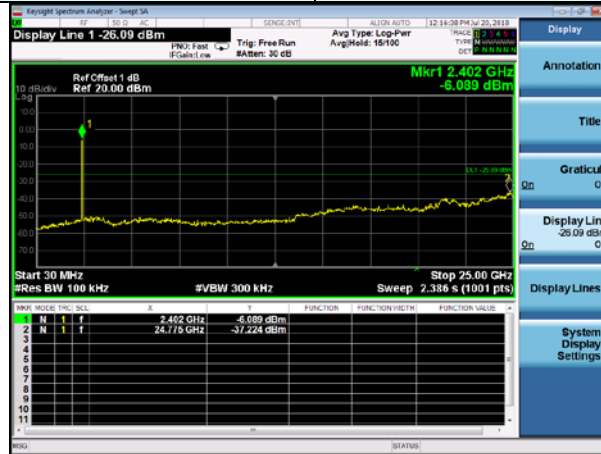

30MHz~25GHz

Test channel: Middle channel

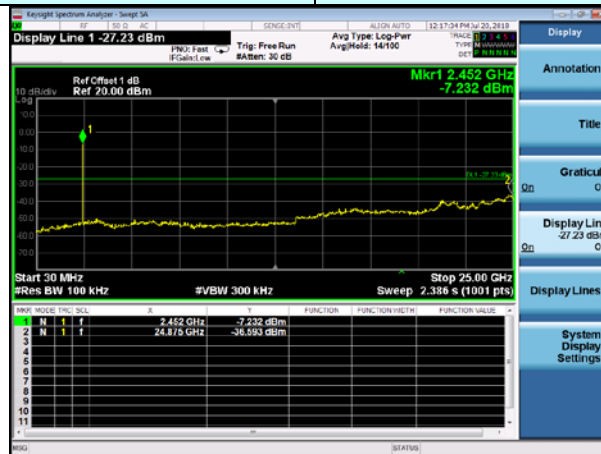

30MHz~25GHz

Test channel: Highest channel

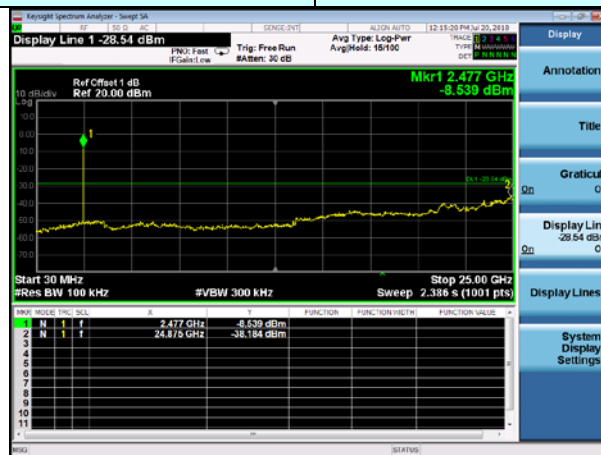

30MHz~25GHz

7.10.2 Radiated Emission Method

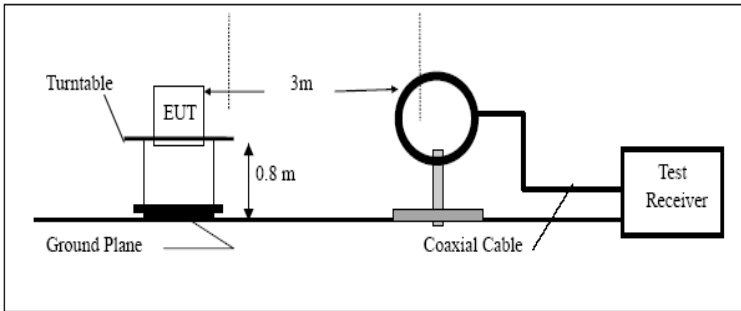
| | | | | | |
|-----------------------|--|--------------|---------|----------------------|------------|
| Test Requirement: | FCC Part15 C Section 15.209 | | | | |
| Test Method: | ANSI C63.10:2013 | | | | |
| Test Frequency Range: | 9kHz to 25GHz | | | | |
| Test site: | Measurement Distance: 3m | | | | |
| Receiver setup: | Frequency | Detector | RBW | VBW | Value |
| | 9KHz-150KHz | Quasi-peak | 200Hz | 600Hz | Quasi-peak |
| | 150KHz-30MHz | Quasi-peak | 9KHz | 30KHz | Quasi-peak |
| | 30MHz-1GHz | Quasi-peak | 100KHz | 300KHz | Quasi-peak |
| | Above 1GHz | Peak | 1MHz | 3MHz | Peak |
| Peak | | 1MHz | 10Hz | Average | |
| Limit: | Frequency | Limit (uV/m) | Value | Measurement Distance | |
| | 0.009MHz-0.490MHz | 2400/F(KHz) | QP | 300m | |
| | 0.490MHz-1.705MHz | 24000/F(KHz) | QP | 300m | |
| | 1.705MHz-30MHz | 30 | QP | 30m | |
| | 30MHz-88MHz | 100 | QP | 3m | |
| | 88MHz-216MHz | 150 | QP | | |
| | 216MHz-960MHz | 200 | QP | | |
| | 960MHz-1GHz | 500 | QP | | |
| | Above 1GHz | 500 | Average | | |
| | | 5000 | Peak | | |
| Test setup: | Below 30MHz | | | | |
| |  | | | | |
| Below 1GHz | | | | | |

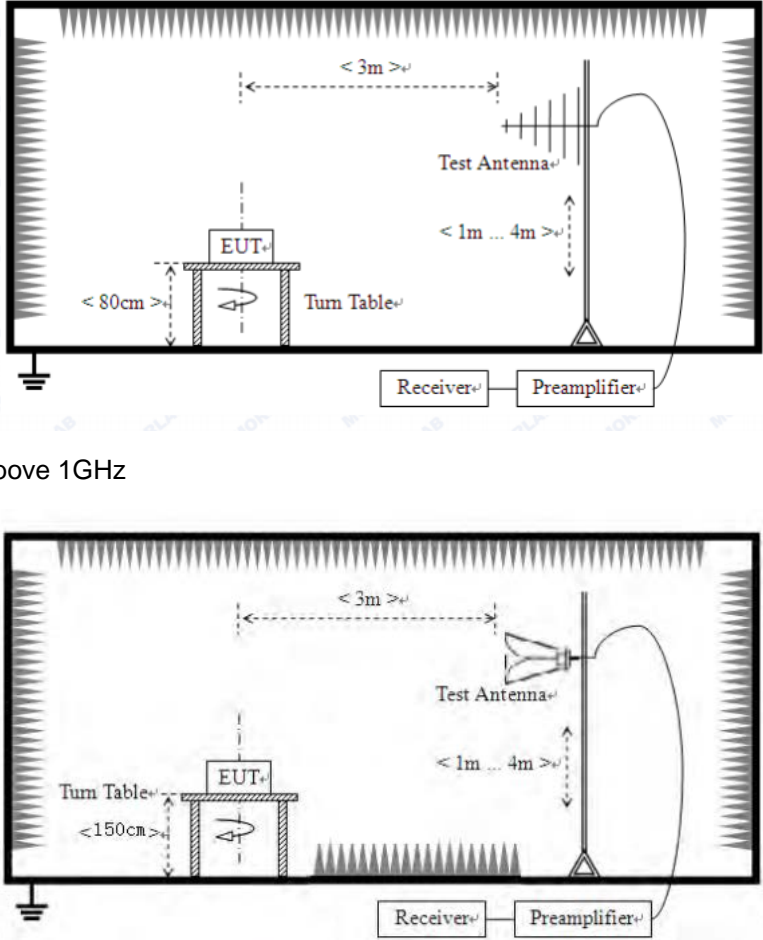
| | |
|------------------------|--|
| |  <p>Above 1GHz</p> |
| <p>Test Procedure:</p> | <ol style="list-style-type: none"> 1. The EUT was placed on the top of a rotating table (0.8m for below 1G and 1.5m for above 1G) above the ground at a 3 meter camber. The table was rotated 360 degrees to determine the position of the highest radiation. 2. The EUT was set 3 meters away from the interference-receiving antenna, which was mounted on the top of a variable-height antenna tower. 3. The antenna height is varied from one meter to four meters above the ground to determine the maximum value of the field strength. Both horizontal and vertical polarizations of the antenna are set to make the measurement. 4. For each suspected emission, the EUT was arranged to its worst case and then the antenna was tuned to heights from 1 meter to 4 meters and the rota table was turned from 0 degrees to 360 degrees to find the maximum reading. 5. The test-receiver system was set to Peak Detect Function and Specified Bandwidth with Maximum Hold Mode. 6. If the emission level of the EUT in peak mode was 10dB lower than the limit specified, then testing could be stopped and the peak values of the |

| | |
|-------------------|---|
| | EUT would be reported. Otherwise the emissions that did not have 10dB margin would be re-tested one by one using peak, quasi-peak or average method as specified and then reported in a data sheet. |
| Test Instruments: | Refer to section 6.0 for details |
| Test mode: | Refer to section 5.2 for details |
| Test results: | Pass |

Measurement data:*Remark:*

1. Pre-scan all kind of the place mode (X-axis, Y-axis, Z-axis), and found the Y-axis which it is worse case.

■ 9kHz~30MHz

The low frequency, which started from 9 kHz to 30 MHz, was pre-scanned and the result which was 20 dB lower than the limit line per 15.31(o) was not reported.

■ Below 1GHz
Model No.: HB197-3-L

| | | | |
|------------|-------------------|-------------------|------------|
| Test mode: | Transmitting mode | Antenna Polarity: | Horizontal |
| Temp.: | 27°C | Humidity: | 55% |

Data: 1

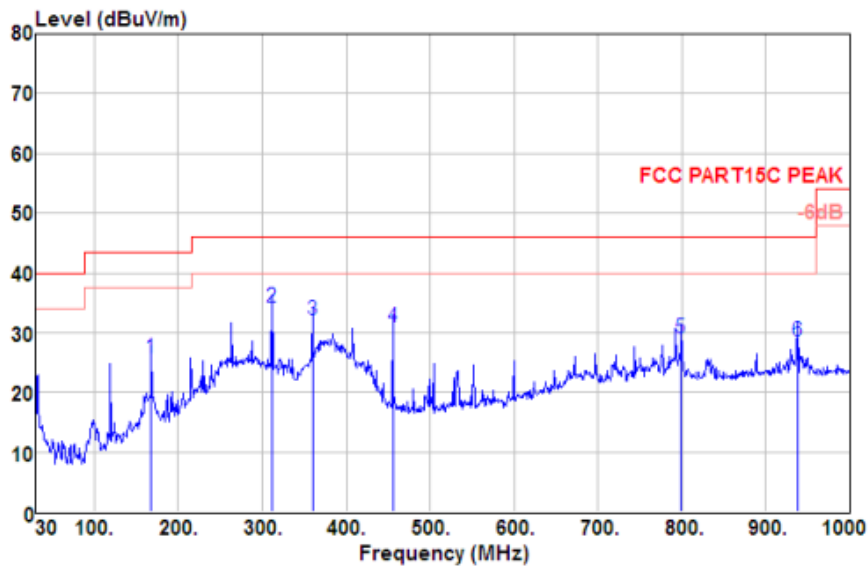

| Freq MHz | Reading level dBuV | Antenna factor dB/m | Cable loss dB | Preamp factor dB | level dBuV | Limit level dBuV/m | Over limit dB | Remark |
|-------------|--------------------------|---------------------------|---------------------|------------------------|---------------|--------------------------|---------------------|--------|
| 167.740 | 42.40 | 13.43 | 2.53 | 32.52 | 25.84 | 43.50 | -17.66 | QP |
| 312.270 | 50.11 | 13.13 | 3.52 | 32.51 | 34.25 | 46.00 | -11.75 | QP |
| 359.800 | 46.71 | 14.04 | 3.86 | 32.49 | 32.12 | 46.00 | -13.88 | QP |
| 455.830 | 43.42 | 15.75 | 4.34 | 32.52 | 30.99 | 46.00 | -15.01 | QP |
| 799.210 | 34.87 | 20.79 | 6.12 | 32.65 | 29.13 | 46.00 | -16.87 | QP |
| 937.920 | 32.27 | 21.93 | 6.43 | 32.06 | 28.57 | 46.00 | -17.43 | QP |

| | | | |
|------------|-------------------|-------------------|----------|
| Test mode: | Transmitting mode | Antenna Polarity: | Vertical |
| Temp.: | 27°C | Humidity: | 55% |

Data: 2

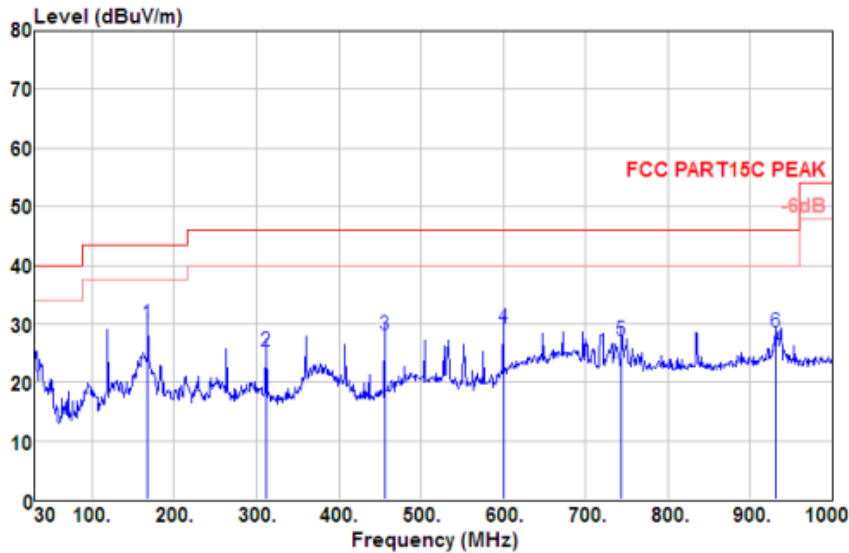

| Freq MHz | Reading level dBuV | Antenna factor dB/m | Cable loss dB | Preamp factor dB | level dBuV | Limit level dBuV/m | Over limit dB | Remark |
|-------------|--------------------------|---------------------------|---------------------|------------------------|---------------|--------------------------|---------------------|--------|
| 167.740 | 46.43 | 13.43 | 2.53 | 32.52 | 29.87 | 43.50 | -13.63 | QP |
| 312.270 | 41.18 | 13.13 | 3.52 | 32.51 | 25.32 | 46.00 | -20.68 | QP |
| 455.830 | 40.46 | 15.75 | 4.34 | 32.52 | 28.03 | 46.00 | -17.97 | QP |
| 600.360 | 38.56 | 18.40 | 5.02 | 32.69 | 29.29 | 46.00 | -16.71 | QP |
| 743.920 | 34.16 | 20.18 | 5.58 | 32.72 | 27.20 | 46.00 | -18.80 | QP |
| 931.130 | 32.21 | 21.89 | 6.44 | 32.07 | 28.47 | 46.00 | -17.53 | QP |

Model No.: HB197-2-L

| | | | |
|------------|-------------------|-------------------|------------|
| Test mode: | Transmitting mode | Antenna Polarity: | Horizontal |
| Temp.: | 27°C | Humidity: | 55% |

Data: 21

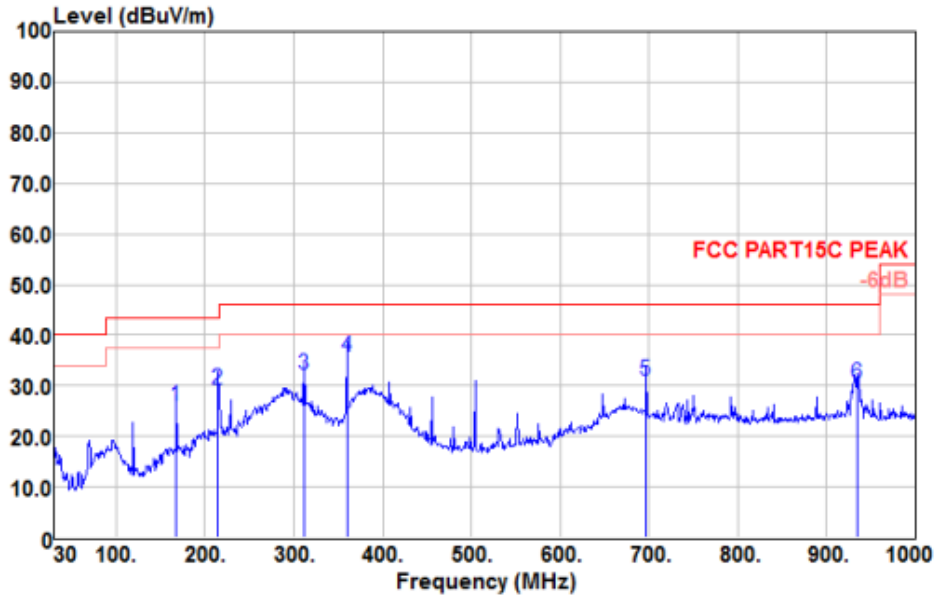

| Freq MHz | Reading level dBuV | Antenna factor dB/m | Cable loss dB | Preamp factor dB | level dBuV | Limit level dBuV/m | Over limit dB | Remark |
|-------------|--------------------------|---------------------------|---------------------|------------------------|---------------|--------------------------|---------------------|--------|
| 167.740 | 42.59 | 13.43 | 2.53 | 32.52 | 26.03 | 43.50 | -17.47 | QP |
| 215.270 | 48.35 | 10.36 | 2.91 | 32.54 | 29.08 | 43.50 | -14.42 | QP |
| 312.270 | 48.08 | 13.13 | 3.52 | 32.51 | 32.22 | 46.00 | -13.78 | QP |
| 359.800 | 50.26 | 14.04 | 3.86 | 32.49 | 35.67 | 46.00 | -10.33 | QP |
| 696.390 | 38.63 | 19.65 | 5.55 | 32.78 | 31.05 | 46.00 | -14.95 | QP |
| 934.040 | 34.25 | 21.90 | 6.43 | 32.07 | 30.51 | 46.00 | -15.49 | QP |

| | | | |
|------------|-------------------|-------------------|----------|
| Test mode: | Transmitting mode | Antenna Polarity: | Vertical |
| Temp.: | 27°C | Humidity: | 55% |

Data: 22

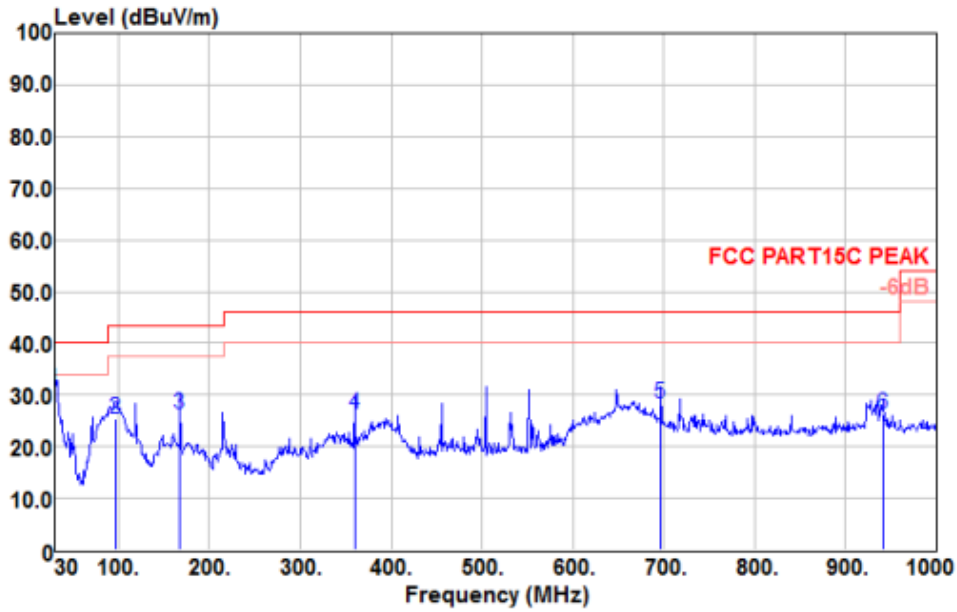

| Freq MHz | Reading level dBUV | Antenna factor dB/m | Cable loss dB | Preamp factor dB | level dBUV | Limit level dBUV/m | Over limit dB | Remark |
|-------------|--------------------------|---------------------------|---------------------|------------------------|---------------|--------------------------|---------------------|--------|
| 30.000 | 49.33 | 13.20 | 0.92 | 32.52 | 30.93 | 40.00 | -9.07 | QP |
| 96.930 | 45.96 | 9.99 | 1.92 | 32.45 | 25.42 | 43.50 | -18.08 | QP |
| 167.740 | 42.72 | 13.43 | 2.53 | 32.52 | 26.16 | 43.50 | -17.34 | QP |
| 359.800 | 40.95 | 14.04 | 3.86 | 32.49 | 26.36 | 46.00 | -19.64 | QP |
| 696.390 | 36.05 | 19.65 | 5.55 | 32.78 | 28.47 | 46.00 | -17.53 | QP |
| 940.830 | 30.01 | 21.94 | 6.43 | 32.06 | 26.32 | 46.00 | -19.68 | QP |

Model No.: HB198-2-L

| | | | |
|------------|-------------------|-------------------|------------|
| Test mode: | Transmitting mode | Antenna Polarity: | Horizontal |
| Temp.: | 27°C | Humidity: | 55% |

Data: 24

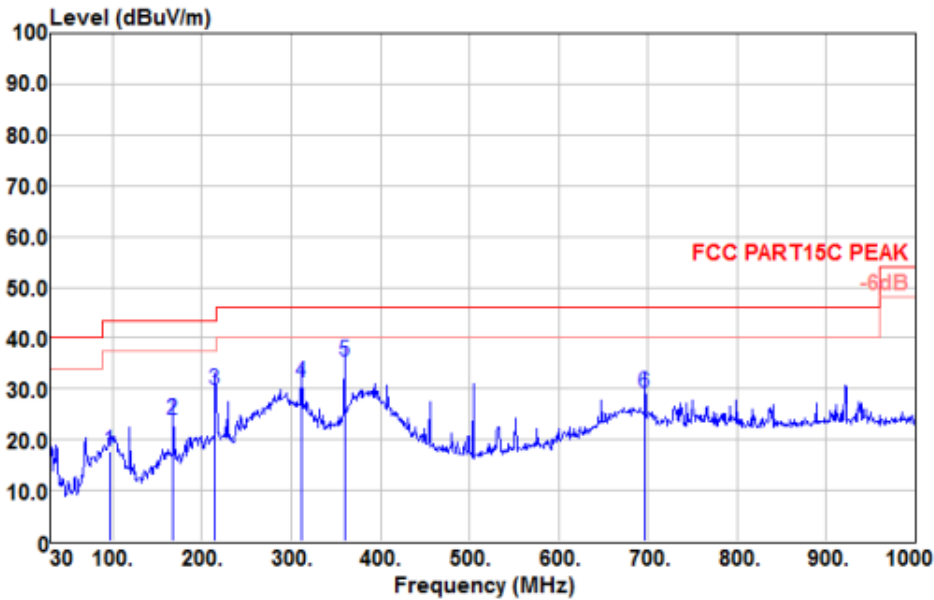

| Freq MHz | Reading level dBuV | Antenna factor dB/m | Cable loss dB | Preamp factor dB | level dBuV | Limit level dBuV/m | Over limit dB | Remark |
|-------------|--------------------------|---------------------------|---------------------|------------------------|---------------|--------------------------|---------------------|--------|
| 96.930 | 38.26 | 9.99 | 1.92 | 32.45 | 17.72 | 43.50 | -25.78 | QP |
| 167.740 | 40.45 | 13.43 | 2.53 | 32.52 | 23.89 | 43.50 | -19.61 | QP |
| 215.270 | 49.21 | 10.36 | 2.91 | 32.54 | 29.94 | 43.50 | -13.56 | QP |
| 312.270 | 47.06 | 13.13 | 3.52 | 32.51 | 31.20 | 46.00 | -14.80 | QP |
| 359.800 | 49.97 | 14.04 | 3.86 | 32.49 | 35.38 | 46.00 | -10.62 | QP |
| 696.390 | 36.80 | 19.65 | 5.55 | 32.78 | 29.22 | 46.00 | -16.78 | QP |

| | | | |
|------------|-------------------|-------------------|----------|
| Test mode: | Transmitting mode | Antenna Polarity: | Vertical |
| Temp.: | 27°C | Humidity: | 55% |

Data: 23

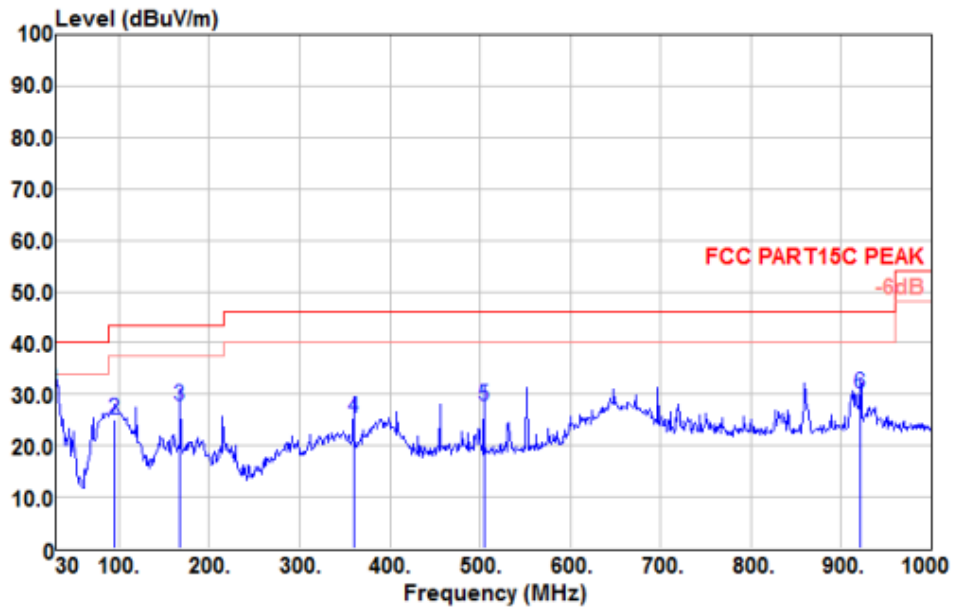

| Freq MHz | Reading level dBuV | Antenna factor dB/m | Cable loss dB | Preamp factor dB | level dBuV | Limit level dBuV/m | Over limit dB | Remark |
|-------------|--------------------------|---------------------------|---------------------|------------------------|---------------|--------------------------|---------------------|--------|
| 30.000 | 48.95 | 13.20 | 0.92 | 32.52 | 30.55 | 40.00 | -9.45 | QP |
| 95.960 | 45.56 | 9.92 | 1.91 | 32.45 | 24.94 | 43.50 | -18.56 | QP |
| 167.740 | 44.43 | 13.43 | 2.53 | 32.52 | 27.87 | 43.50 | -15.63 | QP |
| 359.800 | 40.05 | 14.04 | 3.86 | 32.49 | 25.46 | 46.00 | -20.54 | QP |
| 504.330 | 39.08 | 16.58 | 4.51 | 32.56 | 27.61 | 46.00 | -18.39 | QP |
| 920.460 | 33.83 | 21.82 | 6.44 | 32.08 | 30.01 | 46.00 | -15.99 | QP |

Model No.: HB198-3-L

| | | | |
|------------|-------------------|-------------------|------------|
| Test mode: | Transmitting mode | Antenna Polarity: | Horizontal |
| Temp.: | 27°C | Humidity: | 55% |

Data: 25

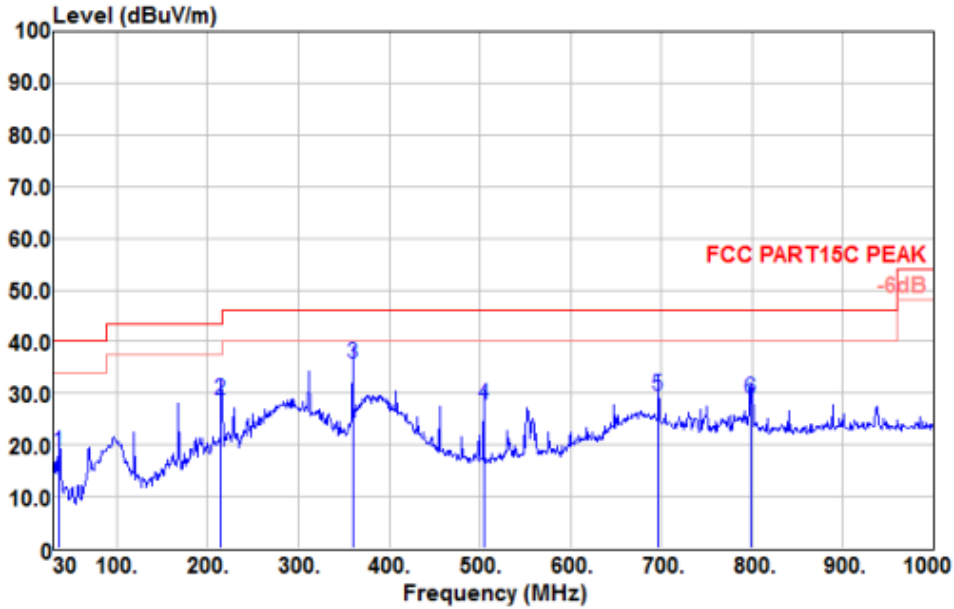

| Freq MHz | Reading level dBuV | Antenna factor dB/m | Cable loss dB | Preamp factor dB | level dBuV | Limit level dBuV/m | Over limit dB | Remark |
|-------------|--------------------------|---------------------------|---------------------|------------------------|---------------|--------------------------|---------------------|--------|
| 36.790 | 36.48 | 13.65 | 1.14 | 32.55 | 18.72 | 40.00 | -21.28 | QP |
| 215.270 | 48.00 | 10.36 | 2.91 | 32.54 | 28.73 | 43.50 | -14.77 | QP |
| 359.800 | 50.40 | 14.04 | 3.86 | 32.49 | 35.81 | 46.00 | -10.19 | QP |
| 504.330 | 39.17 | 16.58 | 4.51 | 32.56 | 27.70 | 46.00 | -18.30 | QP |
| 696.390 | 37.07 | 19.65 | 5.55 | 32.78 | 29.49 | 46.00 | -16.51 | QP |
| 799.210 | 34.56 | 20.79 | 6.12 | 32.65 | 28.82 | 46.00 | -17.18 | QP |

| | | | |
|------------|-------------------|-------------------|----------|
| Test mode: | Transmitting mode | Antenna Polarity: | Vertical |
| Temp.: | 27°C | Humidity: | 55% |

Data: 26

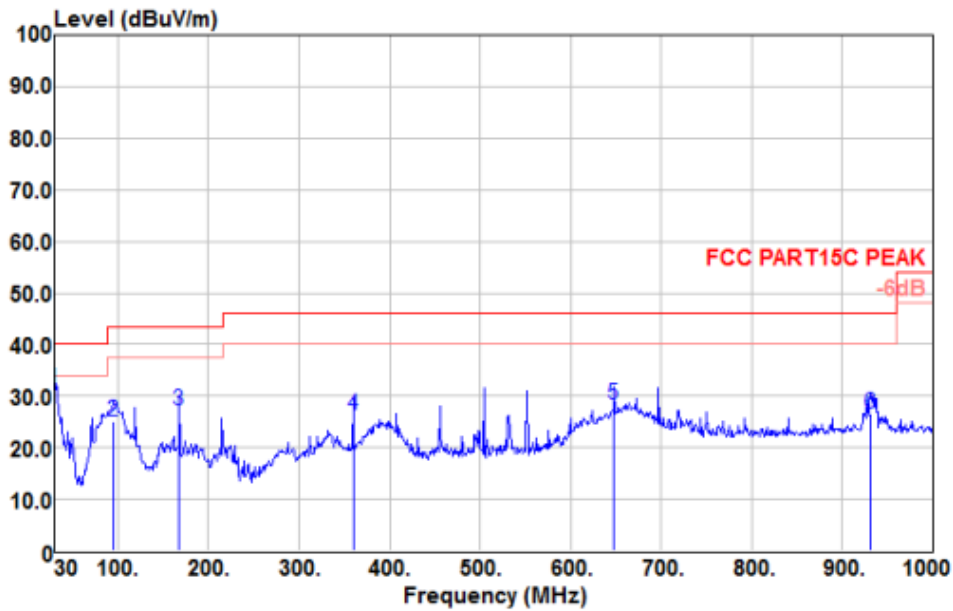

| Freq MHz | Reading level dBuV | Antenna factor dB/m | Cable loss dB | Preamp factor dB | level dBuV | Limit level dBUV/m | Over limit dB | Remark |
|-------------|--------------------------|---------------------------|---------------------|------------------------|---------------|--------------------------|---------------------|--------|
| 30.000 | 49.71 | 13.20 | 0.92 | 32.52 | 31.31 | 40.00 | -8.69 | QP |
| 95.960 | 45.67 | 9.92 | 1.91 | 32.45 | 25.05 | 43.50 | -18.45 | QP |
| 167.740 | 43.75 | 13.43 | 2.53 | 32.52 | 27.19 | 43.50 | -16.31 | QP |
| 359.800 | 40.98 | 14.04 | 3.86 | 32.49 | 26.39 | 46.00 | -19.61 | QP |
| 647.890 | 36.73 | 19.02 | 5.17 | 32.73 | 28.19 | 46.00 | -17.81 | QP |
| 931.130 | 30.42 | 21.89 | 6.44 | 32.07 | 26.68 | 46.00 | -19.32 | QP |

■ Above 1GHz

| | |
|---------------|--------|
| Test channel: | Lowest |
|---------------|--------|

Peak value:

| Frequency (MHz) | Read Level (dBuV) | Antenna Factor (dB/m) | Cable Loss (dB) | Preamp Factor (dB) | Level (dBuV/m) | Limit Line (dBuV/m) | Over Limit (dB) | Polarization |
|-----------------|-------------------|-----------------------|-----------------|--------------------|----------------|---------------------|-----------------|--------------|
| 4804.00 | 40.02 | 31.23 | 5.45 | 36.27 | 40.43 | 74.00 | -33.57 | Vertical |
| 7206.00 | 39.82 | 35.87 | 6.94 | 34.25 | 48.38 | 74.00 | -25.62 | Vertical |
| 9608.00 | 39.94 | 37.79 | 7.77 | 34.13 | 51.37 | 74.00 | -22.63 | Vertical |
| 12010.00 | * | | | | | 74.00 | * | Vertical |
| 14412.00 | * | | | | | 74.00 | * | Vertical |
| 4804.00 | 43.43 | 31.23 | 5.45 | 36.27 | 43.84 | 74.00 | -30.16 | Horizontal |
| 7206.00 | 40.42 | 35.87 | 6.94 | 34.25 | 48.98 | 74.00 | -25.02 | Horizontal |
| 9608.00 | 40.62 | 37.79 | 7.77 | 34.13 | 52.05 | 74.00 | -21.95 | Horizontal |
| 12010.00 | * | | | | | 74.00 | * | Horizontal |
| 14412.00 | * | | | | | 74.00 | * | Horizontal |

Average value:

| Frequency (MHz) | Read Level (dBuV) | Antenna Factor (dB/m) | Cable Loss (dB) | Preamp Factor (dB) | Level (dBuV/m) | Limit Line (dBuV/m) | Over Limit (dB) | Polarization |
|-----------------|-------------------|-----------------------|-----------------|--------------------|----------------|---------------------|-----------------|--------------|
| 4804.00 | 30.02 | 31.23 | 5.45 | 36.27 | 30.43 | 54.00 | -23.57 | Vertical |
| 7206.00 | 28.82 | 35.87 | 6.94 | 34.25 | 37.38 | 54.00 | -16.62 | Vertical |
| 9608.00 | 28.64 | 37.79 | 7.77 | 34.13 | 40.07 | 54.00 | -13.93 | Vertical |
| 12010.00 | * | | | | | 54.00 | * | Vertical |
| 14412.00 | * | | | | | 54.00 | * | Vertical |
| 4804.00 | 32.23 | 31.23 | 5.45 | 36.27 | 32.64 | 54.00 | -21.36 | Horizontal |
| 7206.00 | 29.38 | 35.87 | 6.94 | 34.25 | 37.94 | 54.00 | -16.06 | Horizontal |
| 9608.00 | 28.54 | 37.79 | 7.77 | 34.13 | 39.97 | 54.00 | -14.03 | Horizontal |
| 12010.00 | * | | | | | 54.00 | * | Horizontal |
| 14412.00 | * | | | | | 54.00 | * | Horizontal |

Remark:

1. Final Level = Receiver Read level + Antenna Factor + Cable Loss – Preamplifier Factor
2. “*”, means this data is the too weak instrument of signal is unable to test.
3. The emission levels of other frequencies are very lower than the limit and not show in test report.

| | |
|---------------|--------|
| Test channel: | Middle |
|---------------|--------|

Peak value:

| Frequency (MHz) | Read Level (dBuV) | Antenna Factor (dB/m) | Cable Loss (dB) | Preamplifier Factor (dB) | Level (dBuV/m) | Limit Line (dBuV/m) | Over Limit (dB) | Polarization |
|-----------------|-------------------|-----------------------|-----------------|--------------------------|----------------|---------------------|-----------------|--------------|
| 4882.00 | 45.24 | 31.42 | 5.40 | 36.24 | 45.82 | 74.00 | -28.18 | Vertical |
| 7323.00 | 40.94 | 36.14 | 7.28 | 34.36 | 50.00 | 74.00 | -24.00 | Vertical |
| 9764.00 | 38.45 | 38.08 | 7.98 | 34.20 | 50.31 | 74.00 | -23.69 | Vertical |
| 12205.00 | * | | | | | 74.00 | * | Vertical |
| 14646.00 | * | | | | | 74.00 | * | Vertical |
| 4882.00 | 43.28 | 31.42 | 5.40 | 36.24 | 43.86 | 74.00 | -30.14 | Horizontal |
| 7323.00 | 42.02 | 36.14 | 7.28 | 34.36 | 51.08 | 74.00 | -22.92 | Horizontal |
| 9764.00 | 38.76 | 38.08 | 7.98 | 34.20 | 50.62 | 74.00 | -23.38 | Horizontal |
| 12205.00 | * | | | | | 74.00 | * | Horizontal |
| 14646.00 | * | | | | | 74.00 | * | Horizontal |

Average value:

| Frequency (MHz) | Read Level (dBuV) | Antenna Factor (dB/m) | Cable Loss (dB) | Preamplifier Factor (dB) | Level (dBuV/m) | Limit Line (dBuV/m) | Over Limit (dB) | Polarization |
|-----------------|-------------------|-----------------------|-----------------|--------------------------|----------------|---------------------|-----------------|--------------|
| 4882.00 | 35.21 | 31.42 | 5.40 | 36.24 | 35.79 | 54.00 | -18.21 | Vertical |
| 7323.00 | 29.84 | 36.14 | 7.28 | 34.36 | 38.90 | 54.00 | -15.10 | Vertical |
| 9764.00 | 29.56 | 38.08 | 7.98 | 34.20 | 41.42 | 54.00 | -12.58 | Vertical |
| 12205.00 | * | | | | | 54.00 | * | Vertical |
| 14646.00 | * | | | | | 54.00 | * | Vertical |
| 4882.00 | 35.52 | 31.42 | 5.40 | 36.24 | 33.10 | 54.00 | -20.90 | Horizontal |
| 7323.00 | 30.12 | 36.14 | 7.28 | 34.36 | 39.18 | 54.00 | -14.82 | Horizontal |
| 9764.00 | 27.42 | 38.08 | 7.98 | 34.20 | 39.28 | 54.00 | -14.72 | Horizontal |
| 12205.00 | * | | | | | 54.00 | * | Horizontal |
| 14646.00 | * | | | | | 54.00 | * | Horizontal |

Remark:

1. *Final Level = Receiver Read level + Antenna Factor + Cable Loss – Preamplifier Factor*
2. *“*”*, means this data is the too weak instrument of signal is unable to test.
3. *The emission levels of other frequencies are very lower than the limit and not show in test report.*

| | |
|---------------|---------|
| Test channel: | Highest |
|---------------|---------|

Peak value:

| Frequency (MHz) | Read Level (dBuV) | Antenna Factor (dB/m) | Cable Loss (dB) | Preamplifier Factor (dB) | Level (dBuV/m) | Limit Line (dBuV/m) | Over Limit (dB) | Polarization |
|-----------------|-------------------|-----------------------|-----------------|--------------------------|----------------|---------------------|-----------------|--------------|
| 4960.00 | 45.59 | 31.60 | 5.36 | 36.21 | 46.34 | 74.00 | -27.66 | Vertical |
| 7440.00 | 41.95 | 36.41 | 7.44 | 34.47 | 51.33 | 74.00 | -22.67 | Vertical |
| 9920.00 | 41.65 | 38.36 | 8.05 | 34.26 | 53.80 | 74.00 | -20.20 | Vertical |
| 12400.00 | * | | | | | 74.00 | * | Vertical |
| 14880.00 | * | | | | | 74.00 | * | Vertical |
| 4960.00 | 42.40 | 31.60 | 5.36 | 36.21 | 43.15 | 74.00 | -30.85 | Horizontal |
| 7440.00 | 41.67 | 36.41 | 7.44 | 34.47 | 51.05 | 74.00 | -22.95 | Horizontal |
| 9920.00 | 40.20 | 38.36 | 8.05 | 34.26 | 52.35 | 74.00 | -21.65 | Horizontal |
| 12400.00 | * | | | | | 74.00 | * | Horizontal |
| 14880.00 | * | | | | | 74.00 | * | Horizontal |

Average value:

| Frequency (MHz) | Read Level (dBuV) | Antenna Factor (dB/m) | Cable Loss (dB) | Preamplifier Factor (dB) | Level (dBuV/m) | Limit Line (dBuV/m) | Over Limit (dB) | Polarization |
|-----------------|-------------------|-----------------------|-----------------|--------------------------|----------------|---------------------|-----------------|--------------|
| 4960.00 | 33.72 | 31.60 | 5.36 | 36.21 | 34.47 | 54.00 | -19.53 | Vertical |
| 7440.00 | 30.25 | 36.41 | 7.44 | 34.47 | 39.63 | 54.00 | -14.37 | Vertical |
| 9920.00 | 31.44 | 38.36 | 8.05 | 34.26 | 43.59 | 54.00 | -10.41 | Vertical |
| 12400.00 | * | | | | | 54.00 | * | Vertical |
| 14880.00 | * | | | | | 54.00 | * | Vertical |
| 4960.00 | 39.72 | 31.60 | 5.36 | 36.21 | 40.47 | 54.00 | -13.53 | Horizontal |
| 7440.00 | 28.96 | 36.41 | 7.44 | 34.47 | 38.34 | 54.00 | -15.66 | Horizontal |
| 9920.00 | 29.41 | 38.36 | 8.05 | 34.26 | 41.56 | 54.00 | -12.44 | Horizontal |
| 12400.00 | * | | | | | 54.00 | * | Horizontal |
| 14880.00 | * | | | | | 54.00 | * | Horizontal |

Remark:

1. *Final Level = Receiver Read level + Antenna Factor + Cable Loss – Preamplifier Factor*
2. *“**”, means this data is the too weak instrument of signal is unable to test.*
3. *The emission levels of other frequencies are very lower than the limit and not show in test report.*

8 Test Setup Photo

Radiated Emission

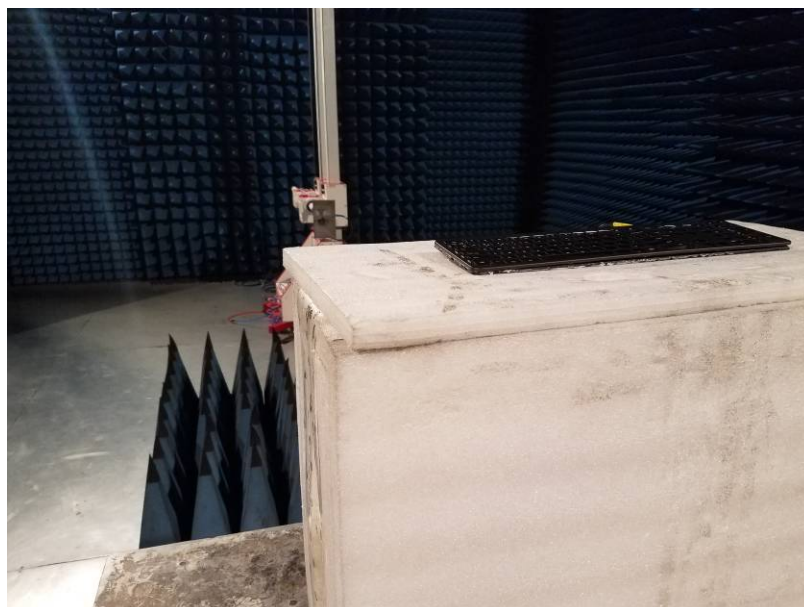
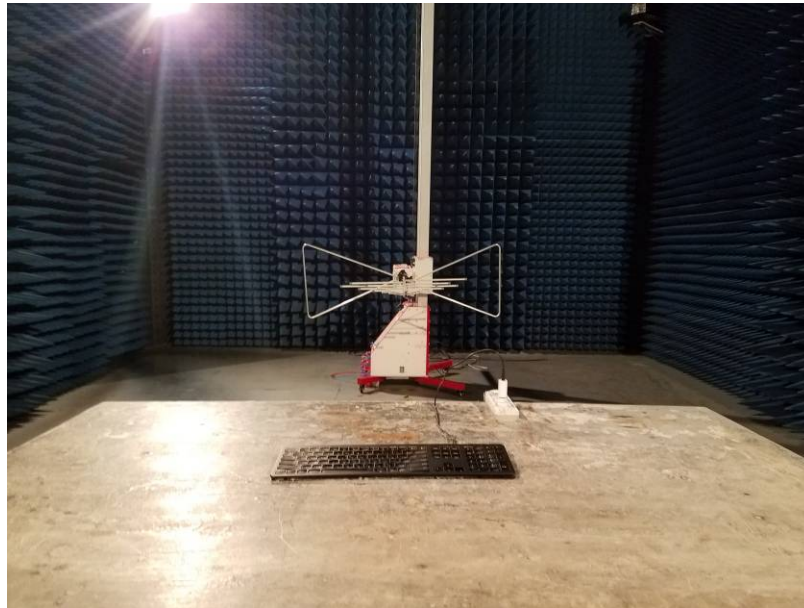

Conducted Emission



9 EUT Constructional Details

Test Model No.: HB197-3-L



Model No.: HB197-2-L



Model No.: HB198-3-L



Model No.: HB198-2-L



Test Model No.: HB197-3-L



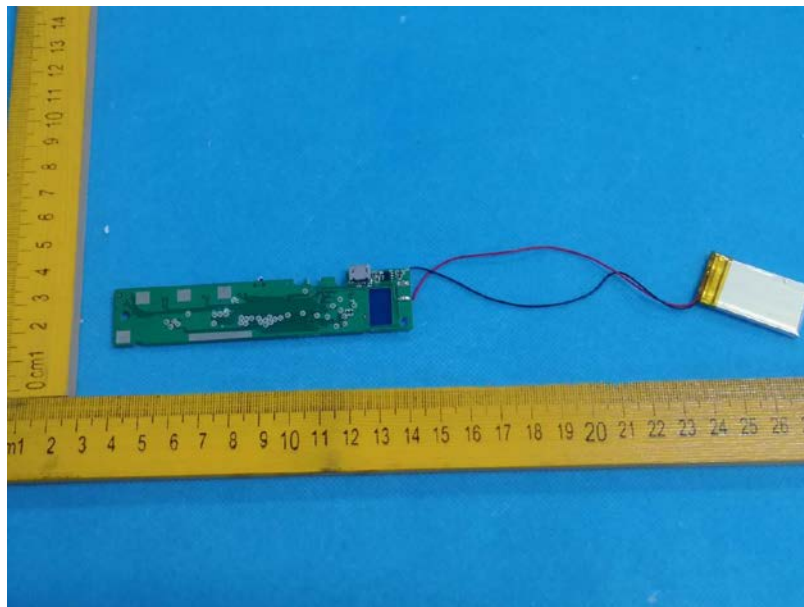

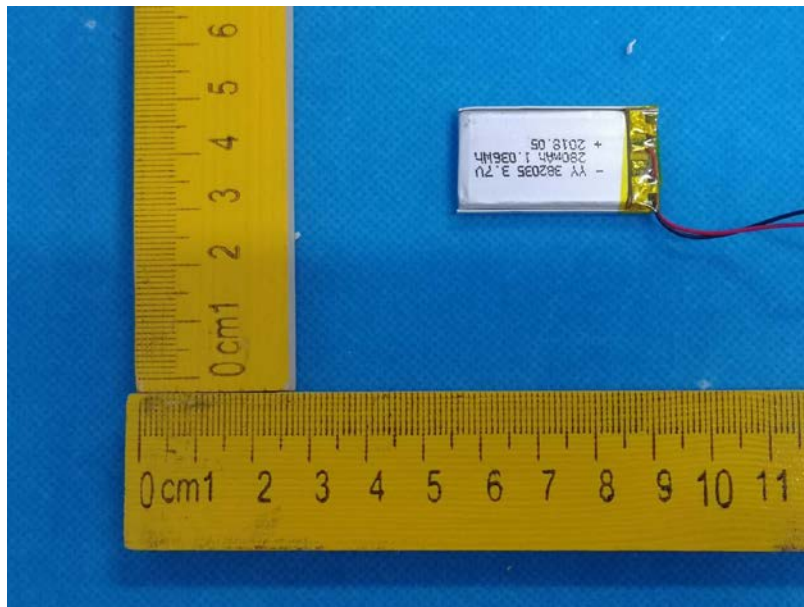
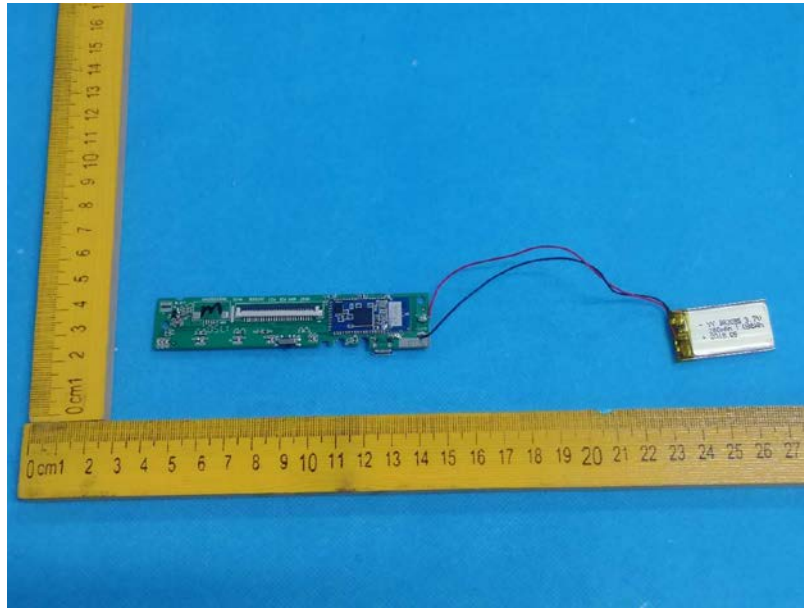

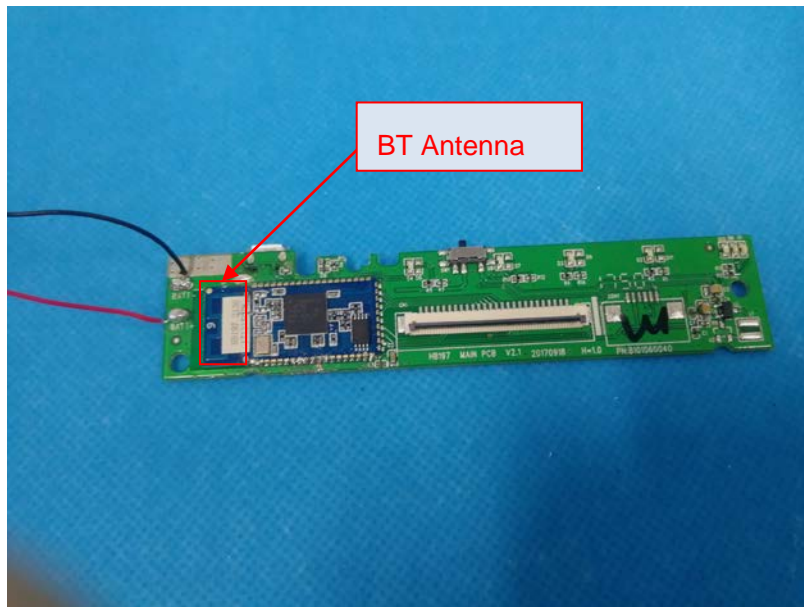
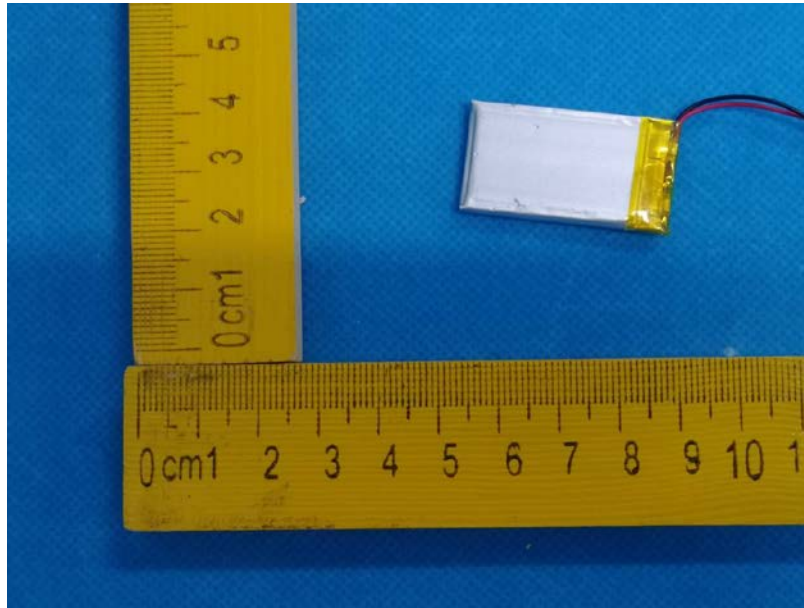

-----End-----