

FCC Report (Bluetooth)

Applicant: Shenzhen Hangshi Technology Co., Ltd

Address of Applicant: Hangshi Technology Park, Democracy West Industry Area, Shajing Town, Bao'an Distric, Shenzhen, China

Manufacturer/Factory: Shenzhen Hangshi Technology Co., Ltd

Address of Manufacturer/Factory: Hangshi Technology Park, Democracy West Industry Area, Shajing Town, Bao'an Distric, Shenzhen, China

Equipment Under Test (EUT)

Product Name: Bluetooth Keyboard

Model No.: HB188S

FCC ID: 2AKHJHB188S

Applicable standards: FCC CFR Title 47 Part 15 Subpart C Section 15.247

Date of sample receipt: May 09, 2018

Date of Test: May 10- 25, 2018

Date of report issued: May 25, 2018

Test Result : PASS *

* In the configuration tested, the EUT complied with the standards specified above.

Authorized Signature:



Robinson Lo
Laboratory Manager

This results shown in this test report refer only to the sample(s) tested, this test report cannot be reproduced, except in full, without prior written permission of the company. The report would be invalid without specific stamp of test institute and the signatures of compiler and approver.

2 Version

Version No.	Date	Description
V1.0	May 25, 2018	Original

Prepared By:



Date:

May 25, 2018

Project Engineer

Check By:

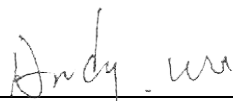

Date:

May 25, 2018

Reviewer

3 Contents

	Page
1 COVER PAGE	1
2 VERSION	2
3 CONTENTS	3
4 TEST SUMMARY	4
5 GENERAL INFORMATION	5
5.1 GENERAL DESCRIPTION OF EUT	5
5.2 TEST MODE	7
5.3 TEST FACILITY	7
5.4 TEST LOCATION	7
5.5 OTHER INFORMATION REQUESTED BY THE CUSTOMER	7
5.6 DESCRIPTION OF SUPPORT UNITS	7
5.7 ADDITIONAL INSTRUCTIONS	8
6 TEST INSTRUMENTS LIST	9
7 TEST RESULTS AND MEASUREMENT DATA	10
7.1 ANTENNA REQUIREMENT	10
7.2 CONDUCTED EMISSIONS	11
7.3 CONDUCTED PEAK OUTPUT POWER	14
7.4 20dB EMISSION BANDWIDTH	16
7.5 CARRIER FREQUENCIES SEPARATION	18
7.6 HOPPING CHANNEL NUMBER	20
7.7 DWELL TIME	21
7.8 PSEUDORANDOM FREQUENCY HOPPING SEQUENCE	23
7.9 BAND EDGE	24
7.9.1 <i>Conducted Emission Method</i>	24
7.9.2 <i>Radiated Emission Method</i>	26
7.10 SPURIOUS EMISSION	28
7.10.1 <i>Conducted Emission Method</i>	28
7.10.2 <i>Radiated Emission Method</i>	30
8 TEST SETUP PHOTO	38
9 EUT CONSTRUCTIONAL DETAILS	40

4 Test Summary

Test Item	Section in CFR 47	Result
Antenna Requirement	15.203/15.247 (c)	Pass
AC Power Line Conducted Emission	15.207	Pass
Conducted Peak Output Power	15.247 (b)(1)	Pass
20dB Occupied Bandwidth	15.247 (a)(1)	Pass
Carrier Frequencies Separation	15.247 (a)(1)	Pass
Hopping Channel Number	15.247 (a)(1)	Pass
Dwell Time	15.247 (a)(1)	Pass
Pseudorandom Frequency Hopping Sequence	15.247(b)(4)	Pass
Radiated Emission	15.205/15.209	Pass
Band Edge	15.247(d)	Pass

Pass: The EUT complies with the essential requirements in the standard.

Remark: Test according to ANSI C63.4:2014 and ANSI C63.10:2013

Measurement Uncertainty

Test Item	Frequency Range	Measurement Uncertainty	Notes
Radiated Emission	9kHz ~ 30MHz	± 4.34dB	(1)
Radiated Emission	30MHz ~ 1000MHz	± 4.24dB	(1)
Radiated Emission	1GHz ~ 26.5GHz	± 4.68dB	(1)
AC Power Line Conducted Emission	0.15MHz ~ 30MHz	± 3.45dB	(1)

Note (1): The measurement uncertainty is for coverage factor of k=2 and a level of confidence of 95%.

5 General Information

5.1 General Description of EUT

Product Name:	Bluetooth Keyboard
Model No.:	HB188S
Serial No.:	HSHB188s00001
Test sample(s) ID:	GTS201805000108-1
Sample(s) Status	Engineer sample
Hardware:	V1.0
Software:	V1.0
Operation Frequency:	2402MHz~2480MHz
Channel numbers:	79
Channel separation:	1MHz
Modulation type:	GFSK
Antenna Type:	PCB Antenna
Antenna gain:	1.87dBi
Power supply:	DC 3.7V by Li-ON battery

Operation Frequency each of channel							
Channel	Frequency	Channel	Frequency	Channel	Frequency	Channel	Frequency
1	2402MHz	21	2422MHz	41	2442MHz	61	2462MHz
2	2403MHz	22	2423MHz	42	2443MHz	62	2463MHz
3	2404MHz	23	2424MHz	43	2444MHz	63	2464MHz
4	2405MHz	24	2425MHz	44	2445MHz	64	2465MHz
5	2406MHz	25	2426MHz	45	2446MHz	65	2466MHz
6	2407MHz	26	2427MHz	46	2447MHz	66	2467MHz
7	2408MHz	27	2428MHz	47	2448MHz	67	2468MHz
8	2409MHz	28	2429MHz	48	2449MHz	68	2469MHz
9	2410MHz	29	2430MHz	49	2450MHz	69	2470MHz
10	2411MHz	30	2431MHz	50	2451MHz	70	2471MHz
11	2412MHz	31	2432MHz	51	2452MHz	71	2472MHz
12	2413MHz	32	2433MHz	52	2453MHz	72	2473MHz
13	2414MHz	33	2434MHz	53	2454MHz	73	2474MHz
14	2415MHz	34	2435MHz	54	2455MHz	74	2475MHz
15	2416MHz	35	2436MHz	55	2456MHz	75	2476MHz
16	2417MHz	36	2437MHz	56	2457MHz	76	2477MHz
17	2418MHz	37	2438MHz	57	2458MHz	77	2478MHz
18	2419MHz	38	2439MHz	58	2459MHz	78	2479MHz
19	2420MHz	39	2440MHz	59	2460MHz	79	2480MHz
20	2421MHz	40	2441MHz	60	2461MHz		

Note:

In section 15.31(m), regards to the operating frequency range over 10 MHz, the Lowest frequency, the middle frequency, and the highest frequency of channel were selected to perform the test, and the selected channel see below:

Channel	Frequency
The lowest channel	2402MHz
The middle channel	2441MHz
The Highest channel	2480MHz

5.2 Test mode

Transmitting mode	Keep the EUT in continuously transmitting mode.
<i>Remark: During the test, the test voltage was tuned from 85% to 115% of the nominal rated supply voltage, and found that the worst case was under the nominal rated supply condition. So the report just shows that condition's data.</i>	

5.3 Test Facility

<p>The test facility is recognized, certified, or accredited by the following organizations:</p> <ul style="list-style-type: none"> ● FCC —Registration No.: 381383 Global United Technology Services Co., Ltd., Shenzhen EMC Laboratory has been registered and fully described in a report filed with the (FCC) Federal Communications Commission. The acceptance letter from the FCC is maintained in files. Registration 381383, January 08, 2018. ● Industry Canada (IC) —Registration No.: 9079A-2 The 3m Semi-anechoic chamber of Global United Technology Services Co., Ltd. has been registered by Certification and Engineering Bureau of Industry Canada for radio equipment testing with Registration No.: 9079A-2, August 15, 2016.
--

5.4 Test Location

All tests were performed at:
<p>Global United Technology Services Co., Ltd. Address: No. 301-309, 3/F., Jinyuan Business Building, No.2, Laodong Industrial Zone, Xixiang Road, Baoan District, Shenzhen, Guangdong, China 518102 Tel: 0755-27798480 Fax: 0755-27798960</p>

5.5 Other Information Requested by the Customer

None.

5.6 Description of Support Units

Manufacturer	Description	Model	Serial Number
Emerson Network Power	USB Charger	A1299	N/A

5.7 Additional Instructions

EUT Software Settings:

Mode	Special software is used. The software provided by client to enable the EUT under transmission condition continuously at specific channel frequencies individually.
------	--

Power level setup in software			
Test Software Name	Broadcom BlueTool		
Mode	Channel	Frequency (MHz)	Soft Set
GFSK	CH00	2402	TX level : 0dBm
	CH39	2441	
	CH79	2480	

Run Software

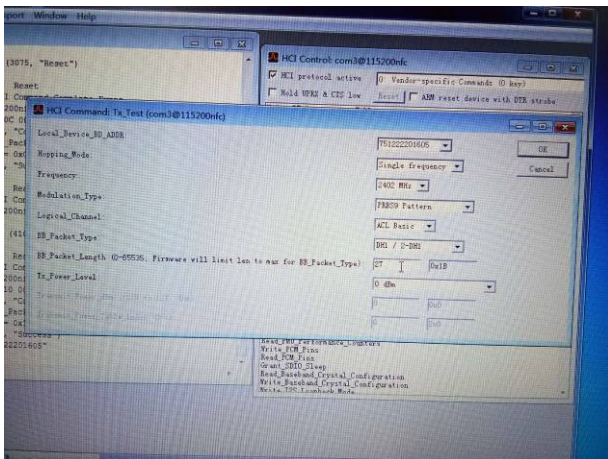

6 Test Instruments list

Radiated Emission:						
Item	Test Equipment	Manufacturer	Model No.	Inventory No.	Cal.Date (mm-dd-yy)	Cal.Due date (mm-dd-yy)
1	3m Semi- Anechoic Chamber	ZhongYu Electron	9.0(L)*6.0(W)* 6.0(H)	GTS250	July. 03 2015	July 02 2020
2	Control Room	ZhongYu Electron	6.2(L)*2.5(W)* 2.4(H)	GTS251	N/A	N/A
3	ESU EMI Test Receiver	R&S	ESU26	GTS203	June 28 2017	June 27 2018
4	Loop Antenna	Zhinan	ZN30900A	GTS534	June 28 2017	June 27 2018
5	BiConiLog Antenna	SCHWARZBECK	VULB9163	GTS214	June 28 2017	June 27 2018
6	Double-ridged horn antenna	SCHWARZBECK	9120D	GTS208	June 28 2017	June 27 2018
7	Horn Antenna	ETS-LINDGREN	3160-09	GTS218	June 28 2017	June 27 2018
8	RF Amplifier	HP	8347A	GTS204	June 28 2017	June 27 2018
9	RF Amplifier	HP	8349B	GTS206	June 28 2017	June 27 2018
10	Broadband Preamplifier	SCHWARZBECK	BBV9718	GTS535	June 28 2017	June 27 2018
11	Spectrum Analyzer	Keysight	N9010A	GTS536	March 02 2017	March 01 2018
12	EMI Test Software	AUDIX	E3	N/A	N/A	N/A
13	Coaxial Cable	GTS	N/A	GTS210	June 28 2017	June 27 2018
14	Coaxial Cable	GTS	N/A	GTS211	June 28 2017	June 27 2018
15	Coaxial Cable	GTS	N/A	GTS210	June 28 2017	June 27 2018
16	Coaxial Cable	GTS	N/A	GTS212	June 28 2017	June 27 2018
17	Thermo meter	N/A	N/A	GTS256	June 28 2017	June 27 2018
18	D.C. Power Supply	Instek	PS-3030	GTS232	June 28 2017	June 27 2018
19	Loop Antenna	ZHINAN	ZN30900A	GTS534	June 28 2017	June 27 2018

Conducted Emission						
Item	Test Equipment	Manufacturer	Model No.	Inventory No.	Cal.Date (mm-dd-yy)	Cal.Due date (mm-dd-yy)
1	Shielding Room	ZhongYu Electron	7.3(L)x3.1(W)x2.9(H)	GTS252	May.16 2014	May 15 2019
2	EMI Test Receiver	R&S	ESCI 7	GTS552	June 28 2017	June 27 2018
3	Coaxial Switch	ANRITSU CORP	MP59B	GTS225	June 28 2017	June 27 2018
4	Artificial Mains Network	SCHWARZBECK MESS	NSLK8127	GTS226	June 28 2017	June 27 2018
5	High voltage probe	SCHWARZBECK	TK9420	GTS537	June 28 2017	June 27 2018
6	ISN	SCHWARZBECK	NTFM 8158	GTS565	June 28 2017	June 27 2018
7	Coaxial Cable	GTS	N/A	GTS227	June 28 2017	June 27 2018
8	EMI Test Software	AUDIX	E3	N/A	N/A	N/A
9	Thermo meter	KTJ	TA328	GTS233	June 28 2017	June 27 2018
10	10dB Pulse Limiter	Rohde & Schwarz	N/A	GTS224	June 28 2017	June 27 2018

General used equipment:						
Item	Test Equipment	Manufacturer	Model No.	Inventory No.	Cal.Date (mm-dd-yy)	Cal.Due date (mm-dd-yy)
1	Barometer	ChangChun	DYM3	GTS257	June 28 2017	June 27 2018

7 Test results and Measurement Data

7.1 Antenna requirement

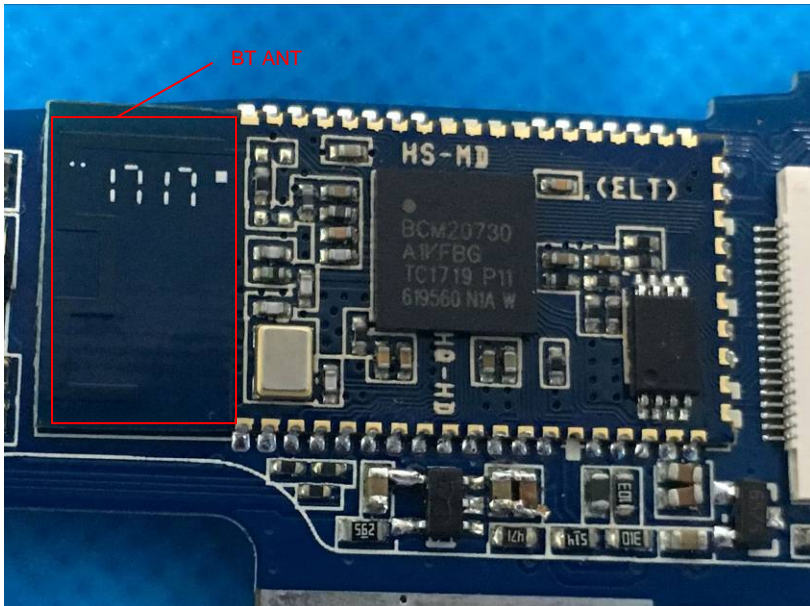
Standard requirement:	FCC Part15 C Section 15.203 /247(c)
<p>15.203 requirement:</p> <p>An intentional radiator shall be designed to ensure that no antenna other than that furnished by the responsible party shall be used with the device. The use of a permanently attached antenna or of an antenna that uses a unique coupling to the intentional radiator, the manufacturer may design the unit so that a broken antenna can be replaced by the user, but the use of a standard antenna jack or electrical connector is prohibited.</p> <p>15.247(c) (1)(i) requirement:</p> <p>(i) Systems operating in the 2400-2483.5 MHz band that is used exclusively for fixed. Point-to-point operations may employ transmitting antennas with directional gain greater than 6dBi provided the maximum conducted output power of the intentional radiator is reduced by 1 dB for every 3 dB that the directional gain of the antenna exceeds 6dBi.</p>	
E.U.T Antenna:	
<p><i>The antenna is PCB antenna, the best case gain of the antenna is 1.87dBi</i></p> 	

7.2 Conducted Emissions

Test Requirement:	FCC Part15 C Section 15.207														
Test Method:	ANSI C63.10:2013														
Test Frequency Range:	150KHz to 30MHz														
Class / Severity:	Class B														
Receiver setup:	RBW=9KHz, VBW=30KHz, Sweep time=auto														
Limit:	<table border="1"> <thead> <tr> <th rowspan="2">Frequency range (MHz)</th> <th colspan="2">Limit (dBuV)</th> </tr> <tr> <th>Quasi-peak</th> <th>Average</th> </tr> </thead> <tbody> <tr> <td>0.15-0.5</td> <td>66 to 56*</td> <td>56 to 46*</td> </tr> <tr> <td>0.5-5</td> <td>56</td> <td>46</td> </tr> <tr> <td>5-30</td> <td>60</td> <td>50</td> </tr> </tbody> </table> <p>* Decreases with the logarithm of the frequency.</p>	Frequency range (MHz)	Limit (dBuV)		Quasi-peak	Average	0.15-0.5	66 to 56*	56 to 46*	0.5-5	56	46	5-30	60	50
Frequency range (MHz)	Limit (dBuV)														
	Quasi-peak	Average													
0.15-0.5	66 to 56*	56 to 46*													
0.5-5	56	46													
5-30	60	50													
Test setup:	<p><i>Remark</i> E.U.T: Equipment Under Test LISN: Line Impedance Stabilization Network Test table height=0.8m</p>														
Test procedure:	<ol style="list-style-type: none"> 1. The E.U.T and simulators are connected to the main power through a line impedance stabilization network (L.I.S.N.). This provides a 50ohm/50uH coupling impedance for the measuring equipment. 2. The peripheral devices are also connected to the main power through a LISN that provides a 50ohm/50uH coupling impedance with 50ohm termination. (Please refer to the block diagram of the test setup and photographs). 3. Both sides of A.C. line are checked for maximum conducted interference. In order to find the maximum emission, the relative positions of equipment and all of the interface cables must be changed according to ANSI C63.10:2013 on conducted measurement. 														
Test Instruments:	Refer to section 6.0 for details														
Test mode:	Refer to section 5.2 for details														
Test results:	Pass														

Measurement data:

Line:

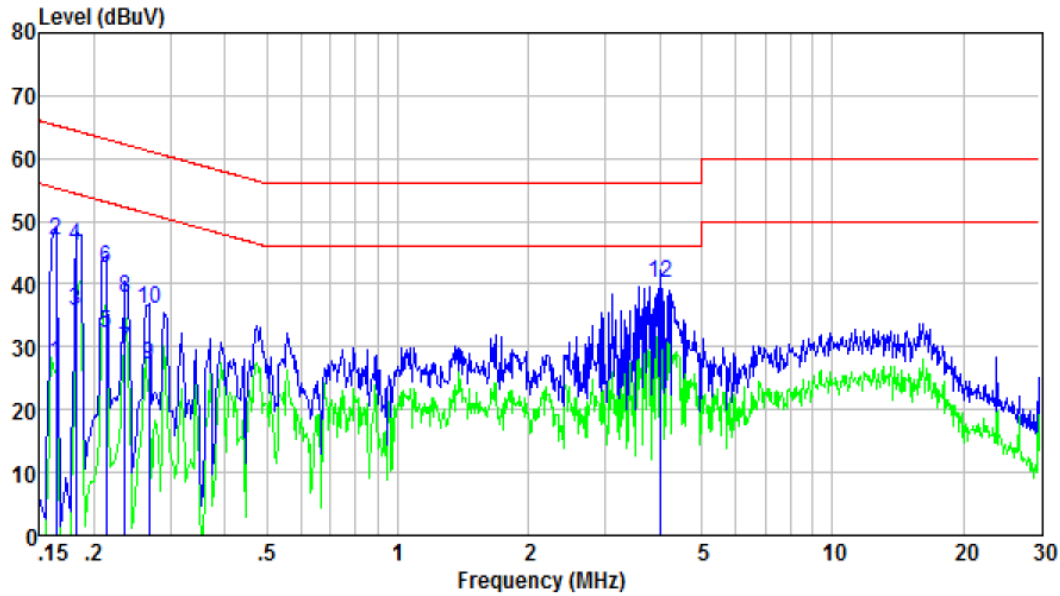

Freq MHz	Reading level dBuV	LISN/ISN factor dB	Cable loss dB	level dBuV	Limit level dBuV	Over limit dB	Remark
0.163	17.80	9.55	0.05	27.40	55.30	-27.90	Average
0.163	37.20	9.55	0.05	46.80	65.30	-18.50	QP
0.182	26.10	9.55	0.03	35.68	54.42	-18.74	Average
0.182	36.50	9.55	0.03	46.08	64.42	-18.34	QP
0.213	22.60	9.56	0.01	32.17	53.10	-20.93	Average
0.213	32.90	9.56	0.01	42.47	63.10	-20.63	QP
0.235	19.81	9.56	0.01	29.38	52.26	-22.88	Average
0.235	28.31	9.56	0.01	37.88	62.26	-24.38	QP
0.267	17.60	9.57	0.01	27.18	51.20	-24.02	Average
0.267	26.30	9.57	0.01	35.88	61.20	-25.32	QP
4.006	18.20	9.63	0.03	27.86	46.00	-18.14	Average
4.006	30.50	9.63	0.03	40.16	56.00	-15.84	QP

Neutral:

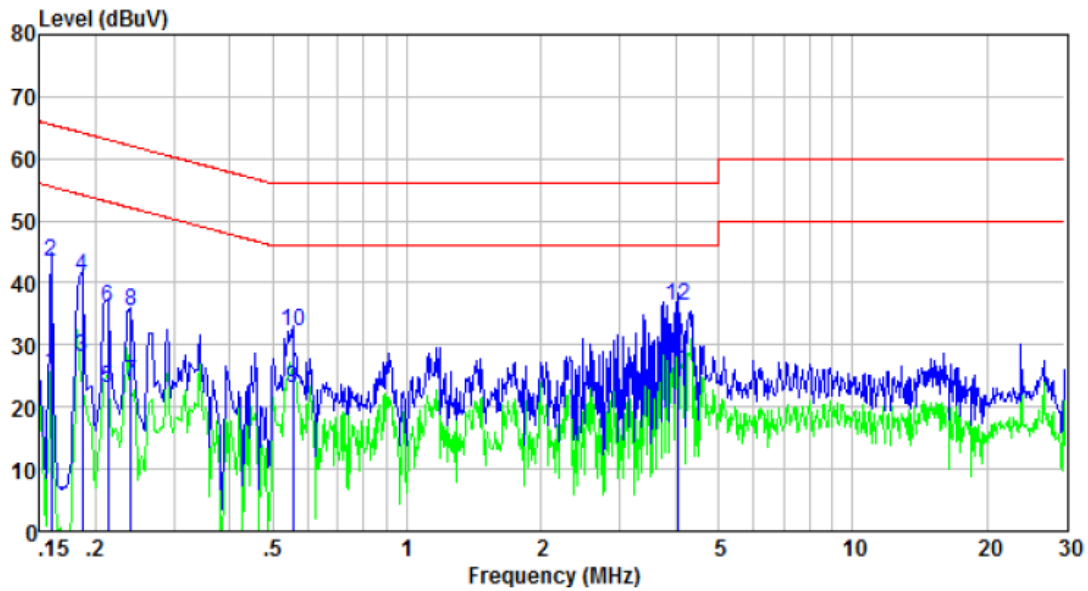

Freq MHz	Reading level dBuV	LISN/ISN factor dB	Cable loss dB	level dBuV	Limit level dBuV	Over limit dB	Remark
0.159	15.69	9.55	0.06	25.30	55.52	-30.22	Average
0.159	33.79	9.55	0.06	43.40	65.52	-22.12	QP
0.186	18.41	9.56	0.02	27.99	54.20	-26.21	Average
0.186	31.51	9.56	0.02	41.09	64.20	-23.11	QP
0.213	13.40	9.58	0.01	22.99	53.10	-30.11	Average
0.213	26.50	9.58	0.01	36.09	63.10	-27.01	QP
0.240	14.30	9.59	0.01	23.90	52.08	-28.18	Average
0.240	25.70	9.59	0.01	35.30	62.08	-26.78	QP
0.555	13.30	9.63	0.02	22.95	46.00	-23.05	Average
0.555	22.40	9.63	0.02	32.05	56.00	-23.95	QP
4.070	16.40	9.68	0.03	26.11	46.00	-19.89	Average
4.070	26.70	9.68	0.03	36.41	56.00	-19.59	QP

Notes:

1. An initial pre-scan was performed on the line and neutral lines with peak detector.
2. Quasi-Peak and Average measurement were performed at the frequencies with maximized peak emission.
3. Final Level = Receiver Read level + LISN Factor + Cable Loss

7.3 Conducted Peak Output Power

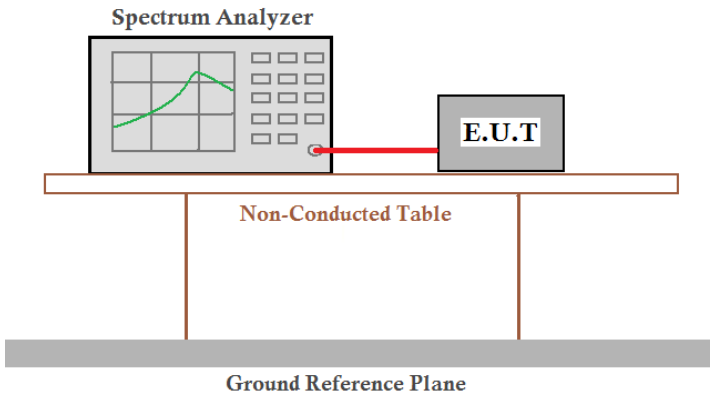
Test Requirement:	FCC Part15 C Section 15.247 (b)(3)
Test Method:	ANSI C63.10:2013
Limit:	20.97dBm
Test setup:	 <p>The diagram illustrates the test setup. A Spectrum Analyzer is connected to an E.U.T. (Equipment Under Test) via a red cable. Both are placed on a Non-Conducted Table, which is supported by a Ground Reference Plane.</p>
Test Instruments:	Refer to section 6.0 for details
Test mode:	Refer to section 5.2 for details
Test results:	Pass

Measurement Data

Mode	Test channel	Peak Output Power (dBm)	Limit (dBm)	Result
GFSK	Lowest	-5.278	20.97	Pass
	Middle	-4.209		
	Highest	-3.639		

Test plot as follows:

Test mode:	GFSK mode
------------	-----------

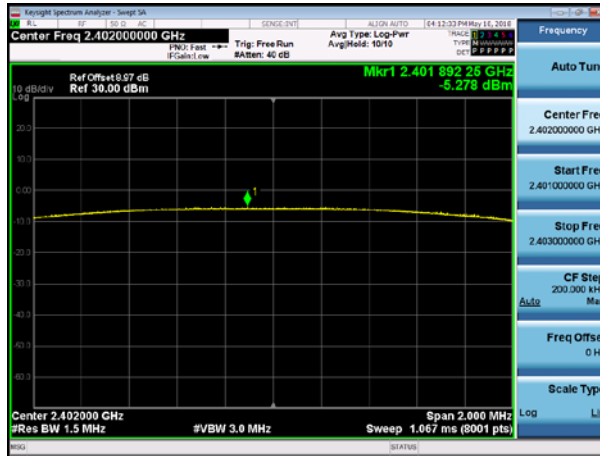

Lowest channel

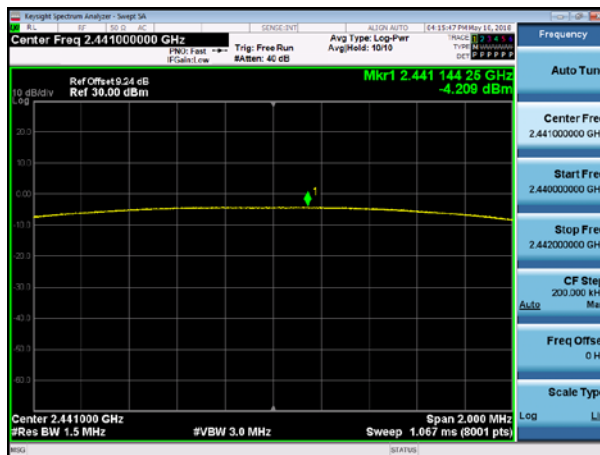

Middle channel

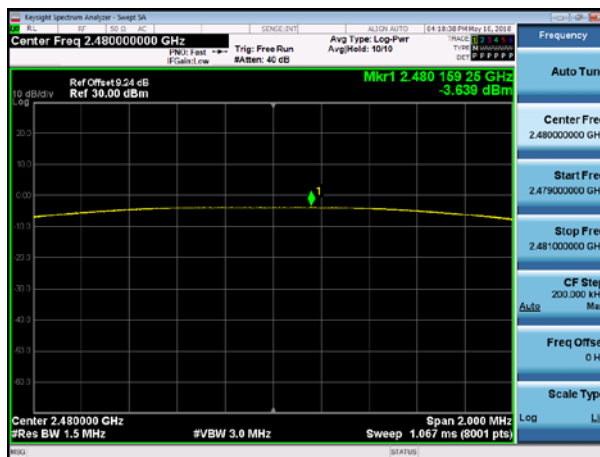

Highest channel

7.4 20dB Emission Bandwidth

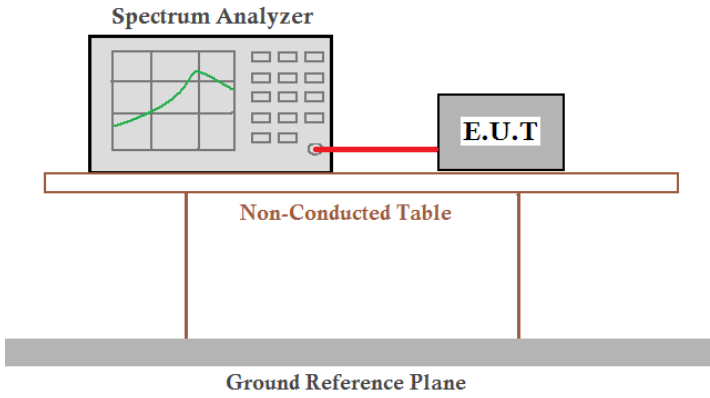
Test Requirement:	FCC Part15 C Section 15.247 (a)(2)
Test Method:	ANSI C63.10:2013
Limit:	N/A
Test setup:	 <p>The diagram illustrates the test setup. A Spectrum Analyzer is connected to an E.U.T. (Equipment Under Test) via a red cable. Both are placed on a Non-Conducted Table, which is supported by two legs. Below the table is a Ground Reference Plane.</p>
Test Instruments:	Refer to section 6.0 for details
Test mode:	Refer to section 5.2 for details
Test results:	Pass

Measurement Data

Mode	Test channel	20dB Emission Bandwidth (MHz)	Result
GFSK	Lowest	1.134	Pass
	Middle	1.141	
	Highest	1.136	

Test plot as follows:

Test mode:	GFSK mode
------------	-----------

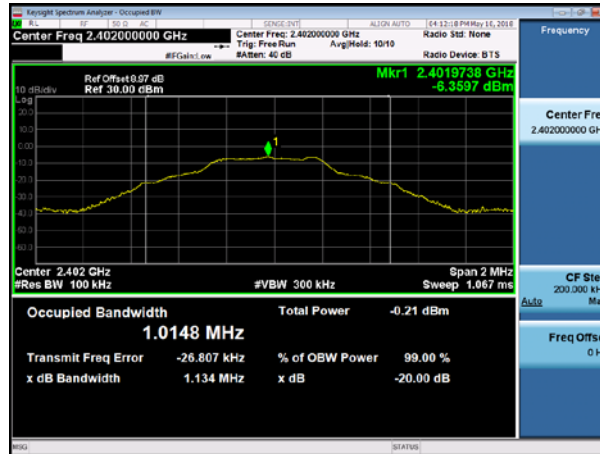

Lowest channel

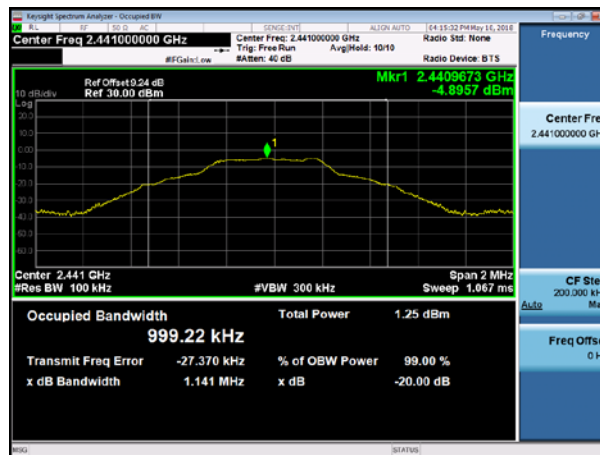

Middle channel



Highest channel

7.5 Carrier Frequencies Separation

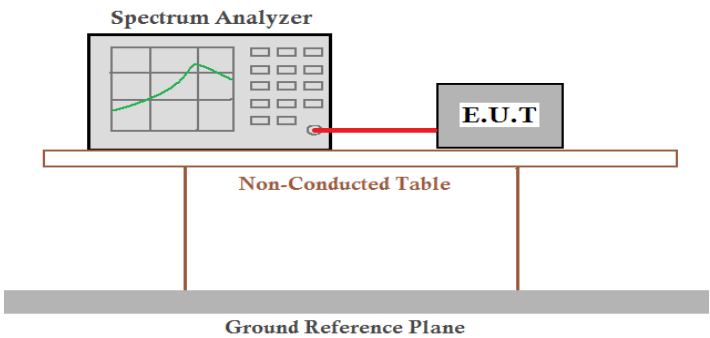
Test Requirement:	FCC Part15 C Section 15.247 (a)(1)
Test Method:	ANSI C63.10:2013
Receiver setup:	RBW=100KHz, VBW=300KHz, detector=Peak
Limit:	0.025MHz or 2/3 of the 20dB bandwidth (whichever is greater)
Test setup:	 <p>The diagram shows a Spectrum Analyzer on the left and an E.U.T. on the right, connected by a red cable. They are both on a table labeled 'Non-Conducted Table'. Below the table is a 'Ground Reference Plane'.</p>
Test Instruments:	Refer to section 6.0 for details
Test mode:	Refer to section 5.2 for details
Test results:	Pass

Measurement Data

Mode	Test channel	Carrier Frequencies Separation (kHz)	Limit (kHz)	Result
GFSK	Lowest	1009	756	Pass
	Middle	960	756	Pass
	Highest	1003	756	Pass

Note: According to section 7.4

Mode	20dB bandwidth (kHz) (worse case)	Limit (kHz) (Carrier Frequencies Separation)
GFSK	1134	756

Test plot as follows:

Modulation mode:	GFSK
------------------	------



Lowest channel



Middle channel



Highest channel

7.6 Hopping Channel Number

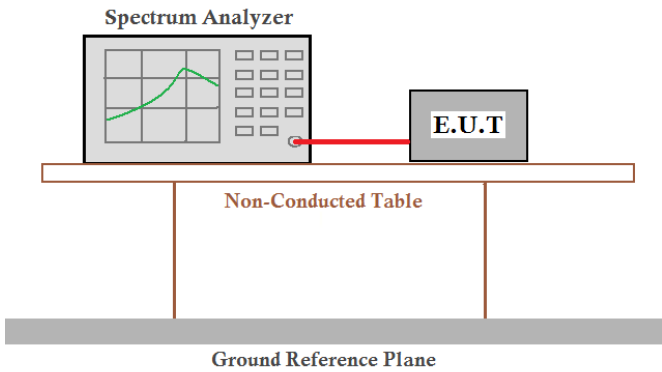
Test Requirement:	FCC Part15 C Section 15.247 (a)(1)
Test Method:	ANSI C63.10:2013
Receiver setup:	RBW=100kHz, VBW=300kHz, Frequency range=2400MHz-2483.5MHz, Detector=Peak
Limit:	15 channels
Test setup:	 <p>The diagram illustrates the test setup. A Spectrum Analyzer is connected via a red cable to an E.U.T. (Equipment Under Test). Both are placed on a Non-Conducted Table. The table is supported by a Ground Reference Plane.</p>
Test Instruments:	Refer to section 6.0 for details
Test mode:	Refer to section 5.2 for details
Test results:	Pass

Measurement Data:

Mode	Hopping channel numbers	Limit	Result
GFSK	79	15	Pass

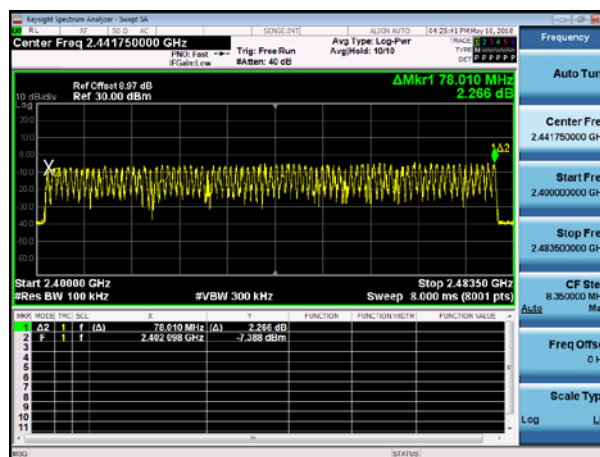

7.7 Dwell Time

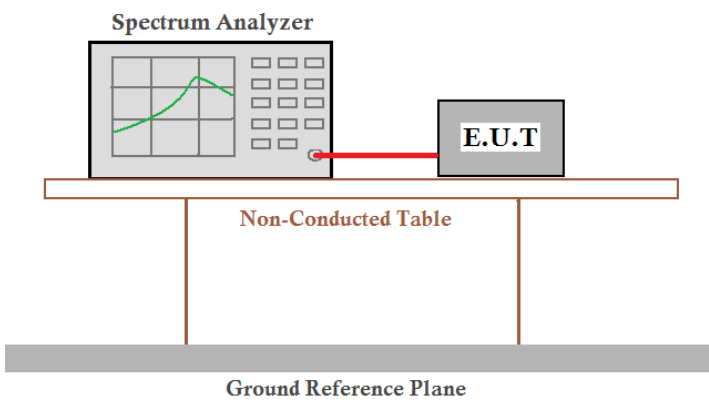
Test Requirement:	FCC Part15 C Section 15.247 (a)(1)
Test Method:	ANSI C63.10:2013
Receiver setup:	RBW=1MHz, VBW=1MHz, Span=0Hz, Detector=Peak
Limit:	0.4 Second
Test setup:	
Test Instruments:	Refer to section 6.0 for details
Test mode:	Refer to section 5.2 for details
Test results:	Pass

Measurement Data

Frequency	Packet	Dwell time(ms)	Limit(ms)	Result
2441MHz	DH1	136.00	400	Pass
2441MHz	DH3	267.20	400	Pass
2441MHz	DH5	310.40	400	Pass

The test period: $T = 0.4 \text{ Second/Channel} \times 79 \text{ Channel} = 31.6 \text{ s}$

Test channel: 2441MHz as below

DH1 time slot = $0.425(\text{ms}) \times (1600 / (2 \times 79)) \times 31.6 = 136.00\text{ms}$

DH3 time slot = $1.670(\text{ms}) \times (1600 / (4 \times 79)) \times 31.6 = 267.20\text{ms}$

DH5 time slot = $2.910(\text{ms}) \times (1600 / (6 \times 79)) \times 31.6 = 310.40\text{ms}$

Test plot as follows:

Test channel: 2441MHz

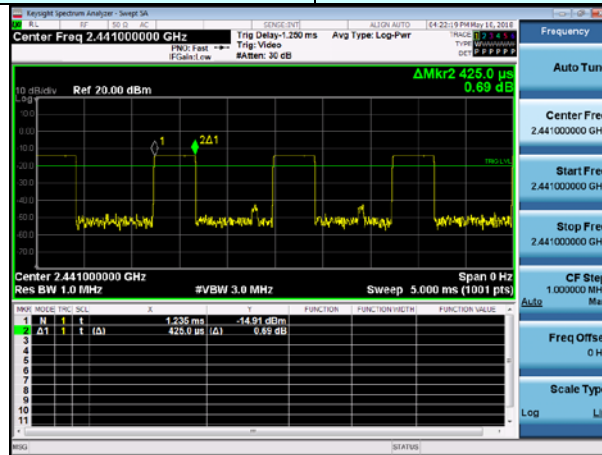

DH1

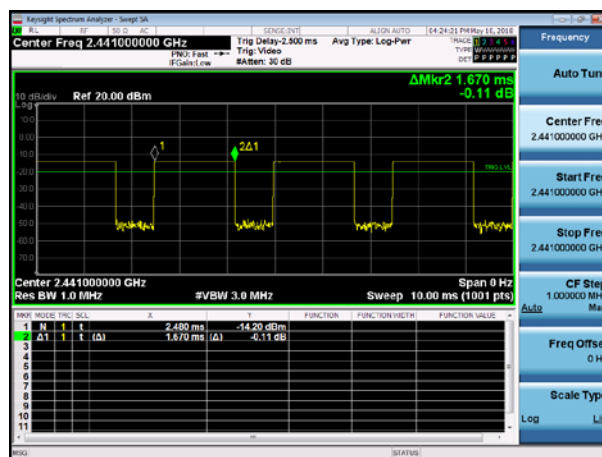

DH3

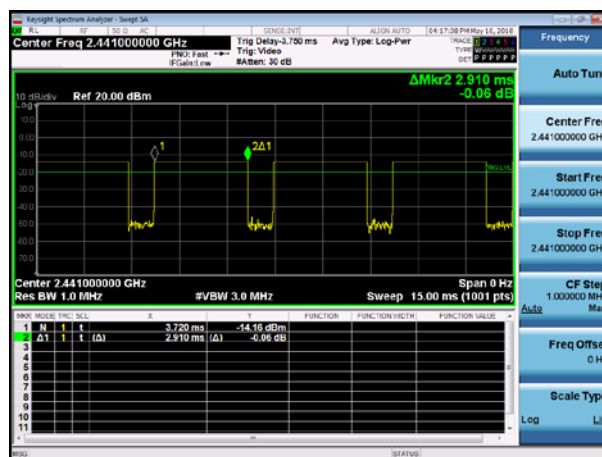

DH5

7.8 Pseudorandom Frequency Hopping Sequence

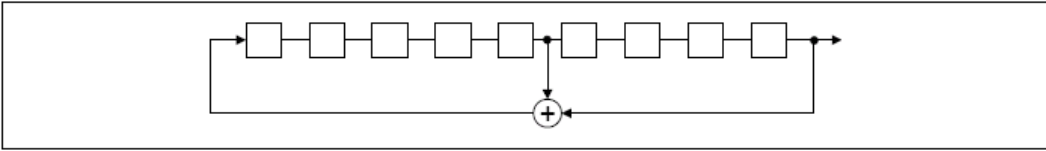
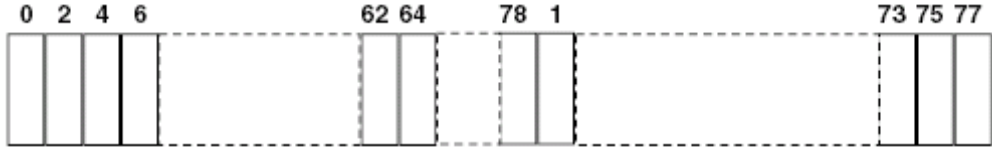
Test Requirement:	FCC Part15 C Section 15.247 (a)(1) requirement:
<p><i>Frequency hopping systems shall have hopping channel carrier frequencies separated by a minimum of 25 kHz or the 20 dB bandwidth of the hopping channel, whichever is greater.</i></p> <p><i>Alternatively. Frequency hopping systems operating in the 2400-2483.5 MHz band may have hopping channel carrier frequencies that are separated by 25 kHz or two-thirds of the 20 dB bandwidth of the hopping channel, whichever is greater, provided the systems operate with an output power no greater than 125 mW. The system shall hop to channel frequencies that are selected at the system hopping rate from a Pseudorandom ordered list of hopping frequencies. Each frequency must be used equally on the average by each transmitter. The system receivers shall have input bandwidths that match the hopping channel bandwidths of their corresponding transmitters and shall shift frequencies in synchronization with the transmitted signals.</i></p>	
EUT Pseudorandom Frequency Hopping Sequence	
<p><i>The pseudorandom sequence may be generated in a nine-stage shift register whose 5th and 9th stage outputs are added in a modulo-two addition stage. And the result is fed back to the input of the first stage. The sequence begins with the first ONE of 9 consecutive ONES; i.e. the shift register is initialized with nine ones.</i></p> <ul style="list-style-type: none"> • Number of shift register stages: 9 • Length of pseudo-random sequence: $2^9 - 1 = 511$ bits • Longest sequence of zeros: 8 (non-inverted signal) 	
	
<p><i>Linear Feedback Shift Register for Generation of the PRBS sequence</i></p>	
<p><i>An example of Pseudorandom Frequency Hopping Sequence as follow:</i></p>	
	
<p><i>Each frequency used equally on the average by each transmitter.</i></p> <p><i>The system receivers have input bandwidths that match the hopping channel bandwidths of their corresponding transmitters and shift frequencies in synchronization with the transmitted signals.</i></p>	

7.9 Band Edge

7.9.1 Conducted Emission Method

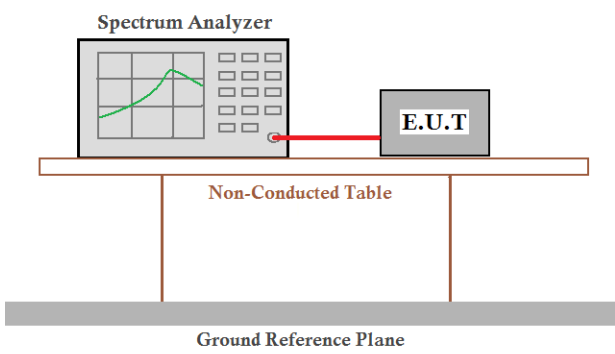
Test Requirement:	FCC Part15 C Section 15.247 (d)
Test Method:	ANSI C63.10:2013
Receiver setup:	RBW=100kHz, VBW=300kHz, Detector=Peak
Limit:	In any 100 kHz bandwidth outside the frequency band in which the spread spectrum intentional radiator is operating, the radio frequency power that is produced by the intentional radiator shall be at least 20 dB below that in the 100 kHz bandwidth within the band that contains the highest level of the desired power, based on either an RF conducted or a radiated measurement.
Test setup:	 <p>The diagram illustrates the test setup. A Spectrum Analyzer is connected to an E.U.T. (Equipment Under Test) via a red cable. Both are placed on a Non-Conducted Table, which is supported by two legs. Below the table is a Ground Reference Plane.</p>
Test Instruments:	Refer to section 6.0 for details
Test mode:	Refer to section 5.2 for details
Test results:	Pass

Test plot as follows:

GFSK Mode:

Test channel: Lowest channel

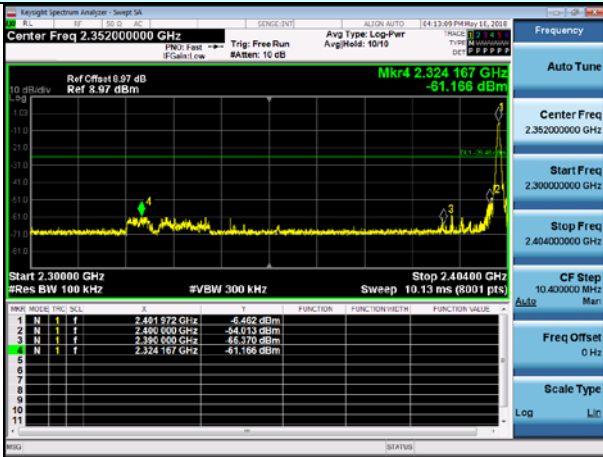

No-hopping mode

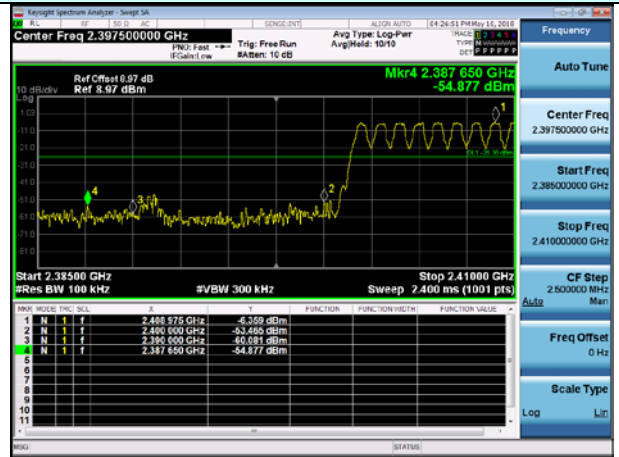

Hopping mode

Test channel: Highest channel



No-hopping mode

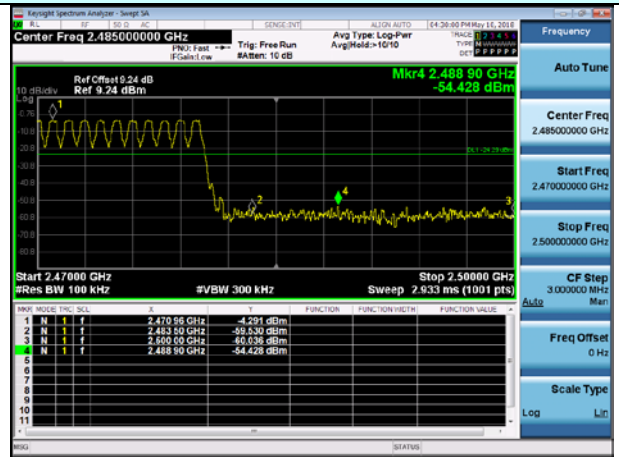

Hopping mode

7.9.2 Radiated Emission Method

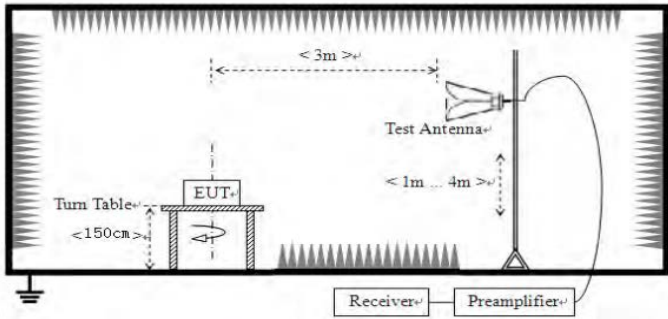
Test Requirement:	FCC Part15 C Section 15.209 and 15.205				
Test Method:	ANSI C63.10:2013				
Test Frequency Range:	All restriction band have been tested, and 2.3GHz to 2.5GHz band is the worse case				
Test site:	Measurement Distance: 3m				
Receiver setup:	Frequency	Detector	RBW	VBW	Remark
	Above 1GHz	Peak	1MHz	3MHz	Peak Value
		Peak	1MHz	10Hz	Average Value
Limit:	Frequency		Limit (dBuV/m @3m)		Remark
	Above 1GHz		54.00		Average Value
			74.00		Peak Value
Test setup:					
Test Procedure:	<ol style="list-style-type: none"> 1. The EUT was placed on the top of a rotating table 1.5 meters above the ground at a 3 meter camber. The table was rotated 360 degrees to determine the position of the highest radiation. 2. The EUT was set 3 meters away from the interference-receiving antenna, which was mounted on the top of a variable-height antenna tower. 3. The antenna height is varied from one meter to four meters above the ground to determine the maximum value of the field strength. Both horizontal and vertical polarizations of the antenna are set to make the measurement. 4. For each suspected emission, the EUT was arranged to its worst case and then the antenna was tuned to heights from 1 meter to 4 meters and the rota table was turned from 0 degrees to 360 degrees to find the maximum reading. 5. The test-receiver system was set to Peak Detect Function and Specified Bandwidth with Maximum Hold Mode. 6. If the emission level of the EUT in peak mode was 10dB lower than the limit specified, then testing could be stopped and the peak values of the EUT would be reported. Otherwise the emissions that did not have 10dB margin would be re-tested one by one using peak, quasi-peak or average method as specified and then reported in a data sheet. 				
Test Instruments:	Refer to section 6.0 for details				
Test mode:	Refer to section 5.2 for details				
Test results:	Pass				

Remark:

Test channel:	Lowest
---------------	--------

Peak value:

Frequency (MHz)	Read Level (dBuV)	Antenna Factor (dB/m)	Cable Loss (dB)	Preamp Factor (dB)	Level (dBuV/m)	Limit Line (dBuV/m)	Over Limit (dB)	Polarization
2390.00	41.99	27.11	3.64	36.08	36.66	74.00	-37.34	Horizontal
2400.00	44.85	27.14	3.65	36.11	39.53	74.00	-34.47	Horizontal
2390.00	41.76	27.11	3.64	36.08	36.43	74.00	-37.57	Vertical
2400.00	42.16	27.14	3.65	36.11	36.84	74.00	-37.16	Vertical

Average value:

Frequency (MHz)	Read Level (dBuV)	Antenna Factor (dB/m)	Cable Loss (dB)	Preamp Factor (dB)	Level (dBuV/m)	Limit Line (dBuV/m)	Over Limit (dB)	Polarization
2390.00	32.38	27.11	3.64	36.08	24.96	54.00	-29.04	Horizontal
2400.00	43.54	27.14	3.65	36.11	25.70	54.00	-28.30	Horizontal
2390.00	32.23	27.11	3.64	36.08	23.32	54.00	-30.68	Vertical
2400.00	45.06	27.14	3.65	36.11	24.38	54.00	-29.62	Vertical

Test channel:	Highest
---------------	---------

Peak value:

Frequency (MHz)	Read Level (dBuV)	Antenna Factor (dB/m)	Cable Loss (dB)	Preamp Factor (dB)	Level (dBuV/m)	Limit Line (dBuV/m)	Over Limit (dB)	Polarization
2483.50	43.55	27.36	3.68	36.33	38.26	74.00	-35.74	Horizontal
2500.00	45.06	27.40	3.68	36.37	39.77	74.00	-34.23	Horizontal
2483.50	45.02	27.36	3.68	36.33	39.73	74.00	-34.27	Vertical
2500.00	43.07	27.40	3.68	36.37	37.78	74.00	-36.22	Vertical

Average value:

Frequency (MHz)	Read Level (dBuV)	Antenna Factor (dB/m)	Cable Loss (dB)	Preamp Factor (dB)	Level (dBuV/m)	Limit Line (dBuV/m)	Over Limit (dB)	Polarization
2483.50	29.68	27.36	3.68	36.33	24.39	54.00	-29.61	Horizontal
2500.00	30.12	27.40	3.68	36.37	24.83	54.00	-29.17	Horizontal
2483.50	31.09	27.36	3.68	36.33	25.8	54.00	-28.20	Vertical
2500.00	30.85	27.40	3.68	36.37	25.56	54.00	-28.44	Vertical

Remark:

1. Final Level = Receiver Read level + Antenna Factor + Cable Loss – Preamplifier Factor
2. The emission levels of other frequencies are very lower than the limit and not show in test report.

7.10 Spurious Emission

7.10.1 Conducted Emission Method

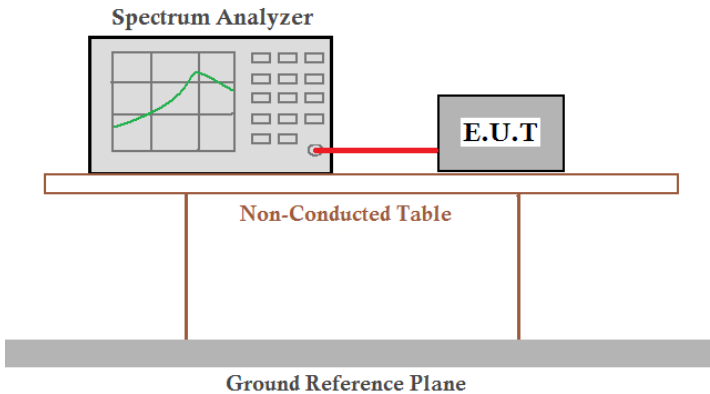
Test Requirement:	FCC Part15 C Section 15.247 (d)
Test Method:	ANSI C63.10:2013
Limit:	In any 100 kHz bandwidth outside the frequency band in which the spread spectrum intentional radiator is operating, the radio frequency power that is produced by the intentional radiator shall be at least 20 dB below that in the 100 kHz bandwidth within the band that contains the highest level of the desired power, based on either an RF conducted or a radiated measurement.
Test setup:	 <p>The diagram illustrates the test setup. A Spectrum Analyzer is connected to an E.U.T. (Equipment Under Test) via a red cable. Both are placed on a Non-Conducted Table, which is supported by two legs. Below the table is a Ground Reference Plane.</p>
Test Instruments:	Refer to section 6.0 for details
Test mode:	Refer to section 5.2 for details
Test results:	Pass

Test channel: Lowest channel

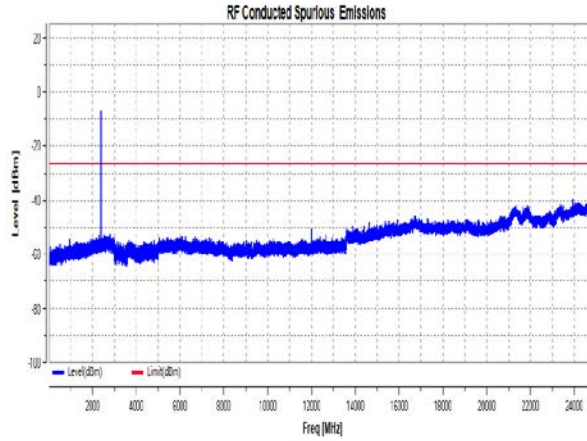

30MHz~25GHz

Test channel: Middle channel

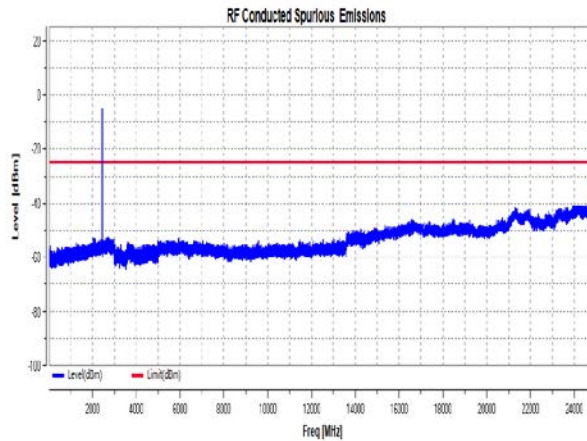

30MHz~25GHz

Test channel: Highest channel

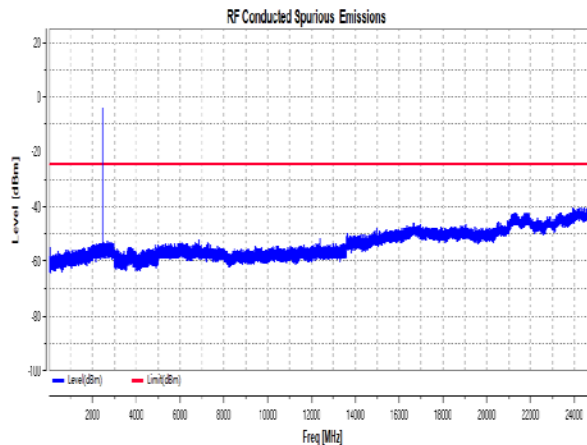

30MHz~25GHz

7.10.2 Radiated Emission Method

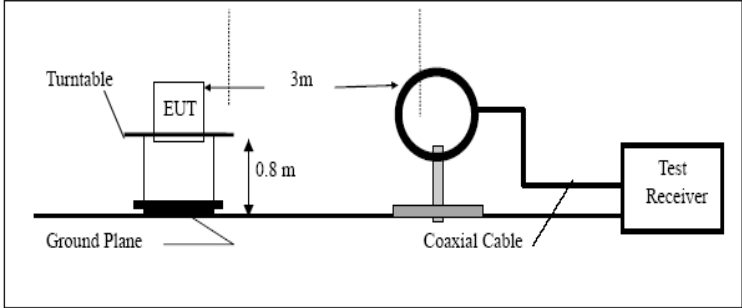
Test Requirement:	FCC Part15 C Section 15.209				
Test Method:	ANSI C63.10:2013				
Test Frequency Range:	9kHz to 25GHz				
Test site:	Measurement Distance: 3m				
Receiver setup:	Frequency	Detector	RBW	VBW	Value
	9KHz-150KHz	Quasi-peak	200Hz	600Hz	Quasi-peak
	150KHz-30MHz	Quasi-peak	9KHz	30KHz	Quasi-peak
	30MHz-1GHz	Quasi-peak	100KHz	300KHz	Quasi-peak
	Above 1GHz	Peak	1MHz	3MHz	Peak
Peak		1MHz	10Hz	Average	
Limit: (Spurious Emissions)	Frequency	Limit (uV/m)	Value	Measurement Distance	
	0.009MHz-0.490MHz	2400/F(KHz)	QP	300m	
	0.490MHz-1.705MHz	24000/F(KHz)	QP	300m	
	1.705MHz-30MHz	30	QP	30m	
	30MHz-88MHz	100	QP	3m	
	88MHz-216MHz	150	QP		
	216MHz-960MHz	200	QP		
	960MHz-1GHz	500	QP		
	Above 1GHz	500	Average		
		5000	Peak		
Test setup:	Below 30MHz				
					
Below 1GHz					

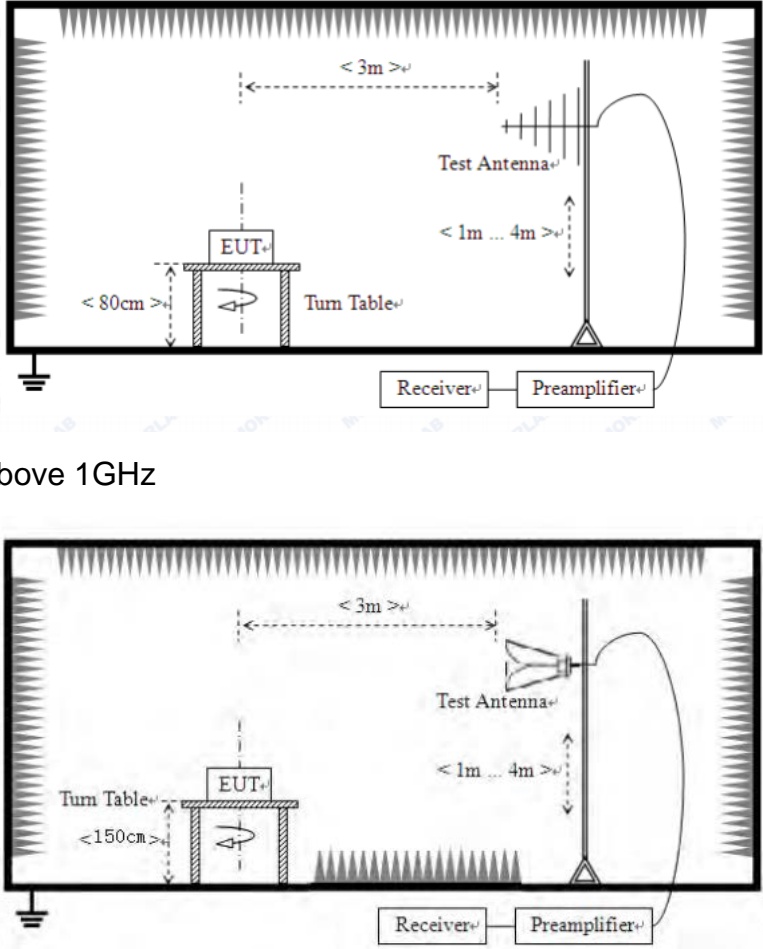
	 <p>Above 1GHz</p>
<p>Test Procedure:</p>	<ol style="list-style-type: none"> 1. The EUT was placed on the top of a rotating table(0.8 meters below 1G and 1.5 meters above 1G) above the ground at a 3 meter camber. The table was rotated 360 degrees to determine the position of the highest radiation. 2. The EUT was set 3 meters away from the interference-receiving antenna, which was mounted on the top of a variable-height antenna tower. 3. The antenna height is varied from one meter to four meters above the ground to determine the maximum value of the field strength. Both horizontal and vertical polarizations of the antenna are set to make the measurement. 4. For each suspected emission, the EUT was arranged to its worst case and then the antenna was tuned to heights from 1 meter to 4 meters and the rota table was turned from 0 degrees to 360 degrees to find the maximum reading. 5. The test-receiver system was set to Peak Detect Function

	and Specified Bandwidth with Maximum Hold Mode. 6. If the emission level of the EUT in peak mode was 10dB lower than the limit specified, then testing could be stopped and the peak values of the EUT would be reported. Otherwise the emissions that did not have 10dB margin would be re-tested one by one using peak, quasi-peak or average method as specified and then reported in a data sheet.
Test Instruments:	Refer to section 6.0 for details
Test mode:	Refer to section 5.2 for details
Test results:	Pass

Remark:

Measurement data:

■ **9 kHz ~ 30 MHz**

The low frequency, which started from 9 kHz to 30 MHz, was pre-scanned and the result which was 20 dB lower than the limit line per 15.31(o) was not reported.

■ Below 1GHz

Horizontal:

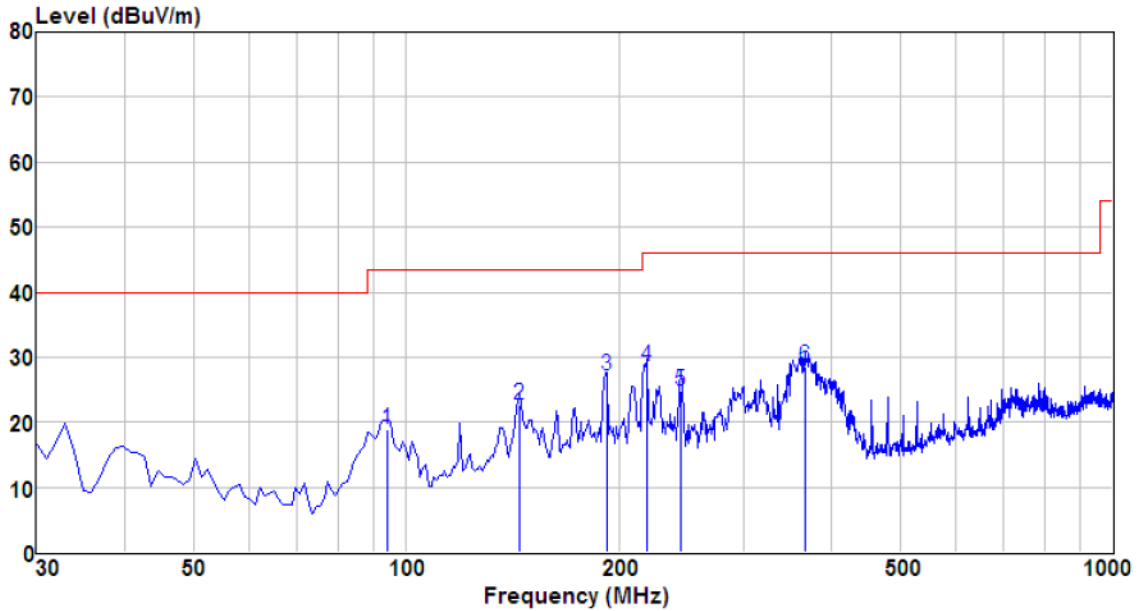

Freq MHz	Reading level dBuV	Antenna factor dB/m	Cable loss dB	Preamp factor dB	level dBuV	Limit level dBuV/m	Over limit dB	Remark
94.020	39.67	9.78	1.90	32.45	18.90	43.50	-24.60	QP
144.460	38.92	13.81	2.37	32.50	22.60	43.50	-20.90	QP
191.990	46.48	10.38	2.78	32.54	27.10	43.50	-16.40	QP
219.150	47.75	10.47	2.92	32.54	28.60	46.00	-17.40	QP
244.370	43.07	11.23	3.14	32.54	24.90	46.00	-21.10	QP
367.560	43.02	14.18	3.88	32.48	28.60	46.00	-17.40	QP

Vertical:

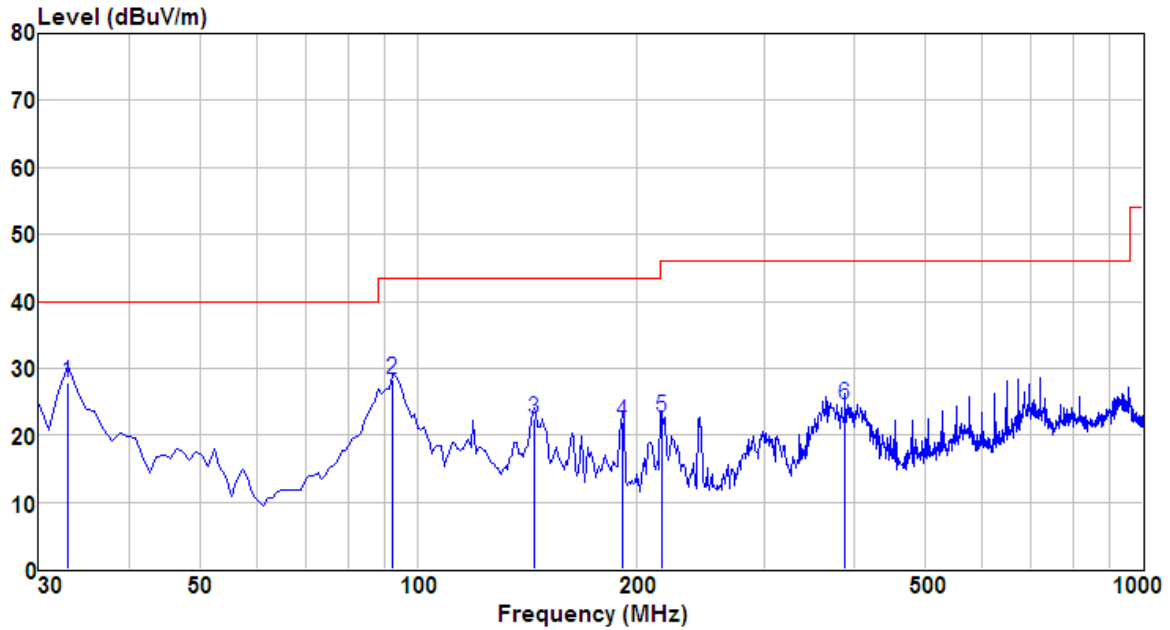

Freq MHz	Reading level dBuV	Antenna factor dB/m	Cable loss dB	Preamp factor dB	level dBuV	Limit level dBuV/m	Over limit dB	Remark
32.910	45.97	13.32	1.04	32.53	27.80	40.00	-12.20	QP
92.080	49.23	9.65	1.88	32.46	28.30	43.50	-15.20	QP
144.460	38.82	13.81	2.37	32.50	22.50	43.50	-21.00	QP
191.020	41.23	10.44	2.77	32.54	21.90	43.50	-21.60	QP
217.210	41.91	10.42	2.91	32.54	22.70	46.00	-23.30	QP
387.930	38.57	14.57	3.94	32.48	24.60	46.00	-21.40	QP

■ Above 1GHz

Test channel:	Lowest
---------------	--------

Peak value:

Frequency (MHz)	Read Level (dBuV)	Antenna Factor (dB/m)	Cable Loss (dB)	Preamp Factor (dB)	Level (dBuV/m)	Limit Line (dBuV/m)	Over Limit (dB)	Polarization
4804.00	44.30	31.23	5.45	36.27	44.71	74.00	-29.29	Vertical
7206.00	44.21	35.87	6.94	34.25	52.67	74.00	-21.33	Vertical
9608.00	43.20	37.79	7.77	34.13	54.63	74.00	-19.37	Vertical
12010.00	*					74.00		Vertical
14412.00	*					74.00		Vertical
4804.00	41.58	31.23	5.45	36.27	41.99	74.00	-32.01	Horizontal
7206.00	38.95	35.87	6.94	34.25	47.41	74.00	-26.59	Horizontal
9608.00	39.64	37.79	7.77	34.13	51.07	74.00	-22.93	Horizontal
12010.00	*					74.00		Horizontal
14412.00	*					74.00		Horizontal

Average value:

Frequency (MHz)	Read Level (dBuV)	Antenna Factor (dB/m)	Cable Loss (dB)	Preamp Factor (dB)	Level (dBuV/m)	Limit Line (dBuV/m)	Over Limit (dB)	Polarization
4804.00	29.33	31.23	5.45	36.27	34.81	54.00	-19.19	Vertical
7206.00	29.91	35.87	6.94	34.25	36.59	54.00	-17.41	Vertical
9608.00	29.53	37.79	7.77	34.13	40.31	54.00	-13.69	Vertical
12010.00	*					54.00		Vertical
14412.00	*					54.00		Vertical
4804.00	30.11	31.23	5.45	36.27	39.09	54.00	-23.48	Horizontal
7206.00	27.63	35.87	6.94	34.25	38.79	54.00	-17.91	Horizontal
9608.00	27.43	37.79	7.77	34.13	40.08	54.00	-15.14	Horizontal
12010.00	*					54.00		Horizontal
14412.00	*					54.00		Horizontal

Remark:

1. Final Level = Receiver Read level + Antenna Factor + Cable Loss – Pre-amplifier Factor
2. “*”, means this data is the too weak instrument of signal is unable to test.
3. The emission levels of other frequencies are very lower than the limit and not show in test report.

Test channel:	Middle
---------------	--------

Peak value:

Frequency (MHz)	Read Level (dBuV)	Antenna Factor (dB/m)	Cable Loss (dB)	Preamplifier Factor (dB)	Level (dBuV/m)	Limit Line (dBuV/m)	Over Limit (dB)	Polarization
4882.00	40.11	31.41	5.41	36.24	40.69	74.00	-33.31	Vertical
7323.00	41.26	36.14	7.28	34.36	50.32	74.00	-23.68	Vertical
9764.00	40.13	38.08	7.98	34.20	51.99	74.00	-22.01	Vertical
12205.00	*					74.00		Vertical
14646.00	*					74.00		Vertical
4882.00	43.68	31.41	5.41	36.24	44.26	74.00	-29.74	Horizontal
7323.00	39.50	36.14	7.28	34.36	48.56	74.00	-25.44	Horizontal
9764.00	39.10	38.08	7.98	34.20	50.96	74.00	-23.04	Horizontal
12205.00	*					74.00		Horizontal
14646.00	*					74.00		Horizontal

Average value:

Frequency (MHz)	Read Level (dBuV)	Antenna Factor (dB/m)	Cable Loss (dB)	Preamplifier Factor (dB)	Level (dBuV/m)	Limit Line (dBuV/m)	Over Limit (dB)	Polarization
4882.00	29.36	31.41	5.41	36.24	29.94	54.00	-24.06	Vertical
7323.00	28.90	36.14	7.28	34.36	37.96	54.00	-16.04	Vertical
9764.00	26.77	38.08	7.98	34.20	38.63	54.00	-15.37	Vertical
12205.00	*					54.00		Vertical
14646.00	*					54.00		Vertical
4882.00	32.35	31.41	5.41	36.24	32.93	54.00	-21.07	Horizontal
7323.00	28.35	36.14	7.28	34.36	37.41	54.00	-16.59	Horizontal
9764.00	26.86	38.08	7.98	34.20	38.72	54.00	-15.28	Horizontal
12205.00	*					54.00		Horizontal
14646.00	*					54.00		Horizontal

Remark:

1. *Final Level = Receiver Read level + Antenna Factor + Cable Loss – Preamplifier Factor*
2. *“*” , means this data is the too weak instrument of signal is unable to test.*
3. *The emission levels of other frequencies are very lower than the limit and not show in test report.*

Test channel:	Highest
---------------	---------

Peak value:

Frequency (MHz)	Read Level (dBuV)	Antenna Factor (dB/m)	Cable Loss (dB)	Preamplifier Factor (dB)	Level (dBuV/m)	Limit Line (dBuV/m)	Over Limit (dB)	Polarization
4960.00	41.54	31.60	5.36	36.21	42.29	74.00	-31.71	Vertical
7440.00	47.38	36.41	7.44	34.47	56.76	74.00	-17.24	Vertical
9920.00	39.31	38.36	8.05	34.27	51.45	74.00	-22.55	Vertical
12400.00	*					74.00		Vertical
14880.00	*					74.00		Vertical
4960.00	41.98	31.60	5.36	36.21	42.73	74.00	-31.27	Horizontal
7440.00	43.22	36.41	7.44	34.47	52.60	74.00	-21.40	Horizontal
9920.00	39.90	38.36	8.05	34.27	52.04	74.00	-21.96	Horizontal
12400.00	*					74.00		Horizontal
14880.00	*					74.00		Horizontal

Average value:

Frequency (MHz)	Read Level (dBuV)	Antenna Factor (dB/m)	Cable Loss (dB)	Preamplifier Factor (dB)	Level (dBuV/m)	Limit Line (dBuV/m)	Over Limit (dB)	Polarization
4960.00	29.73	31.60	5.36	36.21	30.48	54.00	-23.52	Vertical
7440.00	31.22	36.41	7.44	34.47	40.60	54.00	-13.40	Vertical
9920.00	26.72	38.36	8.05	34.27	38.86	54.00	-15.14	Vertical
12400.00	*					54.00		Vertical
14880.00	*					54.00		Vertical
4960.00	29.79	31.60	5.36	36.21	30.54	54.00	-23.46	Horizontal
7440.00	29.57	36.41	7.44	34.47	38.95	54.00	-15.05	Horizontal
9920.00	26.45	38.36	8.05	34.27	38.59	54.00	-15.41	Horizontal
12400.00	*					54.00		Horizontal
14880.00	*					54.00		Horizontal

Remark:

1. *Final Level = Receiver Read level + Antenna Factor + Cable Loss – Preamplifier Factor*
2. *“**”, means this data is the too weak instrument of signal is unable to test.*
3. *The emission levels of other frequencies are very lower than the limit and not show in test report.*

8 Test Setup Photo

Radiated Emission

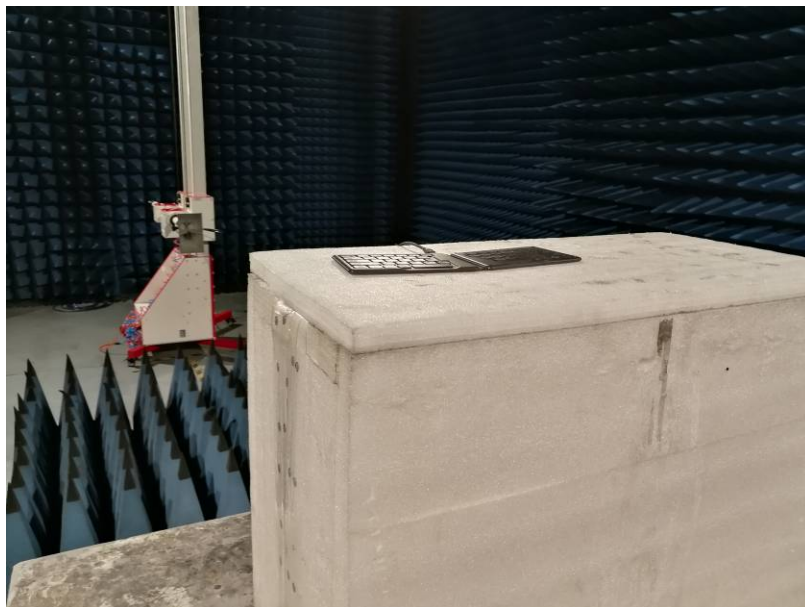
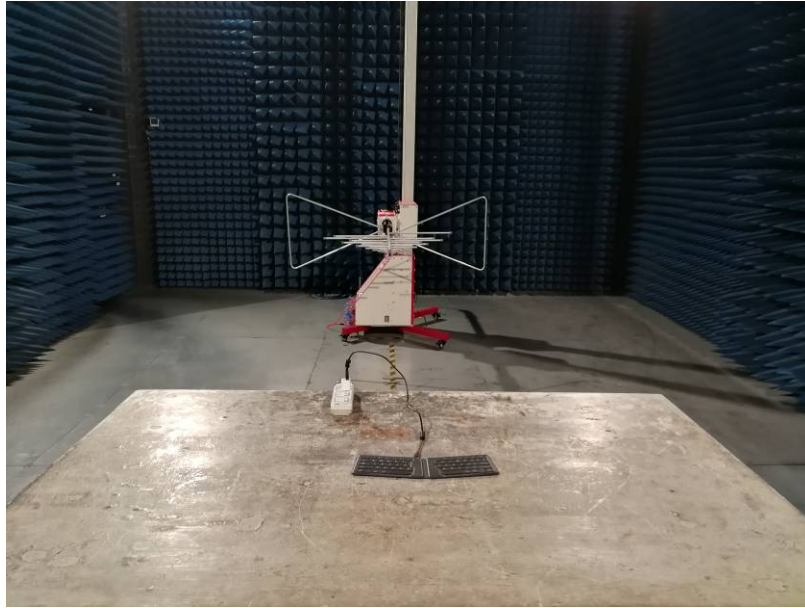

Conducted Emission



9 EUT Constructional Details

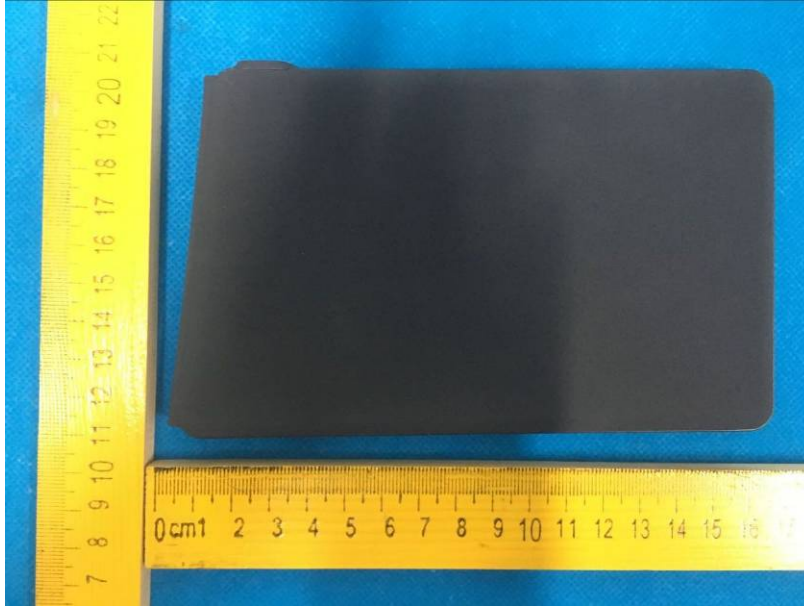



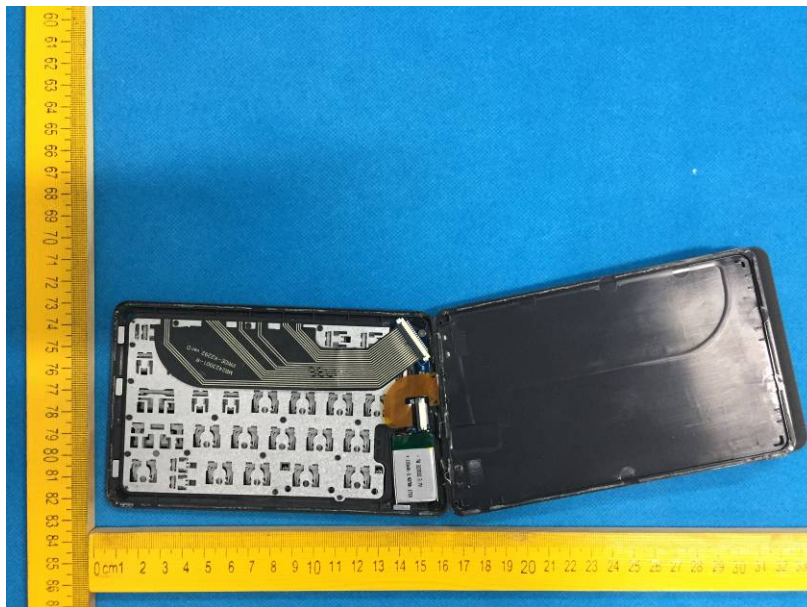

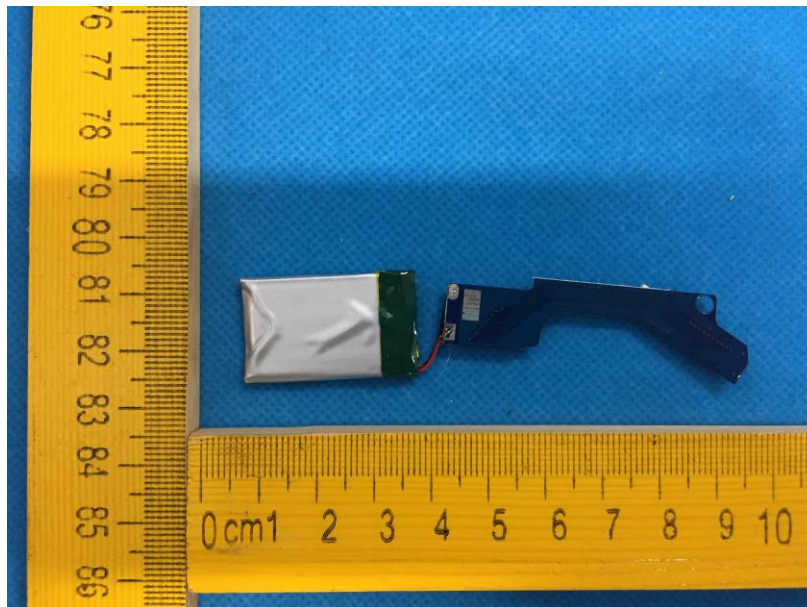
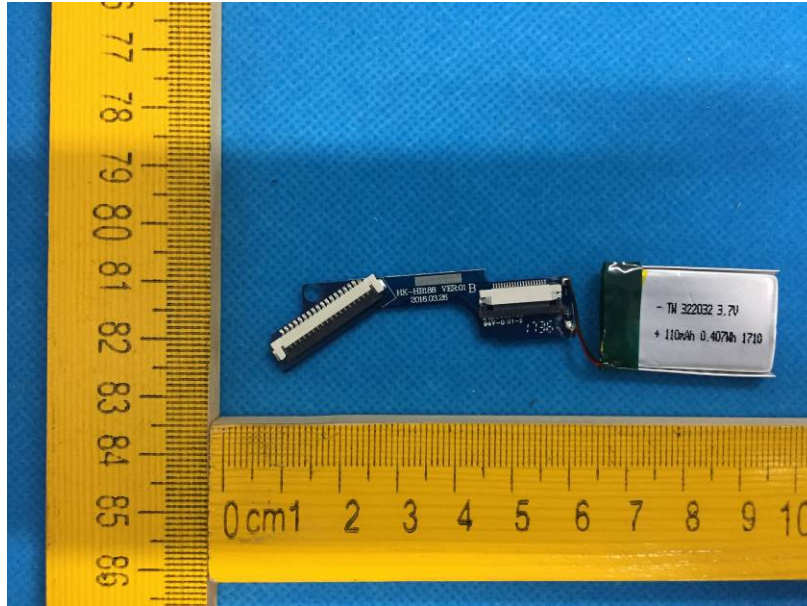

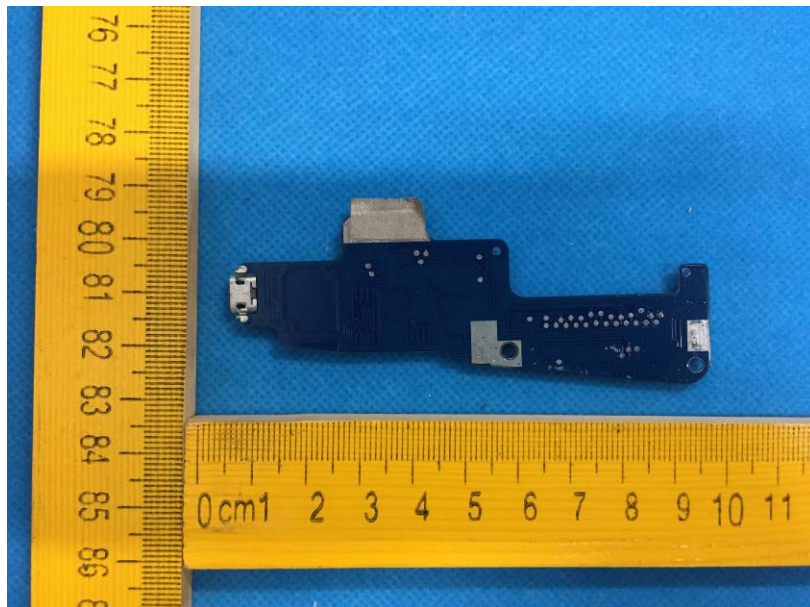
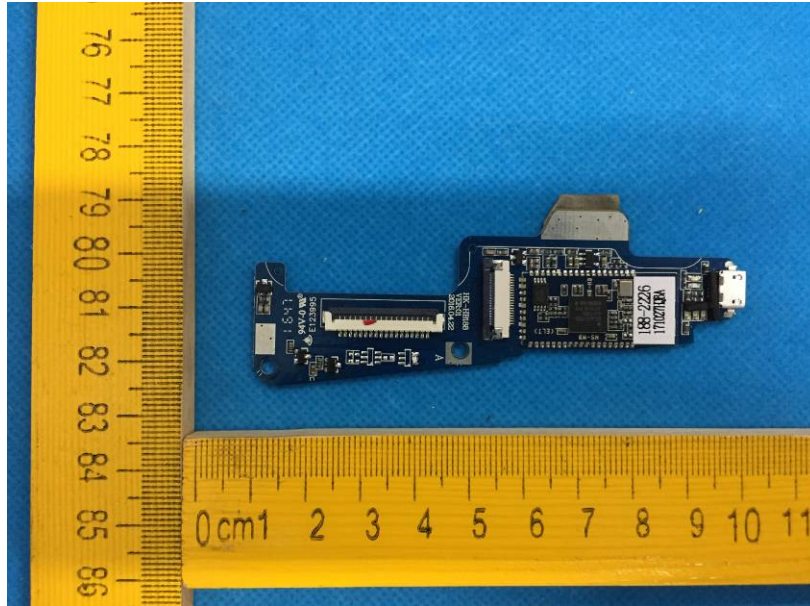

-----End-----