

FCC SAR Test Report (Class II Permissive Change)

Product Name : Intel® Wi-Fi 6 AX201
Model No. : AX201NGW

Applicant : TONGFANG HONGKONG (SUZHOU) LIMITED
Address : No.10 Plant, Jianwu Phase III, Western Zone, Suzhou Industrial Park,
215000 Suzhou City, Jiangsu Province, China

Date of Receipt : 2022/03/14
Issued Date : 2022/04/19
Report No. : 2230501R-SAUSSARV02-A
Report Version : V1.0



The test results relate only to the samples tested.
The test results shown in the test report are traceable to the national/international standard through the calibration report of the equipment and evaluated measurement uncertainty herein.
This report must not be used to claim product endorsement by TAF or any agency of the government.
The test report shall not be reproduced without the written approval of DEKRA Testing and Certification Co., Ltd.
Measurement uncertainties evaluated for each testing system and associated connections are given here to provide the system information for reference. Compliance determinations do not take into account measurement uncertainties for each testing system, but are based on the results of the compliance measurement.

TABLE OF CONTENTS

Description	Page
1. General Information.....	5
1.1 EUT Description	5
1.2 Antenna List	6
1.3 SAR Test Exclusion Calculation	7
1.3 Test Environment.....	8
2. SAR Measurement System	9
2.1 DASY5 System Description	9
2.1.1 Applications	10
2.1.2 Area Scans	10
2.1.3 Zoom Scan (Cube Scan Averaging)	10
2.1.4 Uncertainty of Inter-/Extrapolation and Averaging	10
2.2 DASY5 E-Field Probe	11
2.2.1 Isotropic E-Field Probe Specification	11
2.3 Boundary Detection Unit and Probe Mounting Device.....	12
2.4 DATA Acquisition Electronics (DAE) and Measurement Server	12
2.5 Robot.....	13
2.6 Light Beam Unit.....	13
2.7 Device Holder	14
2.8 SAM Twin Phantom	14
3. Tissue Simulating Liquid	15
3.1 The composition of the tissue simulating liquid.....	15
3.2 Tissue Calibration Result	15
3.3 Tissue Dielectric Parameters for Head and Body Phantoms	17
4. SAR Measurement Procedure	18
4.1 SAR System Check	18
4.1.1 Dipoles.....	18
4.1.2 System Check Result	18
4.2 SAR Measurement Procedure.....	20
5. SAR Exposure Limits	21
6. Test Equipment List.....	22
7. Measurement Uncertainty	25
8. Conducted Power Measurement (Including tolerance allowed for production unit).	27
9. Test Results.....	30
9.1 SAR Test Results Summary	30
9.2 Simultaneous Transmission.....	32
9.2.1 Simultaneous transmission of MIMO in 802.11 test exclusion considerations	32
9.2.2 simultaneous transmission of Wi-Fi and other wireless technologies	33
10. SAR measurement variability	34
Appendix	35
Appendix A. SAR System Check Data	
Appendix B. SAR measurement Data	
Appendix C. Test Setup Photographs	
Appendix D. Probe Calibration Data	
Appendix E. Dipole Calibration Data	
Appendix F. Product Photos- Please refer to the file: 2230501R-Product Photos	

Revision History

Report No.	Version	Description	Issued Date
2230501R-SAUSSARV02-A	V1.0	Initial issue of report.	2022/04/19

1. General Information

1.1 EUT Description

Product Name	Intel® Wi-Fi 6 AX201		
Trade Name	Intel		
Model No.	AX201NGW		
FCC ID	2AKHFAX201NG		
Frequency Range	802.11b/g/n/ax-20: 2412-2472MHz, 802.11n/ax-40: 2422-2462MHz 802.11a/n/ax-20: 5180-5320MHz, 5500-5700MHz, 5745-5825MHz 802.11n/ax-40: 5190-5310MHz, 5510-5670MHz, 5755-5795MHz 802.11ac/ax-20MHz: 5720MHz, 802.11ac/ax-40MHz: 5710MHz 802.11ac/ax-80MHz: 5210-5290MHz, 5530-5610MHz, 5775MHz 802.11ac/ax-160MHz: 5250MHz, 5570MHz BT: 2402-2480MHz		
Channel Separation	802.11b/g/n/ax-20: 5MHz 802.11a/n/ax-20: 20MHz, 802.11n/ax-40: 40MHz 802.11 ac/ax-80: 80MHz; 802.11ac/ax-160: 320MHz BT: 1MHz; BLE: 2MHz		
Type of Modulation	802.11b: DSSS 802.11a/g/n/ac/ax: OFDM, OFDMA GFSK(1Mbps) / π / 4DQPSK(2Mbps) / 8DPSK(3Mbps)		
Antenna Type	PIFA		
Device Category	Portable		
RF Exposure Environment	Uncontrolled		
Summary of test result –Reported 1g SAR (W/Kg)			
Test configuration	DTS	NII	DSS(BT)
Body-Standalone	1.139	1.083	0.059
Body-Simultaneous	DTS (Main + Aux)	NII (Main + Aux)	NII + DSS(BT)
	2.208 (SPLSR=0.04)	2.163 (SPLSR=0.039)	2.222 (SPLSR=0.04)

Note:

Host information				
Brand	Product Name	Model No.	GPU	Difference
TONGFANG	Notebook PC	PH6ARX1	N/A	All models are electrically identical and different model names are used to distinguish between different GPU specifications.
		PH6AQE1	GN20-P0 MaxQ	
		PH6AQF1	GN20-P1 MaxQ	
		PH6AG01	GN20-E3	
		PH6AQ71	GN20-E6 MaxQ	
		PH6AQI1	GN20-E7 MaxQ	
The representative test sample is PH6AQ71.				

1.2 Antenna List

No.	Manufacturer	Part No.	Antenna Type	Peak Gain
1	Auden	ANTRP61119-1801 (Main)	PIFA	3.20dBi for 2.4GHz 2.83dBi for 5.15~5.25GHz 2.83dBi for 5.25~5.35GHz 2.87dBi for 5.47~5.725GHz 2.67dBi for 5.725~5.850GHz
	Auden	ANTRP61119-1801 (Aux)	PIFA	2.26dBi for 2.4GHz 3.17dBi for 5.15~5.25GHz 3.17dBi for 5.25~5.35GHz 3.49dBi for 5.47~5.725GHz 2.45dBi for 5.725~5.850GHz

Note: The above EUT information is declared by manufacturer.

1.3 SAR Test Exclusion Calculation

According to KDB Publication 447498 D01, section 4.3.1, per the calculations of item 1

(Power(mW)/separation (mm)*sqrt(f(GHz)≤3.0), SAR is required as shown in the table below where calculated values are greater than 3.0:

SAR exclusion calculations for WiFi-SISO and Bluetooth for antenna < 50mm from the user:

Antenna	Tx	Frequency (MHz)	Output Power		Separation distances (mm)	Calculated Threshold Value (≤3.0 SAR is not required)
			dBm	mW		
Main	WiFi	2462	21	126	Bottom	Bottom
Main	WiFi	2462	21	126	15	13.2
Main	WiFi	5240	16.5	45	15	6.8
Main	WiFi	5320	16.5	45	15	6.9
Main	WiFi	5700	16.5	45	15	7.1
Main	WiFi	5825	16.5	45	15	7.2

Antenna	Tx	Frequency (MHz)	Output Power		Separation distances (mm)	Calculated Threshold Value (≤3.0 SAR is not required)
			dBm	mW		
Aux	WiFi	2462	21	126	Bottom	Bottom
Aux	WiFi	2462	21	126	15	13.2
Aux	WiFi	5240	17.5	56	15	8.6
Aux	WiFi	5320	17.5	56	15	8.6
Aux	WiFi	5700	17.5	56	15	9.0
Aux	WiFi	5825	17.5	56	15	9.0
Aux	BT	2480	9	8	15	0.8

1.4 Test Environment

Ambient conditions in the laboratory:

Test Date: Mar. 15, 2022

Items	Required	Actual
Temperature (°C)	18-25	23.4 ± 2
Humidity (%RH)	30-70	51

Test Date: Mar. 16, 2022

Items	Required	Actual
Temperature (°C)	18-25	23.1 ± 2
Humidity (%RH)	30-70	49

USA : FCC Registration Number: TW0033
Canada : CAB Identifier Number: TW3023 / Company Number: 26930

Site Description : Accredited by TAF
Accredited Number: 3023

Test Laboratory : DEKRA Testing and Certification Co., Ltd
Address : No. 26, Huaya 1st Rd., Guishan Dist.,
Taoyuan City 333411, Taiwan, R.O.C.

Phone number : 886-3-275-7255

Fax number : 866-3-327-8031

Email address : info.tw@dekra.com

Website : <http://www.dekra.com.tw>

2. SAR Measurement System

2.1 DASY5 System Description

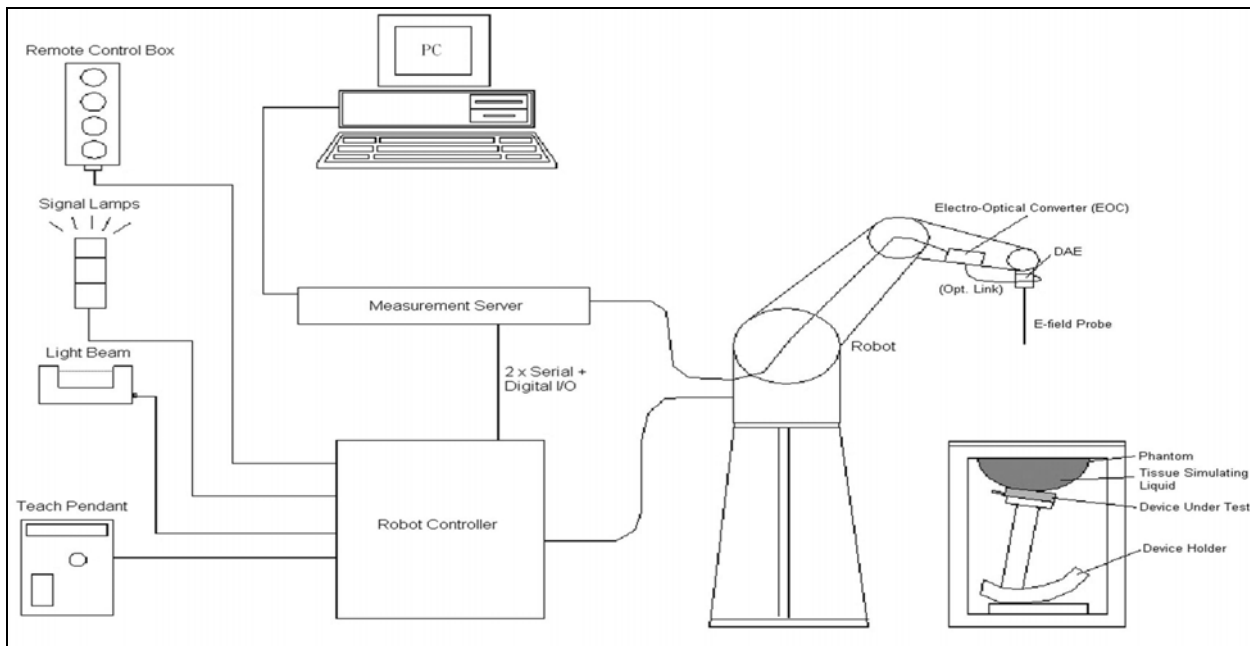

The DASY5 system for performing compliance tests consists of the following items:

- A standard high precision 6-axis robot with controller, teach pendant and software. An arm extension for accommodating the data acquisition electronics (DAE).
- A data acquisition electronics (DAE) which performs the signal amplification, signal multiplexing, AD-conversion, offset measurements, mechanical surface detection, collision detection, etc. The unit is battery powered with standard or rechargeable batteries. The signal is optically transmitted to the EOC.
- The Electro-optical converter (EOC) performs the conversion from optical to electrical signals for the digital communication to the DAE. To use optical surface detection, a special version of the EOC is required. The EOC signal is transmitted to the measurement server.
- The Light Beam used is for probe alignment. This improves the (absolute) accuracy of the probe positioning.
- A computer running WinXP and the DASY5 software.
- Remote control and teach pendant as well as additional circuitry for robot safety such as warning lamps, etc.
- The phantom, the device holder and other accessories according to the targeted measurement.

2.1.1 Applications

Predefined procedures and evaluations for automated compliance testing with all worldwide standards, e.g., IEEE 1528, OET 65, IEC 62209-1, IEC 62209-2, EN 50360, EN 50383 and others.

2.1.2 Area Scans

Area scans are defined prior to the measurement process being executed with a user defined variable spacing between each measurement point (integral) allowing low uncertainty measurements to be conducted. Scans defined for FCC applications utilize a 10mm² step integral, with 1mm interpolation used to locate the peak SAR area used for zoom scan assessments.

When an Area Scan has measured all reachable points, it computes the field maxima found in the scanned area, within a range of the global maximum. The range (in dB) is specified in the standards for compliance testing. For example, a 2 dB range is required in IEEE 1528-2013, EN 50361 and IEC 62209 standards, whereby 3 dB is a requirement when compliance is assessed in accordance with the ARIB standard (Japan).

2.1.3 Zoom Scan (Cube Scan Averaging)

Zoom Scans are used to assess the peak spatial SAR values within a cubic averaging volume containing 1 g and 10 g of simulated tissue. A density of 1000 kg/m³ is used to represent the head and body tissue density and not the phantom liquid density, in order to be consistent with the definition of the liquid dielectric properties, i.e. the side length of the 1 g cube is 10mm, with the side length of the 10 g cube 21,5mm.

The zoom scan integer steps can be user defined so as to reduce uncertainty, but normal practice for typical test applications (including FCC) utilize a physical step of 5x5x7 (8mmx8mmx5mm) providing a volume of 32mm in the X & Y axis, and 30mm in the Z axis.

2.1.4 Uncertainty of Inter-/Extrapolation and Averaging

In order to evaluate the uncertainty of the interpolation, extrapolation and averaged SAR calculation algorithms of the Postprocessor, DASY5 allows the generation of measurement grids which are artificially predefined by analytically based test functions. Therefore, the grids of area scans and zoom scans can be filled with uncertainty test data, according to the SAR benchmark functions of IEEE 1528. The three analytical functions shown in equations as below are used to describe the possible range of the expected SAR distributions for the tested handsets. The field gradients are covered by the spatially flat distribution f1, the spatially steep distribution f3 and f2 accounts for H-field cancellation on the phantom/tissue surface.

$$f_1(x, y, z) = Ae^{-\frac{z}{2a}} \cos^2 \left(\frac{\pi}{2} \frac{\sqrt{x'^2 + y'^2}}{5a} \right)$$

$$f_2(x, y, z) = Ae^{-\frac{z}{a}} \frac{a^2}{a^2 + x'^2} \left(3 - e^{-\frac{2z}{a}} \right) \cos^2 \left(\frac{\pi}{2} \frac{y'}{3a} \right)$$

$$f_3(x, y, z) = A \frac{a^2}{\frac{a^2}{4} + x'^2 + y'^2} \left(e^{-\frac{2z}{a}} + \frac{a^2}{2(a + 2z)^2} \right)$$

2.2 DASY5 E-Field Probe

The SAR measurement is conducted with the dosimetric probe manufactured by SPEAG. The probe is specially designed and calibrated for use in liquid with high permittivity. The dosimetric probe has special calibration in liquid at different frequency.

SPEAG conducts the probe calibration in compliance with international and national standards (e.g. IEEE 1528, EN 62209-1, IEC 62209, etc.) under ISO 17025. The calibration data are in Appendix D.

2.2.1 Isotropic E-Field Probe Specification

Model	Ex3DV4	
Construction	Symmetrical design with triangular core Built-in shielding against static charges PEEK enclosure material (resistant to organic solvents, e.g., DGBE)	
Frequency	10 MHz to 6 GHz Linearity: ± 0.2 dB (30 MHz to 6 GHz)	
Directivity	± 0.3 dB in HSL (rotation around probe axis) ± 0.5 dB in tissue material (rotation normal to probe axis)	
Dynamic Range	10 μ W/g to 100 mW/g Linearity: ± 0.2 dB (noise: typically < 1 μ W/g)	
Dimensions	Overall length: 330 mm (Tip: 20 mm) Tip diameter: 2.5 mm (Body: 12 mm) Typical distance from probe tip to dipole centers: 1 mm	
Application	High precision dosimetric measurements in any exposure scenario (e.g., very strong gradient fields). Only probe which enables compliance testing for frequencies up to 6 GHz with precision of better 30%.	

2.3 Boundary Detection Unit and Probe Mounting Device

The DASY probes use a precise connector and an additional holder for the probe, consisting of a plastic tube and a flexible silicon ring to center the probe. The connector at the DAE is flexibly mounted and held in the default position with magnets and springs. Two switching systems in the connector mount detect frontal and lateral probe collisions and trigger the necessary software response.



2.4 DATA Acquisition Electronics (DAE) and Measurement Server

The data acquisition electronics (DAE) consists of a highly sensitive electrometer-grade preamplifier with auto-zeroing, a channel and gain-switching multiplexer, a fast 16 bit AD-converter and a command decoder and control logic unit. Transmission to the measurement server is accomplished through an optical downlink for data and status information as well as an optical uplink for commands and the clock. The input impedance of the DAE4 is 200M Ohm; the inputs are symmetrical and floating. Common mode rejection is above 80dB.



The DASY5 measurement server is based on a PC/104 CPU board with a 400MHz Realtek ULV Celeron, 128MB chipdisk and 128MB RAM. The necessary circuits for communication with the DAE electronics box, as well as the 16 bit AD converter system for optical detection and digital I/O interface are contained on the DASY5 I/O board, which is directly connected to the PC/104 bus of the CPU board.



2.5 Robot

The DASY5 system uses the high precision robots TX90 XL type out of the newer series from Stäubli SA (France). For the 6-axis controller DASY5 system, the CS8C robot controller version from Stäubli is used.

The XL robot series have many features that are important for our application:

- High precision (repeatability 0.02 mm)
- High reliability (industrial design)
- Jerk-free straight movements
- Low ELF interference (the closed metallic construction shields against motor control fields)
- 6-axis controller



2.6 Light Beam Unit

The light beam switch allows automatic "tooling" of the probe. During the process, the actual position of the probe tip with respect to the robot arm is measured, as well as the probe length and the horizontal probe offset. The software then corrects all movements, such that the robot coordinates are valid for the probe tip.

The repeatability of this process is better than 0.1 mm. If a position has been taught with an aligned probe, the same position will be reached with another aligned probe within 0.1 mm, even if the other probe has different dimensions. During probe rotations, the probe tip will keep its actual position.



2.7 Device Holder

The DASY5 device holder is designed to cope with different positions given in the standard. It has two scales for the device rotation (with respect to the body axis) and the device inclination (with respect to the line between the ear reference points). The rotation center for both scales is the ear reference point (EPR).

Thus the device needs no repositioning when changing the angles.

The DASY5 device holder has been made out of low-loss POM material having the following dielectric parameters: relative permittivity $\epsilon_r = 3$ and loss tangent $\delta = 0.02$. The amount of dielectric material has been reduced in the closest vicinity of the device, since measurements have suggested that the influence of the clamp on the test results could thus be lowered.



2.8 SAM Twin Phantom

The SAM twin phantom is a fiberglass shell phantom with 2mm shell thickness (except the ear region where shell thickness increases to 6mm). It has three measurement areas:

- Left head
- Right head
- Flat phantom



The bottom plate contains three pair of bolts for locking the device holder. The device holder positions are adjusted to the standard measurement positions in the three sections. A white cover is provided to tap the phantom during off-periods to prevent water evaporation and changes in the liquid parameters. On the phantom top, three reference markers are provided to identify the phantom position with respect to the robot.

3. Tissue Simulating Liquid

3.1 The composition of the tissue simulating liquid

INGREDIENT (% Weight)	2450MHz Head	5GHz Head
Water	46.7	68.29
Salt	0.00	0.00
Sugar	0.00	0.00
HEC	0.00	0.00
Preventol	0.00	0.00
DGBE	53.3	2.44
Triton X-100	0.00	29.27

3.2 Tissue Calibration Result

The dielectric parameters of the liquids were verified prior to the SAR evaluation using Dielectric Probe Kit and Vector Network Analyzer.

Head Tissue Simulate Measurement				
Frequency [MHz]	Description	Dielectric Parameters		Tissue Temp. [°C]
		ϵ_r	σ [s/m]	
2450 MHz	Reference result ± 5% window	39.2 37.24 to 41.16	1.8 1.71 to 1.89	N/A
	15-Mar-22	39.45	1.80	22.2
2417 MHz	Channel 2	39.57	1.76	22.2
2437 MHz	Channel 6	39.49	1.78	22.2
2441 MHz	Channel 39	39.48	1.79	22.2
2457 MHz	Channel 10	39.42	1.81	22.2

Head Tissue Simulate Measurement				
Frequency [MHz]	Description	Dielectric Parameters		Tissue Temp. [°C]
		ϵ_r	σ [s/m]	
5250 MHz	Reference result ± 5% window	35.95 34.15 to 37.75	4.71 4.47 to 4.95	N/A
	16-Mar-22	36.23	4.64	22.3
5210 MHz	Channel 42	36.34	4.58	22.3
5290 MHz	Channel 58	36.12	4.69	22.3

Head Tissue Simulate Measurement				
Frequency [MHz]	Description	Dielectric Parameters		Tissue Temp. [°C]
		ϵ_r	σ [s/m]	
5600 MHz	Reference result $\pm 5\%$ window	35.5 33.73 to 37.28	5.07 4.82 to 5.32	N/A
	16-Mar-22	35.26	5.11	22.3
5530 MHz	Channel 106	35.45	5.02	22.3
5610 MHz	Channel 122	35.24	5.13	22.3
5690 MHz	Channel 138	35.02	5.23	22.3

Head Tissue Simulate Measurement				
Frequency [MHz]	Description	Dielectric Parameters		Tissue Temp. [°C]
		ϵ_r	σ [s/m]	
5800 MHz	Reference result $\pm 5\%$ window	35.3 33.54 to 37.07	5.27 5.01 to 5.53	N/A
	16-Mar-22	34.71	5.37	22.3
5775 MHz	Channel 155	34.78	5.34	22.3

3.3 Tissue Dielectric Parameters for Head and Body Phantoms

The head tissue dielectric parameters recommended by the IEC 62209-1 have been incorporated in the following table. These head parameters are derived from planar layer models simulating the highest expected SAR for the dielectric properties and tissue thickness variations in a human head. Other head tissue parameters that have not been specified are interpolated according to the head parameters specified in IEC 62209-1.

Target Frequency (MHz)	Head	
	ϵ_r	σ (S/m)
300	45.3	0.87
450	43.5	0.87
750	41.9	0.89
835	41.5	0.90
900	41.5	0.97
1450	40.5	1.20
1640	40.2	1.31
1750	40.1	1.37
1800 – 2000	40.0	1.40
2450	39.2	1.80
3000	38.5	2.40
5000	36.2	4.45
5200	36.0	4.66
5400	35.8	4.86
5600	35.3	5.27
5800	35.3	5.27
6000	35.1	5.48

(ϵ_r = relative permittivity, σ = conductivity and $\rho = 1000 \text{ kg/m}^3$)

4. SAR Measurement Procedure

4.1 SAR System Check

4.1.1 Dipoles

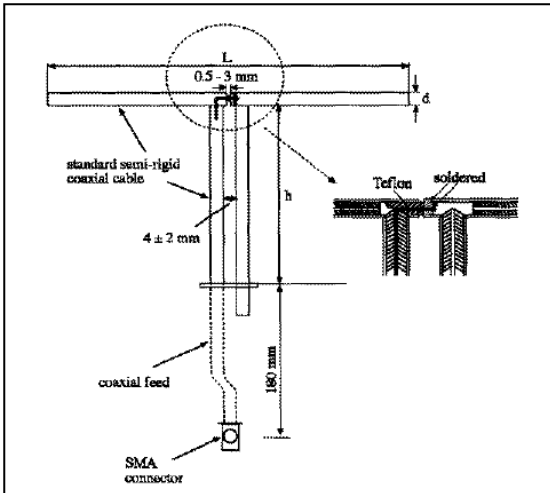

The dipoles used is based on the IEEE-1528 standard, and is complied with mechanical and electrical specifications in line with the requirements of both IEEE and FCC Supplement C. the table below provides details for the mechanical and electrical specifications for the dipoles.

Frequency	L (mm)	h (mm)	d (mm)
2450MHz	51.5	30.4	3.6
5200M~5800MHz	20.6	40.3	3.6

4.1.2 System Check Result

System Performance Check at 2450MHz				
Dipole Kit: D2450V2				
Frequency [MHz]	Description	SAR [w/kg] 1g	SAR [w/kg] 10g	Tissue Temp. [°C]
2450 MHz	Reference result ± 10% window	53.1 47.79 to 58.41	24.6 22.14 to 27.06	N/A
	15-Mar-22	54	25.56	22.2

Note: (1) The power level is used 250mW
 (2) All SAR values are normalized to 1W forward power.
 (3) The reference result is from Appendix E.

System Performance Check at 5250MHz				
Dipole Kit: D5GHzV2				
Frequency [MHz]	Description	SAR [w/kg] 1g	SAR [w/kg] 10g	Tissue Temp. [°C]
5250 MHz	Reference result ± 10% window	81.6 73.44 to 89.76	23.2 20.88 to 25.52	N/A
	16-Mar-22	81.5	22.8	22.3
Note: (1) The power level is used 100mW (2) All SAR values are normalized to 1W forward power. (3) The reference result is from Appendix E.				

System Performance Check at 5600MHz				
Dipole Kit: D5GHzV2				
Frequency [MHz]	Description	SAR [w/kg] 1g	SAR [w/kg] 10g	Tissue Temp. [°C]
5600 MHz	Reference result ± 10% window	85.9 77.31 to 94.49	24.2 21.78 to 26.62	N/A
	16-Mar-22	85.7	25.1	22.3
Note: (1) The power level is used 100mW (2) All SAR values are normalized to 1W forward power. (3) The reference result is from Appendix E.				

System Performance Check at 5800MHz				
Dipole Kit: D5GHzV2				
Frequency [MHz]	Description	SAR [w/kg] 1g	SAR [w/kg] 10g	Tissue Temp. [°C]
5800 MHz	Reference result ± 10% window	82.0 73.80 to 90.20	22.8 20.52 to 25.08	N/A
	16-Mar-22	83.7	23.6	22.3
Note: (1) The power level is used 100mW (2) All SAR values are normalized to 1W forward power. (3) The reference result is from Appendix E.				

4.2 SAR Measurement Procedure

The Dasy5 calculates SAR using the following equation,

$$SAR = \frac{\sigma |E|^2}{\rho}$$

σ : represents the simulated tissue conductivity

ρ : represents the tissue density

The EUT is set to transmit at the required power in line with product specification, at each frequency relating to the LOW, MID, and HIGH channel settings.

Pre-scans are made on the device to establish the location for the transmitting antenna, using a large area scan in either air or tissue simulation fluid.

The EUT is placed against the Universal Phantom where the maximum area scan dimensions are larger than the physical size of the resonating antenna. When the scan size is not large enough to cover the peak SAR distribution, it is modified by either extending the area scan size in both the X and Y directions, or the device is shifted within the predefined area.

The area scan is then run to establish the peak SAR location (interpolated resolution set at 1mm²) which is then used to orient the center of the zoom scan. The zoom scan is then executed and the 1g and 10g averages are derived from the zoom scan volume (interpolated resolution set at 1mm³).

5. SAR Exposure Limits

SAR assessments have been made in line with the requirements of IEEE-1528, FCC Supplement C, and comply with ANSI/IEEE C95.1-1992 “Uncontrolled Environments” limits. These limits apply to a location which is deemed as “Uncontrolled Environment” which can be described as a situation where the general public may be exposed to an RF source with no prior knowledge or control over their exposure.

Limits for General Population/Uncontrolled Exposure (W/kg)

Type Exposure	Uncontrolled Environment Limit
Spatial Peak SAR (1g cube tissue for brain or body)	1.60 W/kg
Spatial Average SAR (whole body)	0.08 W/kg
Spatial Peak SAR (10g for hands, feet, ankles and wrist)	4.00 W/kg

6. Test Equipment List

Instrument	Manufacturer	Model No.	Serial No.	Last Calibration	Next Calibration
Reference Dipole 2450MHz	Speag	D2450V2	930	2019/11/21	2022/11/20
Reference Dipole 5GHz	Speag	D5GHzV2	1041	2020/05/25	2023/05/24
Device Holder	Speag	N/A	N/A	N/A	N/A
Data Acquisition Electronic	Speag	DAE4	1207	2021/11/22	2022/11/21
E-Field Probe	Speag	EX3DV4	3698	2021/11/24	2022/11/23
SAR Software	Speag	DASY52	V52.10.0.1446	N/A	N/A
Power Amplifier	Mini-Circuit	ZVE-8G	541100241	N/A	N/A
Directional Coupler	Agilent	87300C	MY44300353	N/A	N/A ¹
Attenuator	Woken	WATT-218FS-10	N/A	N/A	N/A ¹
Attenuator	Mini-Circuit	BW-S20W2+	N/A	N/A	N/A ¹
Vector Network Analyzer	Keysight	E5071C	MY46106342	2021/10/18	2022/10/17
Signal Generator	Anritsu	MG3694A	041902	2021/8/26	2022/8/25
Power Meter	Anritsu	ML2487A	6K00001447	2021/11/02	2022/11/01
Power Sensor	Anritsu	MA2411B	1339194	2021/11/02	2022/11/01

Note: 1. System Check, the path loss measured by the network analyzer, includes the signal generator, amplifier, cable, attenuator and directional coupler.

Note:

Per KDB 865664 D01 requirements for dipole calibration, the following are recommended FCC procedures for SAR dipole calibration.

1. After a dipole is damaged and properly repaired to meet required specifications
2. When the measured SAR deviates from the calibrated SAR value by more than 10% due to changes in physical, mechanical, electrical or other relevant dipole conditions;
3. When the most recent return-loss, measured at least annually, deviates by more than 20% from the previous measurement (i.e. 0.2 of the dB value) or not meeting the required -20 dB return-loss specification

	Frequency	Tissue	Return loss	Limit	Verified Date
Calibration	2450	Head	-25.16dB	Within 20%	2019.11.21
Measurement	2450	Head	-24.77dB		2020.11.18
Measurement	2450	Head	-25.29dB		2021.11.16

	Frequency	Tissue	Return loss	Limit	Verified Date
Calibration	5250	Head	-26.86dB	Within 20%	2020.05.25
Measurement	5250	Head	-24.16dB		2021.05.18

	Frequency	Tissue	Return loss	Limit	Verified Date
Calibration	5600	Head	-24.43dB	Within 20%	2020.05.25
Measurement	5600	Head	-27.05dB		2021.05.18

	Frequency	Tissue	Return loss	Limit	Verified Date
Calibration	5800	Head	-26.80dB	Within 20%	2020.05.25
Measurement	5800	Head	-25.64dB		2021.05.18

4. When the most recent measurement of the real or imaginary parts of the impedance, measured at least annually, deviates by more than 5 Ω from the previous measurement

	Frequency	Tissue	Impedance	Limit	Verified Date
Calibration	2450	Head	54.37	Within 5 Ω	2019.11.21
Measurement	2450	Head	56.58		2020.11.18
Measurement	2450	Head	55.9		2021.11.16

	Frequency	Tissue	Return loss	Limit	Verified Date
Calibration	5250	Head	49.04	Within 5 Ω	2020.05.25
Measurement	5250	Head	45.54		2021.05.18

	Frequency	Tissue	Return loss	Limit	Verified Date
Calibration	5600	Head	56.26	Within 5 Ω	2020.05.25
Measurement	5600	Head	52.24		2021.05.18

	Frequency	Tissue	Return loss	Limit	Verified Date
Calibration	5800	Head	54.28	Within 5 Ω	2020.05.25
Measurement	5800	Head	49.85		2021.05.18

7. Measurement Uncertainty

Measurement uncertainty for 30 MHz to 3 GHz								
Error Description	Uncert. value	Prob. Dist.	Div.	(ci) 1g	(ci) 10g	Std. Unc. (1g)	Std. Unc. (10g)	(vi) V _{eff}
Measurement System								
Probe Calibration	±6%	N	1	1	1	±6.0%	±6.0%	∞
Axial Isotropy	±4.7%	R	$\sqrt{3}$	0.7	0.7	±1.9%	±1.9%	∞
Hemispherical Isotropy	±9.6%	R	$\sqrt{3}$	0.7	0.7	±3.9%	±3.9%	∞
Boundary Effects	±1.0%	R	$\sqrt{3}$	1	1	±0.6%	±0.6%	∞
Linearity	±4.7%	R	$\sqrt{3}$	1	1	±2.7%	±2.7%	∞
System Detection Limits	±1.0%	R	$\sqrt{3}$	1	1	±0.6%	±0.6%	∞
Modulation Response	±2.4%	R	$\sqrt{3}$	1	1	±1.4%	±1.4%	∞
Readout Electronics	±0.3%	N	1	1	1	±0.3%	±0.3%	∞
Response Time	±0.8%	R	$\sqrt{3}$	1	1	±0.5%	±0.5%	∞
Integration Time	±2.6%	R	$\sqrt{3}$	1	1	±1.5%	±1.5%	∞
RF Ambient Noise	±3.0%	R	$\sqrt{3}$	1	1	±1.7%	±1.7%	∞
RF Ambient Reflections	±3.0%	R	$\sqrt{3}$	1	1	±1.7%	±1.7%	∞
Probe Positioner	±0.4%	R	$\sqrt{3}$	1	1	±0.2%	±0.2%	∞
Probe Positioning	±2.9%	R	$\sqrt{3}$	1	1	±1.7%	±1.7%	∞
Max. SAR Eval.	±4.0%	R	$\sqrt{3}$	1	1	±1.2%	±1.2%	∞
Test Sample Related								
Device Positioning	±2.9%	N	1	1	1	±2.9%	±2.9%	145
Device Holder	±3.6%	N	1	1	1	±3.6%	±3.6%	5
Power Drift	±5.0%	R	$\sqrt{3}$	1	1	±2.9%	±2.9%	∞
Power Scaling	±0%	R	$\sqrt{3}$	1	1	±0.0%	±0.0%	
Phantom and Setup								
Phantom Uncertainty	±6.1%	R	$\sqrt{3}$	1	1	±3.5%	±3.5%	∞
SAR correction	±1.9%	R	$\sqrt{3}$	1	0.84	±1.1%	±0.9%	∞
Liquid Conductivity (meas.)	±2.5%	R	$\sqrt{3}$	0.78	0.71	±1.1%	±1.0%	∞
Liquid Permittivity (meas.)	±2.5%	R	$\sqrt{3}$	0.26	0.26	±0.3%	±0.4%	∞
Temp. unc. - Conductivity	±3.4%	R	$\sqrt{3}$	0.78	0.71	±1.5%	±1.4%	∞
Temp. unc. - Permittivity	±0.4%	R	$\sqrt{3}$	0.23	0.26	±0.1%	±0.1%	∞
Combined Std. Uncertainty						±11.2%	±11.1%	361
Expanded STD Uncertainty						±22.3%	±22.2%	

Measurement uncertainty for 3GHz to 6 GHz								
Error Description	Uncert. value	Prob. Dist.	Div.	(ci) 1g	(ci) 10g	Std. Unc. (1g)	Std. Unc. (10g)	(vi) V _{eff}
Measurement System								
Probe Calibration	±6.55%	N	1	1	1	±6.55%	±6.55%	∞
Axial Isotropy	±4.7%	R	√3	0.7	0.7	±1.9%	±1.9%	∞
Hemispherical Isotropy	±9.6%	R	√3	0.7	0.7	±3.9%	±3.9%	∞
Boundary Effects	±2.0%	R	√3	1	1	±1.2%	±1.2%	∞
Linearity	±4.7%	R	√3	1	1	±2.7%	±2.7%	∞
System Detection Limits	±1.0%	R	√3	1	1	±0.6%	±0.6%	∞
Modulation Response	±2.4%	R	√3	1	1	±1.4%	±1.4%	∞
Readout Electronics	±0.3%	N	1	1	1	±0.3%	±0.3%	∞
Response Time	±0.8%	R	√3	1	1	±0.5%	±0.5%	∞
Integration Time	±2.6%	R	√3	1	1	±1.5%	±1.5%	∞
RF Ambient Noise	±3.0%	R	√3	1	1	±1.7%	±1.7%	∞
RF Ambient Reflections	±3.0%	R	√3	1	1	±1.7%	±1.7%	∞
Probe Positioner	±0.8%	R	√3	1	1	±0.5%	±0.5%	∞
Probe Positioning	±6.7%	R	√3	1	1	±3.9%	±3.9%	∞
Post-processing	±4.0%	R	√3	1	1	±2.3%	±2.3%	∞
Test Sample Related								
Device Positioning	±2.9%	N	1	1	1	±2.9%	±2.9%	145
Device Holder	±3.6%	N	1	1	1	±3.6%	±3.6%	5
Power Drift	±5.0%	R	√3	1	1	±2.9%	±2.9%	∞
Power Scaling	±0%	R	√3	1	1	±0.0%	±0.0%	
Phantom and Setup								
Phantom Uncertainty	±6.6%	R	√3	1	1	±3.8%	±3.8%	∞
SAR correction	±1.9%	R	√3	1	1	±1.1%	±0.9%	∞
Liquid Conductivity (meas.)	±2.5%	R	√3	1	0.84	±1.1%	±1.0%	∞
Liquid Permittivity (meas.)	±2.5%	R	√3	0.26	0.26	±0.3%	±0.4%	∞
Temp. unc. - Conductivity	±3.4%	R	√3	0.78	0.71	±1.5%	±1.4%	∞
Temp. unc. - Permittivity	±0.4%	R	√3	0.23	0.26	±0.1%	±0.1%	∞
Combined Std. Uncertainty						±12.3%	±12.2%	748
Expanded STD Uncertainty						±24.6%	±24.5%	

8. Conducted Power Measurement (Including tolerance allowed for production unit)

WLAN 2.4G 2TX SISO												
DSSS/OFDM mode specified maximum output power at an antenna port	Frequency	Mode	BW	SISO-Main(TX1)			SISO-Aux(TX2)					
				CH	AV Power	AV Target	CH	AV Power	AV Target			
WLAN 2.4GHz		b	20	1	19.49	19.5	1	19.45	19.5			
				2	20.92	21	2	20.88	21			
				6	20.97	21	6	20.91	21			
				10	20.85	21	10	20.89	21			
				11	19.91	20	11	19.97	20			
				12	18.65	19	12	18.48	18.5			
				13	15.44	15.5	13	15.41	15.5			
			g	20	1	16.91	17	1	16.92	17		
					6	20.87	21	6	20.81	21		
					11	17.46	17.5	11	17.41	17.5		
					12	15.46	15.5	12	14.92	15		
					13	1.99	2	13	1.48	1.5		
					n (HT)	20	1	16.91	17	1	16.98	17
							6	20.44	20.5	6	20.41	20.5
		11	15.95	16			11	16.41	16.5			
		12	15.47	15.5			12	14.97	15			
		40	3	16.96		17.5	3	16.98	17			
			6	16.41		20	6	15.96	20			
			9	15.95		16	9	15.91	16			
			10	12.41		12.5	10	11.93	12.5			
		ax (HE)	20	1	17.47	17.5	1	16.98	17.5			
				6	15.47	20	6	14.39	20			
				11	15.91	16	11	15.91	16			
				12	15.41	15.5	12	15.41	15.5			
				13	1.91	2	13	1.41	1.5			
			40	3	16.41	16.5	3	16.44	16.5			
				6	16.48	16.5	6	16.41	16.5			
				9	15.97	16	9	15.96	16			
10	12.44			12.5	10	11.91	12					
11	5.45			5.5	11	4.41	4.5					

WLAN 5G 2TX SISO																	
Frequency	Mode	BW	SISO-Main(TX1)			SISO-Aux(TX2)			Frequency	Mode	BW	SISO-Main(TX1)			SISO-Aux(TX2)		
			CH	AV Power	AV Target	CH	AV Power	AV Target				CH	AV Power	AV Target	CH	AV Power	AV Target
U-NII-1 (5150~5250MHz)	a	20	36	15.94	16.5	36	15.94	17.5	U-NII-2C (5470~5725MHz)	a	20	100	15.93	16.5	100	15.91	17.5
			40	15.88	16.5	40	15.96	17.5				112	15.96	16.5	112	15.95	17.5
			44	15.89	16.5	44	15.96	17.5				116	15.93	16.5	116	15.91	17.5
			48	15.94	16.5	48	15.95	17.5				128	15.91	16.5	128	15.92	17.5
	n (HT)	20	36	15.94	16.5	36	15.93	17.5		n (HT)	20	100	15.91	16.5	100	15.96	17.5
			40	15.91	16.5	40	15.91	17.5				112	15.93	16.5	112	15.94	17.5
			44	15.94	16.5	44	15.89	17.5				116	15.91	16.5	116	15.95	17.5
			48	15.92	16.5	48	15.91	17.5				128	15.96	16.5	128	15.91	17.5
	ac(VHT)	40	38	15.95	16.5	38	15.95	17.5		ac(VHT)	40	102	15.93	16.5	102	15.91	17.5
			46	15.91	16.5	46	15.96	17.5				110	15.91	16.5	110	15.92	17.5
			38	15.94	16.5	38	15.91	17.5				118	15.91	16.5	118	15.96	17.5
			46	15.92	16.5	46	15.92	17.5				126	15.94	16.5	126	15.94	17.5
	ax (HE)	20	36	15.95	16.5	36	15.92	17.5		ax(HE)	20	134	15.92	16.5	134	15.96	17.5
			40	15.91	16.5	40	15.94	17.5				142	15.95	16.5	142	15.94	17.5
			44	15.93	16.5	44	15.92	17.5				106	15.93	16.5	106	15.89	17.5
			48	15.91	16.5	48	15.91	17.5				122	15.89	16.5	122	15.87	17.5
ax (HE)	40	38	15.94	16.5	38	15.91	17.5	ax(VHT)	80	138	15.96	16.5	138	15.98	17.5		
		46	15.92	16.5	46	15.92	17.5			106	15.93	16.5	106	15.89	17.5		
		42	15.93	16.5	42	15.96	17.5			122	15.89	16.5	122	15.87	17.5		
		42	15.93	16.5	42	15.96	17.5			160	114	14.96	15	114	14.46	14.5	
U-NII-2A (5250~5350MHz)	a	20	52	15.91	16.5	52	15.91	17.5	U-NII-3 (5725~5850MHz)	a	20	149	15.96	16.5	149	15.91	17.5
			56	15.93	16.5	56	15.91	17.5				157	15.91	16.5	157	15.96	17.5
			60	15.91	16.5	60	15.94	17.5				165	15.91	16.5	165	15.89	17.5
			64	15.89	16.5	64	15.94	17.5				149	15.94	16.5	149	15.93	17.5
	n (HT)	20	52	15.96	16.5	52	15.97	17.5		n (HT)	20	157	15.94	16.5	157	15.91	17.5
			56	15.93	16.5	56	15.92	17.5				165	15.95	16.5	165	15.89	17.5
			60	15.91	16.5	60	15.95	17.5				151	15.91	16.5	151	15.91	17.5
			64	15.94	16.5	64	15.96	17.5				159	15.91	16.5	159	15.92	17.5
	ac (VHT)	40	54	15.92	16.5	54	15.95	17.5		ac(VHT)	80	155	15.91	16.5	155	15.94	17.5
			62	15.92	16.5	62	15.93	16.5				149	15.93	16.5	149	15.92	17.5
			58	15.97	16.5	58	15.98	17.5				157	15.93	16.5	157	15.91	17.5
			50	14.97	15	50	14.98	15				165	15.92	16.5	165	15.91	17.5
	ax (HE)	20	52	15.93	16.5	52	15.95	17.5		ax(HE)	20	151	15.91	16.5	151	15.92	17.5
			56	15.91	16.5	56	15.95	17.5				159	15.94	16.5	159	15.94	17.5
			60	15.93	16.5	60	15.92	17.5				138	15.94	16.5	138	15.86	17.5
			64	15.91	16.5	64	15.95	17.5				155	15.87	16.5	155	15.96	17.5
ax (HE)	40	54	15.93	16.5	54	15.93	17.5	ax(HE)	40	151	15.91	16.5	151	15.92	17.5		
		62	15.94	16.5	62	15.94	16.5			159	15.94	16.5	159	15.94	17.5		
		58	15.91	16.5	58	15.95	17.5			138	15.94	16.5	138	15.86	17.5		
		80	15.91	16.5	80	15.95	17.5			155	15.87	16.5	155	15.96	17.5		
ax (HE)	80	50	14.96	15	50	14.91	15	ax(HE)	80	155	15.87	16.5	155	15.96	17.5		

OFDM mode specified maximum output power at an antenna port

BT Only Support Aux									
Bluetooth mode maximum output power	Frequency	Mode	Modulation	SISO-Main(TX1)			SISO-Aux(TX2)		
				CH	AV Power	AV Target	CH	AV Power	AV Target
	BT 2.4GHz	BR	GFSK	0	N/A	N/A	0	8.67	9.0
				39	N/A	N/A	39	8.91	9.0
				78	N/A	N/A	78	8.83	9.0
		EDR	8DPSK	0	N/A	N/A	0	7.58	8.5
				39	N/A	N/A	39	7.74	8.5
				78	N/A	N/A	78	7.69	8.5
		BLE	GFSK	0	N/A	N/A	0	6.96	7.0
				19	N/A	N/A	19	6.82	7.0
				39	N/A	N/A	39	6.97	7.0

9. Test Results

9.1 SAR Test Results Summary

SAR MEASUREMENT									
Liquid Temperature (°C) : 22.2 ±2					Relative Humidity (%) : 51 %				
Ambient Temperature (°C) : 23.4 ±2					Depth of Liquid (cm) : >15				
Test Position	Antenna Position	Dist (mm)	Frequency		Conducted Power (dBm)		SAR 1g (W/kg)		Plot No.
			Channel	MHz	Measurement	Tune-up Limit	Measurement	Tune-up Scaled	
Test Mode : 802.11b Main									
Bottom	Fixed	0	2	2417	20.92	21	1.040	1.059	
Bottom	Fixed	0	6	2437	20.97	21	1.060	1.067	
Bottom	Fixed	0	10	2457	20.85	21	1.100	1.139	1
Test Mode : 802.11b Aux									
Bottom	Fixed	0	2	2417	20.88	21	1.040	1.069	
Bottom	Fixed	0	6	2437	20.91	21	0.994	1.015	
Bottom	Fixed	0	10	2457	20.89	21	0.730	0.749	
Test Mode : BT-1M Aux									
Bottom	Fixed	0	39	2441	8.91	9	0.058	0.059	2
<p>Note : 1. When the highest reported SAR for DSSS is adjusted by the ratio of OFDM to DSSS specified maximum output power and the adjusted SAR is ≤ 1.2 W/kg, SAR is not required.</p> <p>2. When the reported SAR of the highest measured maximum output power channel for the exposure configuration is ≤ 0.8 W/kg, no further SAR testing is required for 802.11b DSSS in that exposure configuration.</p>									

SAR MEASUREMENT									
Liquid Temperature (°C) : 22.3 ±2					Relative Humidity (%) : 49 %				
Ambient Temperature (°C) : 23.1 ±2					Depth of Liquid (cm) : >15				
Test Position	Antenna Position	Dist (mm)	Frequency		Conducted Power (dBm)		SAR 1g (W/kg)		Plot No.
			Channel	MHz	Measurement	Tune-up Limit	Measurement	Tune-up Scaled	
Test Mode :802.11ac80M Main									
Bottom	Fixed	0	42	5210	15.92	16.5	0.495	0.566	
Bottom	Fixed	0	58	5290	15.97	16.5	0.608	0.687	
Bottom	Fixed	0	106	5530	15.93	16.5	0.743	0.847	
Bottom	Fixed	0	122	5610	15.89	16.5	0.941	1.083	3
Bottom	Fixed	0	138	5690	15.96	16.5	0.842	0.953	
Bottom	Fixed	0	155	5775	15.91	16.5	0.710	0.813	
Test Mode :802.11ac80M Aux									
Bottom	Fixed	0	42	5210	15.96	17.5	0.576	0.821	
Bottom	Fixed	0	58	5290	15.98	17.5	0.621	0.881	4
Bottom	Fixed	0	106	5530	15.89	17.5	0.649	0.940	
Bottom	Fixed	0	122	5610	15.87	17.5	0.736	1.071	
Bottom	Fixed	0	138	5690	15.98	17.5	0.761	1.080	
Bottom	Fixed	0	155	5775	15.94	17.5	0.742	1.063	5
<p>Note : 1. When multiple transmission modes (802.11 n) have the same specified maximum output power, largest channel bandwidth, lowest order modulation and lowest data rate, the lowest order 802.11 mode is selected</p> <p>2. When the reported SAR of the highest measured maximum output power channel for the exposure configuration is ≤ 0.8 W/kg, no further SAR testing is required in that exposure configuration.</p> <p>3. When the reported SAR of the highest measured maximum U-NII-2A for the exposure configuration is ≤ 1.2 W/kg, SAR is not required for U-NII-1 band.</p>									

9.2 Simultaneous Transmission

Simultaneous Transmission Configurations	
1	WLAN 2.4GHz Main + WLAN 2.4GHz Aux
2	WLAN 2.4GHz Main + BT Aux
3	WLAN 5GHz Main + BT Aux
4	WLAN 5GHz Main + WLAN 5GHz Aux
5	WLAN 5GHz Main + WLAN 5GHz Aux + BT Aux

9.2.1 Simultaneous transmission of MIMO in 802.11 test exclusion considerations

Frequency (GHz)	Test Position	WLAN Main SAR (W/Kg)	WLAN Aux SAR W/Kg)	Simultaneous Transmission (W/Kg)	Antenna pair in mm	Peak location separation ratio
2.4	Bottom	1.139	1.069	2.208	77.76	0.04
5	Bottom	1.083	1.080	2.163	82.29	0.039

Note: The sum of value is less than 1.6W/Kg or the ratio is determined by $(SAR1 + SAR2)^{1.5}/R_i$, rounded to two decimal digits, and must be ≤ 0.04 for all antenna pairs in the configuration to qualify for SAR test exclusion.

9.2.2 simultaneous transmission of Wi-Fi and other wireless technologies

When the sum of SAR is larger than the limit, The ratio is determined by $(SAR1 + SAR2)^{1.5/R_i}$, rounded to two decimal digits, and must be ≤ 0.04 for all antenna pairs in the configuration to qualify for 1-g SAR test exclusion.

The estimation result as below:

For DTS Band:

Mode	WLAN Main SAR (W/Kg)	BT SAR (W/Kg)	Simultaneous Transmission (W/Kg)	Antenna pair in mm	Peak location separation ratio
Bottom	1.139	0.059	1.198	N/A	N/A

The sum of value is less than 1.6W/Kg, thus simultaneous SAR testing is not needed.

For U-NII Band:

Mode	WLAN Main SAR (W/Kg)	BT SAR (W/Kg)	Simultaneous Transmission (W/Kg)	Antenna pair in mm	Peak location separation ratio
Bottom	1.083	0.059	1.142	N/A	N/A

The sum of value is less than 1.6W/Kg, thus simultaneous SAR testing is not needed.

Mode	WLAN Main SAR (W/Kg)	WLAN Aux SAR (W/Kg)	BT SAR (W/Kg)	Simultaneous Transmission (W/Kg)	Antenna pair in mm	Peak location separation ratio
Bottom	1.083	1.080	0.059	2.222	82.29	0.04

The ratio of value is less than or equal to 0.04, thus simultaneous SAR testing is not needed.

10. SAR measurement variability

- 1) Repeated measurement is not required when the original highest measured SAR is < 0.80 W/kg; steps 2) through 4) do not apply.
- 2) When the original highest measured SAR is ≥ 0.80 W/kg, repeat that measurement once.
- 3) Perform a second repeated measurement only if the ratio of largest to smallest SAR for the original and first repeated measurements is > 1.20 or when the original or repeated measurement is ≥ 1.45 W/kg ($\sim 10\%$ from the 1-g SAR limit).
- 4) Perform a third repeated measurement only if the original, first or second repeated measurement is ≥ 1.5 W/kg and the ratio of largest to smallest SAR for the original, first and second repeated measurements is > 1.20 .

Frequency		SAR 1g (W/kg)						
Channel	MHz	Original	First Repeated		Second Repeated		Third Repeated	
			Value	Ratio	Value	Ratio	Value	Ratio
10	2457	1.100	1.090	1.009	N/A	N/A	N/A	N/A
122	5610	0.941	0.848	1.110	N/A	N/A	N/A	N/A

Appendix

Appendix A. SAR System Check Data

Appendix B. SAR measurement Data

Appendix C. Test Setup Photographs

Appendix D. Probe Calibration Data

Appendix E. Dipole Calibration Data

Appendix F. Product Photos-Please refer to the file: 2230501R-Product Photos

Appendix A. SAR System Check Data

Test Laboratory: DEKRA

Date: 2022/03/15

System Performance Check_2450MHz-Head

DUT: Dipole 2450 MHz; Type: D2450V2

Communication System: UID 10000, CW; Frequency: 2450 MHz;

Communication System PAR: 0 dB

Medium parameters used: $f = 2450$ MHz; $\sigma = 1.8$ S/m; $\epsilon_r = 39.45$; $\rho = 1000$ kg/m³

Phantom section: Flat Section

Ambient Temperature (°C) : 23.4, Liquid Temperature (°C) : 22.2

Measurement Standard: DASYS (IEEE/IEC/ANSI C63.19-2011)

DASY5 Configuration:

- Probe: EX3DV4 - SN3698; ConvF(7.19, 7.19, 7.19); Calibrated: 2021/11/24;
- Sensor-Surface: 1.4mm (Mechanical Surface Detection)
- Electronics: DAE4 Sn1207; Calibrated: 2021/11/22
- Phantom: SAM with left table; Type: SAM;
- Measurement SW: DASYS2, Version 52.10 (0); SEMCAD X Version 14.6.10 (7417)

Configuration/2450MHz_Head/Area Scan (8x9x1): Measurement grid: dx=12mm, dy=12mm

Maximum value of SAR (measured) = 19.7 W/kg

Configuration/2450MHz_Head/Zoom Scan (7x7x7)/Cube 0: Measurement grid: dx=5mm, dy=5mm, dz=5mm

Reference Value = 110.4 V/m; Power Drift = -0.02 dB

Peak SAR (extrapolated) = 26.3 W/kg

SAR(1 g) = 13.5 W/kg; SAR(10 g) = 6.39 W/kg

Maximum value of SAR (measured) = 24.1 W/kg

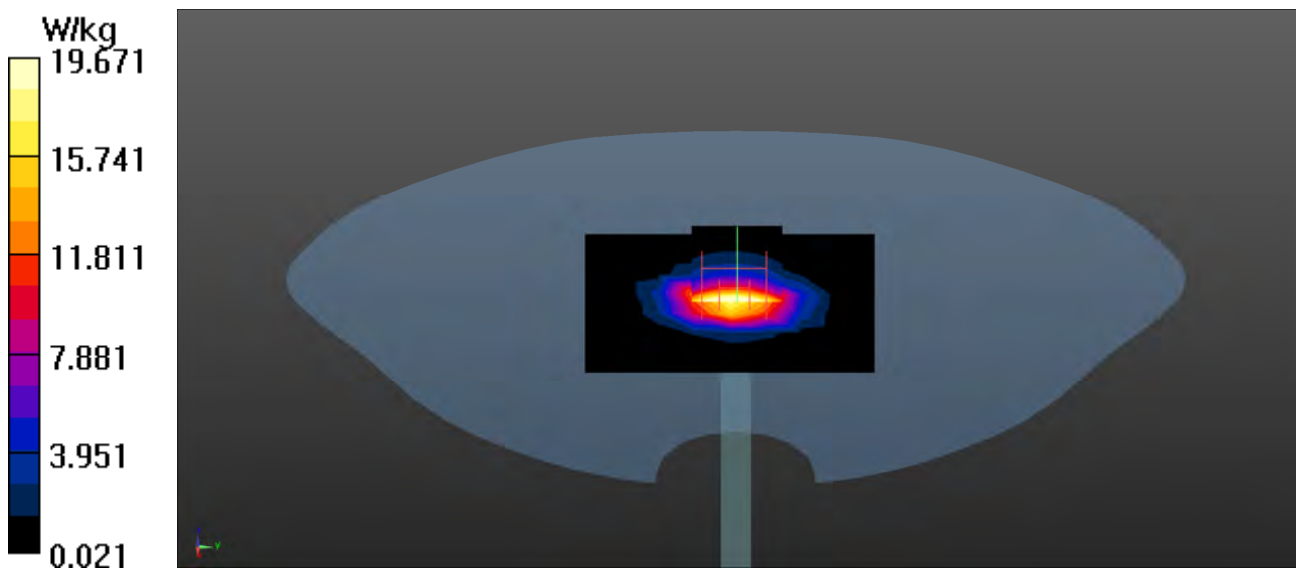

Test Laboratory: DEKRA

Date: 2022/03/16

System Performance Check_5250MHz-Head**DUT: Dipole 5GHz; Type: D5GHzV2**

Communication System: UID 0, CW; Frequency: 5250 MHz;

Communication System PAR: 0 dB

Medium parameters used: $f = 5250$ MHz; $\sigma = 4.64$ S/m; $\epsilon_r = 36.23$; $\rho = 1000$ kg/m³

Phantom section: Flat Section

Ambient Temperature (°C) : 23.1, Liquid Temperature (°C) : 22.3

Measurement Standard: DASY5 (IEEE/IEC/ANSI C63.19-2011)

DASY5 Configuration:

- Probe: EX3DV4 - SN3698; ConvF(4.7, 4.7, 4.7); Calibrated: 2021/11/24;
- Sensor-Surface: 1.4mm (Mechanical Surface Detection)
- Electronics: DAE4 Sn1207; Calibrated: 2021/11/22
- Phantom: SAM with right table; Type: SAM;
- Measurement SW: DASY52, Version 52.10 (0); SEMCAD X Version 14.6.10 (7417)

Configuration/5250MHz-Head/Area Scan (8x8x1): Measurement grid: dx=10mm, dy=10mm

Maximum value of SAR (measured) = 12.0 W/kg

Configuration/5250MHz-Head/Zoom Scan (7x7x7)/Cube 0: Measurement grid: dx=4mm, dy=4mm, dz=1.4mm

Reference Value = 72.84 V/m; Power Drift = -0.03 dB

Peak SAR (extrapolated) = 28.1 W/kg

SAR(1 g) = 8.15 W/kg; SAR(10 g) = 2.28 W/kg

Maximum value of SAR (measured) = 20.6 W/kg

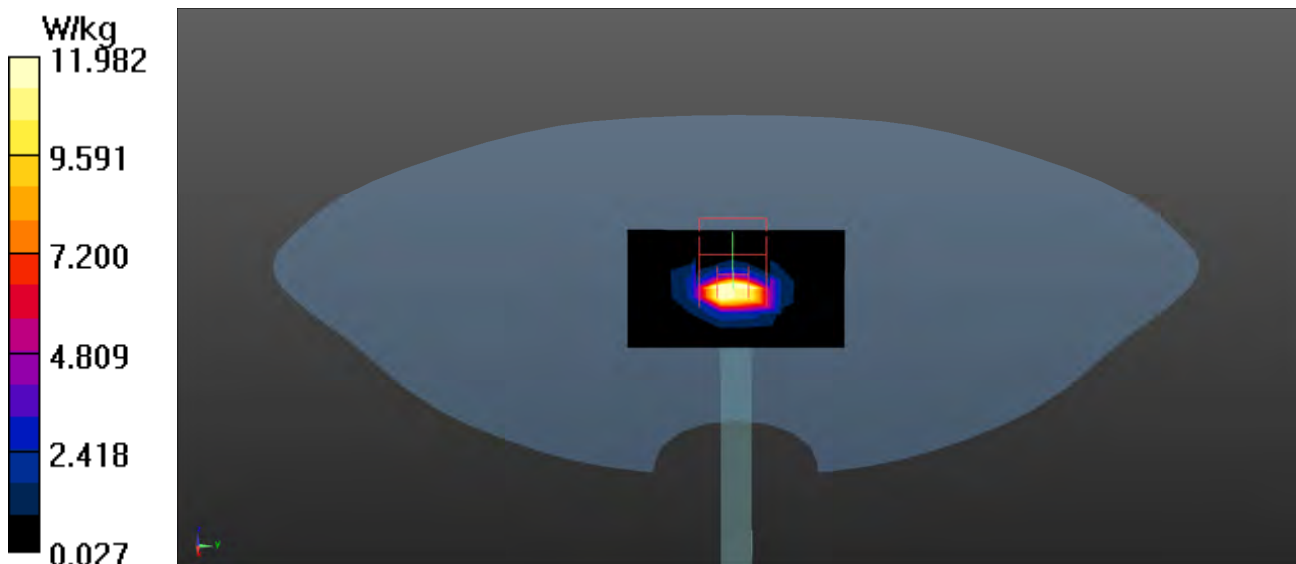

Test Laboratory: DEKRA

Date: 2022/03/16

System Performance Check_5600MHz-Head**DUT: Dipole 5GHz; Type: D5GHzV2**

Communication System: UID 0, CW (0); Frequency: 5600 MHz;

Communication System PAR: 0 dB

Medium parameters used: $f = 5600$ MHz; $\sigma = 5.11$ S/m; $\epsilon_r = 35.26$; $\rho = 1000$ kg/m³

Phantom section: Flat Section

Ambient Temperature (°C) : 23.1, Liquid Temperature (°C) : 22.3

Measurement Standard: DASYS (IEEE/IEC/ANSI C63.19-2011)

DASY5 Configuration:

- Probe: EX3DV4 - SN3698; ConvF(4.35, 4.35, 4.35); Calibrated: 2021/11/24;
- Sensor-Surface: 1.4mm (Mechanical Surface Detection)
- Electronics: DAE4 Sn1207; Calibrated: 2021/11/22
- Phantom: SAM with right table; Type: SAM;
- Measurement SW: DASYS2, Version 52.10 (0); SEMCAD X Version 14.6.10 (7417)

Configuration/5600MHz-Head/Area Scan (8x8x1): Measurement grid: dx=10mm, dy=10mm

Maximum value of SAR (measured) = 14.3 W/kg

Configuration/5600MHz-Head/Zoom Scan (7x7x7)/Cube 0: Measurement grid: dx=4mm, dy=4mm, dz=1.4mm

Reference Value = 67.13 V/m; Power Drift = -0.06 dB

Peak SAR (extrapolated) = 32.4 W/kg

SAR(1 g) = 8.57 W/kg; SAR(10 g) = 2.51 W/kg

Maximum value of SAR (measured) = 24.5 W/kg

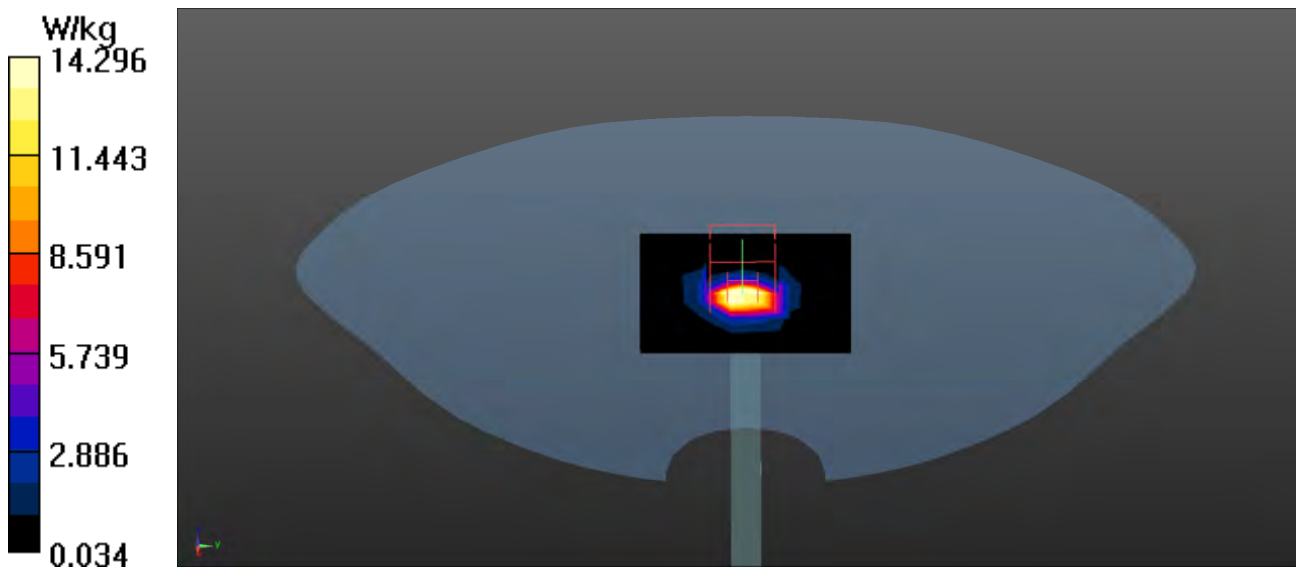

Test Laboratory: DEKRA

Date: 2022/03/16

System Performance Check_5800MHz-Head**DUT: Dipole 5GHz; Type: D5GHzV2**

Communication System: UID 0, CW; Frequency: 5800 MHz;

Communication System PAR: 0 dB

Medium parameters used: $f = 5800$ MHz; $\sigma = 5.37$ S/m; $\epsilon_r = 34.71$; $\rho = 1000$ kg/m³

Phantom section: Flat Section

Ambient Temperature (°C) : 23.1, Liquid Temperature (°C) : 22.3

Measurement Standard: DASYS (IEEE/IEC/ANSI C63.19-2011)

DASY5 Configuration:

- Probe: EX3DV4 - SN3698; ConvF(4.58, 4.58, 4.58); Calibrated: 2021/11/24;
- Sensor-Surface: 1.4mm (Mechanical Surface Detection)
- Electronics: DAE4 Sn1207; Calibrated: 2021/11/22
- Phantom: SAM with left table; Type: SAM;
- Measurement SW: DASYS2, Version 52.10 (0); SEMCAD X Version 14.6.10 (7417)

Configuration/5800MHz-Head/Area Scan (8x8x1): Measurement grid: dx=10mm, dy=10mm

Maximum value of SAR (measured) = 17.5 W/kg

Configuration/5800MHz-Head/Zoom Scan (7x7x7)/Cube 0: Measurement grid: dx=4mm, dy=4mm, dz=1.4mm

Reference Value = 62.85 V/m; Power Drift = 0.09 dB

Peak SAR (extrapolated) = 35.5 W/kg

SAR(1 g) = 8.37 W/kg; SAR(10 g) = 2.36 W/kg

Maximum value of SAR (measured) = 24.5 W/kg

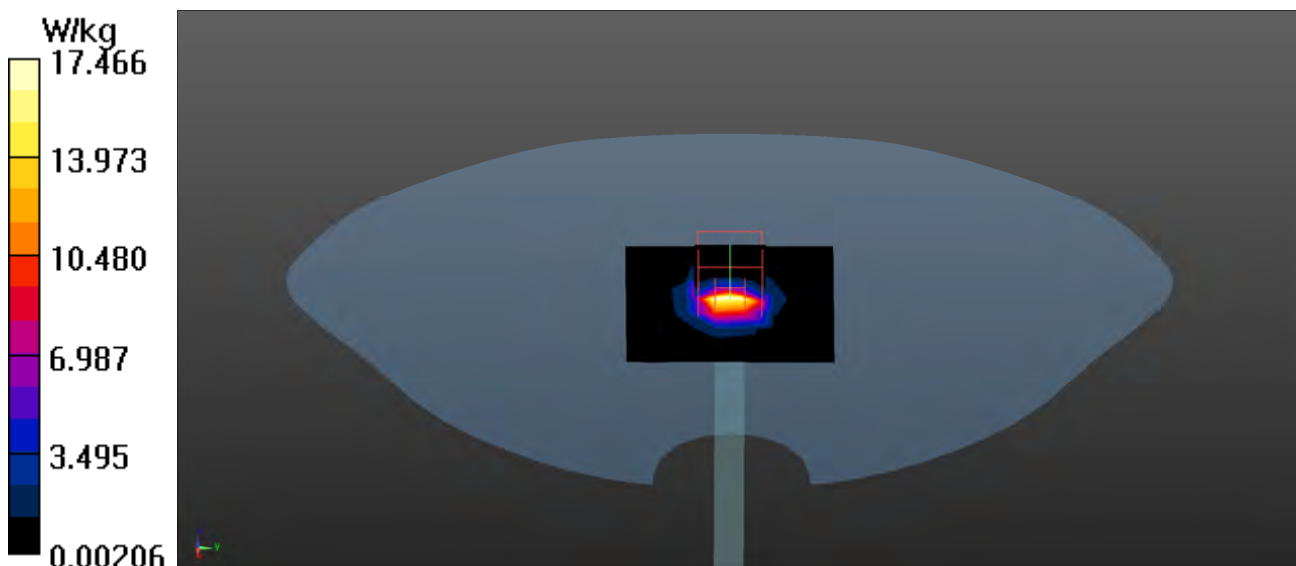

Appendix B. SAR measurement Data

Test Laboratory: DEKRA

Date: 2022/03/15

802.11b_10-Bottom Main

DUT: Notebook PC; Type: PH6AQ71

Communication System: UID 0, WLAN 2.4G; Frequency: 2457 MHz;

Communication System PAR: 0 dB

Medium parameters used: $f = 2457$ MHz; $\sigma = 1.81$ S/m; $\epsilon_r = 39.42$; $\rho = 1000$ kg/m³

Phantom section: Flat Section

Ambient Temperature (°C) : 23.4, Liquid Temperature (°C) : 22.2

Measurement Standard: DASY5 (IEEE/IEC/ANSI C63.19-2011)

DASY5 Configuration:

- Probe: EX3DV4 - SN3698; ConvF(7.19, 7.19, 7.19); Calibrated: 2021/11/24;
- Sensor-Surface: 1.4mm (Mechanical Surface Detection)
- Electronics: DAE4 Sn1207; Calibrated: 2021/11/22
- Phantom: SAM with left table; Type: SAM;
- Measurement SW: DASY52, Version 52.10 (0); SEMCAD X Version 14.6.10 (7417)

Configuration/Flat/Area Scan (7x13x1): Measurement grid: dx=12mm, dy=12mm
Maximum value of SAR (measured) = 1.54 W/kg

Configuration/Flat/Zoom Scan (7x7x7)/Cube 0: Measurement grid: dx=5mm, dy=5mm, dz=5mm
Reference Value = 8.001 V/m; Power Drift = -0.16 dB
Peak SAR (extrapolated) = 2.17 W/kg
SAR(1 g) = 1.1 W/kg; SAR(10 g) = 0.537 W/kg
Maximum value of SAR (measured) = 1.76 W/kg

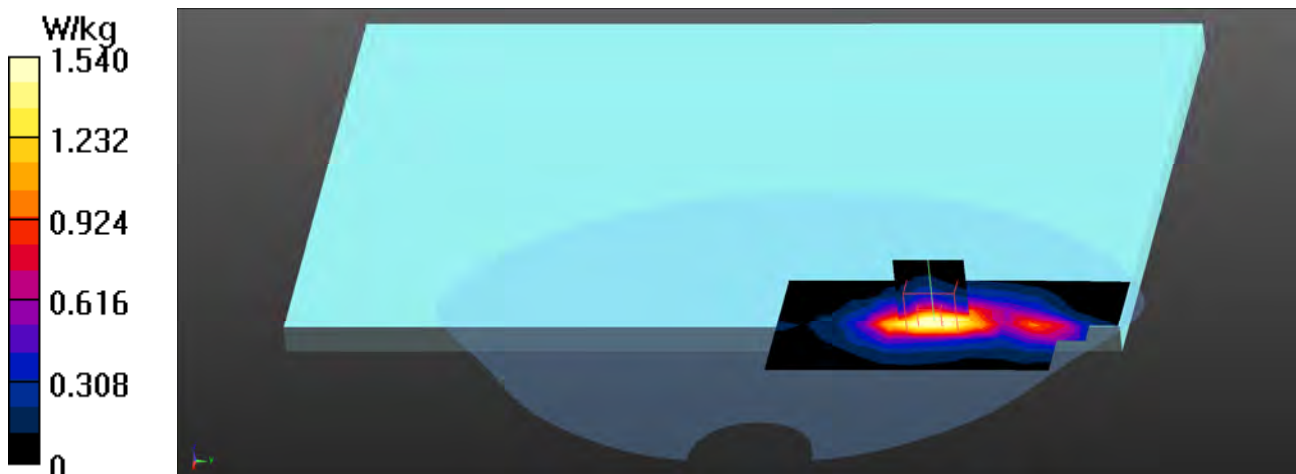

Test Laboratory: DEKRA

Date: 2022/03/15

BT-1M_39-Bottom Aux**DUT: Notebook PC; Type: PH6AQ71**

Communication System: UID 0, BT 1M&3M&BLE; Frequency: 2441 MHz;

Communication System PAR: 0 dB

Medium parameters used: $f = 2441$ MHz; $\sigma = 1.79$ S/m; $\epsilon_r = 39.48$; $\rho = 1000$ kg/m³

Phantom section: Flat Section

Ambient Temperature (°C) : 23.4, Liquid Temperature (°C) : 22.2

Measurement Standard: DASYS (IEEE/IEC/ANSI C63.19-2011)

DASY5 Configuration:

- Probe: EX3DV4 - SN3698; ConvF(7.19, 7.19, 7.19); Calibrated: 2021/11/24;
- Sensor-Surface: 1.4mm (Mechanical Surface Detection)
- Electronics: DAE4 Sn1207; Calibrated: 2021/11/22
- Phantom: SAM with left table; Type: SAM;
- Measurement SW: DASYS2, Version 52.10 (0); SEMCAD X Version 14.6.10 (7417)

Configuration/Flat/Area Scan (8x14x1): Measurement grid: dx=12mm, dy=12mm

Maximum value of SAR (measured) = 0.0857 W/kg

Configuration/Flat/Zoom Scan (7x7x7)/Cube 0: Measurement grid: dx=5mm, dy=5mm, dz=5mm

Reference Value = 6.270 V/m; Power Drift = 0.18 dB

Peak SAR (extrapolated) = 0.114 W/kg

SAR(1 g) = 0.058 W/kg; SAR(10 g) = 0.031 W/kg

Maximum value of SAR (measured) = 0.0893 W/kg

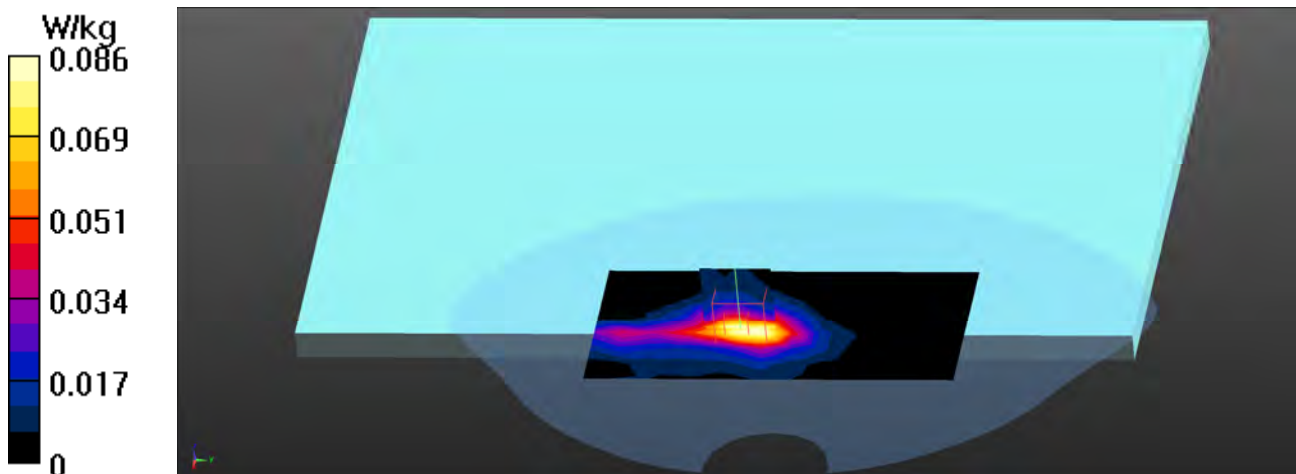

802.11b EUT Bottom (Main Antenna) Z-Axis plot

Channel: 10

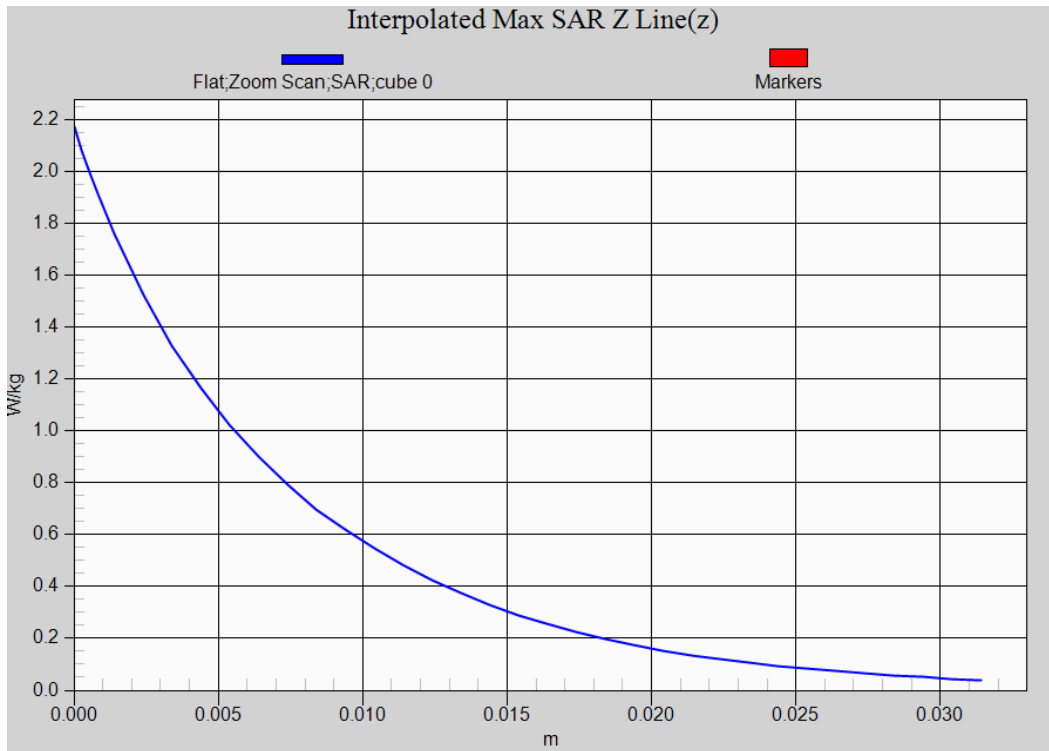

Test Laboratory: DEKRA

Date: 2022/03/16

802.11ac80M_122-Bottom Main**DUT: Notebook PC; Type: PH6AQ71**

Communication System: UID 0, WLAN 5G; Frequency: 5610 MHz;

Communication System PAR: 0 dB

Medium parameters used: $f = 5610$ MHz; $\sigma = 5.13$ S/m; $\epsilon_r = 35.24$; $\rho = 1000$ kg/m³

Phantom section: Flat Section

Ambient Temperature (°C) : 23.1, Liquid Temperature (°C) : 22.3

Measurement Standard: DASYS (IEEE/IEC/ANSI C63.19-2011)

DASY5 Configuration:

- Probe: EX3DV4 - SN3698; ConvF(4.35, 4.35, 4.35); Calibrated: 2021/11/24;
- Sensor-Surface: 1.4mm (Mechanical Surface Detection)
- Electronics: DAE4 Sn1207; Calibrated: 2021/11/22
- Phantom: SAM with right table; Type: SAM;
- Measurement SW: DASY52, Version 52.10 (0); SEMCAD X Version 14.6.10 (7417)

Configuration/Flat/Area Scan (9x15x1): Measurement grid: dx=10mm, dy=10mm

Maximum value of SAR (measured) = 1.86 W/kg

Configuration/Flat/Zoom Scan (7x7x7)/Cube 0: Measurement grid: dx=4mm, dy=4mm, dz=1.4mm

Reference Value = 2.640 V/m; Power Drift = -0.07 dB

Peak SAR (extrapolated) = 4.02 W/kg

SAR(1 g) = 0.941 W/kg; SAR(10 g) = 0.307 W/kg

Maximum value of SAR (measured) = 2.35 W/kg

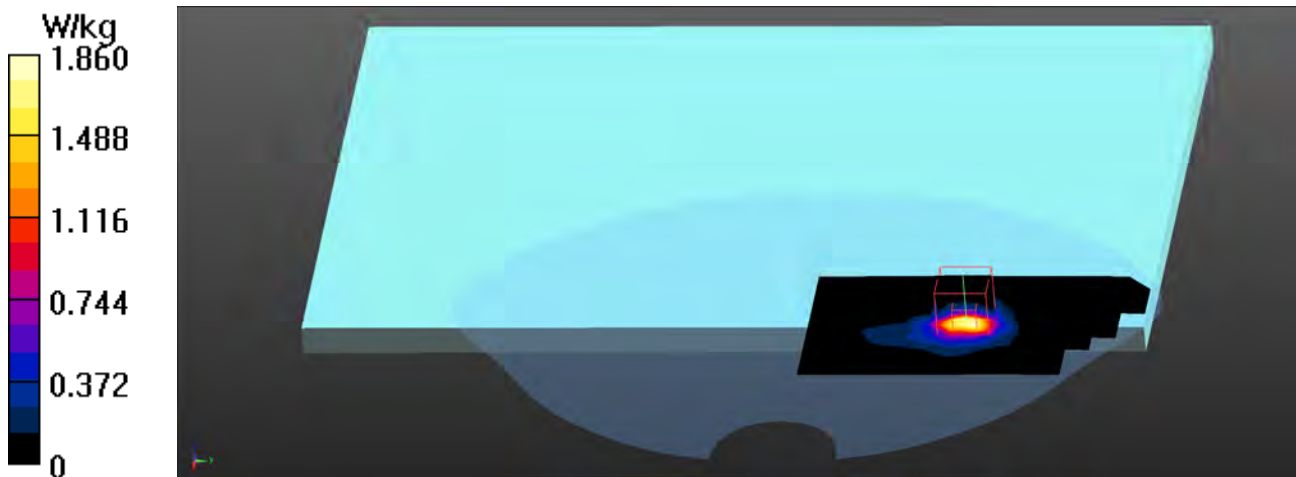

Test Laboratory: DEKRA

Date: 2022/03/16

802.11ac80M_58-Bottom Aux**DUT: Notebook PC; Type: PH6AQ71**

Communication System: UID 0, WLAN 5G; Frequency: 5290 MHz;

Communication System PAR: 0 dB

Medium parameters used: $f = 5290$ MHz; $\sigma = 4.69$ S/m; $\epsilon_r = 36.12$; $\rho = 1000$ kg/m³

Phantom section: Flat Section

Ambient Temperature (°C) : 23.1, Liquid Temperature (°C) : 22.3

Measurement Standard: DASYS (IEEE/IEC/ANSI C63.19-2011)

DASY5 Configuration:

- Probe: EX3DV4 - SN3698; ConvF(4.7, 4.7, 4.7); Calibrated: 2021/11/24;
- Sensor-Surface: 1.4mm (Mechanical Surface Detection)
- Electronics: DAE4 Sn1207; Calibrated: 2021/11/22
- Phantom: SAM with right table; Type: SAM;
- Measurement SW: DASY52, Version 52.10 (0); SEMCAD X Version 14.6.10 (7417)

Configuration/Flat/Area Scan (9x14x1): Measurement grid: dx=10mm, dy=10mm

Maximum value of SAR (measured) = 1.14 W/kg

Configuration/Flat/Zoom Scan (7x7x7)/Cube 0: Measurement grid: dx=4mm, dy=4mm, dz=1.4mm

Reference Value = 15.85 V/m; Power Drift = -0.16 dB

Peak SAR (extrapolated) = 2.38 W/kg

SAR(1 g) = 0.621 W/kg; SAR(10 g) = 0.215 W/kg

Maximum value of SAR (measured) = 1.41 W/kg

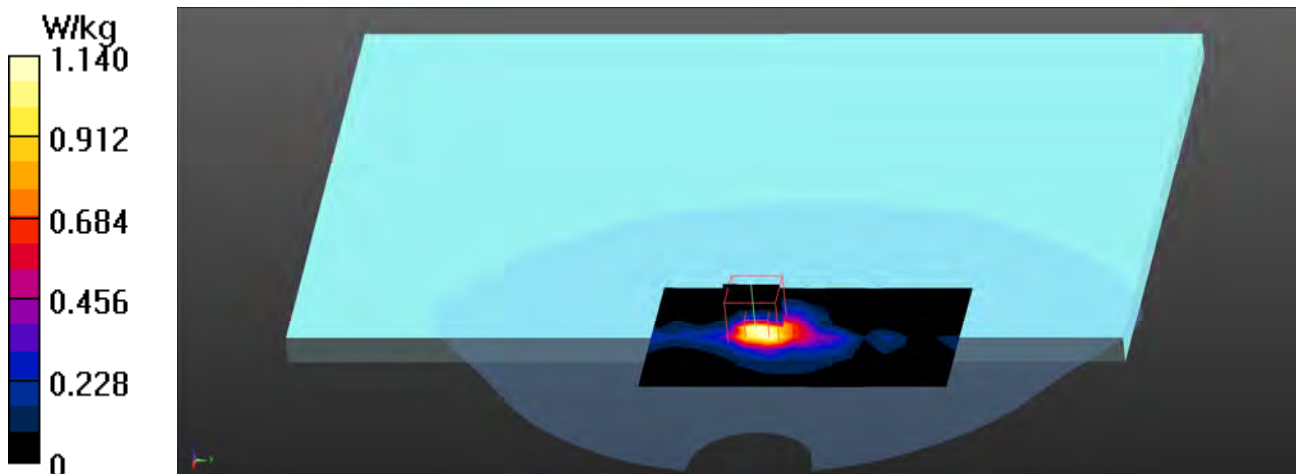

Test Laboratory: DEKRA

Date: 2022/03/16

802.11ac80M_155-Bottom Aux**DUT: Notebook PC; Type: PH6AQ71**

Communication System: UID 0, WLAN 5G; Frequency: 5775 MHz;

Communication System PAR: 0 dB

Medium parameters used: $f = 5775$ MHz; $\sigma = 5.34$ S/m; $\epsilon_r = 34.78$; $\rho = 1000$ kg/m³

Phantom section: Flat Section

Ambient Temperature (°C) : 23.1, Liquid Temperature (°C) : 22.3

Measurement Standard: DASYS (IEEE/IEC/ANSI C63.19-2011)

DASY5 Configuration:

- Probe: EX3DV4 - SN3698; ConvF(4.58, 4.58, 4.58); Calibrated: 2021/11/24;
- Sensor-Surface: 1.4mm (Mechanical Surface Detection)
- Electronics: DAE4 Sn1207; Calibrated: 2021/11/22
- Phantom: SAM with right table; Type: SAM;
- Measurement SW: DASYS2, Version 52.10 (0); SEMCAD X Version 14.6.10 (7417)

Configuration/Flat/Area Scan (9x14x1): Measurement grid: dx=10mm, dy=10mm

Maximum value of SAR (measured) = 1.78 W/kg

Configuration/Flat/Zoom Scan (7x7x7)/Cube 0: Measurement grid: dx=4mm, dy=4mm, dz=1.4mm

Reference Value = 11.96 V/m; Power Drift = -0.04 dB

Peak SAR (extrapolated) = 3.42 W/kg

SAR(1 g) = 0.742 W/kg; SAR(10 g) = 0.237 W/kg

Maximum value of SAR (measured) = 1.89 W/kg

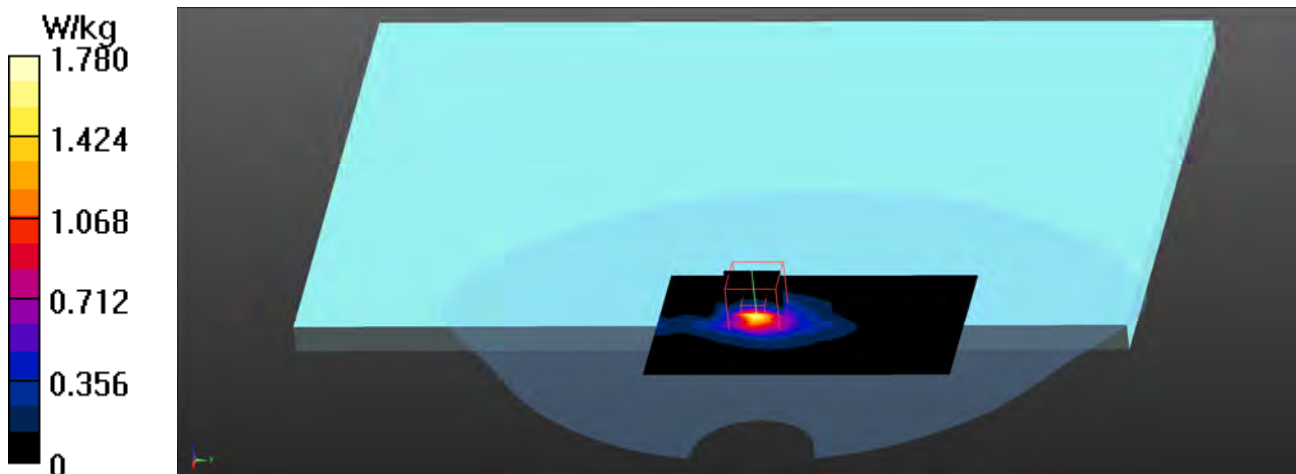

802.11ac80M Bottom (Main Antenna), Z-Axis plot

Channel: 122

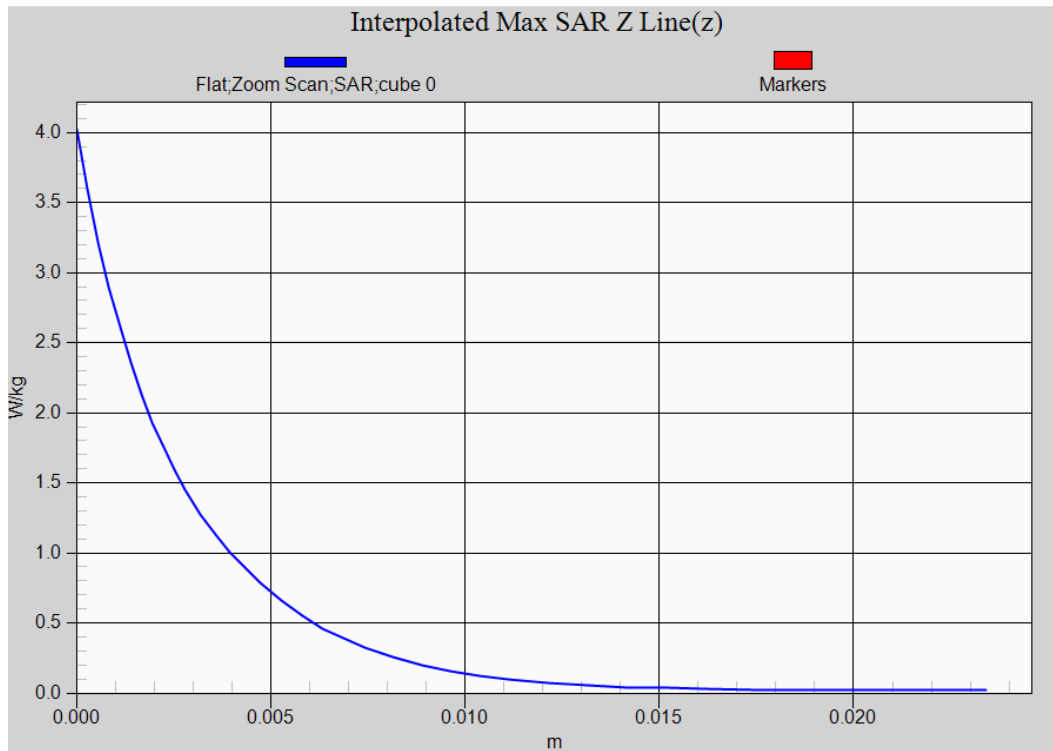

SAR measurement variability

Test Laboratory: DEKRA

Date: 2022/03/15

802.11b_10-Bottom Main_Verify

DUT: Notebook PC; Type: PH6AQ71

Communication System: UID 0, WLAN 2.4G; Frequency: 2457 MHz;

Communication System PAR: 0 dB

Medium parameters used: $f = 2457$ MHz; $\sigma = 1.81$ S/m; $\epsilon_r = 39.42$; $\rho = 1000$ kg/m³

Phantom section: Flat Section

Ambient Temperature (°C) : 23.4, Liquid Temperature (°C) : 22.2

Measurement Standard: DASY5 (IEEE/IEC/ANSI C63.19-2011)

DASY5 Configuration:

- Probe: EX3DV4 - SN3698; ConvF(7.19, 7.19, 7.19); Calibrated: 2021/11/24;
- Sensor-Surface: 1.4mm (Mechanical Surface Detection)
- Electronics: DAE4 Sn1207; Calibrated: 2021/11/22
- Phantom: SAM with left table; Type: SAM;
- Measurement SW: DASY52, Version 52.10 (0); SEMCAD X Version 14.6.10 (7417)

Configuration/Flat/Area Scan (7x13x1): Measurement grid: dx=12mm, dy=12mm

Maximum value of SAR (measured) = 1.59 W/kg

Configuration/Flat/Zoom Scan (7x7x7)/Cube 0: Measurement grid: dx=5mm, dy=5mm, dz=5mm

Reference Value = 7.504 V/m; Power Drift = -0.12 dB

Peak SAR (extrapolated) = 2.12 W/kg

SAR(1 g) = 1.09 W/kg; SAR(10 g) = 0.528 W/kg

Maximum value of SAR (measured) = 1.73 W/kg

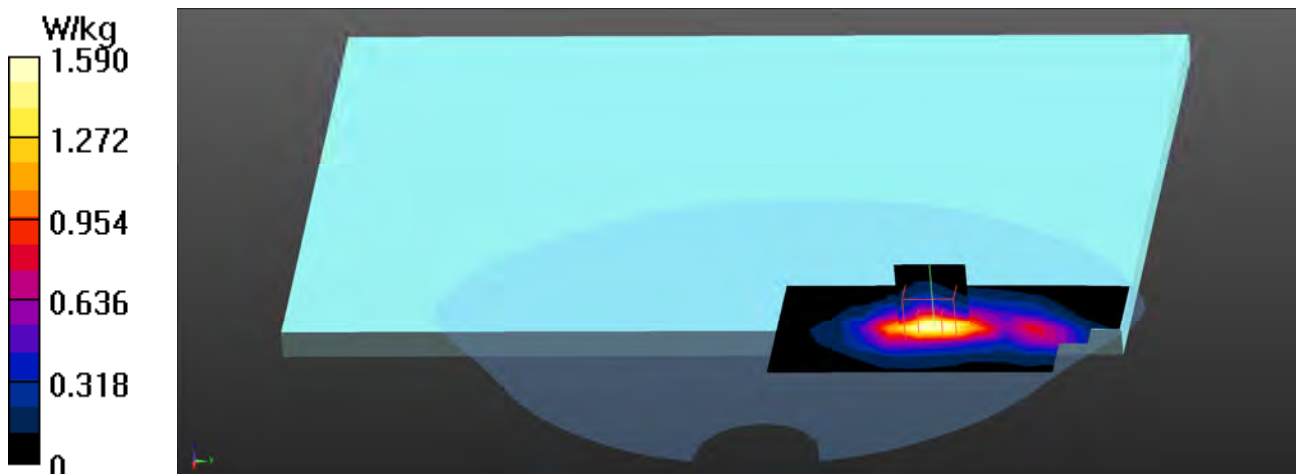

Test Laboratory: DEKRA

Date: 2022/03/16

802.11ac80M_122-Bottom Main_Verify**DUT: Notebook PC; Type: PH6AQ71**

Communication System: UID 0, WLAN 5G; Frequency: 5610 MHz;

Communication System PAR: 0 dB

Medium parameters used: $f = 5610$ MHz; $\sigma = 5.13$ S/m; $\epsilon_r = 35.24$; $\rho = 1000$ kg/m³

Phantom section: Flat Section

Ambient Temperature (°C) : 23.1, Liquid Temperature (°C) : 22.3

Measurement Standard: DASYS (IEEE/IEC/ANSI C63.19-2011)

DASY5 Configuration:

- Probe: EX3DV4 - SN3698; ConvF(4.35, 4.35, 4.35); Calibrated: 2021/11/24;
- Sensor-Surface: 1.4mm (Mechanical Surface Detection)
- Electronics: DAE4 Sn1207; Calibrated: 2021/11/22
- Phantom: SAM with right table; Type: SAM;
- Measurement SW: DASYS2, Version 52.10 (0); SEMCAD X Version 14.6.10 (7417)

Configuration/Flat/Area Scan (9x15x1): Measurement grid: dx=10mm, dy=10mm

Maximum value of SAR (measured) = 1.52 W/kg

Configuration/Flat/Zoom Scan (7x7x7)/Cube 0: Measurement grid: dx=4mm, dy=4mm, dz=1.4mm

Reference Value = 2.883 V/m; Power Drift = 0.16 dB

Peak SAR (extrapolated) = 3.66 W/kg

SAR(1 g) = 0.848 W/kg; SAR(10 g) = 0.273 W/kg

Maximum value of SAR (measured) = 2.09 W/kg

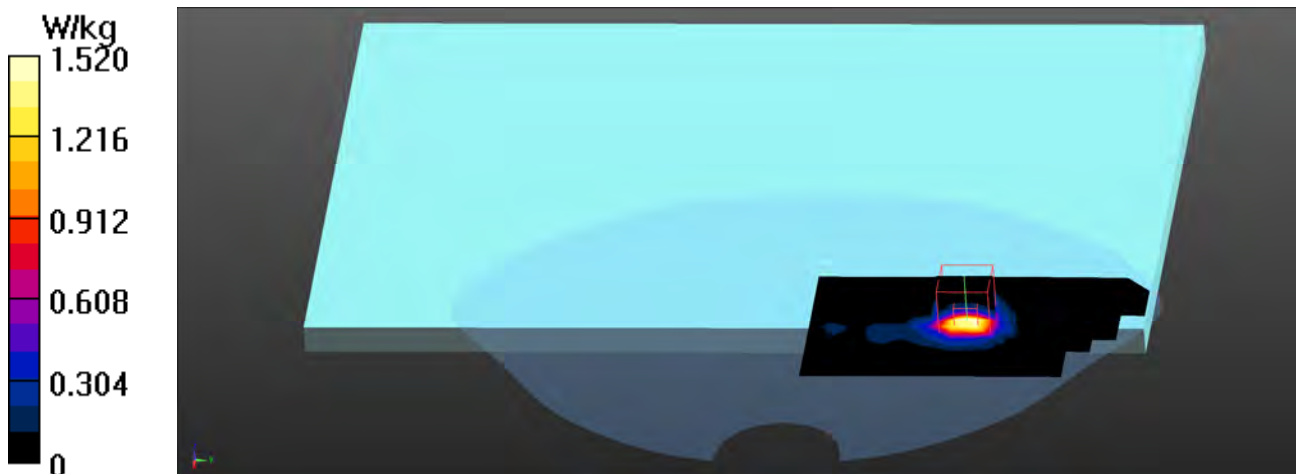



Appendix D. Probe Calibration



Accredited by the Swiss Accreditation Service (SAS)
The Swiss Accreditation Service is one of the signatories to the EA
Multilateral Agreement for the recognition of calibration certificates

Accreditation No.: **SCS 0108**

Client **DEKRA (Auden)**

Certificate No: **EX3-3698_Nov21**

CALIBRATION CERTIFICATE

Object: **EX3DV4 - SN:3698**

Calibration procedure(s): **QA CAL-01.v9, QA CAL-12.v9, QA CAL-14.v6, QA CAL-23.v5,
QA CAL-25.v7
Calibration procedure for dosimetric E-field probes**

Calibration date: **November 24, 2021**

This calibration certificate documents the traceability to national standards, which realize the physical units of measurements (SI).
The measurements and the uncertainties with confidence probability are given on the following pages and are part of the certificate.

All calibrations have been conducted in the closed laboratory facility: environment temperature (22 ± 3)°C and humidity < 70%.

Calibration Equipment used (M&TE critical for calibration)

Primary Standards	ID	Cal Date (Certificate No.)	Scheduled Calibration
Power meter NRP	SN: 104778	09-Apr-21 (No. 217-03291/03292)	Apr-22
Power sensor NRP-Z91	SN: 103244	09-Apr-21 (No. 217-03291)	Apr-22
Power sensor NRP-Z91	SN: 103245	09-Apr-21 (No. 217-03292)	Apr-22
Reference 20 dB Attenuator	SN: CC2552 (20x)	09-Apr-21 (No. 217-03343)	Apr-22
DAE4	SN: 660	23-Dec-20 (No. DAE4-660_Dec20)	Dec-21
Reference Probe ES3DV2	SN: 3013	30-Dec-20 (No. ES3-3013_Dec20)	Dec-21
Secondary Standards	ID	Check Date (in house)	Scheduled Check
Power meter E4419B	SN: GB41293874	06-Apr-16 (in house check Jun-20)	In house check: Jun-22
Power sensor E4412A	SN: MY41498087	06-Apr-16 (in house check Jun-20)	In house check: Jun-22
Power sensor E4412A	SN: 000110210	06-Apr-16 (in house check Jun-20)	In house check: Jun-22
RF generator HP 8648C	SN: US3642U01700	04-Aug-99 (in house check Jun-20)	In house check: Jun-22
Network Analyzer E8358A	SN: US41080477	31-Mar-14 (in house check Oct-20)	In house check: Oct-22

	Name	Function	Signature
Calibrated by:	Jeton Kastrati	Laboratory Technician	
Approved by:	Niels Kuster	Quality Manager	

Issued: November 26, 2021

This calibration certificate shall not be reproduced except in full without written approval of the laboratory.



Accredited by the Swiss Accreditation Service (SAS)

Accreditation No.: **SCS 0108**

The Swiss Accreditation Service is one of the signatories to the EA
Multilateral Agreement for the recognition of calibration certificates

Glossary:

TSL	tissue simulating liquid
NORM _{x,y,z}	sensitivity in free space
ConvF	sensitivity in TSL / NORM _{x,y,z}
DCP	diode compression point
CF	crest factor (1/duty_cycle) of the RF signal
A, B, C, D	modulation dependent linearization parameters
Polarization φ	φ rotation around probe axis
Polarization ϑ	ϑ rotation around an axis that is in the plane normal to probe axis (at measurement center), i.e., $\vartheta = 0$ is normal to probe axis
Connector Angle	information used in DASY system to align probe sensor X to the robot coordinate system

Calibration is Performed According to the Following Standards:

- IEC/IEEE 62209-1528, "Measurement Procedure For The Assessment Of Specific Absorption Rate Of Human Exposure To Radio Frequency Fields From Hand-Held And Body-Worn Wireless Communication Devices - Part 1528: Human Models, Instrumentation And Procedures (Frequency Range of 4 MHz to 10 GHz)", October 2020.
- KDB 865664, "SAR Measurement Requirements for 100 MHz to 6 GHz"

Methods Applied and Interpretation of Parameters:

- NORM_{x,y,z}**: Assessed for E-field polarization $\vartheta = 0$ ($f \leq 900$ MHz in TEM-cell; $f > 1800$ MHz: R22 waveguide). NORM_{x,y,z} are only intermediate values, i.e., the uncertainties of NORM_{x,y,z} does not affect the E²-field uncertainty inside TSL (see below *ConvF*).
- NORM(f)_{x,y,z}** = NORM_{x,y,z} * *frequency_response* (see Frequency Response Chart). This linearization is implemented in DASY4 software versions later than 4.2. The uncertainty of the frequency response is included in the stated uncertainty of *ConvF*.
- DCP_{x,y,z}**: DCP are numerical linearization parameters assessed based on the data of power sweep with CW signal (no uncertainty required). DCP does not depend on frequency nor media.
- PAR**: PAR is the Peak to Average Ratio that is not calibrated but determined based on the signal characteristics
- A_{x,y,z}; B_{x,y,z}; C_{x,y,z}; D_{x,y,z}; VR_{x,y,z}**: A, B, C, D are numerical linearization parameters assessed based on the data of power sweep for specific modulation signal. The parameters do not depend on frequency nor media. VR is the maximum calibration range expressed in RMS voltage across the diode.
- ConvF and Boundary Effect Parameters**: Assessed in flat phantom using E-field (or Temperature Transfer Standard for $f \leq 800$ MHz) and inside waveguide using analytical field distributions based on power measurements for $f > 800$ MHz. The same setups are used for assessment of the parameters applied for boundary compensation (alpha, depth) of which typical uncertainty values are given. These parameters are used in DASY4 software to improve probe accuracy close to the boundary. The sensitivity in TSL corresponds to NORM_{x,y,z} * *ConvF* whereby the uncertainty corresponds to that given for *ConvF*. A frequency dependent *ConvF* is used in DASY version 4.4 and higher which allows extending the validity from ± 50 MHz to ± 100 MHz.
- Spherical isotropy (3D deviation from isotropy)**: in a field of low gradients realized using a flat phantom exposed by a patch antenna.
- Sensor Offset**: The sensor offset corresponds to the offset of virtual measurement center from the probe tip (on probe axis). No tolerance required.
- Connector Angle**: The angle is assessed using the information gained by determining the NORM_x (no uncertainty required).

DASY/EASY - Parameters of Probe: EX3DV4 - SN:3698

Basic Calibration Parameters

	Sensor X	Sensor Y	Sensor Z	Unc (k=2)
Norm ($\mu\text{V}/(\text{V}/\text{m})^2$) ^A	0.41	0.34	0.37	$\pm 10.1 \%$
DCP (mV) ^B	105.0	101.0	105.0	

Calibration Results for Modulation Response

UID	Communication System Name		A dB	B dB $\sqrt{\mu\text{V}}$	C	D dB	VR mV	Max dev.	Unc ^E (k=2)
0	CW	X	0.0	0.0	1.0	0.00	147.1	$\pm 3.3 \%$	$\pm 4.7 \%$
		Y	0.0	0.0	1.0		129.5		
		Z	0.0	0.0	1.0		141.3		

The reported uncertainty of measurement is stated as the standard uncertainty of measurement multiplied by the coverage factor $k=2$, which for a normal distribution corresponds to a coverage probability of approximately 95%.

^A The uncertainties of Norm X,Y,Z do not affect the E^2 -field uncertainty inside TSL (see Page 5).

^B Numerical linearization parameter: uncertainty not required.

^E Uncertainty is determined using the max. deviation from linear response applying rectangular distribution and is expressed for the square of the field value.

DASY/EASY - Parameters of Probe: EX3DV4 - SN:3698

Other Probe Parameters

Sensor Arrangement	Triangular
Connector Angle (°)	-137
Mechanical Surface Detection Mode	enabled
Optical Surface Detection Mode	disabled
Probe Overall Length	337 mm
Probe Body Diameter	10 mm
Tip Length	9 mm
Tip Diameter	2.5 mm
Probe Tip to Sensor X Calibration Point	1 mm
Probe Tip to Sensor Y Calibration Point	1 mm
Probe Tip to Sensor Z Calibration Point	1 mm
Recommended Measurement Distance from Surface	1.4 mm

Note: Measurement distance from surface can be increased to 3-4 mm for an *Area Scan* job.

DASY/EASY - Parameters of Probe: EX3DV4 - SN:3698

Calibration Parameter Determined in Head Tissue Simulating Media

f (MHz) ^c	Relative Permittivity ^F	Conductivity (S/m) ^F	ConvF X	ConvF Y	ConvF Z	Alpha ^G	Depth ^G (mm)	Unc (k=2)
450	43.5	0.87	9.73	9.73	9.73	0.16	1.30	± 13.3 %
750	41.9	0.89	9.10	9.10	9.10	0.46	0.80	± 12.0 %
835	41.5	0.90	8.90	8.90	8.90	0.38	0.96	± 12.0 %
900	41.5	0.97	8.81	8.81	8.81	0.47	0.80	± 12.0 %
1450	40.5	1.20	8.18	8.18	8.18	0.58	0.80	± 12.0 %
1640	40.2	1.31	8.08	8.08	8.08	0.30	0.86	± 12.0 %
1750	40.1	1.37	7.96	7.96	7.96	0.28	0.86	± 12.0 %
1950	40.0	1.40	7.60	7.60	7.60	0.39	0.86	± 12.0 %
2300	39.5	1.67	7.39	7.39	7.39	0.33	0.90	± 12.0 %
2450	39.2	1.80	7.19	7.19	7.19	0.27	0.90	± 12.0 %
2600	39.0	1.96	6.97	6.97	6.97	0.36	0.90	± 12.0 %
3300	38.2	2.71	6.65	6.65	6.65	0.30	1.35	± 13.1 %
3500	37.9	2.91	6.30	6.30	6.30	0.35	1.30	± 13.1 %
3700	37.7	3.12	6.15	6.15	6.15	0.35	1.30	± 13.1 %
5250	35.9	4.71	4.70	4.70	4.70	0.40	1.80	± 13.1 %
5600	35.5	5.07	4.35	4.35	4.35	0.40	1.80	± 13.1 %
5800	35.3	5.27	4.58	4.58	4.58	0.40	1.80	± 13.1 %

^c Frequency validity above 300 MHz of ± 100 MHz only applies for DASY v4.4 and higher (see Page 2), else it is restricted to ± 50 MHz. The uncertainty is the RSS of the ConvF uncertainty at calibration frequency and the uncertainty for the indicated frequency band. Frequency validity below 300 MHz is ± 10, 25, 40, 50 and 70 MHz for ConvF assessments at 30, 64, 128, 150 and 220 MHz respectively. Validity of ConvF assessed at 6 MHz is 4-9 MHz, and ConvF assessed at 13 MHz is 9-19 MHz. Above 5 GHz frequency validity can be extended to ± 110 MHz.

^F At frequencies below 3 GHz, the validity of tissue parameters (ϵ and σ) can be relaxed to ± 10% if liquid compensation formula is applied to measured SAR values. At frequencies above 3 GHz, the validity of tissue parameters (ϵ and σ) is restricted to ± 5%. The uncertainty is the RSS of the ConvF uncertainty for indicated target tissue parameters.

^G Alpha/Depth are determined during calibration. SPEAG warrants that the remaining deviation due to the boundary effect after compensation is always less than ± 1% for frequencies below 3 GHz and below ± 2% for frequencies between 3-6 GHz at any distance larger than half the probe tip diameter from the boundary.

Frequency Response of E-Field (TEM-Cell:ifi110 EXX, Waveguide: R22)

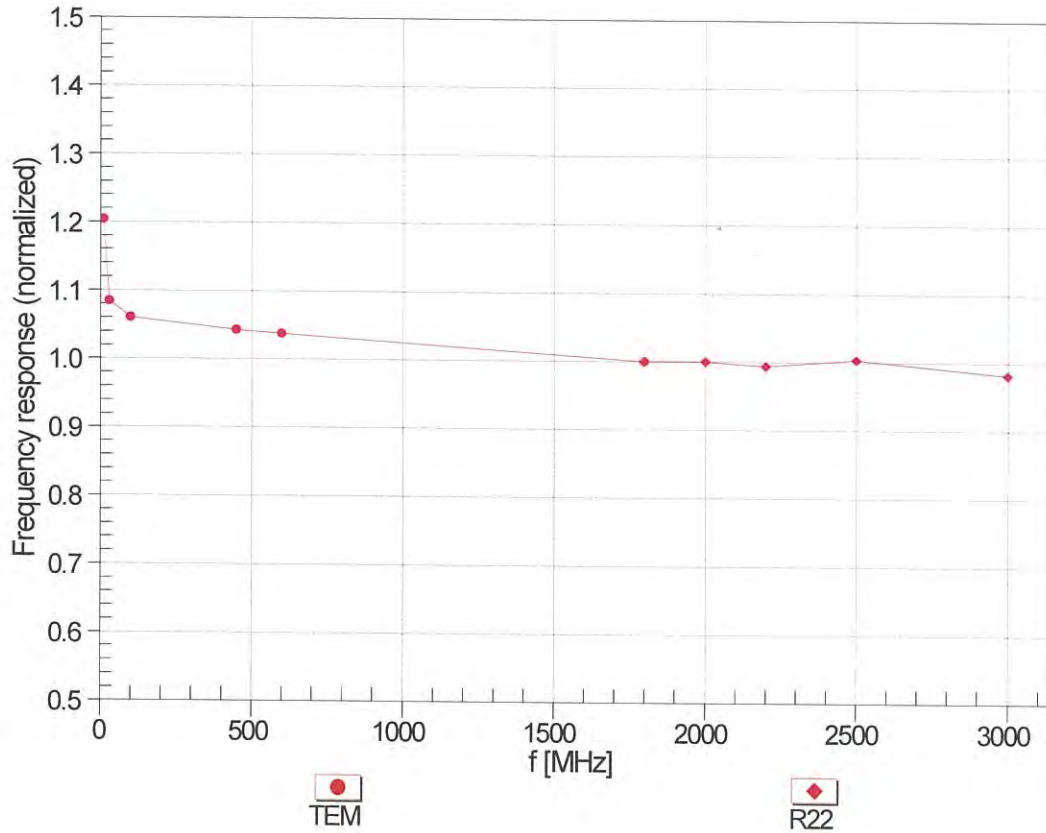

Uncertainty of Frequency Response of E-field: $\pm 6.3\%$ (k=2)

Receiving Pattern (ϕ), $\vartheta = 0^\circ$

f=600 MHz, TEM

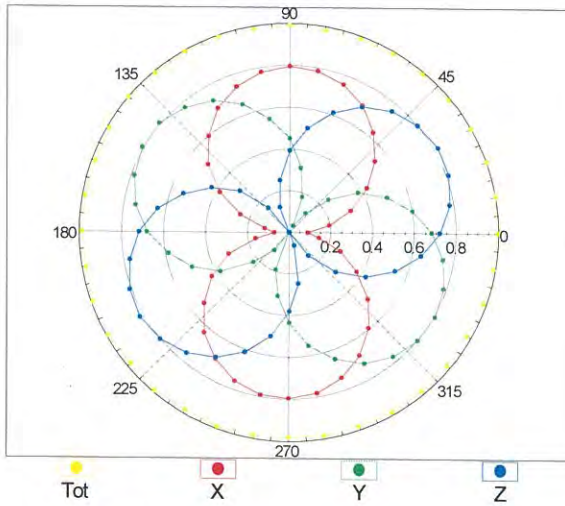

f=1800 MHz, R22

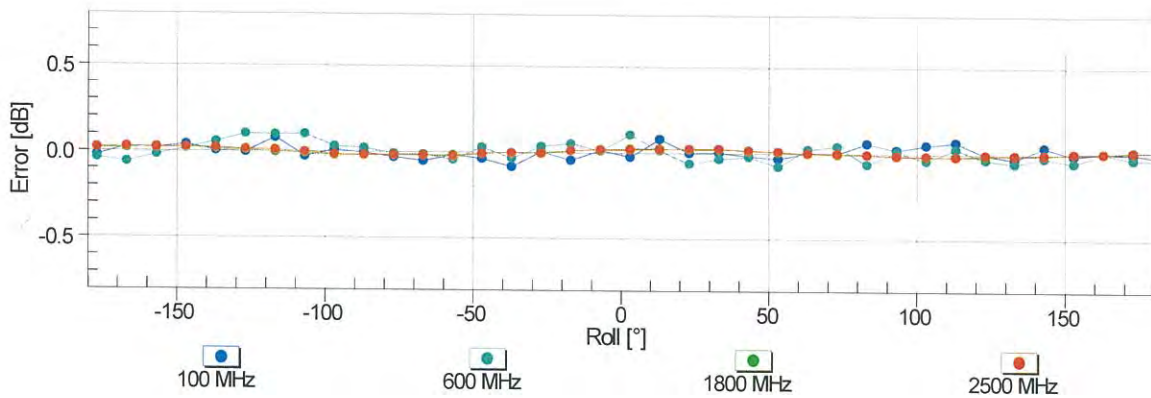
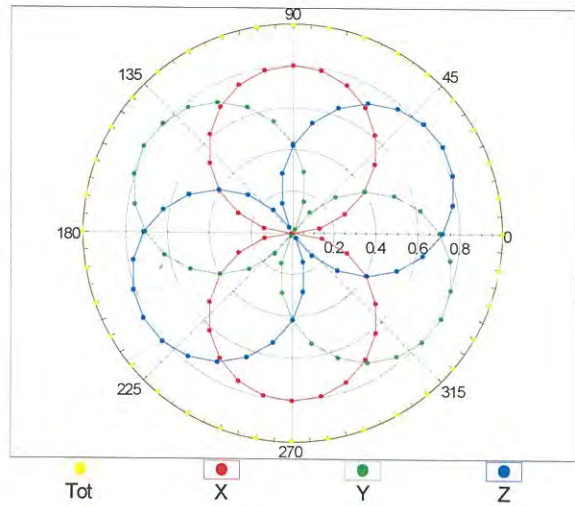

Uncertainty of Axial Isotropy Assessment: $\pm 0.5\%$ ($k=2$)

Dynamic Range f(SAR_{head}) (TEM cell , f_{eval}= 1900 MHz)

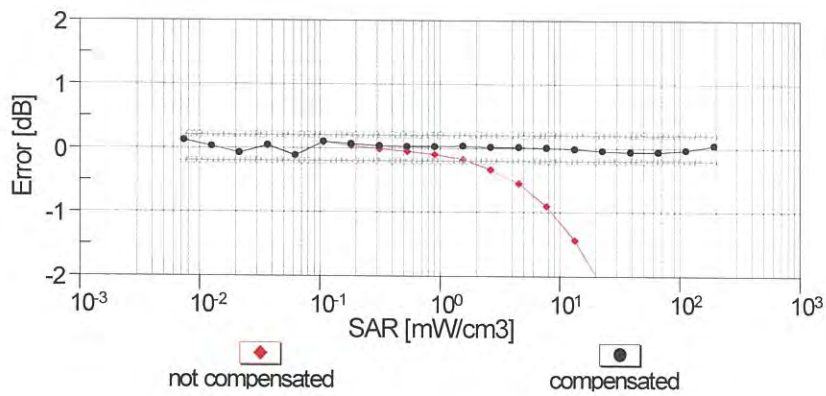
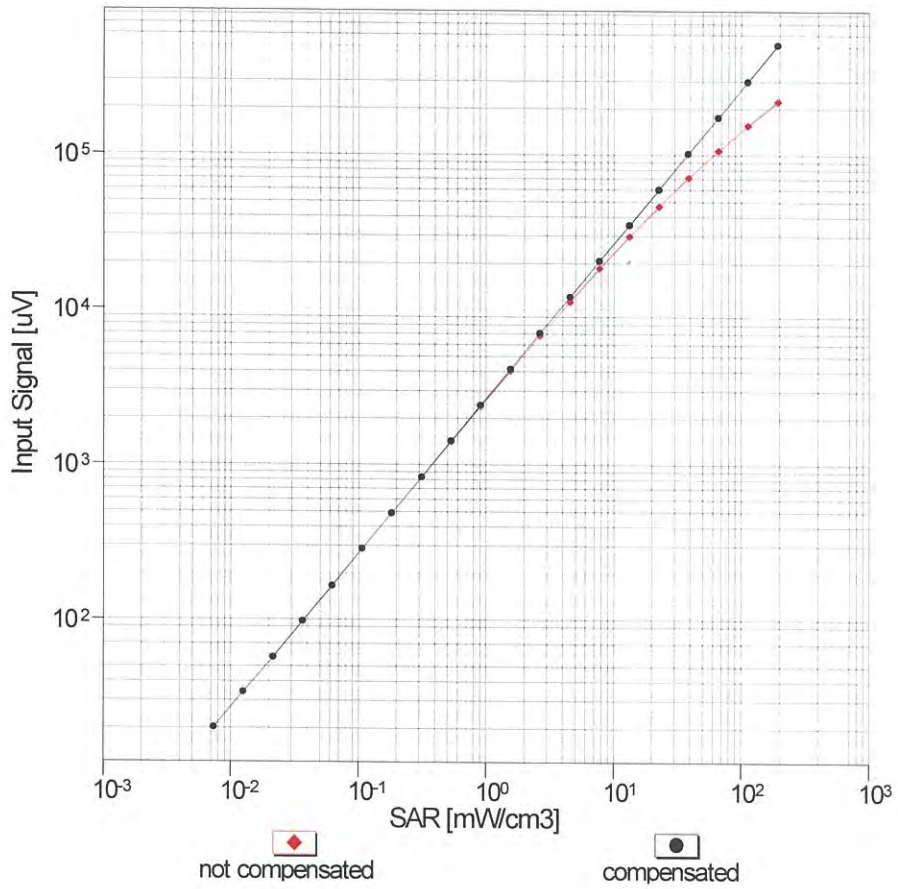

Uncertainty of Linearity Assessment: ± 0.6% (k=2)

Conversion Factor Assessment

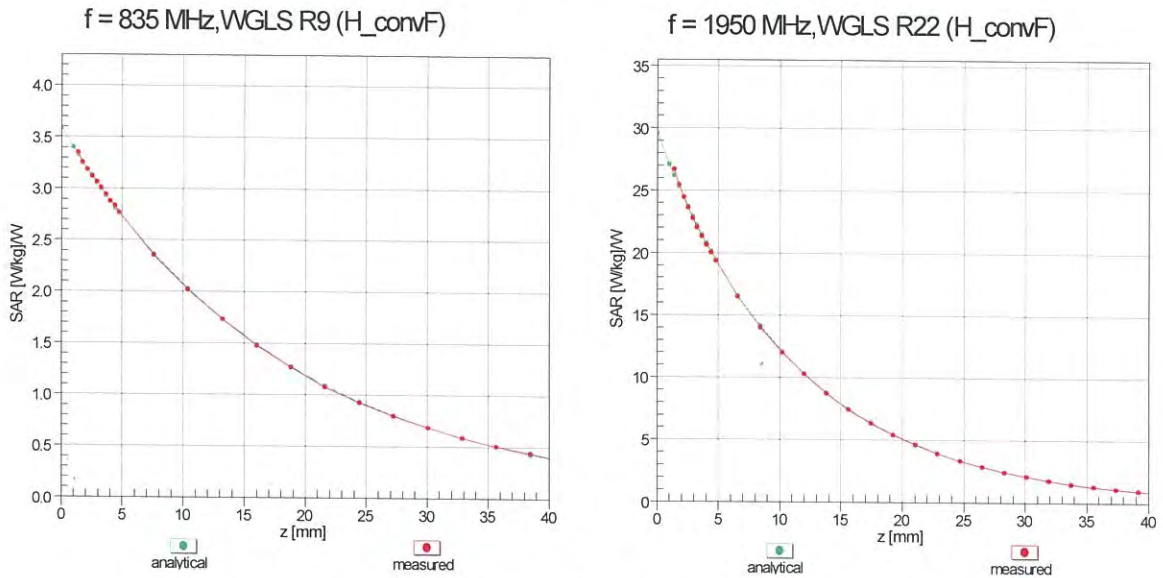

Deviation from Isotropy in Liquid Error (ϕ, θ), f = 900 MHz

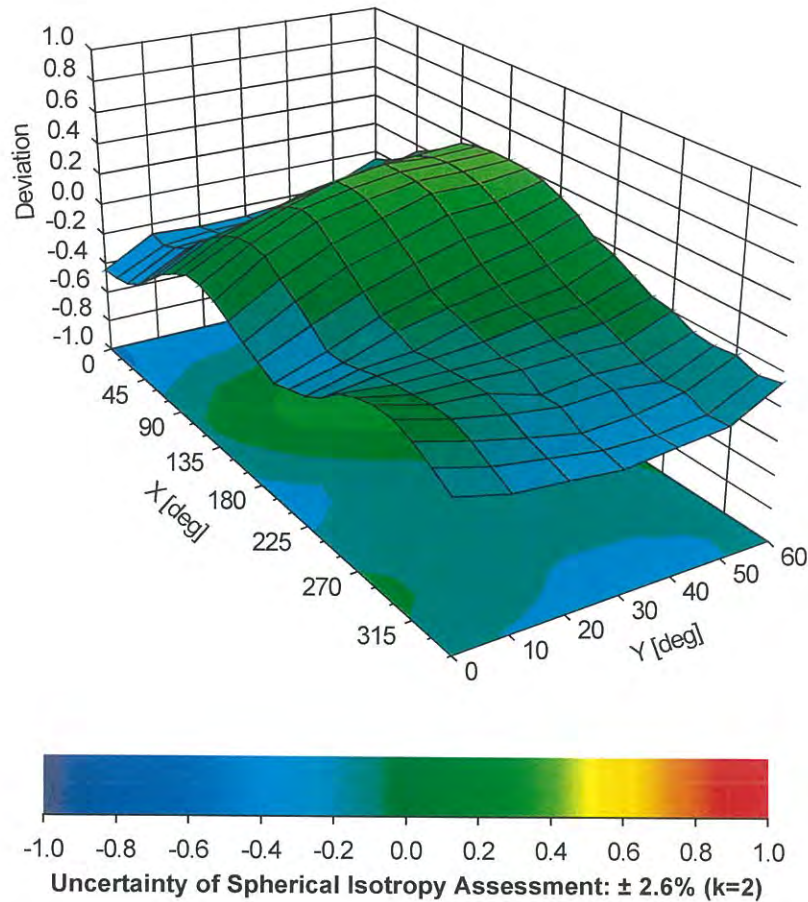



Appendix E. Dipole Calibration

139817

**Calibration Laboratory of
Schmid & Partner
Engineering AG**
Zeughausstrasse 43, 8004 Zurich, Switzerland



S Schweizerischer Kalibrierdienst
C Service suisse d'étalonnage
S Servizio svizzero di taratura
S Swiss Calibration Service

Accredited by the Swiss Accreditation Service (SAS)
The Swiss Accreditation Service is one of the signatories to the EA
Multilateral Agreement for the recognition of calibration certificates

Accreditation No.: **SCS 0108**

Client **DEKRA (Auden)**

Certificate No: **D2450V2-930_Nov19**

CALIBRATION CERTIFICATE

Object: **D2450V2 - SN:930**

Calibration procedure(s): **QA CAL-05.v11
Calibration Procedure for SAR Validation Sources between 0.7-3 GHz**

Calibration date: **November 21, 2019**

This calibration certificate documents the traceability to national standards, which realize the physical units of measurements (SI).
The measurements and the uncertainties with confidence probability are given on the following pages and are part of the certificate.

All calibrations have been conducted in the closed laboratory facility: environment temperature (22 ± 3)°C and humidity < 70%.

Calibration Equipment used (M&TE critical for calibration)

Primary Standards	ID #	Cal Date (Certificate No.)	Scheduled Calibration
Power meter NRP	SN: 104778	03-Apr-19 (No. 217-02892/02893)	Apr-20
Power sensor NRP-Z91	SN: 103244	03-Apr-19 (No. 217-02892)	Apr-20
Power sensor NRP-Z91	SN: 103245	03-Apr-19 (No. 217-02893)	Apr-20
Reference 20 dB Attenuator	SN: 5058 (20k)	04-Apr-19 (No. 217-02894)	Apr-20
Type-N mismatch combination	SN: 5047.2 / 06327	04-Apr-19 (No. 217-02895)	Apr-20
Reference Probe EX3DV4	SN: 7349	29-May-19 (No. EX3-7349_May19)	May-20
DAE4	SN: 601	30-Apr-19 (No. DAE4-601_Apr19)	Apr-20
Secondary Standards	ID #	Check Date (in house)	Scheduled Check
Power meter E4419B	SN: GB39512475	30-Oct-14 (in house check Feb-19)	In house check: Oct-20
Power sensor HP 8481A	SN: US37292783	07-Oct-15 (in house check Oct-18)	In house check: Oct-20
Power sensor HP 8481A	SN: MY41092317	07-Oct-15 (in house check Oct-18)	In house check: Oct-20
RF generator R&S SMT-06	SN: 100972	15-Jun-15 (in house check Oct-18)	In house check: Oct-20
Network Analyzer Agilent E8358A	SN: US41080477	31-Mar-14 (in house check Oct-19)	In house check: Oct-20

Calibrated by: **Claudio Leubler** (Name), **Laboratory Technician** (Function),  (Signature)

Approved by: **Katja Pokovic** (Name), **Technical Manager** (Function),  (Signature)

Issued: November 25, 2019

This calibration certificate shall not be reproduced except in full without written approval of the laboratory.



Accredited by the Swiss Accreditation Service (SAS)
The Swiss Accreditation Service is one of the signatories to the EA
Multilateral Agreement for the recognition of calibration certificates

Glossary:

TSL	tissue simulating liquid
ConvF	sensitivity in TSL / NORM x,y,z
N/A	not applicable or not measured

Calibration is Performed According to the Following Standards:

- a) IEEE Std 1528-2013, "IEEE Recommended Practice for Determining the Peak Spatial-Averaged Specific Absorption Rate (SAR) in the Human Head from Wireless Communications Devices: Measurement Techniques", June 2013
- b) IEC 62209-1, "Measurement procedure for the assessment of Specific Absorption Rate (SAR) from hand-held and body-mounted devices used next to the ear (frequency range of 300 MHz to 6 GHz)", July 2016
- c) IEC 62209-2, "Procedure to determine the Specific Absorption Rate (SAR) for wireless communication devices used in close proximity to the human body (frequency range of 30 MHz to 6 GHz)", March 2010
- d) KDB 865664, "SAR Measurement Requirements for 100 MHz to 6 GHz"

Additional Documentation:

- e) DASY4/5 System Handbook

Methods Applied and Interpretation of Parameters:

- *Measurement Conditions:* Further details are available from the Validation Report at the end of the certificate. All figures stated in the certificate are valid at the frequency indicated.
- *Antenna Parameters with TSL:* The dipole is mounted with the spacer to position its feed point exactly below the center marking of the flat phantom section, with the arms oriented parallel to the body axis.
- *Feed Point Impedance and Return Loss:* These parameters are measured with the dipole positioned under the liquid filled phantom. The impedance stated is transformed from the measurement at the SMA connector to the feed point. The Return Loss ensures low reflected power. No uncertainty required.
- *Electrical Delay:* One-way delay between the SMA connector and the antenna feed point. No uncertainty required.
- *SAR measured:* SAR measured at the stated antenna input power.
- *SAR normalized:* SAR as measured, normalized to an input power of 1 W at the antenna connector.
- *SAR for nominal TSL parameters:* The measured TSL parameters are used to calculate the nominal SAR result.

The reported uncertainty of measurement is stated as the standard uncertainty of measurement multiplied by the coverage factor $k=2$, which for a normal distribution corresponds to a coverage probability of approximately 95%.

Measurement Conditions

DASY system configuration, as far as not given on page 1.

DASY Version	DASY5	V52.10.3
Extrapolation	Advanced Extrapolation	
Phantom	Modular Flat Phantom	
Distance Dipole Center - TSL	10 mm	with Spacer
Zoom Scan Resolution	dx, dy, dz = 5 mm	
Frequency	2450 MHz \pm 1 MHz	

Head TSL parameters

The following parameters and calculations were applied.

	Temperature	Permittivity	Conductivity
Nominal Head TSL parameters	22.0 °C	39.2	1.80 mho/m
Measured Head TSL parameters	(22.0 \pm 0.2) °C	38.2 \pm 6 %	1.84 mho/m \pm 6 %
Head TSL temperature change during test	< 0.5 °C	----	----

SAR result with Head TSL

SAR averaged over 1 cm ³ (1 g) of Head TSL	Condition	
SAR measured	250 mW input power	13.5 W/kg
SAR for nominal Head TSL parameters	normalized to 1W	53.1 W/kg \pm 17.0 % (k=2)

SAR averaged over 10 cm ³ (10 g) of Head TSL	condition	
SAR measured	250 mW input power	6.22 W/kg
SAR for nominal Head TSL parameters	normalized to 1W	24.6 W/kg \pm 16.5 % (k=2)

Body TSL parameters

The following parameters and calculations were applied.

	Temperature	Permittivity	Conductivity
Nominal Body TSL parameters	22.0 °C	52.7	1.95 mho/m
Measured Body TSL parameters	(22.0 \pm 0.2) °C	50.8 \pm 6 %	2.01 mho/m \pm 6 %
Body TSL temperature change during test	< 0.5 °C	----	----

SAR result with Body TSL

SAR averaged over 1 cm ³ (1 g) of Body TSL	Condition	
SAR measured	250 mW input power	13.3 W/kg
SAR for nominal Body TSL parameters	normalized to 1W	52.0 W/kg \pm 17.0 % (k=2)

SAR averaged over 10 cm ³ (10 g) of Body TSL	condition	
SAR measured	250 mW input power	6.17 W/kg
SAR for nominal Body TSL parameters	normalized to 1W	24.3 W/kg \pm 16.5 % (k=2)

Appendix (Additional assessments outside the scope of SCS 0108)

Antenna Parameters with Head TSL

Impedance, transformed to feed point	54.4 Ω + 3.8 j Ω
Return Loss	- 25.2 dB

Antenna Parameters with Body TSL

Impedance, transformed to feed point	51.2 Ω + 5.1 j Ω
Return Loss	- 25.8 dB

General Antenna Parameters and Design

Electrical Delay (one direction)	1.158 ns
----------------------------------	----------

After long term use with 100W radiated power, only a slight warming of the dipole near the feedpoint can be measured.

The dipole is made of standard semirigid coaxial cable. The center conductor of the feeding line is directly connected to the second arm of the dipole. The antenna is therefore short-circuited for DC-signals. On some of the dipoles, small end caps are added to the dipole arms in order to improve matching when loaded according to the position as explained in the "Measurement Conditions" paragraph. The SAR data are not affected by this change. The overall dipole length is still according to the Standard.

No excessive force must be applied to the dipole arms, because they might bend or the soldered connections near the feedpoint may be damaged.

Additional EUT Data

Manufactured by	SPEAG
-----------------	-------

DASY5 Validation Report for Head TSL

Date: 21.11.2019

Test Laboratory: SPEAG, Zurich, Switzerland

DUT: Dipole 2450 MHz; Type: D2450V2; Serial: D2450V2 - SN:930

Communication System: UID 0 - CW; Frequency: 2450 MHz

Medium parameters used: $f = 2450$ MHz; $\sigma = 1.84$ S/m; $\epsilon_r = 38.2$; $\rho = 1000$ kg/m³

Phantom section: Flat Section

Measurement Standard: DASY5 (IEEE/IEC/ANSI C63.19-2011)

DASY52 Configuration:

- Probe: EX3DV4 - SN7349; ConvF(7.9, 7.9, 7.9) @ 2450 MHz; Calibrated: 29.05.2019
- Sensor-Surface: 1.4mm (Mechanical Surface Detection)
- Electronics: DAE4 Sn601; Calibrated: 30.04.2019
- Phantom: Flat Phantom 5.0 (front); Type: QD 000 P50 AA; Serial: 1001
- DASY52 52.10.3(1513); SEMCAD X 14.6.13(7474)

Dipole Calibration for Head Tissue/Pin=250 mW, d=10mm/Zoom Scan (7x7x7)/Cube 0:

Measurement grid: dx=5mm, dy=5mm, dz=5mm

Reference Value = 117.5 V/m; Power Drift = 0.07 dB

Peak SAR (extrapolated) = 26.6 W/kg

SAR(1 g) = 13.5 W/kg; SAR(10 g) = 6.22 W/kg

Smallest distance from peaks to all points 3 dB below = 9 mm

Ratio of SAR at M2 to SAR at M1 = 50.8%

Maximum value of SAR (measured) = 22.0 W/kg

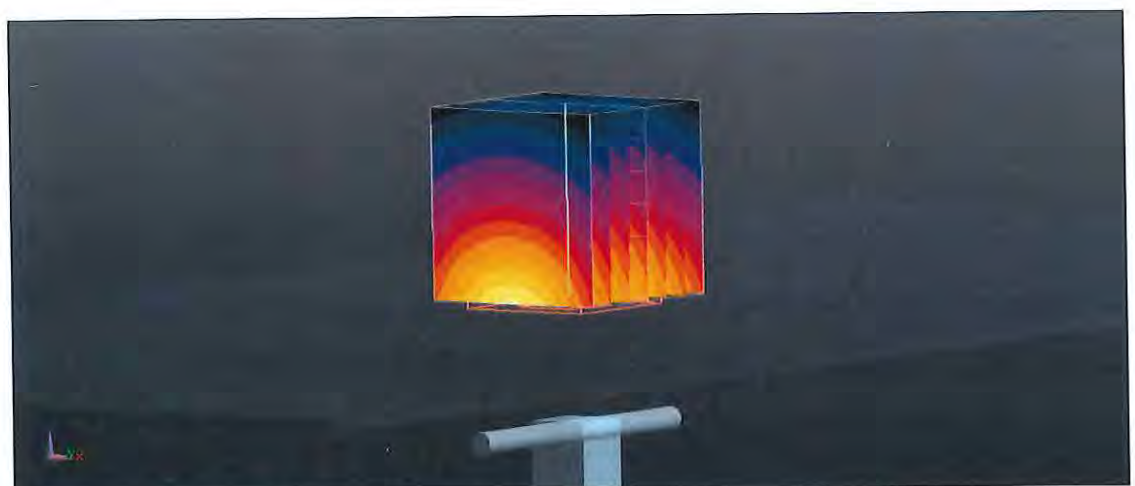
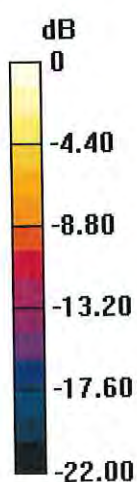

0 dB = 22.0 W/kg = 13.42 dBW/kg

Impedance Measurement Plot for Head TSL

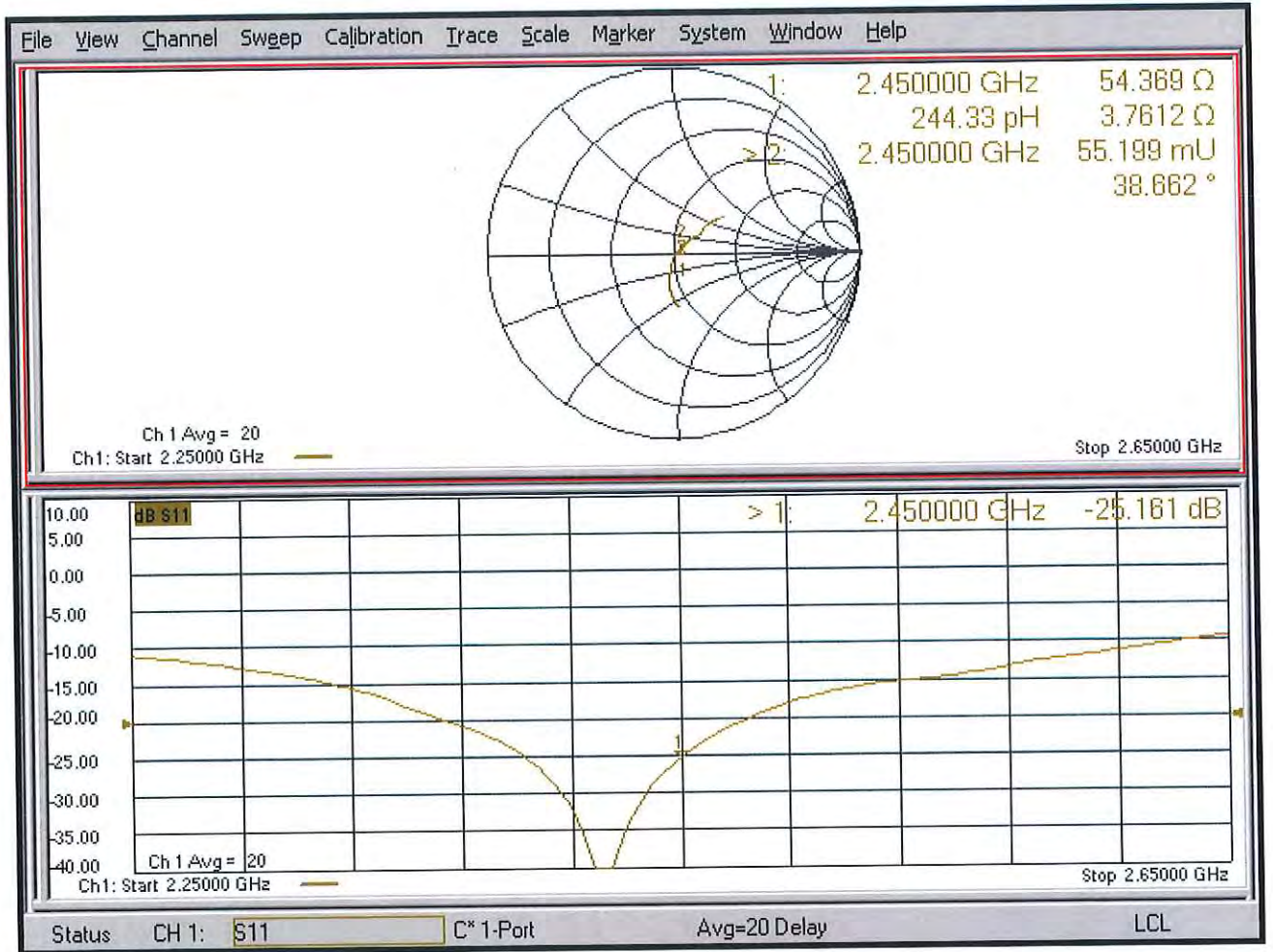

DASY5 Validation Report for Body TSL

Date: 21.11.2019

Test Laboratory: SPEAG, Zurich, Switzerland

DUT: Dipole 2450 MHz; Type: D2450V2; Serial: D2450V2 - SN:930

Communication System: UID 0 - CW; Frequency: 2450 MHz

Medium parameters used: $f = 2450$ MHz; $\sigma = 2.01$ S/m; $\epsilon_r = 50.8$; $\rho = 1000$ kg/m³

Phantom section: Flat Section

Measurement Standard: DASY5 (IEEE/IEC/ANSI C63.19-2011)

DASY52 Configuration:

- Probe: EX3DV4 - SN7349; ConvF(7.94, 7.94, 7.94) @ 2450 MHz; Calibrated: 29.05.2019
- Sensor-Surface: 1.4mm (Mechanical Surface Detection)
- Electronics: DAE4 Sn601; Calibrated: 30.04.2019
- Phantom: Flat Phantom 5.0 (back); Type: QD 000 P50 AA; Serial: 1002
- DASY52 52.10.3(1513); SEMCAD X 14.6.13(7474)

Dipole Calibration for Body Tissue/Pin=250 mW, d=10mm/Zoom Scan (7x7x7)/Cube 0:

Measurement grid: dx=5mm, dy=5mm, dz=5mm

Reference Value = 110.8 V/m; Power Drift = -0.03 dB

Peak SAR (extrapolated) = 26.5 W/kg

SAR(1 g) = 13.3 W/kg; SAR(10 g) = 6.17 W/kg

Smallest distance from peaks to all points 3 dB below = 8.5 mm

Ratio of SAR at M2 to SAR at M1 = 51%

Maximum value of SAR (measured) = 21.9 W/kg

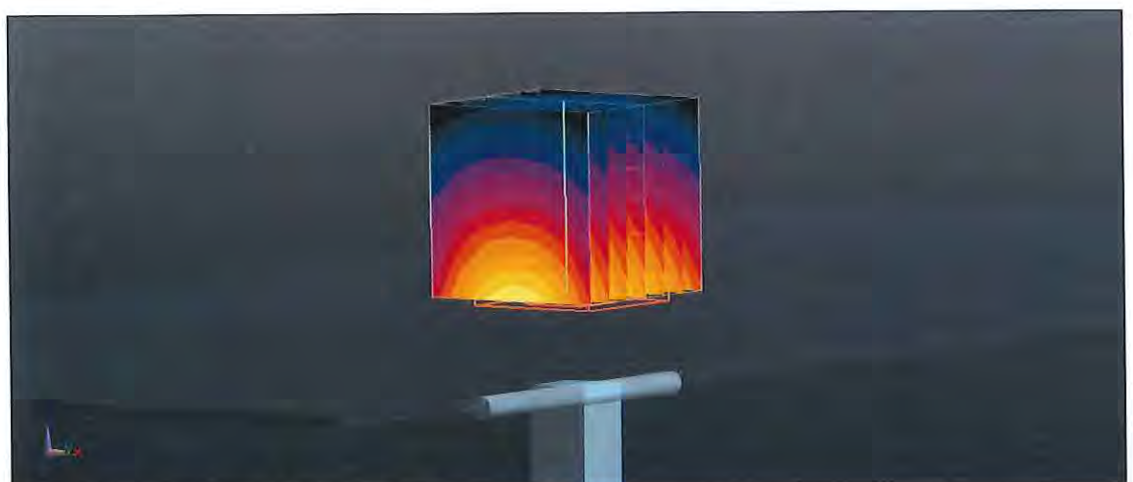
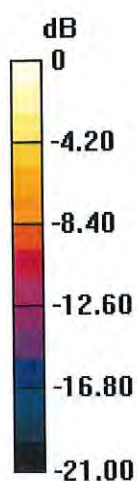

0 dB = 21.9 W/kg = 13.40 dBW/kg

Impedance Measurement Plot for Body TSL

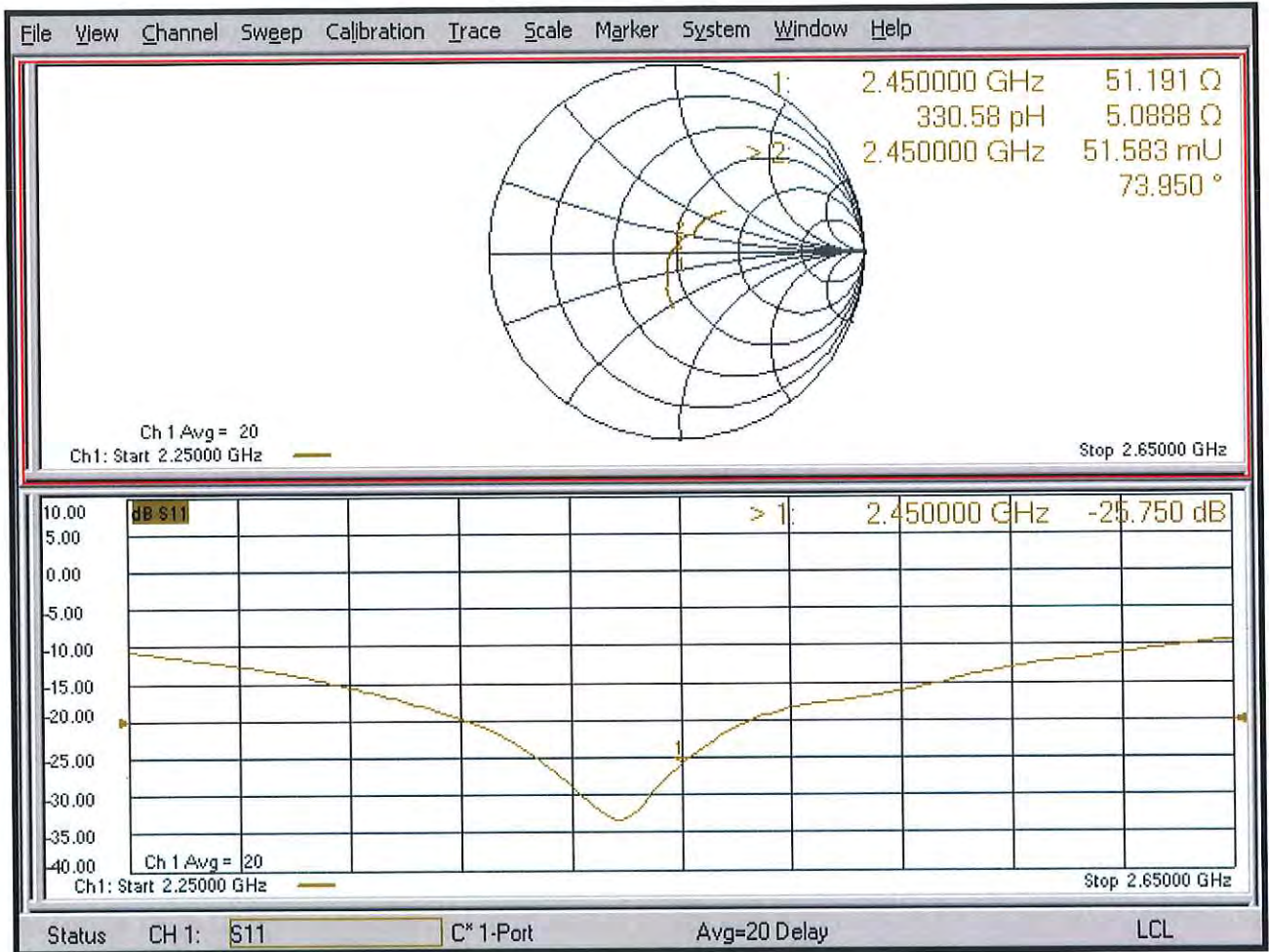



Accredited by the Swiss Accreditation Service (SAS)
The Swiss Accreditation Service is one of the signatories to the EA
Multilateral Agreement for the recognition of calibration certificates

Accreditation No.: **SCS 0108**

Client **DEKRA (Auden)**

Certificate No: **D5GHzV2-1041_May20**

CALIBRATION CERTIFICATE

Object **D5GHzV2 - SN:1041**

Calibration procedure(s) **QA CAL-22.v4
Calibration Procedure for SAR Validation Sources between 3-6 GHz**

Calibration date: **May 25, 2020**

This calibration certificate documents the traceability to national standards, which realize the physical units of measurements (SI).
The measurements and the uncertainties with confidence probability are given on the following pages and are part of the certificate.

All calibrations have been conducted in the closed laboratory facility: environment temperature (22 ± 3)°C and humidity < 70%.

Calibration Equipment used (M&TE critical for calibration)

Primary Standards	ID #	Cal Date (Certificate No.)	Scheduled Calibration
Power meter NRP	SN: 104778	01-Apr-20 (No. 217-03100/03101)	Apr-21
Power sensor NRP-Z91	SN: 103244	01-Apr-20 (No. 217-03100)	Apr-21
Power sensor NRP-Z91	SN: 103245	01-Apr-20 (No. 217-03101)	Apr-21
Reference 20 dB Attenuator	SN: BH9394 (20k)	31-Mar-20 (No. 217-03106)	Apr-21
Type-N mismatch combination	SN: 310982 / 06327	31-Mar-20 (No. 217-03104)	Apr-21
Reference Probe EX3DV4	SN: 3503	31-Dec-19 (No. EX3-3503_Dec19)	Dec-20
DAE4	SN: 601	27-Dec-19 (No. DAE4-601_Dec19)	Dec-20

Secondary Standards	ID #	Check Date (in house)	Scheduled Check
Power meter E4419B	SN: GB39512475	30-Oct-14 (in house check Feb-19)	In house check: Oct-20
Power sensor HP 8481A	SN: US37292783	07-Oct-15 (in house check Oct-18)	In house check: Oct-20
Power sensor HP 8481A	SN: MY41092317	07-Oct-15 (in house check Oct-18)	In house check: Oct-20
RF generator R&S SMT-06	SN: 100972	15-Jun-15 (in house check Oct-18)	In house check: Oct-20
Network Analyzer Agilent E8358A	SN: US41080477	31-Mar-14 (in house check Oct-19)	In house check: Oct-20

Calibrated by:	Name Michael Weber	Function Laboratory Technician	Signature
Approved by:	Name Katja Pokovic	Function Technical Manager	Signature

Issued: May 26, 2020

This calibration certificate shall not be reproduced except in full without written approval of the laboratory.



Accredited by the Swiss Accreditation Service (SAS)

The Swiss Accreditation Service is one of the signatories to the EA
Multilateral Agreement for the recognition of calibration certificates

Accreditation No.: **SCS 0108**

Glossary:

TSL	tissue simulating liquid
ConvF	sensitivity in TSL / NORM x,y,z
N/A	not applicable or not measured

Calibration is Performed According to the Following Standards:

- IEEE Std 1528-2013, "IEEE Recommended Practice for Determining the Peak Spatial-Averaged Specific Absorption Rate (SAR) in the Human Head from Wireless Communications Devices: Measurement Techniques", June 2013
- IEC 62209-1, "Measurement procedure for the assessment of Specific Absorption Rate (SAR) from hand-held and body-mounted devices used next to the ear (frequency range of 300 MHz to 6 GHz)", July 2016
- IEC 62209-2, "Procedure to determine the Specific Absorption Rate (SAR) for wireless communication devices used in close proximity to the human body (frequency range of 30 MHz to 6 GHz)", March 2010
- KDB 865664, "SAR Measurement Requirements for 100 MHz to 6 GHz"

Additional Documentation:

- DASY4/5 System Handbook

Methods Applied and Interpretation of Parameters:

- Measurement Conditions:** Further details are available from the Validation Report at the end of the certificate. All figures stated in the certificate are valid at the frequency indicated.
- Antenna Parameters with TSL:** The dipole is mounted with the spacer to position its feed point exactly below the center marking of the flat phantom section, with the arms oriented parallel to the body axis.
- Feed Point Impedance and Return Loss:** These parameters are measured with the dipole positioned under the liquid filled phantom. The impedance stated is transformed from the measurement at the SMA connector to the feed point. The Return Loss ensures low reflected power. No uncertainty required.
- Electrical Delay:** One-way delay between the SMA connector and the antenna feed point. No uncertainty required.
- SAR measured:** SAR measured at the stated antenna input power.
- SAR normalized:** SAR as measured, normalized to an input power of 1 W at the antenna connector.
- SAR for nominal TSL parameters:** The measured TSL parameters are used to calculate the nominal SAR result.

The reported uncertainty of measurement is stated as the standard uncertainty of measurement multiplied by the coverage factor $k=2$, which for a normal distribution corresponds to a coverage probability of approximately 95%.

Measurement Conditions

DASY system configuration, as far as not given on page 1.

DASY Version	DASY5	V52.10.4
Extrapolation	Advanced Extrapolation	
Phantom	Modular Flat Phantom V5.0	
Distance Dipole Center - TSL	10 mm	with Spacer
Zoom Scan Resolution	dx, dy = 10.0 mm, dz = 10.0 mm	Graded Ratio = 1.4 (Z direction)
Frequency	5250 MHz ± 1 MHz 5600 MHz ± 1 MHz 5800 MHz ± 1 MHz	

Head TSL parameters at 5250 MHz

The following parameters and calculations were applied.

	Temperature	Permittivity	Conductivity
Nominal Head TSL parameters	22.0 °C	35.9	4.71 mho/m
Measured Head TSL parameters	(22.0 ± 0.2) °C	35.3 ± 6 %	4.55 mho/m ± 6 %
Head TSL temperature change during test	< 0.5 °C	----	----

SAR result with Head TSL at 5250 MHz

SAR averaged over 1 cm³ (1 g) of Head TSL	Condition	
SAR measured	100 mW input power	8.20 W/kg
SAR for nominal Head TSL parameters	normalized to 1W	81.6 W/kg ± 19.9 % (k=2)

SAR averaged over 10 cm³ (10 g) of Head TSL	condition	
SAR measured	100 mW input power	2.33 W/kg
SAR for nominal Head TSL parameters	normalized to 1W	23.2 W/kg ± 19.5 % (k=2)

Head TSL parameters at 5600 MHz

The following parameters and calculations were applied.

	Temperature	Permittivity	Conductivity
Nominal Head TSL parameters	22.0 °C	35.5	5.07 mho/m
Measured Head TSL parameters	(22.0 ± 0.2) °C	34.8 ± 6 %	4.90 mho/m ± 6 %
Head TSL temperature change during test	< 0.5 °C	----	----

SAR result with Head TSL at 5600 MHz

SAR averaged over 1 cm³ (1 g) of Head TSL	Condition	
SAR measured	100 mW input power	8.63 W/kg
SAR for nominal Head TSL parameters	normalized to 1W	85.9 W/kg ± 19.9 % (k=2)

SAR averaged over 10 cm³ (10 g) of Head TSL	condition	
SAR measured	100 mW input power	2.43 W/kg
SAR for nominal Head TSL parameters	normalized to 1W	24.2 W/kg ± 19.5 % (k=2)

Head TSL parameters at 5800 MHz

The following parameters and calculations were applied.

	Temperature	Permittivity	Conductivity
Nominal Head TSL parameters	22.0 °C	35.3	5.27 mho/m
Measured Head TSL parameters	(22.0 ± 0.2) °C	34.5 ± 6 %	5.11 mho/m ± 6 %
Head TSL temperature change during test	< 0.5 °C	----	----

SAR result with Head TSL at 5800 MHz

SAR averaged over 1 cm ³ (1 g) of Head TSL	Condition	
SAR measured	100 mW input power	8.25 W/kg
SAR for nominal Head TSL parameters	normalized to 1W	82.0 W/kg ± 19.9 % (k=2)

SAR averaged over 10 cm ³ (10 g) of Head TSL	condition	
SAR measured	100 mW input power	2.30 W/kg
SAR for nominal Head TSL parameters	normalized to 1W	22.8 W/kg ± 19.5 % (k=2)

Appendix (Additional assessments outside the scope of SCS 0108)

Antenna Parameters with Head TSL at 5250 MHz

Impedance, transformed to feed point	49.0 Ω - 4.4 j Ω
Return Loss	- 26.9 dB

Antenna Parameters with Head TSL at 5600 MHz

Impedance, transformed to feed point	56.3 Ω - 1.2 j Ω
Return Loss	- 24.4 dB

Antenna Parameters with Head TSL at 5800 MHz

Impedance, transformed to feed point	54.3 Ω - 2.1 j Ω
Return Loss	- 26.8 dB

General Antenna Parameters and Design

Electrical Delay (one direction)	1.197 ns
----------------------------------	----------

After long term use with 100W radiated power, only a slight warming of the dipole near the feedpoint can be measured.

The dipole is made of standard semirigid coaxial cable. The center conductor of the feeding line is directly connected to the second arm of the dipole. The antenna is therefore short-circuited for DC-signals. On some of the dipoles, small end caps are added to the dipole arms in order to improve matching when loaded according to the position as explained in the "Measurement Conditions" paragraph. The SAR data are not affected by this change. The overall dipole length is still according to the Standard.

No excessive force must be applied to the dipole arms, because they might bend or the soldered connections near the feedpoint may be damaged.

Additional EUT Data

Manufactured by	SPEAG
-----------------	-------

DASY5 Validation Report for Head TSL

Date: 25.05.2020

Test Laboratory: SPEAG, Zurich, Switzerland

DUT: Dipole D5GHzV2; Type: D5GHzV2; Serial: D5GHzV2 - SN:1041

Communication System: UID 0 - CW; Frequency: 5250 MHz, Frequency: 5600 MHz, Frequency: 5800 MHz

Medium parameters used: $f = 5250$ MHz; $\sigma = 4.55$ S/m; $\epsilon_r = 35.3$; $\rho = 1000$ kg/m³,

Medium parameters used: $f = 5600$ MHz; $\sigma = 4.9$ S/m; $\epsilon_r = 34.8$; $\rho = 1000$ kg/m³,

Medium parameters used: $f = 5800$ MHz; $\sigma = 5.11$ S/m; $\epsilon_r = 34.5$; $\rho = 1000$ kg/m³

Phantom section: Flat Section

Measurement Standard: DASY5 (IEEE/IEC/ANSI C63.19-2011)

DASY52 Configuration:

- Probe: EX3DV4 - SN3503; ConvF(5.5, 5.5, 5.5) @ 5250 MHz, ConvF(5.1, 5.1, 5.1) @ 5600 MHz, ConvF(5.01, 5.01, 5.01) @ 5800 MHz; Calibrated: 31.12.2019
- Sensor-Surface: 1.4mm (Mechanical Surface Detection)
- Electronics: DAE4 Sn601; Calibrated: 27.12.2019
- Phantom: Flat Phantom 5.0 (front); Type: QD 000 P50 AA; Serial: 1001
- DASY52 52.10.4(1527); SEMCAD X 14.6.14(7483)

Dipole Calibration for Head Tissue/Pin=100mW, dist=10mm, f=5250 MHz/Zoom Scan, dist=1.4mm (8x8x7)/Cube 0: Measurement grid: dx=4mm, dy=4mm, dz=1.4mm

Reference Value = 79.63 V/m; Power Drift = 0.04 dB

Peak SAR (extrapolated) = 28.8 W/kg

SAR(1 g) = 8.20 W/kg; SAR(10 g) = 2.33 W/kg

Smallest distance from peaks to all points 3 dB below = 7.2 mm

Ratio of SAR at M2 to SAR at M1 = 69.4%

Maximum value of SAR (measured) = 18.9 W/kg

Dipole Calibration for Head Tissue/Pin=100mW, dist=10mm, f=5600 MHz/Zoom Scan, dist=1.4mm (8x8x7)/Cube 0: Measurement grid: dx=4mm, dy=4mm, dz=1.4mm

Reference Value = 79.80 V/m; Power Drift = 0.05 dB

Peak SAR (extrapolated) = 32.6 W/kg

SAR(1 g) = 8.63 W/kg; SAR(10 g) = 2.43 W/kg

Smallest distance from peaks to all points 3 dB below = 7.4 mm

Ratio of SAR at M2 to SAR at M1 = 66.8%

Maximum value of SAR (measured) = 20.6 W/kg

Dipole Calibration for Head Tissue/Pin=100mW, dist=10mm, f=5800 MHz/Zoom Scan, dist=1.4mm (8x8x7)/Cube 0: Measurement grid: dx=4mm, dy=4mm, dz=1.4mm

Reference Value = 77.63 V/m; Power Drift = 0.04 dB

Peak SAR (extrapolated) = 33.4 W/kg

SAR(1 g) = 8.25 W/kg; SAR(10 g) = 2.30 W/kg

Smallest distance from peaks to all points 3 dB below = 7.2 mm

Ratio of SAR at M2 to SAR at M1 = 64.8%

Maximum value of SAR (measured) = 20.2 W/kg

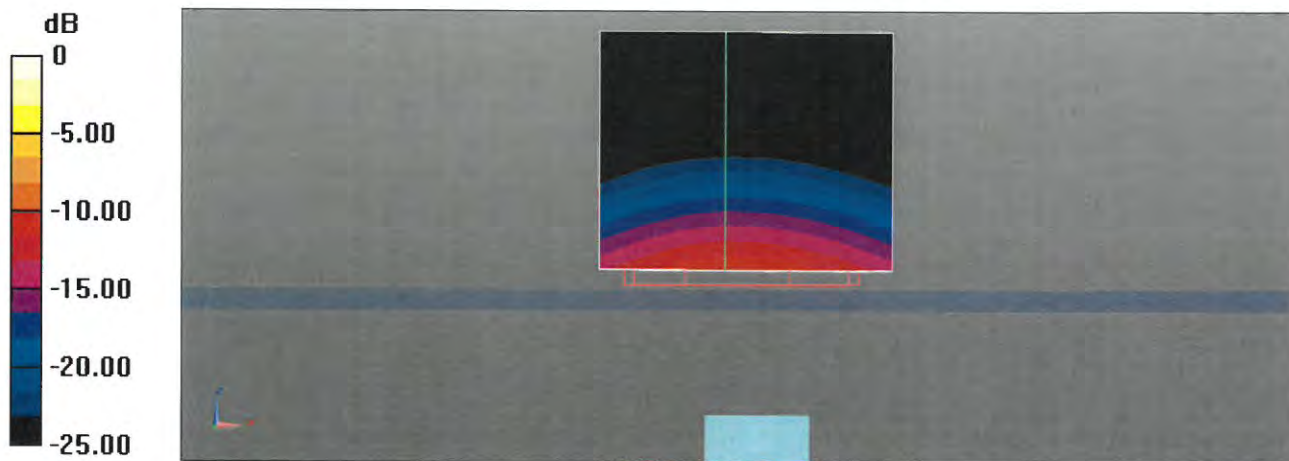

0 dB = 20.6 W/kg = 13.13 dBW/kg

Impedance Measurement Plot for Head TSL

