

FCC Test Report

(Class II Permissive Change)

Product Name	Intel® Wireless-AC 9560
Model No.	9560NGW
FCC ID.	2AKHF9560NG

Applicant	TONGFANG HONGKONG (SUZHOU) LIMITED
Address	No. 10 Plant, Jianwu Phase III, Western Zone, Suzhou Industrial Park, Suzhou City, Jiangsu Province, 215000 China

Date of Receipt	Nov. 04, 2019
Issued Date	Dec. 26, 2019
Report No.	19B0034R-RFUSP11V00-A
Report Version	V1.0



Testing Laboratory

3023

The test results relate only to the samples tested.

The test results shown in the test report are traceable to the national/international standard through the calibration report of the equipment and evaluated measurement uncertainty herein.

This report must not be used to claim product endorsement by TAF or any agency of the government.

The test report shall not be reproduced without the written approval of DEKRA Testing and Certification Co., Ltd.

Test Report

Issued Date: Dec. 26, 2019

Report No.: 19B0034R-RFUSP11V00-A



Product Name	Intel® Wireless-AC 9560
Applicant	TONGFANG HONGKONG (SUZHOU) LIMITED
Address	No. 10 Plant, Jianwu Phase III, Western Zone, Suzhou Industrial Park, Suzhou City, Jiangsu Province, 215000 China
Manufacturer	INTEL CORPORATION SAS
Model No.	9560NGW
FCC ID.	2AKHF9560NG
EUT Rated Voltage	DC 3.3V
EUT Test Voltage	DC 3.3V (Power By Test Fixture)
Trade Name	Intel
Applicable Standard	FCC CFR Title 47 Part 15 Subpart C ANSI C63.4: 2014, ANSI C63.10: 2013
Test Result	Complied

Documented By :



(Adm. Assistant / Ida Tung)

Tested By :



(Engineer / Yulin Chen)

Approved By :



(Director / Vincent Lin)

TABLE OF CONTENTS

Description	Page
1. GENERAL INFORMATION	4
1.1. EUT Description.....	4
1.2. Operational Description.....	6
1.3. Tested System Details.....	7
1.4. Configuration of Tested System	7
1.5. EUT Exercise Software	7
1.6. Test Facility	8
1.7. List of Test Equipment.....	9
1.8. Uncertainty	10
2. PEAK POWER OUTPUT	11
2.1. Test Setup	11
2.2. Limit	11
2.3. Test Procedure	11
2.4. Uncertainty	11
2.5. Test Result of Peak Power Output.....	12
3. RADIATED EMISSION	13
3.1. Test Setup	13
3.2. Limits.....	14
3.3. Test Procedure	15
3.4. Uncertainty	16
3.5. Test Result of Radiated Emission.....	17
4. BAND EDGE	25
4.1. Test Setup	25
4.2. Limit	26
4.3. Test Procedure	26
4.4. Uncertainty	27
4.5. Test Result of Band Edge	28
5. DUTY CYCLE.....	36
5.1. Test Setup	36
5.2. Test Procedure	36
5.3. Uncertainty	36
5.4. Test Result of Duty Cycle.....	37
6. EMI REDUCTION METHOD DURING COMPLIANCE TESTING	38
Attachment 1: EUT Test Photographs	
Attachment 2: EUT Detailed Photographs	

1. GENERAL INFORMATION

1.1. EUT Description

Product Name	Intel® Wireless-AC 9560
Trade Name	Intel
Model No.	9560NGW
FCC ID.	2AKHF9560NG
Frequency Range	2402 – 2480MHz
Channel Number	V5.0: 40CH
Type of Modulation	V5.0: GFSK(2Mbps)
Antenna Type	PIFA Antenna
Channel Control	Auto
Antenna Gain	Refer to the table “Antenna List”
Test Platform	Product name: Notebook PC Brand: TONGFANG Model number: GM7CP6P/GM7CP0P/GM7CP7P
Power Adapter	MFR: Chicony, M/N: A17-230P1A Input: AC 100-240V~3.5A, 50-60Hz Output: DC 19.5V, 11.8A, 230W Cable Out: Shielded, 1.1m, with two ferrite cores bonded.

Antenna List

No.	Manufacturer	Part No.	Antenna Type	Peak Gain
1.	WGT	ANTRG7P119-0301 (Main) ANTRG7P119-0302 (Aux)	PIFA Antenna	4.83dBi for 2.4 GHz

Note: The antenna of EUT is conforming to FCC 15.203.

Center Frequency of Each Channel: (For V5.0)

Channel	Frequency	Channel	Frequency	Channel	Frequency	Channel	Frequency
Channel 00:	2402 MHz	Channel 01:	2404 MHz	Channel 02:	2406 MHz	Channel 03:	2408 MHz
Channel 04:	2410 MHz	Channel 05:	2412 MHz	Channel 06:	2414 MHz	Channel 07:	2416 MHz
Channel 08:	2418 MHz	Channel 09:	2420 MHz	Channel 10:	2422 MHz	Channel 11:	2424 MHz
Channel 12:	2426 MHz	Channel 13:	2428 MHz	Channel 14:	2430 MHz	Channel 15:	2432 MHz
Channel 16:	2434 MHz	Channel 17:	2436 MHz	Channel 18:	2438 MHz	Channel 19:	2440 MHz
Channel 20:	2442 MHz	Channel 21:	2444 MHz	Channel 22:	2446 MHz	Channel 23:	2448 MHz
Channel 24:	2450 MHz	Channel 25:	2452 MHz	Channel 26:	2454 MHz	Channel 27:	2456 MHz
Channel 28:	2458 MHz	Channel 29:	2460 MHz	Channel 30:	2462 MHz	Channel 31:	2464 MHz
Channel 32:	2466 MHz	Channel 33:	2468 MHz	Channel 34:	2470 MHz	Channel 35:	2472 MHz
Channel 36:	2474 MHz	Channel 37:	2476 MHz	Channel 38:	2478 MHz	Channel 39:	2480 MHz

Note:

1. The EUT is an Intel® Wireless-AC 9560 with built-in WLAN (802.11a/b/g/n/ac) with Bluetooth (5.0 and V3.0+HS, V2.1+EDR) transceiver, this report for Bluetooth V5.0.
2. These tests were conducted on a sample for the purpose of demonstrating compliance of transmitter with Part 15 Subpart C Paragraph 15.247 for spread spectrum devices.
3. Regarding to the operation frequency, the lowest, middle and highest frequency are selected to perform the test.
4. This is to request a Class II permissive change for FCC ID: 2AKHF9560NG, originally granted on 03/16/2018.

(1) The major change filed under this application is:

Change #1: Additional Chassis is added, Product name: Notebook PC, Brand: TONGFANG, Model number: GM7CP6P/GM7CP0P/GM7CP7P

All models are listed as below:

Brand	Model No.	Difference
TONGFANG	GM7CP0P	All models are electrically identical and different model names are used to distinguish between different GPU specifications.
	GM7CP6P	
	GM7CP7P	

#2: Reduce the Output Power through firmware, and SAR measurement were evaluated. (Only reduce Wi-Fi Output Power, Bluetooth Output Power haven't changes).

#3: Addition an Antennas, the antenna type is same, the antenna gain is higher than the original application.

Test Mode	Mode 1: Transmit - BLE
-----------	------------------------

1.3. Tested System Details

The types for all equipment, plus descriptions of all cables used in the tested system (including inserted cards) are:

Product	Manufacturer	Model No.	Serial No.	Power Cord
1 Monitor	Lenovo	P27u	V302ZGXP	Non-Shielded, 1.8m
2 HDD	Lenovo	F309	GXB0H43289Z152DT85	N/A
3 HDD	Transcend	TS1TSJ25M3	D468623807	N/A
4 Microphone & Earphone	Verbatim	N/A	N/A	N/A
5 Microphone & Earphone	Verbatim	N/A	N/A	N/A
6 HDD	Transcend	TS1TSJ25M3	D468623812	N/A
7 HDD	Transcend	TS1TSJ25M3	D468623820	N/A
8 Notebook PC	ASUS	CP7P	N/A	N/A

Signal Cable Type	Signal cable Description
A HDMI Cable	Non-shielded, 1.8m
B Type C Cable	Shielded, 0.5m
C USB Cable	Shielded, 1.2m
D Microphone & Earphone Cable	Non-shielded, 1.2m
E Microphone & Earphone Cable	Non-shielded, 1.2m
F USB Cable	Shielded, 1.2m
G USB Cable	Shielded, 1.2m

1.4. Configuration of Tested System

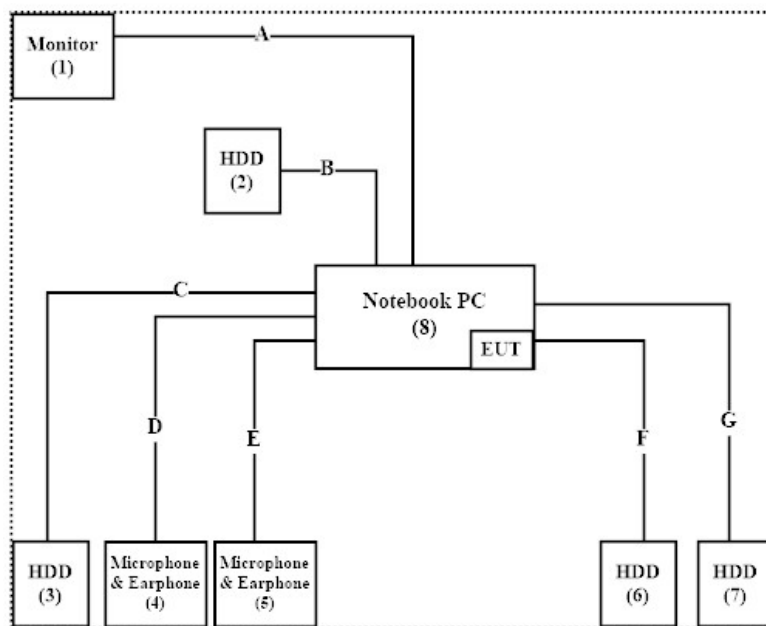

1.5. EUT Exercise Software

- (1) Setup the EUT as shown in Section 1.4.
- (2) Execute software “DRTU (Ver 11.1832.0-08048)” on the notebook PC.
- (3) Configure the test mode, the test channel, and the data rate.
- (4) Press “OK” to start the continuous Transmit.
- (5) Verify that the EUT works properly.

1.6. Test Facility

Ambient conditions in the laboratory:

Performed Item	Items	Required	Actual
Radiated Emission	Temperature (°C)	10~40 °C	20.6 °C
	Humidity (%RH)	10~90 %	73.9 %
Conductive	Temperature (°C)	10~40 °C	22.7 °C
	Humidity (%RH)	10~90 %	57.9 %

USA : FCC Registration Number: TW0023

Canada : IC Registration Number: 4075A

Site Description : Accredited by TAF
Accredited Number: 3023

Test Laboratory : DEKRA Testing and Certification Co., Ltd
Address : No.159, Sec. 2, Wenhua 1st Rd., Linkou Dist.,
New Taipei City 24457, Taiwan, R.O.C.

Phone number : 886-2-2602-7968
Fax number : 866-2-2602-3286
Email address : info.tw@dekra.com
Website : <http://www.dekra.com.tw>

1.7. List of Test Equipment

For Conducted measurements /ASR2

	Equipment	Manufacturer	Model No.	Serial No.	Cali. Data	Due. Data
X	Spectrum Analyzer	R&S	FSV30	103466	2019.12.16	2020.12.15
X	Peak Power Analyzer	KEYSIGHT	8900B	MY51000539	2019.05.06	2020.05.05
X	Power Sensor	KEYSIGHT	N1923A	MY59240002	2019.06.12	2020.06.11
X	Power Sensor	KEYSIGHT	N1923A	MY59240003	2019.06.13	2020.06.12
	Bluetooth Tester	R&S	CBT	101238	2019.01.21	2020.01.20

Note:

1. All equipments are calibrated every one year.
2. The test instruments marked with "X" are used to measure the final test results.
3. Test Software version : DEKRA Conduction Test System V9.0.5

For Radiated measurements /ACB1

	Equipment	Manufacturer	Model No.	Serial No.	Cali. Data	Due. Data
X	Loop Antenna	AMETEK	HLA6121	49611	2019.02.22	2020.02.21
X	Bi-Log Antenna	SCHWARZBECK	VULB9168	9168-953	2019.01.04	2020.01.03
X	Bi-Log Antenna	SCHWARZBECK	VULB9168	9168-953	2019.01.04	2020.01.03
X	Horn Antenna	ETS-Lindgren	3117	00203800	2019.12.12	2020.12.11
X	Horn Antenna	ETS-Lindgren	3117	00201259	2019.10.15	2020.10.14
X	Horn Antenna	ETS-Lindgren	3117	00203761	2019.10.31	2020.10.30
X	Horn Antenna	Com-Power	AH-840	101087	2019.05.30	2020.05.29
X	Pre-Amplifier	EMCI	EMC001330	980301	2019.05.20	2020.05.19
X	Pre-Amplifier	EMCI	EMC001330	980316	2019.06.14	2020.06.13
X	Pre-Amplifier	EMCI	EMC051835SE	980311	2019.06.13	2020.06.12
X	Pre-Amplifier	EMCI	EMC05820SE	980308	2019.09.02	2020.09.01
X	Pre-Amplifier	EMCI	EMC05820SE	980310	2019.06.24	2020.06.23
X	Pre-Amplifier	EMCI	EMC05835SE	980312	2019.06.03	2020.06.02
X	Pre-Amplifier	EMCI	EMC184045SE	980314	2019.05.28	2020.05.27
X	Filter	MICRO TRONICS	BRM50702	G251	2019.09.03	2020.09.02
	Filter	MICRO TRONICS	BRM50716	G188	2019.09.03	2020.09.02
X	EMI Test Receiver	R&S	ESR7	101602	2019.12.16	2020.12.15
X	Spectrum Analyzer	R&S	FSV40	101148	2019.02.08	2020.02.07
X	Coaxial Cable	SUHNER	SUCOFLEX 106	RF002	2019.07.03	2020.07.02
X	Mircoflex Cable	HUBER SUHNER	SUCOFLEX 102	MY3381/2	2019.05.28	2020.05.27

Note:

1. All equipments are calibrated every one year.
2. The test instruments marked with "X" are used to measure the final test results.
3. Test Software version : DEKRA Testing System V1.0.0.20

1.8. Uncertainty

Uncertainties have been calculated according to the DEKRA internal document, and is described in each test chapter of this report.

The reported expanded uncertainties are based on a standard uncertainty multiplied by a coverage factor of $k=2$, providing a level of confidence of approximately 95%.

Measurement uncertainties evaluated for each testing system and associated connections are given here to provide the system information for reference. Compliance determinations do not take into account measurement uncertainties for each testing system, but are based on the results of the compliance measurement.

2. Peak Power Output

2.1. Test Setup

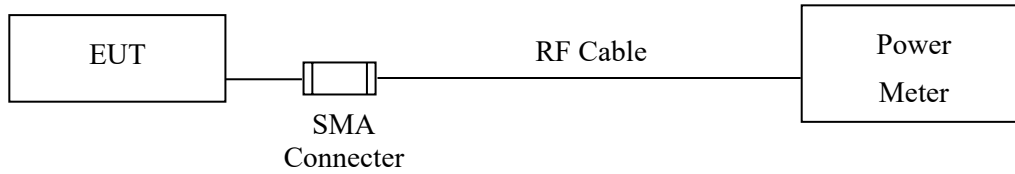

2.2. Limit

The maximum peak power shall be less 1Watt.

2.3. Test Procedure

The EUT was tested according to C63.10:2013 for compliance to FCC 47CFR 15.247 requirements. The maximum peak conducted output power using C63.10:2013 Section 11.9.1.3 PKPM1 Peak power meter method.

2.4. Uncertainty

± 0.86 dB

2.5. Test Result of Peak Power Output

Product : Intel® Wireless-AC 9560
Test Item : Peak Power Output
Test Mode : Mode 1: Transmit - BLE
Test Date : 2019/11/27

Channel No.	Frequency (MHz)	Measurement (dBm)	Required Limit	Result
Channel 00	2402.00	7.47	1 Watt= 30 dBm	Pass
Channel 19	2440.00	8.04	1 Watt= 30 dBm	Pass
Channel 39	2480.00	8.31	1 Watt= 30 dBm	Pass

3. Radiated Emission

3.1. Test Setup

Radiated Emission Under 30MHz

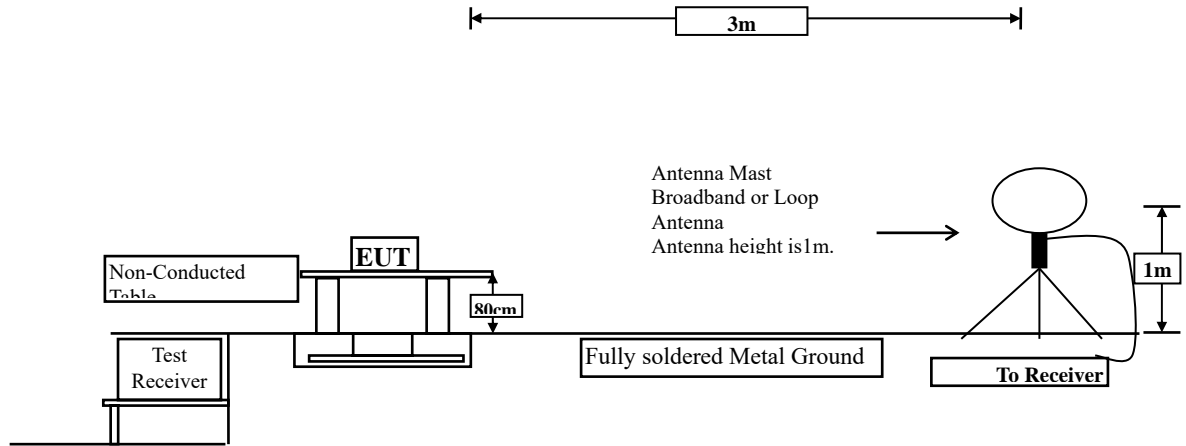

Radiated Emission Below 1GHz

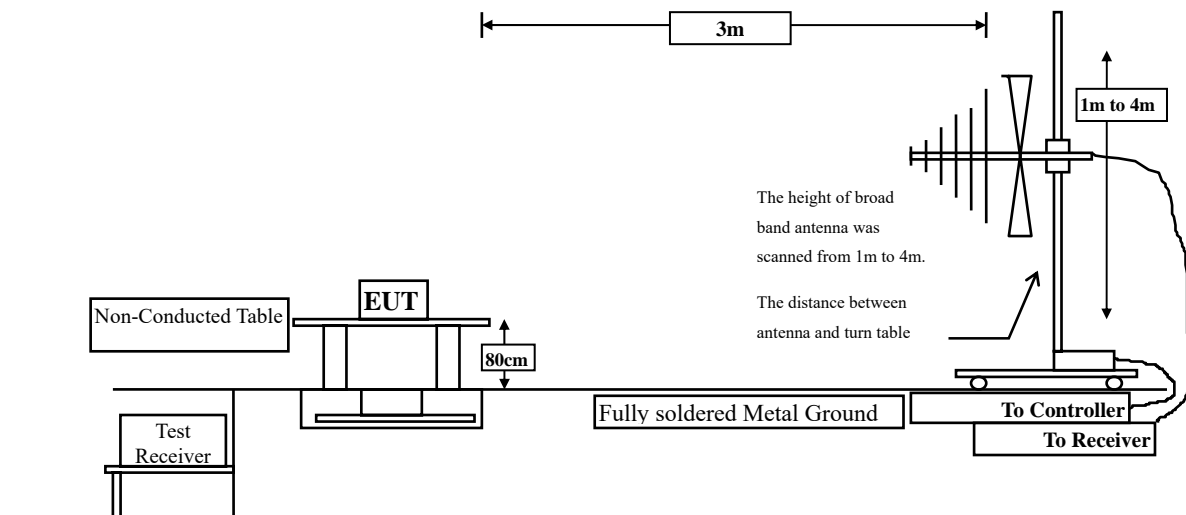

Radiated Emission Above 1GHz

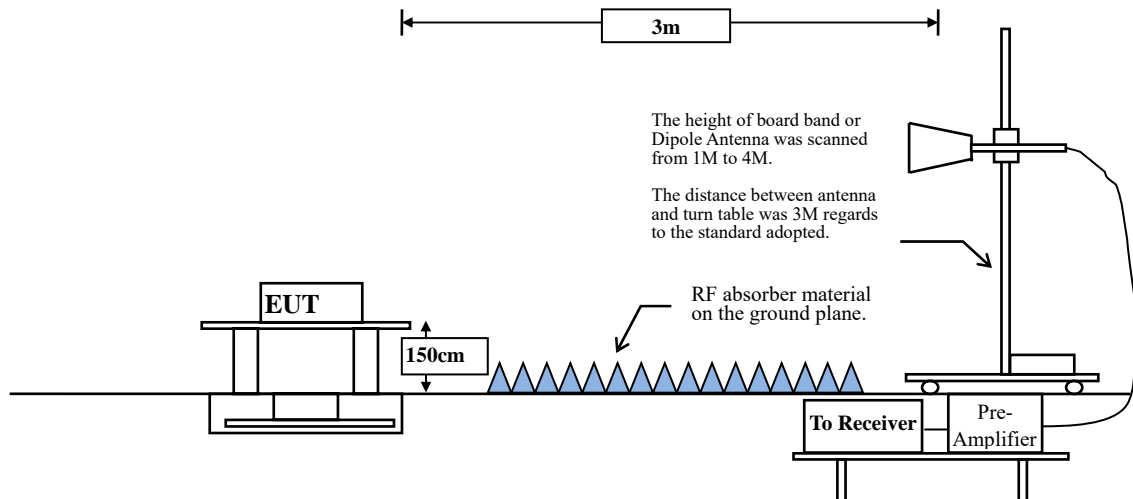

3.2. Limits

➤ General Radiated Emission Limits

Emissions radiated outside of the specified frequency bands, except for harmonics, shall be attenuated by at least 20dB below the level of the fundamental or to the general radiated emission limits in paragraph 15.209, whichever is the lesser attenuation.

FCC Part 15 Subpart C Paragraph 15.209 Limits		
Frequency MHz	Field strength (microvolts/meter)	Measurement distance (meter)
0.009-0.490	2400/F(kHz)	300
0.490-1.705	24000/F(kHz)	30
1.705-30	30	30
30-88	100	3
88-216	150	3
216-960	200	3
Above 960	500	3

- Remarks:
1. RF Voltage (dBuV) = 20 log RF Voltage (uV)
 2. In the Above Table, the tighter limit applies at the band edges.
 3. Distance refers to the distance in meters between the measuring instrument antenna and the closed point of any part of the device or system.

3.3. Test Procedure

The EUT was setup according to ANSI C63.10: 2013 and tested according to C63.10:2013 Section 11.12.1 for compliance to FCC 47CFR 15.247 requirements.

Measuring the frequency range below 1GHz, the EUT is placed on a turn table which is 0.8 meter above ground, when measuring the frequency range above 1GHz, the EUT is placed on a turn table which is 1.5 meter above ground.

The turn table is rotated 360 degrees to determine the position of the maximum emission level.

The EUT was positioned such that the distance from antenna to the EUT was 3 meters.

The antenna is scanned between 1 meter and 4 meters to find out the maximum emission level. This is repeated for both horizontal and vertical polarization of the antenna. In order to find the maximum emission, all of the interface cables were manipulated according to ANSI C63.10: 2013 on radiated measurement.

The resolution bandwidth below 30MHz setting on the field strength meter is 9kHz and 30MHz~1GHz is 120kHz and above 1GHz is 1MHz.

Radiated emission measurements below 30MHz are made using Loop Antenna and 30MHz~1GHz are made using broadband Bilog antenna and above 1GHz are made using Horn Antennas.

The measurement is divided into the Preliminary Measurement and the Final Measurement.

The suspected frequencies are searched for in Preliminary Measurement with the measurement antenna kept pointed at the source of the emission both in azimuth and elevation, with the polarization of the antenna oriented for maximum response. The antenna is pointed at an angle towards the source of the emission, and the EUT is rotated in both height and polarization to maximize the measured emission. The emission is kept within the illumination area of the 3 dB bandwidth of the antenna. The measurement frequency range from 9kHz - 10th Harmonic of fundamental was investigated.

RBW and VBW Parameter setting:

According to C63.10 Section 11.12.2.4 Peak measurement procedure.

RBW = as specified in Table 1.

$VBW \geq 3 \times RBW$.

Table 1 —RBW as a function of frequency

Frequency	RBW
9-150 kHz	200-300 Hz
0.15-30 MHz	9-10 kHz
30-1000 MHz	100-120 kHz
> 1000 MHz	1 MHz

According to C63.10 Section 11.12.2.5 Average measurement procedure.

RBW = 1MHz.

VBW = 10Hz, when duty cycle $\geq 98\%$

$VBW \geq 1/T$, when duty cycle $< 98\%$

(T refers to the minimum transmission duration over which the transmitter is on and is transmitting at its maximum power control level for the tested mode of operation.)

2.4GHz band	Duty Cycle (%)	T (ms)	1/T (Hz)	VBW (Hz)
BLE	89.29	2.2522	444	500

Note: Duty Cycle Refer to Section 5

3.4. Uncertainty

Horizontal polarization :

30-300MHz: ± 4.08 dB ; 300M-1GHz: ± 3.86 dB ; 1-18GHz: ± 3.77 dB ; 18-40GHz: ± 3.98 dB

Vertical polarization :

30-300MHz: ± 4.81 dB ; 300M-1GHz: ± 3.87 dB ; 1-18GHz: ± 3.83 dB ; 18-40GHz: ± 3.98 dB

3.5. Test Result of Radiated Emission

Product : Intel® Wireless-AC 9560
 Test Item : Harmonic Radiated Emission
 Test Mode : Mode 1: Transmit - BLE (2402MHz)
 Test Date : 2019/11/26

Horizontal

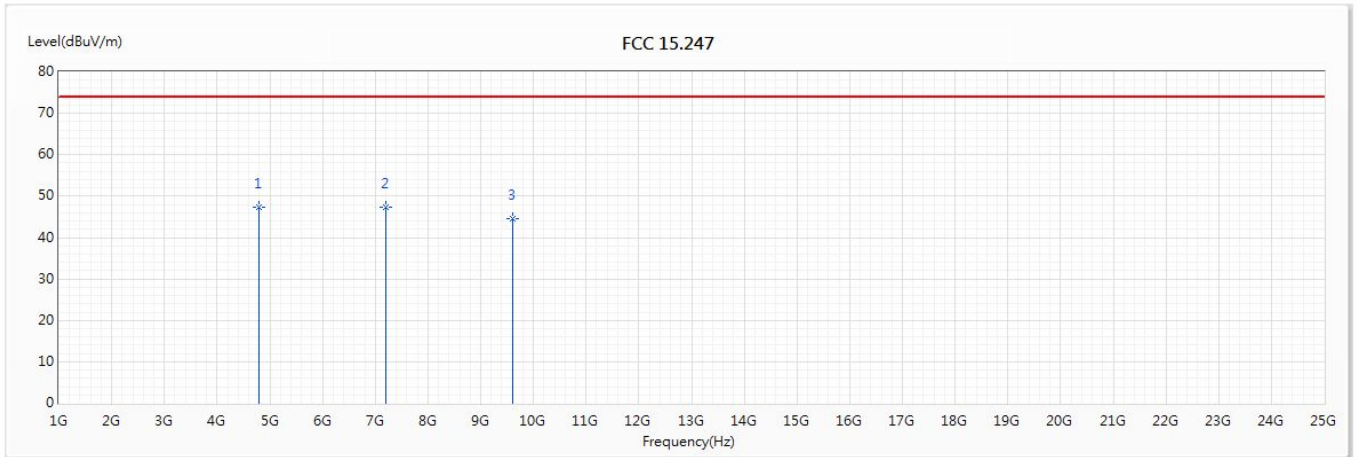

No	Frequency (MHz)	Emission Level (dBuV/m)	Limit (dBuV/m)	Margin (dB)	Reading Level (dBuV)	Correct Factor (dB/m)	Detector Type
1	4804	47.34	74.00	-26.66	51.66	-4.32	PK
* 2	7206	47.47	74.00	-26.53	48.12	-0.65	PK
3	9608	44.51	74.00	-29.49	42.71	1.80	PK

Note:

1. All Readings below 1GHz are Quasi-Peak, above 1GHz are performed with peak and/or average measurements as necessary.
2. Measurement Level = Reading Level + Correct Factor.
3. Correct Factor = Antenna factor + Cable loss – Amplifier gain.
4. The average measurement was not performed when the peak measured data under the limit of average detection.
5. The emission levels of other frequencies are very lower than the limit and not show in test report.

Product : Intel® Wireless-AC 9560
 Test Item : Harmonic Radiated Emission
 Test Mode : Mode 1: Transmit - BLE (2402MHz)
 Test Date : 2019/11/26

Vertical

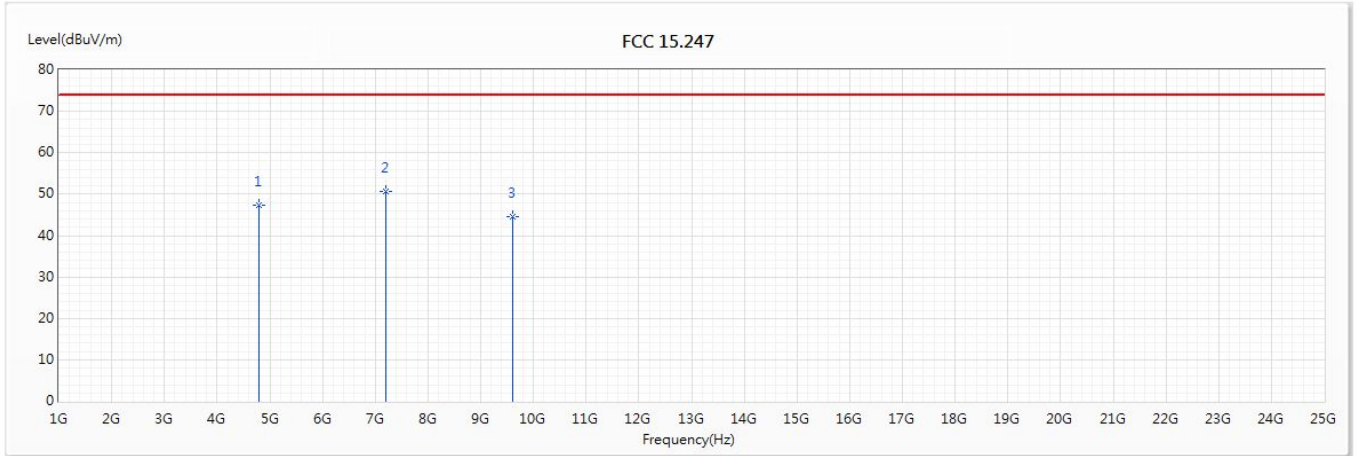

No	Frequency (MHz)	Emission Level (dBuV/m)	Limit (dBuV/m)	Margin (dB)	Reading Level (dBuV)	Correct Factor (dB/m)	Detector Type
1	4804	47.45	74.00	-26.55	51.77	-4.32	PK
* 2	7206	50.67	74.00	-23.33	51.32	-0.65	PK
3	9608	44.50	74.00	-29.50	42.70	1.80	PK

Note:

1. All Readings below 1GHz are Quasi-Peak, above 1GHz are performed with peak and/or average measurements as necessary.
2. Measurement Level = Reading Level + Correct Factor.
3. Correct Factor = Antenna factor + Cable loss – Amplifier gain.
4. The average measurement was not performed when the peak measured data under the limit of average detection.
5. The emission levels of other frequencies are very lower than the limit and not show in test report.

Product : Intel® Wireless-AC 9560
 Test Item : Harmonic Radiated Emission
 Test Mode : Mode 1: Transmit - BLE (2440MHz)
 Test Date : 2019/11/26

Horizontal

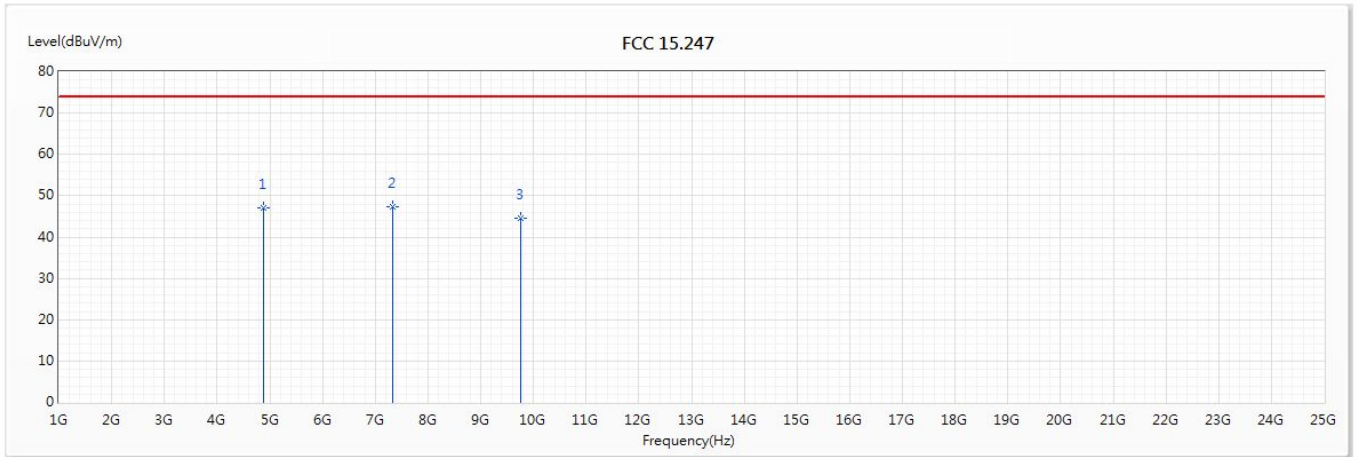

No	Frequency (MHz)	Emission Level (dBuV/m)	Limit (dBuV/m)	Margin (dB)	Reading Level (dBuV)	Correct Factor (dB/m)	Detector Type
1	4880	47.13	74.00	-26.87	51.50	-4.37	PK
* 2	7320	47.27	74.00	-26.73	47.95	-0.68	PK
3	9760	44.61	74.00	-29.39	42.59	2.02	PK

Note:

1. All Readings below 1GHz are Quasi-Peak, above 1GHz are performed with peak and/or average measurements as necessary.
2. Measurement Level = Reading Level + Correct Factor.
3. Correct Factor = Antenna factor + Cable loss – Amplifier gain.
4. The average measurement was not performed when the peak measured data under the limit of average detection.
5. The emission levels of other frequencies are very lower than the limit and not show in test report.

Product : Intel® Wireless-AC 9560
 Test Item : Harmonic Radiated Emission
 Test Mode : Mode 1: Transmit - BLE (2440MHz)
 Test Date : 2019/11/26

Vertical

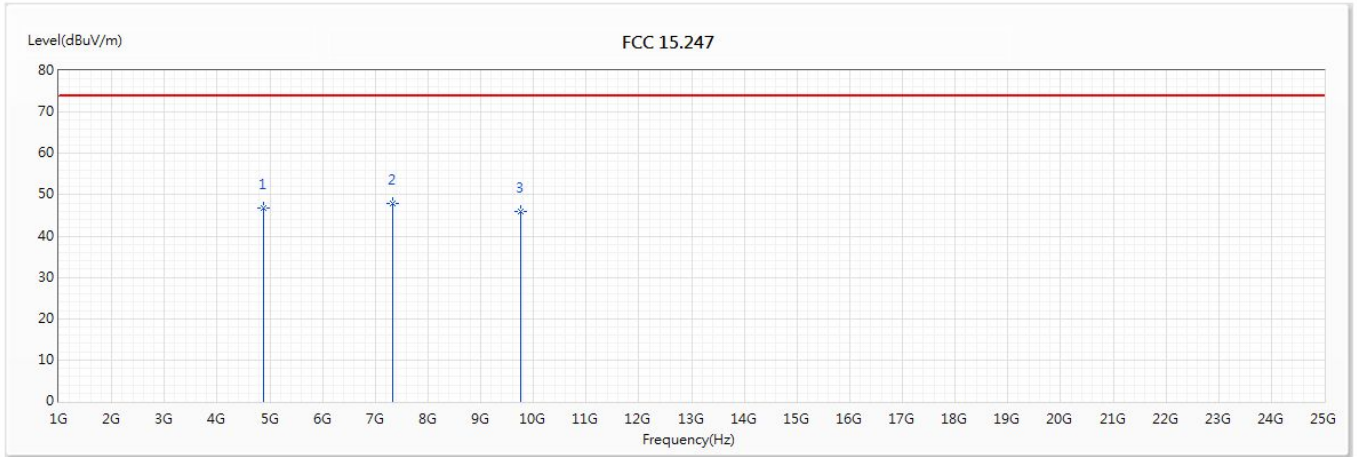

No	Frequency (MHz)	Emission Level (dBuV/m)	Limit (dBuV/m)	Margin (dB)	Reading Level (dBuV)	Correct Factor (dB/m)	Detector Type
1	4880	46.87	74.00	-27.13	51.24	-4.37	PK
* 2	7320	48.00	74.00	-26.00	48.68	-0.68	PK
3	9760	45.95	74.00	-28.05	43.93	2.02	PK

Note:

1. All Readings below 1GHz are Quasi-Peak, above 1GHz are performed with peak and/or average measurements as necessary.
2. Measurement Level = Reading Level + Correct Factor.
3. Correct Factor = Antenna factor + Cable loss – Amplifier gain.
4. The average measurement was not performed when the peak measured data under the limit of average detection.
5. The emission levels of other frequencies are very lower than the limit and not show in test report.

Product : Intel® Wireless-AC 9560
 Test Item : Harmonic Radiated Emission
 Test Mode : Mode 1: Transmit - BLE (2480MHz)
 Test Date : 2019/11/26

Horizontal

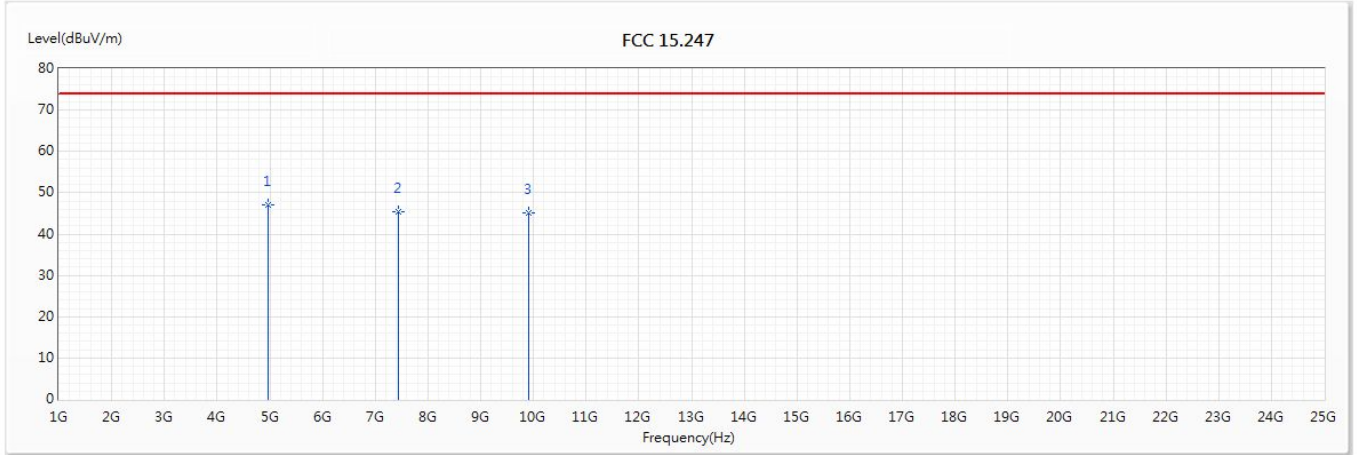

No	Frequency (MHz)	Emission Level (dBuV/m)	Limit (dBuV/m)	Margin (dB)	Reading Level (dBuV)	Correct Factor (dB/m)	Detector Type
* 1	4960	47.01	74.00	-26.99	51.31	-4.30	PK
2	7440	45.46	74.00	-28.54	46.23	-0.77	PK
3	9920	45.20	74.00	-28.80	43.28	1.92	PK

Note:

1. All Readings below 1GHz are Quasi-Peak, above 1GHz are performed with peak and/or average measurements as necessary.
2. Measurement Level = Reading Level + Correct Factor.
3. Correct Factor = Antenna factor + Cable loss – Amplifier gain.
4. The average measurement was not performed when the peak measured data under the limit of average detection.
5. The emission levels of other frequencies are very lower than the limit and not show in test report.

Product : Intel® Wireless-AC 9560
 Test Item : Harmonic Radiated Emission
 Test Mode : Mode 1: Transmit - BLE (2480MHz)
 Test Date : 2019/11/26

Vertical

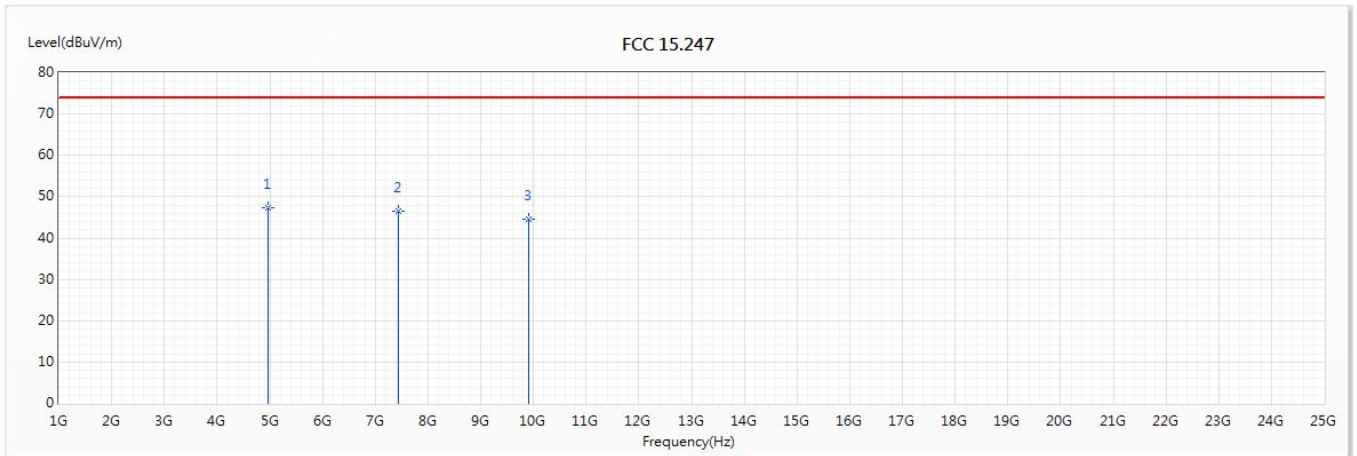

No	Frequency (MHz)	Emission Level (dBuV/m)	Limit (dBuV/m)	Margin (dB)	Reading Level (dBuV)	Correct Factor (dB/m)	Detector Type
* 1	4960	47.23	74.00	-26.77	51.53	-4.30	PK
2	7440	46.38	74.00	-27.62	47.15	-0.77	PK
3	9920	44.49	74.00	-29.51	42.57	1.92	PK

Note:

1. All Readings below 1GHz are Quasi-Peak, above 1GHz are performed with peak and/or average measurements as necessary.
2. Measurement Level = Reading Level + Correct Factor.
3. Correct Factor = Antenna factor + Cable loss – Amplifier gain.
4. The average measurement was not performed when the peak measured data under the limit of average detection.
5. The emission levels of other frequencies are very lower than the limit and not show in test report.

Product : Intel® Wireless-AC 9560
 Test Item : General Radiated Emission
 Test Mode : Mode 1: Transmit - BLE (2440MHz)
 Test Date : 2019/11/27

Horizontal

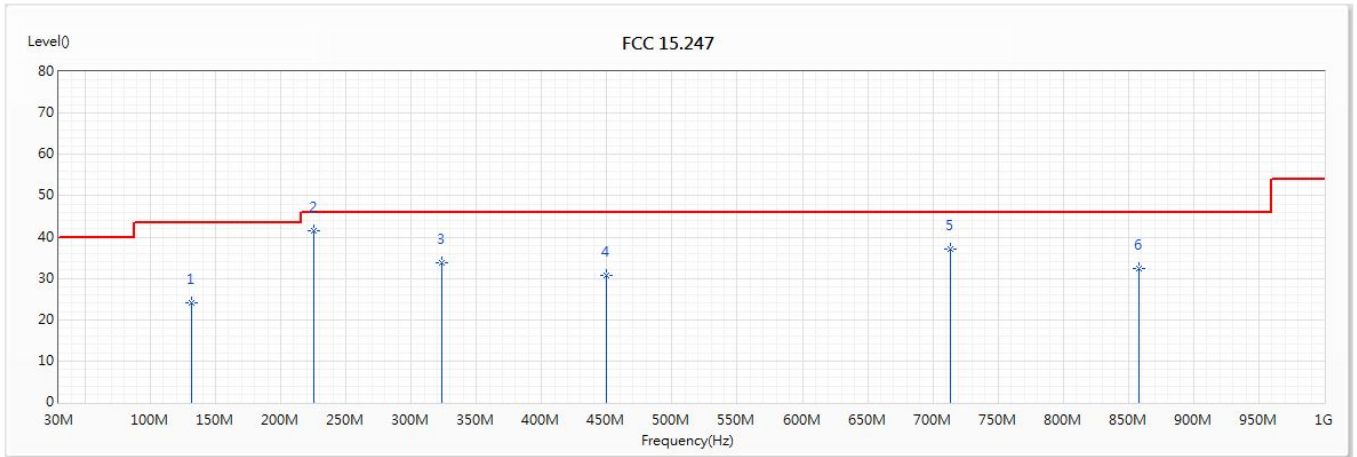

No	Frequency (MHz)	Emission Level (dBuV/m)	Limit (dBuV/m)	Margin (dB)	Reading Level (dBuV)	Correct Factor (dB/m)	Detector Type
1	131.85	24.04	43.50	-19.46	35.72	-11.68	QP
* 2	224.97	41.42	46.00	-4.58	53.99	-12.57	QP
3	323.91	33.81	46.00	-12.19	42.60	-8.79	QP
4	450.01	30.86	46.00	-15.14	36.90	-6.04	QP
5	713.85	37.11	46.00	-8.89	38.51	-1.40	QP
6	858.38	32.39	46.00	-13.61	32.31	0.08	QP

Note:

1. All Readings below 1GHz are Quasi-Peak, above 1GHz are performed with peak and/or average measurements as necessary.
2. Measurement Level = Reading Level + Correct Factor.
3. Correct Factor = Antenna factor + Cable loss – Amplifier gain.
4. The emission levels of other frequencies are very lower than the limit and not show in test report.
5. No emission found between lowest internal used/generated frequency to 30MHz.

Product : Intel® Wireless-AC 9560
 Test Item : General Radiated Emission
 Test Mode : Mode 1: Transmit - BLE (2440MHz)
 Test Date : 2019/11/27

Vertical

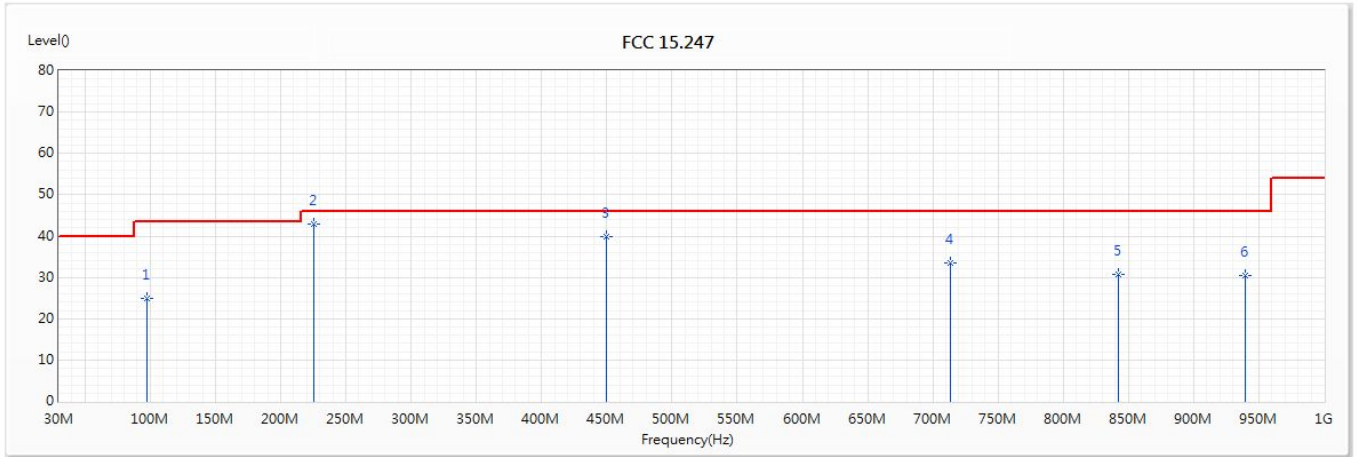

No	Frequency (MHz)	Emission Level (dBuV/m)	Limit (dBuV/m)	Margin (dB)	Reading Level (dBuV)	Correct Factor (dB/m)	Detector Type
1	97.9	25.01	43.50	-18.49	40.95	-15.94	QP
* 2	224.97	42.79	46.00	-3.21	55.36	-12.57	QP
3	450.01	39.92	46.00	-6.08	45.96	-6.04	QP
4	713.85	33.50	46.00	-12.50	34.90	-1.40	QP
5	841.89	30.65	46.00	-15.35	30.45	0.20	QP
6	939.86	30.41	46.00	-15.59	29.41	1.00	QP

Note:

1. All Readings below 1GHz are Quasi-Peak, above 1GHz are performed with peak and/or average measurements as necessary.
2. Measurement Level = Reading Level + Correct Factor.
3. Correct Factor = Antenna factor + Cable loss – Amplifier gain.
4. The emission levels of other frequencies are very lower than the limit and not show in test report.
5. No emission found between lowest internal used/generated frequency to 30MHz.

4. Band Edge

4.1. Test Setup

RF Conducted Measurement

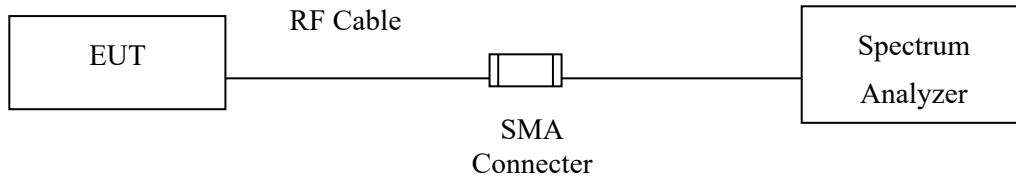

RF Radiated Measurement:

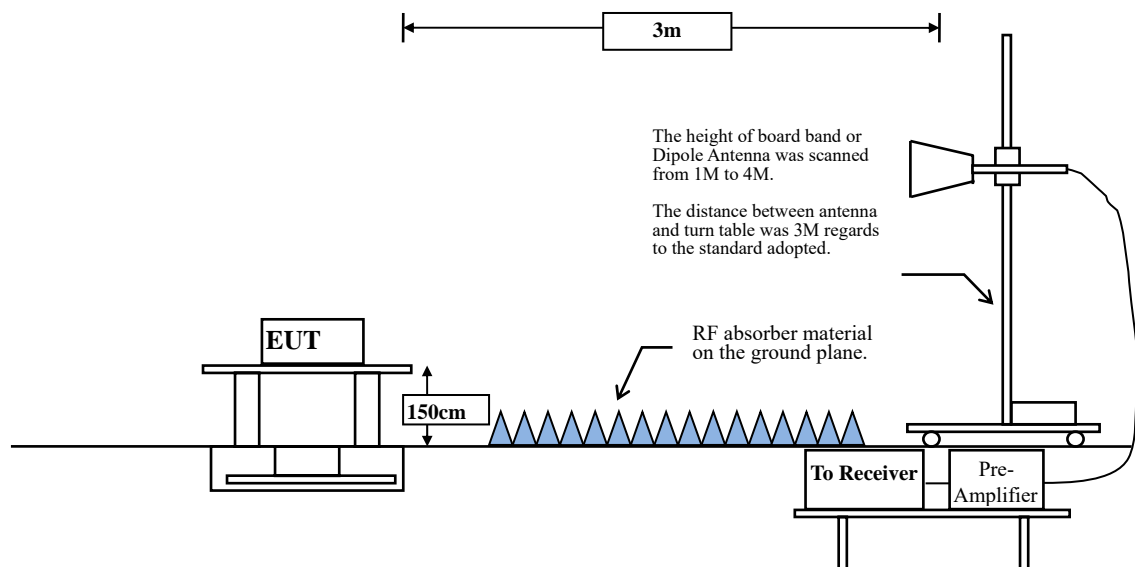

4.2. Limit

According to FCC Section 15.247(d). In any 100 kHz bandwidth outside the frequency band in which the spread spectrum or digitally modulated intentional radiator is operating, the radio frequency power that is produced by the intentional radiator shall be at least 20 dB below that in the 100 kHz bandwidth within the band that contains the highest level of the desired power, based on either an RF conducted or measurement, provided the transmitter demonstrates compliance with the peak conducted power limits. If the transmitter complies with the conducted power limits based on the use of RMS averaging over a time interval, the attenuation required under this paragraph shall be 30 dB instead of 20 dB. Attenuation below the general limits specified in Section 15.209(a) is not required. In addition, radiated emissions which fall in the restricted bands, as defined in Section 15.205(a), must also comply with the radiated emission limits specified in Section 15.209(a) (see Section 15.205(c)).

4.3. Test Procedure

The EUT was setup according to ANSI C63.10, 2013 and tested according to C63.10:2013 Section 11.12.1 for compliance to FCC 47CFR 15.247 requirements.

The EUT is placed on a turn table which is 1.5 meter above ground. The turn table is rotated 360 degrees to determine the position of the maximum emission level. The EUT was positioned such that the distance from antenna to the EUT was 3 meters.

The antenna is scanned from 1 meter to 4 meters to find out the maximum emission level. This is repeated for both horizontal and vertical polarization of the antenna. In order to find the maximum emission, all of the interface cables were manipulated according to ANSI C63.10:2013 on radiated measurement.

RBW and VBW Parameter setting:

According to C63.10 Section 11.12.2.4 Peak measurement procedure.

RBW = as specified in Table 1.

VBW \geq 3 x RBW.

Table 1 —RBW as a function of frequency

Frequency	RBW
9-150 kHz	200-300 Hz
0.15-30 MHz	9-10 kHz
30-1000 MHz	100-120 kHz
> 1000 MHz	1 MHz

According to C63.10 Section 11.12.2.5 Average measurement procedure.

RBW = 1MHz.

VBW = 10Hz, when duty cycle \geq 98 %

VBW \geq 1/T, when duty cycle < 98 %

(T refers to the minimum transmission duration over which the transmitter is on and is transmitting at its maximum power control level for the tested mode of operation.)

2.4GHz band	Duty Cycle (%)	T (ms)	1/T (Hz)	VBW (Hz)
BLE	89.29	2.2522	444	500

Note: Duty Cycle Refer to Section 5

4.4. Uncertainty

Conducted: \pm 1.23dB

Radiated:

Horizontal polarization : 1-18GHz: \pm 3.77dB

Vertical polarization : 1-18GHz : \pm 3.83dB

4.5. Test Result of Band Edge

Product : Intel® Wireless-AC 9560
 Test Item : Band Edge
 Test Mode : Mode 1: Transmit - BLE (2402MHz)
 Test Date : 2019/11/25

Horizontal

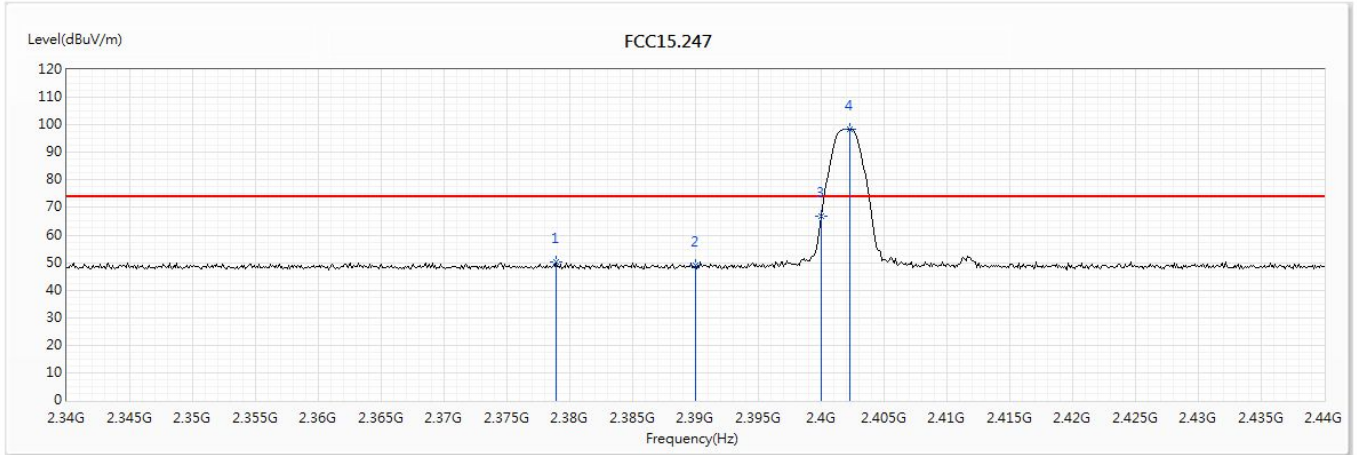

No	Frequency (MHz)	Emission Level (dBuV/m)	Limit (dBuV/m)	Margin (dB)	Reading Level (dBuV)	Correct Factor (dB/m)	Detector Type
1	2378.9	50.24	74.00	-23.76	38.72	11.52	PK
2	2390	48.90	74.00	-25.10	37.37	11.53	PK
3	2400	66.96	--	--	55.42	11.54	PK
4	2402.3	98.39	--	--	86.85	11.54	PK

Note:

1. All readings above 1GHz are performed with peak and/or average measurements as necessary.
2. Measurement Level = Reading Level + Correct Factor.
3. The average measurement was not performed when the peak measured data under the limit of average detection.

Product : Intel® Wireless-AC 9560
 Test Item : Band Edge
 Test Mode : Mode 1: Transmit - BLE (2402MHz)
 Test Date : 2019/11/25

Horizontal

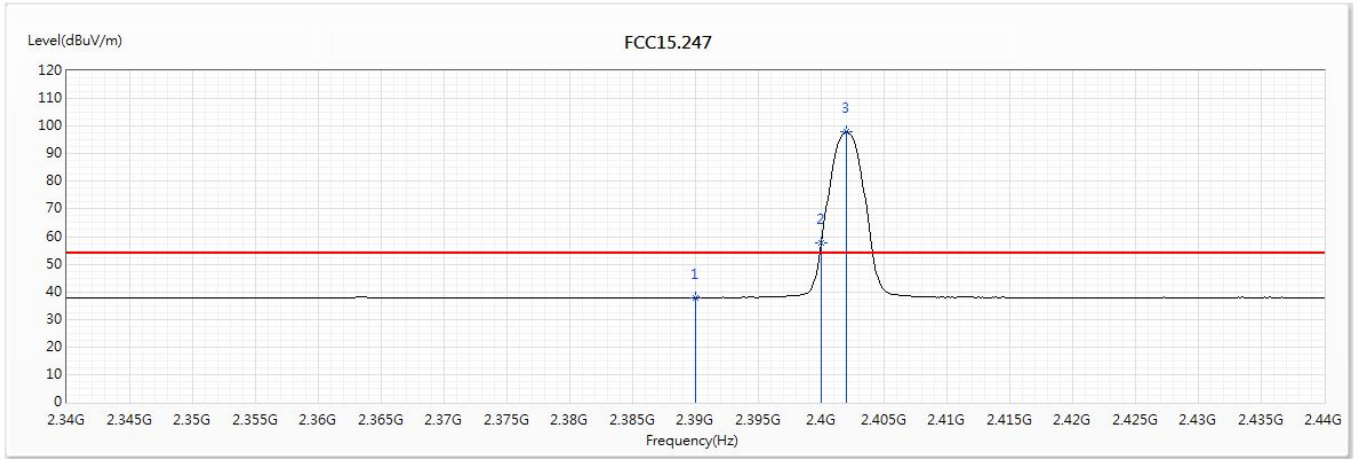

No	Frequency (MHz)	Emission Level (dBuV/m)	Limit (dBuV/m)	Margin (dB)	Reading Level (dBuV)	Correct Factor (dB/m)	Detector Type
1	2390	37.76	54.00	-16.24	26.23	11.53	AV
2	2400	57.71	--	--	46.17	11.54	AV
3	2402	98.04	--	--	86.50	11.54	AV

Note:

1. All readings above 1GHz are performed with peak and/or average measurements as necessary.
2. Measurement Level = Reading Level + Correct Factor.
3. The average measurement was not performed when the peak measured data under the limit of average detection.

Product : Intel® Wireless-AC 9560
 Test Item : Band Edge
 Test Mode : Mode 1: Transmit - BLE (2402MHz)
 Test Date : 2019/11/25

Vertical

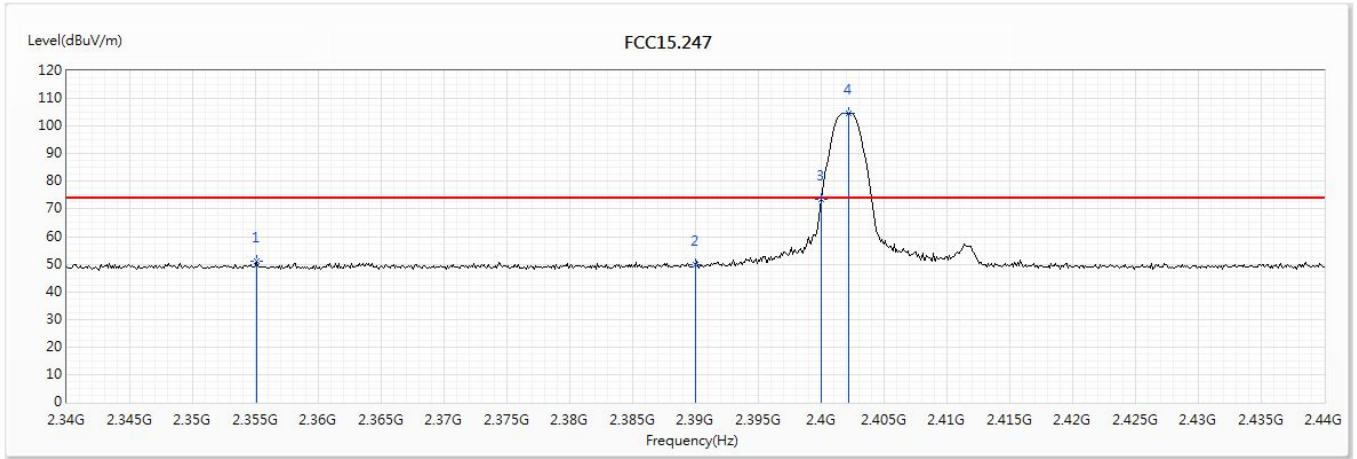

No	Frequency (MHz)	Emission Level (dBuV/m)	Limit (dBuV/m)	Margin (dB)	Reading Level (dBuV)	Correct Factor (dB/m)	Detector Type
1	2355.1	50.92	74.00	-23.08	39.44	11.48	PK
2	2390	50.01	74.00	-23.99	38.48	11.53	PK
3	2400	73.40	--	--	61.86	11.54	PK
4	2402.2	104.74	--	--	93.20	11.54	PK

Note:

1. All readings above 1GHz are performed with peak and/or average measurements as necessary.
2. Measurement Level = Reading Level + Correct Factor.
3. The average measurement was not performed when the peak measured data under the limit of average detection.

Product : Intel® Wireless-AC 9560
 Test Item : Band Edge
 Test Mode : Mode 1: Transmit - BLE (2402MHz)
 Test Date : 2019/11/25

Vertical

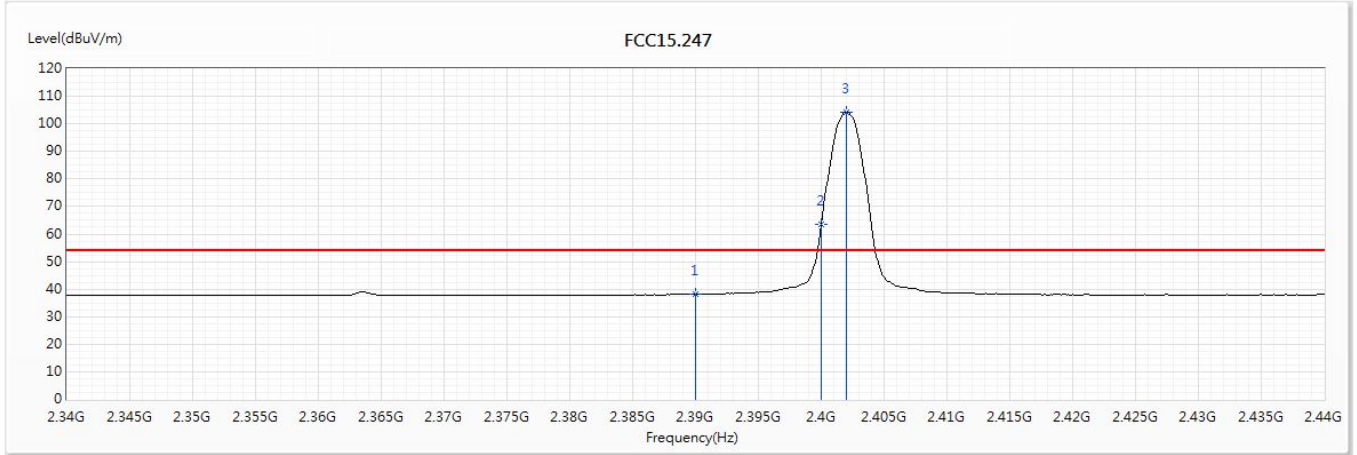

No	Frequency (MHz)	Emission Level (dBuV/m)	Limit (dBuV/m)	Margin (dB)	Reading Level (dBuV)	Correct Factor (dB/m)	Detector Type
1	2390	38.17	54.00	-15.83	26.64	11.53	AV
2	2400	63.59	--	--	52.05	11.54	AV
3	2402	104.38	--	--	92.84	11.54	AV

Note:

1. All readings above 1GHz are performed with peak and/or average measurements as necessary.
2. Measurement Level = Reading Level + Correct Factor.
3. The average measurement was not performed when the peak measured data under the limit of average detection.

Product : Intel® Wireless-AC 9560
 Test Item : Band Edge
 Test Mode : Mode 1: Transmit - BLE (2480MHz)
 Test Date : 2019/11/25

Horizontal

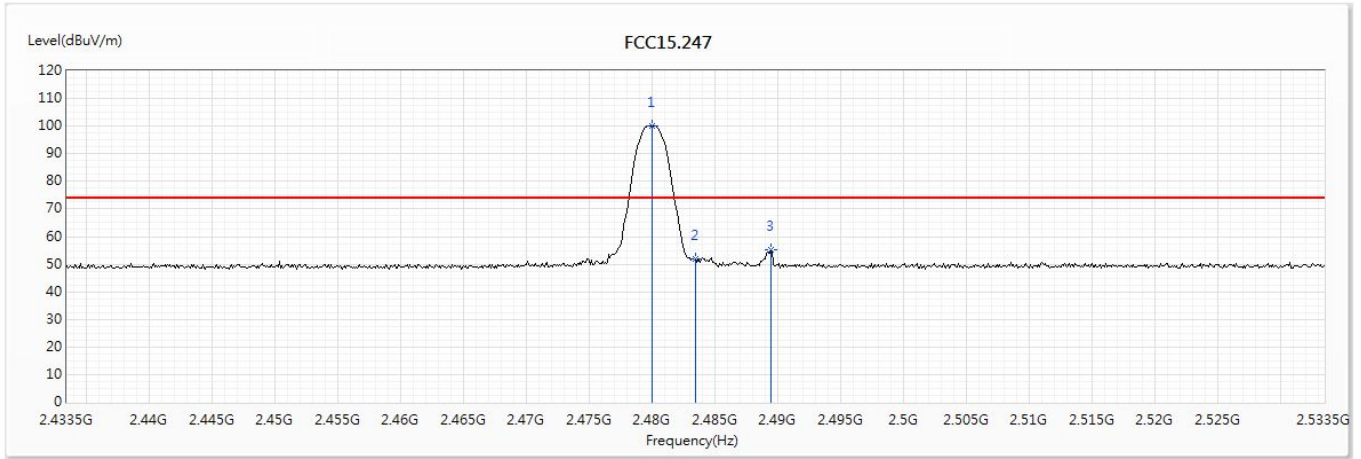

No	Frequency (MHz)	Emission Level (dBuV/m)	Limit (dBuV/m)	Margin (dB)	Reading Level (dBuV)	Correct Factor (dB/m)	Detector Type
1	2480	99.98	--	--	88.31	11.67	PK
2	2483.5	52.00	74.00	-22.00	40.32	11.68	PK
3	2489.5	55.20	74.00	-18.80	43.51	11.69	PK

Note:

1. All readings above 1GHz are performed with peak and/or average measurements as necessary.
2. Measurement Level = Reading Level + Correct Factor.
3. The average measurement was not performed when the peak measured data under the limit of average detection.

Product : Intel® Wireless-AC 9560
 Test Item : Band Edge
 Test Mode : Mode 1: Transmit - BLE (2480MHz)
 Test Date : 2019/11/25

Horizontal

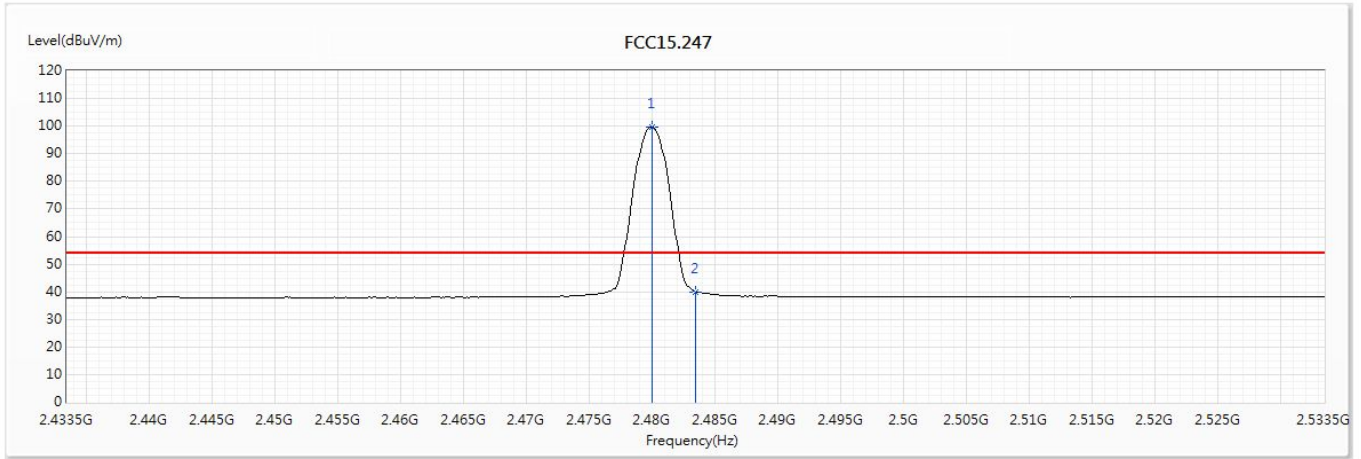

No	Frequency (MHz)	Emission Level (dBuV/m)	Limit (dBuV/m)	Margin (dB)	Reading Level (dBuV)	Correct Factor (dB/m)	Detector Type
1	2480	99.60	--	--	87.93	11.67	AV
2	2483.5	40.01	54.00	-13.99	28.33	11.68	AV

Note:

1. All readings above 1GHz are performed with peak and/or average measurements as necessary.
2. Measurement Level = Reading Level + Correct Factor.
3. The average measurement was not performed when the peak measured data under the limit of average detection.

Product : Intel® Wireless-AC 9560
 Test Item : Band Edge
 Test Mode : Mode 1: Transmit - BLE (2480MHz)
 Test Date : 2019/11/25

Vertical

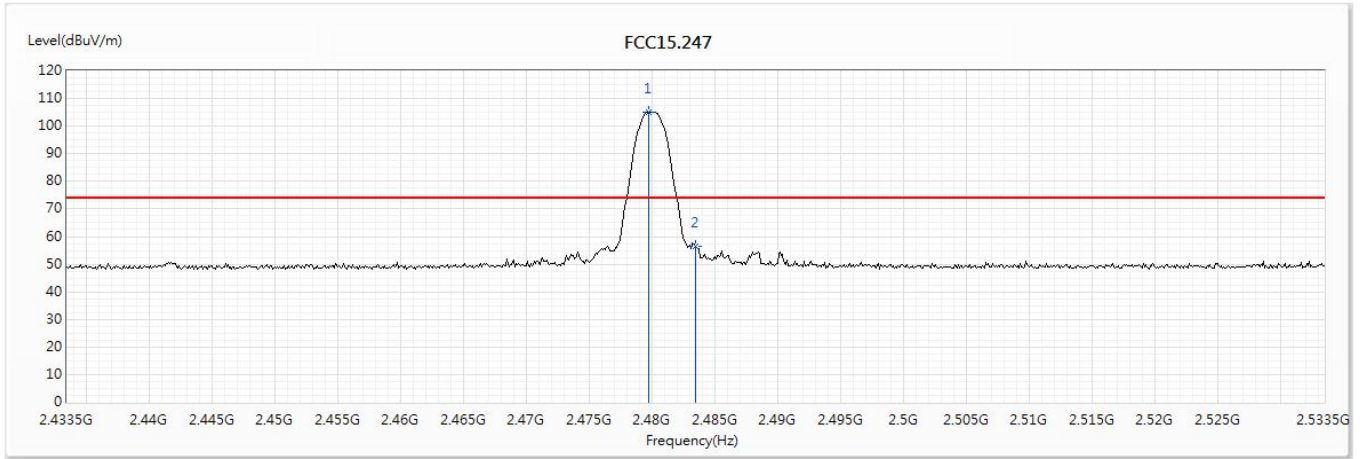

No	Frequency (MHz)	Emission Level (dBuV/m)	Limit (dBuV/m)	Margin (dB)	Reading Level (dBuV)	Correct Factor (dB/m)	Detector Type
1	2479.8	105.01	--	--	93.34	11.67	PK
2	2483.5	56.45	74.00	-17.55	44.77	11.68	PK

Note:

1. All readings above 1GHz are performed with peak and/or average measurements as necessary.
2. Measurement Level = Reading Level + Correct Factor.
3. The average measurement was not performed when the peak measured data under the limit of average detection.

Product : Intel® Wireless-AC 9560
 Test Item : Band Edge
 Test Mode : Mode 1: Transmit - BLE (2480MHz)
 Test Date : 2019/11/25

Vertical

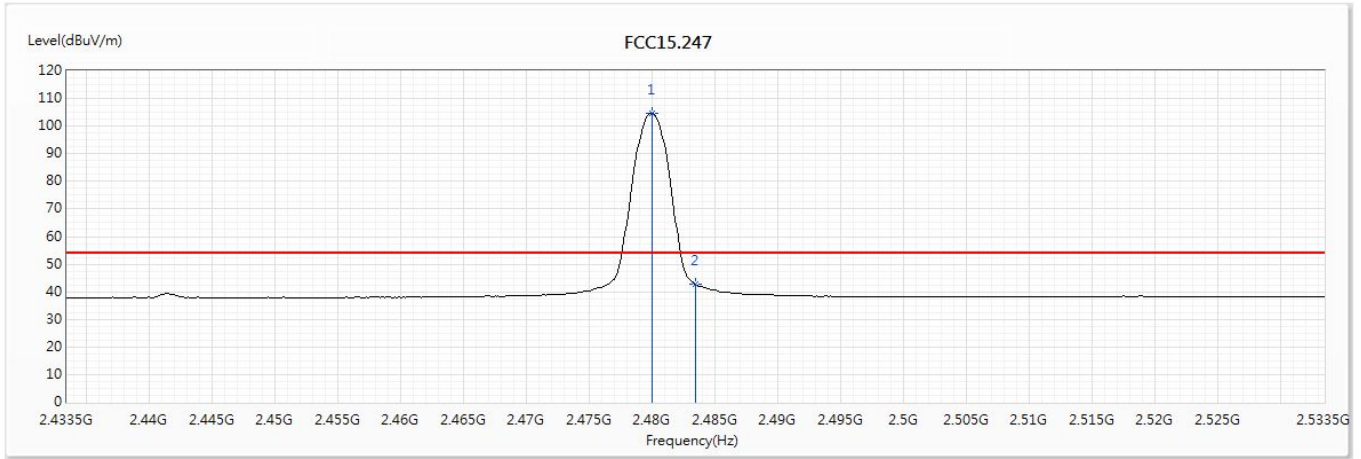

No	Frequency (MHz)	Emission Level (dBuV/m)	Limit (dBuV/m)	Margin (dB)	Reading Level (dBuV)	Correct Factor (dB/m)	Detector Type
1	2480	104.64	--	--	92.97	11.67	AV
2	2483.5	42.57	54.00	-11.43	30.89	11.68	AV

Note:

1. All readings above 1GHz are performed with peak and/or average measurements as necessary.
2. Measurement Level = Reading Level + Correct Factor.
3. The average measurement was not performed when the peak measured data under the limit of average detection.

5. Duty Cycle

5.1. Test Setup

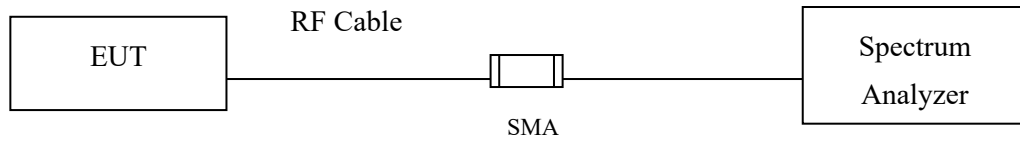

5.2. Test Procedure

The EUT was setup according to ANSI C63.10 2013; tested according to ANSI C63.10 2013 for compliance to FCC 47CFR 15.247 requirements.

5.3. Uncertainty

$\pm 2.31\text{msec}$

5.4. Test Result of Duty Cycle

Product : Intel® Wireless-AC 9560
 Test Item : Duty Cycle
 Test Mode : Mode 1: Transmit - BLE

Duty Cycle Formula:

$$\text{Duty Cycle} = \text{Ton} / (\text{Ton} + \text{Toff})$$

$$\text{Duty Factor} = 10 \text{ Log} (1/\text{Duty Cycle})$$

Results:

2.4GHz band	Ton (ms)	Ton + Toff (ms)	Duty Cycle (%)	Duty Factor (dB)
BLE	2.2522	2.5222	89.29	0.49

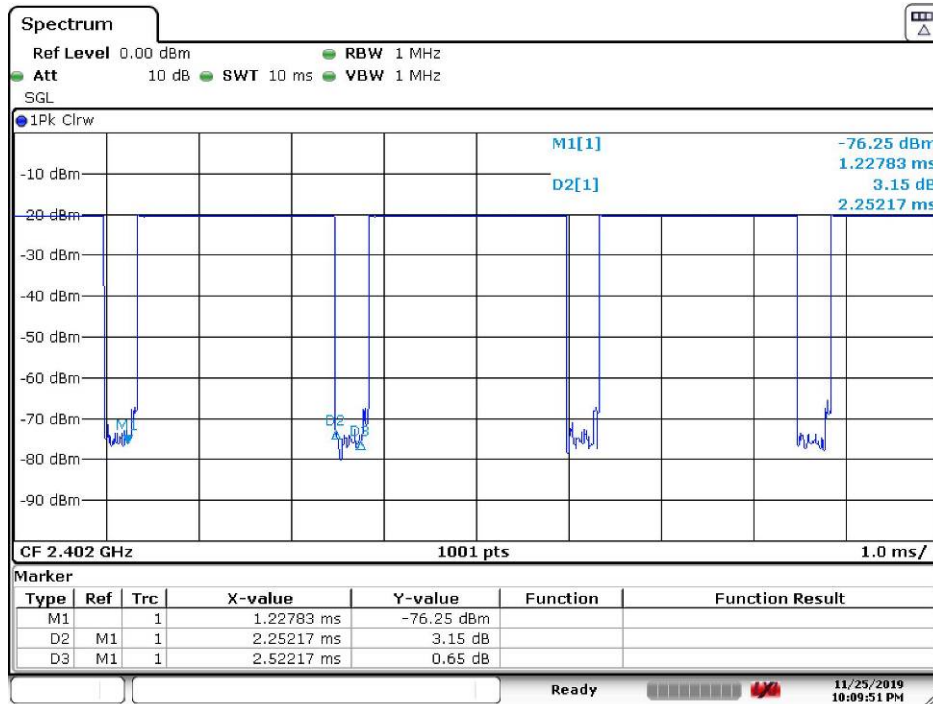

Date: 25.NOV.2019 22:09:51

6. EMI Reduction Method During Compliance Testing

No modification was made during testing.