

# FCC Test Report

## (Class II Permissive Change)

Product Name	Intel® Wireless-AC 9560
Model No.	9560NGW
FCC ID.	2AKHF9560NG

Applicant	TONGFANG HONGKONG (SUZHOU) LIMITED
Address	No. 10 Plant, Jianwu Phase III, Western Zone, Suzhou Industrial Park, Suzhou City, Jiangsu Province, 215000 China

Date of Receipt	Nov. 04, 2019
Issued Date	Dec. 26, 2019
Report No.	19B0034R-RFUSP11V00
Report Version	V1.0



The test results relate only to the samples tested.

The test results shown in the test report are traceable to the national/international standard through the calibration report of the equipment and evaluated measurement uncertainty herein.

This report must not be used to claim product endorsement by TAF or any agency of the government.

The test report shall not be reproduced without the written approval of DEKRA Testing and Certification Co., Ltd.

# Test Report

Issued Date: Dec. 26, 2019

Report No.: 19B0034R-RFUSP11V00



Product Name	Intel® Wireless-AC 9560
Applicant	TONGFANG HONGKONG (SUZHOU) LIMITED
Address	No. 10 Plant, Jianwu Phase III, Western Zone, Suzhou Industrial Park, Suzhou City, Jiangsu Province, 215000 China
Manufacturer	INTEL CORPORATION SAS
Model No.	9560NGW
FCC ID.	2AKHF9560NG
EUT Rated Voltage	DC 3.3V
EUT Test Voltage	DC 3.3V (Power By Test Fixture)
Trade Name	Intel
Applicable Standard	FCC CFR Title 47 Part 15 Subpart C ANSI C63.4: 2014, ANSI C63.10: 2013
Test Result	Complied

Documented By :



( Adm. Assistant / Ida Tung )

Tested By :



( Engineer / Yulin Chen )

Approved By :



( Director / Vincent Lin )

## TABLE OF CONTENTS

Description	Page
<b>1. GENERAL INFORMATION .....</b>	<b>4</b>
1.1. EUT Description.....	4
1.2. Operational Description.....	6
1.3. Tested System Details.....	7
1.4. Configuration of Tested System .....	7
1.5. EUT Exercise Software .....	7
1.6. Test Facility .....	8
1.7. List of Test Equipment.....	9
1.8. Uncertainty .....	10
<b>2. PEAK POWER OUTPUT .....</b>	<b>11</b>
2.1. Test Setup .....	11
2.2. Limit .....	11
2.3. Test Procedure .....	11
2.4. Uncertainty .....	11
2.5. Test Result of Peak Power Output.....	12
<b>3. RADIATED EMISSION .....</b>	<b>14</b>
3.1. Test Setup .....	14
3.2. Limits.....	15
3.3. Test Procedure .....	16
3.4. Uncertainty .....	16
3.5. Test Result of Radiated Emission.....	17
<b>4. BAND EDGE .....</b>	<b>33</b>
4.1. Test Setup .....	33
4.2. Limit .....	34
4.3. Test Procedure .....	34
4.4. Uncertainty .....	34
4.5. Test Result of Band Edge .....	35
<b>5. DUTY CYCLE.....</b>	<b>43</b>
5.1. Test Setup .....	43
5.2. Uncertainty .....	43
5.3. Test Result of Duty Cycle.....	44
<b>6. EMI REDUCTION METHOD DURING COMPLIANCE TESTING .....</b>	<b>46</b>
Attachment 1: EUT Test Photographs	
Attachment 2: EUT Detailed Photographs	

## 1. GENERAL INFORMATION

### 1.1. EUT Description

Product Name	Intel® Wireless-AC 9560
Trade Name	Intel
Model No.	9560NGW
FCC ID.	2AKHF9560NG
Frequency Range	2402-2480MHz
Channel Number	79
Type of Modulation	FHSS: GFSK(1Mbps) / $\pi$ /4DQPSK(2Mbps) / 8DPSK(3Mbps)
Antenna Type	PIFA Antenna
Channel Control	Auto
Antenna Gain	Refer to the table “Antenna List”
Test Platform	Product name: Notebook PC Brand: TONGFANG Model number: GM7CP6P/GM7CP0P/GM7CP7P
Power Adapter	MFR: Chicony, M/N: A17-230P1A Input: AC 100-240V~3.5A, 50-60Hz Output: DC 19.5V, 11.8A, 230W Cable Out: Shielded, 1.1m, with two ferrite cores bonded.

#### Antenna List

No.	Manufacturer	Part No.	Antenna Type	Peak Gain
1.	WGT	ANTRG7P119-0301 (Main) ANTRG7P119-0302 (Aux)	PIFA Antenna	4.83dBi for 2.4 GHz

Note: The antenna of EUT conforms to FCC 15.203.

## Center Frequency of Each Channel:

Channel	Frequency	Channel	Frequency	Channel	Frequency	Channel	Frequency
Channel 00:	2402 MHz	Channel 20:	2422 MHz	Channel 40:	2442 MHz	Channel 60:	2462 MHz
Channel 01:	2403 MHz	Channel 21:	2423 MHz	Channel 41:	2443 MHz	Channel 61:	2463 MHz
Channel 02:	2404 MHz	Channel 22:	2424 MHz	Channel 42:	2444 MHz	Channel 62:	2464 MHz
Channel 03:	2405 MHz	Channel 23:	2425 MHz	Channel 43:	2445 MHz	Channel 63:	2465 MHz
Channel 04:	2406 MHz	Channel 24:	2426 MHz	Channel 44:	2446 MHz	Channel 64:	2466 MHz
Channel 05:	2407 MHz	Channel 25:	2427 MHz	Channel 45:	2447 MHz	Channel 65:	2467 MHz
Channel 06:	2408 MHz	Channel 26:	2428 MHz	Channel 46:	2448 MHz	Channel 66:	2468 MHz
Channel 07:	2409 MHz	Channel 27:	2429 MHz	Channel 47:	2449 MHz	Channel 67:	2469 MHz
Channel 08:	2410 MHz	Channel 28:	2430 MHz	Channel 48:	2450 MHz	Channel 68:	2470 MHz
Channel 09:	2411 MHz	Channel 29:	2431 MHz	Channel 49:	2451 MHz	Channel 69:	2471 MHz
Channel 10:	2412 MHz	Channel 30:	2432 MHz	Channel 50:	2452 MHz	Channel 70:	2472 MHz
Channel 11:	2413 MHz	Channel 31:	2433 MHz	Channel 51:	2453 MHz	Channel 71:	2473 MHz
Channel 12:	2414 MHz	Channel 32:	2434 MHz	Channel 52:	2454 MHz	Channel 72:	2474 MHz
Channel 13:	2415 MHz	Channel 33:	2435 MHz	Channel 53:	2455 MHz	Channel 73:	2475 MHz
Channel 14:	2416 MHz	Channel 34:	2436 MHz	Channel 54:	2456 MHz	Channel 74:	2476 MHz
Channel 15:	2417 MHz	Channel 35:	2437 MHz	Channel 55:	2457 MHz	Channel 75:	2477 MHz
Channel 16:	2418 MHz	Channel 36:	2438 MHz	Channel 56:	2458 MHz	Channel 76:	2478 MHz
Channel 17:	2419 MHz	Channel 37:	2439 MHz	Channel 57:	2459 MHz	Channel 77:	2479 MHz
Channel 18:	2420 MHz	Channel 38:	2440 MHz	Channel 58:	2460 MHz	Channel 78:	2480 MHz
Channel 19:	2421 MHz	Channel 39:	2441 MHz	Channel 59:	2461 MHz		

## Note:

- The EUT is an Intel® Wireless-AC 9560 with a built-in WLAN (802.11a/b/g/n/ac) with Bluetooth (5.0 and V3.0+HS, V2.1+EDR) transceiver, this report for Bluetooth V3.0+HS, V2.1+EDR.
- These tests were conducted on a sample for the purpose of demonstrating compliance of transmitter with Part 15 Subpart C Paragraph 15.247 for spread spectrum devices.
- Regarding to the operation frequency, the lowest, middle and highest frequency are selected to perform the test.
- This is to request a Class II permissive change for FCC ID: 2AKHF9560NG, originally granted on 03/16/2018.

(1) The major change filed under this application is:

Change #1: Additional Chassis is added, Product name: Notebook PC, Brand: TONGFANG,  
Model number: GM7CP6P/GM7CP0P/GM7CP7P

All models are listed as below:

Brand	Model No.	Difference
TONGFANG	GM7CP0P	All models are electrically identical and different model names are used to distinguish between different GPU specifications.
	GM7CP6P	
	GM7CP7P	

#2: Reduce the Output Power through firmware, and SAR measurement were evaluated.  
(Only reduce Wi-Fi Output Power, Bluetooth Output Power haven't changes).

#3: Addition an Antennas, the antenna type is same, the antenna gain is higher than the original application.

Test Mode	Mode 1: Transmit - 1Mbps Mode 2: Transmit - 3Mbps
-----------	--

### 1.3. Tested System Details

The types for all equipment, plus descriptions of all cables used in the tested system (including inserted cards) are:

Product	Manufacturer	Model No.	Serial No.	Power Cord					
1   Monitor	Lenovo	P27u	V302ZGXP	Non-Shielded, 1.8m					
2   HDD	Lenovo	F309	GXB0H43289Z152DT85	N/A					
3   HDD	Transcend	TS1TSJ25M3	D468623807	N/A					
4   Microphone & Earphone	Verbatim	N/A	N/A	N/A					
5   Microphone & Earphone	Verbatim	N/A	N/A	N/A					
6   HDD	Transcend	TS1TSJ25M3	D468623812	N/A					
7   HDD	Transcend	TS1TSJ25M3	D468623820	N/A </tr <tr> <td>8   Notebook PC</td> <td>ASUS</td> <td>CP7P</td> <td>N/A</td> <td>N/A</td> </tr>	8   Notebook PC	ASUS	CP7P	N/A	N/A
8   Notebook PC	ASUS	CP7P	N/A	N/A					

Signal Cable Type	Signal cable Description
A   HDMI Cable	Non-shielded, 1.8m
B   Type C Cable	Shielded, 0.5m
C   USB Cable	Shielded, 1.2m
D   Microphone & Earphone Cable	Non-shielded, 1.2m
E   Microphone & Earphone Cable	Non-shielded, 1.2m
F   USB Cable	Shielded, 1.2m
G   USB Cable	Shielded, 1.2m

### 1.4. Configuration of Tested System

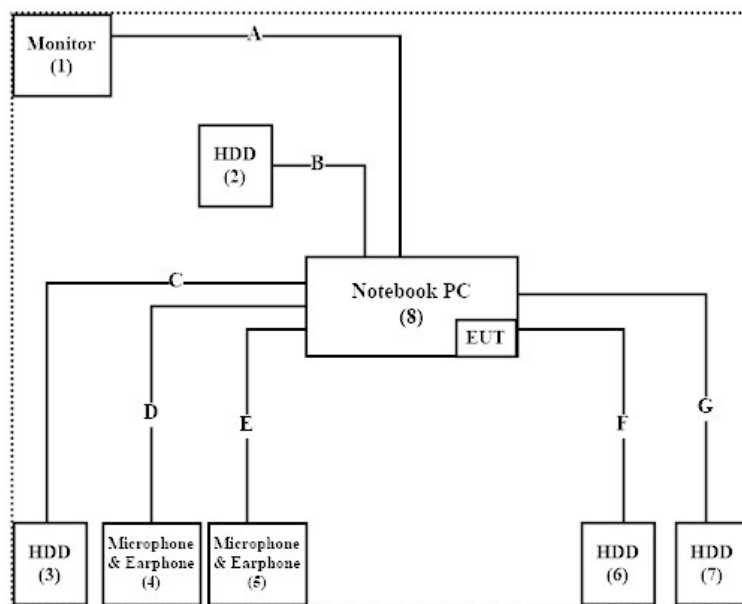

### 1.5. EUT Exercise Software

1. Setup the EUT as shown in Section 1.4.
2. Execute software “DRTU (Ver 11.1832.0-08048)” on the notebook PC.
3. Configure the test mode, the test channel, and the data rate.
4. Press “OK” to start the continuous Transmit.
5. Verify that the EUT works properly.

## 1.6. Test Facility

Ambient conditions in the laboratory:

Performed Item	Items	Required	Actual
Radiated Emission	Temperature (°C)	10~40 °C	20.6 °C
	Humidity (%RH)	10~90 %	73.9 %
Conductive	Temperature (°C)	10~40 °C	22.7 °C
	Humidity (%RH)	10~90 %	57.9 %

**USA : FCC Registration Number: TW0023**

**Canada : IC Registration Number: 4075A**

Site Description : Accredited by TAF  
Accredited Number: 3023

Test Laboratory : DEKRA Testing and Certification Co., Ltd  
Address : No.159, Sec. 2, Wenhua 1st Rd., Linkou Dist.,  
New Taipei City 24457, Taiwan, R.O.C.

Phone number : 886-2-2602-7968  
Fax number : 866-2-2602-3286  
Email address : [info.tw@dekra.com](mailto:info.tw@dekra.com)  
Website : <http://www.dekra.com.tw>

## 1.7. List of Test Equipment

### For Conducted measurements /ASR2

	Equipment	Manufacturer	Model No.	Serial No.	Cali. Data	Due. Data
X	Spectrum Analyzer	R&S	FSV30	103466	2019.12.16	2020.12.15
X	Peak Power Analyzer	KEYSIGHT	8900B	MY51000539	2019.05.06	2020.05.05
X	Power Sensor	KEYSIGHT	N1923A	MY59240002	2019.06.12	2020.06.11
X	Power Sensor	KEYSIGHT	N1923A	MY59240003	2019.06.13	2020.06.12
	Bluetooth Tester	R&S	CBT	101238	2019.01.21	2020.01.20

Note:

1. All equipments are calibrated every one year.
2. The test instruments marked with "X" are used to measure the final test results.
3. Test Software version : DEKRA Conduction Test System V9.0.5

### For Radiated measurements /ACB1

	Equipment	Manufacturer	Model No.	Serial No.	Cali. Data	Due. Data
X	Loop Antenna	AMETEK	HLA6121	49611	2019.02.22	2020.02.21
X	Bi-Log Antenna	SCHWARZBECK	VULB9168	9168-953	2019.01.04	2020.01.03
X	Bi-Log Antenna	SCHWARZBECK	VULB9168	9168-953	2019.01.04	2020.01.03
X	Horn Antenna	ETS-Lindgren	3117	00203800	2019.12.12	2020.12.11
X	Horn Antenna	ETS-Lindgren	3117	00201259	2019.10.15	2020.10.14
X	Horn Antenna	ETS-Lindgren	3117	00203761	2019.10.31	2020.10.30
X	Horn Antenna	Com-Power	AH-840	101087	2019.05.30	2020.05.29
X	Pre-Amplifier	EMCI	EMC001330	980301	2019.05.20	2020.05.19
X	Pre-Amplifier	EMCI	EMC001330	980316	2019.06.14	2020.06.13
X	Pre-Amplifier	EMCI	EMC051835SE	980311	2019.06.13	2020.06.12
X	Pre-Amplifier	EMCI	EMC05820SE	980308	2019.09.02	2020.09.01
X	Pre-Amplifier	EMCI	EMC05820SE	980310	2019.06.24	2020.06.23
X	Pre-Amplifier	EMCI	EMC05835SE	980312	2019.06.03	2020.06.02
X	Pre-Amplifier	EMCI	EMC184045SE	980314	2019.05.28	2020.05.27
X	Filter	MICRO TRONICS	BRM50702	G251	2019.09.03	2020.09.02
	Filter	MICRO TRONICS	BRM50716	G188	2019.09.03	2020.09.02
X	EMI Test Receiver	R&S	ESR7	101602	2019.12.16	2020.12.15
X	Spectrum Analyzer	R&S	FSV40	101148	2019.02.08	2020.02.07
X	Coaxial Cable	SUHNER	SUCOFLEX 106	RF002	2019.07.03	2020.07.02
X	Mircoflex Cable	HUBER SUHNER	SUCOFLEX 102	MY3381/2	2019.05.28	2020.05.27

Note:

1. All equipments are calibrated every one year.
2. The test instruments marked with "X" are used to measure the final test results.
3. Test Software version : DEKRA Testing System V1.0.0.20



## 1.8. Uncertainty

Uncertainties have been calculated according to the DEKRA internal document, and is described in each test chapter of this report.

The reported expanded uncertainties are based on a standard uncertainty multiplied by a coverage factor of  $k=2$ , providing a level of confidence of approximately 95%.

Measurement uncertainties evaluated for each testing system and associated connections are given here to provide the system information for reference. Compliance determinations do not take into account measurement uncertainties for each testing system, but are based on the results of the compliance measurement.

## 2. Peak Power Output

### 2.1. Test Setup

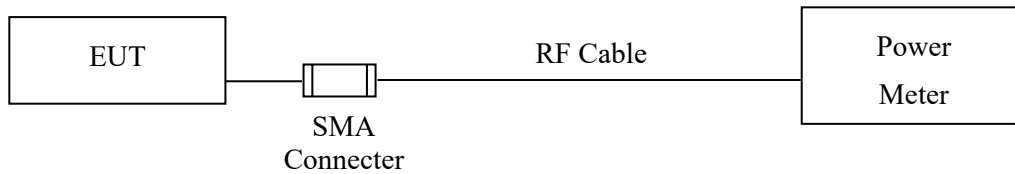

### 2.2. Limit

The maximum peak power shall be less 1Watt.

### 2.3. Test Procedure

Tested according to FHSS test procedure of KDB 558074 section 9 (b for compliance to FCC 47CFR 15.247 requirements.

### 2.4. Uncertainty

$\pm 0.86$  dB

## 2.5. Test Result of Peak Power Output

Product : Intel® Wireless-AC 9560  
Test Item : Peak Power Output  
Test Mode : Mode 1: Transmit - 1Mbps  
Test Date : 2019/11/27

Channel No.	Frequency (MHz)	Measurement (dBm)	Required Limit	Result
Channel 00	2402.00	8.25	1 Watt= 30 dBm	Pass
Channel 39	2441.00	9.24	1 Watt= 30 dBm	Pass
Channel 78	2480.00	9.98	1 Watt= 30 dBm	Pass

Product : Intel® Wireless-AC 9560  
Test Item : Peak Power Output  
Test Mode : Mode 2: Transmit - 3Mbps  
Test Date : 2019/11/27

Channel No.	Frequency (MHz)	Measurement (dBm)	Required Limit	Result
Channel 00	2402.00	6.68	1 Watt= 30 dBm	Pass
Channel 39	2441.00	7.32	1 Watt= 30 dBm	Pass
Channel 78	2480.00	7.57	1 Watt= 30 dBm	Pass

### 3. Radiated Emission

#### 3.1. Test Setup

Radiated Emission Under 30MHz

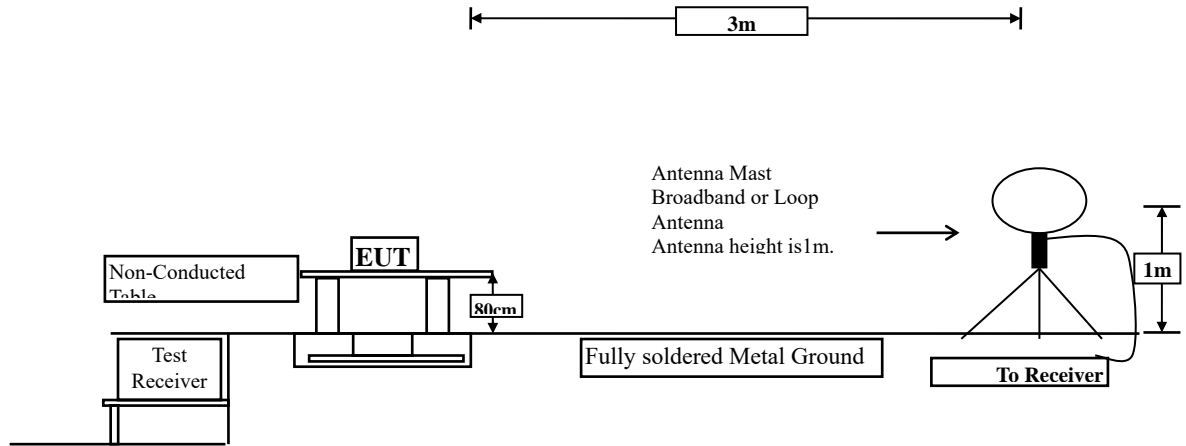

Radiated Emission Below 1GHz

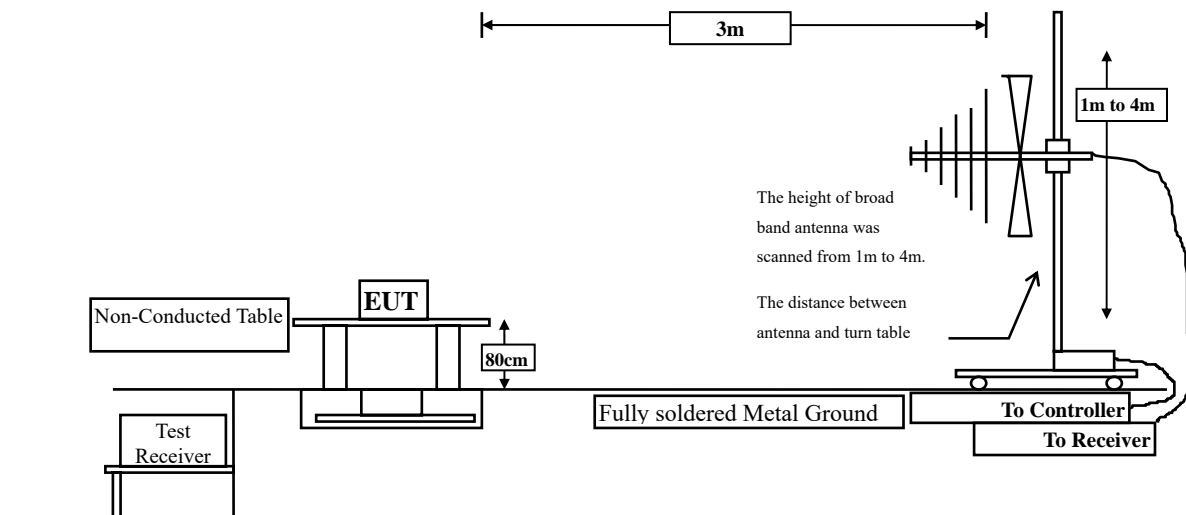

Radiated Emission Above 1GHz

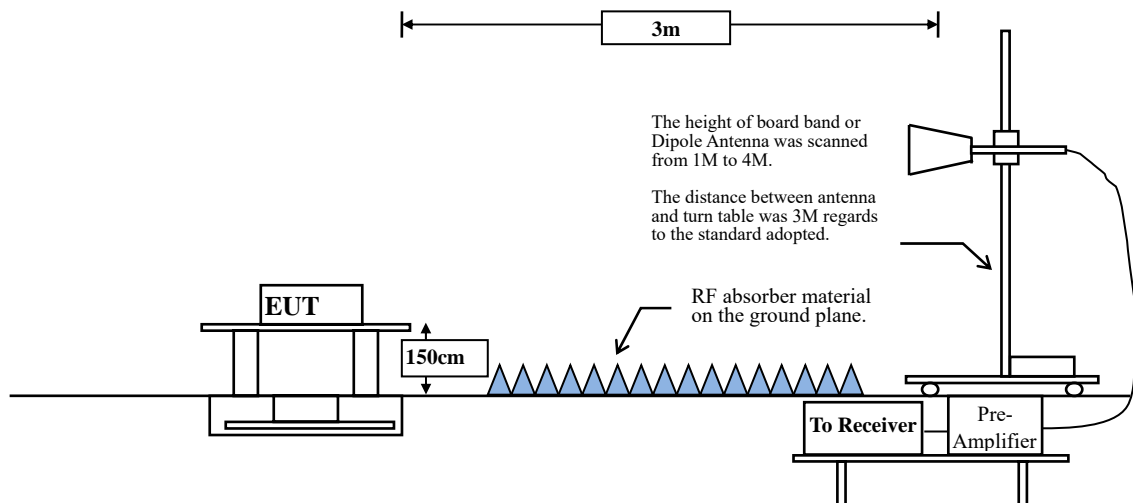

### 3.2. Limits

#### ➤ General Radiated Emission Limits

Emissions radiated outside of the specified frequency bands, except for harmonics, shall be attenuated by at least 20dB below the level of the fundamental or to the general radiated emission limits in paragraph 15.209, whichever is the lesser attenuation.

<b>FCC Part 15 Subpart C Paragraph 15.209 Limits</b>		
Frequency MHz	Field strength (microvolts/meter)	Measurement distance (meter)
0.009-0.490	2400/F(kHz)	300
0.490-1.705	24000/F(kHz)	30
1.705-30	30	30
30-88	100	3
88-216	150	3
216-960	200	3
Above 960	500	3

- Remarks:
1. RF Voltage (dBuV) = 20 log RF Voltage (uV)
  2. In the Above Table, the tighter limit applies at the band edges.
  3. Distance refers to the distance in meters between the measuring instrument antenna and the closed point of any part of the device or system.

### 3.3. Test Procedure

The EUT was setup according to ANSI C63.10, 2013 and tested compliance to FCC 47CFR 15.247 requirements.

Measuring the frequency range below 1GHz, the EUT is placed on a turn table which is 0.8 meter above ground, when measuring the frequency range above 1GHz, the EUT is placed on a turn table which is 1.5 meter above ground.

The turn table is rotated 360 degrees to determine the position of the maximum emission level.

The EUT was positioned such that the distance from antenna to the EUT was 3 meters.

The antenna is scanned between 1 meter and 4 meters to find out the maximum emission level. This is repeated for both horizontal and vertical polarization of the antenna. In order to find the maximum emission, all of the interface cables were manipulated according to ANSI C63.10: 2013 on radiated measurement.

The resolution bandwidth below 30MHz setting on the field strength meter is 9kHz and 30MHz~1GHz is 120kHz and above 1GHz is 1MHz.

Radiated emission measurements below 30MHz are made using Loop Antenna and 30MHz~1GHz are made using broadband Bilog antenna and above 1GHz are made using Horn Antennas.

The measurement is divided into the Preliminary Measurement and the Final Measurement.

The suspected frequencies are searched for in Preliminary Measurement with the measurement antenna kept pointed at the source of the emission both in azimuth and elevation, with the polarization of the antenna oriented for maximum response. The antenna is pointed at an angle towards the source of the emission, and the EUT is rotated in both height and polarization to maximize the measured emission. The emission is kept within the illumination area of the 3 dB bandwidth of the antenna. The measurement frequency range from 9kHz - 10th Harmonic of fundamental was investigated.

### 3.4. Uncertainty

Horizontal polarization :

30-300MHz:  $\pm 4.08$ dB ; 300M-1GHz:  $\pm 3.86$ dB ; 1-18GHz:  $\pm 3.77$ dB ; 18-40GHz:  $\pm 3.98$ dB

Vertical polarization :

30-300MHz:  $\pm 4.81$ dB ; 300M-1GHz:  $\pm 3.87$ dB ; 1-18GHz :  $\pm 3.83$ dB ; 18-40GHz:  $\pm 3.98$ dB

### 3.5. Test Result of Radiated Emission

Product : Intel® Wireless-AC 9560  
 Test Item : Harmonic Radiated Emission  
 Test Mode : Mode 1: Transmit - 1Mbps (2402MHz)  
 Test Date : 2019/11/26

#### Horizontal

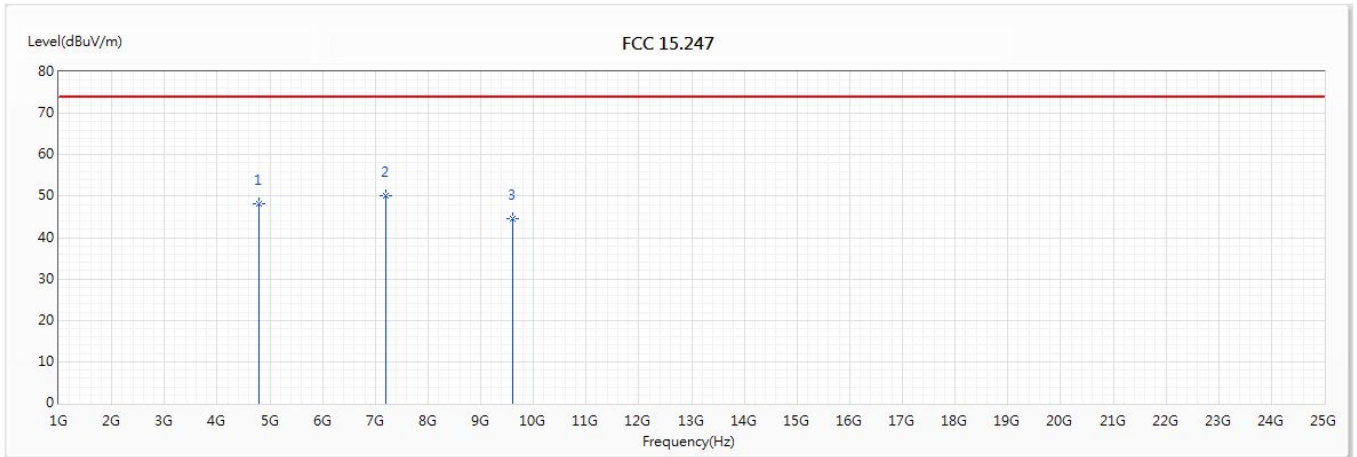

No	Frequency (MHz)	Emission Level (dBuV/m)	Limit (dBuV/m)	Margin (dB)	Reading Level (dBuV)	Correct Factor (dB/m)	Detector Type
1	4804	48.10	74.00	-25.90	52.42	-4.32	PK
* 2	7206	50.09	74.00	-23.91	50.74	-0.65	PK
3	9608	44.51	74.00	-29.49	42.71	1.80	PK

Note:

- All Readings below 1GHz are Quasi-Peak, above 1GHz are performed with peak and/or average measurements as necessary.
- Peak measurements: RBW = 1MHz, VBW = 3 MHz, Sweep: Auto.
- Emission Level = Reading Level + Correct Factor.
- Correct Factor = Antenna factor + Cable loss – Amplifier gain.
- The average measurement was not performed when the peak measured data under the limit of average detection.
- The emission levels of other frequencies are very lower than the limit and not show in test report.

Frequency MHz	Peak Measurement dBμV/m	Duty Cycle Factor dB	Average Measurement dBμV/m	Margin dB	Peak Limit dBμV/m	Average Limit dBμV/m
<b>Average Detector:</b>						
--	--	--	--	--	74.000	54.000

Note:

- AVG Measurement=Peak Measurement + Duty Cycle Correct Factor
- The Duty Cycle is refer to section 5.



Product : Intel® Wireless-AC 9560  
 Test Item : Harmonic Radiated Emission  
 Test Mode : Mode 1: Transmit - 1Mbps (2402MHz)  
 Test Date : 2019/11/26

**Vertical**

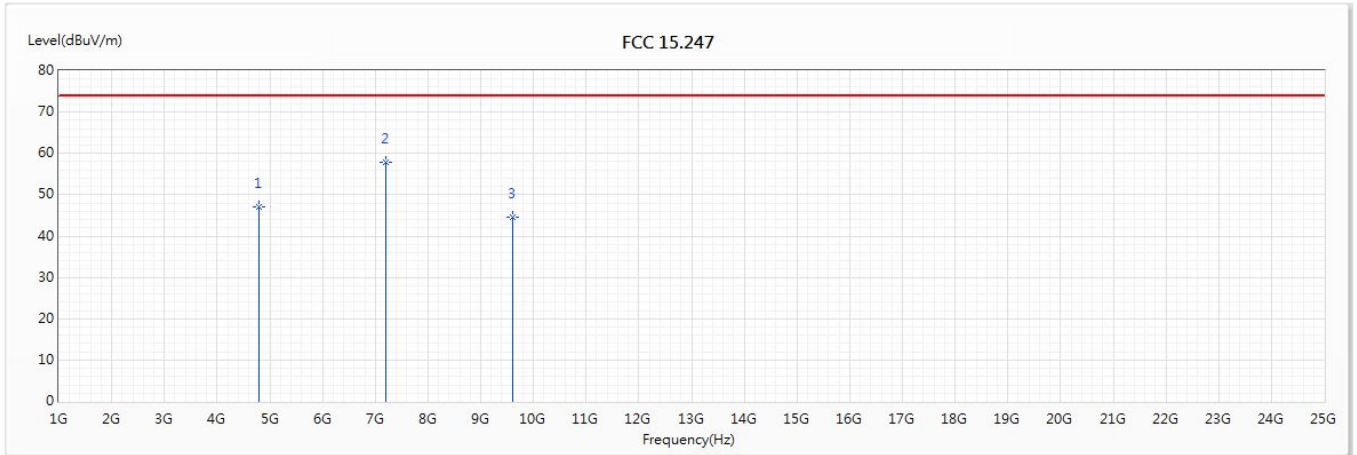

No	Frequency (MHz)	Emission Level (dBuV/m)	Limit (dBuV/m)	Margin (dB)	Reading Level (dBuV)	Correct Factor (dB/m)	Detector Type
1	4804	47.10	74.00	-26.90	51.42	-4.32	PK
* 2	7206	57.84	74.00	-16.16	58.49	-0.65	PK
3	9608	44.55	74.00	-29.45	42.75	1.80	PK

**Note:**

1. All Readings below 1GHz are Quasi-Peak, above 1GHz are performed with peak and/or average measurements as necessary.
2. Peak measurements: RBW = 1MHz, VBW = 3 MHz, Sweep: Auto.
3. Emission Level = Reading Level + Correct Factor.
4. Correct Factor = Antenna factor + Cable loss – Amplifier gain.
5. The average measurement was not performed when the peak measured data under the limit of average detection.
6. The emission levels of other frequencies are very lower than the limit and not show in test report.

Frequency MHz	Peak Measurement dBμV/m	Duty Cycle Factor dB	Average Measurement dBμV/m	Margin dB	Peak Limit dBμV/m	Average Limit dBμV/m
<b>Average Detector:</b> 7206	57.84	-24.746	33.094	-20.906	74.000	54.000

**Note:**

1. AVG Measurement=Peak Measurement + Duty Cycle Correct Factor
2. The Duty Cycle is refer to section 5.

Product : Intel® Wireless-AC 9560  
 Test Item : Harmonic Radiated Emission  
 Test Mode : Mode 1: Transmit - 1Mbps (2441MHz)  
 Test Date : 2019/11/26

**Horizontal**

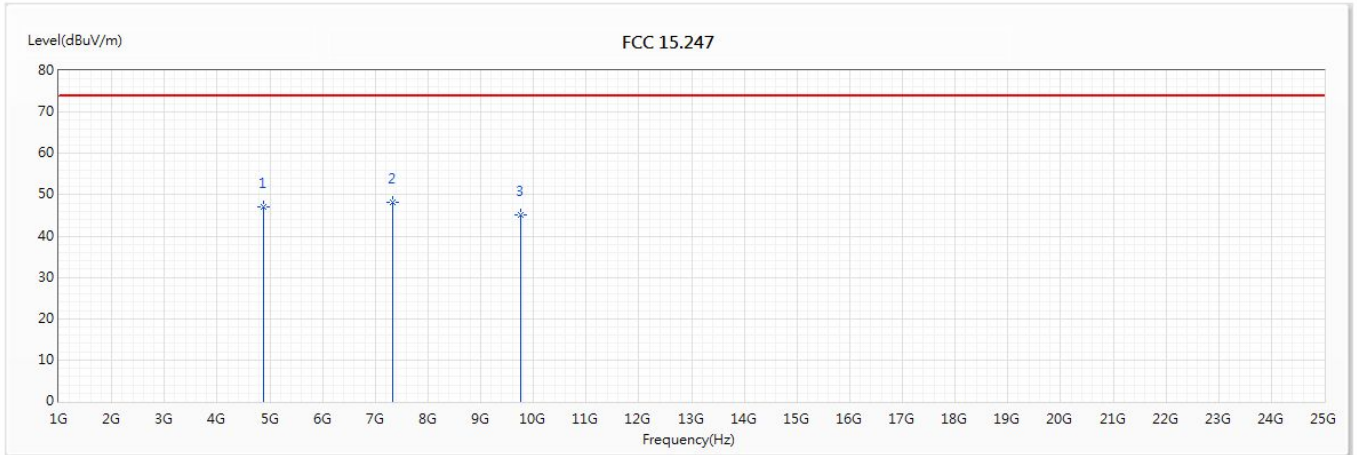

No	Frequency (MHz)	Emission Level (dBuV/m)	Limit (dBuV/m)	Margin (dB)	Reading Level (dBuV)	Correct Factor (dB/m)	Detector Type
1	4882	47.18	74.00	-26.82	51.56	-4.38	PK
* 2	7323	48.14	74.00	-25.86	48.82	-0.68	PK
3	9764	45.13	74.00	-28.87	43.10	2.03	PK

**Note:**

1. All Readings below 1GHz are Quasi-Peak, above 1GHz are performed with peak and/or average measurements as necessary.
2. Peak measurements: RBW = 1MHz, VBW = 3 MHz, Sweep: Auto.
3. Emission Level = Reading Level + Correct Factor.
4. Correct Factor = Antenna factor + Cable loss – Amplifier gain.
5. The average measurement was not performed when the peak measured data under the limit of average detection.
6. The emission levels of other frequencies are very lower than the limit and not show in test report.

Frequency MHz	Peak Measurement dBμV/m	Duty Cycle Factor dB	Average Measurement dBμV/m	Margin dB	Peak Limit dBμV/m	Average Limit dBμV/m
---	---	---	---	---	74.000	54.000

**Note:**

1. AVG Measurement=Peak Measurement + Duty Cycle Correct Factor
2. The Duty Cycle is refer to section 5.

Product : Intel® Wireless-AC 9560  
 Test Item : Harmonic Radiated Emission  
 Test Mode : Mode 1: Transmit - 1Mbps (2441MHz)  
 Test Date : 2019/11/26

**Vertical**

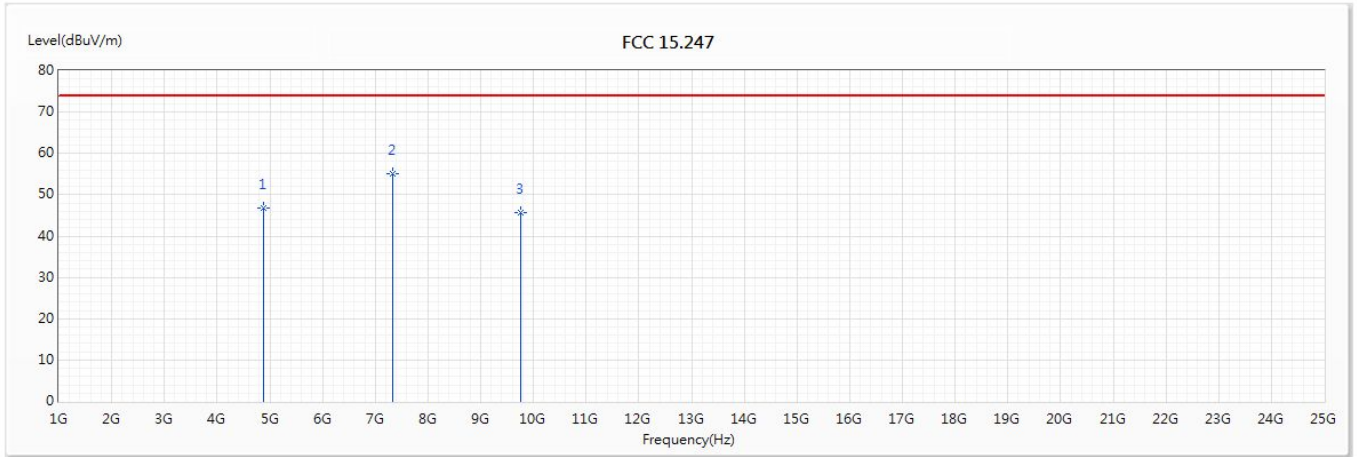

No	Frequency (MHz)	Emission Level (dBuV/m)	Limit (dBuV/m)	Margin (dB)	Reading Level (dBuV)	Correct Factor (dB/m)	Detector Type
1	4882	46.79	74.00	-27.21	51.17	-4.38	PK
* 2	7323	55.22	74.00	-18.78	55.90	-0.68	PK
3	9764	45.81	74.00	-28.19	43.78	2.03	PK

Note:

- All Readings below 1GHz are Quasi-Peak, above 1GHz are performed with peak and/or average measurements as necessary.
- Peak measurements: RBW = 1MHz, VBW = 3 MHz, Sweep: Auto.
- Emission Level = Reading Level + Correct Factor.
- Correct Factor = Antenna factor + Cable loss – Amplifier gain.
- The average measurement was not performed when the peak measured data under the limit of average detection.
- The emission levels of other frequencies are very lower than the limit and not show in test report.

Frequency MHz	Peak Measurement dBμV/m	Duty Cycle Factor dB	Average Measurement dBμV/m	Margin dB	Peak Limit dBμV/m	Average Limit dBμV/m
<b>Average Detector:</b> 7323	55.22	-24.746	30.474	-23.526	74.000	54.000

Note:

- AVG Measurement=Peak Measurement + Duty Cycle Correct Factor
- The Duty Cycle is refer to section 5.

Product : Intel® Wireless-AC 9560  
 Test Item : Harmonic Radiated Emission  
 Test Mode : Mode 1: Transmit - 1Mbps (2480MHz)  
 Test Date : 2019/11/26

**Horizontal**

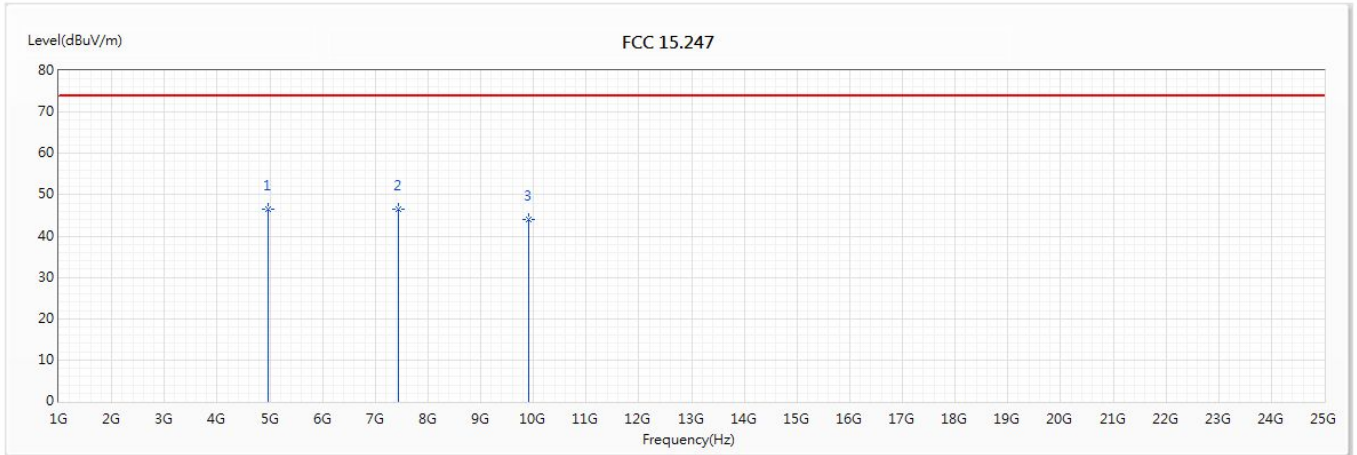

No	Frequency (MHz)	Emission Level (dBuV/m)	Limit (dBuV/m)	Margin (dB)	Reading Level (dBuV)	Correct Factor (dB/m)	Detector Type
* 1	4960	46.57	74.00	-27.43	50.87	-4.30	PK
2	7440	46.43	74.00	-27.57	47.20	-0.77	PK
3	9920	43.91	74.00	-30.09	41.99	1.92	PK

**Note:**

1. All Readings below 1GHz are Quasi-Peak, above 1GHz are performed with peak and/or average measurements as necessary.
2. Peak measurements: RBW = 1MHz, VBW = 3 MHz, Sweep: Auto.
3. Emission Level = Reading Level + Correct Factor.
4. Correct Factor = Antenna factor + Cable loss – Amplifier gain.
5. The average measurement was not performed when the peak measured data under the limit of average detection.
6. The emission levels of other frequencies are very lower than the limit and not show in test report.

Frequency MHz	Peak Measurement dBμV/m	Duty Cycle Factor dB	Average Measurement dBμV/m	Margin dB	Peak Limit dBμV/m	Average Limit dBμV/m
<b>Average Detector:</b>						
--	--	--	--	--	74.000	54.000

**Note:**

1. AVG Measurement=Peak Measurement + Duty Cycle Correct Factor
2. The Duty Cycle is refer to section 5.

Product : Intel® Wireless-AC 9560  
 Test Item : Harmonic Radiated Emission  
 Test Mode : Mode 1: Transmit - 1Mbps (2480MHz)  
 Test Date : 2019/11/26

**Vertical**

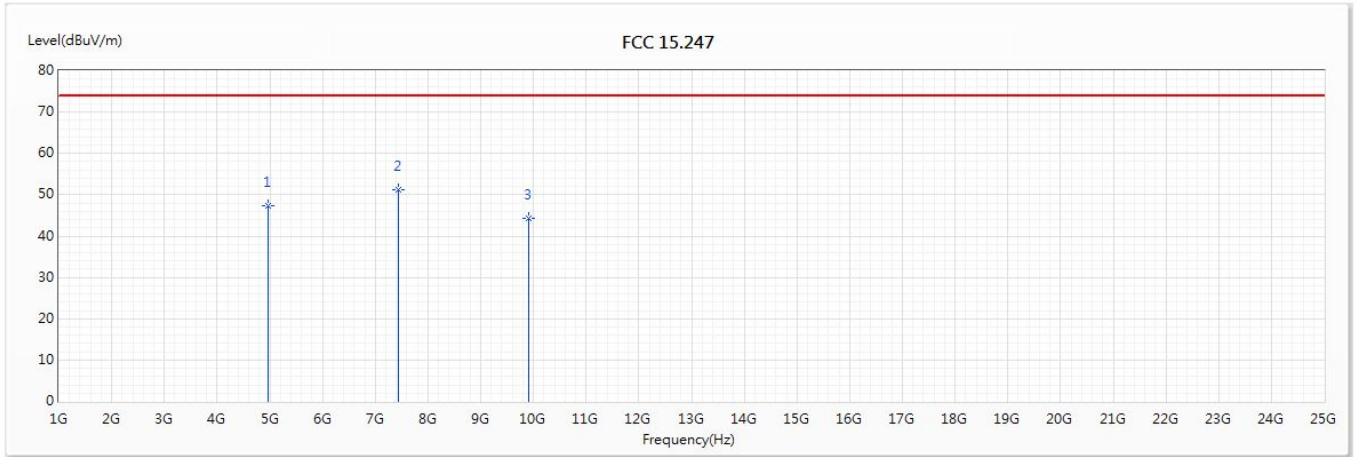

No	Frequency (MHz)	Emission Level (dBuV/m)	Limit (dBuV/m)	Margin (dB)	Reading Level (dBuV)	Correct Factor (dB/m)	Detector Type
1	4960	47.40	74.00	-26.60	51.70	-4.30	PK
* 2	7440	51.29	74.00	-22.71	52.06	-0.77	PK
3	9920	44.30	74.00	-29.70	42.38	1.92	PK

Note:

- All Readings below 1GHz are Quasi-Peak, above 1GHz are performed with peak and/or average measurements as necessary.
- Peak measurements: RBW = 1MHz, VBW = 3 MHz, Sweep: Auto.
- Emission Level = Reading Level + Correct Factor.
- Correct Factor = Antenna factor + Cable loss – Amplifier gain.
- The average measurement was not performed when the peak measured data under the limit of average detection.
- The emission levels of other frequencies are very lower than the limit and not show in test report.

Frequency MHz	Peak Measurement dBμV/m	Duty Cycle Factor dB	Average Measurement dBμV/m	Margin dB	Peak Limit dBμV/m	Average Limit dBμV/m
<b>Average Detector:</b>						
--	--	--	--	--	74.000	54.000

Note:

- AVG Measurement=Peak Measurement + Duty Cycle Correct Factor
- The Duty Cycle is refer to section 5.

Product : Intel® Wireless-AC 9560  
 Test Item : Harmonic Radiated Emission  
 Test Mode : Mode 2: Transmit - 3Mbps (2402MHz)  
 Test Date : 2019/11/26

**Horizontal**

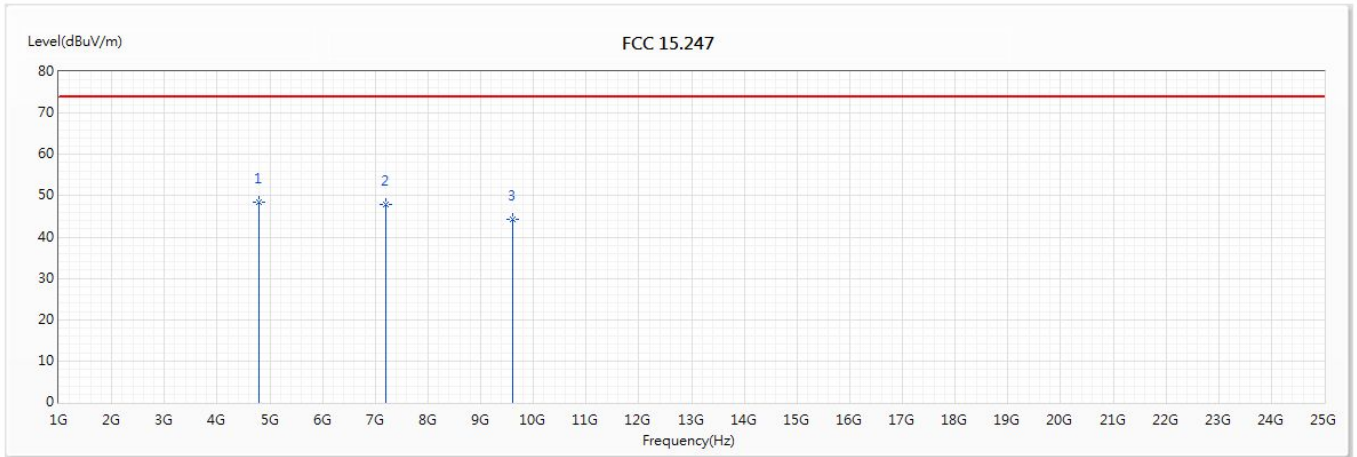

No	Frequency (MHz)	Emission Level (dBuV/m)	Limit (dBuV/m)	Margin (dB)	Reading Level (dBuV)	Correct Factor (dB/m)	Detector Type
* 1	4804	48.39	74.00	-25.61	52.71	-4.32	PK
2	7206	47.85	74.00	-26.15	48.50	-0.65	PK
3	9608	44.41	74.00	-29.59	42.61	1.80	PK

Note:

1. All Readings below 1GHz are Quasi-Peak, above 1GHz are performed with peak and/or average measurements as necessary.
2. Peak measurements: RBW = 1MHz, VBW = 3 MHz, Sweep: Auto.
3. Emission Level = Reading Level + Correct Factor.
4. Correct Factor = Antenna factor + Cable loss – Amplifier gain.
5. The average measurement was not performed when the peak measured data under the limit of average detection.
6. The emission levels of other frequencies are very lower than the limit and not show in test report.

Frequency MHz	Peak Measurement dBμV/m	Duty Cycle Factor dB	Average Measurement dBμV/m	Margin dB	Peak Limit dBμV/m	Average Limit dBμV/m
<b>Average Detector:</b>						
--	--	--	--	--	74.000	54.000

Note:

1. AVG Measurement=Peak Measurement + Duty Cycle Correct Factor
2. The Duty Cycle is refer to section 5.

Product : Intel® Wireless-AC 9560  
 Test Item : Harmonic Radiated Emission  
 Test Mode : Mode 2: Transmit - 3Mbps (2402MHz)  
 Test Date : 2019/11/26

**Vertical**

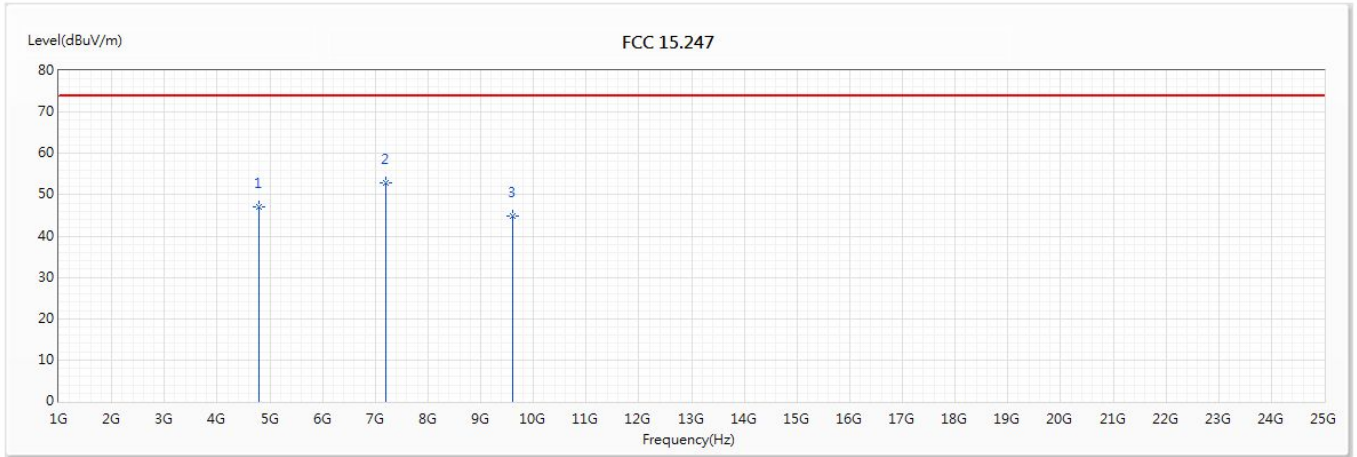

No	Frequency (MHz)	Emission Level (dBuV/m)	Limit (dBuV/m)	Margin (dB)	Reading Level (dBuV)	Correct Factor (dB/m)	Detector Type
1	4804	47.13	74.00	-26.87	51.45	-4.32	PK
* 2	7206	52.91	74.00	-21.09	53.56	-0.65	PK
3	9608	44.73	74.00	-29.27	42.93	1.80	PK

**Note:**

1. All Readings below 1GHz are Quasi-Peak, above 1GHz are performed with peak and/or average measurements as necessary.
2. Peak measurements: RBW = 1MHz, VBW = 3 MHz, Sweep: Auto.
3. Emission Level = Reading Level + Correct Factor.
4. Correct Factor = Antenna factor + Cable loss – Amplifier gain.
5. The average measurement was not performed when the peak measured data under the limit of average detection.
6. The emission levels of other frequencies are very lower than the limit and not show in test report.

Frequency (MHz)	Peak Measurement (dBμV/m)	Duty Cycle Factor (dB)	Average Measurement (dBμV/m)	Margin (dB)	Peak Limit (dBμV/m)	Average Limit (dBμV/m)
<b>Average Detector:</b>						
--	--	--	--	--	74.000	54.000

**Note:**

1. AVG Measurement=Peak Measurement + Duty Cycle Correct Factor
2. The Duty Cycle is refer to section 5.

Product : Intel® Wireless-AC 9560  
 Test Item : Harmonic Radiated Emission  
 Test Mode : Mode 2: Transmit - 3Mbps (2441MHz)  
 Test Date : 2019/11/26

**Horizontal**

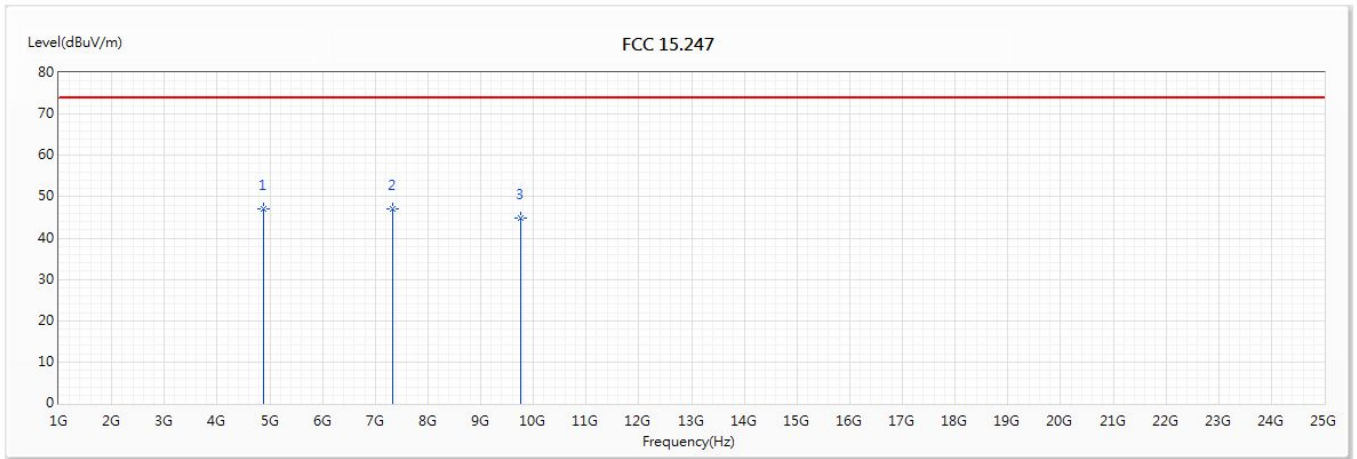

No	Frequency (MHz)	Emission Level (dBuV/m)	Limit (dBuV/m)	Margin (dB)	Reading Level (dBuV)	Correct Factor (dB/m)	Detector Type
1	4882	46.93	74.00	-27.07	51.31	-4.38	PK
* 2	7323	47.11	74.00	-26.89	47.79	-0.68	PK
3	9764	44.83	74.00	-29.17	42.80	2.03	PK

Note:

- All Readings below 1GHz are Quasi-Peak, above 1GHz are performed with peak and/or average measurements as necessary.
- Peak measurements: RBW = 1MHz, VBW = 3 MHz, Sweep: Auto.
- Emission Level = Reading Level + Correct Factor.
- Correct Factor = Antenna factor + Cable loss – Amplifier gain.
- The average measurement was not performed when the peak measured data under the limit of average detection.
- The emission levels of other frequencies are very lower than the limit and not show in test report.

Frequency MHz	Peak Measurement dBμV/m	Duty Cycle Factor dB	Average Measurement dBμV/m	Margin dB	Peak Limit dBμV/m	Average Limit dBμV/m
<b>Average Detector:</b>						
--	--	--	--	--	74.000	54.000

Note:

- AVG Measurement=Peak Measurement + Duty Cycle Correct Factor
- The Duty Cycle is refer to section 5.



Product : Intel® Wireless-AC 9560  
 Test Item : Harmonic Radiated Emission  
 Test Mode : Mode 2: Transmit - 3Mbps (2441MHz)  
 Test Date : 2019/11/26

**Vertical**

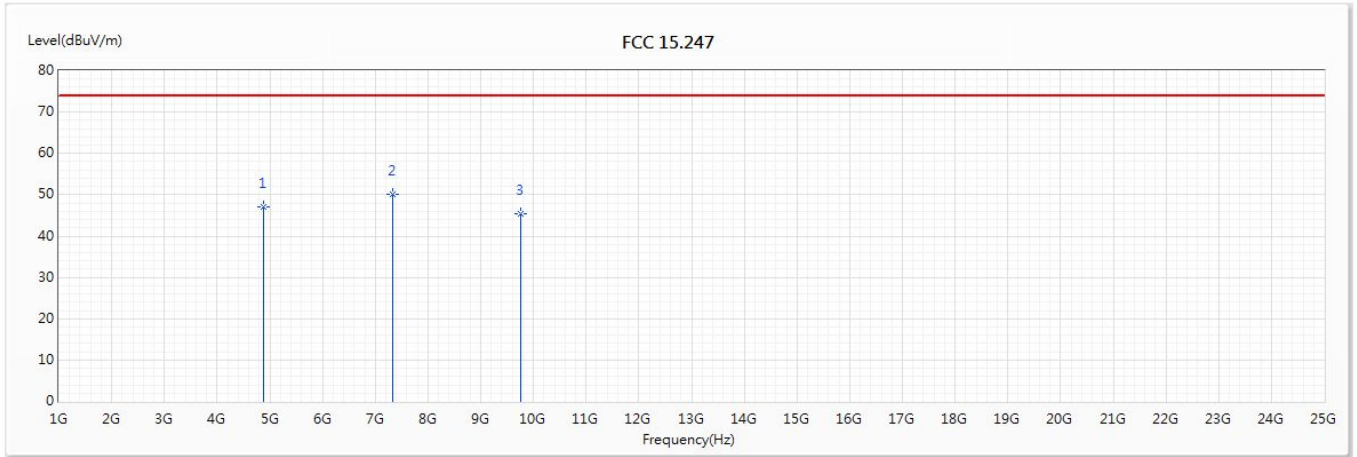

No	Frequency (MHz)	Emission Level (dBuV/m)	Limit (dBuV/m)	Margin (dB)	Reading Level (dBuV)	Correct Factor (dB/m)	Detector Type
1	4882	47.14	74.00	-26.86	51.52	-4.38	PK
* 2	7323	50.24	74.00	-23.76	50.92	-0.68	PK
3	9764	45.43	74.00	-28.57	43.40	2.03	PK

**Note:**

1. All Readings below 1GHz are Quasi-Peak, above 1GHz are performed with peak and/or average measurements as necessary.
2. Peak measurements: RBW = 1MHz, VBW = 3 MHz, Sweep: Auto.
3. Emission Level = Reading Level + Correct Factor.
4. Correct Factor = Antenna factor + Cable loss – Amplifier gain.
5. The average measurement was not performed when the peak measured data under the limit of average detection.
6. The emission levels of other frequencies are very lower than the limit and not show in test report.

Frequency (MHz)	Peak Measurement (dBμV/m)	Duty Cycle Factor (dB)	Average Measurement (dBμV/m)	Margin (dB)	Peak Limit (dBμV/m)	Average Limit (dBμV/m)
<b>Average Detector:</b>						
--	--	--	--	--	74.000	54.000

**Note:**

1. AVG Measurement=Peak Measurement + Duty Cycle Correct Factor
2. The Duty Cycle is refer to section 5.

Product : Intel® Wireless-AC 9560  
 Test Item : Harmonic Radiated Emission  
 Test Mode : Mode 2: Transmit - 3Mbps (2480MHz)  
 Test Date : 2019/11/26

**Horizontal**

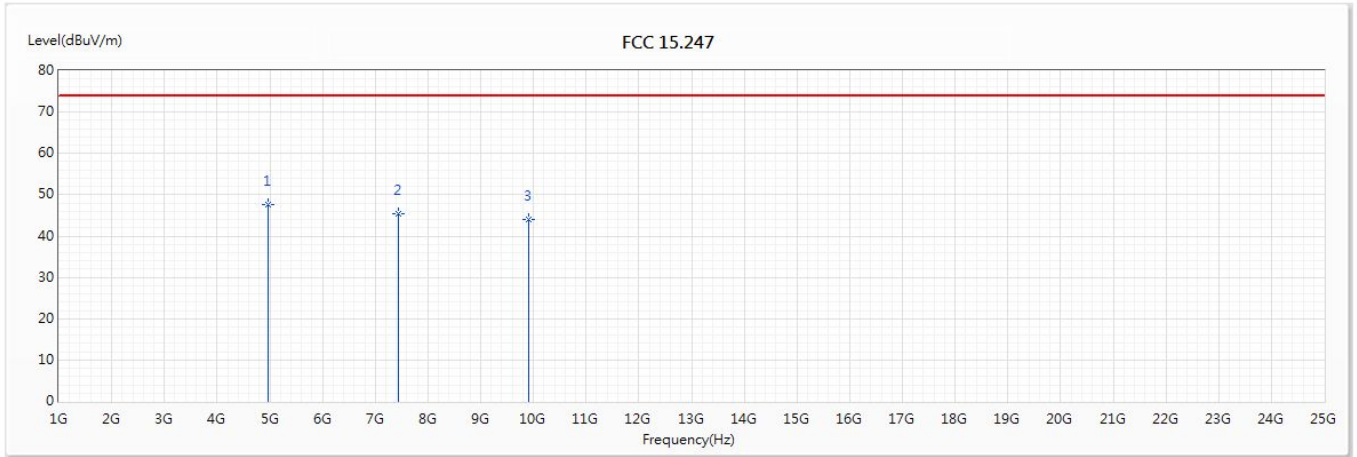

No	Frequency (MHz)	Emission Level (dBuV/m)	Limit (dBuV/m)	Margin (dB)	Reading Level (dBuV)	Correct Factor (dB/m)	Detector Type
* 1	4960	47.50	74.00	-26.50	51.80	-4.30	PK
2	7440	45.52	74.00	-28.48	46.29	-0.77	PK
3	9920	44.03	74.00	-29.97	42.11	1.92	PK

Note:

- All Readings below 1GHz are Quasi-Peak, above 1GHz are performed with peak and/or average measurements as necessary.
- Peak measurements: RBW = 1MHz, VBW = 3 MHz, Sweep: Auto.
- Emission Level = Reading Level + Correct Factor.
- Correct Factor = Antenna factor + Cable loss – Amplifier gain.
- The average measurement was not performed when the peak measured data under the limit of average detection.
- The emission levels of other frequencies are very lower than the limit and not show in test report.

Frequency MHz	Peak Measurement dBμV/m	Duty Cycle Factor dB	Average Measurement dBμV/m	Margin dB	Peak Limit dBμV/m	Average Limit dBμV/m
<b>Average Detector:</b>						
--	--	--	--	--	74.000	54.000

Note:

- AVG Measurement=Peak Measurement + Duty Cycle Correct Factor
- The Duty Cycle is refer to section 5.

Product : Intel® Wireless-AC 9560  
 Test Item : Harmonic Radiated Emission  
 Test Mode : Mode 2: Transmit - 3Mbps (2480MHz)  
 Test Date : 2019/11/26

**Vertical**

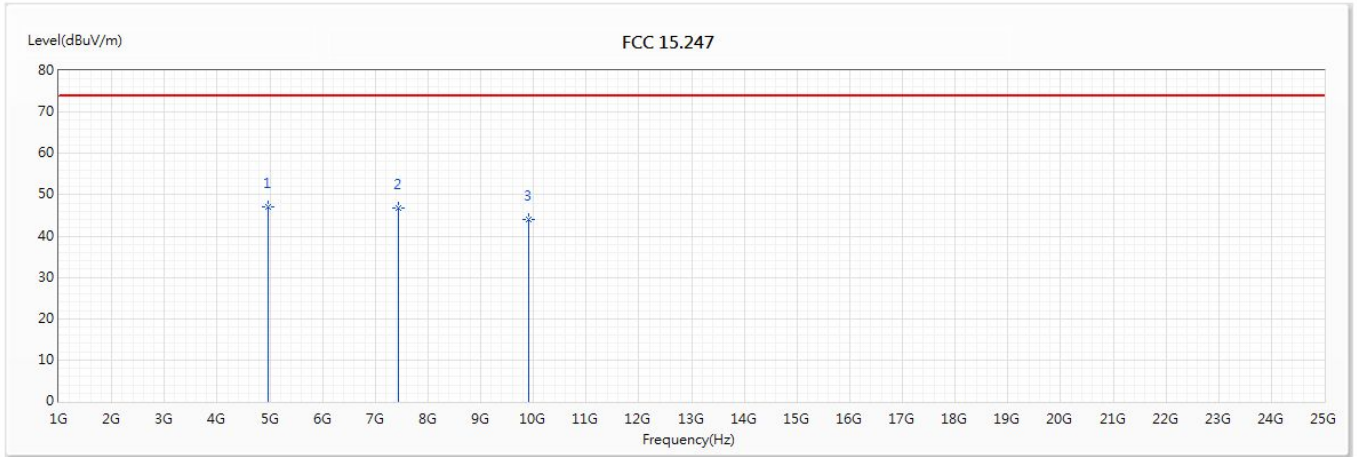

No	Frequency (MHz)	Emission Level (dBuV/m)	Limit (dBuV/m)	Margin (dB)	Reading Level (dBuV)	Correct Factor (dB/m)	Detector Type
* 1	4960	46.99	74.00	-27.01	51.29	-4.30	PK
2	7440	46.71	74.00	-27.29	47.48	-0.77	PK
3	9920	44.13	74.00	-29.87	42.21	1.92	PK

Note:

1. All Readings below 1GHz are Quasi-Peak, above 1GHz are performed with peak and/or average measurements as necessary.
2. Peak measurements: RBW = 1MHz, VBW = 3 MHz, Sweep: Auto.
3. Emission Level = Reading Level + Correct Factor.
4. Correct Factor = Antenna factor + Cable loss – Amplifier gain.
5. The average measurement was not performed when the peak measured data under the limit of average detection.
6. The emission levels of other frequencies are very lower than the limit and not show in test report.

Frequency (MHz)	Peak Measurement (dBμV/m)	Duty Cycle Factor (dB)	Average Measurement (dBμV/m)	Margin (dB)	Peak Limit (dBμV/m)	Average Limit (dBμV/m)
<b>Average Detector:</b>						
--	--	--	--	--	74.000	54.000

Note:

1. AVG Measurement=Peak Measurement + Duty Cycle Correct Factor
2. The Duty Cycle is refer to section 5.

Product : Intel® Wireless-AC 9560  
 Test Item : General Radiated Emission  
 Test Mode : Mode 1: Transmit - 1Mbps (2441MHz)  
 Test Date : 2019/11/27

**Horizontal**

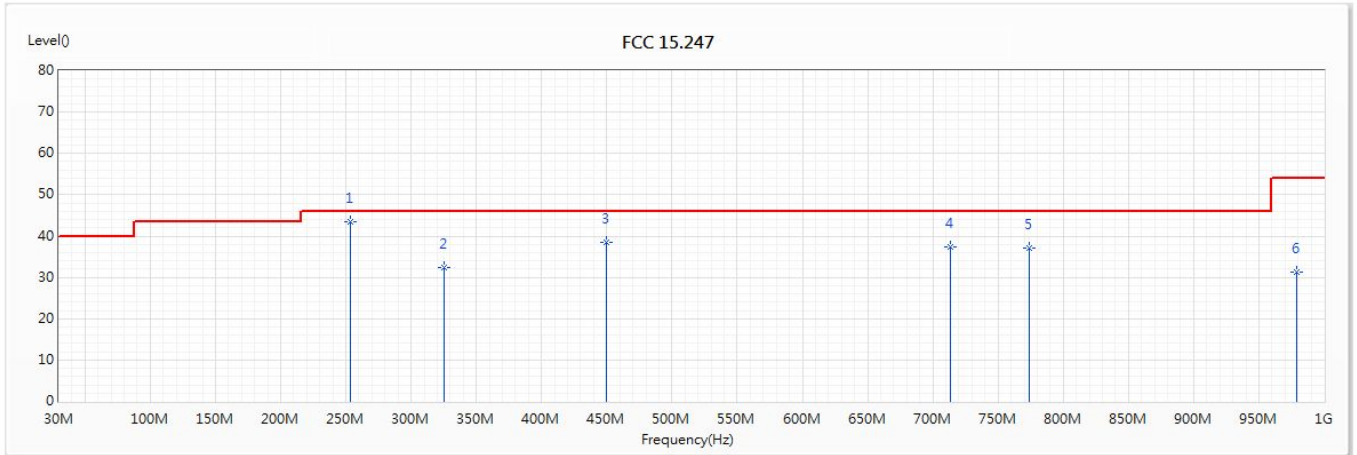

No	Frequency (MHz)	Emission Level (dBuV/m)	Limit (dBuV/m)	Margin (dB)	Reading Level (dBuV)	Correct Factor (dB/m)	Detector Type
* 1	253.1	43.51	46.00	-2.49	54.56	-11.05	QP
2	324.88	32.48	46.00	-13.52	41.22	-8.74	QP
3	450.01	38.55	46.00	-7.45	44.59	-6.04	QP
4	713.85	37.48	46.00	-8.52	38.88	-1.40	QP
5	773.99	37.11	46.00	-8.89	37.84	-0.73	QP
6	978.66	31.24	54.00	-22.76	29.49	1.75	QP

**Note:**

1. All Readings below 1GHz are Quasi-Peak, above 1GHz are performed with peak and/or average measurements as necessary.
2. Emission Level = Reading Level + Correct Factor.
3. Correct Factor = Antenna factor + Cable loss – Amplifier gain.
4. The emission levels of other frequencies are very lower than the limit and not show in test report.
5. No emission found between lowest internal used/generated frequency to 30MHz.

Product : Intel® Wireless-AC 9560  
 Test Item : General Radiated Emission  
 Test Mode : Mode 1: Transmit - 1Mbps (2441MHz)  
 Test Date : 2019/11/27

**Vertical**

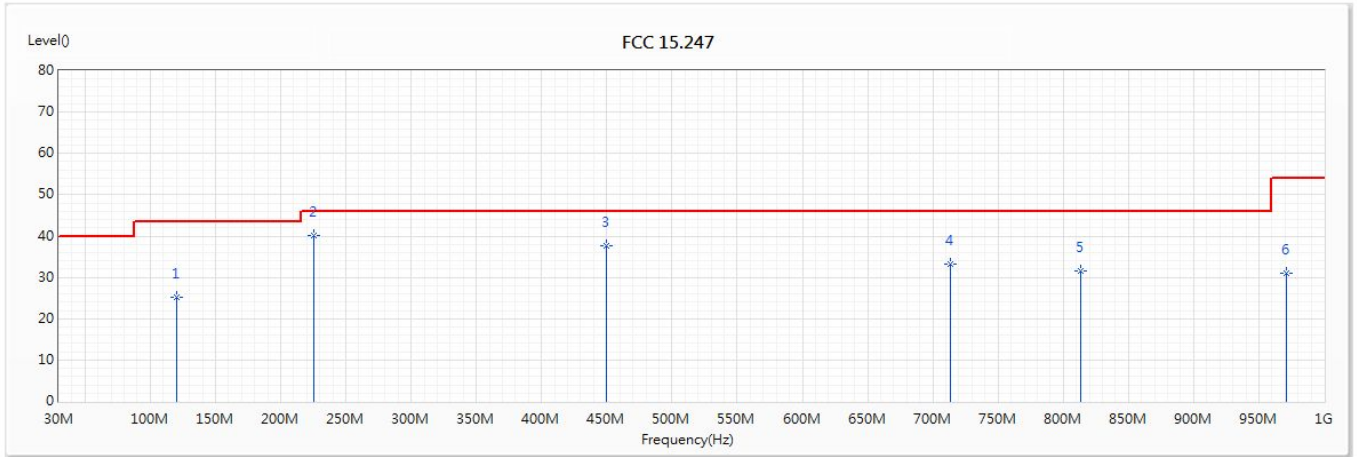

No	Frequency (MHz)	Emission Level (dBuV/m)	Limit (dBuV/m)	Margin (dB)	Reading Level (dBuV)	Correct Factor (dB/m)	Detector Type
1	120.21	25.30	43.50	-18.20	38.34	-13.04	QP
* 2	224.97	40.22	46.00	-5.78	52.79	-12.57	QP
3	450.01	37.61	46.00	-8.39	43.65	-6.04	QP
4	713.85	33.30	46.00	-12.70	34.70	-1.40	QP
5	813.76	31.67	46.00	-14.33	32.14	-0.47	QP
6	970.9	31.04	54.00	-22.96	29.30	1.74	QP

**Note:**

1. All Readings below 1GHz are Quasi-Peak, above 1GHz are performed with peak and/or average measurements as necessary.
2. Emission Level = Reading Level + Correct Factor.
3. Correct Factor = Antenna factor + Cable loss – Amplifier gain.
4. The emission levels of other frequencies are very lower than the limit and not show in test report.
5. No emission found between lowest internal used/generated frequency to 30MHz.

Product : Intel® Wireless-AC 9560  
 Test Item : General Radiated Emission  
 Test Mode : Mode 2: Transmit - 3Mbps (2441MHz)  
 Test Date : 2019/11/27

**Horizontal**

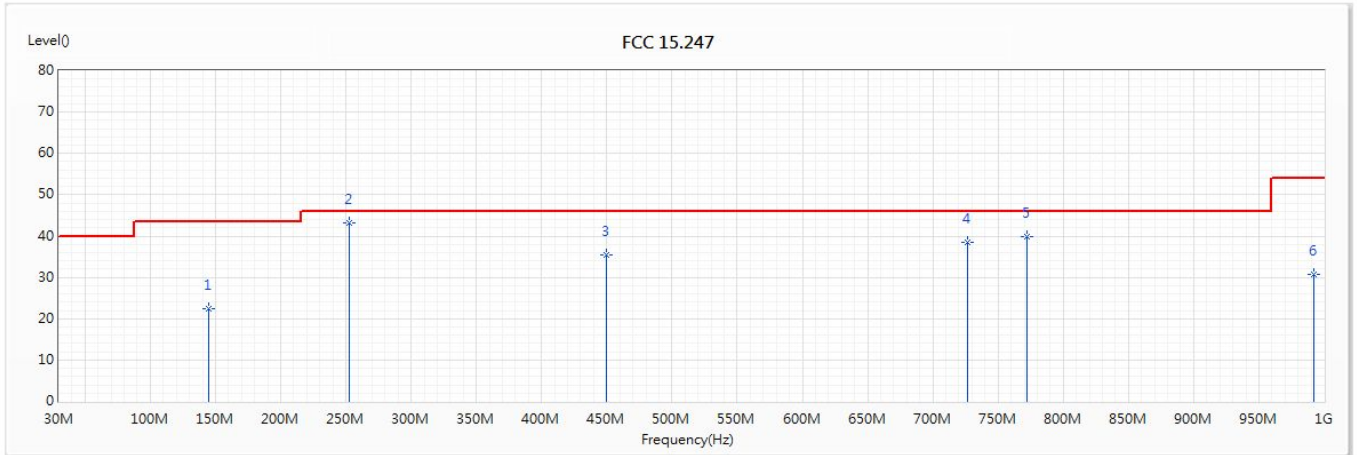

No	Frequency (MHz)	Emission Level (dBuV/m)	Limit (dBuV/m)	Margin (dB)	Reading Level (dBuV)	Correct Factor (dB/m)	Detector Type
1	144.46	22.52	43.50	-20.98	33.10	-10.58	QP
* 2	252.13	43.16	46.00	-2.84	54.24	-11.08	QP
3	450.01	35.35	46.00	-10.65	41.39	-6.04	QP
4	726.46	38.57	46.00	-7.43	39.76	-1.19	QP
5	772.05	39.82	46.00	-6.18	40.55	-0.73	QP
6	992.24	30.85	54.00	-23.15	29.33	1.52	QP

**Note:**

1. All Readings below 1GHz are Quasi-Peak, above 1GHz are performed with peak and/or average measurements as necessary.
2. Emission Level = Reading Level + Correct Factor.
3. Correct Factor = Antenna factor + Cable loss – Amplifier gain.
4. The emission levels of other frequencies are very lower than the limit and not show in test report.
5. No emission found between lowest internal used/generated frequency to 30MHz.

Product : Intel® Wireless-AC 9560  
 Test Item : General Radiated Emission  
 Test Mode : Mode 2: Transmit - 3Mbps (2441MHz)  
 Test Date : 2019/11/27

**Vertical**

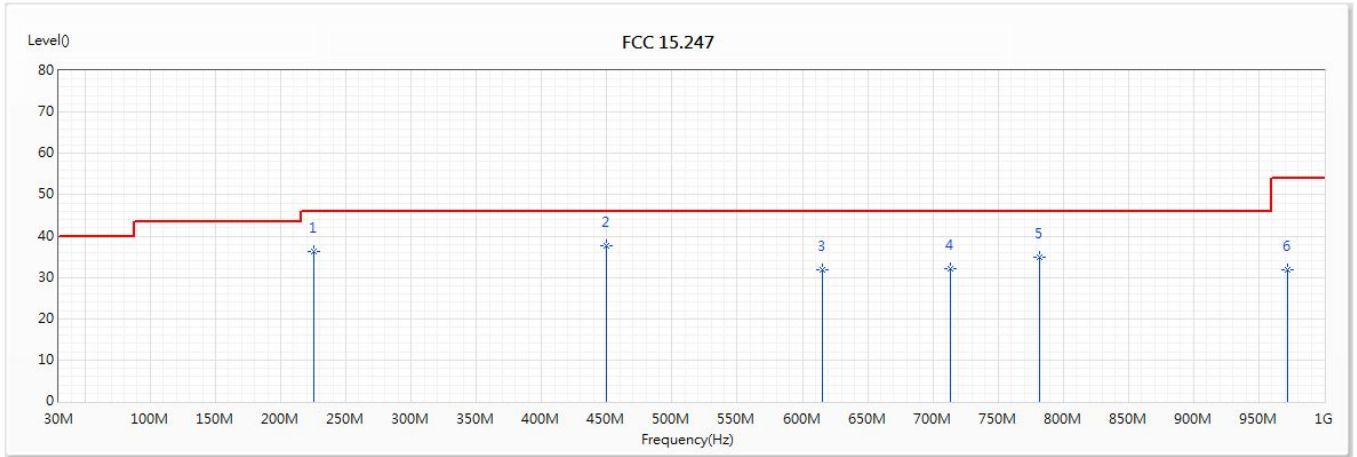

No	Frequency (MHz)	Emission Level (dBuV/m)	Limit (dBuV/m)	Margin (dB)	Reading Level (dBuV)	Correct Factor (dB/m)	Detector Type
1	224.97	36.26	46.00	-9.74	48.83	-12.57	QP
* 2	450.01	37.73	46.00	-8.27	43.77	-6.04	QP
3	614.91	31.71	46.00	-14.29	34.76	-3.05	QP
4	713.85	32.19	46.00	-13.81	33.59	-1.40	QP
5	781.75	34.96	46.00	-11.04	35.53	-0.57	QP
6	971.87	31.79	54.00	-22.21	30.05	1.74	QP

**Note:**

1. All Readings below 1GHz are Quasi-Peak, above 1GHz are performed with peak and/or average measurements as necessary.
2. Emission Level = Reading Level + Correct Factor.
3. Correct Factor = Antenna factor + Cable loss – Amplifier gain.
4. The emission levels of other frequencies are very lower than the limit and not show in test report.
5. No emission found between lowest internal used/generated frequency to 30MHz.

#### 4. Band Edge

##### 4.1. Test Setup

###### RF Conducted Measurement

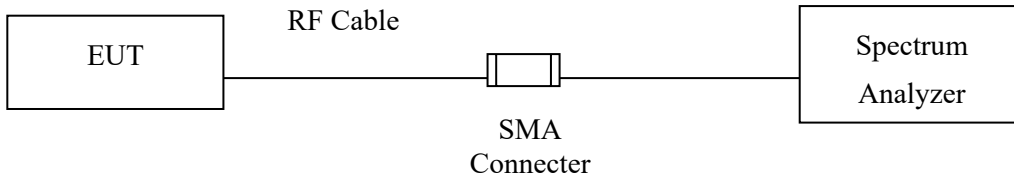

###### RF Radiated Measurement:

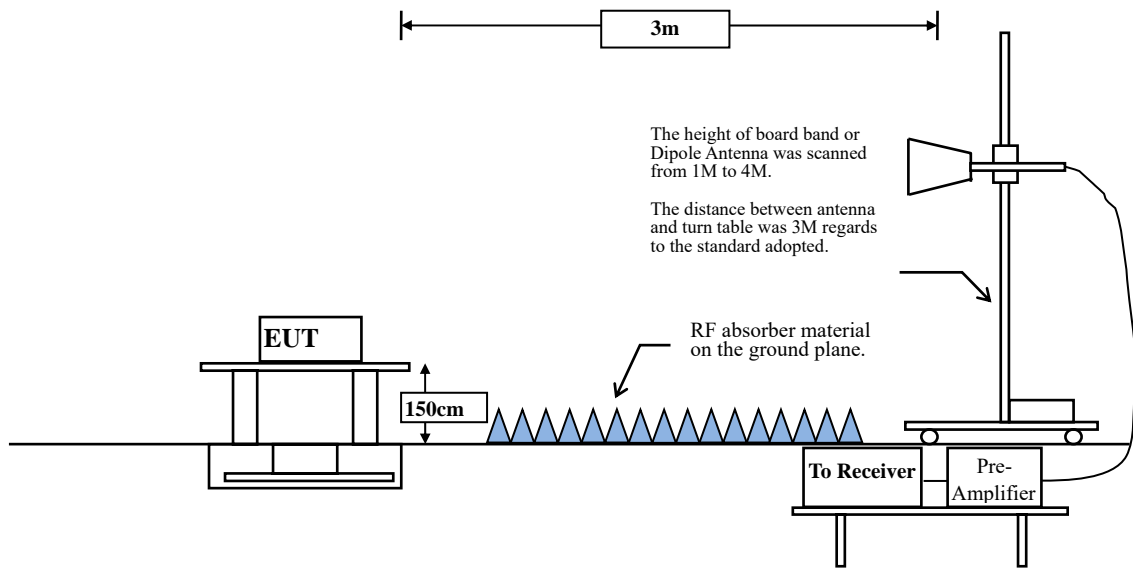



## 4.2. Limit

According to FCC Section 15.247(d). In any 100 kHz bandwidth outside the frequency band in which the spread spectrum or digitally modulated intentional radiator is operating, the radio frequency power that is produced by the intentional radiator shall be at least 20 dB below that in the 100 kHz bandwidth within the band that contains the highest level of the desired power, based on either an RF conducted or measurement, provided the transmitter demonstrates compliance with the peak conducted power limits. If the transmitter complies with the conducted power limits based on the use of RMS averaging over a time interval, the attenuation required under this paragraph shall be 30 dB instead of 20 dB. Attenuation below the general limits specified in Section 15.209(a) is not required. In addition, radiated emissions which fall in the restricted bands, as defined in Section 15.205(a), must also comply with the radiated emission limits specified in Section 15.209(a) (see Section 15.205(c)).

## 4.3. Test Procedure

The EUT is placed on a turn table which is 1.5 meter above ground. The turn table is rotated 360 degrees to determine the position of the maximum emission level. The EUT was positioned such that the distance from antenna to the EUT was 3 meters.

The antenna can move up and down between 1 meter and 4 meters to find out the maximum emission level.

Both horizontal and vertical polarization of the antenna are set on measurement. In order to find the maximum emission, all of the interface cables must be manipulated according to ANSI C63.10: 2013 on radiated measurement.

The bandwidth setting below 1GHz and above 1GHz on the field strength meter is 120 kHz and 1MHz, respectively.

## 4.4. Uncertainty

Conducted:  $\pm 1.23$ dB

Radiated:

Horizontal polarization : 1-18GHz:  $\pm 3.77$ dB

Vertical polarization : 1-18GHz :  $\pm 3.83$ dB

### 4.5. Test Result of Band Edge

Product : Intel® Wireless-AC 9560  
 Test Item : Band Edge  
 Test Mode : Mode 1: Transmit - 1Mbps (2402MHz)  
 Test Date : 2019/11/25

#### Horizontal

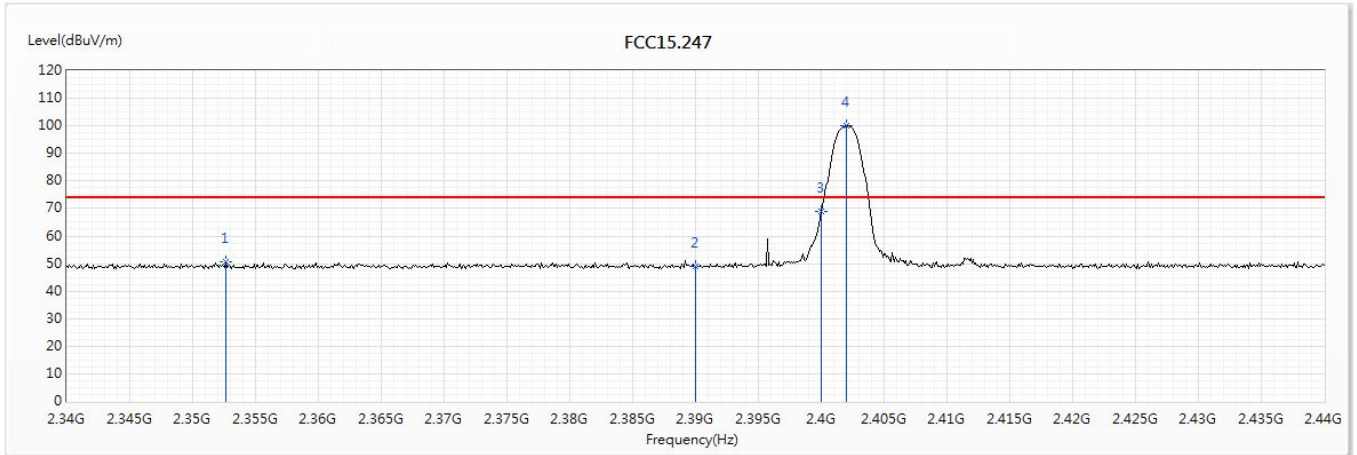

No	Frequency (MHz)	Emission Level (dBuV/m)	Limit (dBuV/m)	Margin (dB)	Reading Level (dBuV)	Correct Factor (dB/m)	Detector Type
1	2352.6	50.62	74.00	-23.38	39.14	11.48	PK
2	2390	48.80	74.00	-25.20	37.27	11.53	PK
3	2400	68.84	--	--	57.30	11.54	PK
4	2402	99.96	--	--	88.42	11.54	PK

Note:

1. All readings above 1GHz are performed with peak and/or average measurements as necessary.
2. Peak measurements: RBW = 1MHz, VBW = 3 MHz, Sweep: Auto.
3. Emission Level = Reading Level + Correct Factor.
4. The average measurement was not performed when the peak measured data under the limit of average detection.

Channel No.	Frequency (MHz)	Peak Measurement (dBμV/m)	Duty Cycle Factor (dB)	Average Measurement (dBμV/m)	Margin (dB)	Average Limit (dBμV/m)	Result
00 (Average)	2352.6	50.62	-24.746	25.874	-28.126	54.000	Pass
00 (Average)	2390	48.8	-24.746	24.054	-29.946	54.000	Pass
00 (Average)	2400	68.84	-24.746	44.094	--	--	Pass
00 (Average)	2402	99.96	-24.746	75.214	--	--	Pass

Note:

1. Average Measurement=Peak Measurement + Duty Cycle Factor
2. The Duty Cycle is refer to section 5.

Product : Intel® Wireless-AC 9560  
 Test Item : Band Edge  
 Test Mode : Mode 1: Transmit - 1Mbps (2402MHz)  
 Test Date : 2019/11/25

**Vertical**

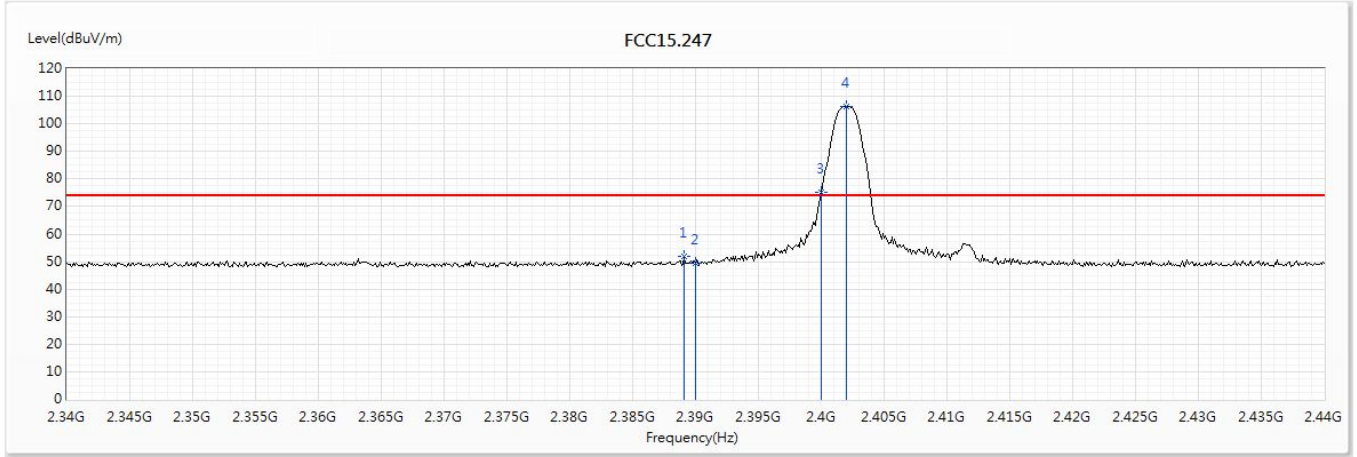

No	Frequency (MHz)	Emission Level (dBuV/m)	Limit (dBuV/m)	Margin (dB)	Reading Level (dBuV)	Correct Factor (dB/m)	Detector Type
1	2389.1	51.83	74.00	-22.17	40.30	11.53	PK
2	2390	49.21	74.00	-24.79	37.68	11.53	PK
3	2400	75.09	--	--	63.55	11.54	PK
4	2402	106.42	--	--	94.88	11.54	PK

Note:

1. All readings above 1GHz are performed with peak and/or average measurements as necessary.
2. Peak measurements: RBW = 1MHz, VBW = 3 MHz, Sweep: Auto.
3. Emission Level = Reading Level + Correct Factor.
4. The average measurement was not performed when the peak measured data under the limit of average detection.

Channel No.	Frequency (MHz)	Peak Measurement (dBμV/m)	Duty Cycle Factor (dB)	Average Measurement (dBμV/m)	Margin (dB)	Average Limit (dBμV/m)	Result
00 (Average)	2389.1	51.83	-24.746	27.084	-26.916	54.000	Pass
00 (Average)	2390	49.21	-24.746	24.464	-29.536	54.000	Pass
00 (Average)	2400	75.09	-24.746	50.344	--	--	Pass
00 (Average)	2402	106.42	-24.746	81.674	--	--	Pass

Note:

1. Average Measurement=Peak Measurement + Duty Cycle Factor
2. The Duty Cycle is refer to section 5.

Product : Intel® Wireless-AC 9560  
 Test Item : Band Edge  
 Test Mode : Mode 1: Transmit - 1Mbps (2480MHz)  
 Test Date : 2019/11/25

**Horizontal**

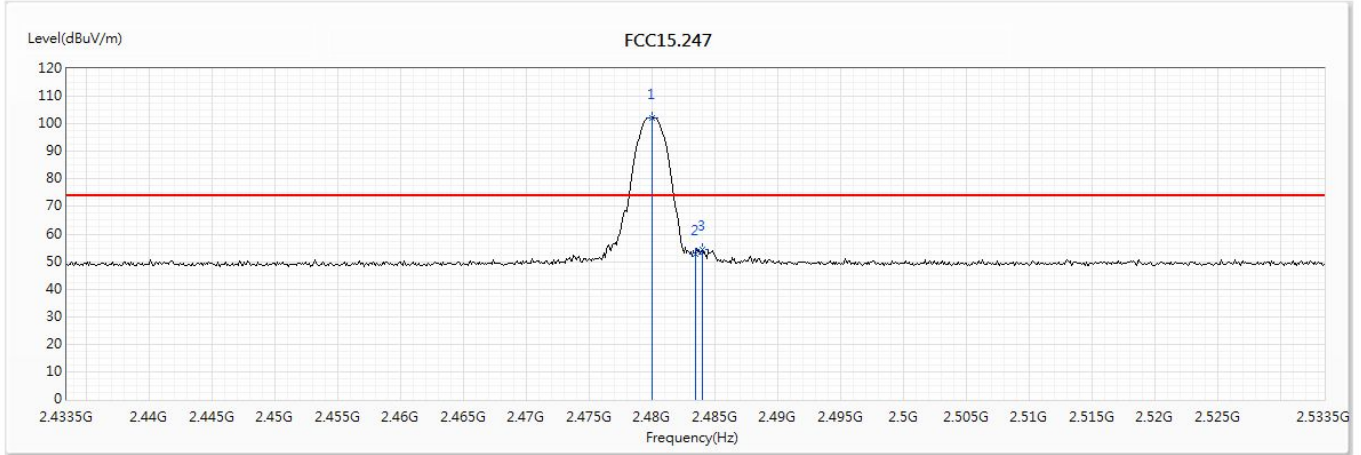

No	Frequency (MHz)	Emission Level (dBuV/m)	Limit (dBuV/m)	Margin (dB)	Reading Level (dBuV)	Correct Factor (dB/m)	Detector Type
1	2480	102.35	--	--	90.68	11.67	PK
2	2483.5	52.79	74.00	-21.21	41.11	11.68	PK
3	2484	54.57	74.00	-19.43	42.89	11.68	PK

Note:

1. All readings above 1GHz are performed with peak and/or average measurements as necessary.
2. Peak measurements: RBW = 1MHz, VBW = 3 MHz, Sweep: Auto.
3. Emission Level = Reading Level + Correct Factor.
4. The average measurement was not performed when the peak measured data under the limit of average detection.

Channel No.	Frequency (MHz)	Peak Measurement (dBμV/m)	Duty Cycle Factor (dB)	Average Measurement (dBμV/m)	Margin (dB)	Average Limit (dBμV/m)	Result
78 (Average)	2480	102.35	-24.746	77.604	--	--	Pass
78 (Average)	2483.5	52.79	-24.746	28.044	-25.956	54.000	Pass
78 (Average)	2484	54.57	-24.746	29.824	-24.176	54.000	Pass

Note:

1. Average Measurement=Peak Measurement + Duty Cycle Factor
2. The Duty Cycle is refer to section 5.

Product : Intel® Wireless-AC 9560  
 Test Item : Band Edge  
 Test Mode : Mode 1: Transmit - 1Mbps (2480MHz)  
 Test Date : 2019/11/25

**Vertical**

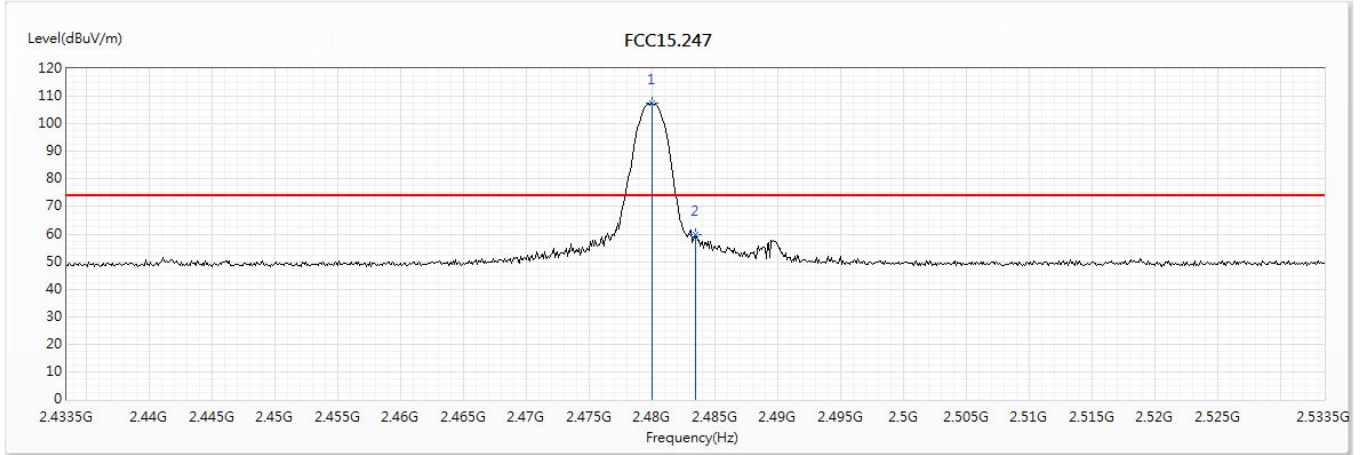

No	Frequency (MHz)	Emission Level (dBuV/m)	Limit (dBuV/m)	Margin (dB)	Reading Level (dBuV)	Correct Factor (dB/m)	Detector Type
1	2480	107.35	--	--	95.68	11.67	PK
2	2483.5	59.73	74.00	-14.27	48.05	11.68	PK

Note:

1. All readings above 1GHz are performed with peak and/or average measurements as necessary.
2. Peak measurements: RBW = 1MHz, VBW = 3 MHz, Sweep: Auto.
3. Emission Level = Reading Level + Correct Factor.
4. The average measurement was not performed when the peak measured data under the limit of average detection.

Channel No.	Frequency (MHz)	Peak Measurement (dBμV/m)	Duty Cycle Factor (dB)	Average Measurement (dBμV/m)	Margin (dB)	Average Limit (dBμV/m)	Result
78 (Average)	2480	107.35	-24.746	82.604	--	--	Pass
78 (Average)	2483.5	59.73	-24.746	34.984	-19.016	54.000	Pass

Note:

1. Average Measurement=Peak Measurement + Duty Cycle Factor
2. The Duty Cycle is refer to section 5.

Product : Intel® Wireless-AC 9560  
 Test Item : Band Edge  
 Test Mode : Mode 2: Transmit - 3Mbps (2402MHz)  
 Test Date : 2019/11/25

**Horizontal**

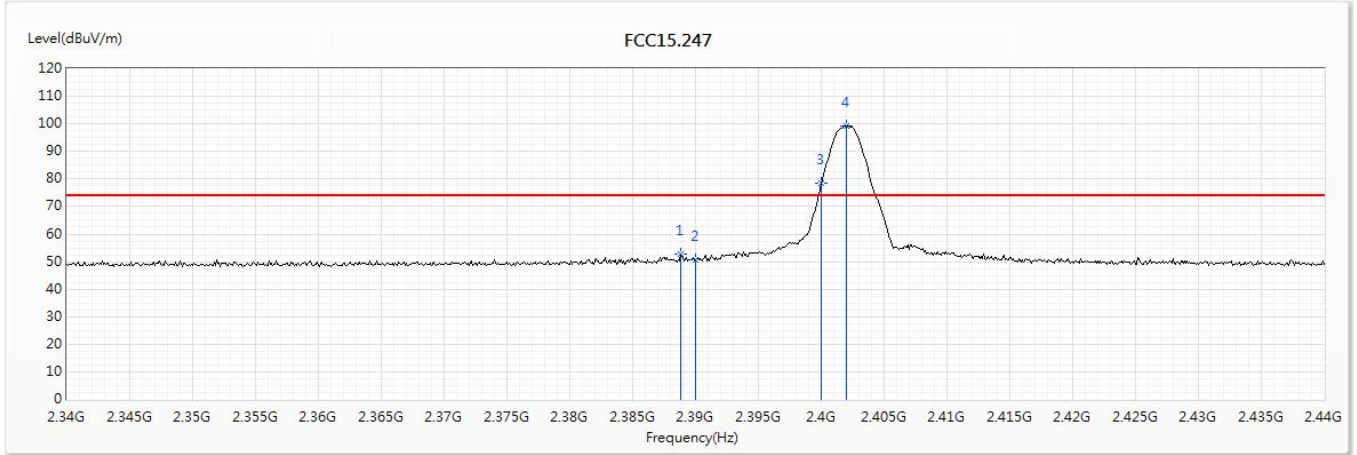

No	Frequency (MHz)	Emission Level (dBuV/m)	Limit (dBuV/m)	Margin (dB)	Reading Level (dBuV)	Correct Factor (dB/m)	Detector Type
1	2388.8	52.56	74.00	-21.44	41.03	11.53	PK
2	2390	50.62	74.00	-23.38	39.09	11.53	PK
3	2400	78.27	--	--	66.73	11.54	PK
4	2402	99.21	--	--	87.67	11.54	PK

Note:

1. All readings above 1GHz are performed with peak and/or average measurements as necessary.
2. Peak measurements: RBW = 1MHz, VBW = 3 MHz, Sweep: Auto.
3. Emission Level = Reading Level + Correct Factor.
4. The average measurement was not performed when the peak measured data under the limit of average detection.

Channel No.	Frequency (MHz)	Peak Measurement (dBμV/m)	Duty Cycle Factor (dB)	Average Measurement (dBμV/m)	Margin (dB)	Average Limit (dBμV/m)	Result
00 (Average)	2388.8	52.56	-24.642	27.918	-26.082	54.000	Pass
00 (Average)	2390	50.62	-24.642	25.978	-28.022	54.000	Pass
00 (Average)	2400	78.27	-24.642	53.628	--	--	Pass
00 (Average)	2402	99.21	-24.642	74.568	--	--	Pass

Note:

1. Average Measurement=Peak Measurement + Duty Cycle Factor
2. The Duty Cycle is refer to section 5.

Product : Intel® Wireless-AC 9560  
 Test Item : Band Edge  
 Test Mode : Mode 2: Transmit - 3Mbps (2402MHz)  
 Test Date : 2019/11/25

**Vertical**

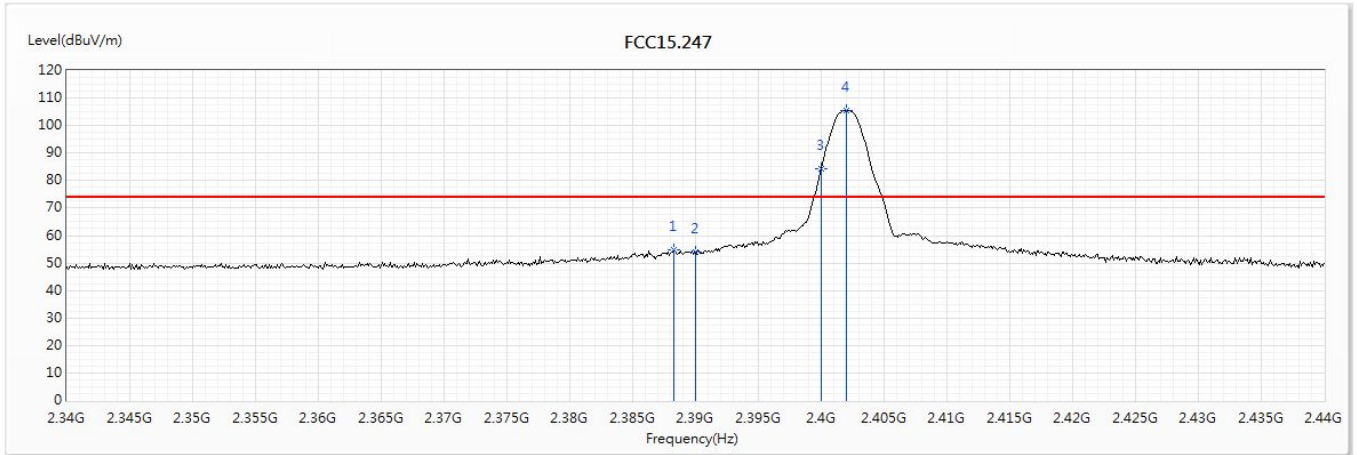

No	Frequency (MHz)	Emission Level (dBuV/m)	Limit (dBuV/m)	Margin (dB)	Reading Level (dBuV)	Correct Factor (dB/m)	Detector Type
1	2388.3	54.99	74.00	-19.01	43.46	11.53	PK
2	2390	54.18	74.00	-19.82	42.65	11.53	PK
3	2400	84.43	--	--	72.89	11.54	PK
4	2402	105.59	--	--	94.05	11.54	PK

Note:

1. All readings above 1GHz are performed with peak and/or average measurements as necessary.
2. Peak measurements: RBW = 1MHz, VBW = 3 MHz, Sweep: Auto.
3. Emission Level = Reading Level + Correct Factor.
4. The average measurement was not performed when the peak measured data under the limit of average detection.

Channel No.	Frequency (MHz)	Peak Measurement (dBμV/m)	Duty Cycle Factor (dB)	Average Measurement (dBμV/m)	Margin (dB)	Average Limit (dBμV/m)	Result
00 (Average)	2388.3	54.99	-24.642	30.348	-23.652	54.000	Pass
00 (Average)	2390	54.18	-24.642	29.538	-24.462	54.000	Pass
00 (Average)	2400	84.43	-24.642	59.788	--	--	Pass
00 (Average)	2402	105.59	-24.642	80.948	--	--	Pass

Note:

1. Average Measurement=Peak Measurement + Duty Cycle Factor
2. The Duty Cycle is refer to section 5.

Product : Intel® Wireless-AC 9560  
 Test Item : Band Edge  
 Test Mode : Mode 2: Transmit - 3Mbps (2480MHz)  
 Test Date : 2019/11/25

**Horizontal**

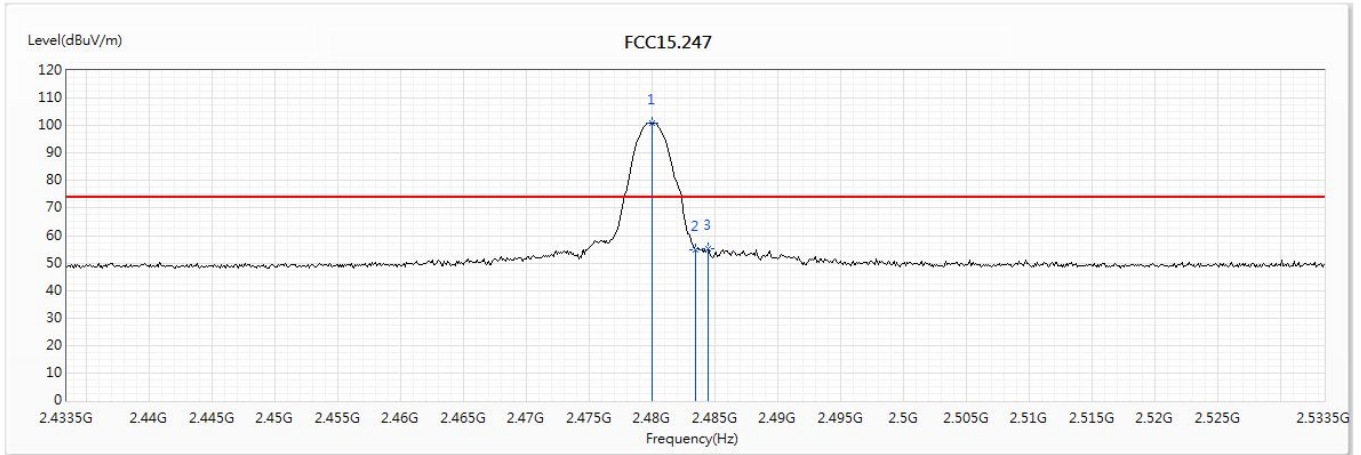

No	Frequency (MHz)	Emission Level (dBuV/m)	Limit (dBuV/m)	Margin (dB)	Reading Level (dBuV)	Correct Factor (dB/m)	Detector Type
1	2480	101.04	--	--	89.37	11.67	PK
2	2483.5	54.71	74.00	-19.29	43.03	11.68	PK
3	2484.5	55.39	74.00	-18.61	43.71	11.68	PK

Note:

1. All readings above 1GHz are performed with peak and/or average measurements as necessary.
2. Peak measurements: RBW = 1MHz, VBW = 3 MHz, Sweep: Auto.
3. Emission Level = Reading Level + Correct Factor.
4. The average measurement was not performed when the peak measured data under the limit of average detection.

Channel No.	Frequency (MHz)	Peak Measurement (dBμV/m)	Duty Cycle Factor (dB)	Average Measurement (dBμV/m)	Margin (dB)	Average Limit (dBμV/m)	Result
78 (Average)	2480	101.04	-24.642	76.398	--	--	Pass
78 (Average)	2483.5	54.71	-24.642	30.068	-23.932	54.000	Pass
78 (Average)	2484.5	55.39	-24.642	30.748	-23.252	54.000	Pass

Note:

1. Average Measurement=Peak Measurement + Duty Cycle Factor
2. The Duty Cycle is refer to section 5.



Product : Intel® Wireless-AC 9560  
 Test Item : Band Edge  
 Test Mode : Mode 2: Transmit - 3Mbps (2480MHz)  
 Test Date : 2019/11/25

**Vertical**

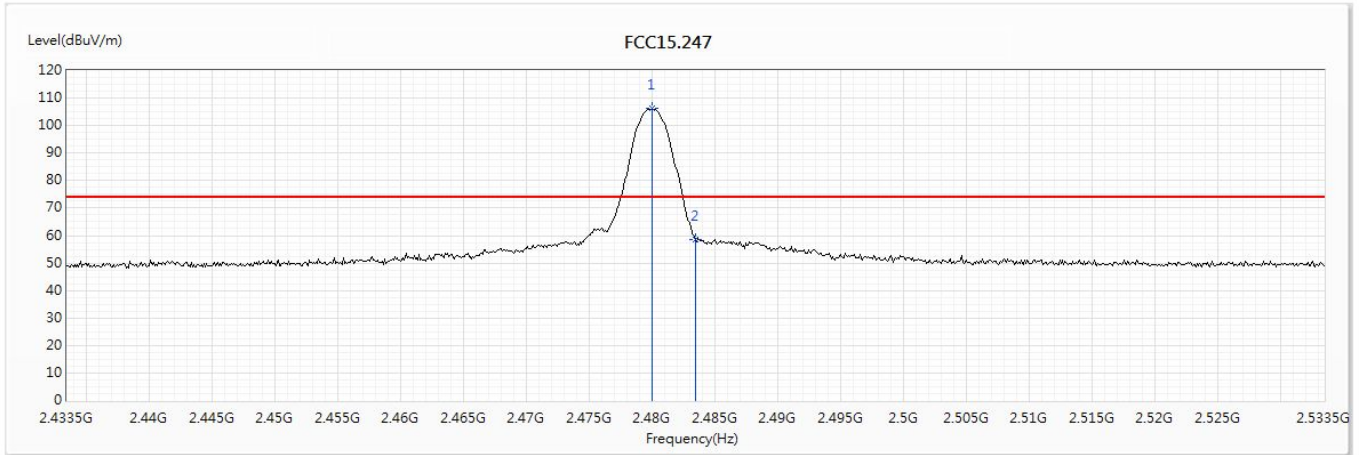

No	Frequency (MHz)	Emission Level (dBuV/m)	Limit (dBuV/m)	Margin (dB)	Reading Level (dBuV)	Correct Factor (dB/m)	Detector Type
1	2480	106.09	--	--	94.42	11.67	PK
2	2483.5	58.72	74.00	-15.28	47.04	11.68	PK

Note:

1. All readings above 1GHz are performed with peak and/or average measurements as necessary.
2. Peak measurements: RBW = 1MHz, VBW = 3 MHz, Sweep: Auto.
3. Emission Level = Reading Level + Correct Factor.
4. The average measurement was not performed when the peak measured data under the limit of average detection.

Channel No.	Frequency (MHz)	Peak Measurement (dBμV/m)	Duty Cycle Factor (dB)	Average Measurement (dBμV/m)	Margin (dB)	Average Limit (dBμV/m)	Result
78 (Average)	2480	106.09	-24.642	81.448	--	--	Pass
78 (Average)	2483.5	58.72	-24.642	34.078	-19.922	54.000	Pass

Note:

1. Average Measurement=Peak Measurement + Duty Cycle Factor
2. The Duty Cycle is refer to section 5.

## 5. Duty Cycle

### 5.1. Test Setup

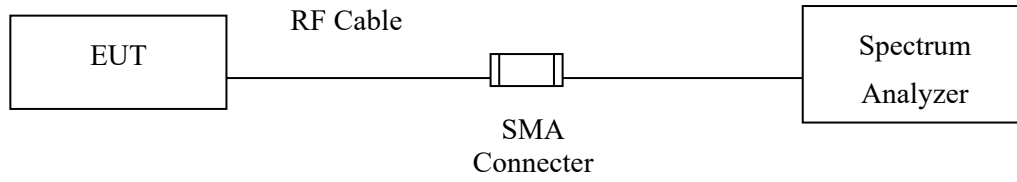

### 5.2. Uncertainty

$\pm 2.31\text{ms}$

### 5.3. Test Result of Duty Cycle

Product : Intel® Wireless-AC 9560  
 Test Item : Duty Cycle Data  
 Test Mode : Mode 1: Transmit - 1Mbps

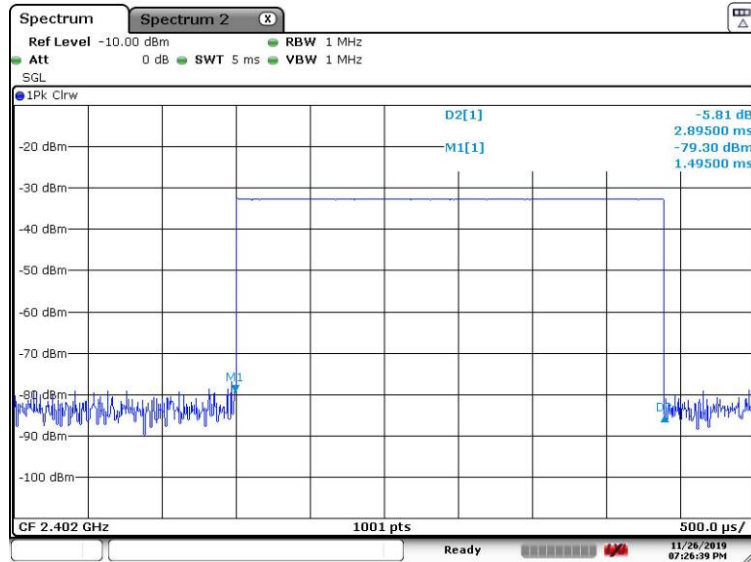

Date: 26.NOV.2019 19:26:39

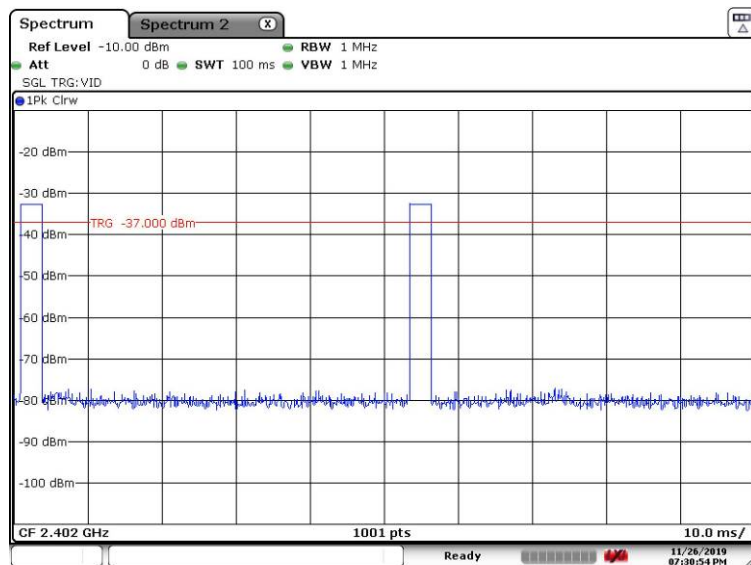

Date: 26.NOV.2019 19:30:54

Time on of 100ms= 2.895ms\*2= 5.790ms

Duty Cycle=5.79ms / 100ms= 0.0579

Duty Cycle correction factor= 20 LOG 0.0579= -24.746 dB

Duty Cycle correction factor	-24.746	dB
------------------------------	---------	----

Product : Intel® Wireless-AC 9560  
 Test Item : Duty Cycle Data  
 Test Mode : Mode 1: Transmit - 3Mbps

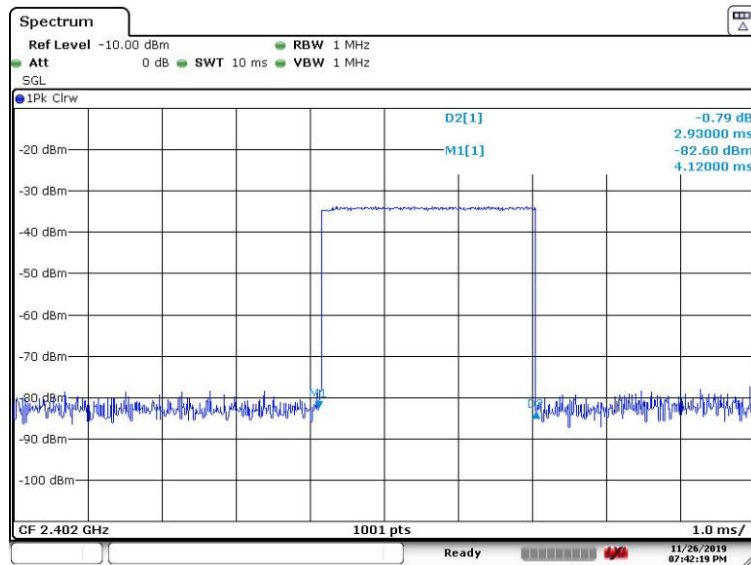

Date: 26.NOV.2019 19:42:19

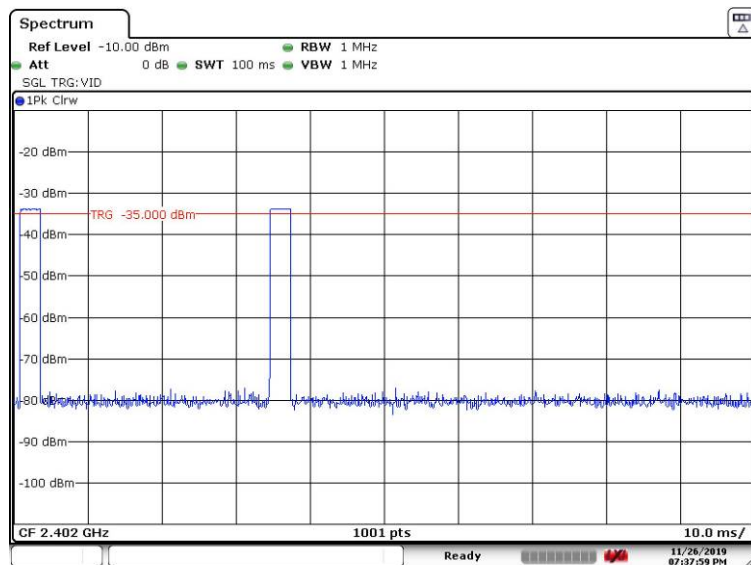

Date: 26.NOV.2019 19:38:00

Time on of 100ms= 2.93ms\*2= 5.860ms

Duty Cycle=5.86ms / 100ms= 0.0586

Duty Cycle correction factor= 20 LOG 0.0586= -24.642 dB

<b>Duty Cycle correction factor</b>	<b>-24.642</b>	<b>dB</b>
-------------------------------------	----------------	-----------

---

**6. EMI Reduction Method During Compliance Testing**

No modification was made during testing.