

# FCC Test Report

## (Class II Permissive Change)

Product Name	Intel® Wireless-AC 9560
Model No	9560NGW
FCC ID	2AKHF9560NG

Applicant	TONGFANG HONGKONG (SUZHOU) LIMITED
Address	NO. 83 Wu Lane, Suzhou Industrial Park, 215000 Suzhou City, Jiangsu Province, PEOPLE'S REPUBLIC OF CHINA

Date of Receipt	Dec. 12, 2018
Issued Date	Jan. 18, 2019
Report No.	18C0177R-RFUSP11V00-C
Report Version	V1.0



The test results relate only to the samples tested.

The test results shown in the test report are traceable to the national/international standard through the calibration report of the equipment and evaluated measurement uncertainty herein.

This report must not be used to claim product endorsement by TAF or any agency of the government.

The test report shall not be reproduced without the written approval of DEKRA Testing and Certification Co., Ltd.

# Test Report

Issued Date: Jan. 18, 2019

Report No.: 18C0177R-RFUSP11V00-C



Product Name	Intel® Wireless-AC 9560
Applicant	TONGFANG HONGKONG (SUZHOU) LIMITED
Address	NO. 83 Wu Lane, Suzhou Industrial Park, 215000 Suzhou City, Jiangsu Province, PEOPLE'S REPUBLIC OF CHINA
Manufacturer	Intel Mobile Communications
Model No.	9560NGW
FCC ID.	2AKHF9560NG
EUT Rated Voltage	AC 100-240V / 50-60Hz
EUT Test Voltage	AC 120V / 60Hz
Trade Name	Intel
Applicable Standard	FCC CFR Title 47 Part 15 Subpart E: 2017 ANSI C63.4: 2014, ANSI C63.10: 2013 789033 D02 General UNII Test Procedures New Rules v02
Test Result	Complied

Documented By : Anny Chou  
( Senior Adm. Specialist / Anny Chou )

Tested By : Sam Hsu  
( Assistant Engineer / Sam Hsu )

Approved By : Vincent Lin  
( Director / Vincent Lin )

## TABLE OF CONTENTS

Description	Page
<b>1. GENERAL INFORMATION.....</b>	<b>4</b>
1.1. EUT Description.....	4
1.2. Operational Description .....	8
1.3. Tested System Details.....	9
1.4. Configuration of tested System .....	10
1.5. EUT Exercise Software .....	10
1.6. Test Facility .....	11
1.7. List of Test Equipment .....	12
<b>2. Maximun conducted output power.....</b>	<b>13</b>
2.1. Test Setup .....	13
2.2. Limits .....	14
2.3. Test Procedure .....	15
2.4. Uncertainty .....	15
2.5. Test Result of Maximum conducted output power.....	16
<b>3. Radiated Emission.....</b>	<b>109</b>
3.1. Test Setup .....	109
3.2. Limits .....	110
3.3. Test Procedure .....	111
3.4. Uncertainty .....	113
3.5. Test Result of Radiated Emission.....	114
<b>4. Band Edge.....</b>	<b>460</b>
4.1. Test Setup .....	460
4.2. Limits .....	460
4.3. Test Procedure .....	461
4.4. Uncertainty .....	463
4.5. Test Result of Band Edge .....	464
<b>5. Duty Cycle.....</b>	<b>702</b>
5.1. Test Setup .....	702
5.2. Test Procedure .....	702
5.3. Uncertainty .....	702
5.4. Test Result of Duty Cycle.....	703
<b>6. EMI Reduction Method During Compliance Testing .....</b>	<b>717</b>

Attachment 1: EUT Test Photographs

Attachment 2: EUT Detailed Photographs

## 1. GENERAL INFORMATION

### 1.1. EUT Description

Product Name	Intel® Wireless-AC 9560
Trade Name	Intel
FCC ID.	2AKHF9560NG
Model No.	9560NGW
Frequency Range	802.11a/n-20MHz: 5180-5320MHz, 5500-5700MHz, 5745-5825MHz 802.11n-40MHz: 5190-5310MHz, 5510-5670MHz, 5755-5795MHz 802.11ac-20MHz: 5720MHz 802.11ac-40MHz: 5710MHz 802.11ac-80MHz: 5210-5290MHz, 5530-5690MHz, 5775MHz 802.11ac-160MHz: 5250MHz, 5570MHz
Number of Channels	802.11a/n-20MHz: 24, 802.11n-40MHz: 11 802.11ac-20MHz: 1, 802.11ac-40MHz: 1 802.11ac-80MHz: 6, 802.11ac-160MHz: 2
Data Rate	802.11a: 6 - 54Mbps 802.11n: up to 300Mbps 802.11ac-80MHz: up to 866.7Mbps 802.11ac-160MHz: up to 1733.3Mbps
Type of Modulation	802.11a/n/ac: OFDM, BPSK, QPSK, 16QAM, 64QAM, 256QAM
Antenna type	Slot Antenna
Channel Control	Auto
Antenna Gain	Refer to the table "Antenna List"
Test Platform	Product name: Notebook PC, Brand: TONGFANG, Model number: GK5CQ7Z, GK5CP0Z, GK5CQ8Z
Adapter	MFR: Chicony, M/N: A15-180P1A Input: AC 100-240V, 50-60Hz, 2.5A Output: DC 19.5V, 9.23A Cable Out: Non-Shielded, 1.7m with two ferrite cores

#### Antenna List

No.	Manufacturer	Model No.	Antenna Type	Peak Gain
1	WGT	ANTRG5Z119-0301 (Main) ANTRG5Z119-0302 (Aux)	Slot Antenna	1.1 dBi for 5.15~5.25GHz 1.34 dBi for 5.25~5.35GHz 2.6 dBi for 5.47~5.725GHz -0.1 dBi For 5.725~5.850GHz

Note: The antenna of EUT is conforming to FCC 15.203.

## 802.11a/n-20MHz Center Working Frequency of Each Channel:

Channel	Frequency	Channel	Frequency	Channel	Frequency	Channel	Frequency
Channel 36:	5180 MHz	Channel 40:	5200 MHz	Channel 44:	5220 MHz	Channel 48:	5240 MHz
Channel 52:	5260 MHz	Channel 56:	5280 MHz	Channel 60:	5300 MHz	Channel 64:	5320 MHz
Channel 100:	5500 MHz	Channel 104:	5520 MHz	Channel 108:	5540 MHz	Channel 112:	5560 MHz
Channel 116:	5580 MHz	Channel 120:	5600 MHz	Channel 124:	5620 MHz	Channel 128:	5640 MHz
Channel 132:	5660 MHz	Channel 136:	5680 MHz	Channel 140:	5700 MHz	Channel 149:	5745 MHz
Channel 153:	5765 MHz	Channel 157:	5785 MHz	Channel 161:	5805 MHz	Channel 165:	5825 MHz

## 802.11n-40MHz Center Working Frequency of Each Channel:

Channel	Frequency	Channel	Frequency	Channel	Frequency	Channel	Frequency
Channel 38:	5190 MHz	Channel 46:	5230 MHz	Channel 54:	5270 MHz	Channel 62:	5310 MHz
Channel 102:	5510 MHz	Channel 110:	5550 MHz	Channel 118:	5590 MHz	Channel 126:	5630 MHz
Channel 134:	5670 MHz	Channel 151:	5755 MHz	Channel 159:	5795 MHz		

## 802.11ac-20MHz Center Working Frequency of Each Channel:

Channel	Frequency
Channel 144:	5720 MHz

## 802.11ac-40MHz Center Working Frequency of Each Channel:

Channel	Frequency
Channel 142:	5710 MHz

## 802.11ac-80MHz Center Working Frequency of Each Channel:

Channel	Frequency	Channel	Frequency	Channel	Frequency	Channel	Frequency
Channel 42:	5210 MHz	Channel 58:	5290 MHz	Channel 106:	5530 MHz	Channel 122:	5610 MHz
Channel 138:	5690 MHz	Channel 155:	5775 MHz				

## 802.11ac-160MHz Center Working Frequency of Each Channel:

Channel	Frequency	Channel	Frequency
Channel 50:	5250 MHz	Channel 114:	5570 MHz

## Note:

1. This device is an Intel® Wireless-AC 9560 with a built-in WLAN (802.11a/b/g/n/ac) with Bluetooth (5.0 and V3.0+HS, V2.1+EDR) transceiver, this report for 5GHz WLAN.
2. Regarding to the operation frequency, the lowest, middle and highest frequency are selected to perform the test.
3. Lowest and highest data rates are tested in each mode. Only worst case is shown in the report.
4. These tests were conducted on a sample of the equipment for the purpose of demonstrating compliance of transmitter with Part 15 Subpart E for Unlicensed National Information Infrastructure devices.
5. This is to request a Class II permissive change for FCC ID: 2AKHF9560NG, originally granted on 03/16/2018.

The major change filed under this application is:

Change #1: Additional Chassis is added, Product name: Notebook PC, Brand: TONGFANG,  
Model number: GK5CQ7Z, GK5CP0Z, GK5CQ8Z.

All models are listed as below:

Brand	Model	GPU (NVIDIA)	Difference
TONGFANG	GK5CP0Z (Main test sample)	GTX2060, N18E-G1	All models are electrically identical and different model names are used to distinguish between different GPU specifications.
	GK5CQ7Z	GTX2070, N18E-G2	
	GK5CQ8Z	GTX2080, N18E-G3	

#2: Reduce the Output Power through firmware, and SAR measurement were evaluated.

#3: Addition an antenna, the antenna type is different from the original application and the antenna gain is higher than the original application

<p>Test Mode</p>	<p>Mode 1 SISO A: Transmit (802.11a_6Mbps)                  Mode 1 SISO A: Transmit (802.11n-20BW_7.2Mbps)                  Mode 1 SISO A: Transmit (802.11n-40BW_15Mbps)                  Mode 1 SISO A: Transmit (802.11ac-20BW_7.2Mbps)                  Mode 1 SISO A: Transmit (802.11ac-40BW_15Mbps)                  Mode 1 SISO A: Transmit (802.11ac-80BW_32.5Mbps)                  Mode 1 SISO A: Transmit (802.11ac-160BW_65Mbps)                  Mode 2 SISO B: Transmit (802.11a_6Mbps)                  Mode 2 SISO B: Transmit (802.11n-20BW_7.2Mbps)                  Mode 2 SISO B: Transmit (802.11n-40BW_15Mbps)                  Mode 2 SISO B: Transmit (802.11ac-20BW_7.2Mbps)                  Mode 2 SISO B: Transmit (802.11ac-40BW_15Mbps)                  Mode 2 SISO B: Transmit (802.11ac-80BW_32.5Mbps)                  Mode 2 SISO B: Transmit (802.11ac-160BW_65Mbps)                  Mode 3 MIMO: Transmit (802.11n-20BW_14.4Mbps)                  Mode 3 MIMO: Transmit (802.11n-40BW_30Mbps)                  Mode 3 MIMO: Transmit (802.11ac-20BW_14.4Mbps)                  Mode 3 MIMO: Transmit (802.11ac-40BW_30Mbps)                  Mode 3 MIMO: Transmit (802.11ac-80BW_65Mbps)                  Mode 3 MIMO: Transmit (802.11ac-160BW_130Mbps)</p>
------------------	---

### 1.3. Tested System Details

The types for all equipment, plus descriptions of all cables used in the tested system (including inserted cards) are:

Product	Manufacturer	Model No.	Serial No.	Power Cord	
1	LED Monitor	ViewSonic	VX2257-mhd	UFY163502150	Non-shielded, 1.8m
2	Monitor	Dell	U2410f	CN-0J257M-72872-985-0JML	Non-shielded, 1.8m
3	USB Mouse	Logitech	M-U0026	1245HS0684D8	N/A
4	USB 3.0(1T)	Transcend	TS1TSJ25M3	C13890-3746	N/A
5	USB 3.0(1T)	Transcend	TS1TSJ25M3	C13890-3746	N/A
6	USB 3.0(1T)	Transcend	TS1TSJ25M3	C13890-3746	N/A
7	Notebook PC	DELL	Latitude 5580	2HRD7H2	Non-shielded, 0.8m
8	Microphone & Earphone	Ergotech	ET-E201	N/A	N/A
9	SD Card 2GB	Transcend	TS2GSDC	205380-8144	N/A

Signal Cable Type	Signal cable Description	
A	Display Cable	Shielded, 2m
B	HDMI Cable	Shielded, 1.7m
C	Type-C to USB Cable	Non-shielded, 0.2m
D	Mouse Cable	Non-shielded, 1.8m
E	USB Cable	Non-shielded, 0.5m
F	USB Cable	Non-shielded, 0.5m
G	USB Cable	Non-shielded, 0.5m
H	Display Cable	Shielded, 1.8m
I	LAN Cable	Shielded, 1.9m
J	Microphone & Earphone Cable	Non-shielded, 1.8m



## 1.4. Configuration of tested System

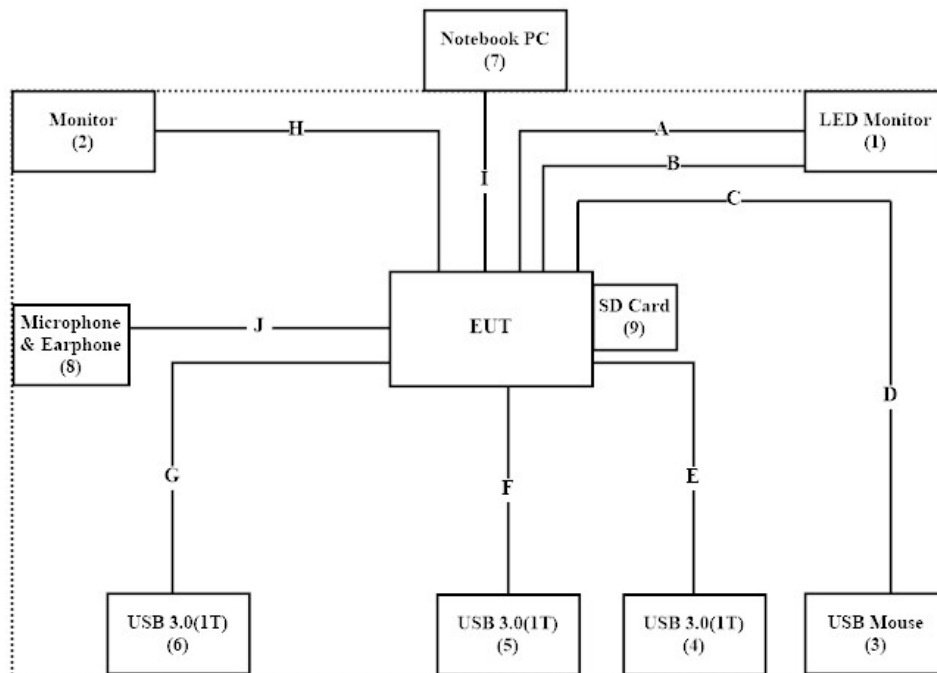

## 1.5. EUT Exercise Software

- (1) Setup the EUT as shown in Section 1.4.
- (2) Execute software “DRTU 10.1748.0-06430” on the EUT.
- (3) Configure the test mode, the test channel, and the data rate.
- (4) Press “OK” to start the continuous Transmit.
- (5) Verify that the EUT works properly.

## 1.6. Test Facility

Ambient conditions in the laboratory:

Items	Required (IEC 68-1)	Actual
Temperature (°C)	15-35	20-35
Humidity (%RH)	25-75	50-65
Barometric pressure (mbar)	860-1060	950-1000

The related certificate for our laboratories about the test site and management system can be downloaded from DEKRA Testing and Certification Co., Ltd. Web Site:

<http://www.dekra.com.tw/chinese/about/certificates.aspx?bval=5>

The address and introduction of DEKRA Testing and Certification Co., Ltd. laboratories can be founded in our Web site: [http:// www.dekra.com.tw](http://www.dekra.com.tw)

Site Description: Accredited by TAF  
Accredited Number: 3023

Site Name: DEKRA Testing and Certification Co., Ltd  
Site Address: No.5-22, Ruishukeng, Linkou Dist., New Taipei City 24451,  
Taiwan, R.O.C.  
TEL : 886-2-8601-3788 / FAX : 886-2-8601-3789  
E-Mail : [info.tw@dekra.com](mailto:info.tw@dekra.com)

FCC Accreditation Number: TW3023

## 1.7. List of Test Equipment

### For Conducted measurements /CB3/SR8

	Equipment	Manufacturer	Model No.	Serial No.	Cali. Date	Due. Date
	Temperature Chamber	WIT GROUP	TH-1S-B	EQ-201-00146	2018/02/12	2019/02/11
X	Spectrum Analyzer	Agilent	N9010A	MY53470892	2018/09/27	2019/09/26
X	Peak Power Analyzer	Keysight	8990B	MY51000410	2018/08/01	2019/07/31
X	Wideband Power Sensor	Keysight	N1923A	MY56080003	2018/07/25	2019/07/24
X	Wideband Power Sensor	Keysight	N1923A	MY56080004	2018/07/25	2019/07/24
X	EMI Test Receiver	R&S	ESCS 30	100369	2018/11/19	2019/11/18
X	LISN	R&S	ESH3-Z5	836679/017	2018/02/09	2019/02/08
X	LISN	R&S	ENV216	100097	2018/02/09	2019/02/08
X	Coaxial Cable	DEKRA	RG 400	LC018-RG	2018/06/21	2019/06/20

### For Radiated measurements /Site3/CB8

	Equipment	Manufacturer	Model No.	Serial No.	Cali. Date	Due. Date
X	Spectrum Analyzer	R&S	FSP40	100170	2018/03/12	2019/03/11
X	Loop Antenna	Teseq	HLA6121	37133	2017/10/13	2019/10/12
X	Bilog Antenna	Schaffner Chase	CBL6112B	2707	2018/06/24	2019/06/23
X	Coaxial Cable	DEKRA	RG 214	LC003-RG	2018/06/14	2019/06/13
X	Pre-Amplifier	Jet-Power	JPA-10M1G33	170101000330010	2018/06/14	2019/06/13
X	Horn Antenna	ETS-Lindgren	3117	00135205	2018/05/03	2019/05/02
X	Horn Antenna	SCHWARZBECK	9120D	576	2018/12/18	2019/12/17
X	Pre-Amplifier	EMCI	EMC012630SE	980210	2018/04/10	2019/04/09
X	Horn Antenna	Com-Power	AH-840	101043	2019/01/09	2020/01/08
X	Amplifier + Cable	EMCI	EMC184045SE	980370	2018/03/21	2019/03/20
X	Filter	MICRO-TRONICS	BRM50702	G270	2018/08/06	2019/08/05
X	Filter	MICRO-TRONICS	BRM50716	G196	2018/08/06	2019/08/05

#### Note:

1. All equipments are calibrated every one year.
2. The test instruments marked with "X" are used to measure the final test results.
3. Test Software version :Quietek EMI 2.0 V2.1.113.

## 2. Maximun conducted output power

### 2.1. Test Setup

#### 99% Occupied Bandwidth

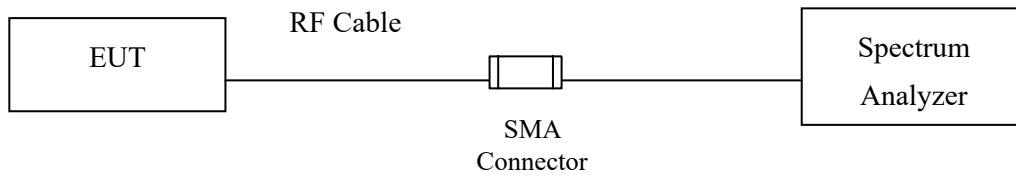

#### Conduction Power Measurement

Conduction Power Measurement (for 802.11an)

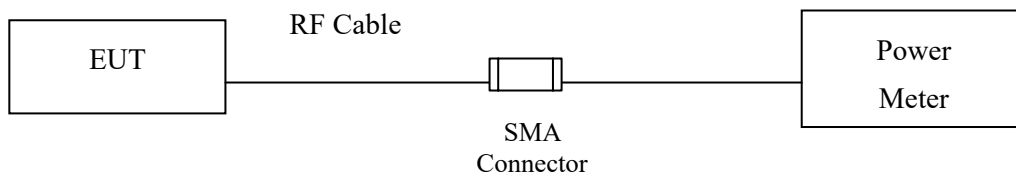

Conduction Power Measurement (for 802.11ac)

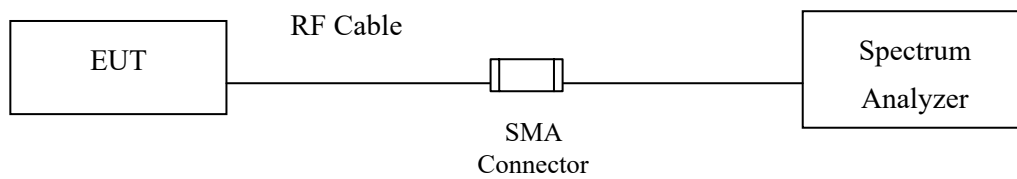

## 2.2. Limits

For the band 5.15-5.25 GHz,

**(i)** For an outdoor access point operating in the band 5.15-5.25 GHz, the maximum conducted output power over the frequency band of operation shall not exceed 1 W, provided the maximum antenna gain does not exceed 6 dBi. If transmitting antennas of directional gain greater than 6 dBi are used, the maximum conducted output power shall be reduced by the amount in dB that the directional gain of the antenna exceeds 6 dBi. The maximum e.i.r.p. at any elevation angle above 30 degrees as measured from the horizon must not exceed 125 mW (21 dBm).

**(ii)** For an indoor access point operating in the band 5.15-5.25 GHz, the maximum conducted output power over the frequency band of operation shall not exceed 1 W provided the maximum antenna gain does not exceed 6 dBi. In addition, if transmitting antennas of directional gain greater than 6 dBi are used, the maximum conducted output power shall be reduced by the amount in dB that the directional gain of the antenna exceeds 6 dBi.

**(iii)** For fixed point-to-point access points operating in the band 5.15-5.25 GHz, the maximum conducted output power over the frequency band of operation shall not exceed 1 W. Fixed point-to-point U-NII devices may employ antennas with directional gain up to 23 dBi without any corresponding reduction in the maximum conducted output power. For fixed point-to-point transmitters that employ a directional antenna gain greater than 23 dBi, a 1 dB reduction in maximum conducted output power is required for each 1 dB of antenna gain in excess of 23 dBi. Fixed, point-to-point operations exclude the use of point-to-multipoint systems, omnidirectional applications, and multiple collocated transmitters transmitting the same information. The operator of the U-NII device, or if the equipment is professionally installed, the installer, is responsible for ensuring that systems employing high gain directional antennas are used exclusively for fixed, point-to-point operations.

**(iv)** For mobile and portable client devices in the 5.15-5.25 GHz band, the maximum conducted output power over the frequency band of operation shall not exceed 250 mW provided the maximum antenna gain does not exceed 6 dBi. In addition, if transmitting antennas of directional gain greater than 6 dBi are used, the maximum conducted output power shall be reduced by the amount in dB that the directional gain of the antenna exceeds 6 dBi.

For the 5.25-5.35 GHz and 5.47-5.725 GHz bands, the maximum conducted output power over the frequency bands of operation shall not exceed the lesser of 250 mW or  $11 \text{ dBm} + 10 \log B$ , where B is the 99% emission bandwidth in megahertz. If transmitting antennas of directional gain greater than 6 dBi are used, the maximum conducted output power shall be reduced by the amount in dB that the directional gain of the antenna exceeds 6 dBi.

For the band 5.725-5.85 GHz, the maximum conducted output power over the frequency band of operation shall not exceed 1 W. In addition, if transmitting antennas of directional gain greater than 6 dBi are used, the maximum conducted output power shall be reduced by the amount in dB that the directional gain of the antenna exceeds 6 dBi. However, fixed point-to-point UNII devices operating in this band may employ transmitting antennas with directional gain greater than 6 dBi without any corresponding reduction in transmitter conducted power. Fixed, point-to-point operations exclude the use of point-to-multipoint systems, omnidirectional applications, and multiple colocated transmitters transmitting the same information. The operator of the U-NII device, or if the equipment is professionally installed, the installer, is responsible for ensuring that systems employing high gain directional antennas are used exclusively for fixed, point-to-point operations.

### 2.3. Test Procedure

As an alternative to FCC KDB-789033, the EUT maximum conducted output power was measured with an average power meter employing a video bandwidth greater than the 6dB BW of the emission under test. Maximum conducted output power was read directly from the meter across all data rates, and across three channels within each sub-band. Special care was used to make sure that the EUT was transmitting in continuous mode. This method exceeds the limitations of FCC KDB-789033, and provides more accurate measurements.

802.11an (BW  $\leq$  40MHz) Maximum conducted output power using KDB 789033 section E)3)b) Method PM-G (Measurement using a gated RF average power meter)

Note: the power meter have a video bandwidth that is greater than or equal to the measurement bandwidth.

802.11ac (BW=80MHz) Maximum conducted output power using KDB 789033 section E)2)b) Method SA-1 (trace averaging with the EUT transmitting at full power throughout each sweep).

When transmitted signals consist of two or more non-contiguous spectrum segments (e.g., 80+80 MHz mode) or when a single spectrum segment of a transmission crosses the boundary between two adjacent U-NII bands, KDB 644545 D03 section D) procedure is used for measurements.

### 2.4. Uncertainty

$\pm 1.27$ dB

## 2.5. Test Result of Maximum conducted output power

Product : Intel® Wireless-AC 9560  
 Test Item : Maximum conducted output power  
 Test Date : 2019/01/07  
 Test Mode : Mode 1 SISO A: Transmit (802.11a\_6Mbps)

Cable loss=1.5dB		Average Power								
Channel No.	Frequency (MHz)	Data Rate (Mbps)								Required Limit
		6	9	12	18	24	36	48	54	
		Measurement Level (dBm)								
36	5180	17.76	--	--	--	--	--	--	--	<24dBm
40	5200	19.28	19.22	19.15	19.08	18.99	18.91	18.85	18.80	<24dBm
48	5240	19.67	--	--	--	--	--	--	--	<24dBm
52	5260	19.86	--	--	--	--	--	--	--	<24dBm
56	5280	19.95	19.88	19.81	19.74	19.68	19.59	19.53	19.45	<24dBm
64	5320	15.35	--	--	--	--	--	--	--	<24dBm
100	5500	16.86	--	--	--	--	--	--	--	<24dBm
120	5600	19.92	19.84	19.78	19.68	19.61	19.54	19.44	19.35	<24dBm
140	5700	17.72	--	--	--	--	--	--	--	<24dBm
149	5745	19.79	--	--	--	--	--	--	--	<30dBm
157	5785	19.97	19.9	19.81	19.71	19.64	19.54	19.48	19.40	<30dBm
165	5825	19.88	--	--	--	--	--	--	--	<30dBm

Note: Maximum conducted output power Value =Reading value on average power meter + cable loss

**Maximum conducted output power Measurement:**

Channel No	Frequency Range (MHz)	99% Bandwidth (MHz)	Output Power (dBm)	Output Power Limit		Result
				(dBm)	dBm+10log(BW)	
36	5180	--	17.76	24	--	Pass
40	5200	--	19.28	24	--	Pass
48	5240	--	19.67	24	--	Pass
52	5260	17.029	19.86	24	23.31	Pass
56	5280	17.078	19.95	24	23.32	Pass
64	5320	17.018	15.35	24	23.31	Pass
100	5500	16.965	16.86	24	23.30	Pass
120	5600	17.092	19.92	24	23.33	Pass
140	5700	16.923	17.72	24	23.28	Pass
149	5745	--	19.79	30	--	Pass
157	5785	--	19.97	30	--	Pass
165	5825	--	19.88	30	--	Pass



99% Occupied Bandwidth:

Channel 52:

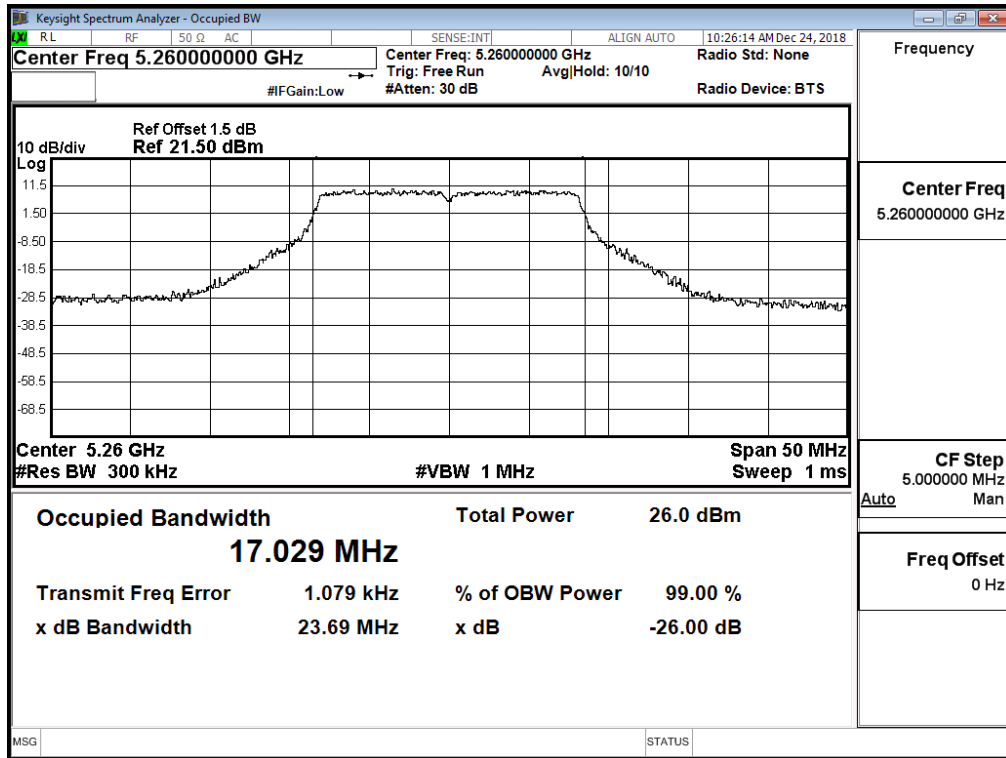

Channel 56:

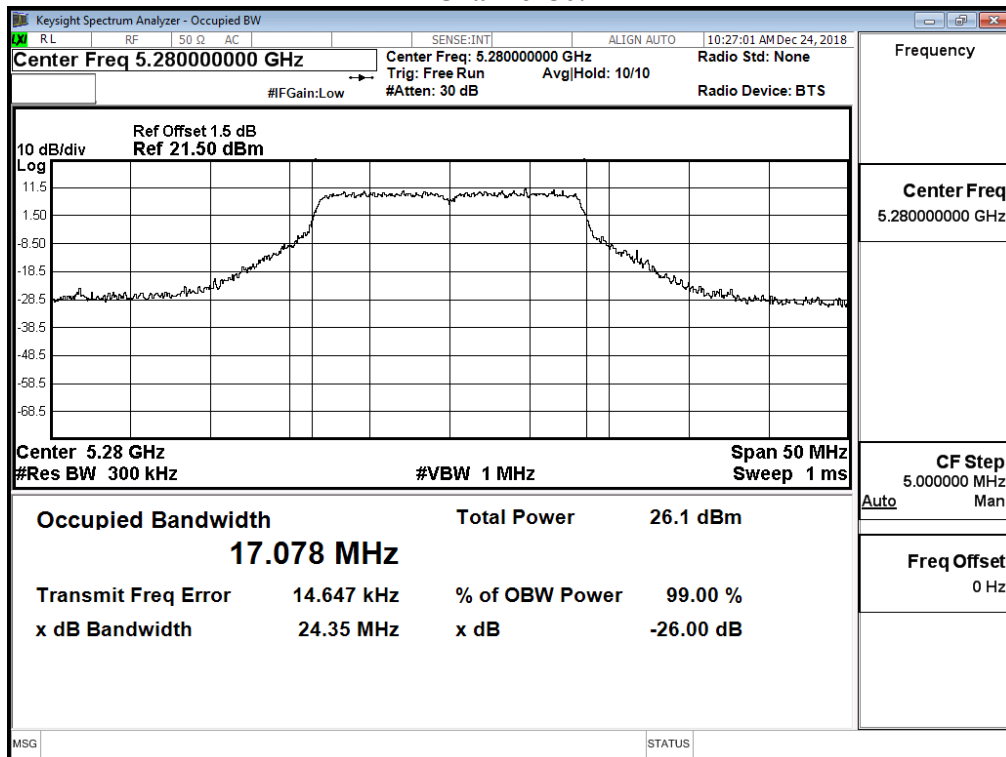

### Channel 64:

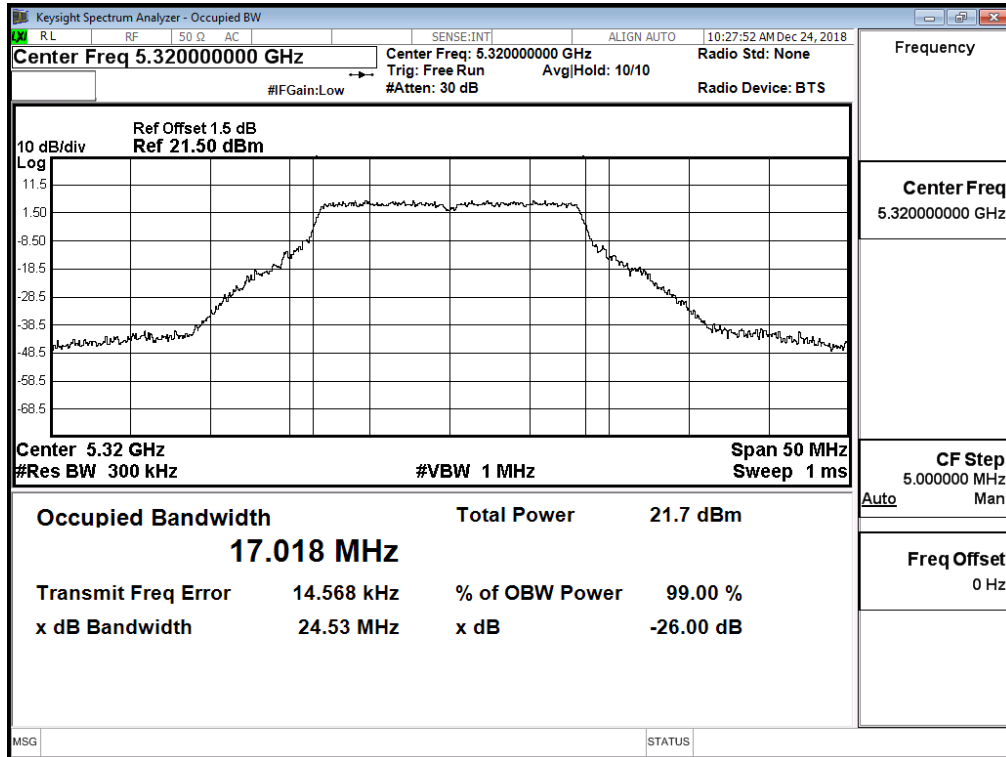

### Channel 100:

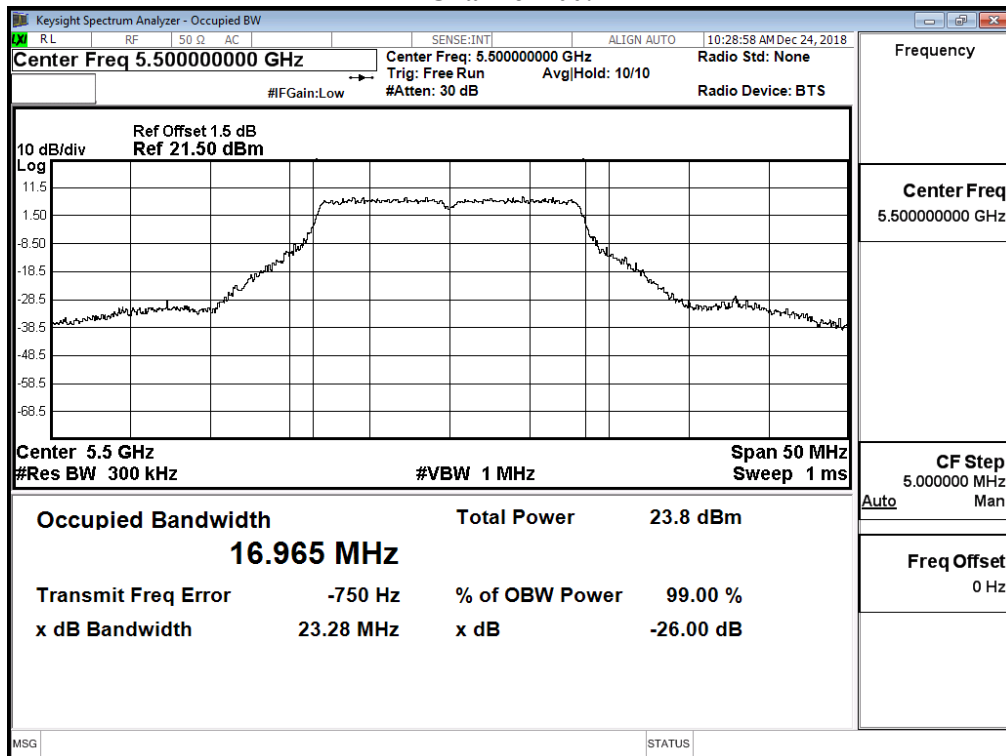

**Channel 120:**

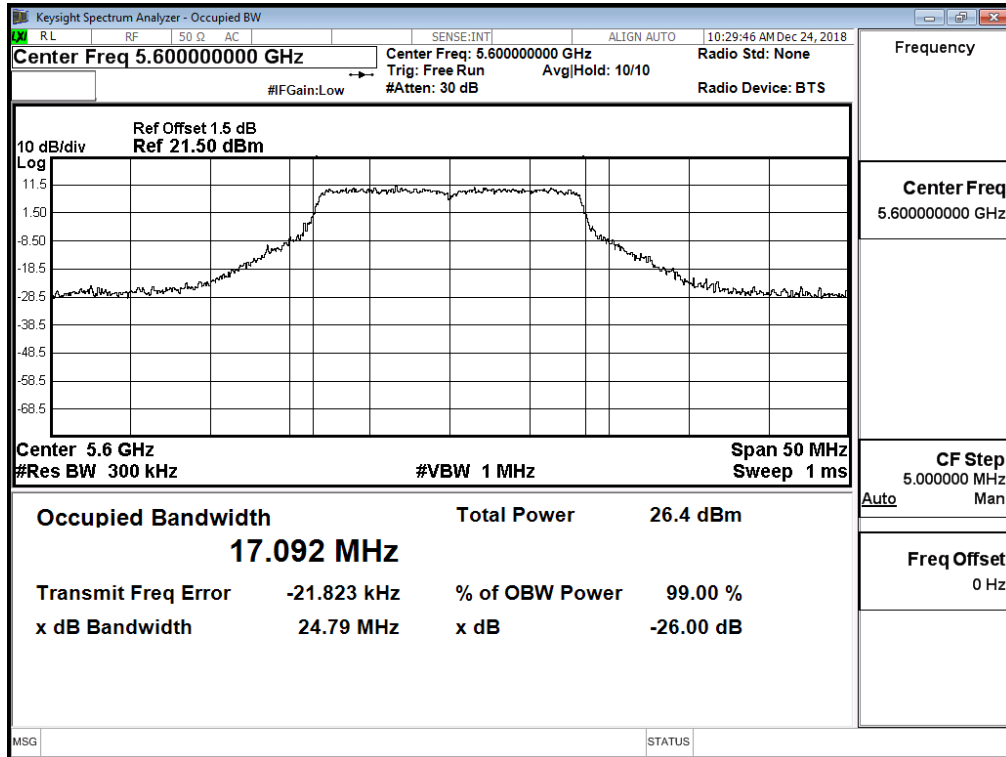

**Channel 140:**

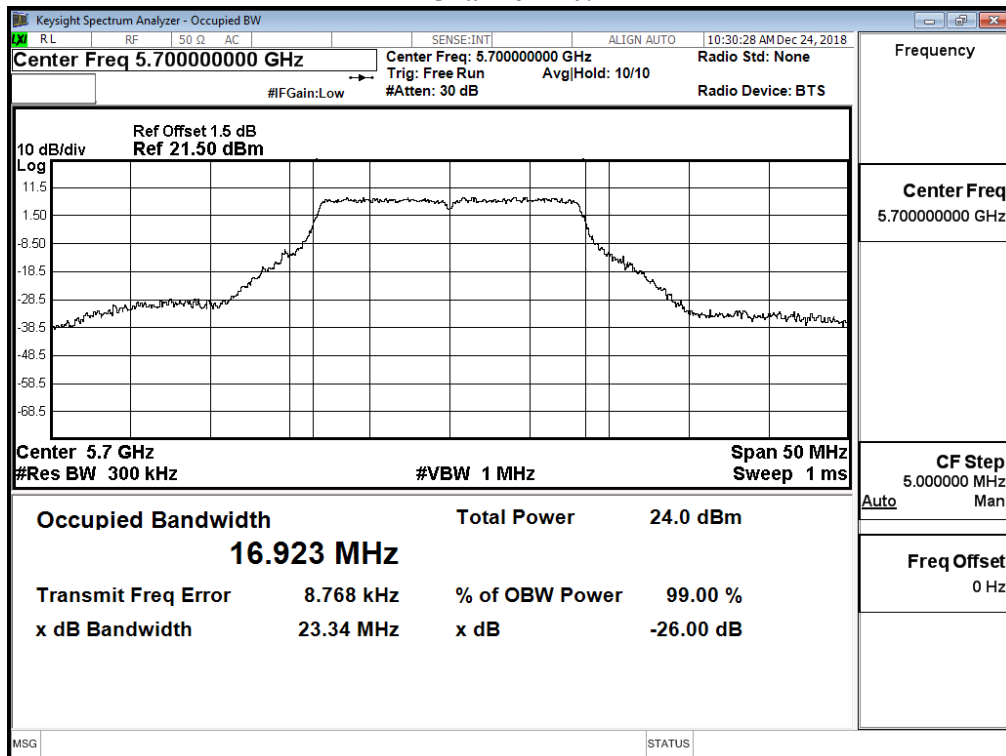

Product : Intel® Wireless-AC 9560  
 Test Item : Maximum conducted output power  
 Test Date : 2019/01/07  
 Test Mode : Mode 1 SISO A: Transmit (802.11n-20BW\_7.2Mbps)

Cable loss=1.5dB		Average Power								
Channel No.	Frequency (MHz)	Data Rate (Mbps)								Required Limit
		7.2	14.4	21.7	28.9	43.3	57.8	65	72.2	
		Measurement Level (dBm)								
36	5180	17.88	--	--	--	--	--	--	--	<24dBm
40	5200	19.41	19.35	19.29	19.22	19.12	19.07	19.02	18.93	<24dBm
48	5240	19.92	--	--	--	--	--	--	--	<24dBm
52	5260	19.87	--	--	--	--	--	--	--	<24dBm
56	5280	19.96	19.89	19.83	19.74	19.66	19.58	19.52	19.47	<24dBm
64	5320	15.32	--	--	--	--	--	--	--	<24dBm
100	5500	16.53	--	--	--	--	--	--	--	<24dBm
120	5600	19.89	19.82	19.73	19.65	19.55	19.46	19.38	19.29	<24dBm
140	5700	17.94	--	--	--	--	--	--	--	<24dBm
149	5745	19.84	--	--	--	--	--	--	--	<30dBm
157	5785	19.86	19.78	19.69	19.63	19.54	19.47	19.39	19.33	<30dBm
165	5825	19.78	--	--	--	--	--	--	--	<30dBm

Note: Maximum conducted output power Value =Reading value on average power meter + cable loss

**Maximum conducted output power Measurement:**

Channel No	Frequency Range (MHz)	99% Bandwidth (MHz)	Output Power (dBm)	Output Power Limit		Result
				(dBm)	dBm+10log(BW)	
36	5200	--	17.88	24	--	Pass
40	5240	--	19.41	24	--	Pass
48	5260	--	19.92	24	--	Pass
52	5280	18.162	19.87	24	23.59	Pass
56	5320	18.153	19.96	24	23.59	Pass
64	5500	18.118	15.32	24	23.58	Pass
100	5600	18.093	16.53	24	23.58	Pass
120	5700	18.127	19.89	24	23.58	Pass
140	5745	18.065	17.94	24	23.57	Pass
149	5785	--	19.84	30	--	Pass
157	5825	--	19.86	30	--	Pass
165	5200	--	19.78	30	--	Pass

99% Occupied Bandwidth:

Channel 52:

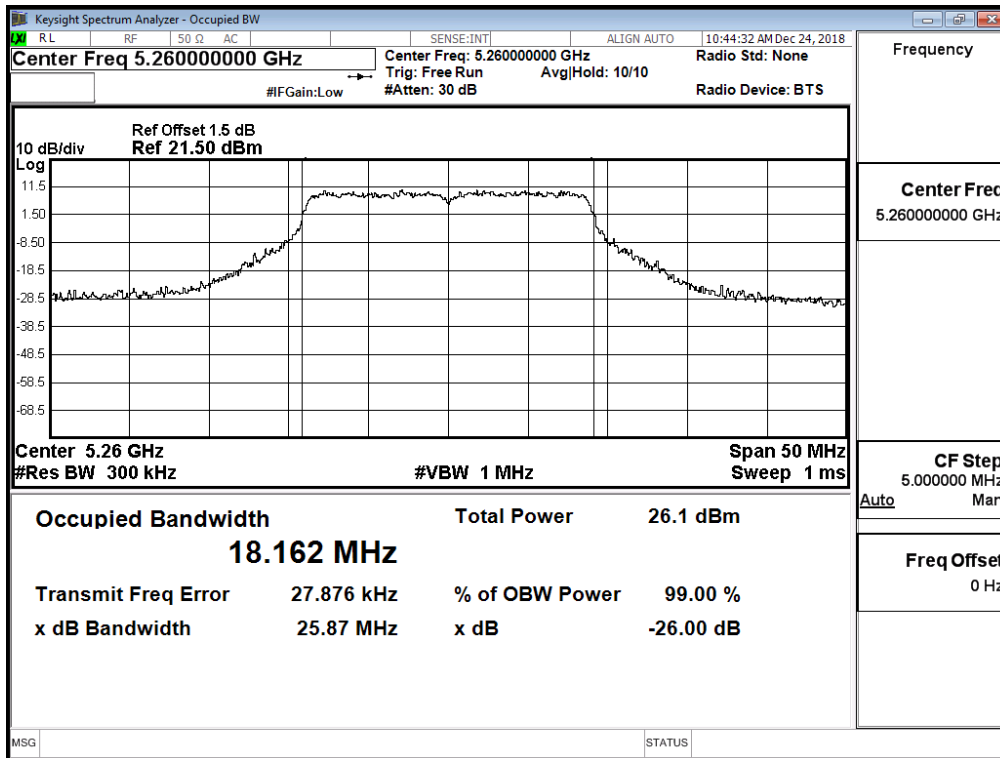

Channel 56:

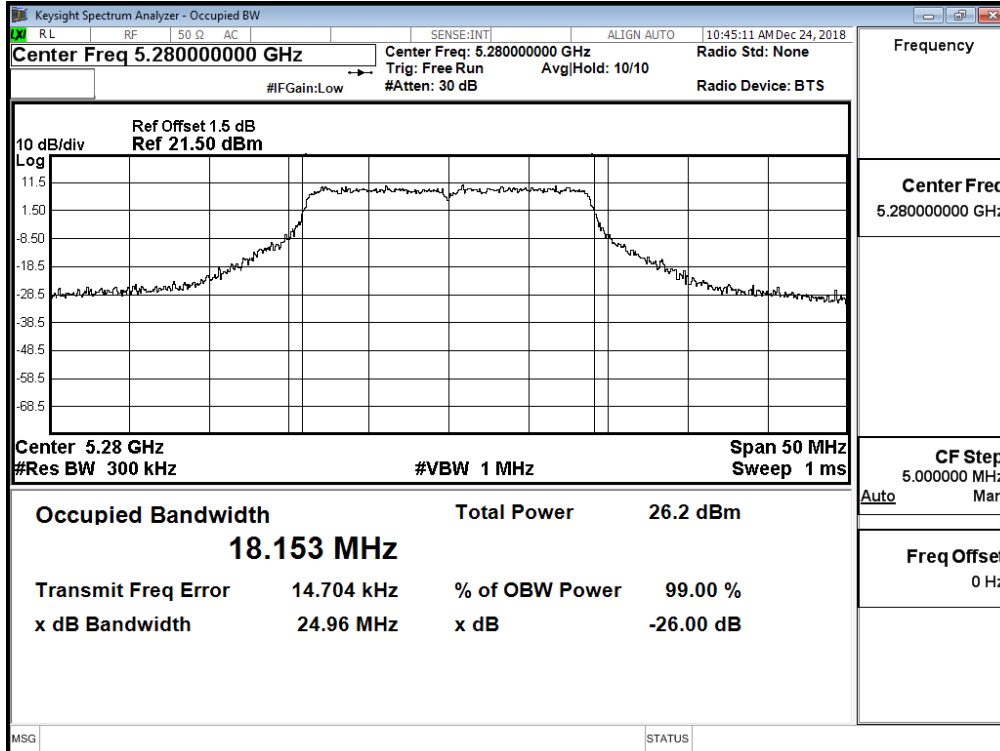

### Channel 64:

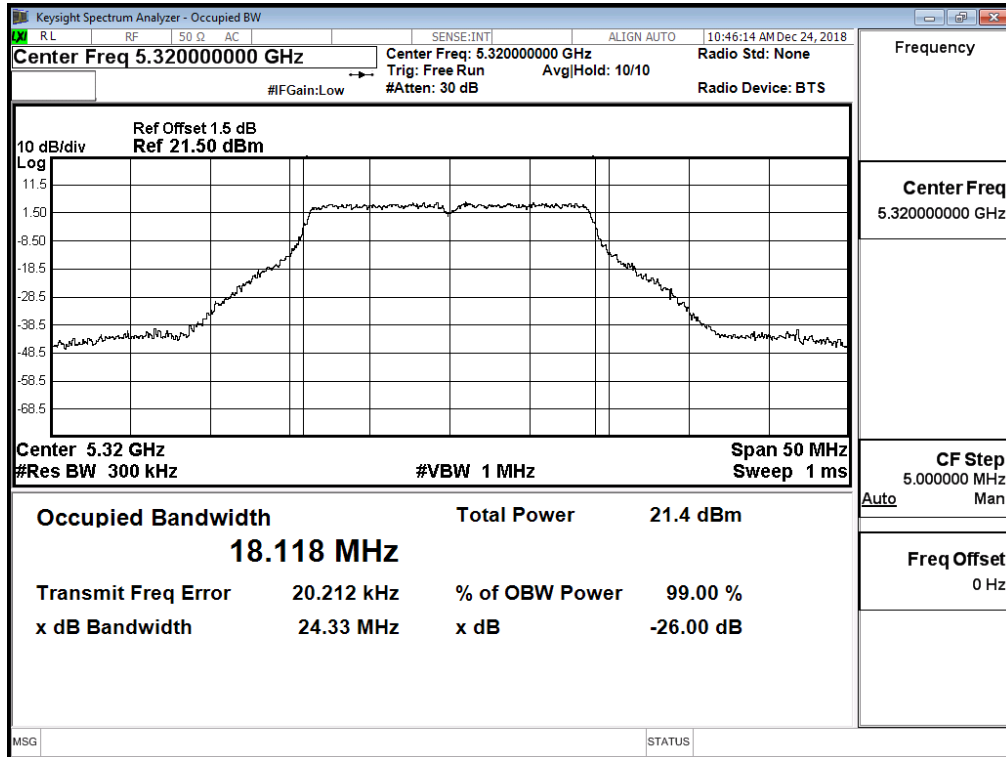

### Channel 100:

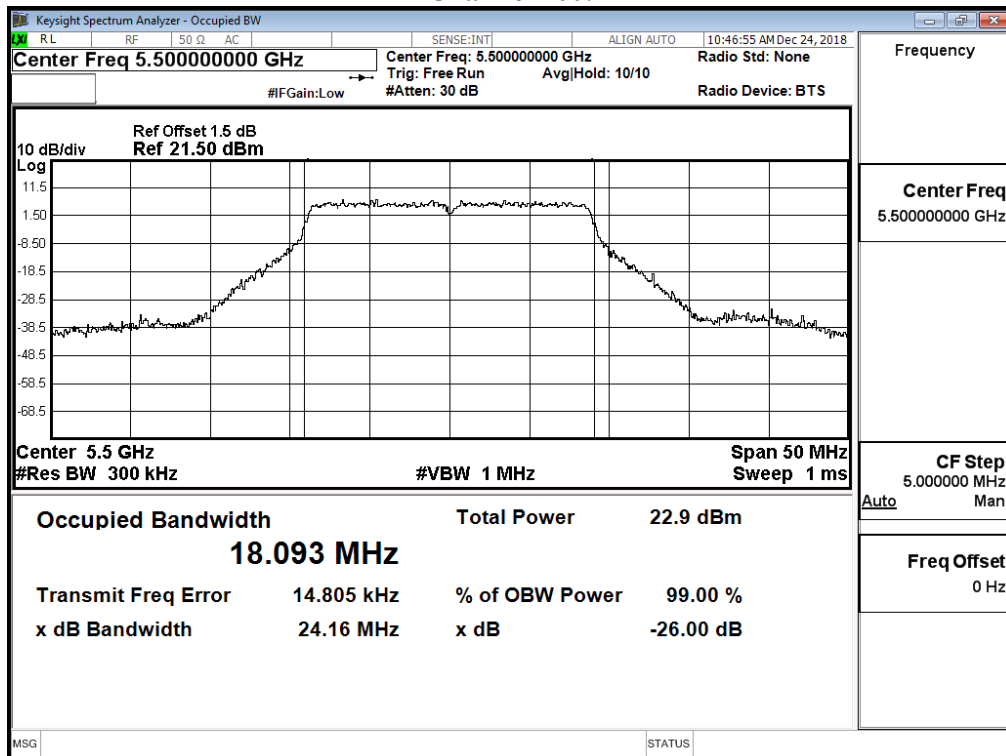

**Channel 120:**

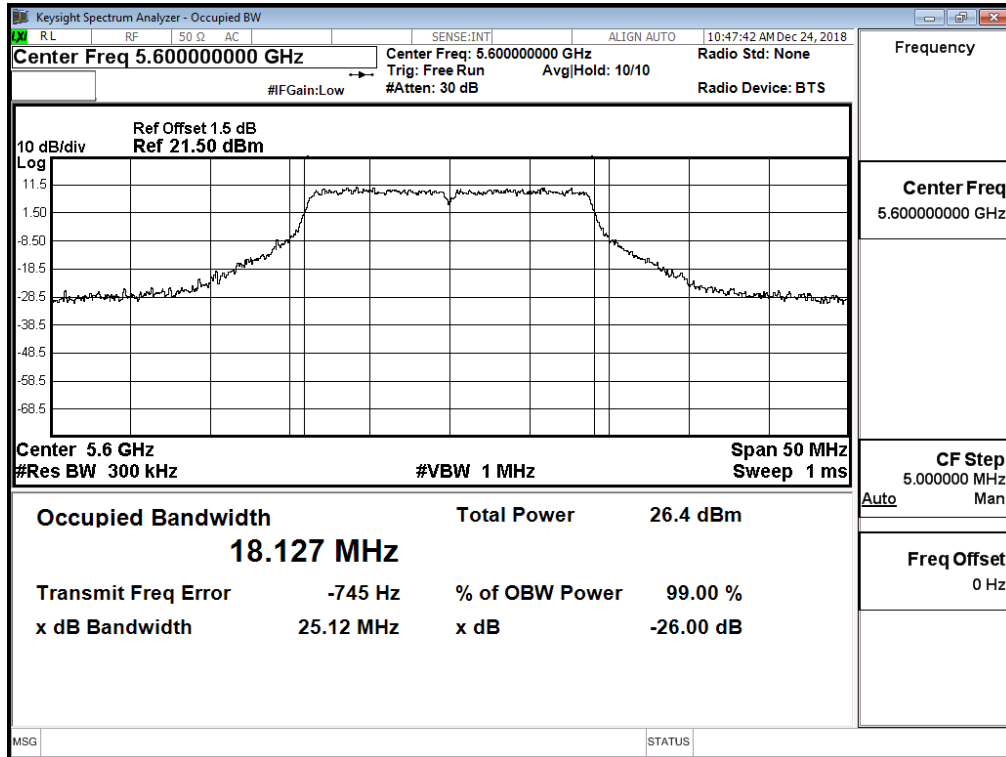

**Channel 140:**

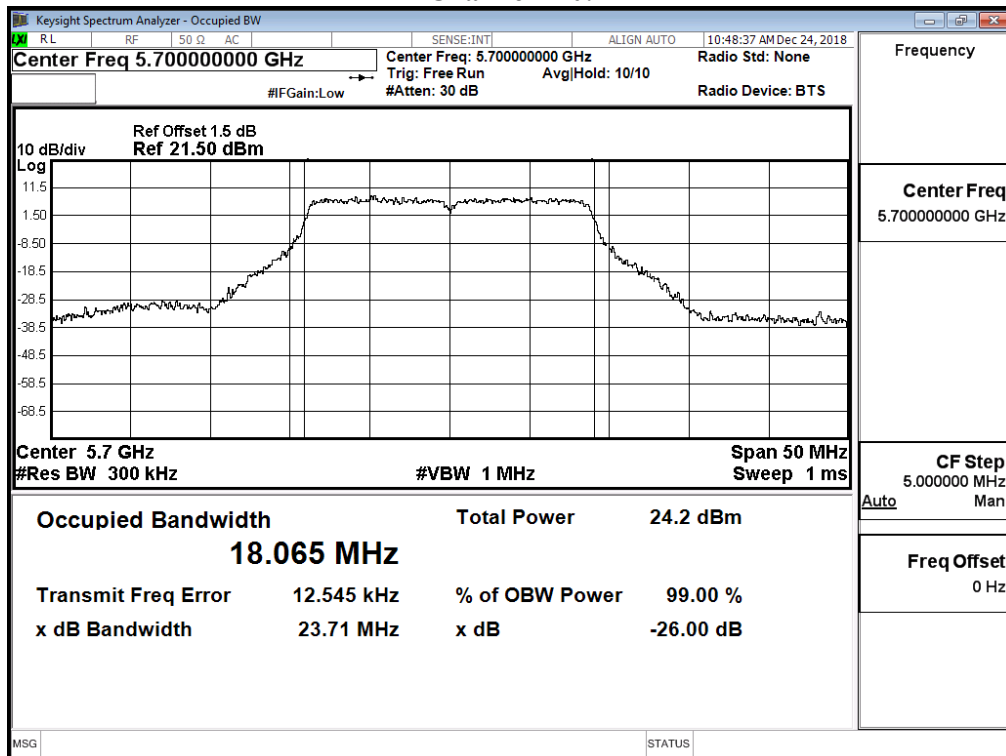



Product : Intel® Wireless-AC 9560  
 Test Item : Maximum conducted output power  
 Test Date : 2019/01/07  
 Test Mode : Mode 1 SISO A: Transmit (802.11n-40BW\_15Mbps)

Cable loss=1.5dB		Average Power								
Channel No.	Frequency (MHz)	Data Rate (Mbps)								Required Limit
		15	30	45	60	90	120	135	150	
		Measurement Level (dBm)								
38	5190	17.42	--	--	--	--	--	--	--	<24dBm
46	5230	18.92	18.87	18.8	18.73	18.67	18.62	18.57	18.52	<24dBm
54	5270	17.93	--	--	--	--	--	--	--	<24dBm
62	5310	13.82	13.76	13.7	13.62	13.57	13.48	13.38	13.31	<24dBm
102	5510	16.2	--	--	--	--	--	--	--	<24dBm
118	5590	19.91	19.82	19.76	19.70	19.62	19.54	19.45	19.39	<24dBm
134	5670	17.9	--	--	--	--	--	--	--	<24dBm
151	5755	18.73	--	--	--	--	--	--	--	<30dBm
159	5795	19.48	19.42	19.34	19.25	19.19	19.13	19.04	18.94	<30dBm

Note: Maximum conducted output power Value =Reading value on average power meter + cable loss

**Maximum conducted output power Measurement:**

Channel No	Frequency Range (MHz)	99% Bandwidth (MHz)	Output Power (dBm)	Output Power Limit		Result
				(dBm)	dBm+10log(BW)	
38	5190	--	17.42	24	--	Pass
46	5230	--	18.92	24	--	Pass
54	5270	36.489	17.93	24	26.62	Pass
62	5310	36.511	13.82	24	26.62	Pass
102	5510	36.540	16.2	24	26.63	Pass
118	5590	36.639	19.91	24	26.64	Pass
134	5670	36.603	17.9	24	26.64	Pass
151	5755	--	18.73	30	--	Pass
159	5795	--	19.48	30	--	Pass

99% Occupied Bandwidth:

Channel 54

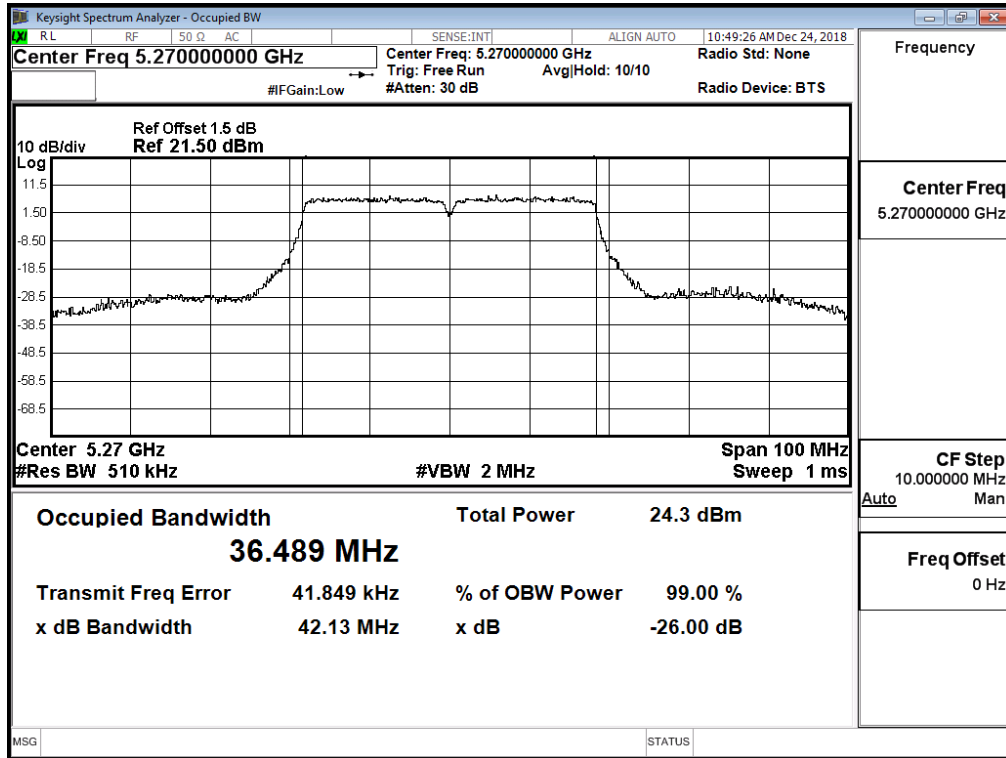

Channel 62

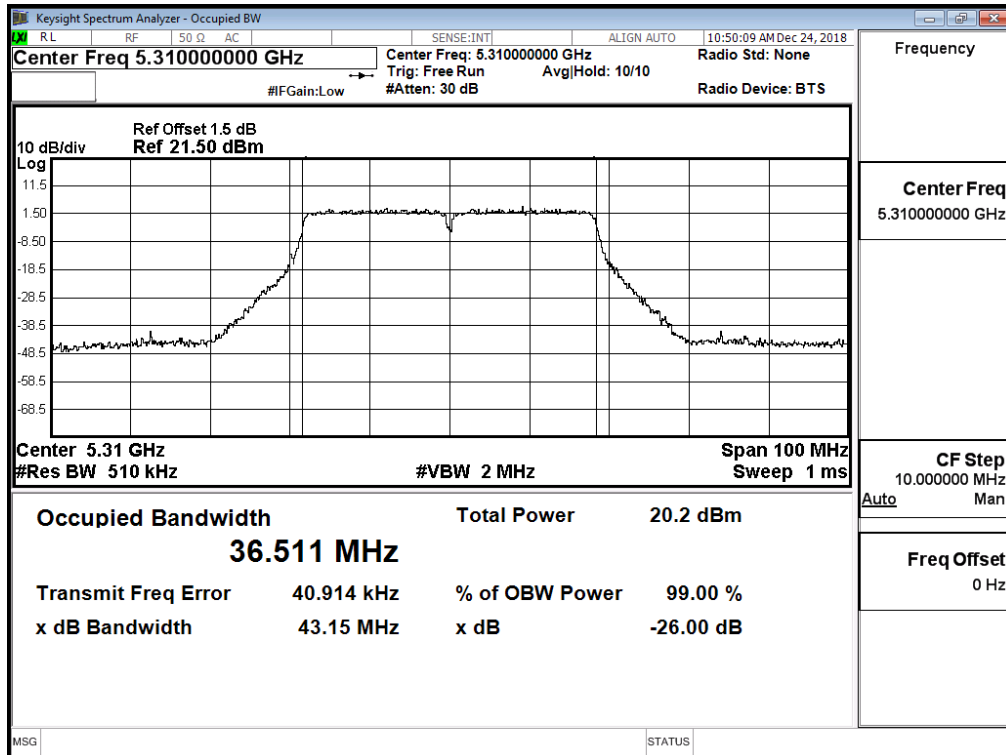

### Channel 102

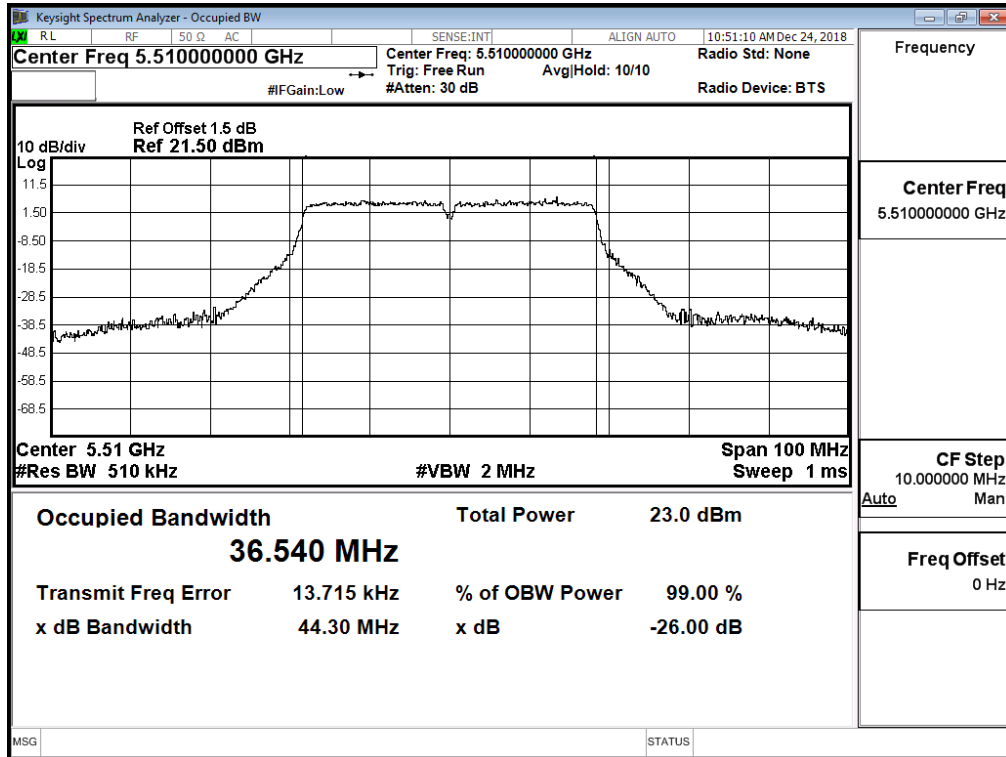

### Channel 118

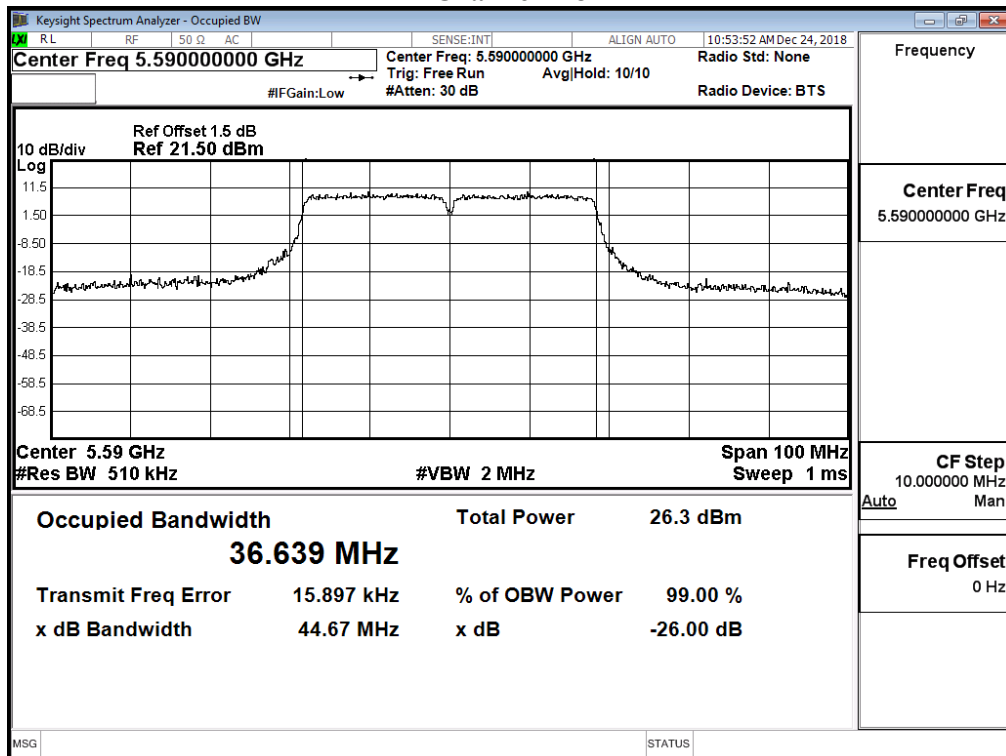

### Channel 134

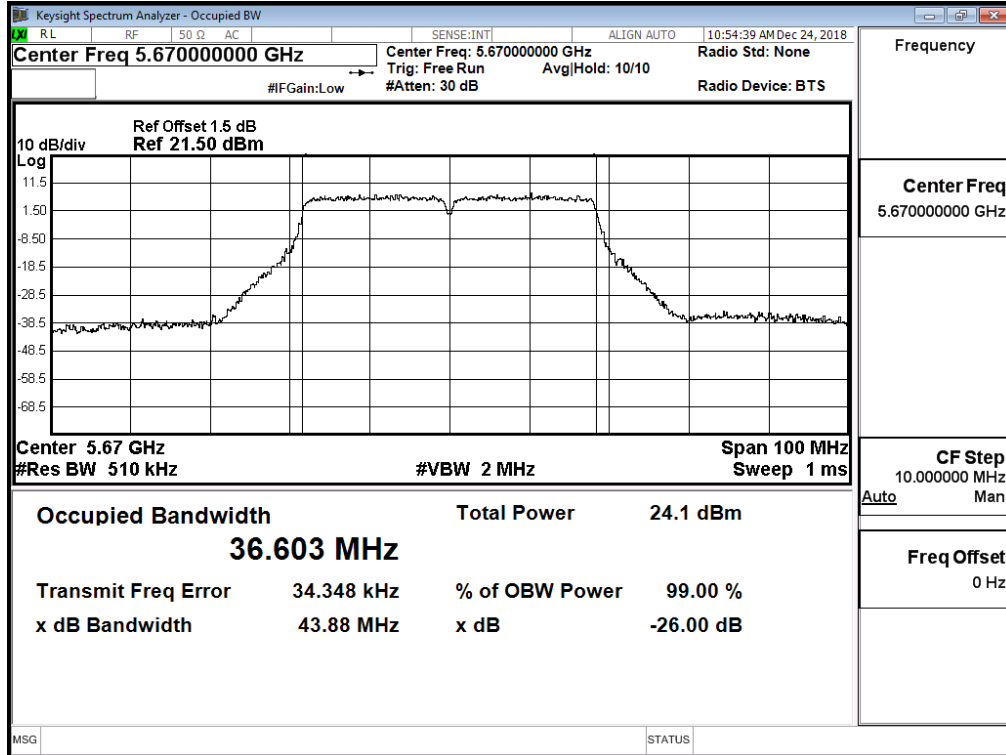

Product : Intel® Wireless-AC 9560  
 Test Item : Maximum conducted output power  
 Test Date : 2019/01/07  
 Test Mode : Mode 1 SISO A: Transmit (802.11ac-20BW\_7.2Mbps)

Cable loss=1.5dB		Average Power										
Channel No.	Frequency (MHz)	Data Rate (Mbps)										Required Limit
		VTH0	VTH1	VTH2	VTH3	VTH4	VTH5	VTH6	VTH7	VTH8		
		Measurement Level (dBm)										
144(U-NII-2C)	5720	18.36	18.28	18.23	18.13	18.03	17.93	17.83	17.78	17.72	<24dBm	
144(U-NII-3)	5720	12.83	12.78	12.72	12.66	12.58	12.52	12.44	12.35	12.27	<30dBm	

Note: Maximum conducted output power Value =Reading value on Spectrum Analyzer + cable loss

**Maximum conducted output power Measurement:**

Channel No	Frequency Range (MHz)	99% Bandwidth (MHz)	Output Power (dBm)	Output Power Limit		Result
				(dBm)	dBm+10log(BW)	
144(U-NII-2C)	5720	14.067	18.36	24	22.48	Pass
144(U-NII-3)	5720	--	12.83	30	--	Pass

**99% Occupied Bandwidth:  
Channel 144**

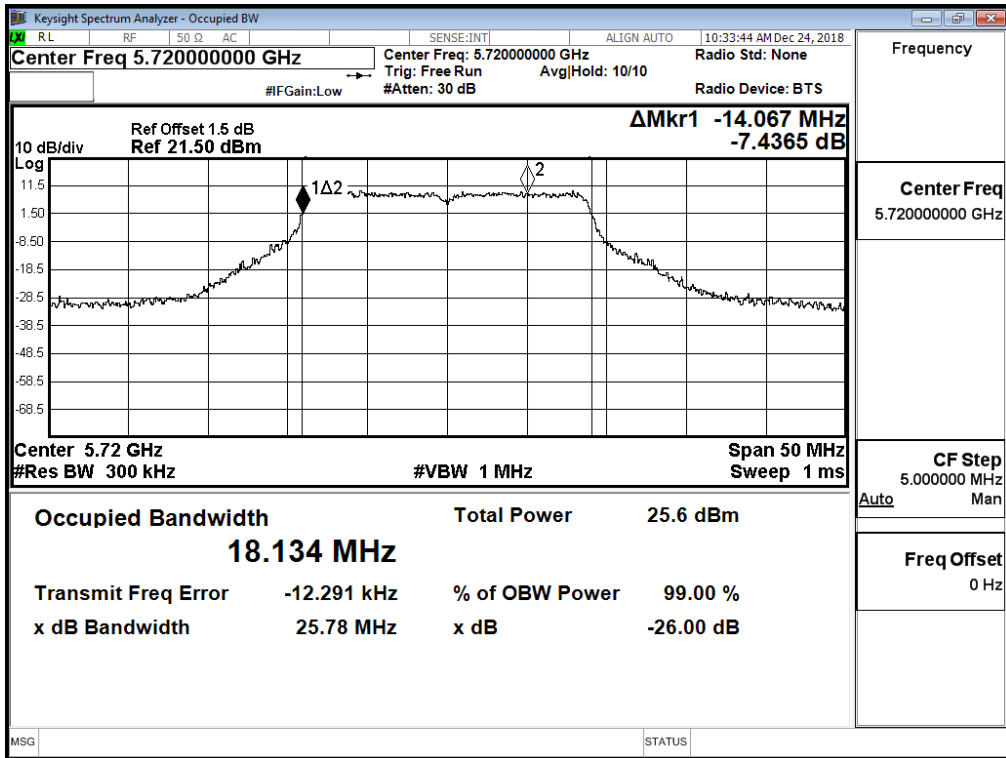

**Maximum conducted output power:**

**Channel 144 (U-NII-2C)**

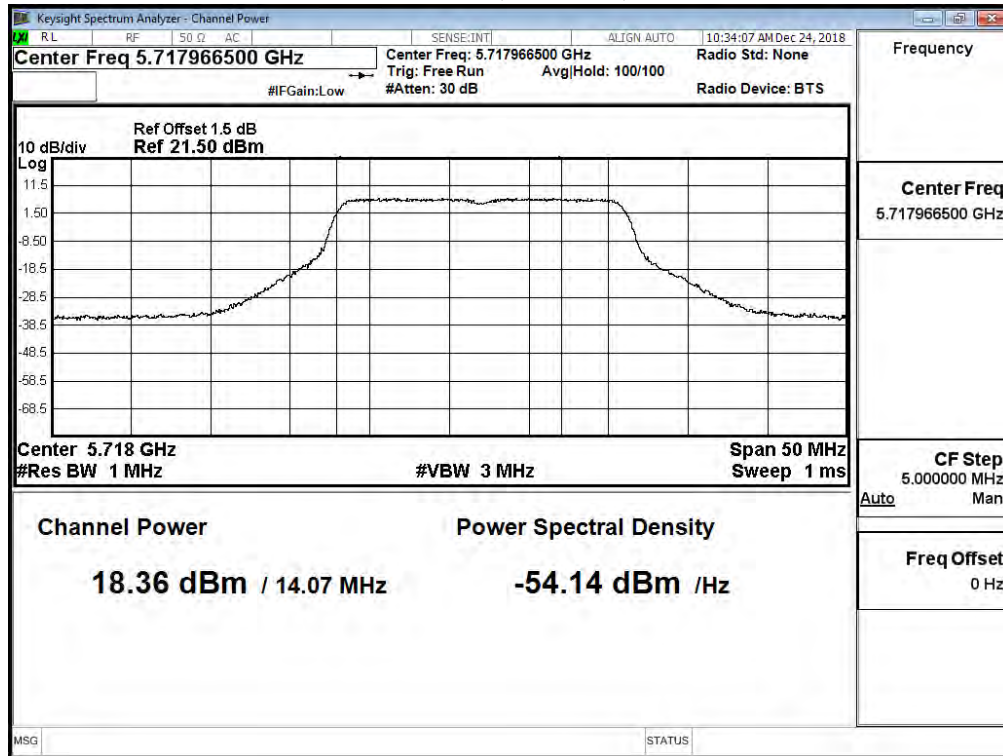

**Channel 144 (U-NII-3)**

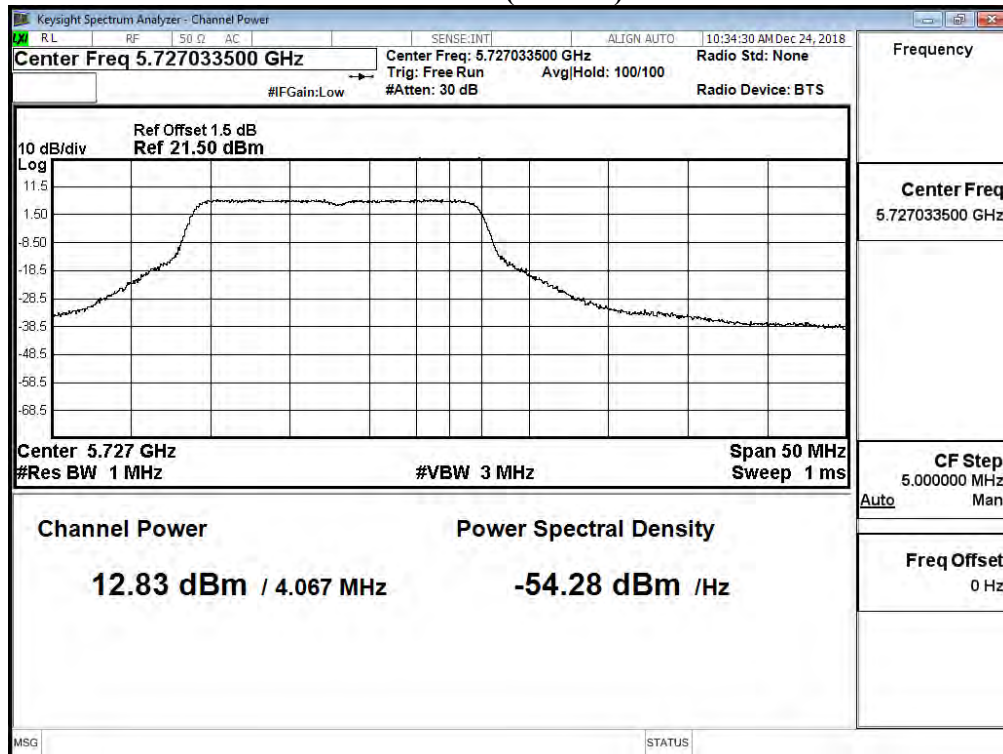



Product : Intel® Wireless-AC 9560  
 Test Item : Maximum conducted output power  
 Test Date : 2019/01/07  
 Test Mode : Mode 1 SISO A: Transmit (802.11ac-40BW\_15Mbps)

Cable loss=1.5dB		Average Power										Required Limit
Channel No.	Frequency (MHz)	Data Rate (Mbps)										
		VTH0	VTH1	VTH2	VTH3	VTH4	VTH5	VTH6	VTH7	VTH8	VTH9	
		Measurement Level (dBm)										
142 (U-NII-2C)	5710	18.42	18.35	18.27	18.22	18.16	18.07	17.97	17.9	17.82	17.75	<24dBm
142 (U-NII-3)	5710	8.17	8.08	8.01	7.91	7.85	7.78	7.68	7.63	7.56	7.49	<30dBm

Note: Maximum conducted output power Value =Reading value on Spectrum Analyzer + cable loss

**Maximum conducted output power Measurement:**

Channel No	Frequency Range (MHz)	99% Bandwidth (MHz)	Output Power (dBm)	Output Power Limit		Result
				(dBm)	dBm+10log(BW)	
142(U-NII-2C)	5710	33.299	18.42	24	26.22	Pass
142(U-NII-3)	5710	--	8.17	30	--	Pass

**99% Occupied Bandwidth:  
Channel 142**

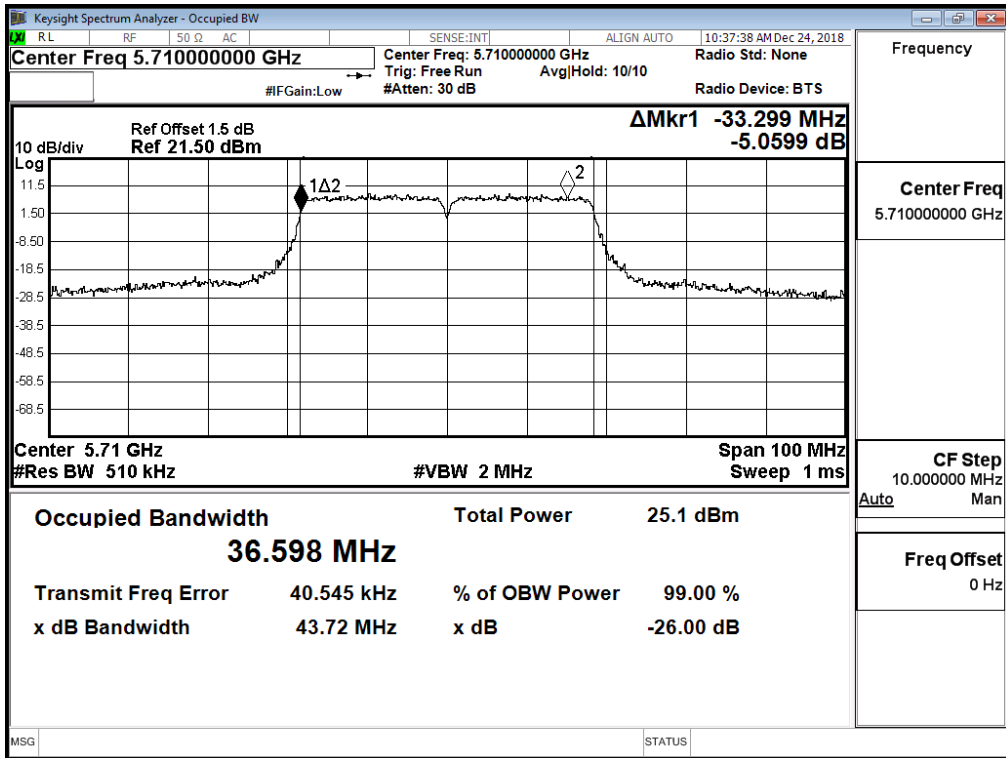



Product : Intel® Wireless-AC 9560  
 Test Item : Maximum conducted output power  
 Test Date : 2019/01/07  
 Test Mode : Mode 1 SISO A: Transmit (802.11ac-80BW\_32.5Mbps)

Cable loss=1.5dB		Average Power										
Channel No	Frequency (MHz)	Data Rate (Mbps)										Required Limit
		VTH0	VTH1	VTH2	VTH3	VTH4	VTH5	VTH6	VTH7	VTH8	VTH9	
42	5210	17.42	17.34	17.29	17.21	17.12	17.05	16.95	16.85	16.8	16.72	<24dBm
58	5290	14.84	14.78	14.73	14.68	14.63	14.53	14.44	14.34	14.25	14.17	<24dBm
106	5530	16.83	--	--	--	--	--	--	--	--	--	<24dBm
122	5610	19.95	19.9	19.85	19.75	19.7	19.61	19.52	19.47	19.41	19.31	<24dBm
138(U-NII-2C)	5690	19.76	--	--	--	--	--	--	--	--	--	<24dBm
138(U-NII-3)	5690	2.47	--	--	--	--	--	--	--	--	--	<30dBm
155	5775	18.39	18.29	18.23	18.15	18.09	18.01	17.91	17.81	17.76	17.68	<30dBm

Note: Maximum conducted output power Value =Reading value on Spectrum Analyzer + cable loss

#### Maximum conducted output power Measurement:

Channel No	Frequency Range (MHz)	99% Bandwidth (MHz)	Output Power (dBm)	Output Power Limit		Result
				(dBm)	dBm+10log(BW)	
42	5210	--	17.42	24	--	Pass
58	5290	75.156	14.84	24	29.76	Pass
106	5530	75.144	16.83	24	29.76	Pass
122	5610	75.430	19.95	24	29.78	Pass
138(U-NII-2C)	5690	72.742	19.76	24	29.62	Pass
138(U-NII-3)	5690	--	2.47	30	--	Pass
155	5775	--	18.39	30	--	Pass

**99% Occupied Bandwidth:  
Channel 58**

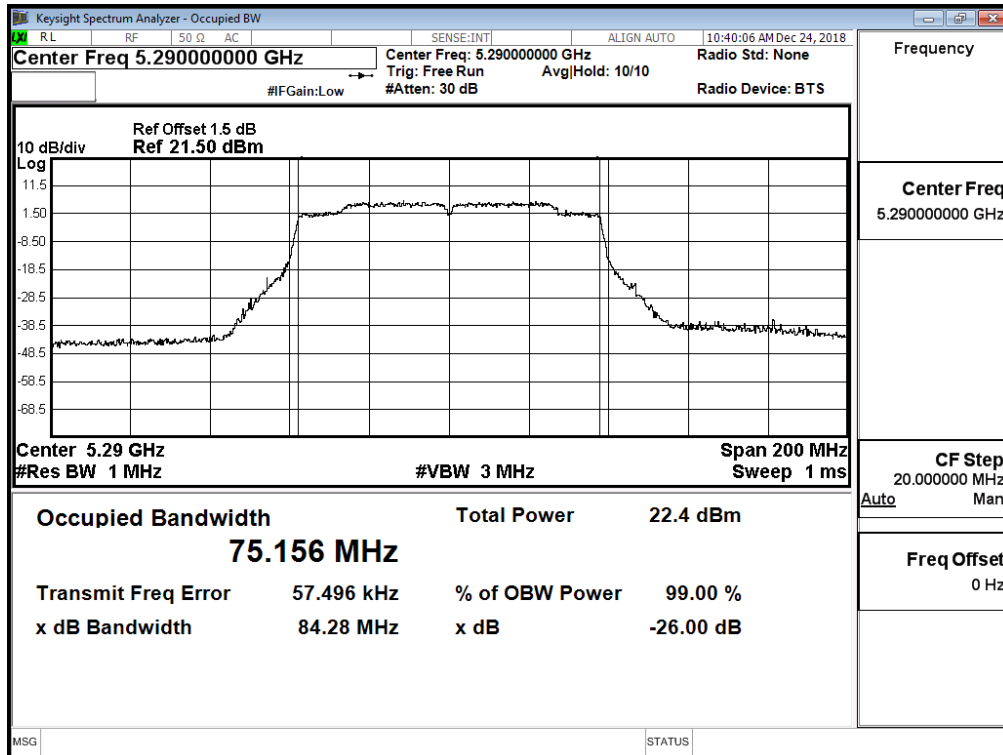

**Channel 106**

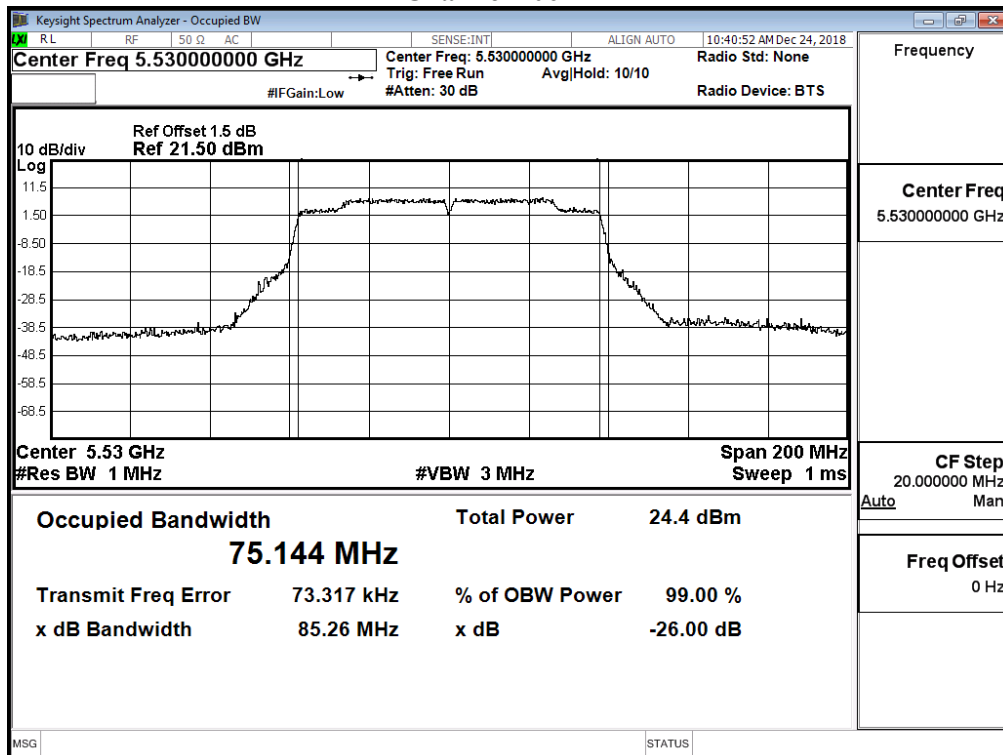

### Channel 122

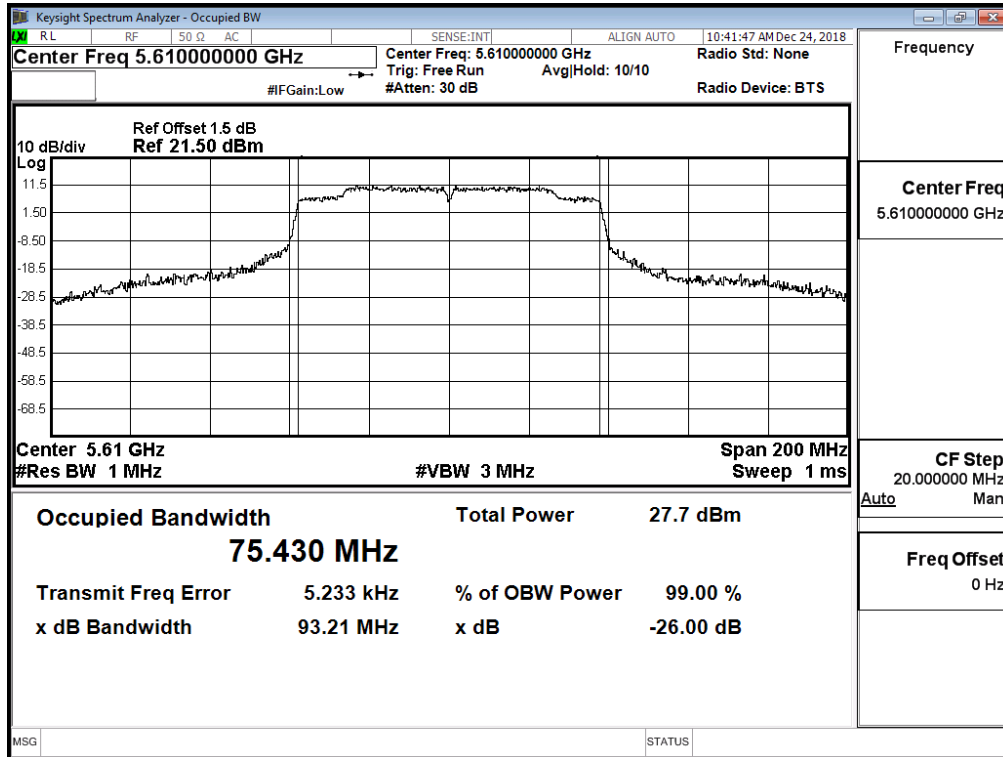

### Channel 138

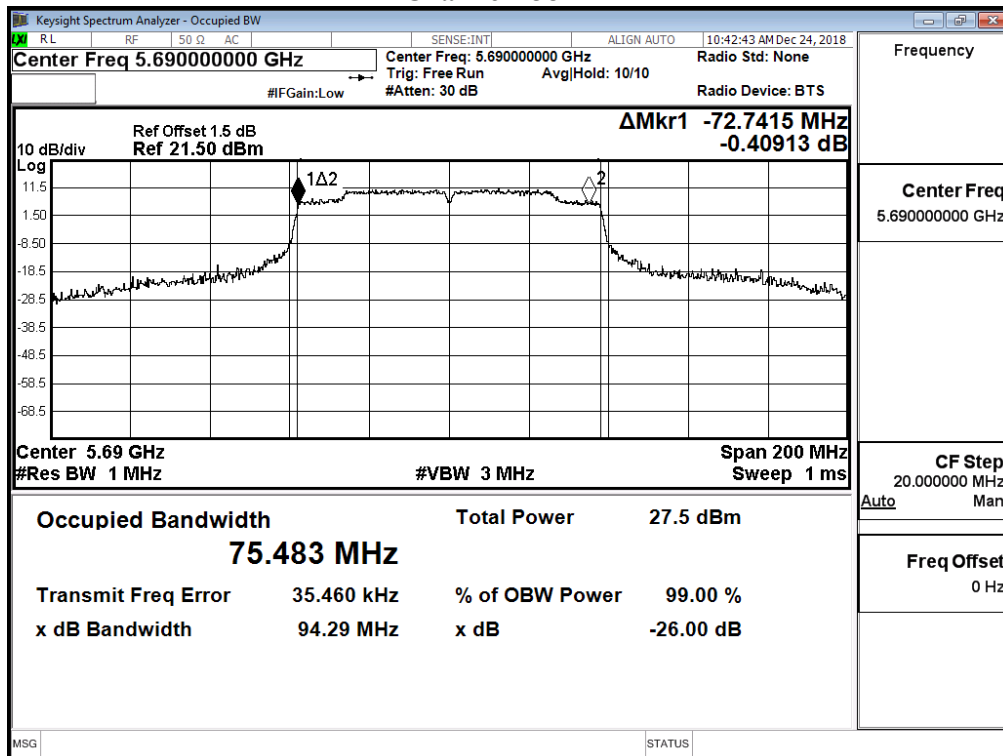

**Maximum conducted output power:  
Channel 138 (U-NII-2C)**

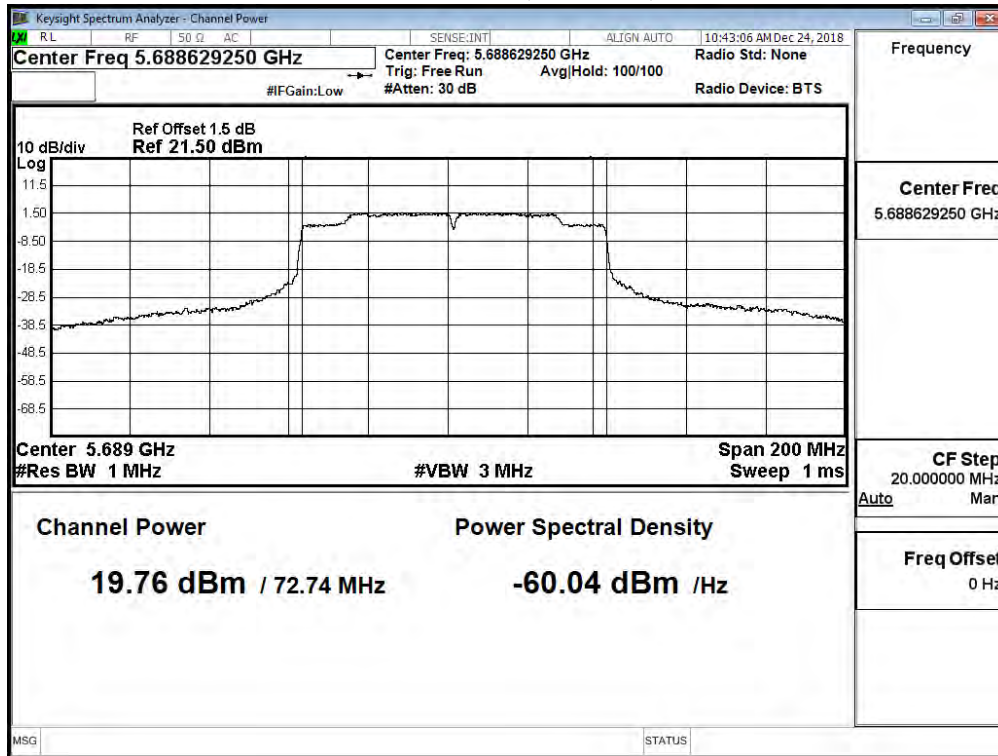

**Maximum conducted output power:  
Channel 138 (U-NII-3)**

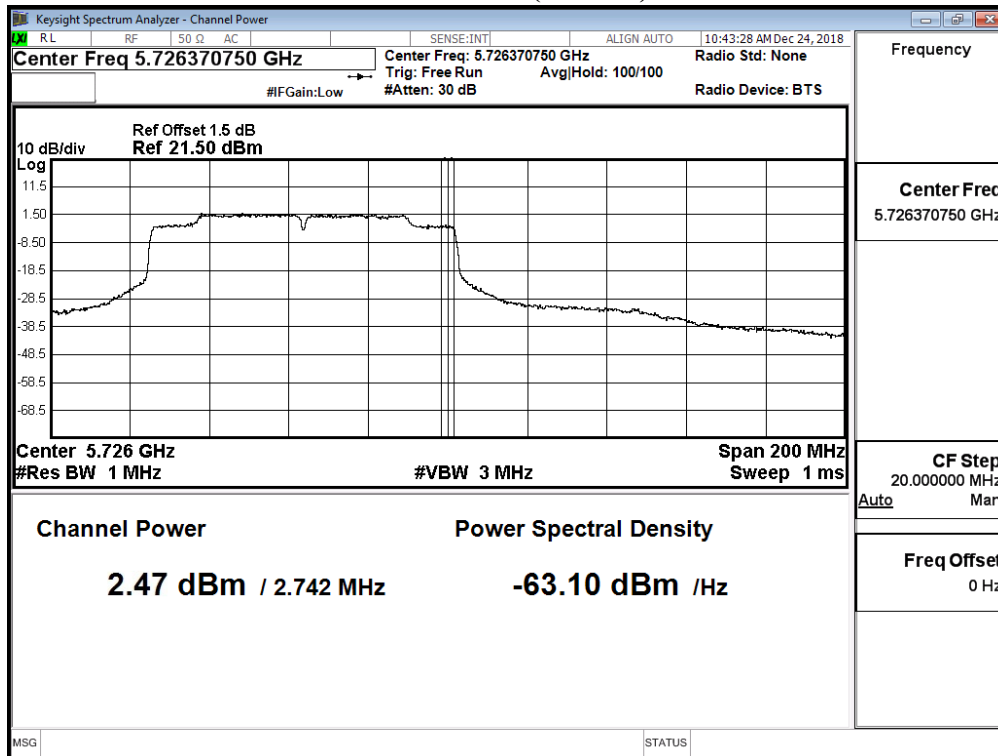

Product : Intel® Wireless-AC 9560  
 Test Item : Maximum conducted output power  
 Test Date : 2019/01/07  
 Test Mode : Mode 1 SISO A: Transmit (802.11ac-160BW\_65Mbps)

Cable loss=1.5dB		Average Power										
Channel No	Frequency (MHz)	Data Rate (Mbps)										Required Limit
		VTH0	VTH1	VTH2	VTH3	VTH4	VTH5	VTH6	VTH7	VTH8	VTH9	
50(U-NII-1)	5250	9.65	9.56	9.47	9.4	9.3	9.22	9.15	9.06	8.98	8.9	<24dBm
50(U-NII-2A)	5250	9.94	9.87	9.82	9.77	9.67	9.6	9.55	9.47	9.39	9.33	<24dBm
114	5570	14.44	14.34	14.25	14.18	14.1	14.05	13.97	13.9	13.82	13.72	<24dBm

Note: Maximum conducted output power Value =Reading value on Spectrum Analyzer + cable loss

**Maximum conducted output power Measurement:**

Channel No	Frequency Range (MHz)	99% Bandwidth (MHz)	Output Power (dBm)	Output Power Limit		Result
				(dBm)	dBm+10log(BW)	
50(U-NII-1)	5250	--	9.65	24	--	Pass
50(U-NII-2A)	5250	76.605	9.94	24	29.84	Pass
114	5570	152.940	14.44	24	32.85	Pass



**99% Occupied Bandwidth:  
Channel 50**

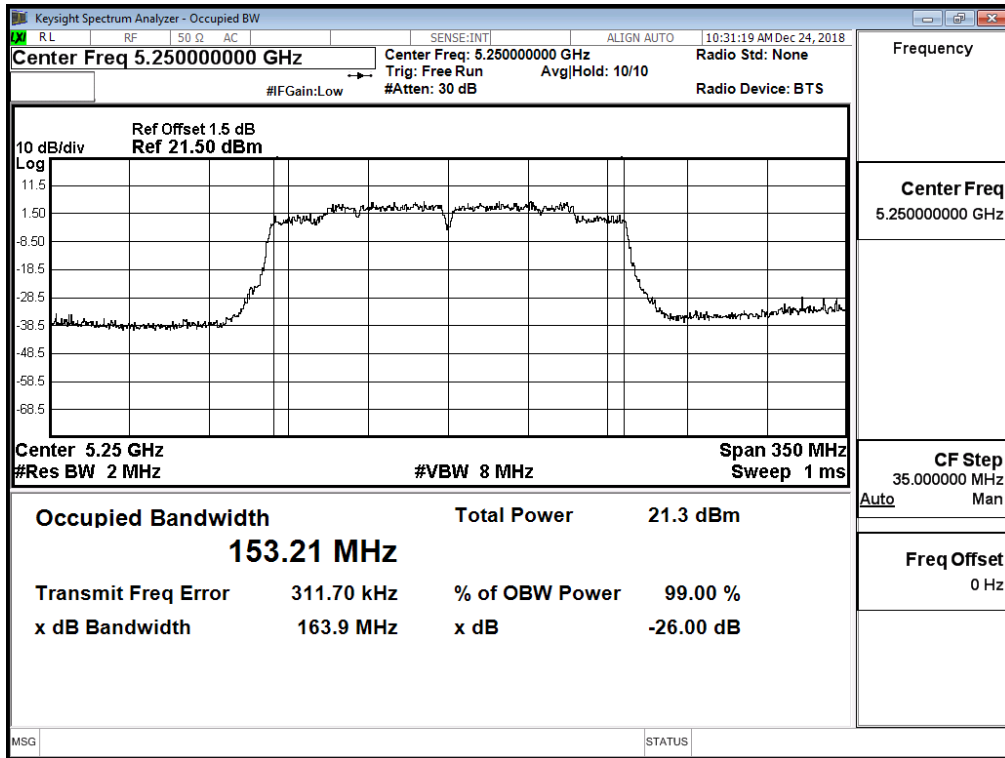

**Channel 114**

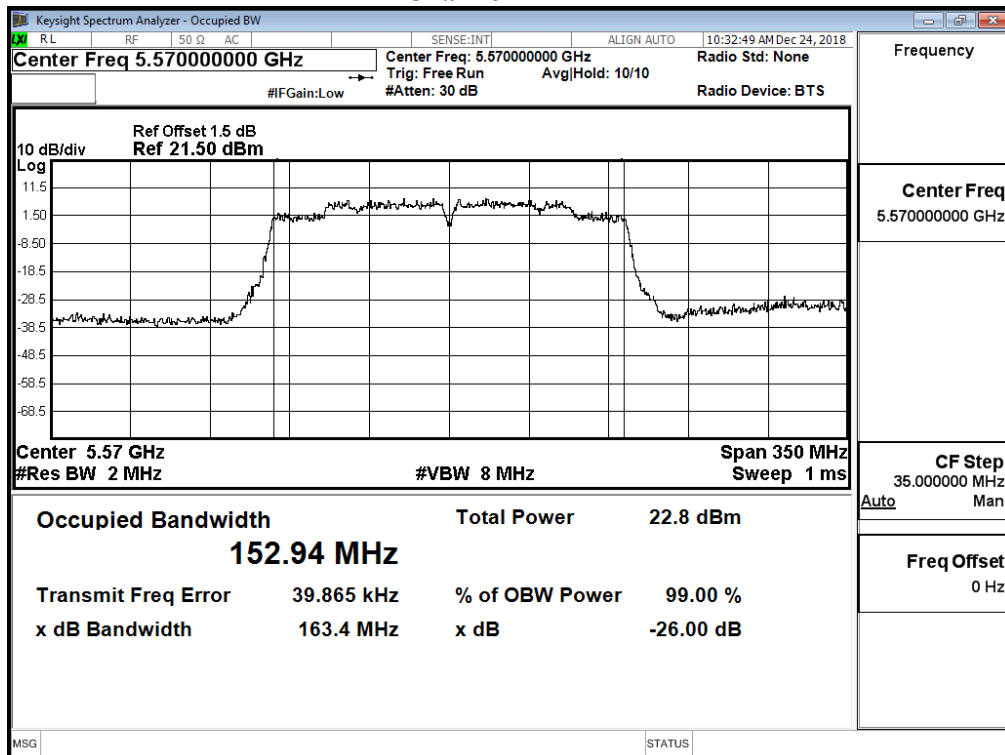

**Maximum conducted output power:**

**Channel 50 (U-NII-1)**

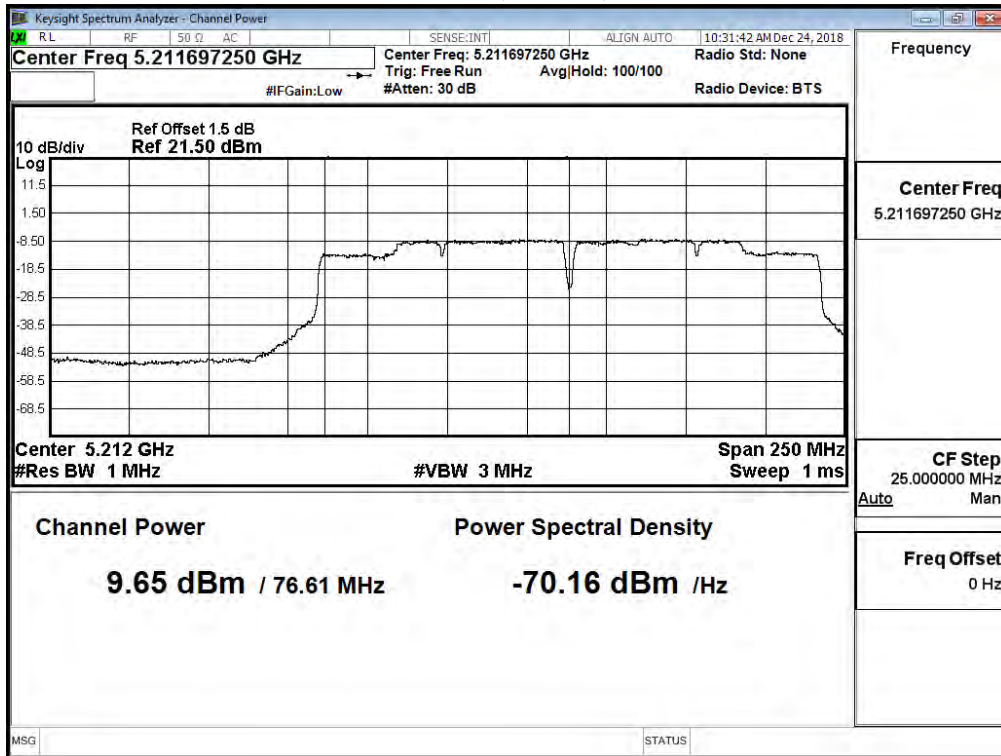

**Maximum conducted output power:**

**Channel 50 (U-NII-2A)**

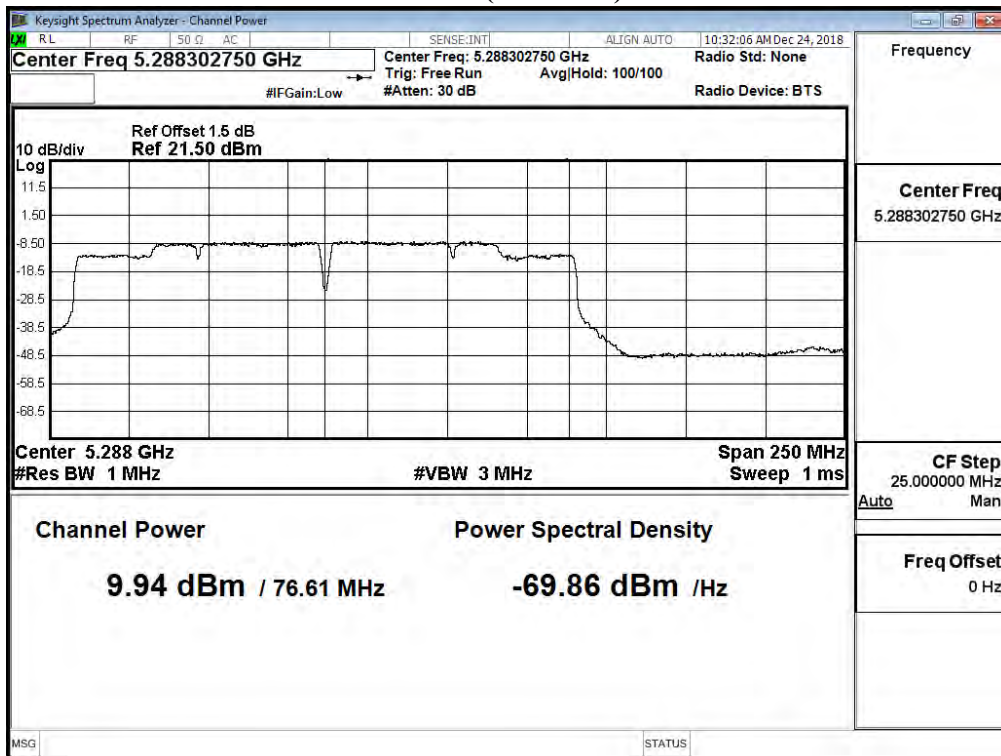

Product : Intel® Wireless-AC 9560  
 Test Item : Maximum conducted output power  
 Test Date : 2019/01/07  
 Test Mode : Mode 2 SISO B: Transmit (802.11a\_6Mbps)

Cable loss=1.5dB		Average Power								
Channel No.	Frequency (MHz)	Data Rate (Mbps)								Required Limit
		6	9	12	18	24	36	48	54	
		Measurement Level (dBm)								
36	5180	18.33	--	--	--	--	--	--	--	<24dBm
40	5200	19.9	19.85	19.79	19.73	19.67	19.57	19.51	19.45	<24dBm
48	5240	19.92	--	--	--	--	--	--	--	<24dBm
52	5260	19.91	--	--	--	--	--	--	--	<24dBm
56	5280	19.84	19.77	19.71	19.65	19.55	19.45	19.37	19.29	<24dBm
64	5320	15.95	--	--	--	--	--	--	--	<24dBm
100	5500	18.49	--	--	--	--	--	--	--	<24dBm
120	5600	19.96	19.88	19.82	19.72	19.65	19.55	19.47	19.42	<24dBm
140	5700	17.72	--	--	--	--	--	--	--	<24dBm
149	5745	19.91	--	--	--	--	--	--	--	<30dBm
157	5785	19.84	19.75	19.65	19.57	19.51	19.45	19.38	19.28	<30dBm
165	5825	19.83	--	--	--	--	--	--	--	<30dBm

Note: Maximum conducted output power Value =Reading value on average power meter + cable loss

**Maximum conducted output power Measurement:**

Channel No	Frequency Range (MHz)	99% Bandwidth (MHz)	Output Power (dBm)	Output Power Limit		Result
				(dBm)	dBm+10log(BW)	
36	5180	--	18.33	24	--	Pass
40	5200	--	19.9	24	--	Pass
48	5240	--	19.92	24	--	Pass
52	5260	17.021	19.91	24	23.31	Pass
56	5280	17.021	19.84	24	23.31	Pass
64	5320	16.981	15.95	24	23.30	Pass
100	5500	17.006	18.49	24	23.31	Pass
120	5600	17.002	19.96	24	23.31	Pass
140	5700	16.992	17.72	24	23.30	Pass
149	5745	--	19.91	30	--	Pass
157	5785	--	19.84	30	--	Pass
165	5825	--	19.83	30	--	Pass

### 99% Occupied Bandwidth: Channel 52:

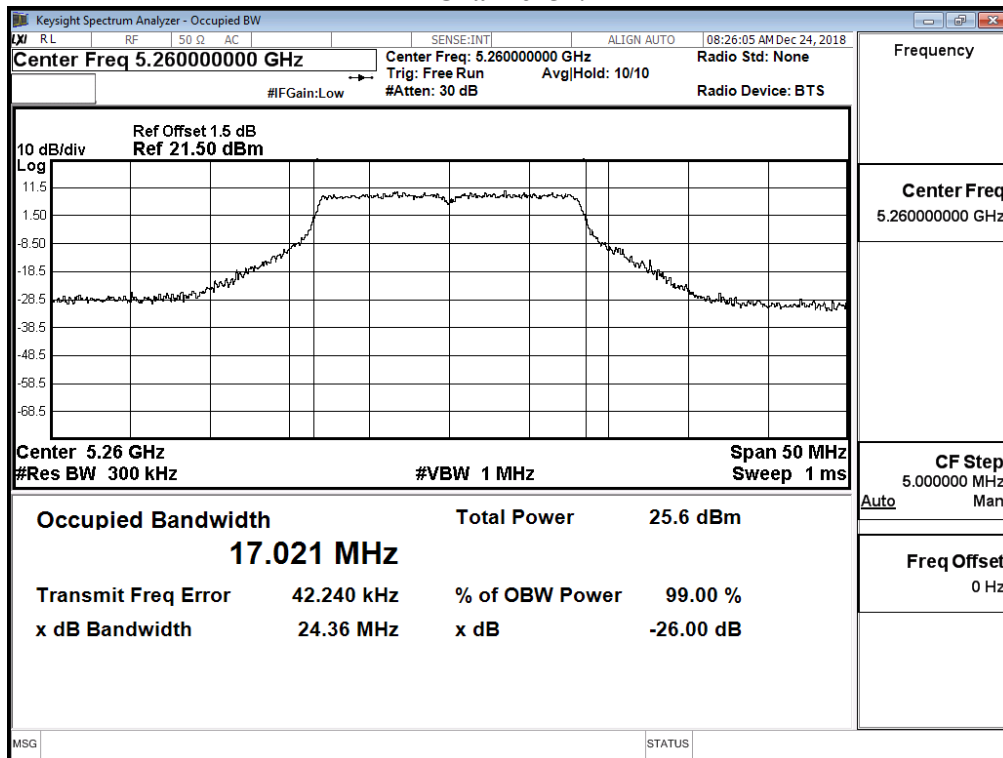

### Channel 56:

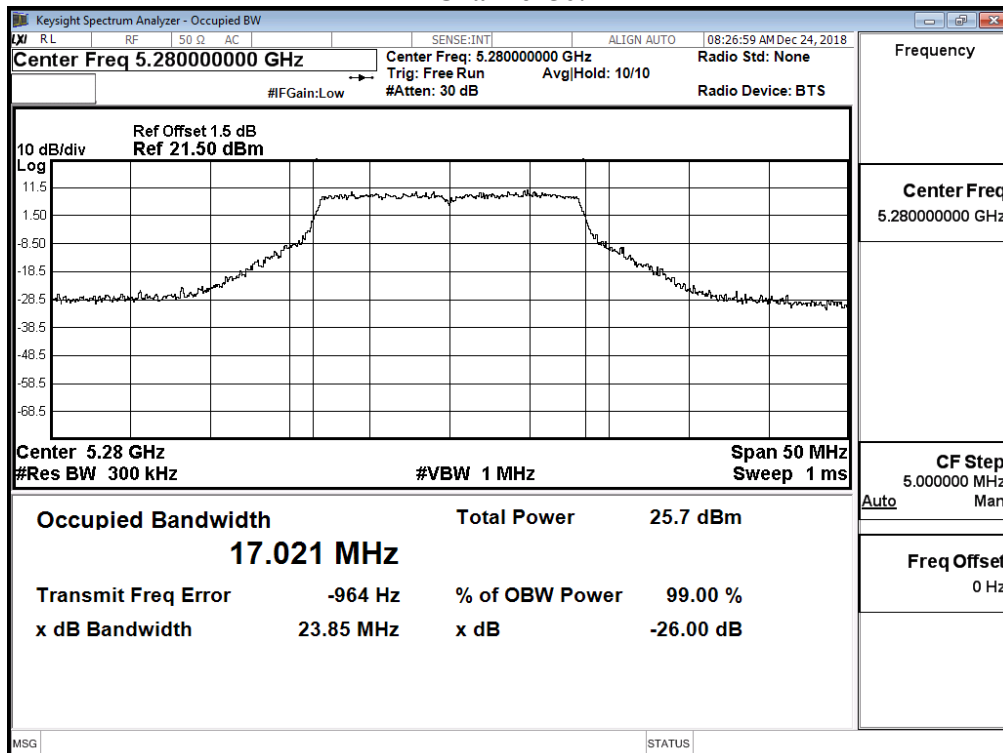

### Channel 64:

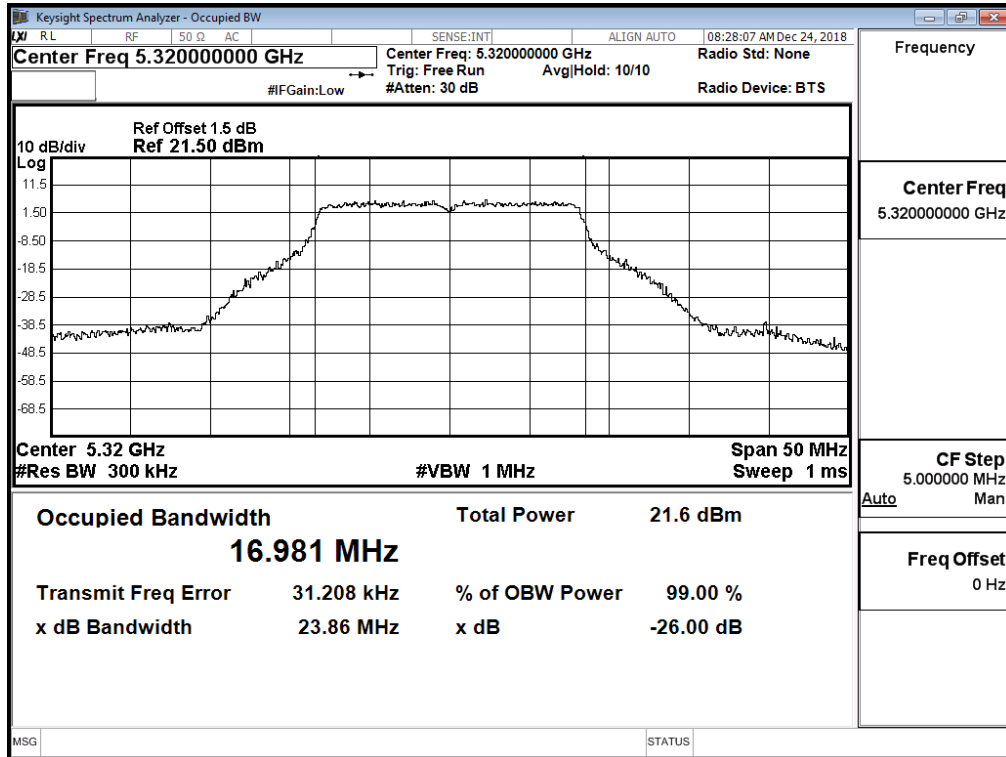

### Channel 100:

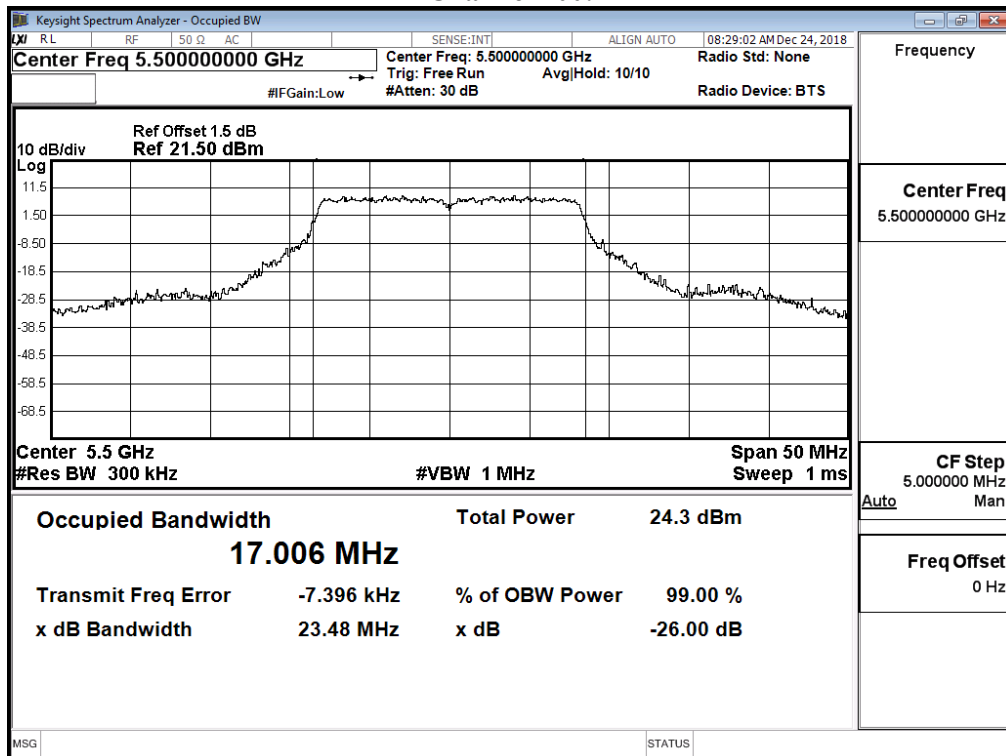

### Channel 120:

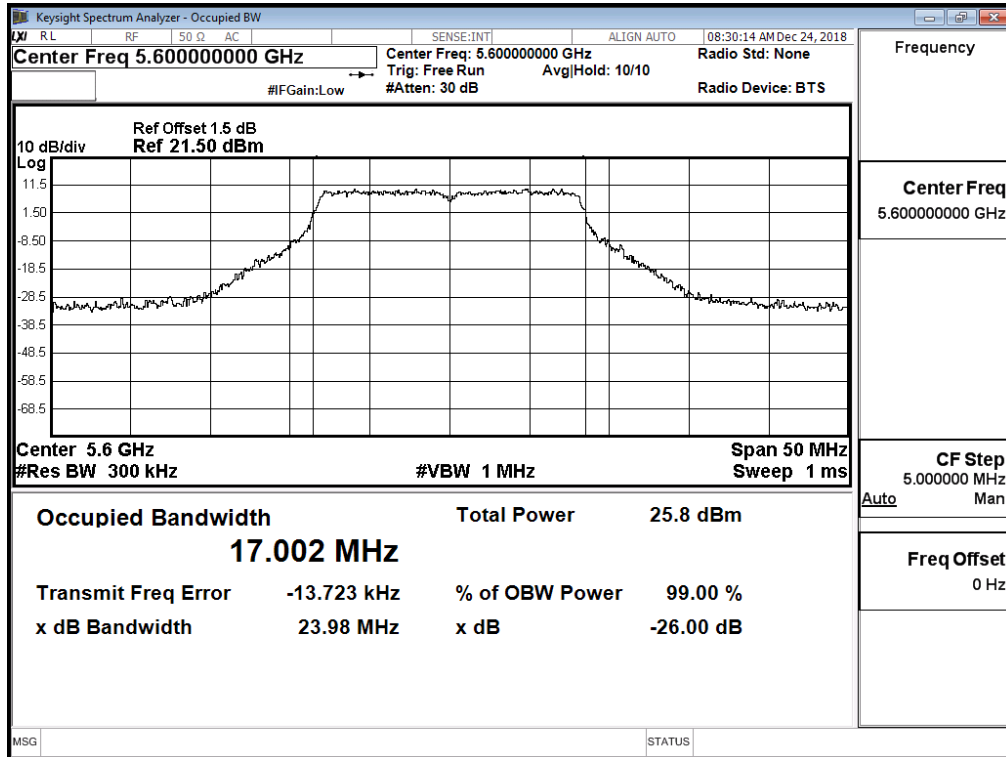

### Channel 140:

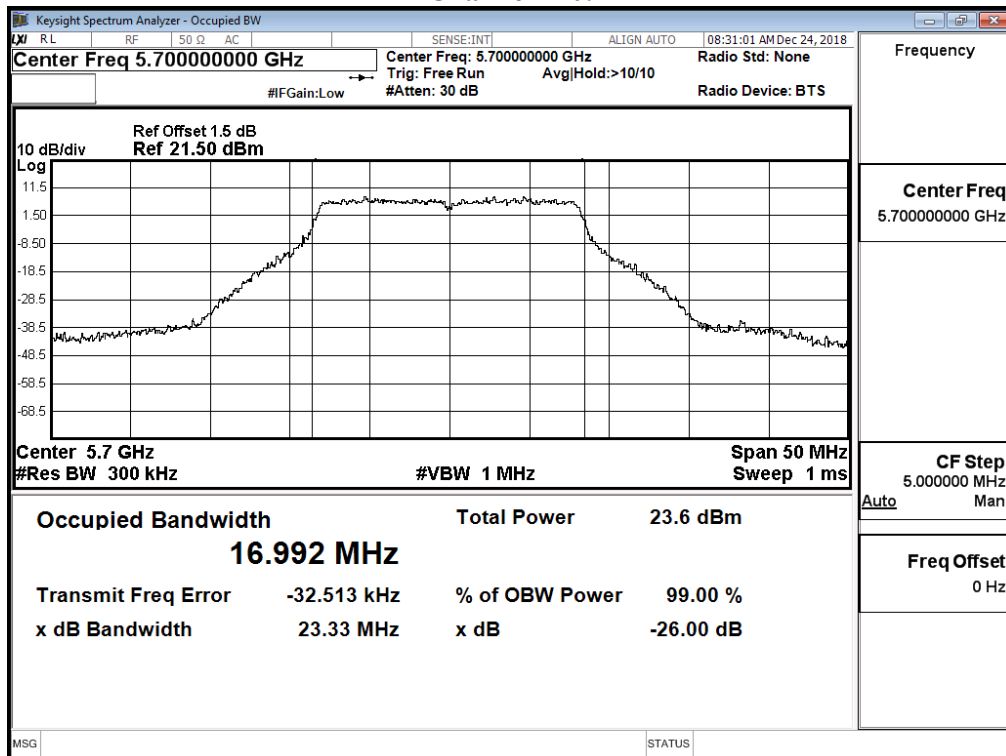

Product : Intel® Wireless-AC 9560  
 Test Item : Maximum conducted output power  
 Test Date : 2019/01/07  
 Test Mode : Mode 2 SISO B: Transmit (802.11n-20BW\_7.2Mbps)

Cable loss=1.5dB		Average Power								
Channel No.	Frequency (MHz)	Data Rate (Mbps)								Required Limit
		7.2	14.4	21.7	28.9	43.3	57.8	65	72.2	
		Measurement Level (dBm)								
36	5180	18.29	--	--	--	--	--	--	--	<24dBm
40	5200	19.81	19.73	19.63	19.53	19.48	19.41	19.32	19.22	<24dBm
48	5240	19.88	--	--	--	--	--	--	--	<24dBm
52	5260	19.85	--	--	--	--	--	--	--	<24dBm
56	5280	19.81	19.73	19.63	19.57	19.51	19.43	19.37	19.31	<24dBm
64	5320	15.93	--	--	--	--	--	--	--	<24dBm
100	5500	16.65	--	--	--	--	--	--	--	<24dBm
120	5600	19.69	19.62	19.52	19.46	19.39	19.30	19.25	19.15	<24dBm
140	5700	17.65	--	--	--	--	--	--	--	<24dBm
149	5745	19.8	--	--	--	--	--	--	--	<30dBm
157	5785	19.83	19.76	19.69	19.60	19.51	19.43	19.33	19.26	<30dBm
165	5825	19.87	--	--	--	--	--	--	--	<30dBm

Note: Maximum conducted output power Value =Reading value on average power meter + cable loss



**Maximum conducted output power Measurement:**

Channel No	Frequency Range (MHz)	99% Bandwidth (MHz)	Output Power (dBm)	Output Power Limit		Result
				(dBm)	dBm+10log(BW)	
36	5180	--	18.29	24	--	Pass
40	5200	--	19.81	24	--	Pass
48	5240	--	19.88	24	--	Pass
52	5260	18.137	19.85	24	23.59	Pass
56	5280	18.146	19.81	24	23.59	Pass
64	5320	18.086	15.93	24	23.57	Pass
100	5500	18.057	16.65	24	23.57	Pass
120	5600	18.092	19.69	24	23.57	Pass
140	5700	18.084	17.65	24	23.57	Pass
149	5745	--	19.8	30	--	Pass
157	5785	--	19.83	30	--	Pass
165	5825	--	19.87	30	--	Pass

99% Occupied Bandwidth:

Channel 52:

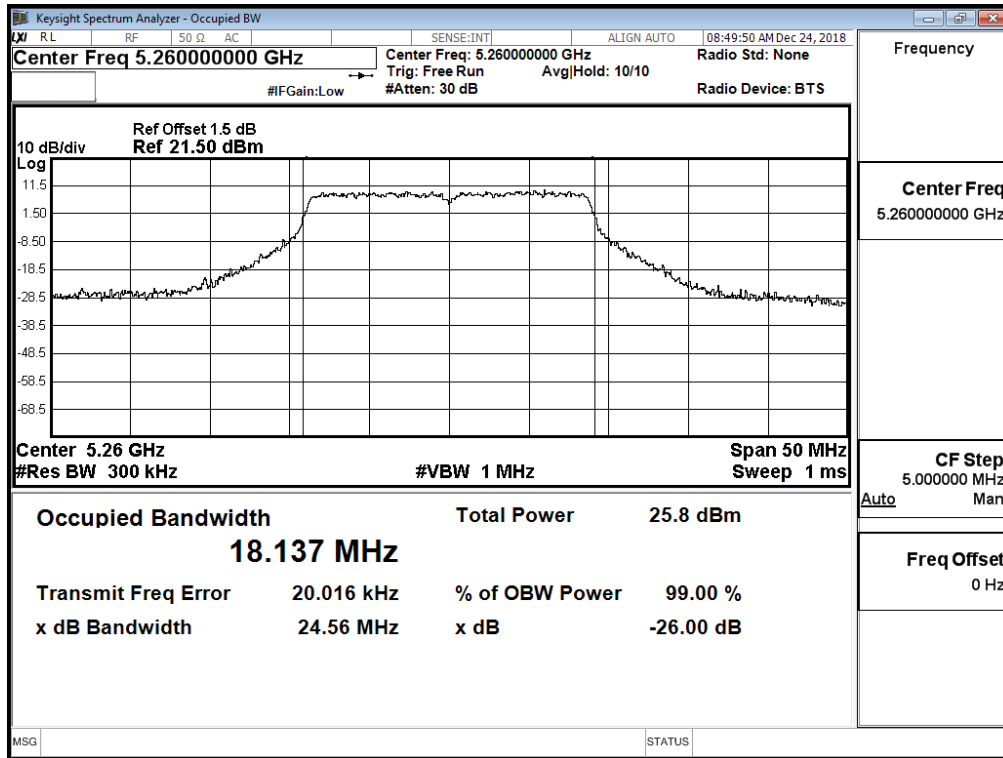

Channel 56:

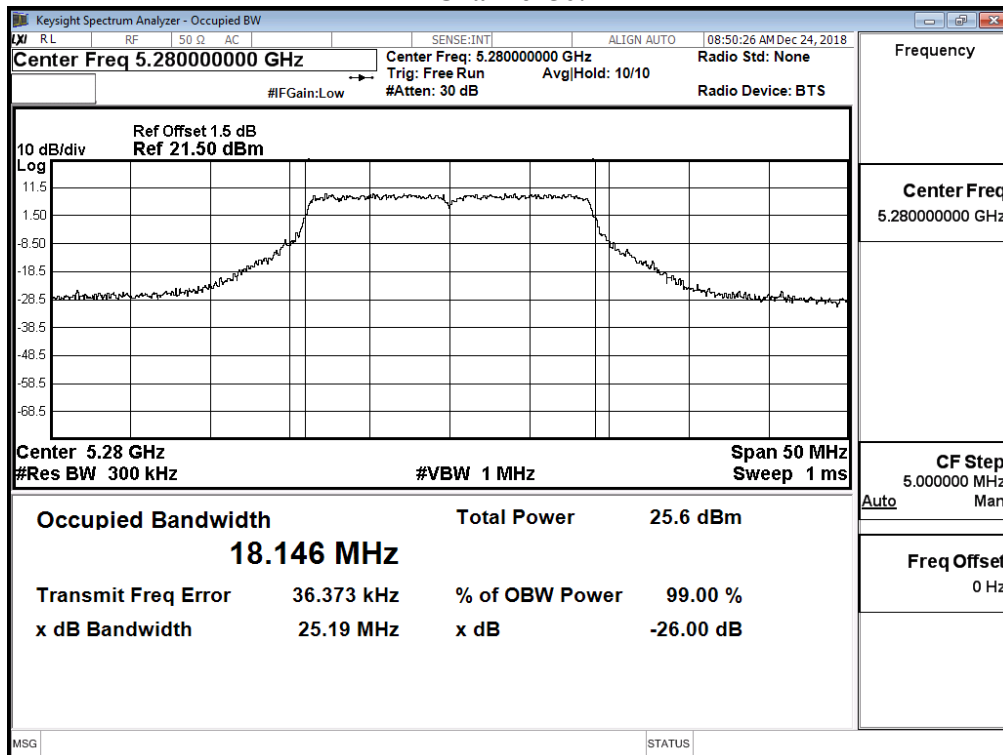

### Channel 64:

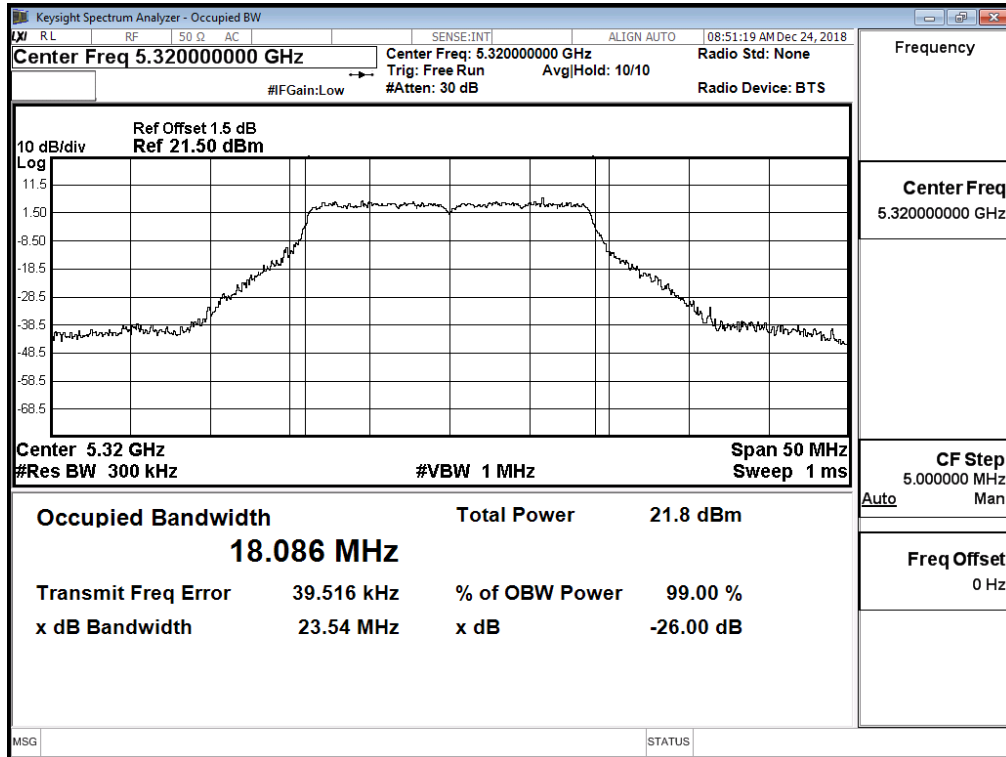

### Channel 100:

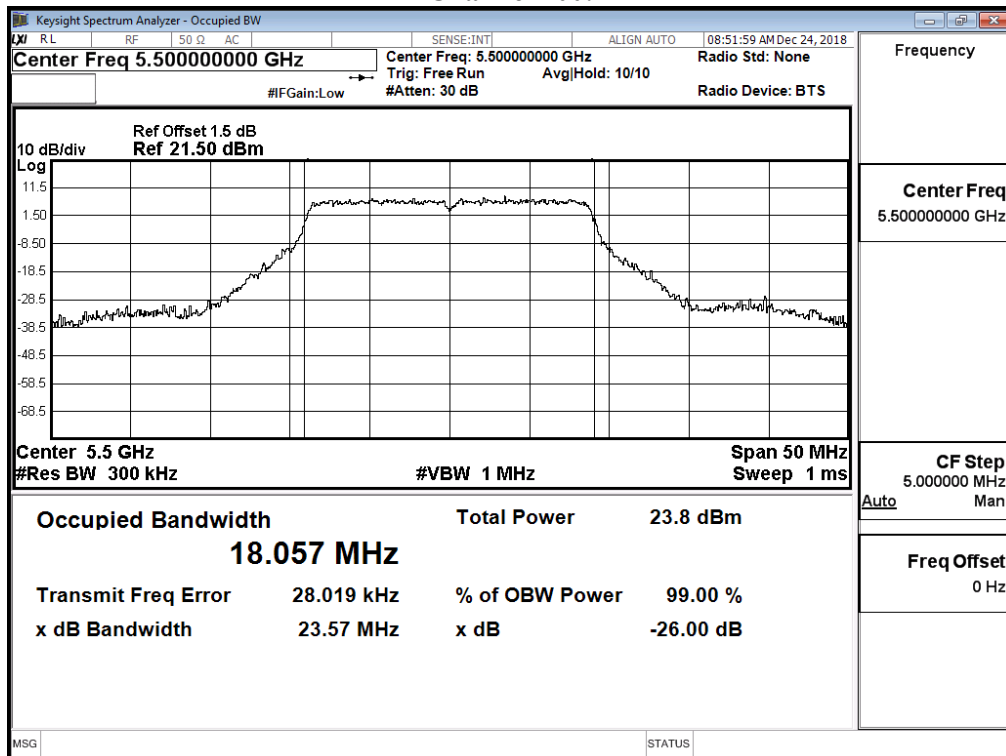

**Channel 120:**

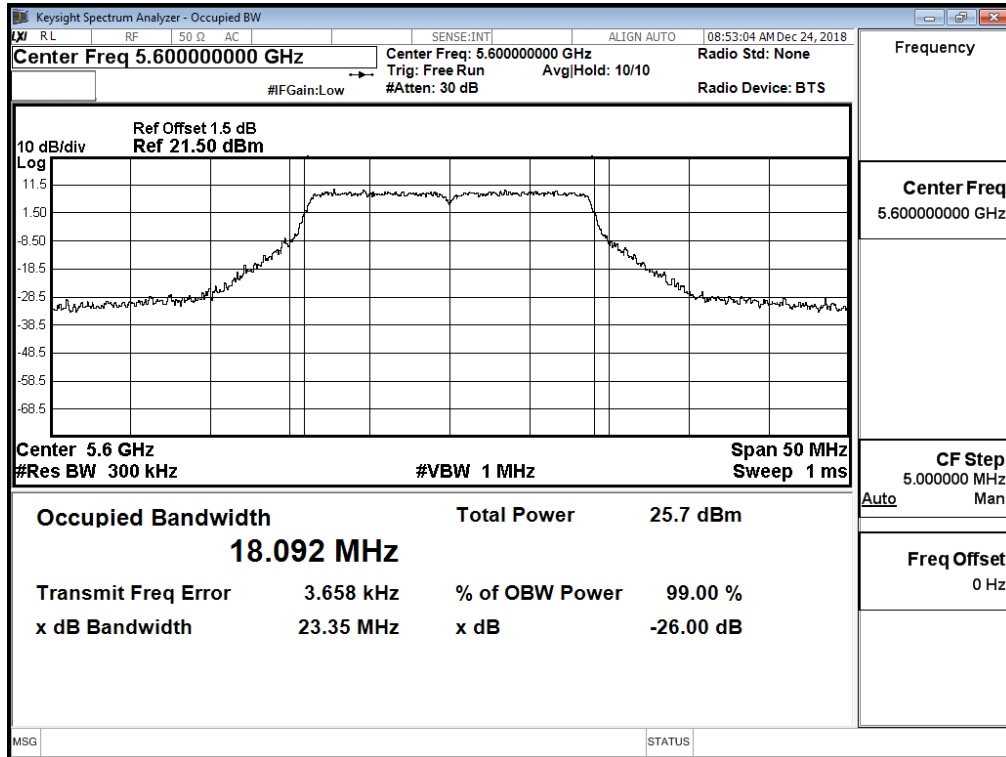

**Channel 140:**

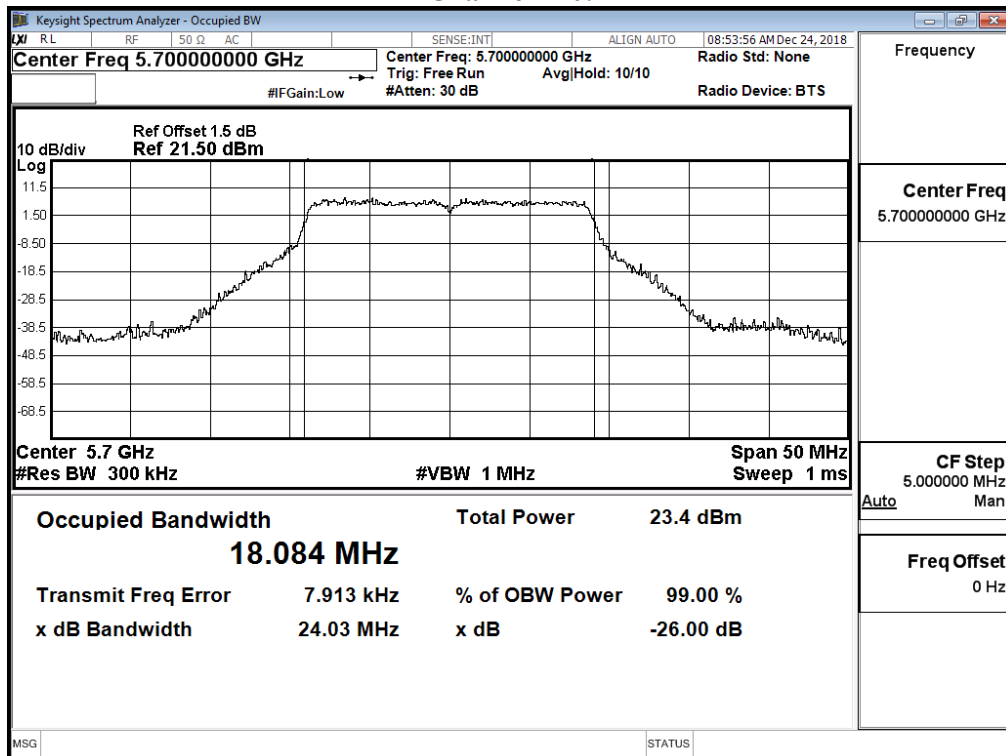

Product : Intel® Wireless-AC 9560  
 Test Item : Maximum conducted output power  
 Test Date : 2019/01/07  
 Test Mode : Mode 2 SISO B: Transmit (802.11n-40BW\_15Mbps)

Cable loss=1.5dB		Average Power								
Channel No.	Frequency (MHz)	Data Rate (Mbps)								Required Limit
		15	30	45	60	90	120	135	150	
		Measurement Level (dBm)								
38	5190	17.29	--	--	--	--	--	--	--	<24dBm
46	5230	18.37	18.27	18.21	18.16	18.07	17.97	17.92	17.84	<24dBm
54	5270	17.82	--	--	--	--	--	--	--	<24dBm
62	5310	13.82	13.74	13.64	13.54	13.49	13.44	13.35	13.25	<24dBm
102	5510	15.72	--	--	--	--	--	--	--	<24dBm
118	5590	19.61	19.51	19.46	19.41	19.35	19.25	19.18	19.11	<24dBm
134	5670	18.65	--	--	--	--	--	--	--	<24dBm
151	5755	17.74	--	--	--	--	--	--	--	<30dBm
159	5795	19.31	19.21	19.13	19.03	18.93	18.88	18.79	18.74	<30dBm

Note: Maximum conducted output power Value =Reading value on average power meter + cable loss

**Maximum conducted output power Measurement:**

Channel No	Frequency Range (MHz)	99% Bandwidth (MHz)	Output Power (dBm)	Output Power Limit		Result
				(dBm)	dBm+10log(BW)	
38	5190	--	17.29	24	--	Pass
46	5230	--	18.37	24	--	Pass
54	5270	36.533	17.82	24	26.63	Pass
62	5310	36.493	13.82	24	26.62	Pass
102	5510	36.598	15.72	24	26.63	Pass
118	5590	36.636	19.61	24	26.64	Pass
134	5670	36.558	18.65	24	26.63	Pass
151	5755	--	17.74	30	--	Pass
159	5795	--	19.31	30	--	Pass

99% Occupied Bandwidth:

Channel 54

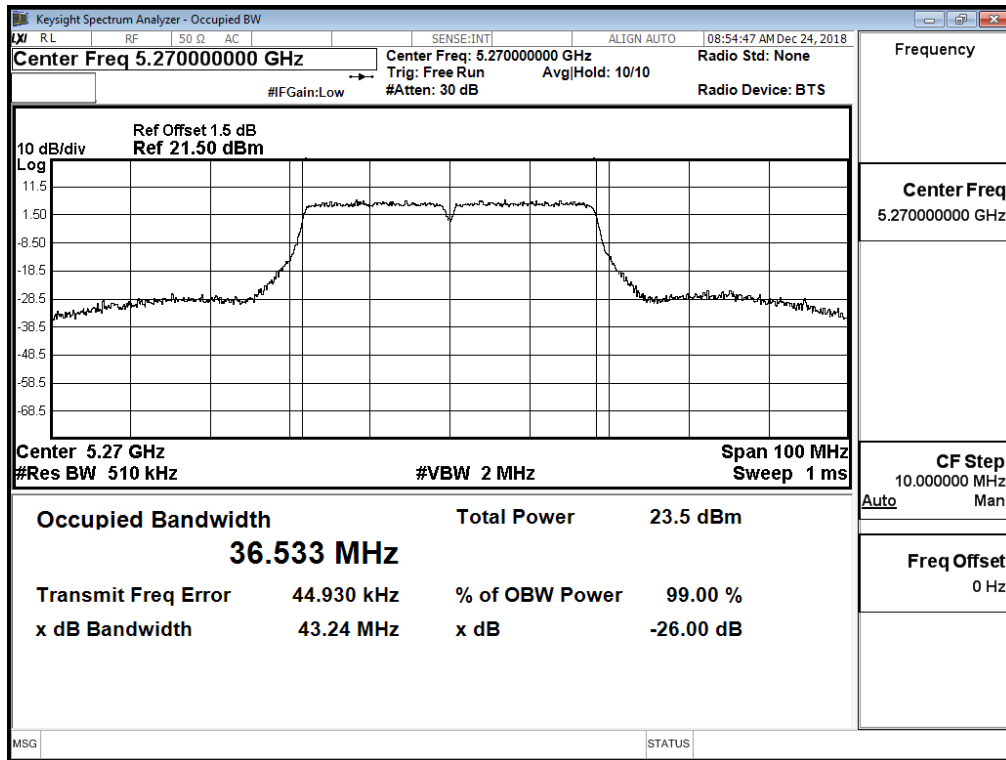

Channel 62

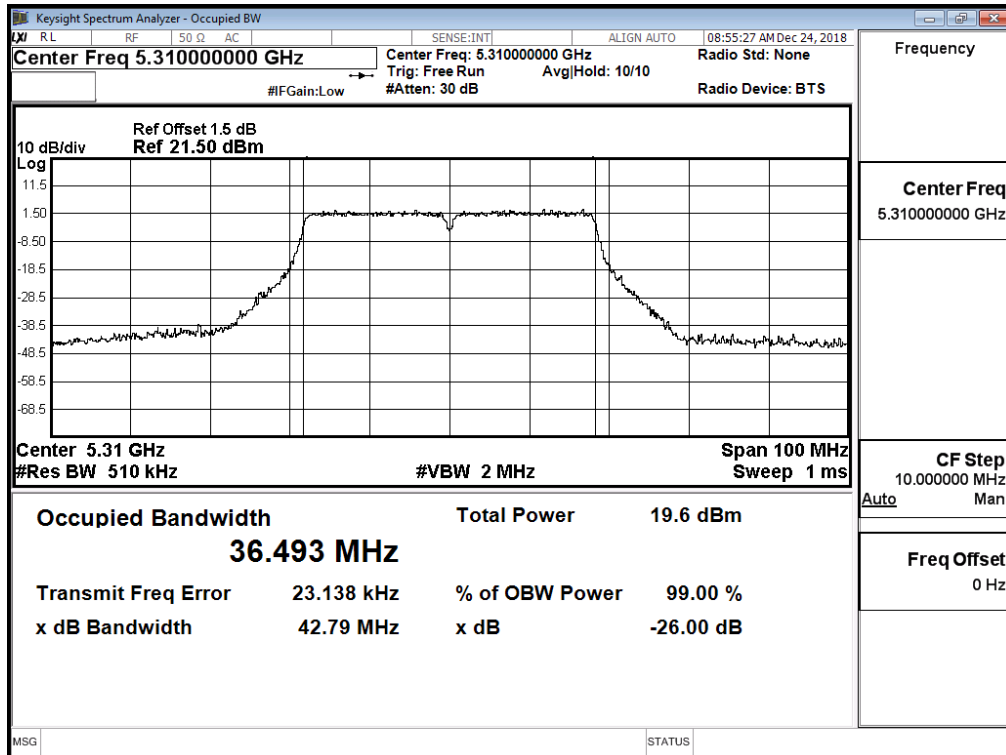

### Channel 102

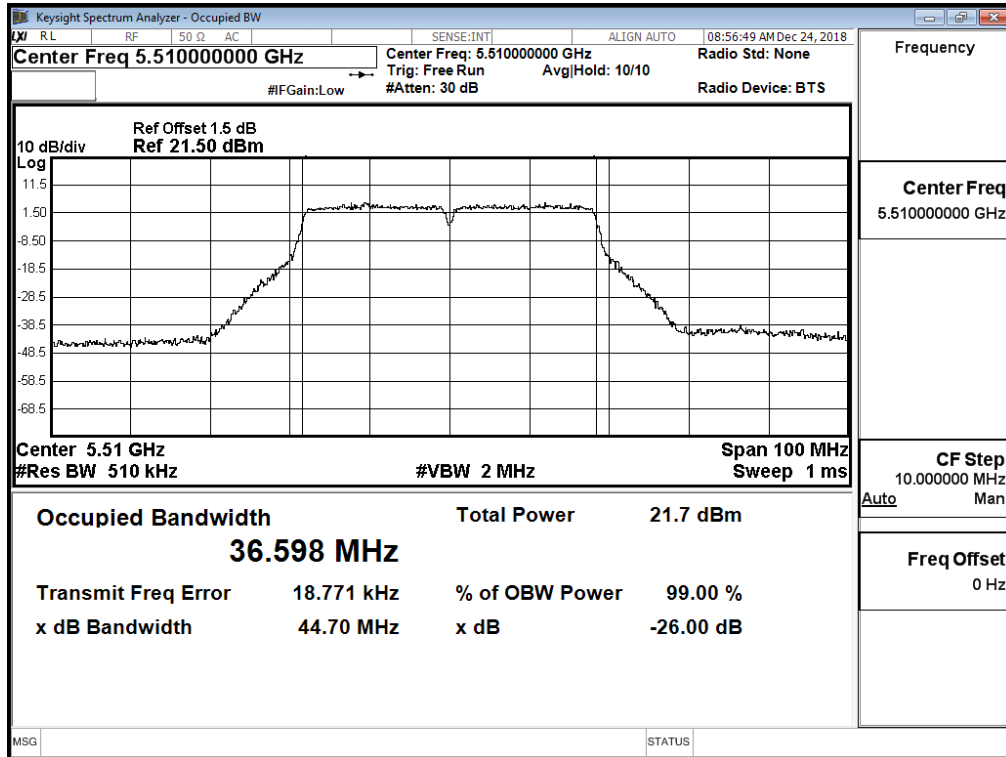

### Channel 118

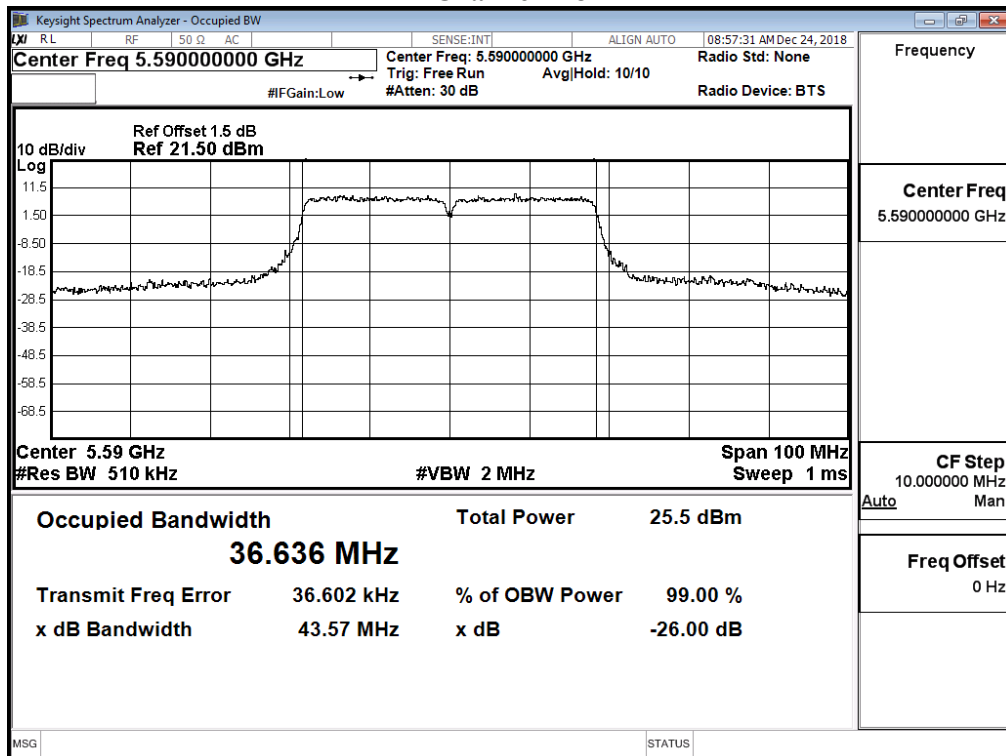



### Channel 134

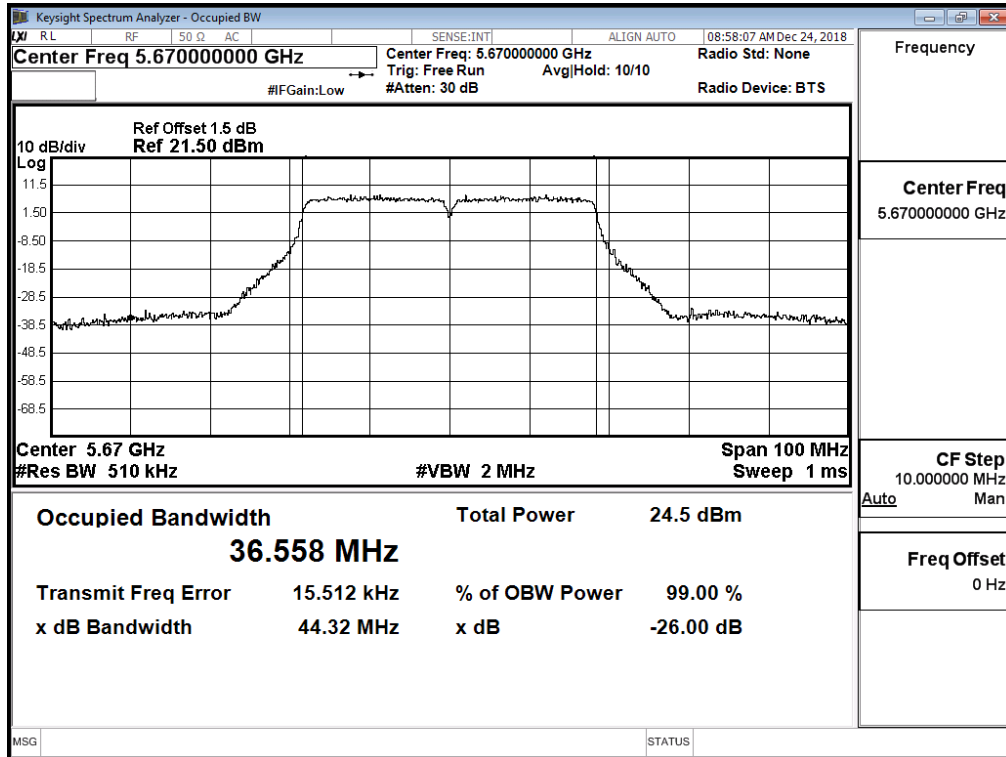

Product : Intel® Wireless-AC 9560  
 Test Item : Maximum conducted output power  
 Test Date : 2019/01/07  
 Test Mode : Mode 2 SISO B: Transmit (802.11ac-20BW\_7.2Mbps)

Cable loss=1.5dB		Average Power									
Channel No.	Frequency (MHz)	Data Rate (Mbps)									Required Limit
		VTH0	VTH1	VTH2	VTH3	VTH4	VTH5	VTH6	VTH7	VTH8	
		Measurement Level (dBm)									
144(U-NII-2C)	5720	17.83	17.76	17.71	17.61	17.52	17.44	17.38	17.33	17.23	<24dBm
144(U-NII-3)	5720	12.13	12.06	12.01	11.91	11.85	11.8	11.74	11.67	11.6	<30dBm

Note: Maximum conducted output power Value =Reading value on Spectrum Analyzer + cable loss

**Maximum conducted output power Measurement:**

Channel No	Frequency Range (MHz)	99% Bandwidth (MHz)	Output Power (dBm)	Output Power Limit		Result
				(dBm)	dBm+10log(BW)	
144(U-NII-2C)	5720	14.034	17.83	24	22.47	Pass
144(U-NII-3)	5720	--	12.13	30	--	Pass

**99% Occupied Bandwidth:  
Channel 144**

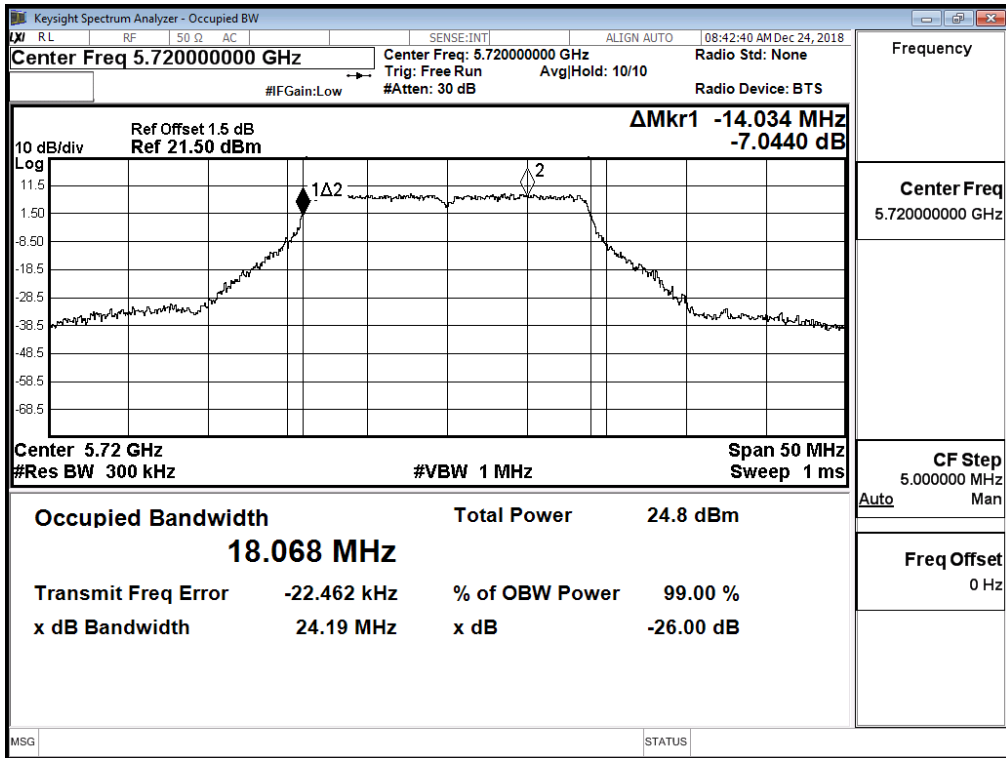

**Maximum conducted output power:**

**Channel 144 (U-NII-2C)**

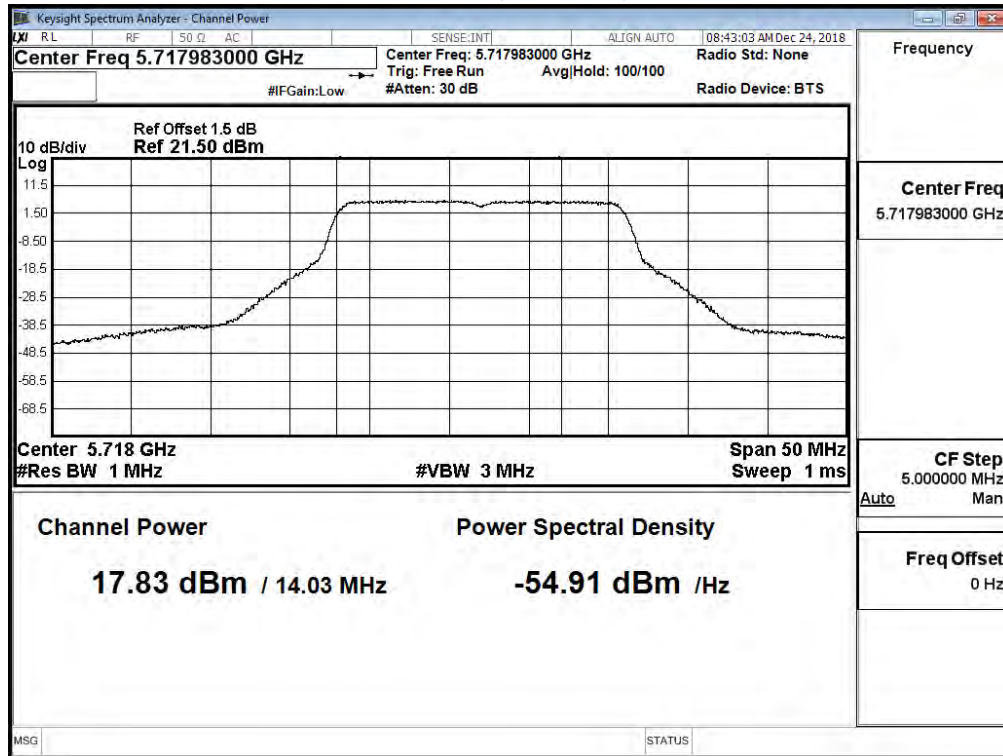

**Channel 144 (U-NII-3)**

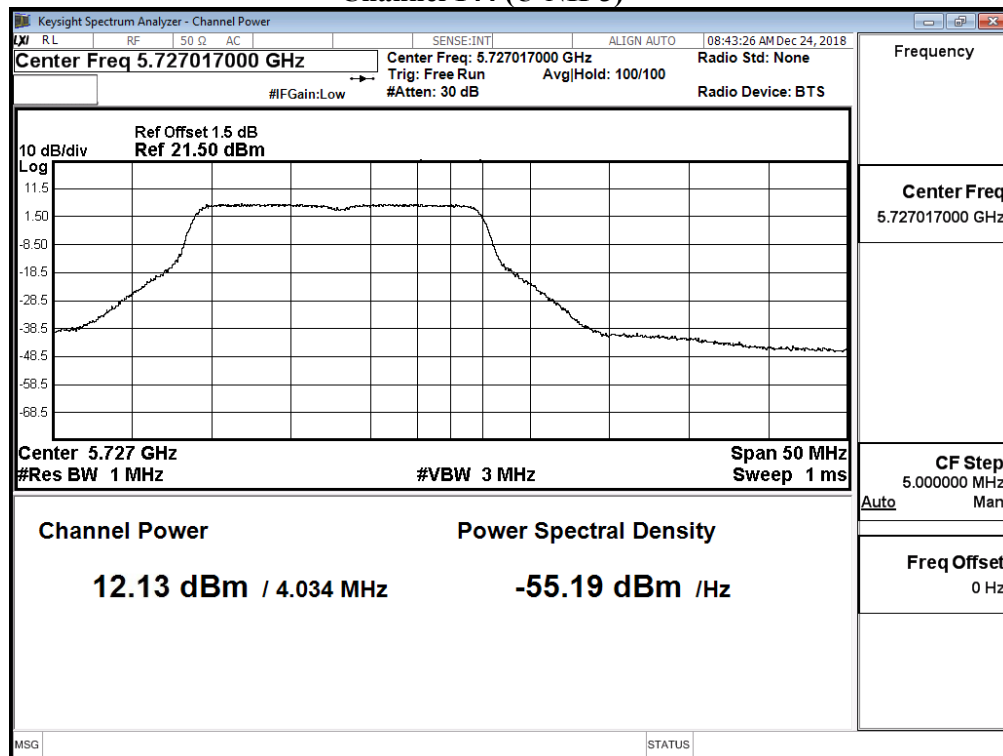

Product : Intel® Wireless-AC 9560  
 Test Item : Maximum conducted output power  
 Test Date : 2019/01/07  
 Test Mode : Mode 2 SISO B: Transmit (802.11ac-40BW\_15Mbps)

Cable loss=1.5dB		Average Power										
Channel No.	Frequency (MHz)	Data Rate (Mbps)										Required Limit
		VTH0	VTH1	VTH2	VTH3	VTH4	VTH5	VTH6	VTH7	VTH8	VTH9	
		Measurement Level (dBm)										
142 (U-NII-2C)	5710	18.47	18.39	18.31	18.26	18.21	18.16	18.08	18	17.93	17.83	<24dBm
142 (U-NII-3)	5710	7.51	7.43	7.33	7.23	7.15	7.07	6.97	6.92	6.85	6.75	<30dBm

Note: Maximum conducted output power Value =Reading value on Spectrum Analyzer + cable loss

**Maximum conducted output power Measurement:**

Channel No	Frequency Range (MHz)	99% Bandwidth (MHz)	Output Power (dBm)	Output Power Limit		Result
				(dBm)	dBm+10log(BW)	
142(U-NII-2C)	5710	33.286	18.47	24	26.22	Pass
142(U-NII-3)	5710	--	7.51	30	--	Pass

**99% Occupied Bandwidth:  
Channel 142**

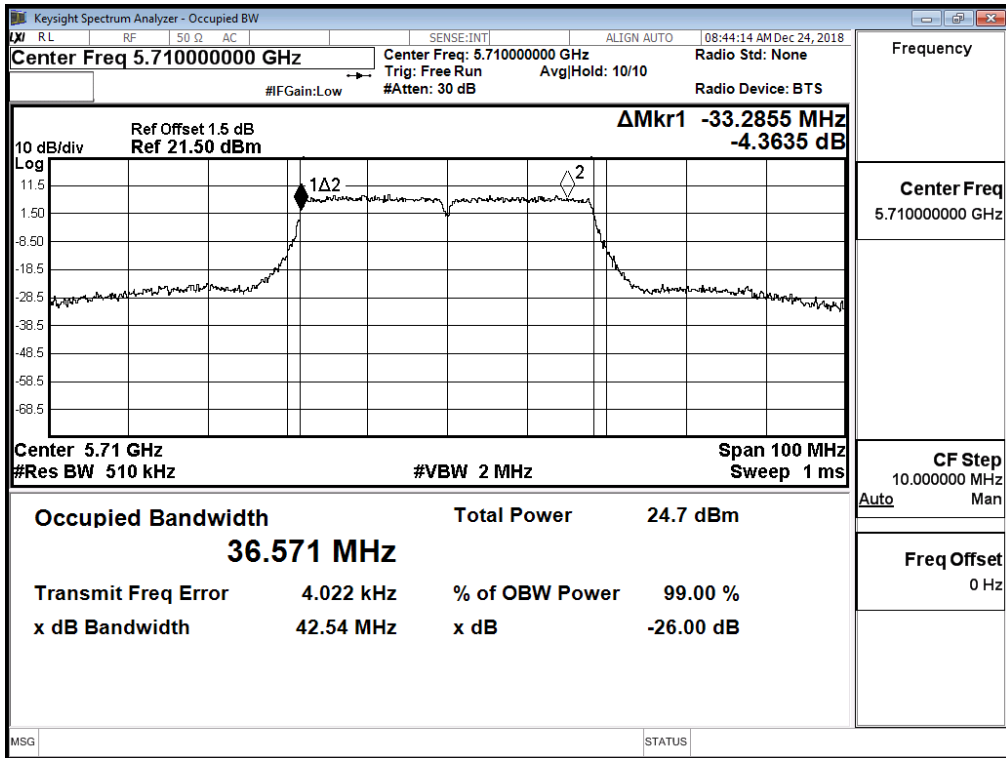

**Maximum conducted output power:  
Channel 142 (U-NII-2C)**

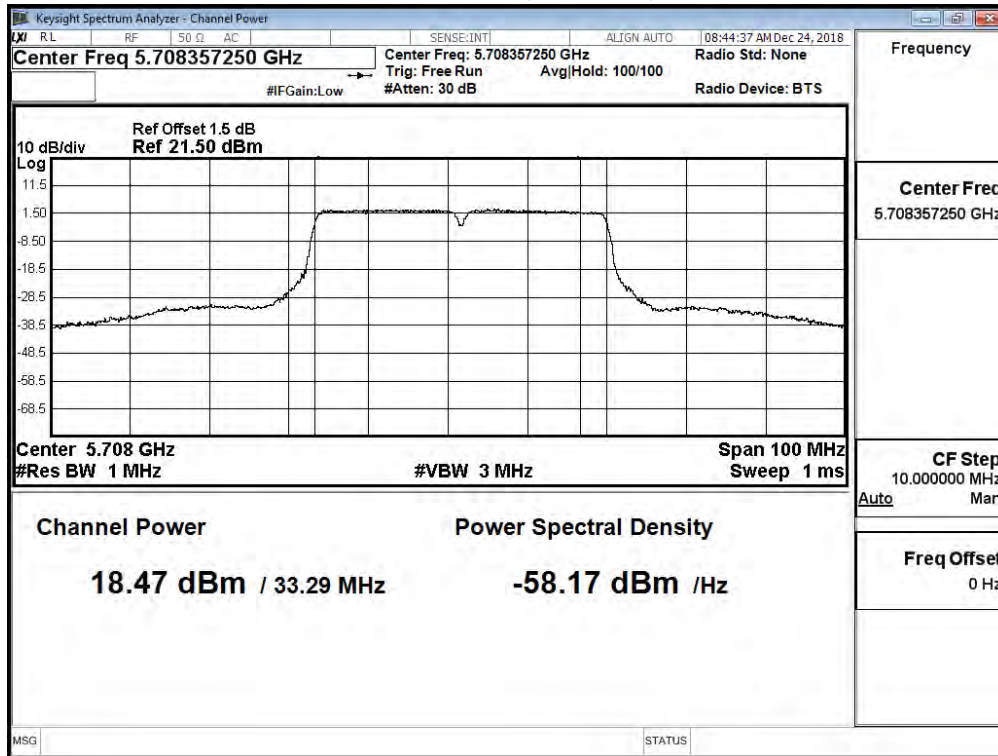

**Channel 142 (U-NII-3)**

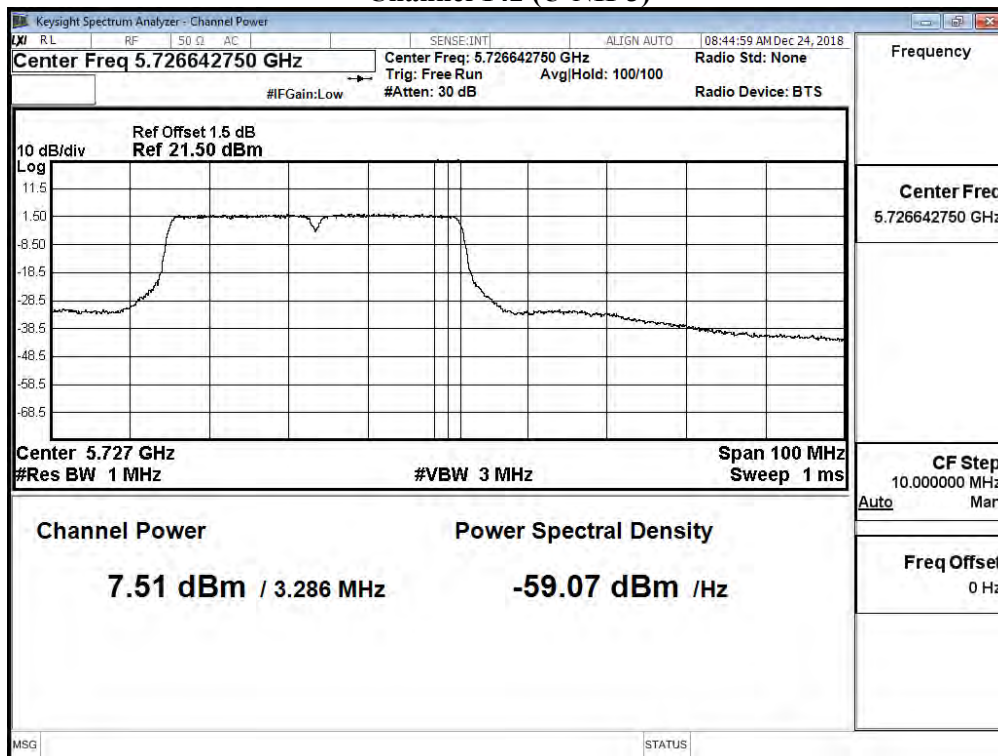

Product : Intel® Wireless-AC 9560  
 Test Item : Maximum conducted output power  
 Test Date : 2019/01/07  
 Test Mode : Mode 2 SISO B: Transmit (802.11ac-80BW\_32.5Mbps)

Cable loss=1.5dB		Average Power										
Channel No	Frequency (MHz)	Data Rate (Mbps)										Required Limit
		VTH0	VTH1	VTH2	VTH3	VTH4	VTH5	VTH6	VTH7	VTH8	VTH9	
42	5210	16.84	16.76	16.68	16.61	16.52	16.43	16.35	16.25	16.2	16.1	<24dBm
58	5290	14.87	14.82	14.77	14.69	14.59	14.5	14.41	14.32	14.23	14.18	<24dBm
106	5530	16.32	--	--	--	--	--	--	--	--	--	<24dBm
122	5610	19.91	19.83	19.73	19.65	19.57	19.52	19.42	19.37	19.3	19.21	<24dBm
138(U-NII-2C)	5690	19.81	--	--	--	--	--	--	--	--	--	<24dBm
138(U-NII-3)	5690	2.13	--	--	--	--	--	--	--	--	--	<30dBm
155	5775	17.9	17.83	17.78	17.72	17.65	17.56	17.5	17.43	17.33	17.27	<30dBm

Note: Maximum conducted output power Value =Reading value on Spectrum Analyzer + cable loss

#### Maximum conducted output power Measurement:

Channel No	Frequency Range (MHz)	99% Bandwidth (MHz)	Output Power (dBm)	Output Power Limit		Result
				(dBm)	dBm+10log(BW)	
42	5210	--	16.84	24	--	Pass
58	5290	75.202	14.87	24	29.76	Pass
106	5530	75.121	16.32	24	29.76	Pass
122	5610	75.185	19.91	24	29.76	Pass
138(U-NII-2C)	5690	72.600	19.81	24	29.61	Pass
138(U-NII-3)	5690	--	2.13	30	--	Pass
155	5775	--	17.90	30	--	Pass



**99% Occupied Bandwidth:  
Channel 58**

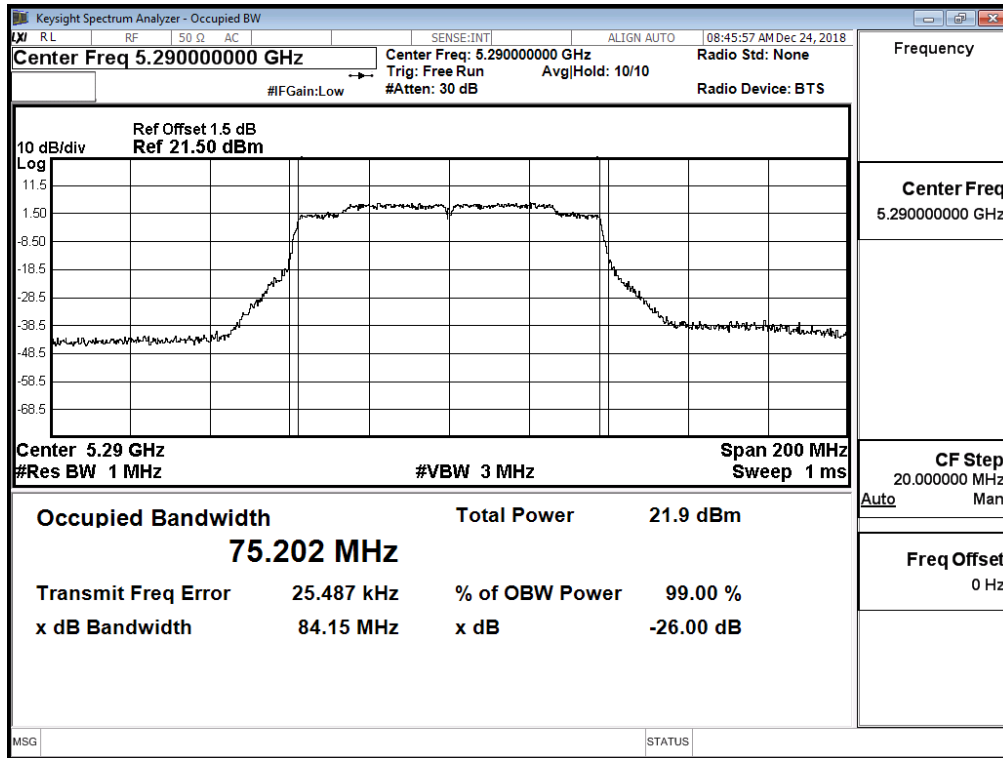

**Channel 106**

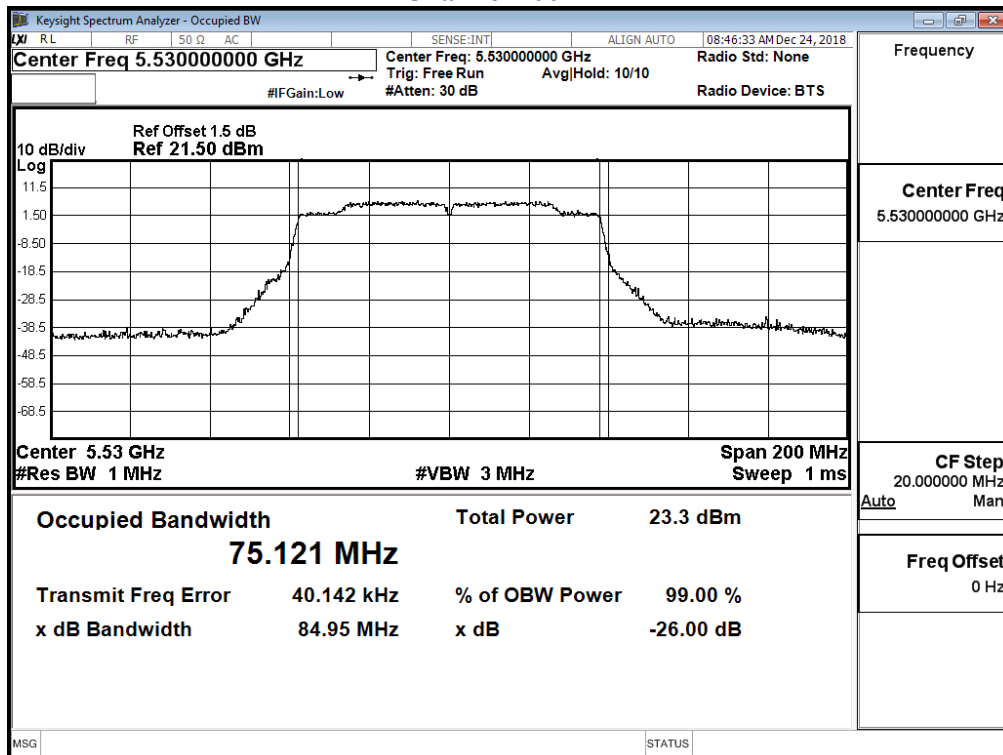

### Channel 112

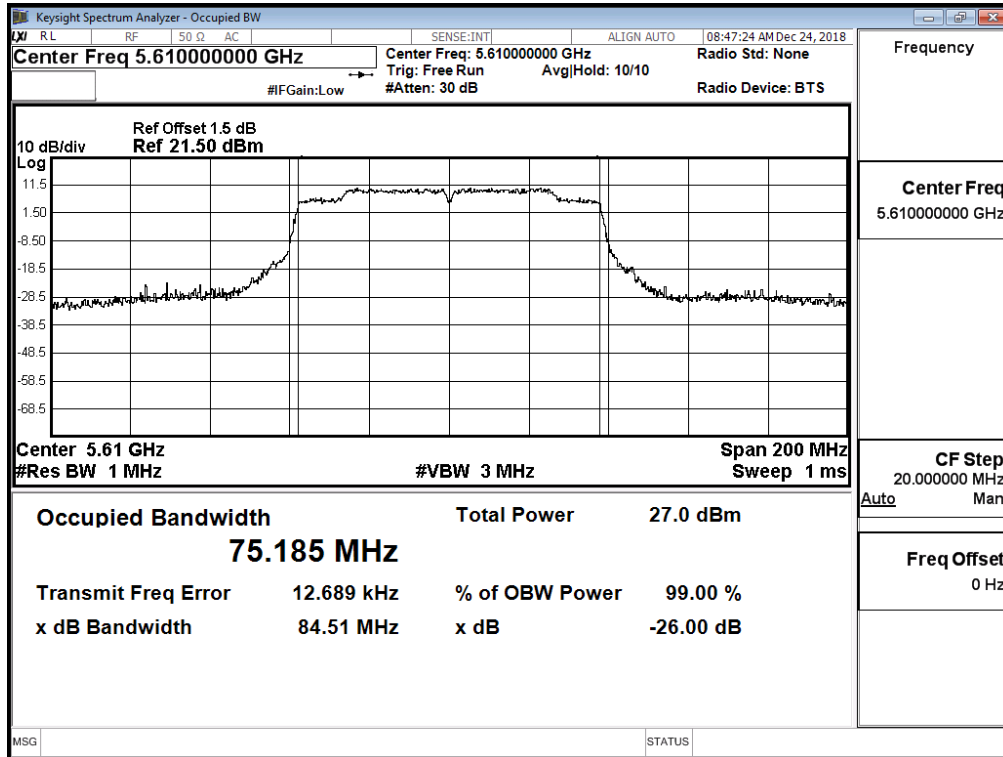

### Channel 138

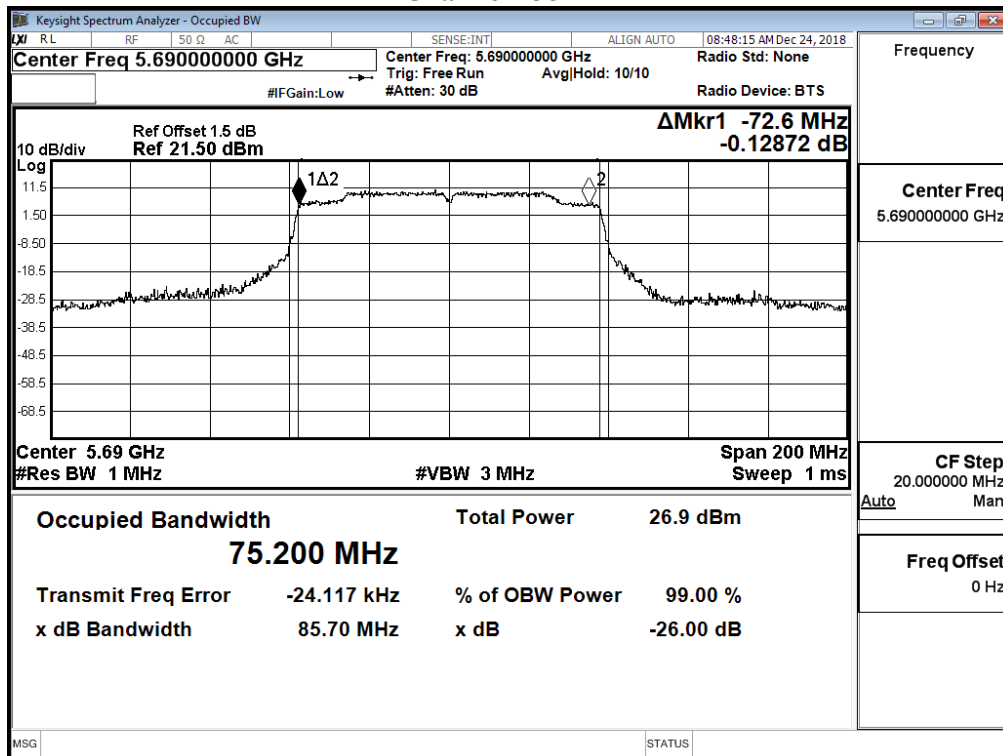

**Maximum conducted output power:  
Channel 138 (U-NII-2C)**

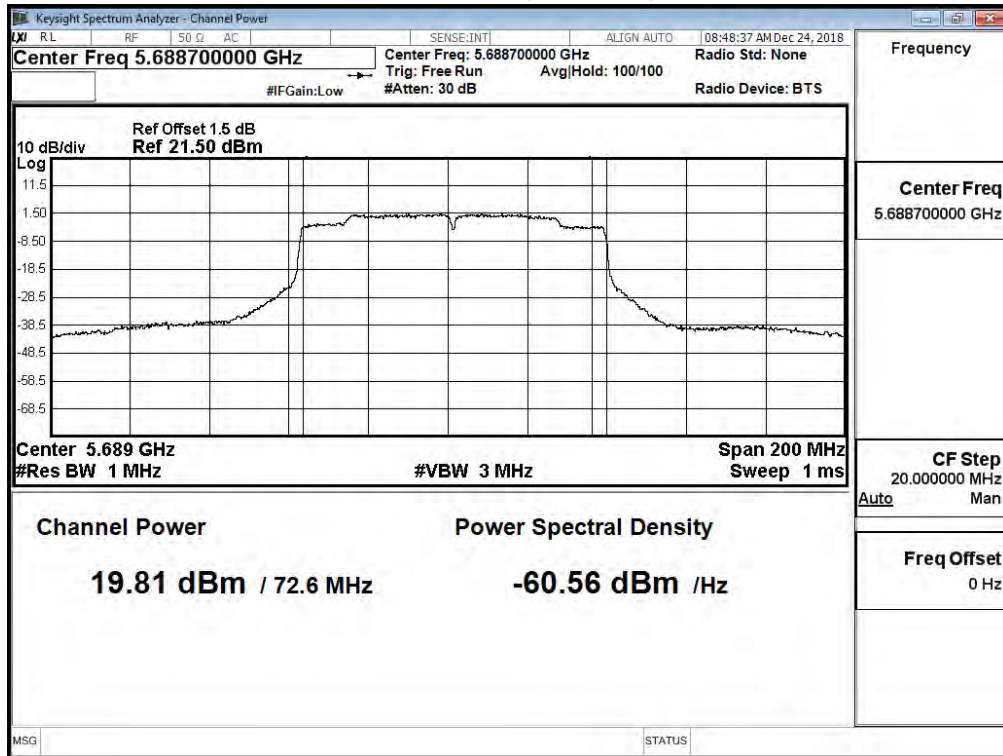

**Maximum conducted output power:  
Channel 138 (U-NII-3)**

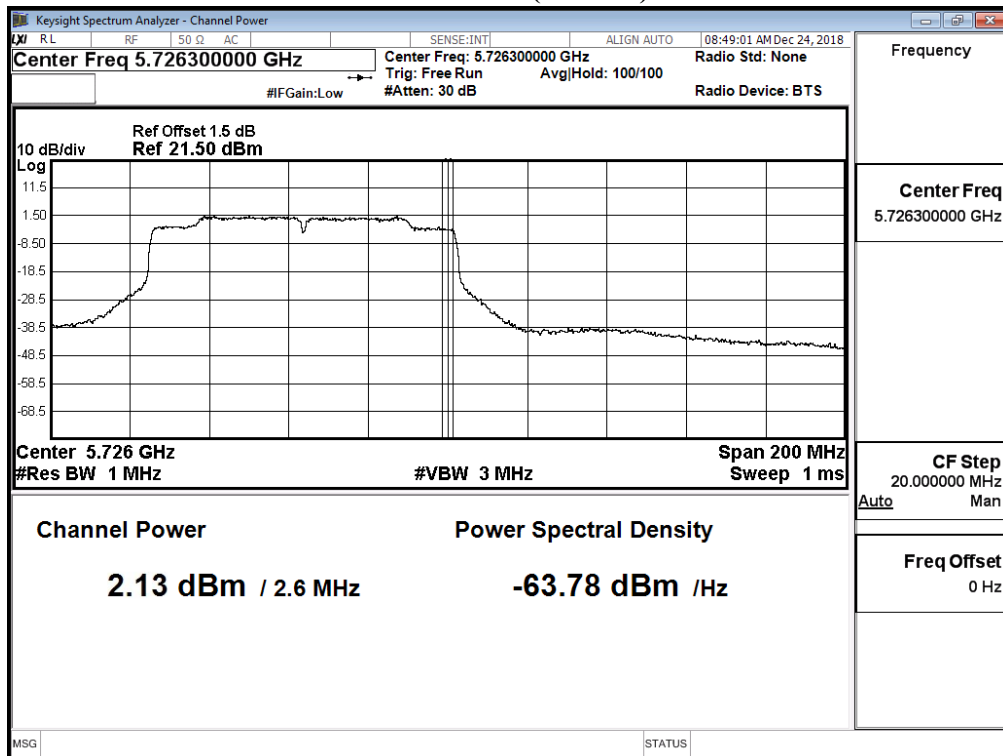

Product : Intel® Wireless-AC 9560  
 Test Item : Maximum conducted output power  
 Test Date : 2019/01/07  
 Test Mode : Mode 2 SISO B: Transmit (802.11ac-160BW\_65Mbps)

Cable loss=1.5dB		Average Power										
Channel No	Frequency (MHz)	Data Rate (Mbps)										Required Limit
		VTH0	VTH1	VTH2	VTH3	VTH4	VTH5	VTH6	VTH7	VTH8	VTH9	
50(U-NII-1)	5250	9.66	9.6	9.5	9.42	9.32	9.26	9.16	9.06	8.96	8.91	<24dBm
50(U-NII-2A)	5250	9.91	9.85	9.79	9.71	9.65	9.6	9.51	9.41	9.36	9.3	<24dBm
114	5570	14.29	14.21	14.12	14.02	13.97	13.88	13.81	13.75	13.65	13.59	<24dBm

Note: Maximum conducted output power Value =Reading value on Spectrum Analyzer + cable loss

**Maximum conducted output power Measurement:**

Channel No	Frequency Range (MHz)	99% Bandwidth (MHz)	Output Power (dBm)	Output Power Limit		Result
				(dBm)	dBm+10log(BW)	
50(U-NII-1)	5250	--	9.66	24	--	Pass
50(U-NII-2A)	5250	76.785	9.91	24	29.85	Pass
114	5570	153.230	14.29	24	32.85	Pass

**99% Occupied Bandwidth:  
Channel 50**

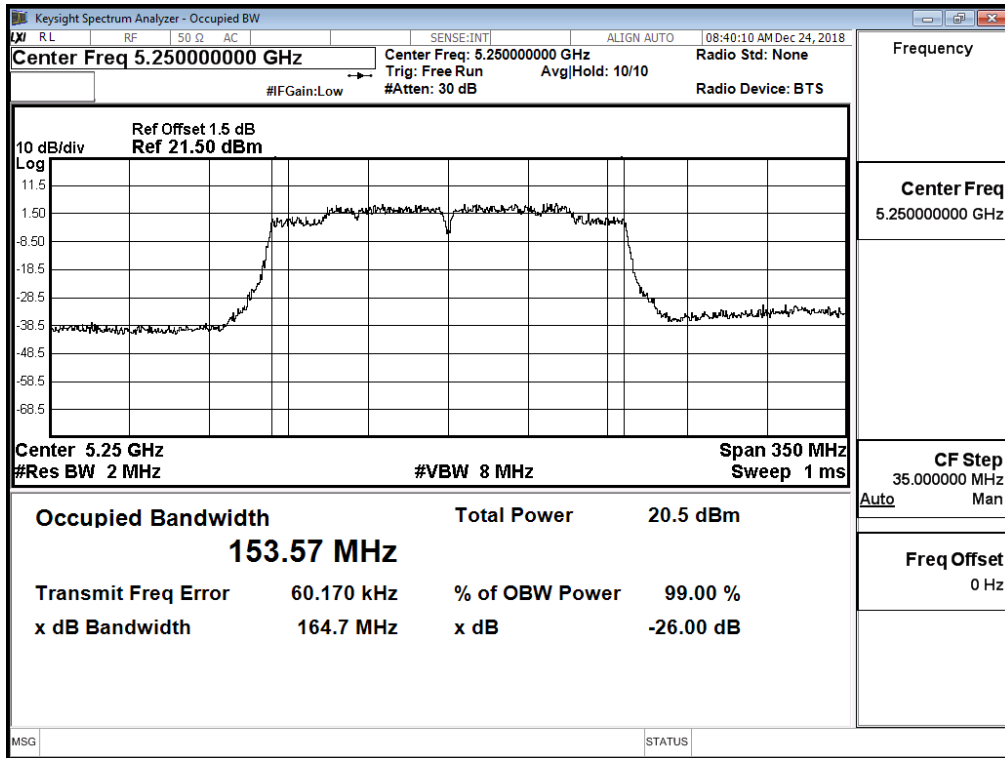

**Channel 114**

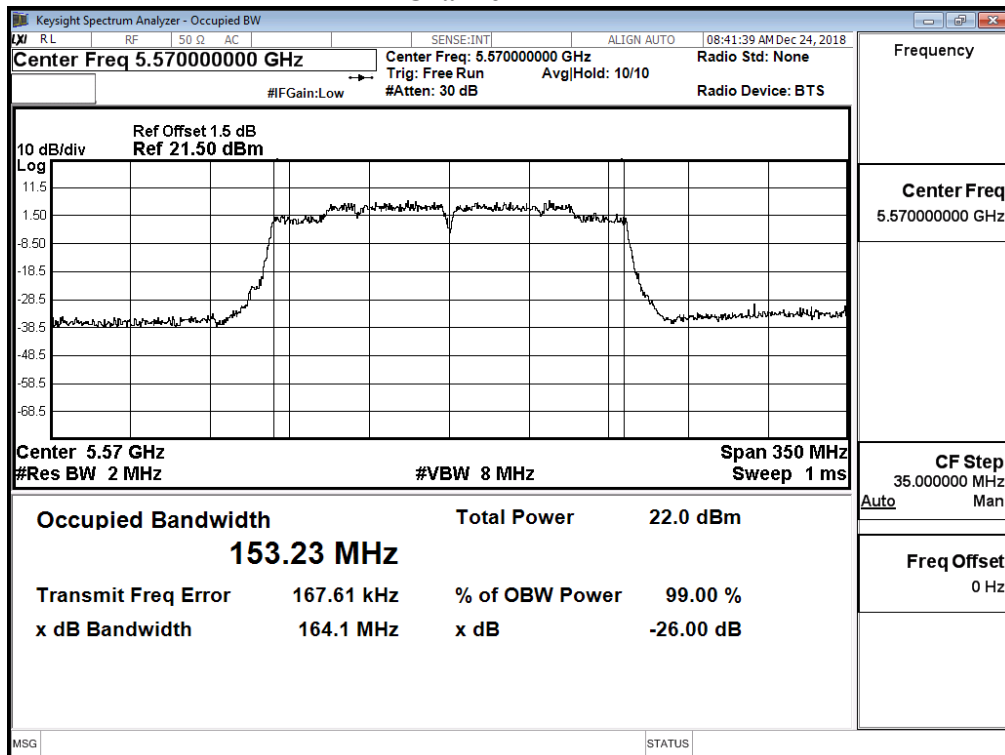

**Maximum conducted output power:**

**Channel 50 (U-NII-1)**

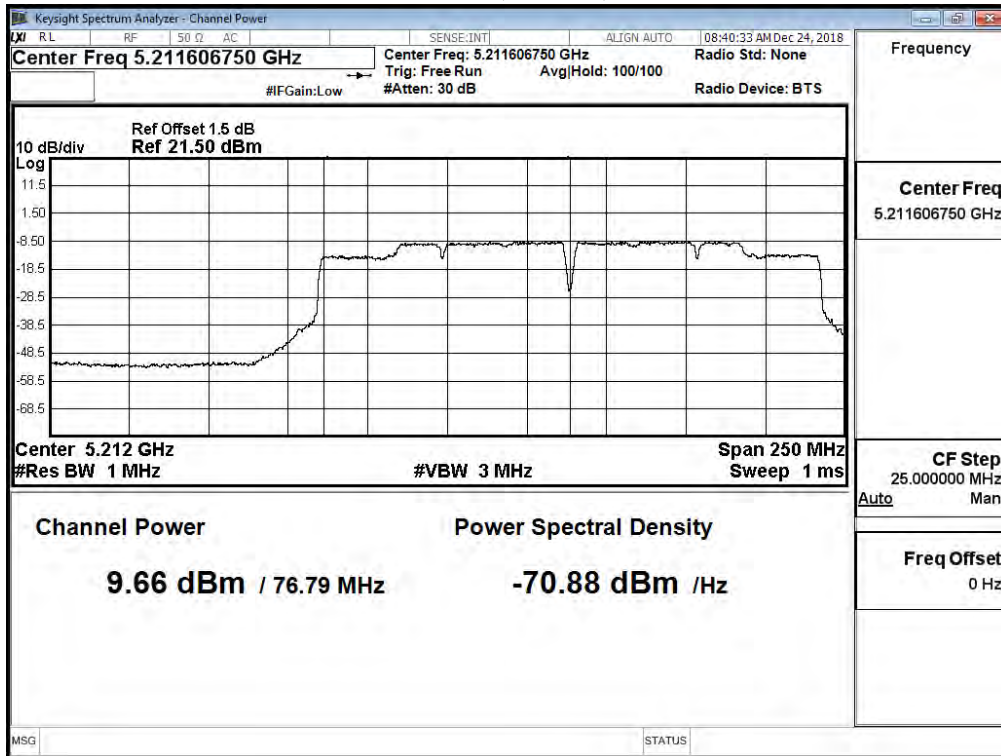

**Maximum conducted output power:**

**Channel 50 (U-NII-2A)**

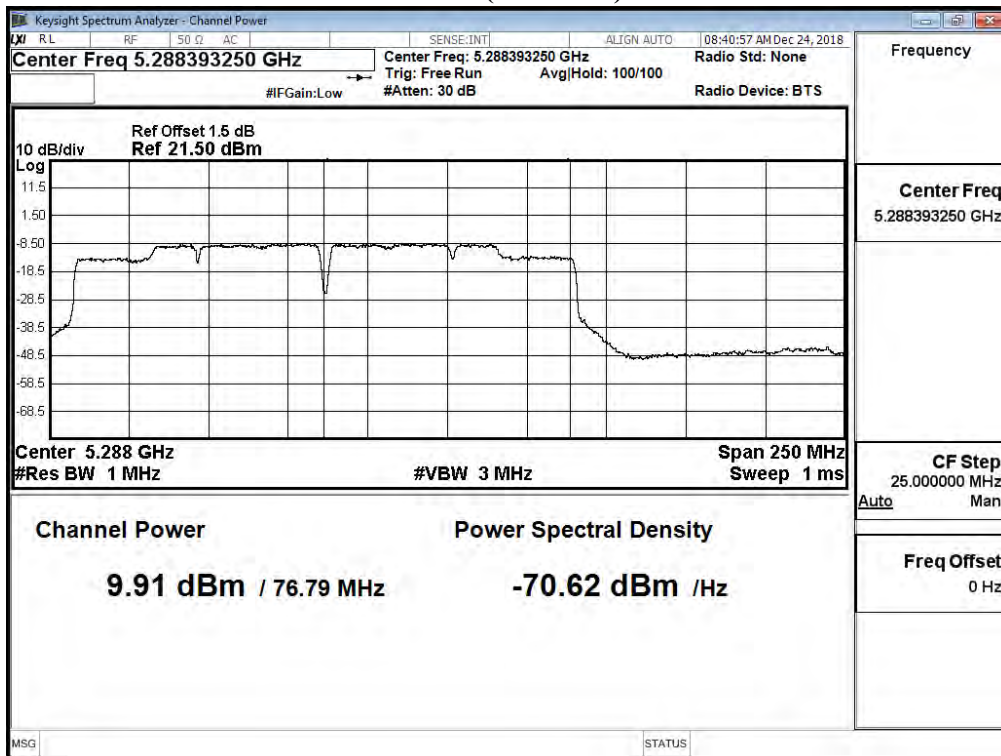

Product : Intel® Wireless-AC 9560  
 Test Item : Maximum conducted output power  
 Test Date : 2019/01/07  
 Test Mode : Mode 3 MIMO: Transmit (802.11n-20BW\_14.4Mbps)

**Chain A**

Cable loss=1.5dB		Average Power								
Channel No.	Frequency (MHz)	Data Rate (Mbps)								Required Limit
		14.4	28.9	43.3	57.8	86.7	115.6	130	144.4	
		Measurement Level (dBm)								
36	5180	14.85	--	--	--	--	--	--	--	<24dBm
40	5200	18.03	17.94	17.89	17.8	17.7	17.63	17.56	17.46	<24dBm
48	5240	17.97	--	--	--	--	--	--	--	<24dBm
52	5260	18.00	--	--	--	--	--	--	--	<24dBm
56	5280	17.92	17.83	17.73	17.68	17.59	17.51	17.43	17.34	<24dBm
64	5320	15.05	--	--	--	--	--	--	--	<24dBm
100	5500	14.99	--	--	--	--	--	--	--	<24dBm
120	5600	18.08	18.01	17.96	17.87	17.81	17.72	17.65	17.59	<24dBm
140	5700	17.05	--	--	--	--	--	--	--	<24dBm
149	5745	18.04	--	--	--	--	--	--	--	<30dBm
157	5785	18.06	17.97	17.89	17.8	17.75	17.69	17.59	17.54	<30dBm
165	5825	17.99	--	--	--	--	--	--	--	<30dBm

Note: Maximum conducted output power Value =Reading value on average power meter + cable loss

**Chain B**

Cable loss=1.5dB		Average Power								
Channel No.	Frequency (MHz)	Data Rate (Mbps)								Required Limit
		14.4	28.9	43.3	57.8	86.7	115.6	130	144.4	
		Measurement Level (dBm)								
36	5180	14.7	--	--	--	--	--	--	--	<24dBm
40	5200	17.74	17.68	17.61	17.53	17.43	17.35	17.25	17.2	<24dBm
48	5240	17.74	--	--	--	--	--	--	--	<24dBm
52	5260	17.91	--	--	--	--	--	--	--	<24dBm
56	5280	17.92	17.86	17.79	17.71	17.65	17.58	17.48	17.4	<24dBm
64	5320	14.85	--	--	--	--	--	--	--	<24dBm
100	5500	14.83	--	--	--	--	--	--	--	<24dBm
120	5600	17.47	17.4	17.3	17.24	17.18	17.13	17.08	17.01	<24dBm
140	5700	16.64	--	--	--	--	--	--	--	<24dBm
149	5745	17.63	--	--	--	--	--	--	--	<30dBm
157	5785	17.5	17.44	17.39	17.29	17.24	17.14	17.04	16.97	<30dBm
165	5825	17.88	--	--	--	--	--	--	--	<30dBm

Note: Maximum conducted output power Value =Reading value on average power meter + cable loss

**Maximum conducted output power Measurement:**

Channel No	Frequency Range (MHz)	99% Bandwidth (MHz)	Chain A Power (dBm)	Chain B Power (dBm)	Output Power (dBm)	Output Power Limit		Result
						(dBm)	dBm+10log(BW)	
36	5180	--	14.85	14.7	17.79	24	--	Pass
40	5200	--	18.03	17.74	20.90	24	--	Pass
48	5240	--	17.97	17.74	20.87	24	--	Pass
52	5260	17.947	18	17.91	20.97	24	23.54	Pass
56	5280	17.954	17.92	17.92	20.93	24	23.54	Pass
64	5320	17.951	15.05	14.85	17.96	24	23.54	Pass
100	5500	17.934	14.99	14.83	17.92	24	23.54	Pass
120	5600	17.990	18.08	17.47	20.80	24	23.55	Pass
140	5700	18.001	17.05	16.64	19.86	24	23.55	Pass
149	5745	--	18.04	17.63	20.85	30	--	Pass
157	5785	--	18.06	17.5	20.80	30	--	Pass
165	5825	--	17.99	17.88	20.95	30	--	Pass

Note:

1. Output Power (dBm) = 10LOG (Chain A Power (mW)+ Chain B Power (mW))
2. 99% Bandwidth is the bandwidth of chain A or chain B whichever is less bandwidth, output power limitation is more stringent.



99% Occupied Bandwidth:

Channel 52 -Chain A

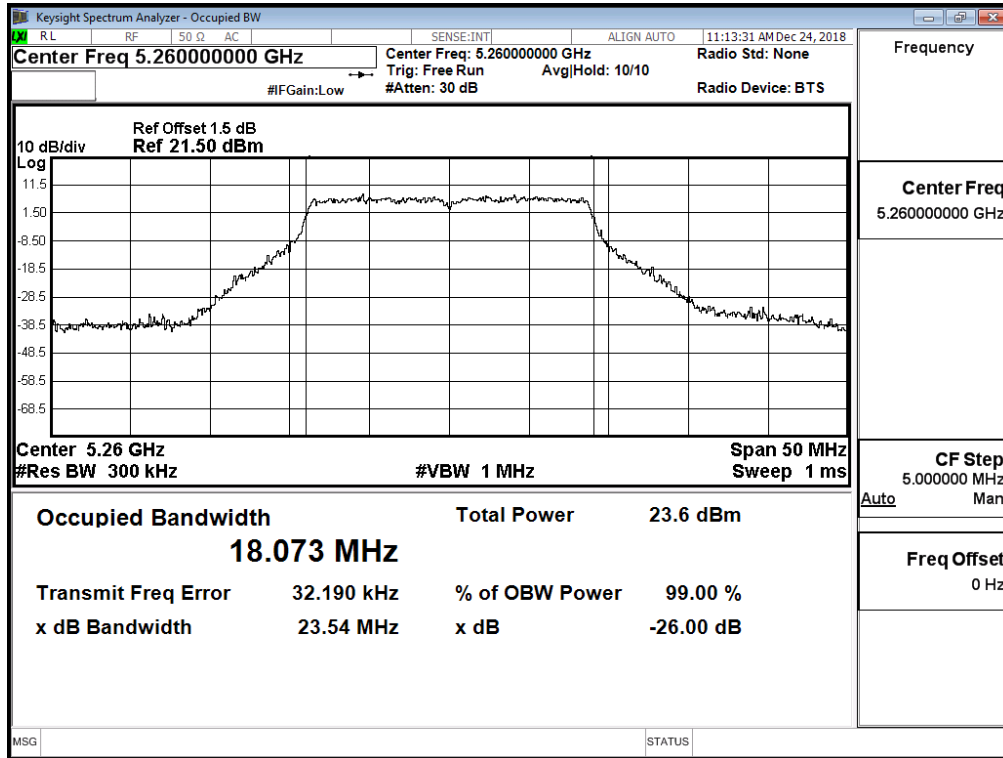

Channel 56 -Chain A

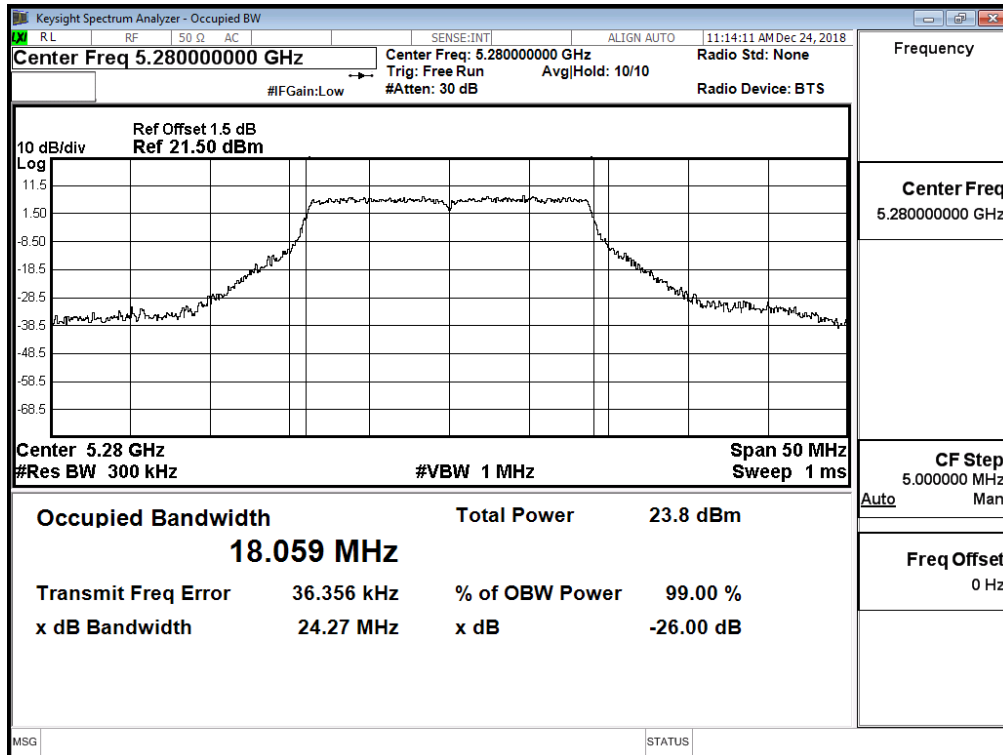

### Channel 64 -Chain A

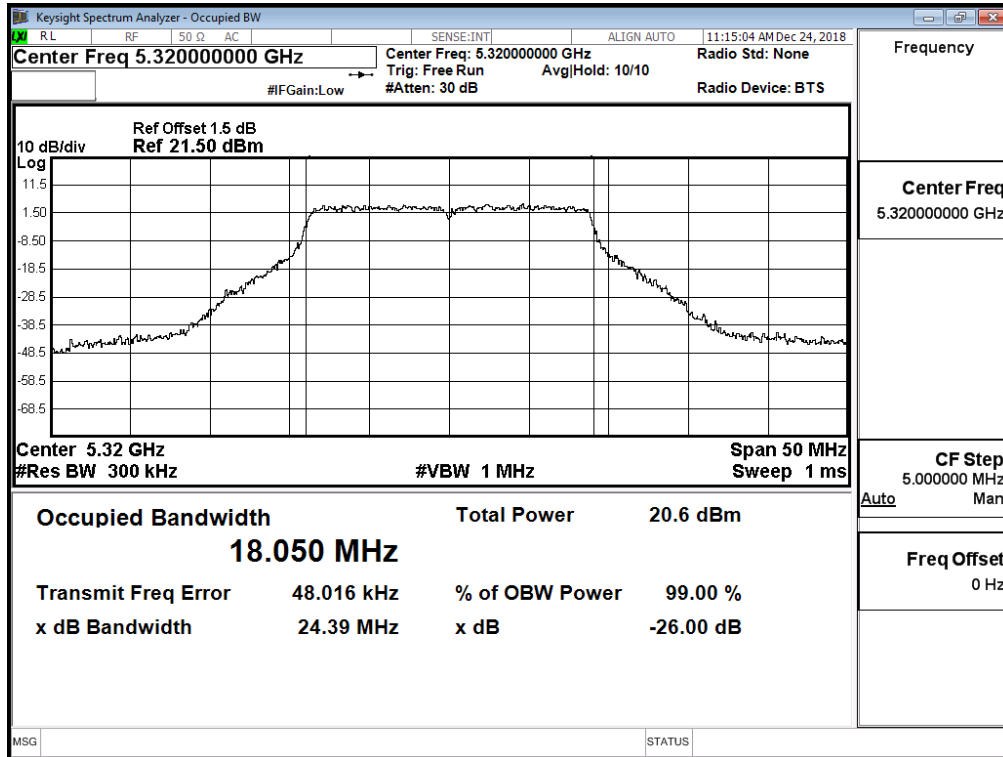

### Channel 100 -Chain A

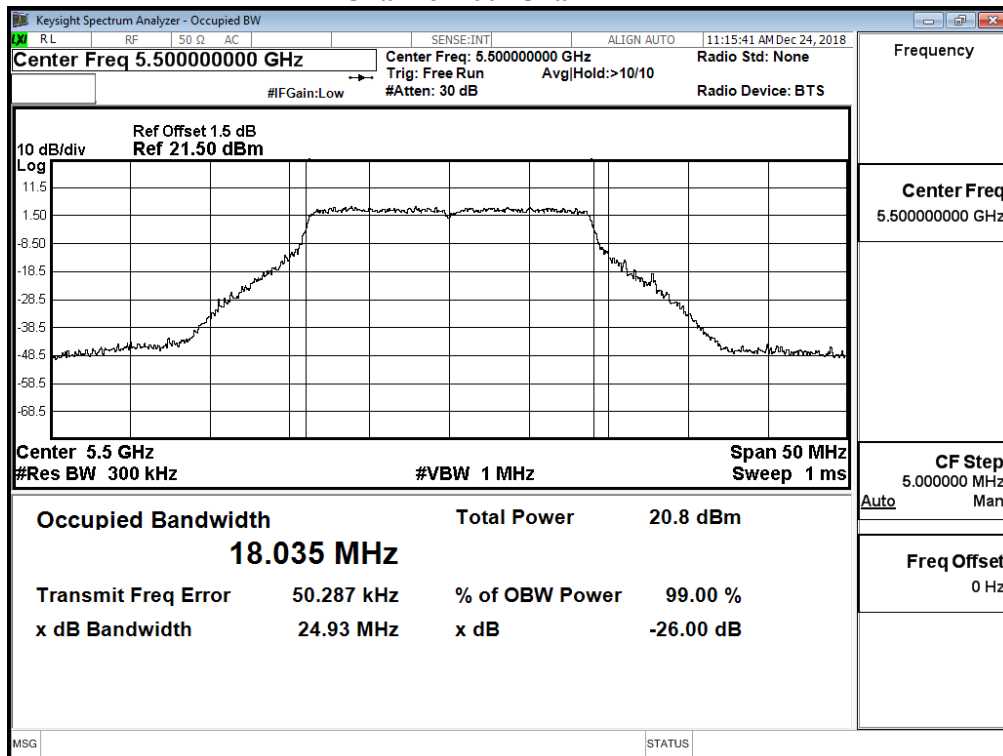

### Channel 120 -Chain A

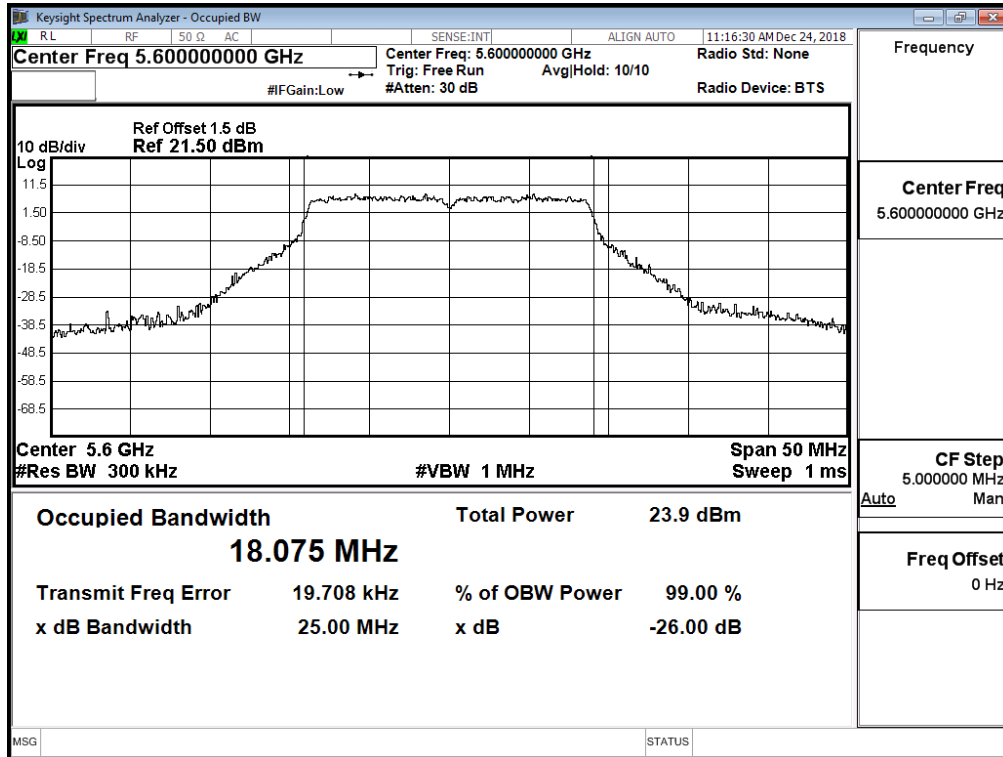

### Channel 140 -Chain A

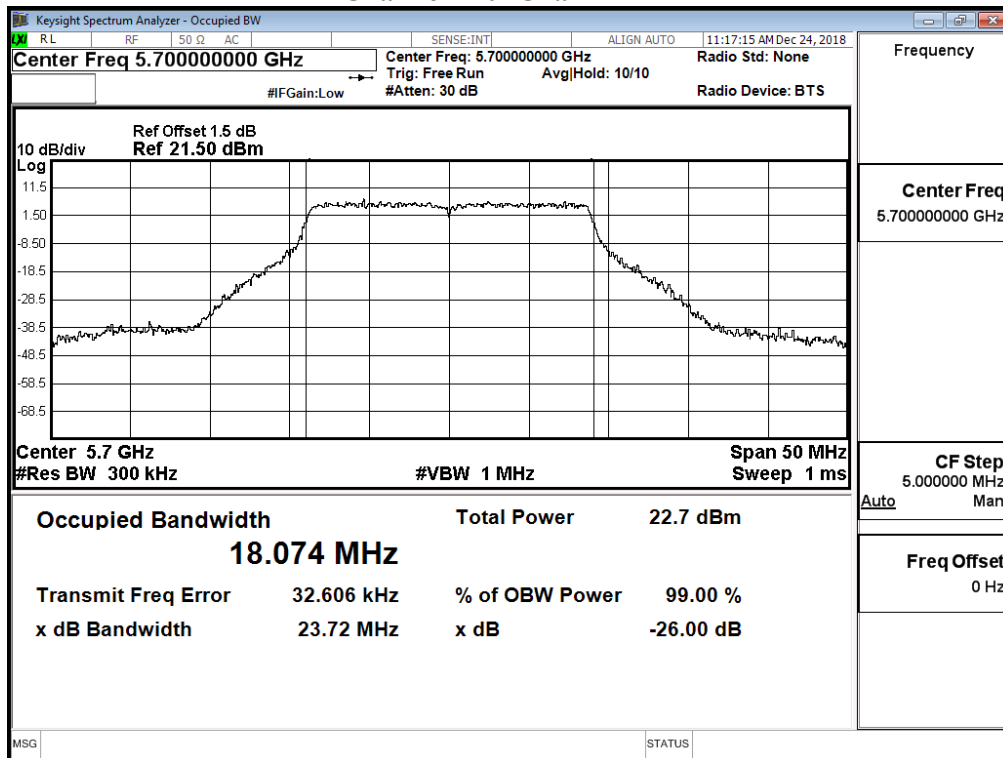

99% Occupied Bandwidth:

Channel 52 -Chain B

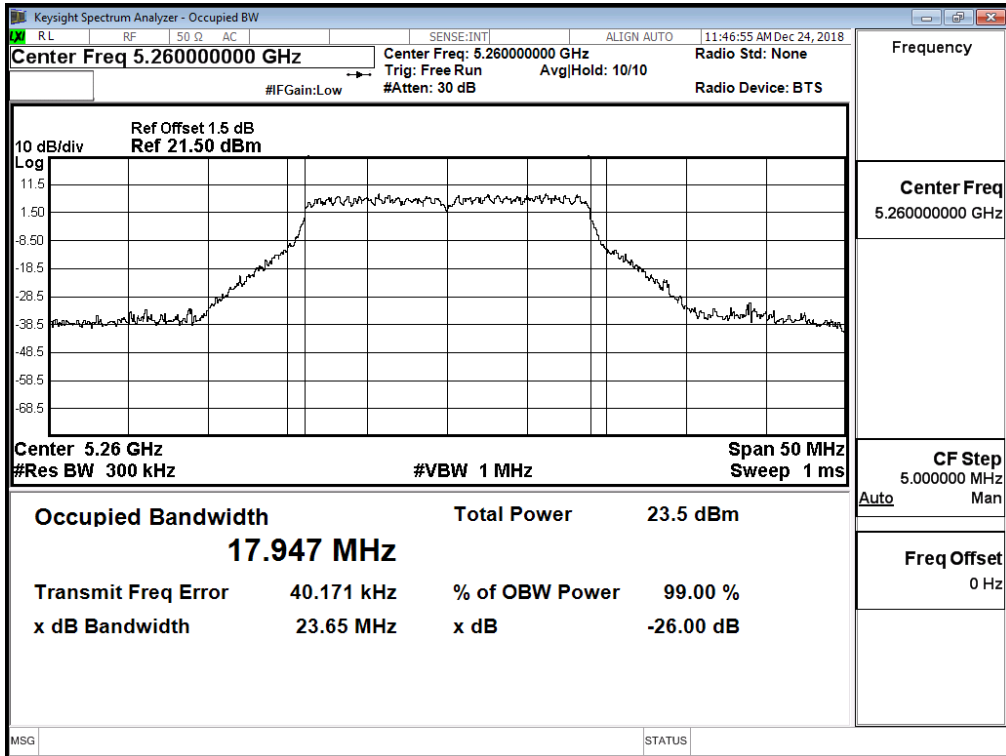

Channel 56 -Chain B

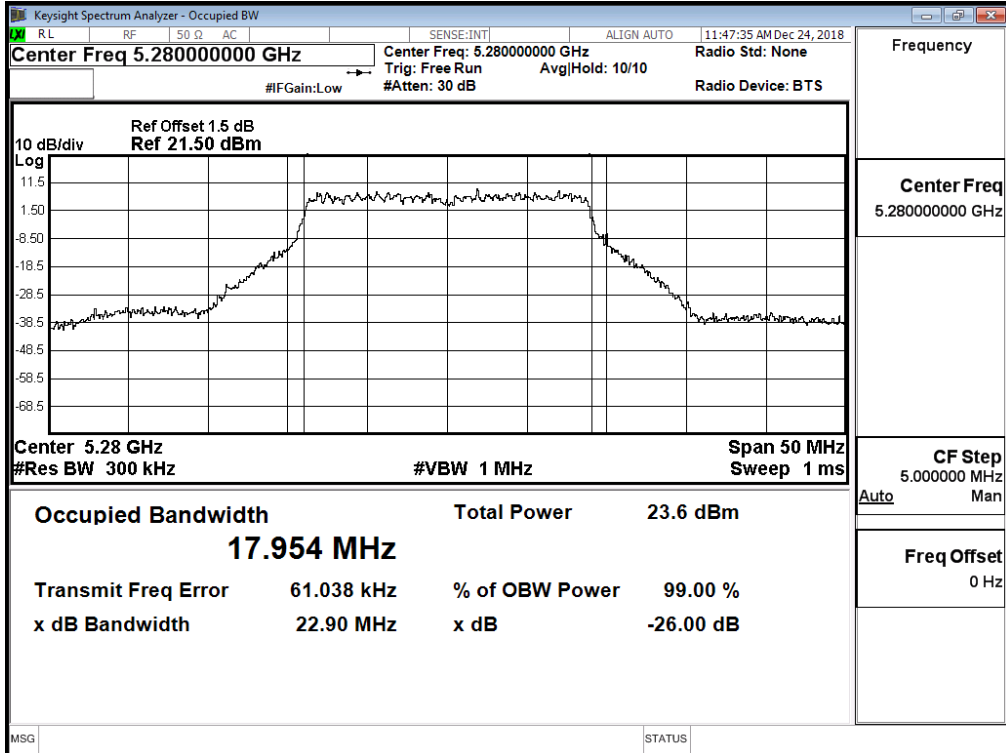

### Channel 64 -Chain B

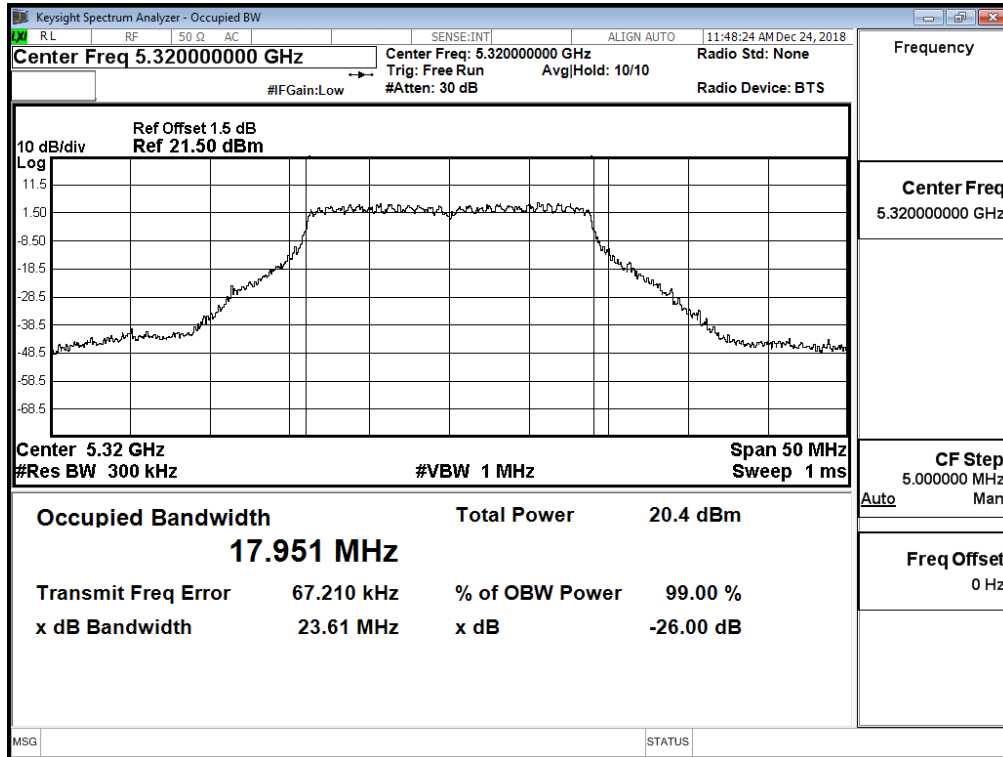

### Channel 100 -Chain B

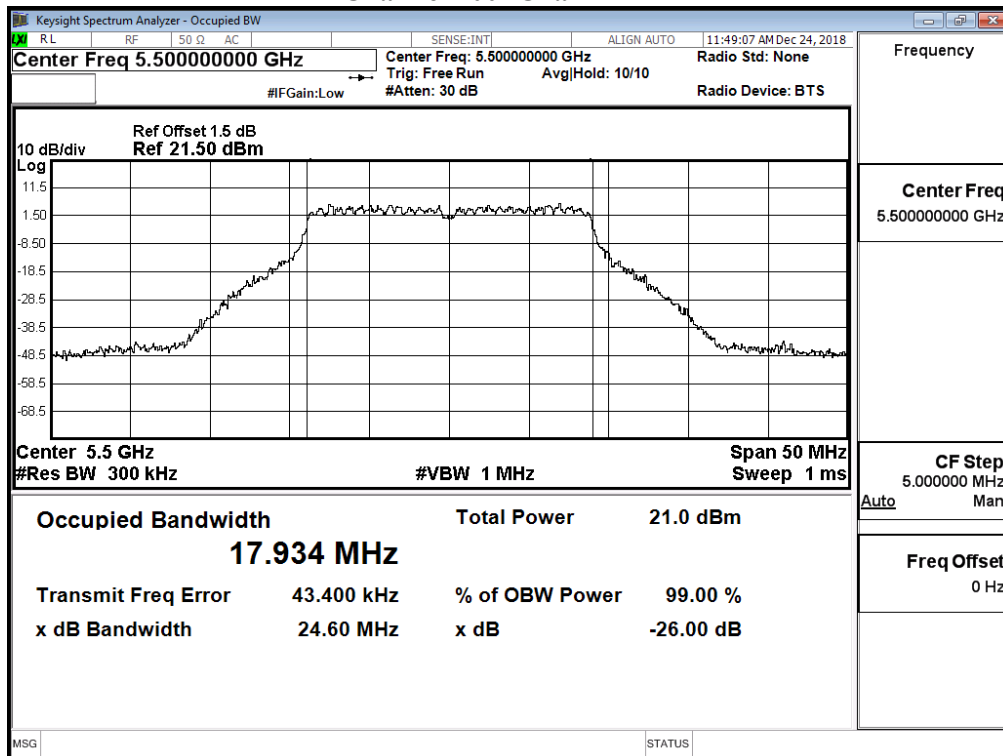

### Channel 120 -Chain B

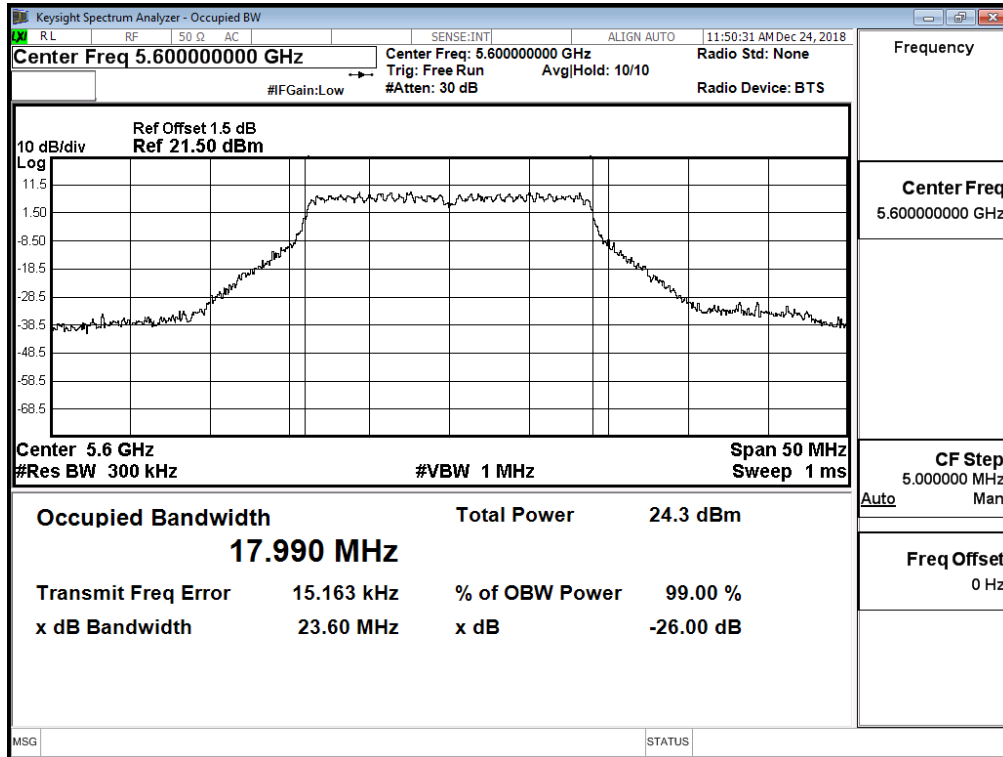

### Channel 140 -Chain B

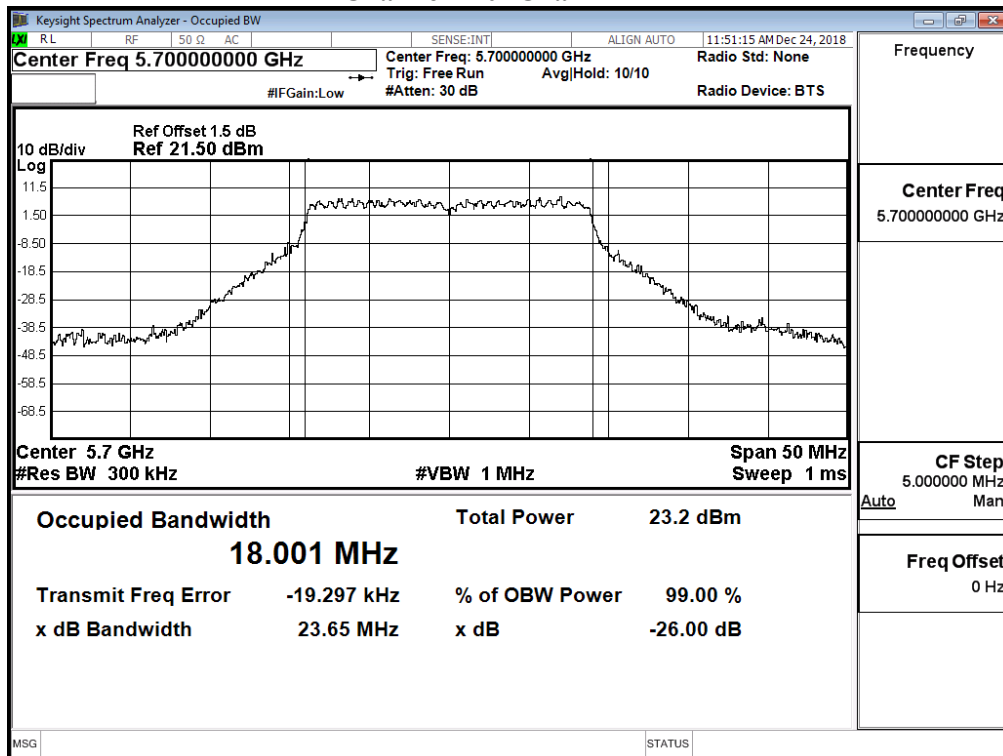

Product : Intel® Wireless-AC 9560  
 Test Item : Maximum conducted output power  
 Test Date : 2019/01/07  
 Test Mode : Mode 3 MIMO: Transmit (802.11n-40BW\_30Mbps)

**Chain A**

Cable loss=1.5dB		Average Power								
Channel No.	Frequency (MHz)	Data Rate (Mbps)								Required Limit
		30	60	90	120	180	240	270	300	
		Measurement Level (dBm)								
38	5190	14.95	--	--	--	--	--	--	--	<24dBm
46	5230	17.94	17.86	17.81	17.75	17.65	17.55	17.49	17.43	<24dBm
54	5270	16.88	--	--	--	--	--	--	--	<24dBm
62	5310	13.87	13.8	13.71	13.62	13.55	13.48	13.38	13.29	<24dBm
102	5510	15.56	--	--	--	--	--	--	--	<24dBm
118	5590	18.15	18.1	18.01	17.95	17.87	17.78	17.72	17.66	<24dBm
134	5670	17.78	--	--	--	--	--	--	--	<24dBm
151	5755	17.62	--	--	--	--	--	--	--	<30dBm
159	5795	17.95	17.85	17.8	17.73	17.65	17.59	17.54	17.49	<30dBm

Note: Maximum conducted output power Value =Reading value on average power meter + cable loss

**Chain B**

Cable loss=1.5dB		Average Power								
Channel No.	Frequency (MHz)	Data Rate (Mbps)								Required Limit
		30	60	90	120	180	240	270	300	
		Measurement Level (dBm)								
38	5190	14.83	--	--	--	--	--	--	--	<24dBm
46	5230	17.71	17.62	17.53	17.45	17.35	17.25	17.15	17.05	<24dBm
54	5270	16.85	--	--	--	--	--	--	--	<24dBm
62	5310	13.85	13.75	13.67	13.57	13.52	13.43	13.34	13.26	<24dBm
102	5510	15.25	--	--	--	--	--	--	--	<24dBm
118	5590	17.73	17.67	17.57	17.52	17.45	17.36	17.29	17.2	<24dBm
134	5670	17.07	--	--	--	--	--	--	--	<24dBm
151	5755	17.28	--	--	--	--	--	--	--	<30dBm
159	5795	17.65	17.59	17.54	17.45	17.39	17.32	17.24	17.16	<30dBm

Note: Maximum conducted output power Value =Reading value on average power meter + cable loss

**Maximum conducted output power Measurement:**

Channel No	Frequency Range (MHz)	99% Bandwidth (MHz)	Chain A Power (dBm)	Chain B Power (dBm)	Output Power (dBm)	Output Power Limit		Result
						(dBm)	dBm+10log(BW)	
38	5190	--	14.95	14.83	17.90	24	--	Pass
46	5230	--	17.94	17.71	20.84	24	--	Pass
54	5270	36.407	16.88	16.85	19.88	24	26.61	Pass
62	5310	36.421	13.87	13.85	16.87	24	26.61	Pass
102	5510	36.451	15.56	15.25	18.42	24	26.62	Pass
118	5590	36.468	18.15	17.73	20.96	24	26.62	Pass
134	5670	36.424	17.78	17.07	20.45	24	26.61	Pass
151	5755	--	17.62	17.28	20.46	30	--	Pass
159	5795	--	17.95	17.65	20.81	30	--	Pass

Note:

1. Output Power (dBm) = 10LOG (Chain A Power (mW)+ Chain B Power (mW))
2. 99% Bandwidth is the bandwidth of chain A or chain B whichever is less bandwidth, output power limitation is more stringent.



99% Occupied Bandwidth:

Channel 54 – Chain A

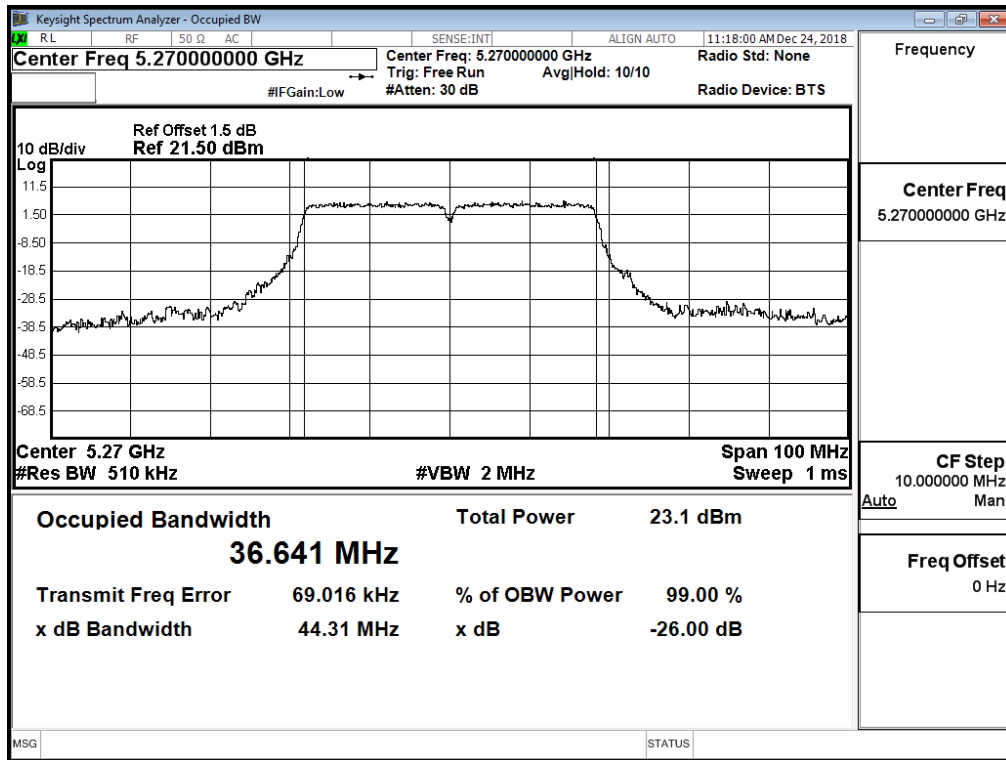

Channel 62 – Chain A

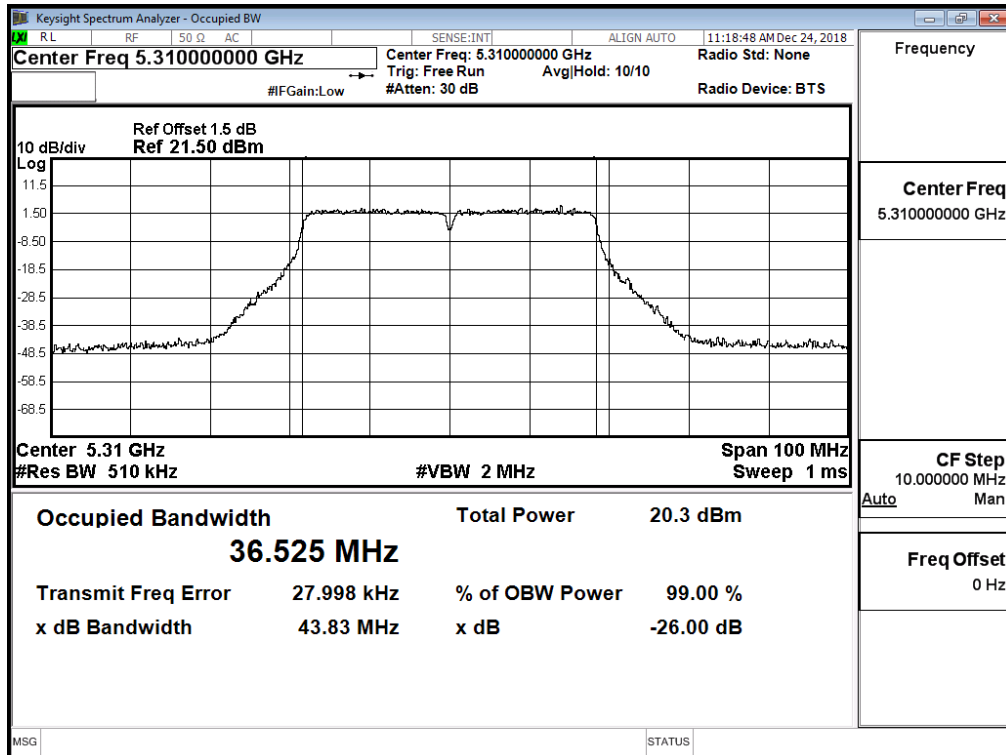

### Channel 102 – Chain A

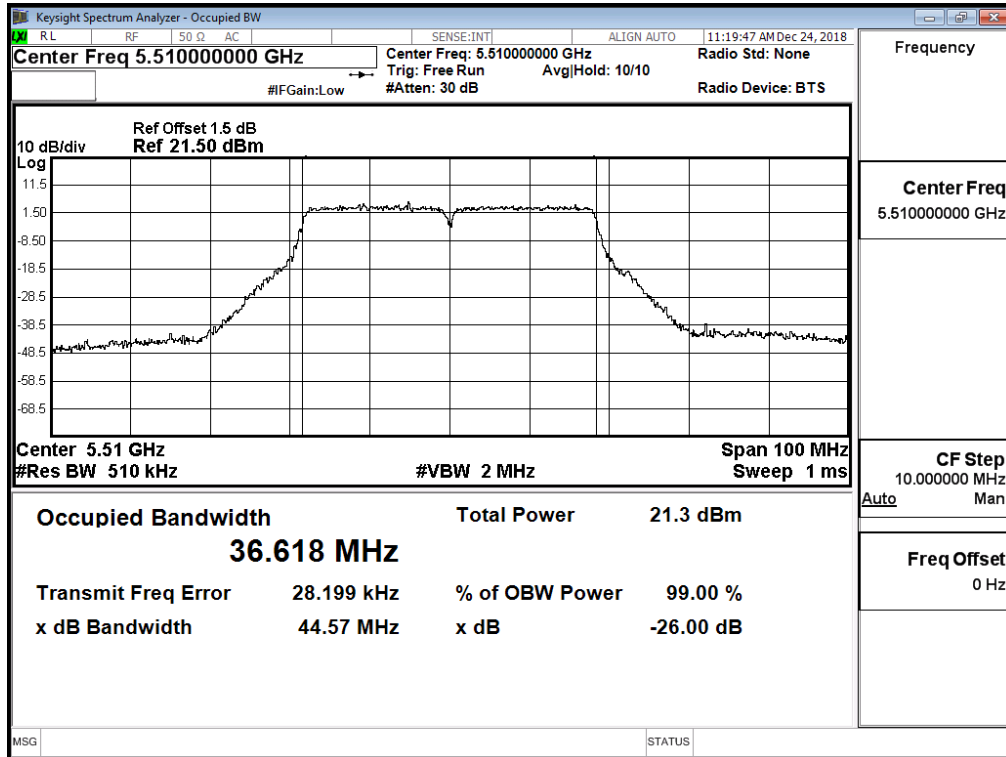

### Channel 118– Chain A

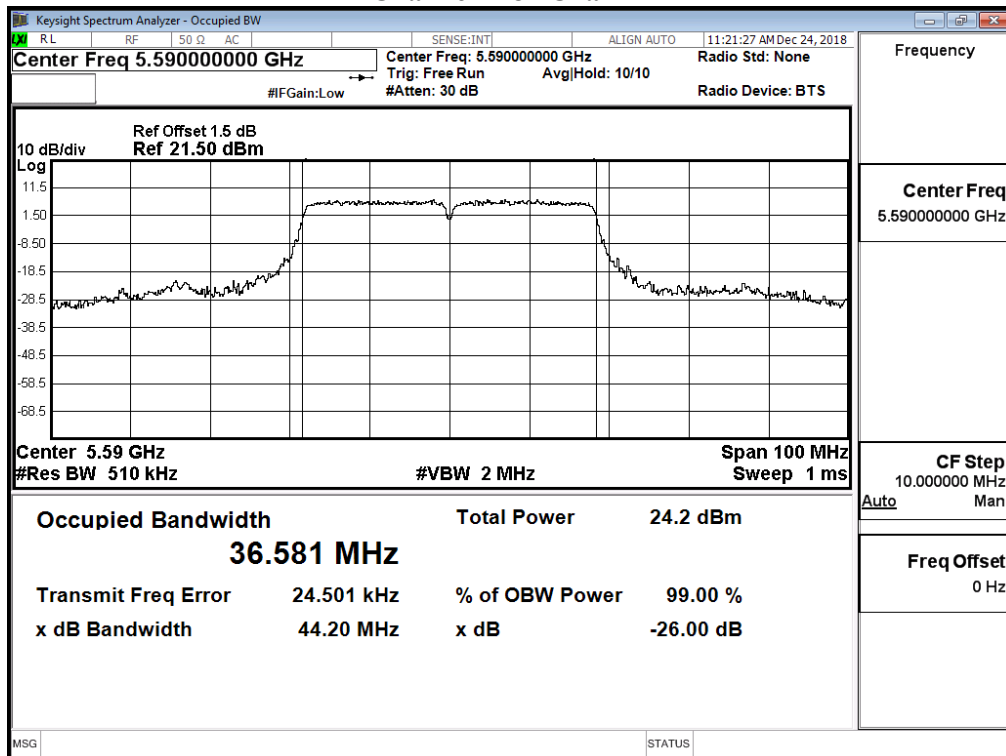

### Channel 134 – Chain A

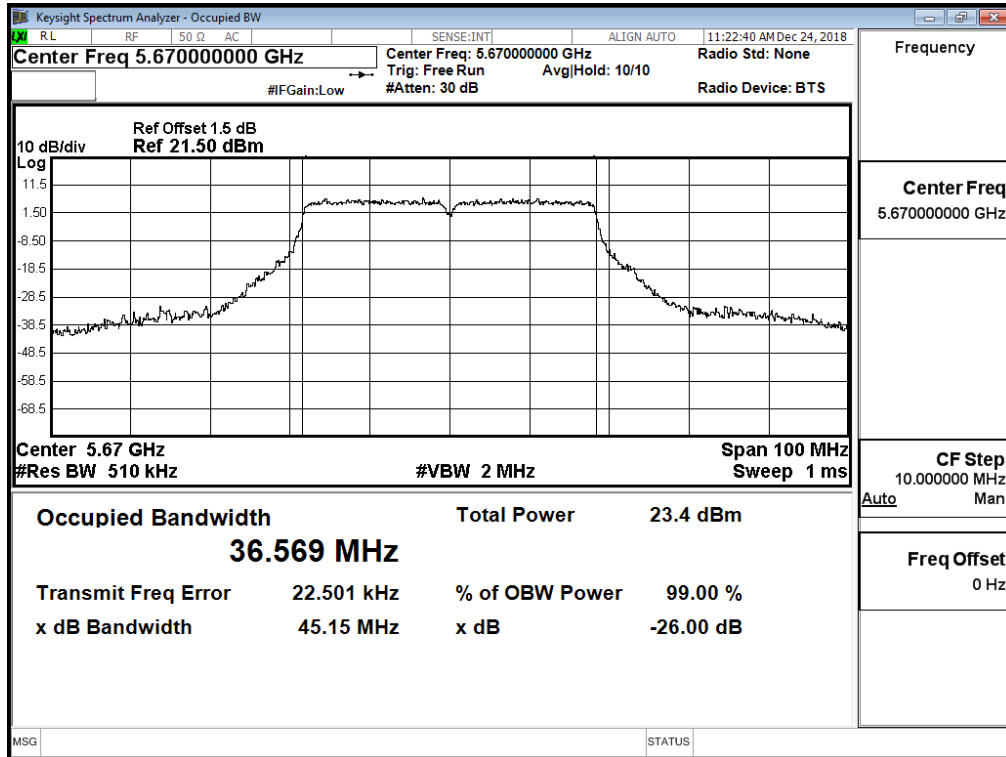

99% Occupied Bandwidth:

Channel 54 –Chain B

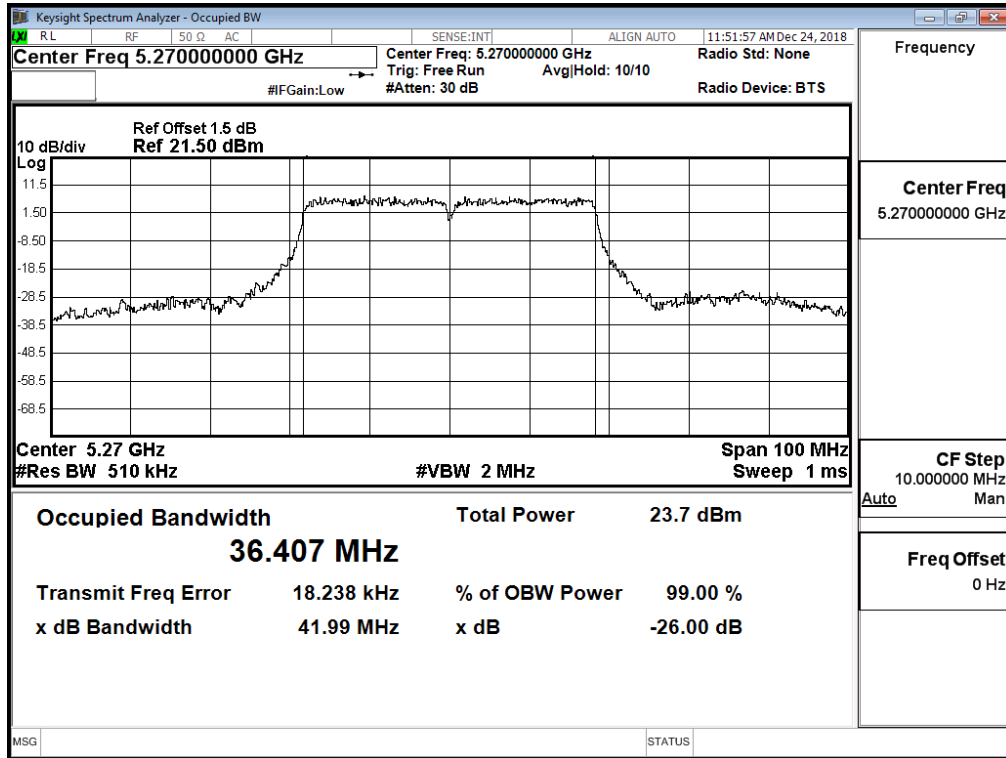

Channel 62 –Chain B

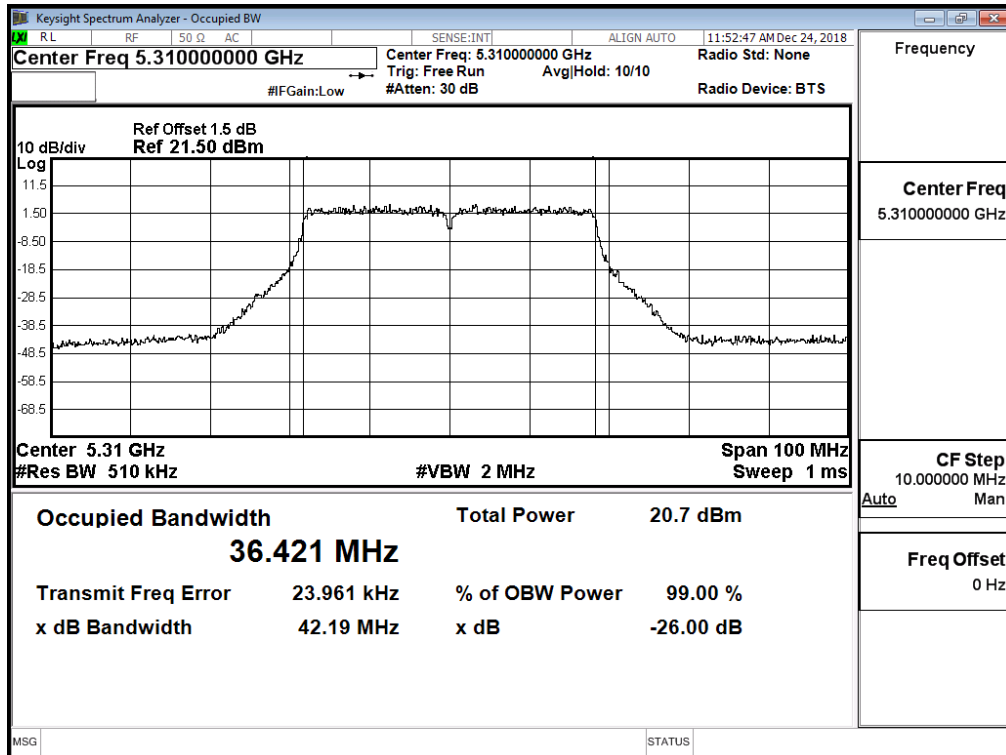

### Channel 102 –Chain B

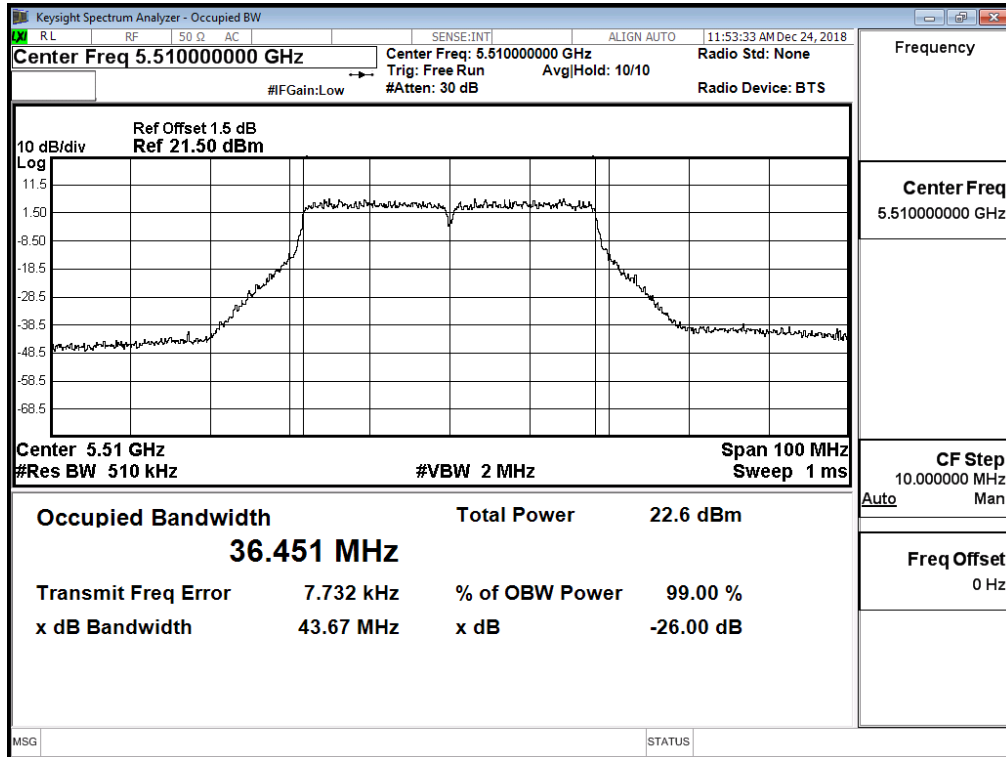

### Channel 118–Chain B

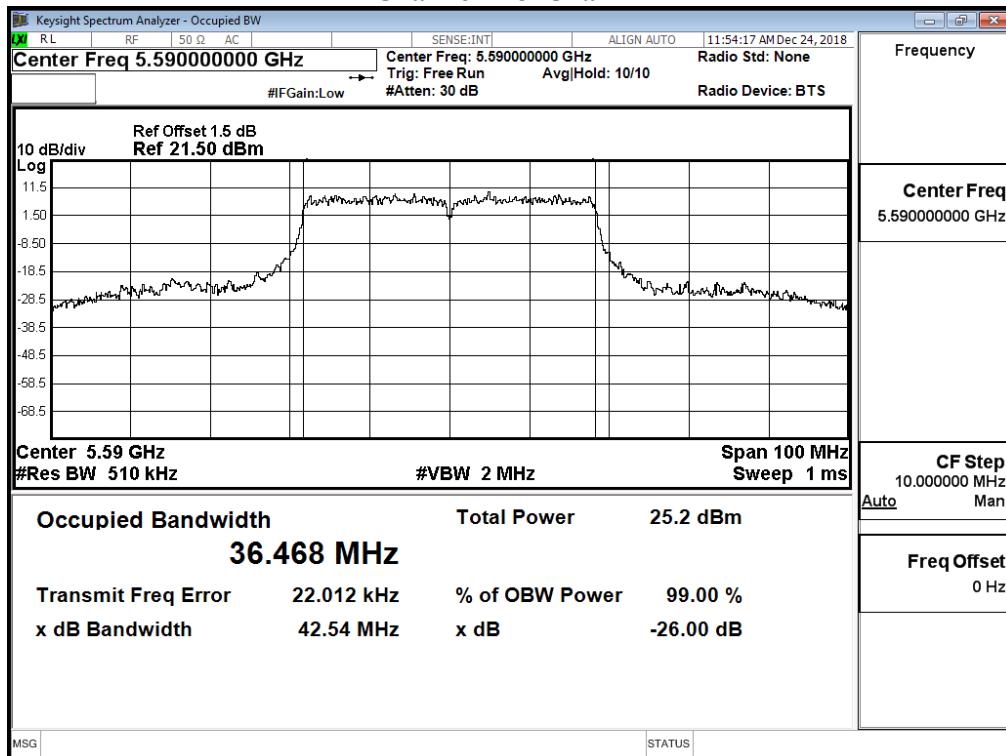

### Channel 134 –Chain B

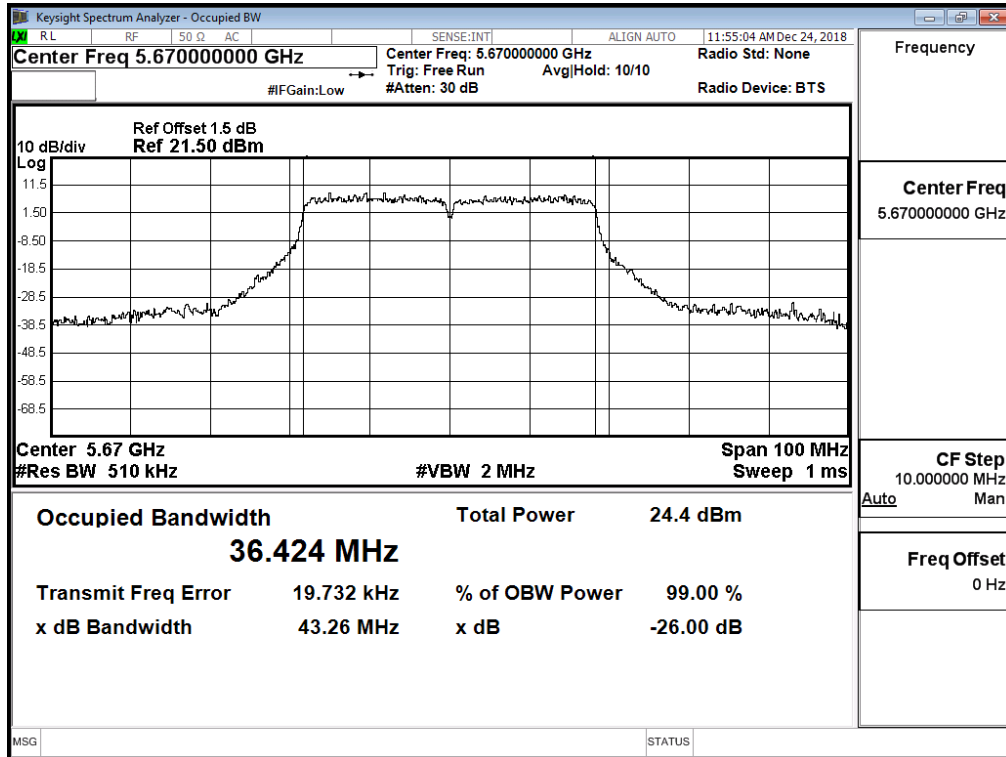

Product : Intel® Wireless-AC 9560  
 Test Item : Maximum conducted output power  
 Test Date : 2019/01/07  
 Test Mode : Mode 3 MIMO: Transmit (802.11ac-20BW\_14.4Mbps)

### Chain A

Cable loss=1.5dB		Average Power									
Channel No.	Frequency (MHz)	Data Rate (Mbps)									Required Limit
		VTH0	VTH1	VTH2	VTH3	VTH4	VTH5	VTH6	VTH7	VTH8	
		Measurement Level (dBm)									
144(U-NII-2C)	5720	16.15	16.06	15.96	15.88	15.78	15.68	15.63	15.54	15.44	<24dBm
144(U-NII-3)	5720	10.45	10.38	10.3	10.25	10.16	10.06	10	9.93	9.86	<30dBm

Note: Maximum conducted output power Value =Reading value on Spectrum Analyzer + cable loss

### Chain B

Cable loss=1.5dB		Average Power									
Channel No.	Frequency (MHz)	Data Rate (Mbps)									Required Limit
		VTH0	VTH1	VTH2	VTH3	VTH4	VTH5	VTH6	VTH7	VTH8	
		Measurement Level (dBm)									
144(U-NII-2C)	5720	15.48	15.4	15.3	15.24	15.15	15.06	14.99	14.9	14.84	<24dBm
144(U-NII-3)	5720	9.85	9.8	9.7	9.62	9.53	9.46	9.36	9.3	9.2	<30dBm

Note: Maximum conducted output power Value =Reading value on Spectrum Analyzer + cable loss

### Maximum conducted output power Measurement:

Channel No	Frequency Range (MHz)	99% Bandwidth (MHz)	Chain A Power (dBm)	Chain B Power (dBm)	Output Power (dBm)	Output Power Limit		Result
						(dBm)	dBm+10log(BW)	
144(U-NII-2C)	5720	13.966	16.15	15.48	18.84	24	22.45	Pass
144(U-NII-3)	5720	--	10.45	9.85	13.17	30	--	Pass

Note:

- Output Power (dBm) = 10LOG (Chain A Power (mW)+ Chain B Power (mW))
- 99% Bandwidth is the bandwidth of chain A or chain B whichever is less bandwidth, output power limitation is more stringent.

**99% Occupied Bandwidth:  
Channel 144 – Chain A**

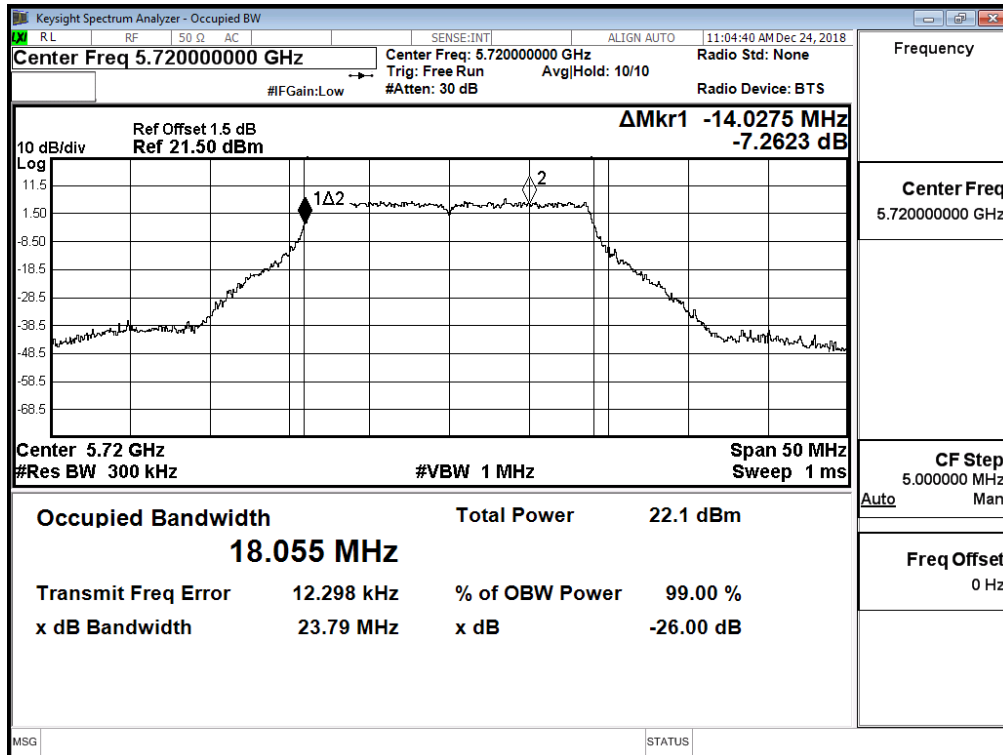

**99% Occupied Bandwidth:  
Channel 144 – Chain B**

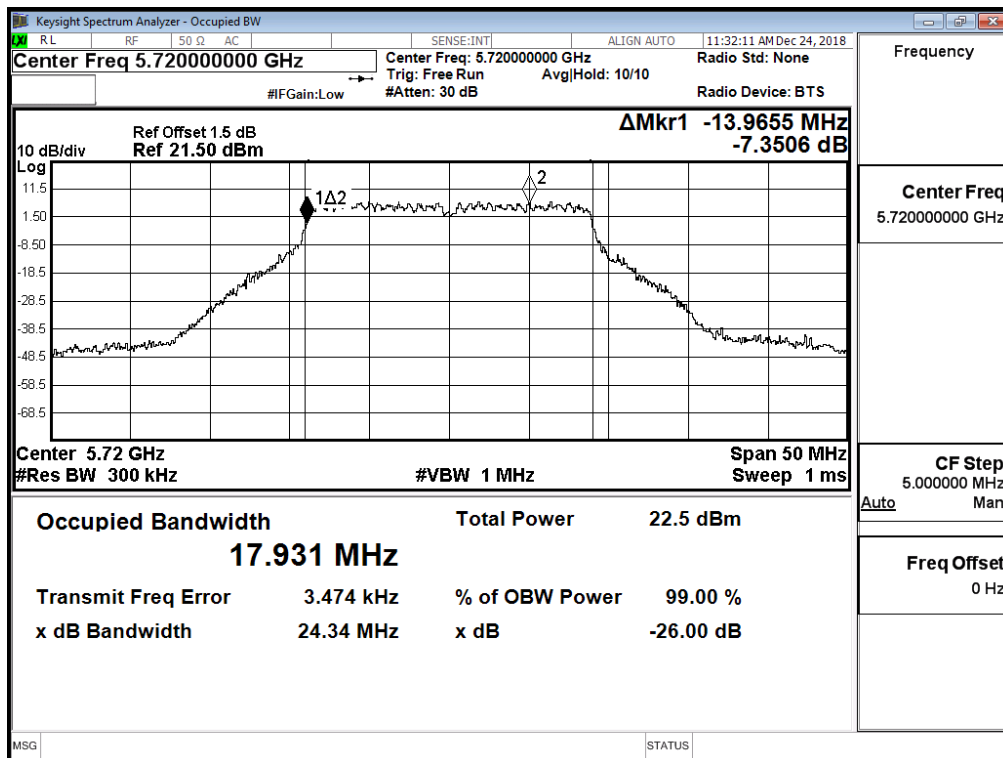



**Maximum conducted output power:  
Channel 144 (U-NII-2C) – Chain A**

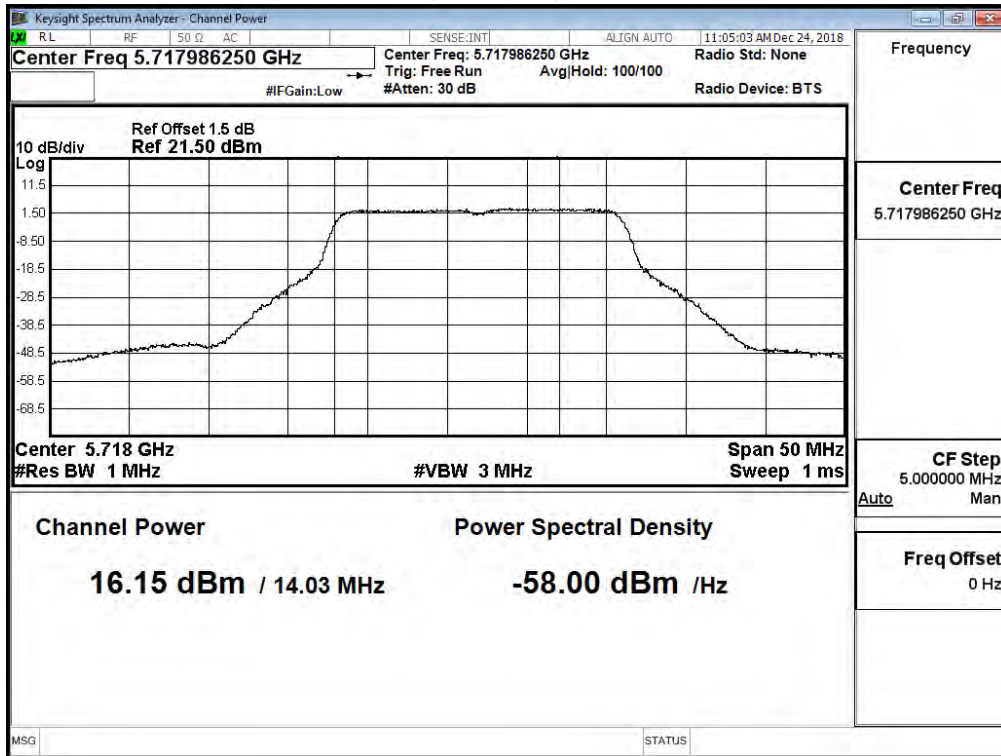

**Channel 144 (U-NII-3) – Chain A**

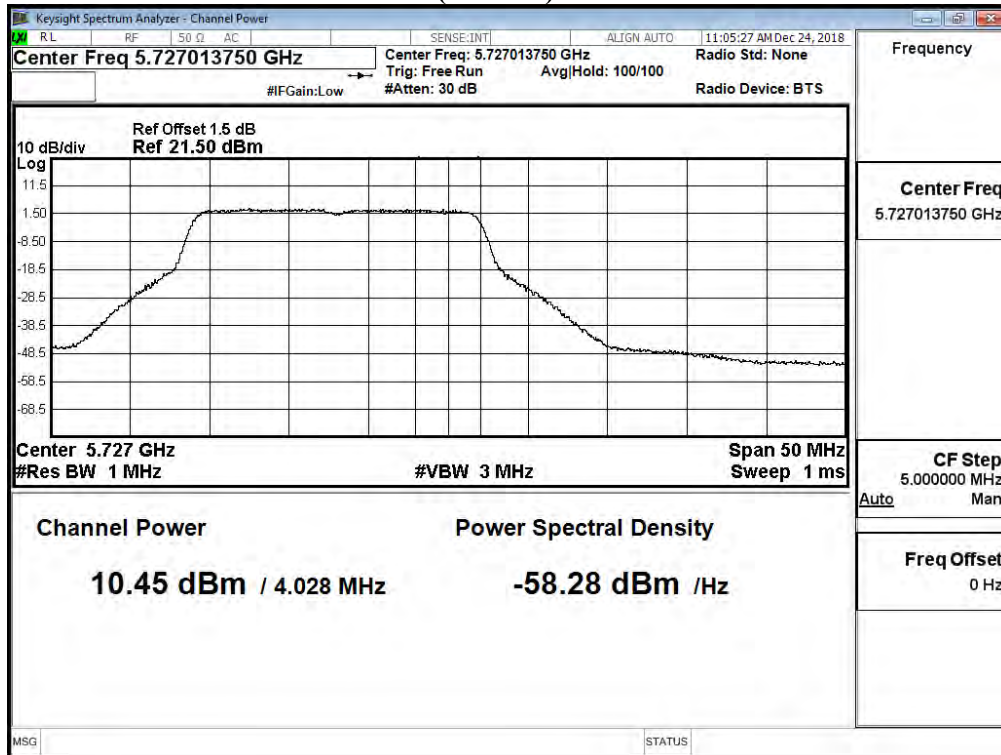

**Maximum conducted output power:  
Channel 144 (U-NII-2C) – Chain B**

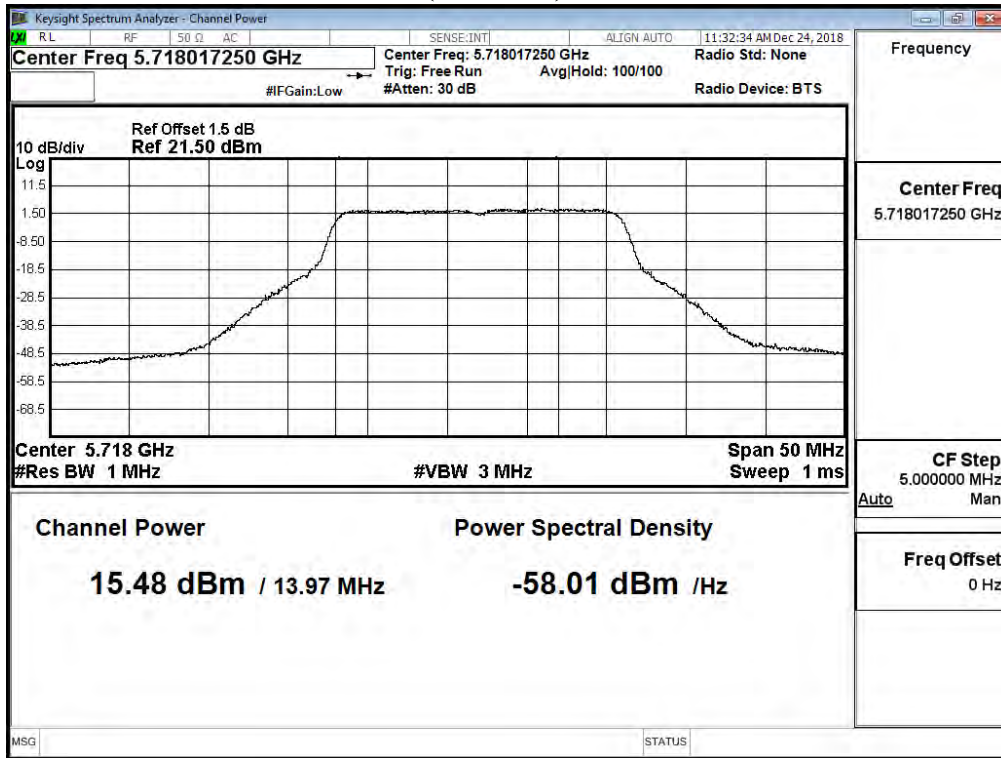

**Channel 144 (U-NII-3) – Chain B**

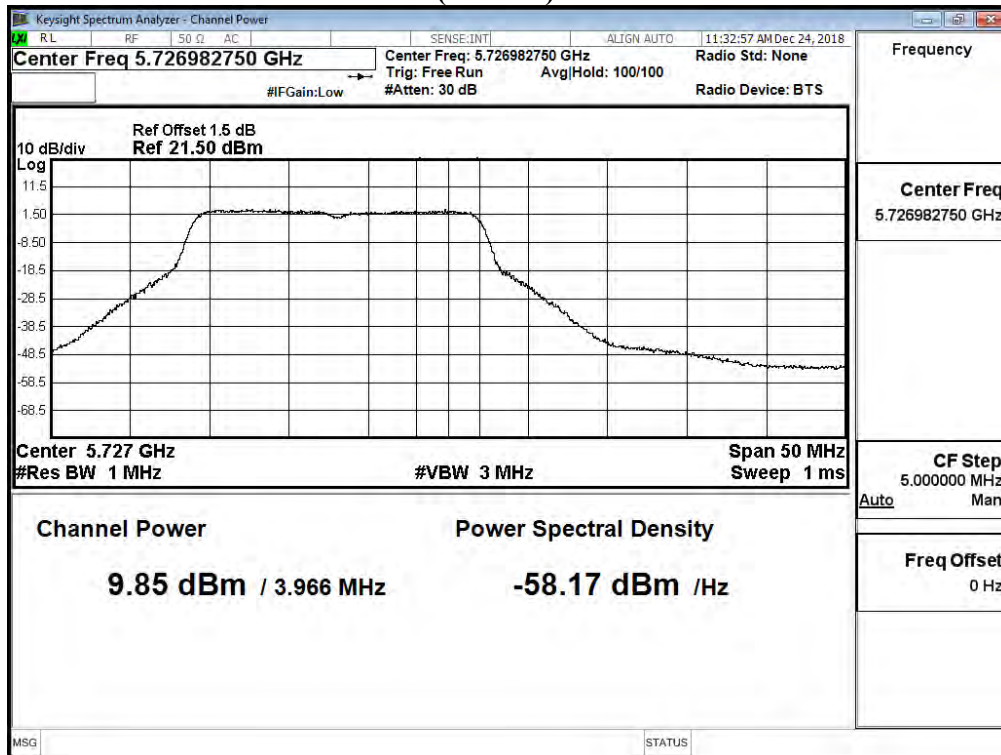

Product : Intel® Wireless-AC 9560  
 Test Item : Maximum conducted output power  
 Test Date : 2019/01/07  
 Test Mode : Mode 3 MIMO: Transmit (802.11ac-40BW\_30Mbps)

**Chain A**

Cable loss=1.5dB		Average Power										Required Limit
Channel No.	Frequency (MHz)	Data Rate (Mbps)										
		VTH0	VTH1	VTH2	VTH3	VTH4	VTH5	VTH6	VTH7	VTH8	VTH9	
		Measurement Level (dBm)										
142 (U-NII-2C)	5710	17.64	17.56	17.49	17.42	17.37	17.31	17.24	17.19	17.13	17.04	<24dBm
142 (U-NII-3)	5710	7.26	7.21	7.14	7.05	7	6.91	6.86	6.76	6.68	6.63	<30dBm

Note: Maximum conducted output power Value =Reading value on Spectrum Analyzer + cable loss

**Chain B**

Cable loss=1.5dB		Average Power										Required Limit
Channel No.	Frequency (MHz)	Data Rate (Mbps)										
		VTH0	VTH1	VTH2	VTH3	VTH4	VTH5	VTH6	VTH7	VTH8	VTH9	
		Measurement Level (dBm)										
142 (U-NII-2C)	5710	17.18	17.08	16.99	16.93	16.85	16.79	16.7	16.62	16.55	16.47	<24dBm
142 (U-NII-3)	5710	7.17	7.12	7.07	7.02	6.94	6.84	6.77	6.72	6.63	6.54	<30dBm

Note: Maximum conducted output power Value =Reading value on Spectrum Analyzer + cable loss

**Maximum conducted output power Measurement:**

Channel No	Frequency Range (MHz)	99% Bandwidth (MHz)	Chain A Power (dBm)	Chain B Power (dBm)	Output Power (dBm)	Output Power Limit		Result
						(dBm)	dBm+10log(BW)	
142(U-NII-2C)	5710	33.205	17.64	17.18	20.43	24	26.21	Pass
142(U-NII-3)	5710	--	7.26	7.17	10.23	30	--	Pass

Note:

- Output Power (dBm) = 10LOG (Chain A Power (mW)+ Chain B Power (mW))
- 99% Bandwidth is the bandwidth of chain A or chain B whichever is less bandwidth, output power limitation is more stringent.

**99% Occupied Bandwidth:  
Channel 142 – Chain A**

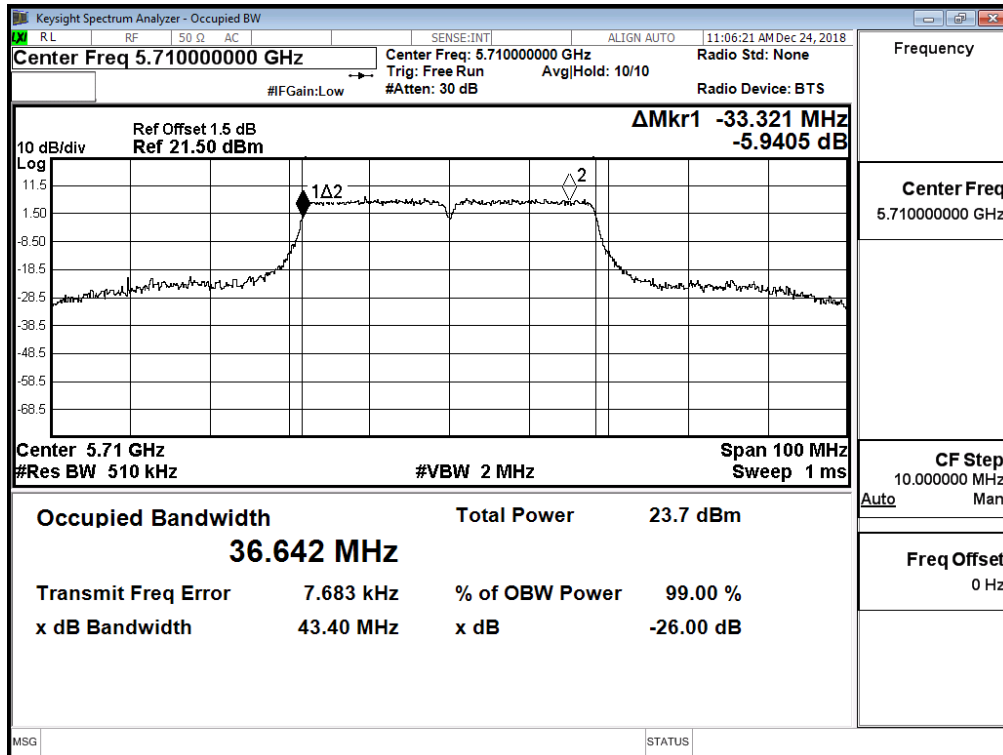

**99% Occupied Bandwidth:  
Channel 142 – Chain B**

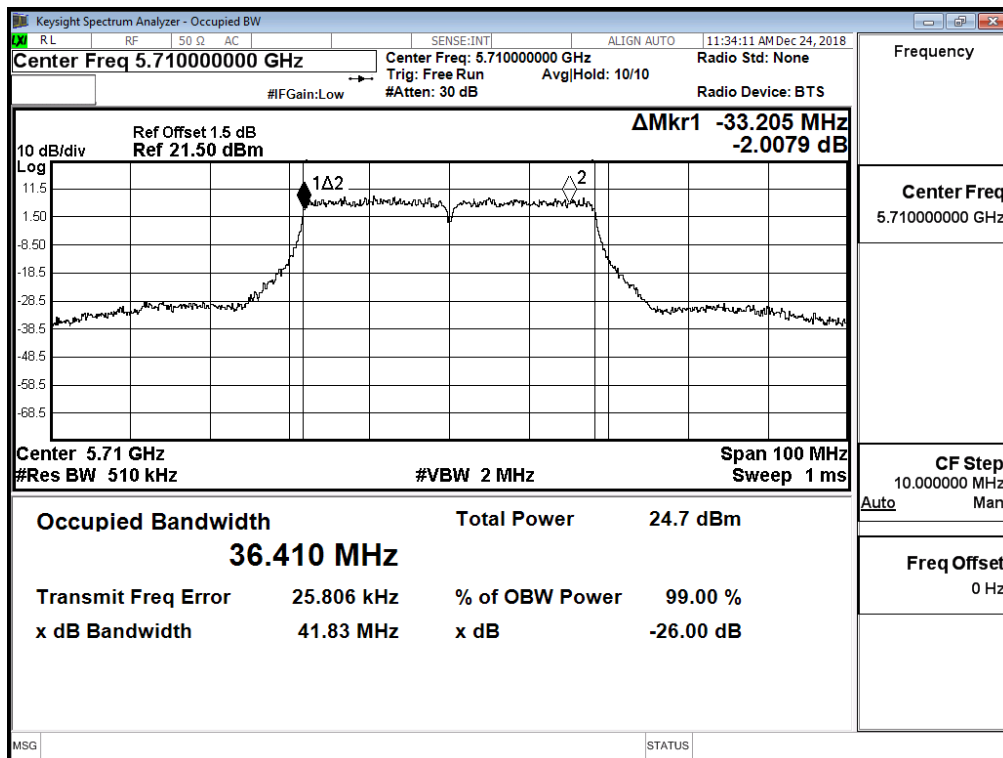

**Maximum conducted output power:  
Channel 142 (U-NII-2C) – Chain A**

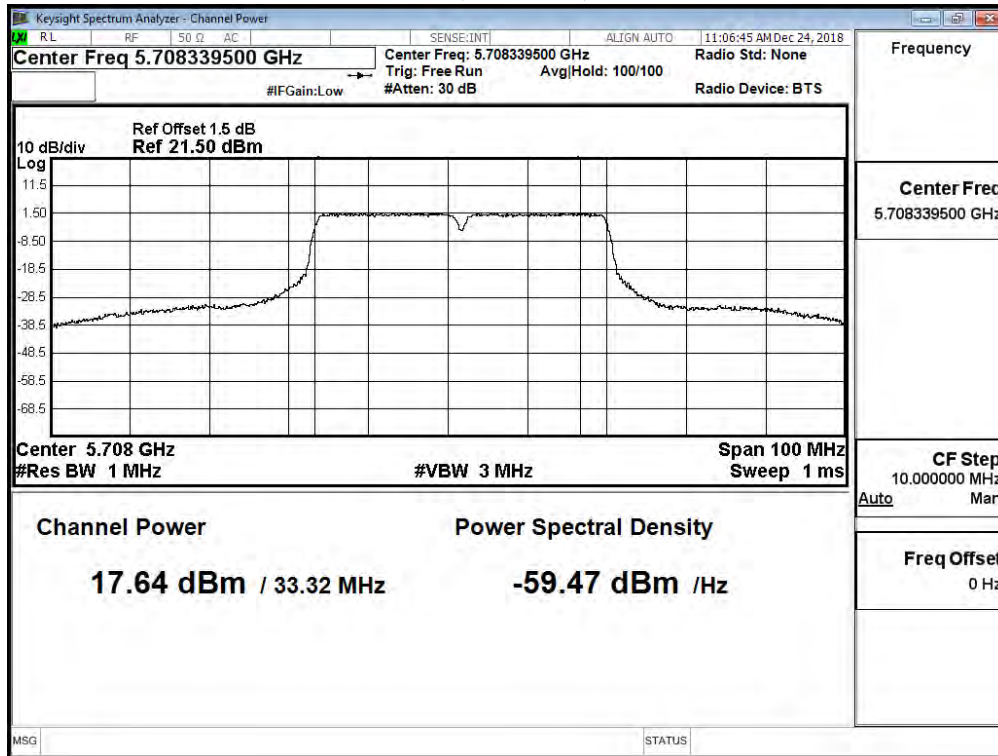

**Channel 142 (U-NII-3) – Chain A**

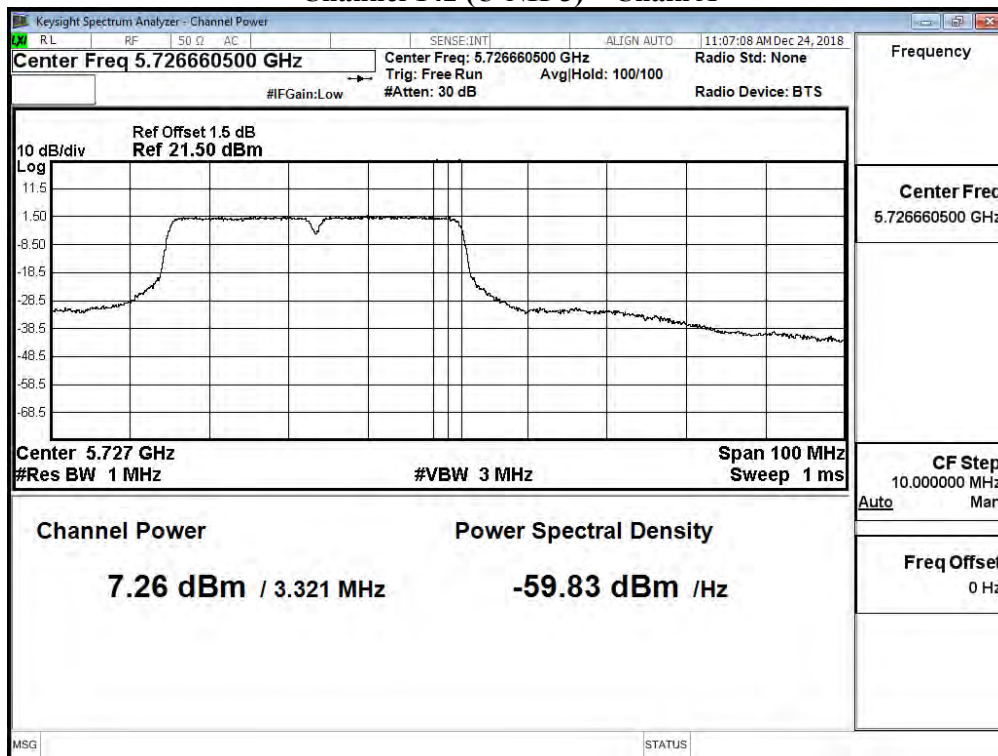

**Maximum conducted output power:  
Channel 142 (U-NII-2C) – Chain B**

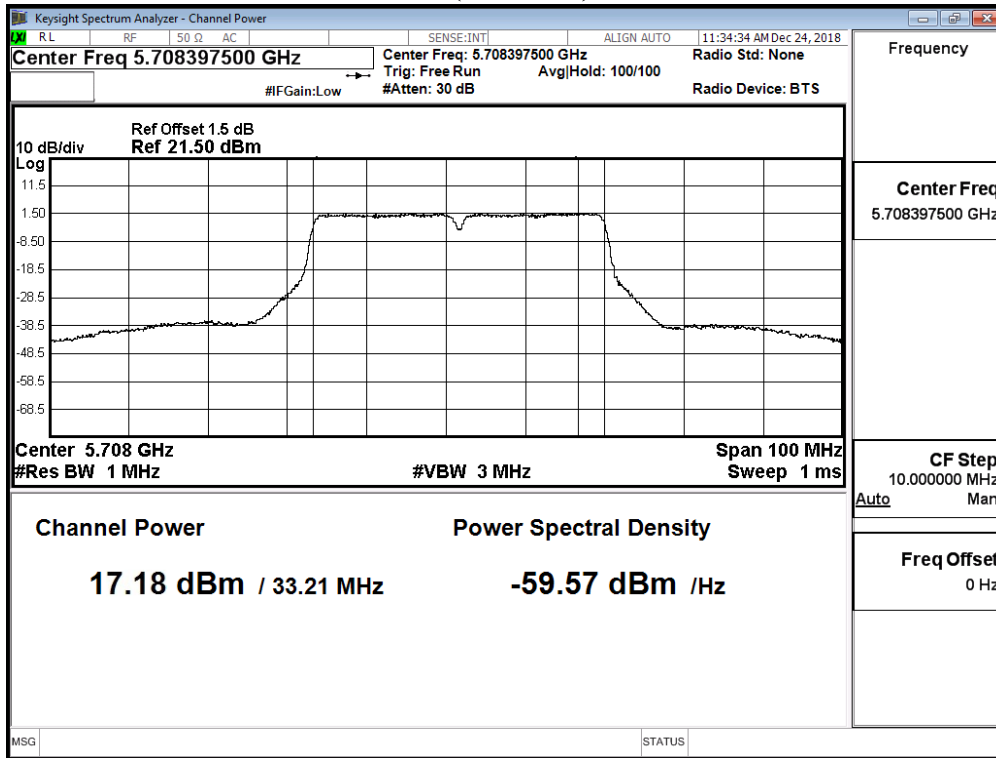

**Channel 142 (U-NII-3) – Chain B**

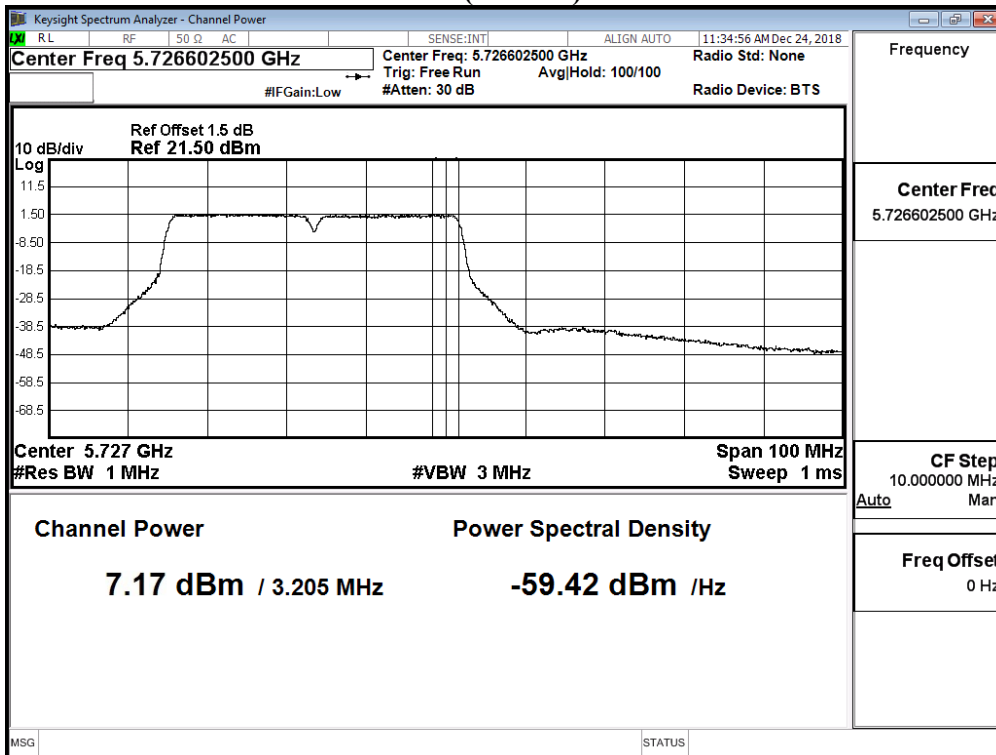

Product : Intel® Wireless-AC 9560  
 Test Item : Maximum conducted output power  
 Test Date : 2019/01/07  
 Test Mode : Mode 3 MIMO: Transmit (802.11ac-80BW\_65Mbps)

**Chain A**

Cable loss=1.5dB		Average Power										
Channel No	Frequency (MHz)	Data Rate (Mbps)										Required Limit
		VTH0	VTH1	VTH2	VTH3	VTH4	VTH5	VTH6	VTH7	VTH8	VTH9	
42	5210	12.57	12.52	12.46	12.37	12.27	12.22	12.16	12.08	12.02	11.95	<24dBm
58	5290	11.52	11.42	11.32	11.27	11.22	11.13	11.08	10.99	10.93	10.83	<24dBm
106	5530	14.18	--	--	--	--	--	--	--	--	--	<24dBm
122	5610	17.60	17.54	17.49	17.42	17.36	17.28	17.21	17.12	17.02	16.95	<24dBm
138(U-NII-2C)	5690	17.95	--	--	--	--	--	--	--	--	--	<24dBm
138(U-NII-3)	5690	0.41	--	--	--	--	--	--	--	--	--	<30dBm
155	5775	16.71	16.64	16.54	16.45	16.37	16.27	16.20	16.11	16.01	15.95	<30dBm

Note: Maximum conducted output power Value =Reading value on Spectrum Analyzer + cable loss

**Chain B**

Cable loss=1.5dB		Average Power										
Channel No	Frequency (MHz)	Data Rate (Mbps)										Required Limit
		VTH0	VTH1	VTH2	VTH3	VTH4	VTH5	VTH6	VTH7	VTH8	VTH9	
42	5210	12.59	12.51	12.45	12.37	12.27	12.20	12.11	12.01	11.94	11.84	<24dBm
58	5290	11.63	11.58	11.50	11.41	11.33	11.26	11.18	11.09	11.04	10.97	<24dBm
106	5530	13.99	--	--	--	--	--	--	--	--	--	<24dBm
122	5610	17.66	17.6	17.55	17.47	17.39	17.34	17.28	17.2	17.1	17.01	<24dBm
138(U-NII-2C)	5690	17.32	--	--	--	--	--	--	--	--	--	<24dBm
138(U-NII-3)	5690	-0.19	--	--	--	--	--	--	--	--	--	<30dBm
155	5775	16.70	16.60	16.50	16.40	16.32	16.26	16.18	16.08	16.00	15.94	<30dBm

Note: Maximum conducted output power Value =Reading value on Spectrum Analyzer + cable loss

**Maximum conducted output power Measurement:**

Channel No	Frequency Range (MHz)	99% Bandwidth (MHz)	Chain A Power (dBm)	Chain B Power (dBm)	Output Power (dBm)	Output Power Limit		Result
						(dBm)	dBm+10log(BW)	
42	5210	--	12.57	12.59	15.59	24	--	Pass
58	5290	75.155	11.52	11.63	14.59	24	29.76	Pass
106	5530	75.033	14.18	13.99	17.10	24	29.75	Pass
122	5610	75.105	17.60	17.66	20.64	24	29.76	Pass
138(U-NII-2C)	5690	72.527	17.95	17.32	20.66	24	29.60	Pass
138(U-NII-3)	5690	--	0.41	-0.19	3.13	30	--	Pass
155	5775	--	16.71	16.70	19.72	30	--	Pass

**Note:**

1. Output Power (dBm) = 10LOG (Chain A Power (mW)+ Chain B Power (mW))
2. 99% Bandwidth is the bandwidth of chain A or chain B whichever is less bandwidth, output power limitation is more stringent.



**99% Occupied Bandwidth:  
Channel 58 – Chain A**

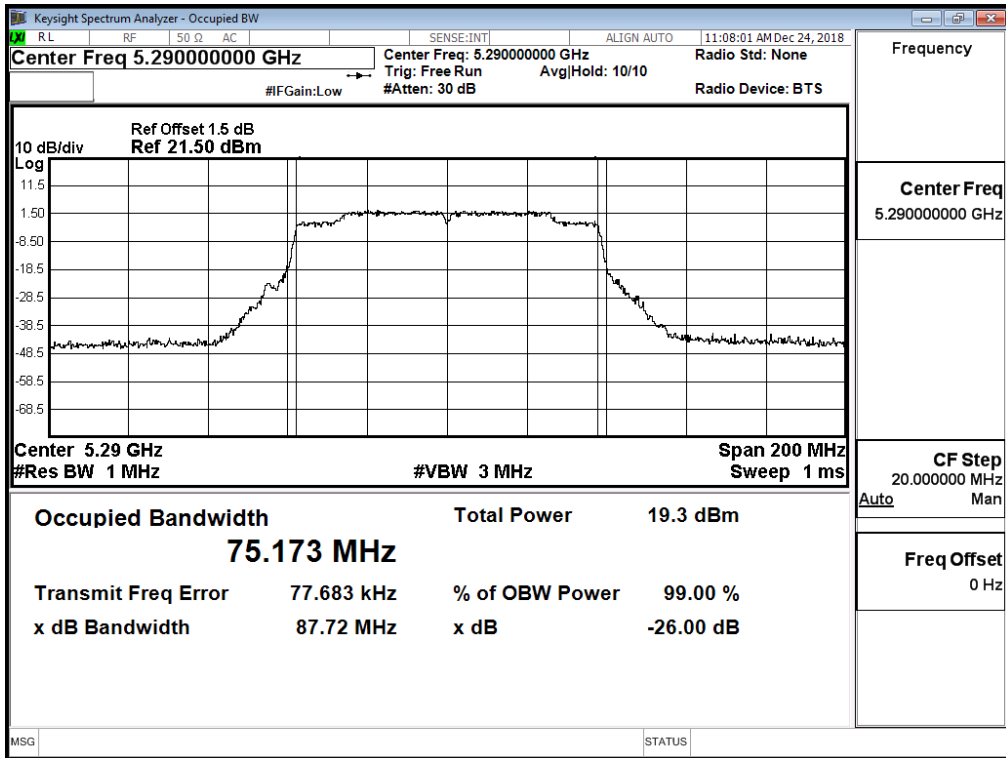

**Channel 106 – Chain A**

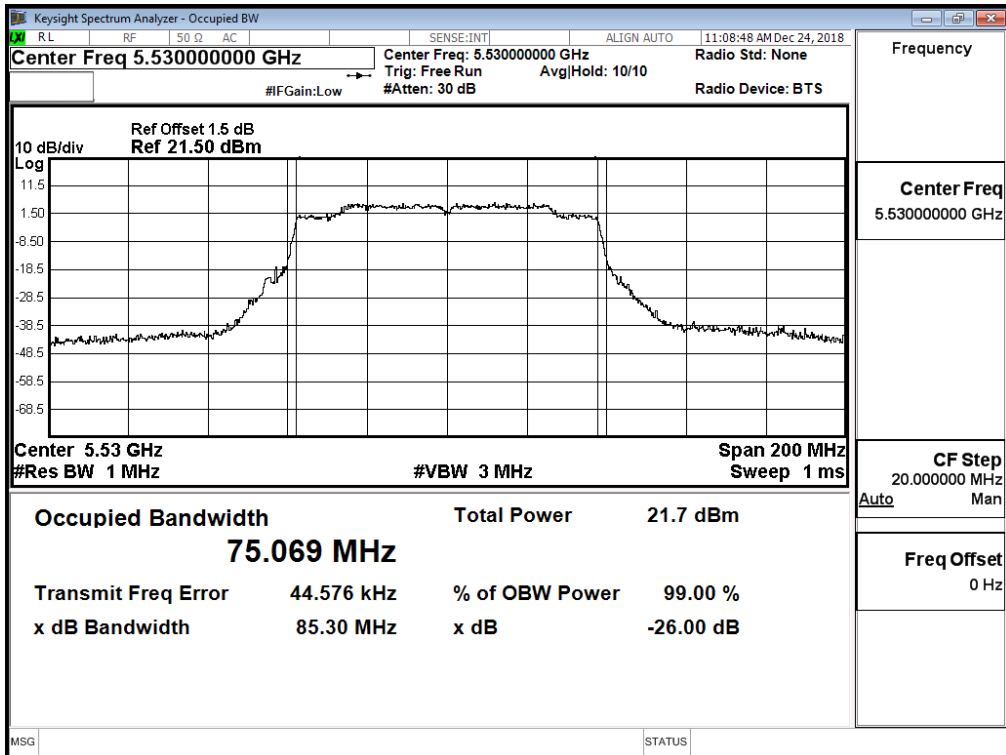

### Channel 122 – Chain A

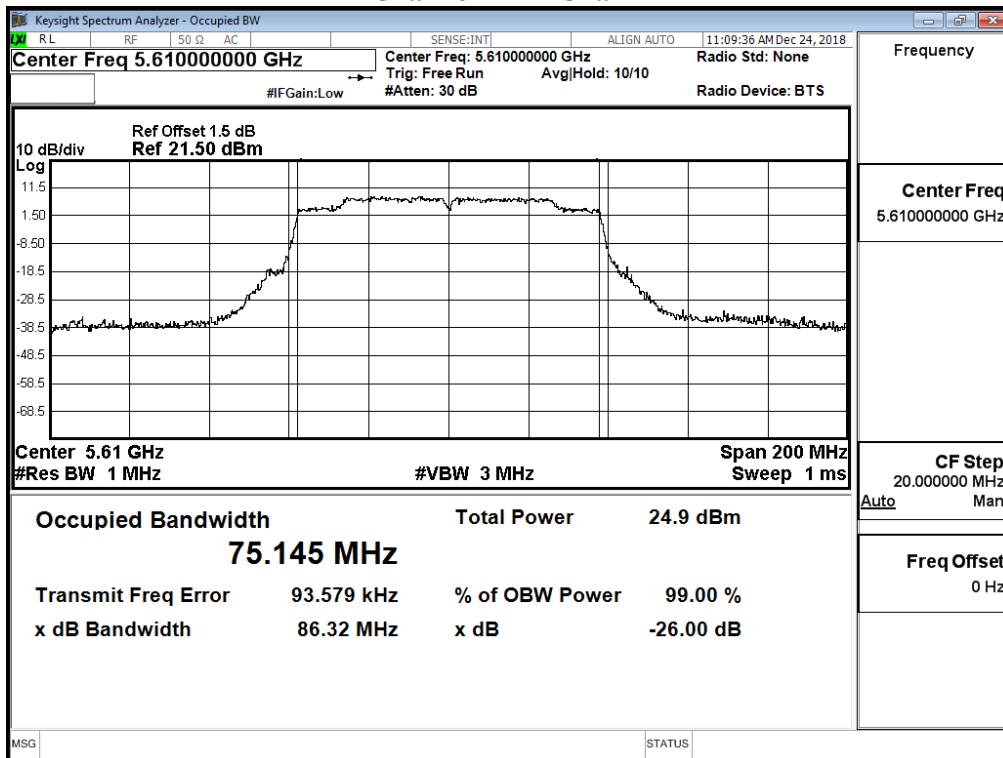

### Channel 138 – Chain A

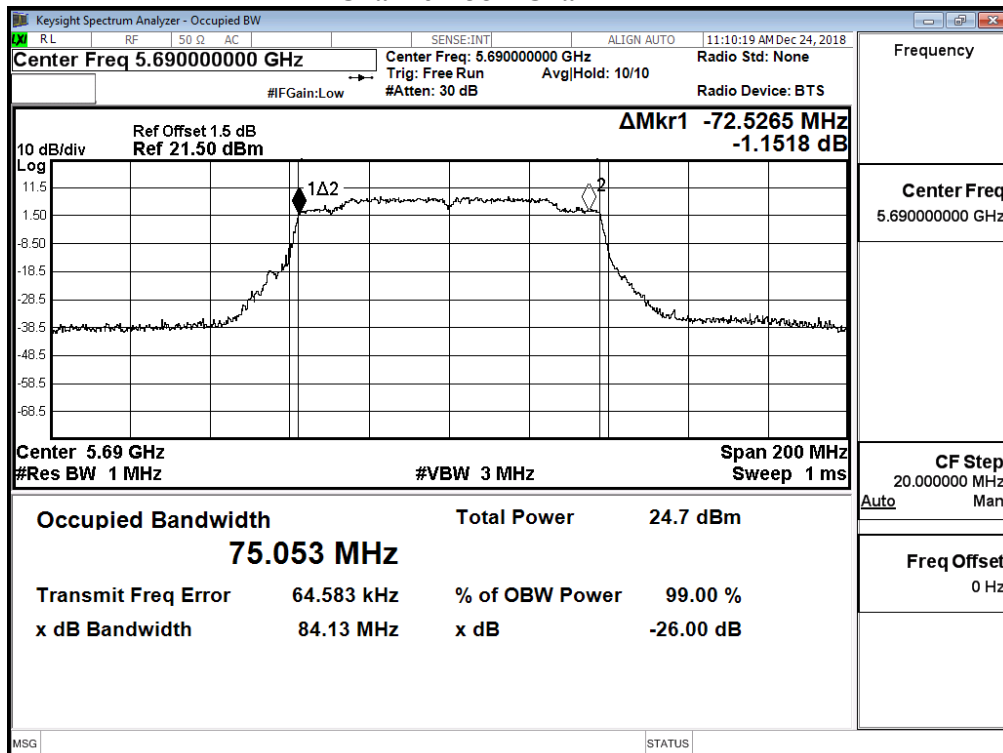

99% Occupied Bandwidth:

Channel 58 – Chain B

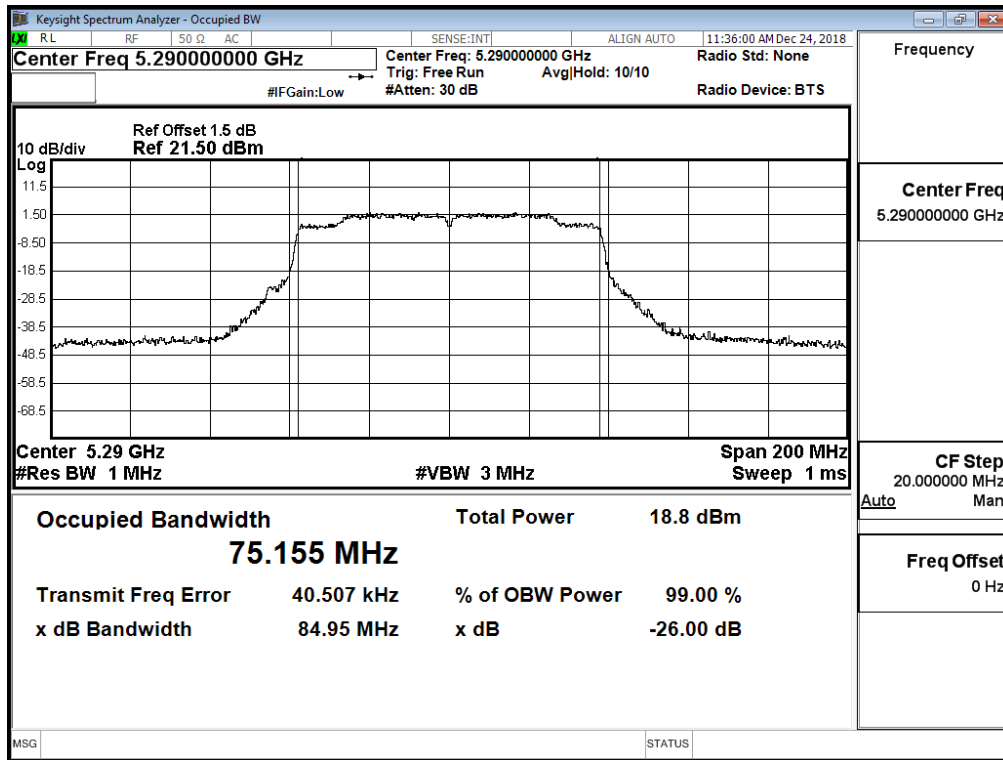

Channel 106 – Chain B

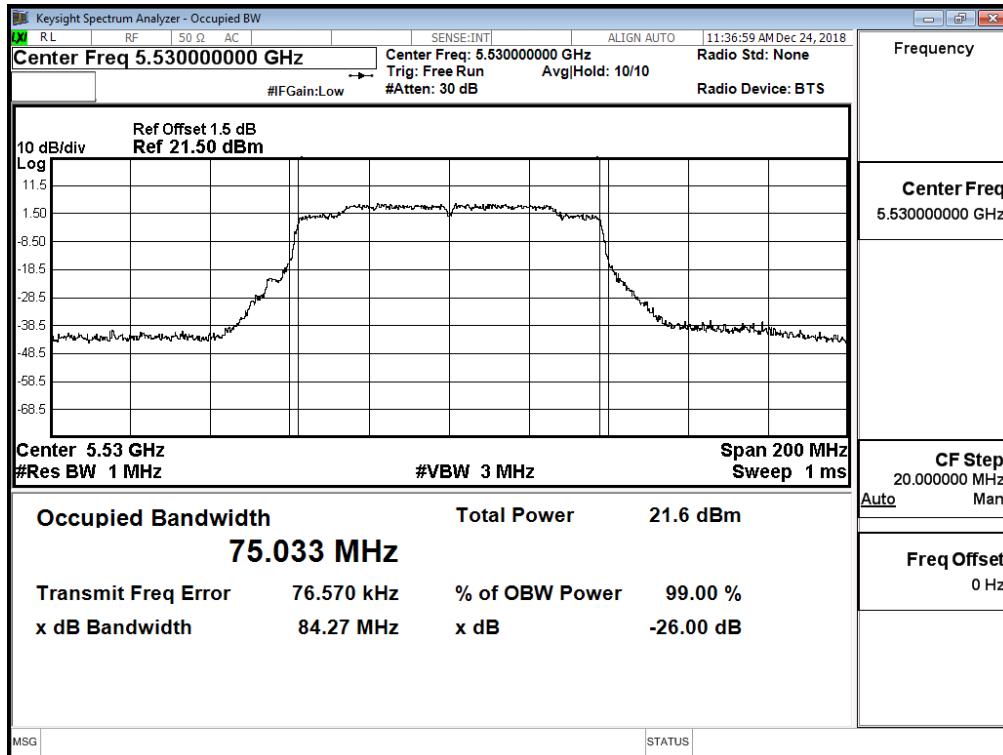

### Channel 122 – Chain B

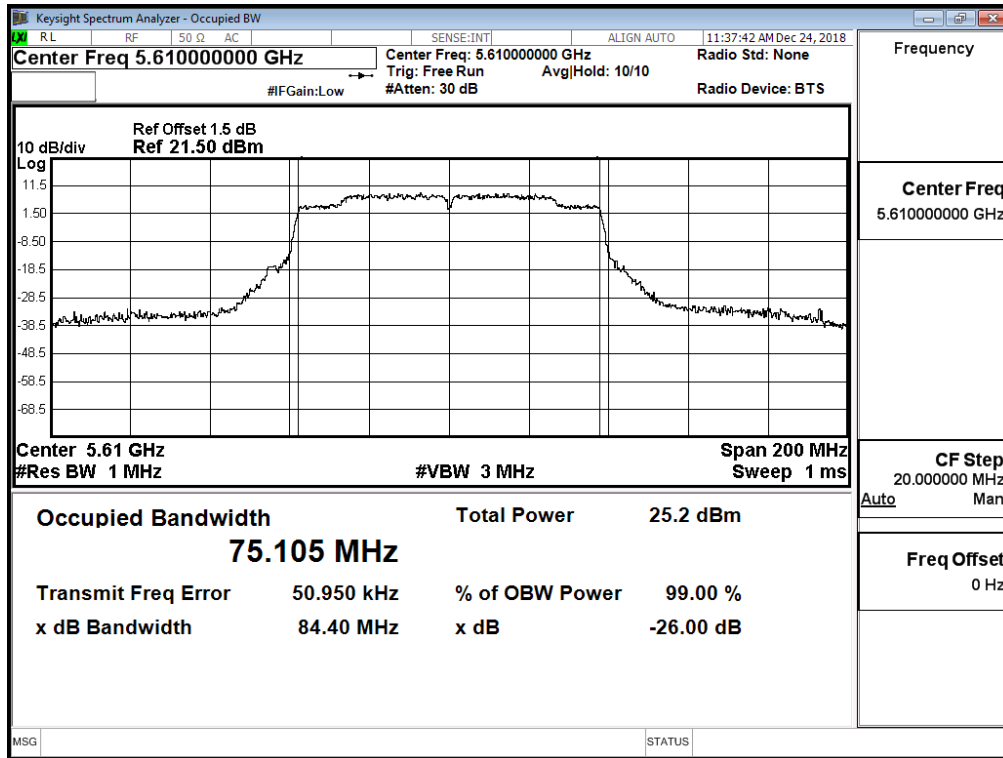

### Channel 138 – Chain B

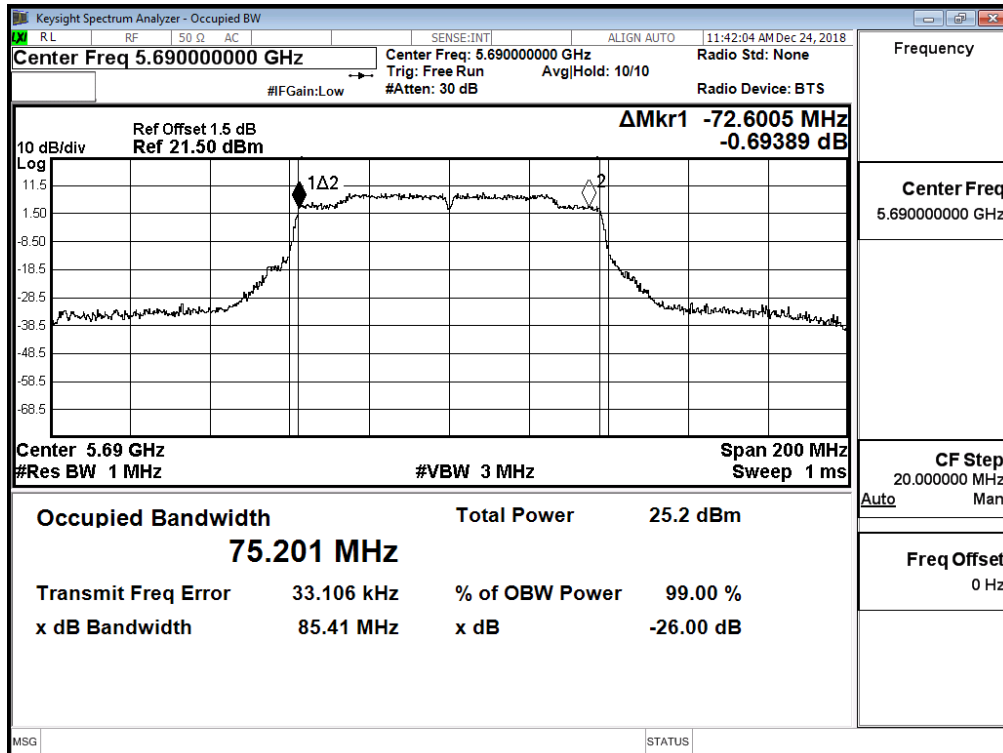

**Maximum conducted output power:  
Channel 138 (U-NII-2C) – Chain A**

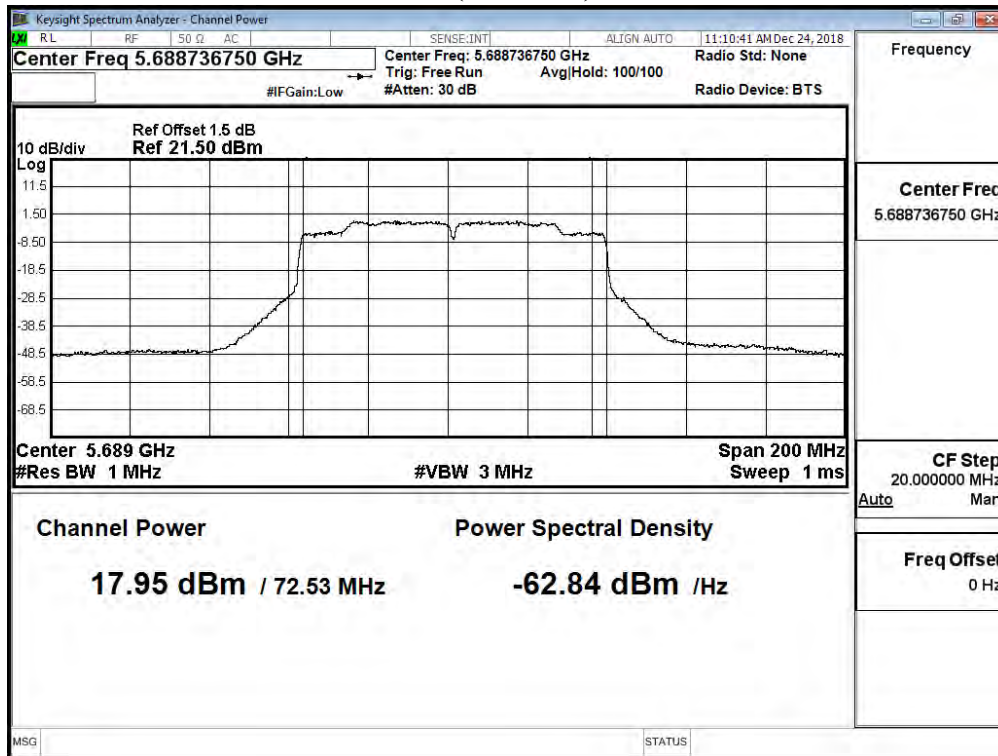

**Maximum conducted output power:  
Channel 138 (U-NII-3) – Chain A**

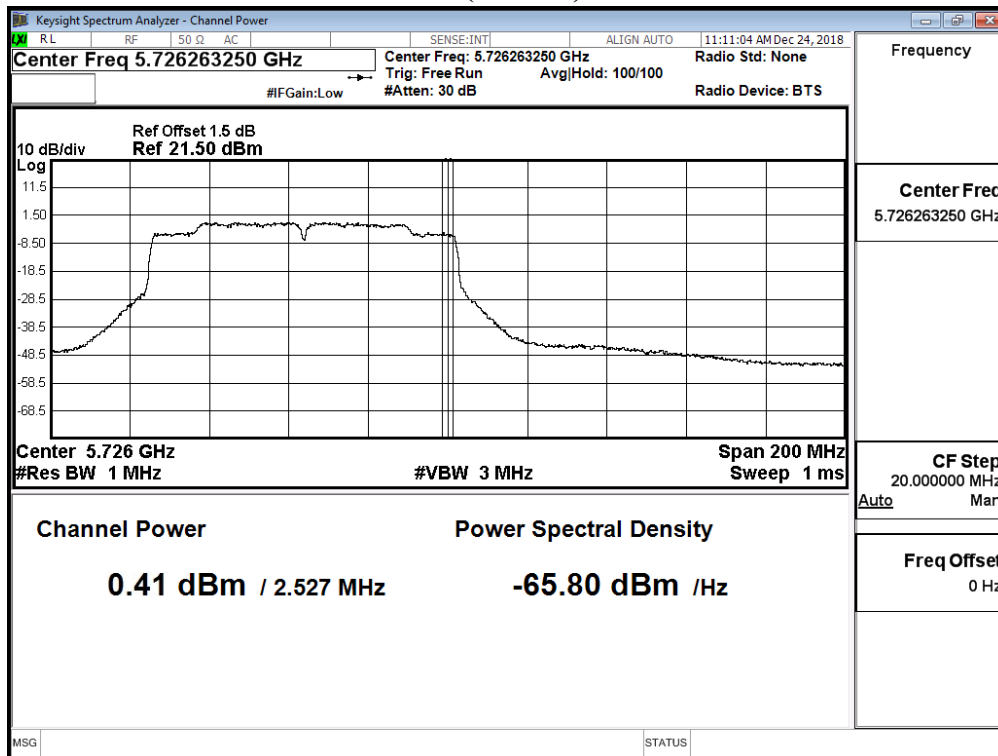

**Maximum conducted output power:  
Channel 138 (U-NII-2C)–Chain B**

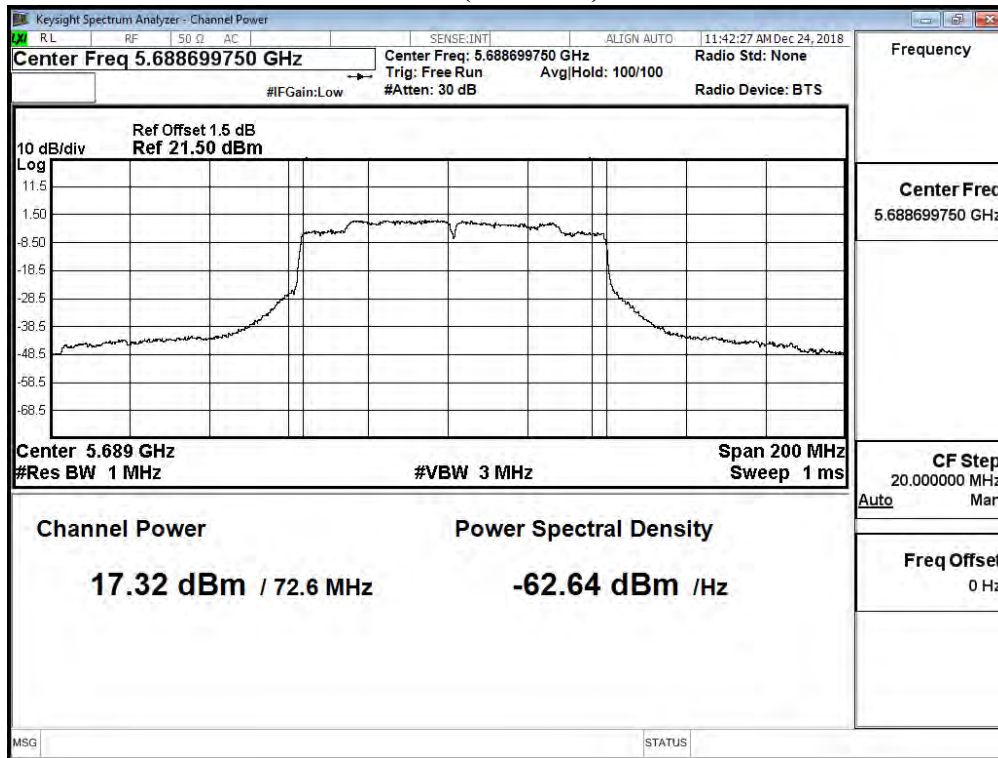

**Maximum conducted output power:  
Channel 138 (U-NII-3)–Chain B**

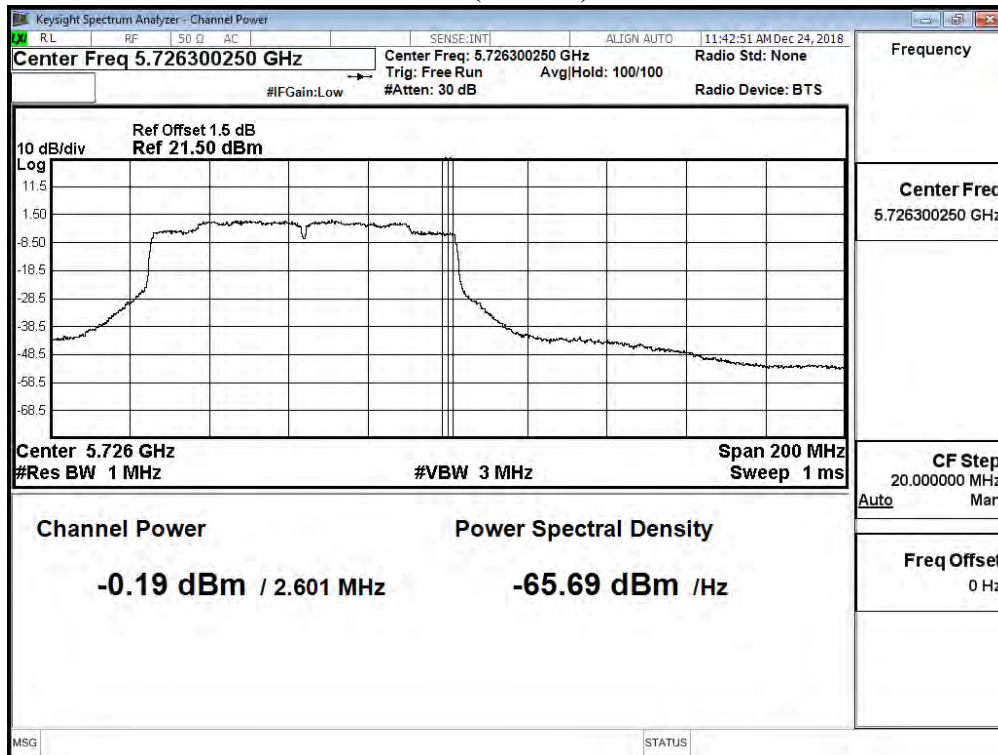

Product : Intel® Wireless-AC 9560  
 Test Item : Maximum conducted output power  
 Test Date : 2019/01/07  
 Test Mode : Mode 3 MIMO: Transmit (802.11ac-160BW\_130Mbps)

**Chain A**

Cable loss=1.5dB		Average Power										
Channel No	Frequency (MHz)	Data Rate (Mbps)										Required Limit
		VTH0	VTH1	VTH2	VTH3	VTH4	VTH5	VTH6	VTH7	VTH8	VTH9	
50(U-NII-1)	5250	7.95	7.88	7.81	7.71	7.66	7.58	7.49	7.42	7.35	7.29	<24dBm
50(U-NII-2A)	5250	8.12	8.03	7.98	7.90	7.81	7.72	7.67	7.60	7.51	7.43	<24dBm
114	5570	12.63	12.57	12.48	12.39	12.33	12.28	12.22	12.16	12.09	12.03	<24dBm

Note: Maximum conducted output power Value =Reading value on Spectrum Analyzer + cable loss

**Chain B**

Cable loss=1.5dB		Average Power										
Channel No	Frequency (MHz)	Data Rate (Mbps)										Required Limit
		VTH0	VTH1	VTH2	VTH3	VTH4	VTH5	VTH6	VTH7	VTH8	VTH9	
50(U-NII-1)	5250	7.28	7.19	7.14	7.08	7.01	6.96	6.91	6.82	6.74	6.64	<24dBm
50(U-NII-2A)	5250	7.56	7.48	7.43	7.33	7.28	7.19	7.13	7.03	6.96	6.90	<24dBm
114	5570	12.66	12.57	12.47	12.37	12.27	12.21	12.12	12.04	11.95	11.89	<24dBm

Note: Maximum conducted output power Value =Reading value on Spectrum Analyzer + cable loss

**Maximum conducted output power Measurement:**

Channel No	Frequency Range (MHz)	99% Bandwidth (MHz)	Chain A Power (dBm)	Chain B Power (dBm)	Output Power (dBm)	Output Power Limit		Result
						(dBm)	dBm+10log(BW)	
50(U-NII-1)	5250	--	7.95	7.28	10.64	24	--	Pass
50(U-NII-2A)	5250	76.460	8.12	7.56	10.86	24	29.83	Pass
114	5570	153.230	12.63	12.66	15.66	24	32.85	Pass

Note:

1. Output Power (dBm) = 10LOG (Chain A Power (mW)+ Chain B Power (mW))
2. 99% Bandwidth is the bandwidth of chain A or chain B whichever is less bandwidth, output power limitation is more stringent.

**99% Occupied Bandwidth:  
Channel 50 – Chain A**

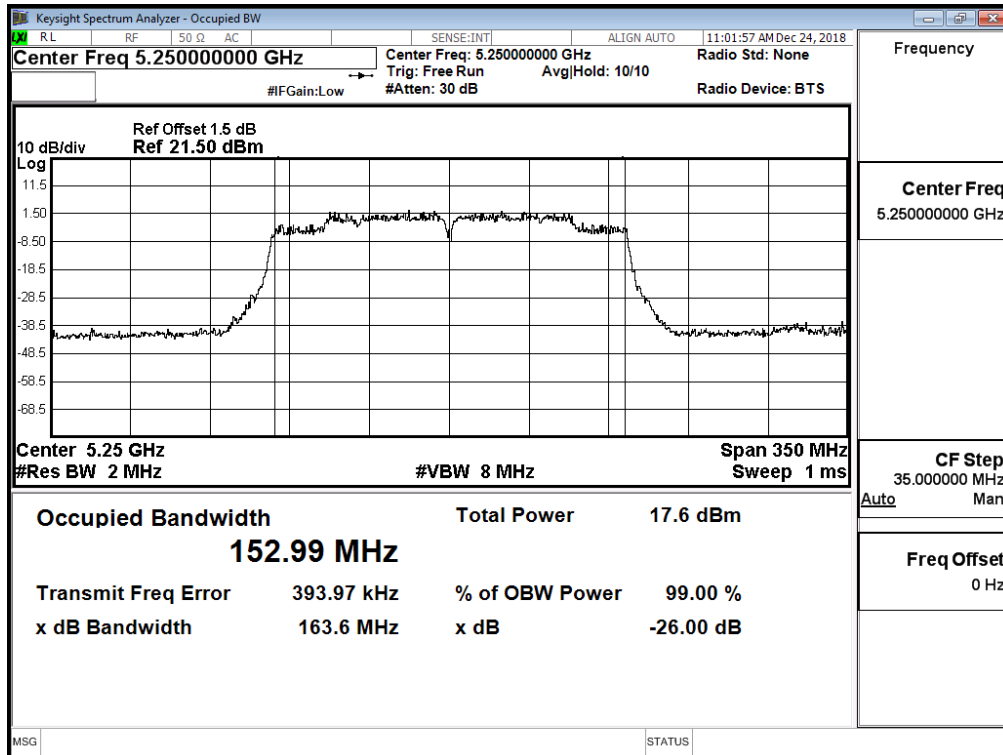

**Channel 114 – Chain A**

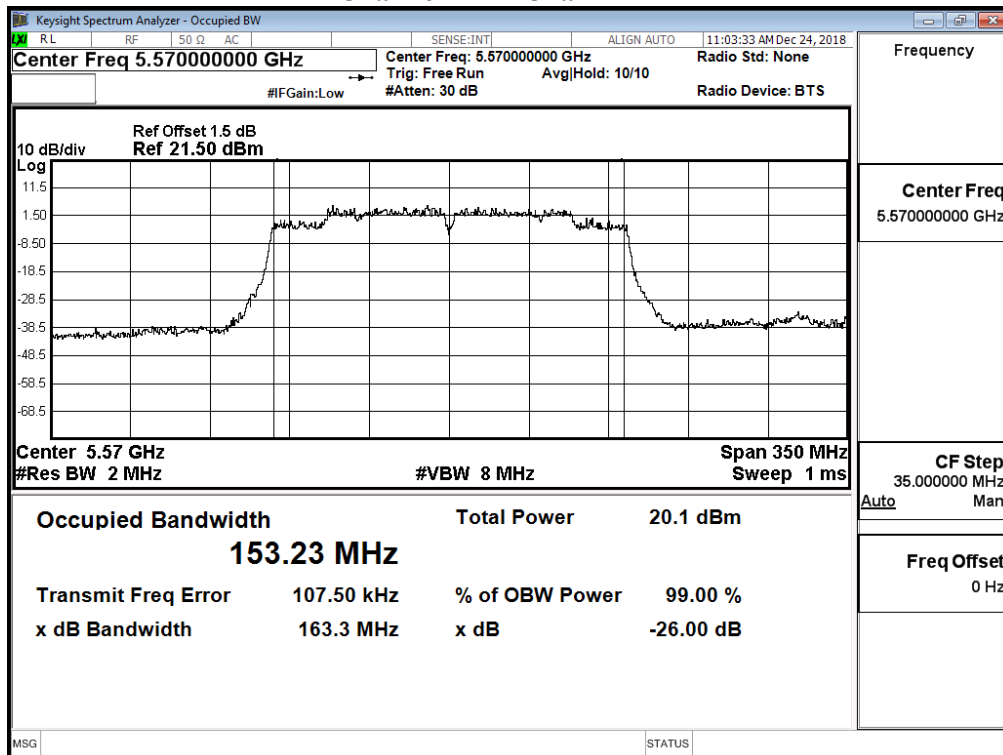



**99% Occupied Bandwidth:  
Channel 50 – Chain B**

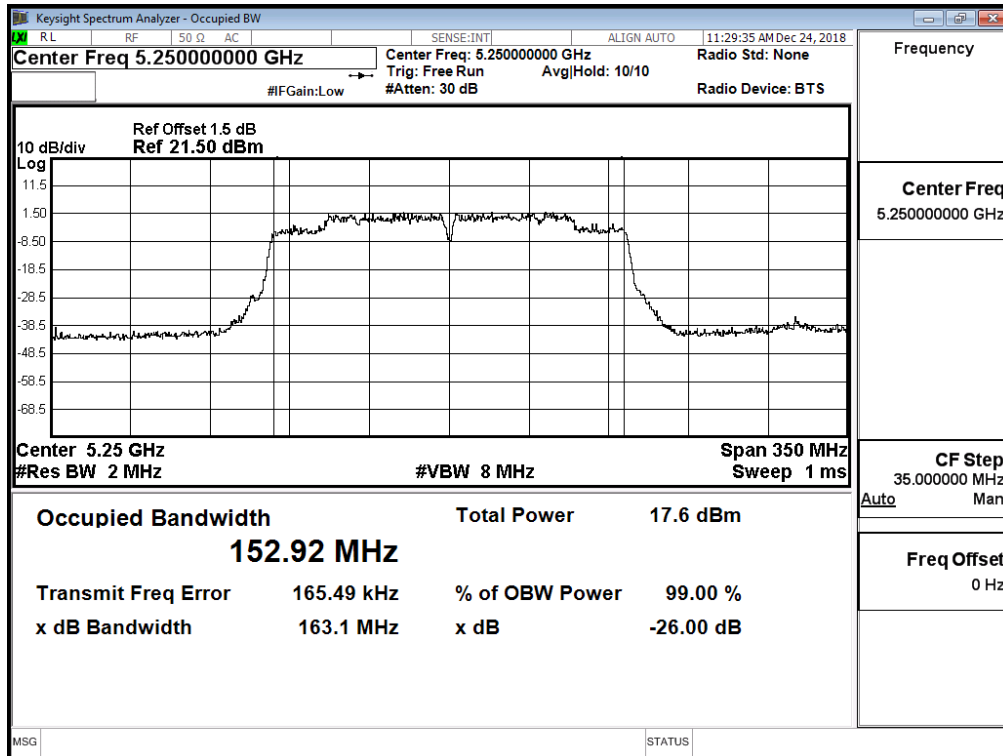

**Channel 114 – Chain B**

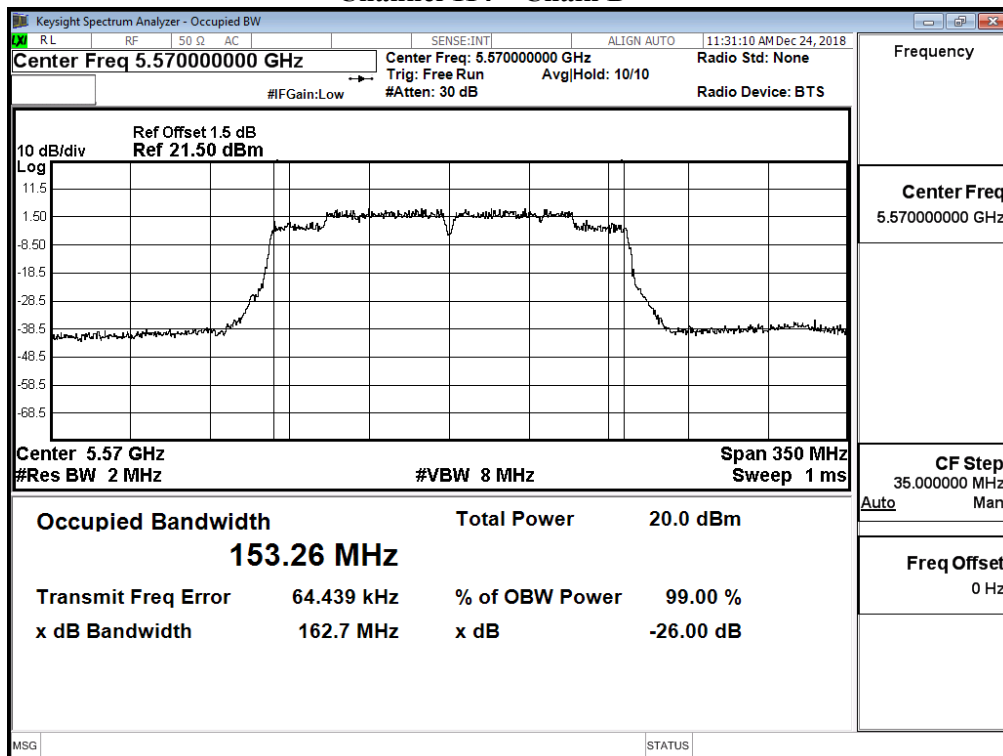

**Maximum conducted output power:**

**Channel 50 (U-NII-1) – Chain A**

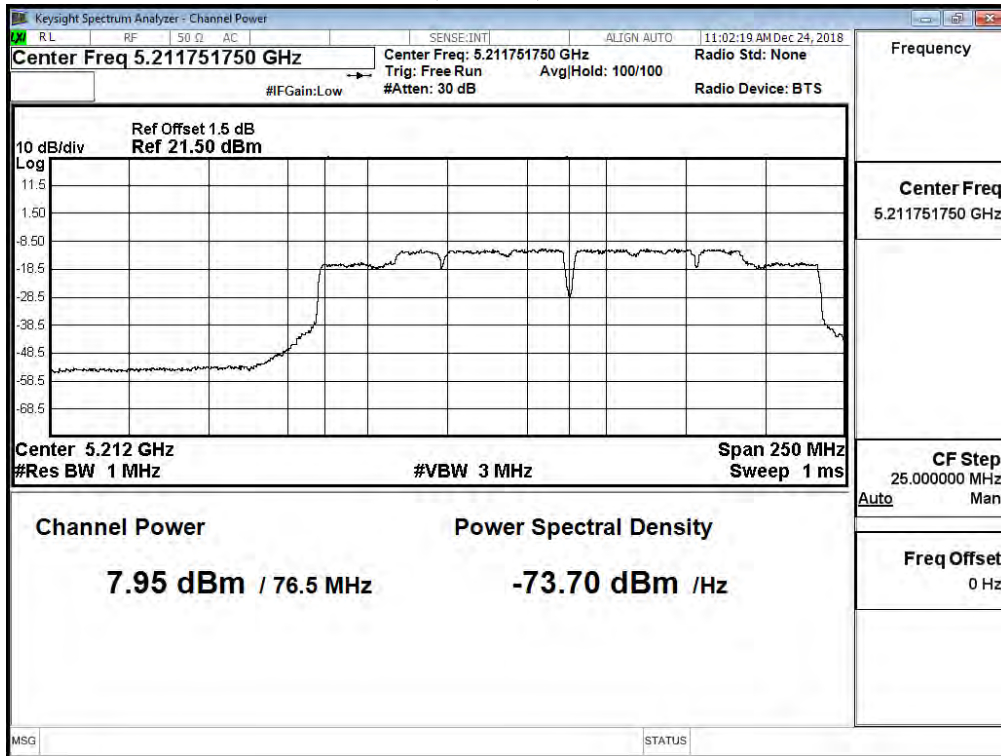

**Maximum conducted output power:**

**Channel 50 (U-NII-2A) – Chain A**

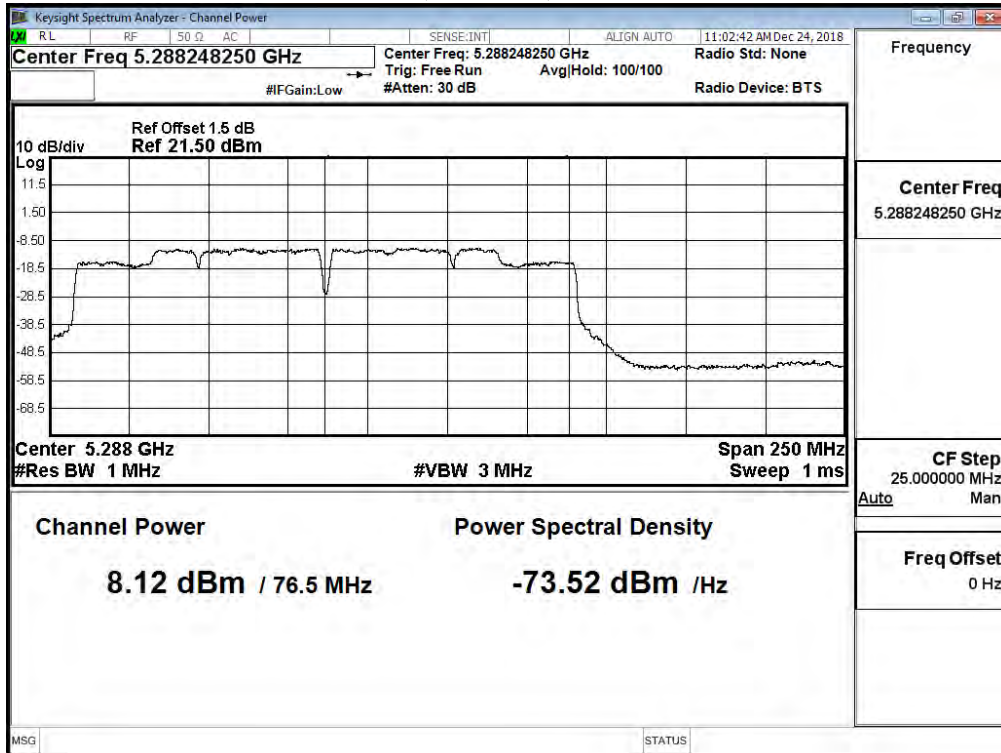

**Maximum conducted output power:  
Channel 50 (U-NII-1) – Chain B**

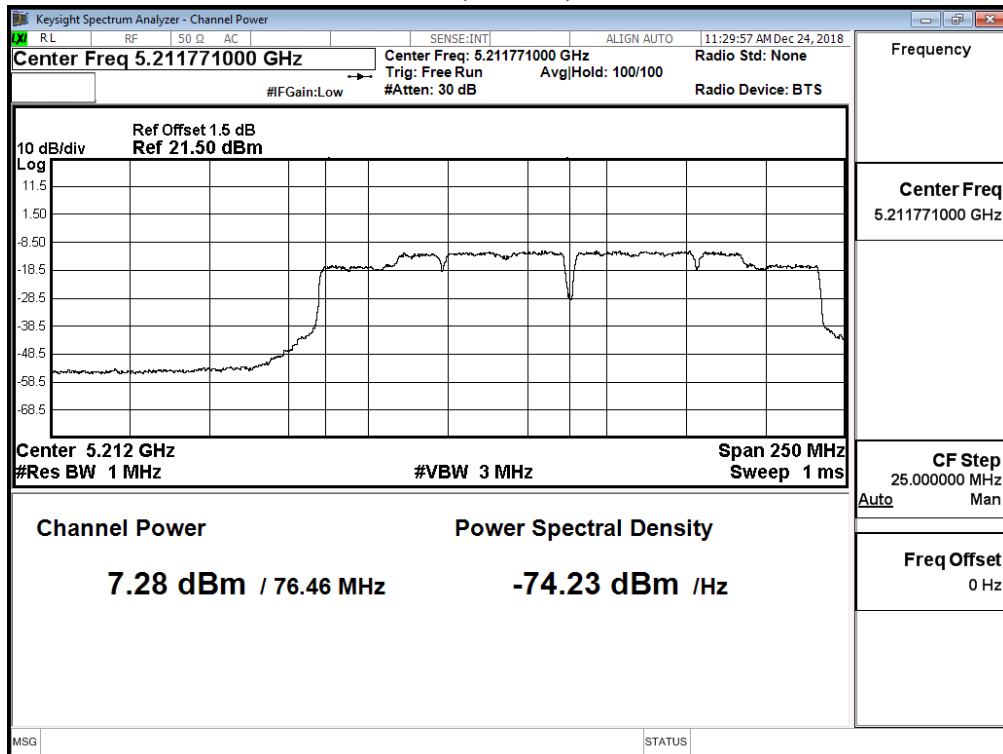

**Maximum conducted output power:  
Channel 50 (U-NII-2A) – Chain B**

