



RADIO TEST REPORT

Test Report No. : 12160939H-A-R1

Applicant : Oki Electric Industry Co., Ltd.
Type of Equipment : MH920-MOD-F
Model No. : MH920-MOD-F
FCC ID : 2AKGW-1TD3016A2
Test regulation : FCC Part 15 Subpart C: 2018
Test Result : Complied

1. This test report shall not be reproduced in full or partial, without the written approval of UL Japan, Inc.
2. The results in this report apply only to the sample tested.
3. This sample tested is in compliance with the above regulation.
4. The test results in this report are traceable to the national or international standards.
5. This test report must not be used by the customer to claim product certification, approval, or endorsement by NVLAP, NIST, or any agency of the Federal Government.
6. This test report covers Radio technical requirements. It does not cover administrative issues such as Manual or non-Radio test related Requirements. (if applicable)
7. This report is a revised version of 12160939H-A. 12160939H-A is replaced with this report.

Date of test: February 9 to 28, 2018

Representative test engineer:

K. Yamamoto

Koji Yamamoto
Engineer
Consumer Technology Division

Approved by:

T. Takayama

Tsubasa Takayama
Leader
Consumer Technology Division



NVLAP LAB CODE: 200572-0

This laboratory is accredited by the NVLAP LAB CODE 200572-0, U.S.A. The tests reported herein have been performed in accordance with its terms of accreditation.

*As for the range of Accreditation in NVLAP, you may refer to the WEB address,

http://japan.ul.com/resources/emc_accredited/

UL Japan, Inc.

Ise EMC Lab.

4383-326 Asama-cho, Ise-shi, Mie-ken 516-0021 JAPAN

Telephone : +81 596 24 8999

Facsimile : +81 596 24 8124

13-EM-F0429

REVISION HISTORY

Original Test Report No.: 12160939H-A

Revision	Test report No.	Date	Page revised	Contents
- (Original)	12160939H-A	March 14, 2018	-	-
1	12160939H-A-R1	April 10, 2018	P.8	Correction of note sentence in Clause 4.1.
1	12160939H-A-R1	April 10, 2018	P.9	Correction of note sentence in Clause 4.2.
1	12160939H-A-R1	April 10, 2018	P.10	Correction of Configuration and peripherals in Clause 4.2.

UL Japan, Inc.

Ise EMC Lab.

4383-326 Asama-cho, Ise-shi, Mie-ken 516-0021 JAPAN
Telephone : +81 596 24 8999
Facsimile : +81 596 24 8124

CONTENTS	PAGE
SECTION 1: Customer information.....	4
SECTION 2: Equipment under test (E.U.T.).....	4
SECTION 3: Test specification, procedures & results.....	5
SECTION 4: Operation of E.U.T. during testing.....	8
SECTION 5: Conducted Emission.....	11
SECTION 6: Radiated Spurious Emission	12
SECTION 7: Antenna Terminal Conducted Tests.....	13
APPENDIX 1: Test data	14
Conducted Emission	14
6dB Bandwidth	24
99%Occupied Bandwidth	26
Maximum Peak Output Power	27
Average Output Power	28
Radiated Spurious Emission	30
Conducted Spurious Emission	62
Power Density	65
APPENDIX 2: Test instruments	67
APPENDIX 3: Photographs of test setup	69
Conducted Emission	69
Radiated Spurious Emission	72
Worst Case Position	76

SECTION 1: Customer information

Company Name : Oki Electric Industry Co., Ltd.
Address : 1-16-8 Chuou Warabi-shi, Saitama 335-8510 Japan
Telephone Number : +81-48-420-7168
Facsimile Number : +81-48-420-7016
Contact Person : Masahiko Kaneko

SECTION 2: Equipment under test (E.U.T.)

2.1 Identification of E.U.T.

Type of Equipment : MH920-MOD-F
Model No. : MH920-MOD-F
Serial No. : Refer to Section 4, Clause 4.2
Rating : DC 3.3 V
Receipt Date of Sample : February 9, 2018
Country of Mass-production : Japan
Condition of EUT : Engineering prototype
(Not for Sale: This sample is equivalent to mass-produced items.)
Modification of EUT : No Modification by the test lab

2.2 Product Description

Radio Specification

Radio Type : Transceiver
Frequency of Operation : 902.4 MHz - 927.6 MHz
Modulation : GFSK
Antenna type : Pattern antenna (Internal)
Sleeve antenna (External)
 $\lambda/4$ Monopole antenna (External)
Film antenna (External)
Antenna Gain : Pattern antenna (Internal) : -2 dBi
Sleeve antenna (External) : 2dBi
 $\lambda/4$ Monopole antenna (External):0 dBi (including Cable)
Film antenna (External) : 1.4 dBi
Clock frequency : 36 MHz (Crystal)

* The EUT does not transmit simultaneously with each antenna.

SECTION 3: Test specification, procedures & results

3.1 Test Specification

Test Specification : FCC Part 15 Subpart C
FCC Part 15 final revised on February 2, 2018 and effective March 5, 2018

Title : FCC 47CFR Part15 Radio Frequency Device Subpart C Intentional Radiators
Section 15.207 Conducted limits
Section 15.247 Operation within the bands 902-928MHz,
2400-2483.5MHz, and 5725-5850MHz

* The revision on February 2, 2018, does not affect the test specification applied to the EUT.

3.2 Procedures and results

Item	Test Procedure	Specification	Worst margin	Results	Remarks
Conducted Emission	FCC: ANSI C63.10-2013 6. Standard test methods ----- IC: RSS-Gen 8.8	FCC: Section 15.207 ----- IC: RSS-Gen 8.8	QP 28.7 dB, 23.27216 MHz, L AV 24.7 dB, 23.19456 MHz, N 23.27216 MHz, L	Complied	-
6dB Bandwidth	FCC: KDB 558074 D01 DTS Meas Guidance v04 ----- IC: -	FCC: Section 15.247(a)(2) ----- IC: RSS-247 5.2(a)	See data.	Complied	Conducted
Maximum Peak Output Power	FCC: KDB 558074 D01 DTS Meas Guidance v04 ----- IC: RSS-Gen 6.12	FCC: Section 15.247(b)(3) ----- IC: RSS-247 5.4(d)		Complied	Conducted
Power Density	FCC: KDB 558074 D01 DTS Meas Guidance v04 ----- IC: -	FCC: Section 15.247(e) ----- IC: RSS-247 5.2(b)		Complied	Conducted
Spurious Emission Restricted Band Edges	FCC: KDB 558074 D01 DTS Meas Guidance v04 ----- IC: RSS-Gen 6.13	FCC: Section15.247(d) ----- IC: RSS-247 5.5 RSS-Gen 8.9 RSS-Gen 8.10	6.1 dB 902.000 MHz, PK, Horizontal	Complied	Conducted (below 30 MHz)/ Radiated (above 30 MHz) *1)

Note: UL Japan, Inc.'s EMI Work Procedures No. 13-EM-W0420 and 13-EM-W0422.

*1) Radiated test was selected over 30 MHz based on section 15.247(d) and KDB 558074 D01 DTS Meas Guidance v04 12.2.7.

* In case any questions arise about test procedure, ANSI C63.10: 2013 is also referred.

FCC Part 15.31 (e)

The RF Module has its own regulator.

The RF Module is constantly provided voltage through the regulator regardless of input voltage. Therefore, this EUT complies with the requirement.

FCC Part 15.203 Antenna requirement

[Internal antenna]

It is impossible for end users to replace the antenna, because the antenna is mounted inside of the EUT. Therefore, the equipment complies with the antenna requirement of Section 15.203.

[External antenna]

The EUT has a unique coupling/antenna connector (UFL). Therefore the equipment complies with the requirement of 15.203. Module has UFL Connector, and antenna Cable has RP-SMA Connector.

UL Japan, Inc.

Ise EMC Lab.

4383-326 Asama-cho, Ise-shi, Mie-ken 516-0021 JAPAN

Telephone : +81 596 24 8999

Facsimile : +81 596 24 8124

3.3 Addition to standard

Item	Test Procedure	Specification	Worst margin	Results	Remarks
99% Occupied Bandwidth	IC: RSS-Gen 6.6	IC: -	N/A	-	Conducted

Other than above, no addition, exclusion nor deviation has been made from the standard.

3.4 Uncertainty

EMI

The following uncertainties have been calculated to provide a confidence level of 95 % using a coverage factor $k = 2$.

Conducted emission

using Item	Frequency range	Uncertainty (+/-)
AMN (LISN)	0.009 MHz to 0.15 MHz	3.8 dB
	0.15 MHz to 30 MHz	3.4 dB

Radiated emission

Measurement distance	Frequency range	Uncertainty (+/-)
3 m	9 kHz to 30 MHz	3.3 dB
10 m		3.2 dB
3 m	30 MHz to 200 MHz (Horizontal) (Vertical)	4.8 dB
		5.0 dB
	200 MHz to 1000 MHz (Horizontal) (Vertical)	5.2 dB
		6.3 dB
10 m	30 MHz to 200 MHz (Horizontal) (Vertical)	4.8 dB
		4.9 dB
	200 MHz to 1000 MHz (Horizontal) (Vertical)	5.0 dB
		5.0 dB
3 m	1 GHz to 6 GHz	5.0 dB
	6 GHz to 18 GHz	5.3 dB
1 m	10 GHz to 26.5 GHz	5.8 dB
	26.5 GHz to 40 GHz	5.8 dB
10 m	1 GHz to 18 GHz	5.2 dB

Antenna Terminal test

Test Item	Uncertainty (+/-)
RF output power	1.3 dB
Antenna terminal conducted emission / Power density /	2.7 dB
Adjacent channel power / Channel power	
Below 3GHz	1.9 dB
3 GHz ot 6 GHz	2.1 dB

Conducted Emission test

The data listed in this test report has enough margin, more than the site margin.

Radiated emission test

The data listed in this test report has enough margin, more than the site margin.

UL Japan, Inc.

Ise EMC Lab.

4383-326 Asama-cho, Ise-shi, Mie-ken 516-0021 JAPAN

Telephone : +81 596 24 8999

Facsimile : +81 596 24 8124

3.5 Test Location

UL Japan, Inc. Ise EMC Lab. *NVLAP Lab. code: 200572-0
4383-326 Asama-cho, Ise-shi, Mie-ken 516-0021 JAPAN
Telephone: +81 596 24 8999, Facsimile: +81 596 24 8124

Test site	IC Registration Number	Width x Depth x Height (m)	Size of reference ground plane (m) / horizontal conducting plane	Other rooms	Maximum measurement distance
No.1 semi-anechoic chamber	2973C-1	19.2 x 11.2 x 7.7	7.0 x 6.0	No.1 Power source room	10 m
No.2 semi-anechoic chamber	2973C-2	7.5 x 5.8 x 5.2	4.0 x 4.0	-	3 m
No.3 semi-anechoic chamber	2973C-3	12.0 x 8.5 x 5.9	6.8 x 5.75	No.3 Preparation room	3 m
No.3 shielded room	-	4.0 x 6.0 x 2.7	N/A	-	-
No.4 semi-anechoic chamber	2973C-4	12.0 x 8.5 x 5.9	6.8 x 5.75	No.4 Preparation room	3 m
No.4 shielded room	-	4.0 x 6.0 x 2.7	N/A	-	-
No.5 semi-anechoic chamber	-	6.0 x 6.0 x 3.9	6.0 x 6.0	-	-
No.6 shielded room	-	4.0 x 4.5 x 2.7	4.0 x 4.5	-	-
No.6 measurement room	-	4.75 x 5.4 x 3.0	4.75 x 4.15	-	-
No.7 shielded room	-	4.7 x 7.5 x 2.7	4.7 x 7.5	-	-
No.8 measurement room	-	3.1 x 5.0 x 2.7	N/A	-	-
No.9 measurement room	-	8.8 x 4.6 x 2.8	2.4 x 2.4	-	-
No.11 measurement room	-	6.2 x 4.7 x 3.0	4.8 x 4.6	-	-

* Size of vertical conducting plane (for Conducted Emission test) : 2.0 m x 2.0m for No.1, No.2, No.3, and No.4 semi-anechoic chambers and No.3 and No.4 shielded rooms.

3.6 Test data, Test instruments, and Test set up

Refer to APPENDIX.

UL Japan, Inc.

Ise EMC Lab.

4383-326 Asama-cho, Ise-shi, Mie-ken 516-0021 JAPAN

Telephone : +81 596 24 8999

Facsimile : +81 596 24 8124

SECTION 4: Operation of E.U.T. during testing

4.1 Operating Mode(s)

Mode	Remarks*
Transmitting mode	-
*Power of the EUT was set by the software as follows; Power settings: +13dBm Software: MH920-Mod-F Software Ver.f4 *This setting of software is the worst case. Any conditions under the normal use do not exceed the condition of setting. In addition, end users cannot change the settings of the output power of the product.	

*The details of Operating mode(s)

Test Item	Operating Mode	Antenna port*	Tested frequency
Conducted Emission	Tx	1 (External antenna) 2 (Internal antenna)	902.4 MHz 915.0 MHz 927.6 MHz
Radiated Spurious Emission	Tx	1 (External antenna) 2 (Internal antenna)	902.4 MHz 915.0 MHz 927.6 MHz
6dB Bandwidth Conducted Spurious Emission Power Density 99% Occupied Bandwidth	Tx	1 (External antenna)	902.4 MHz 915.0 MHz 927.6 MHz
Maximum Peak Output Power	Tx	1 (External antenna) 2 (Internal antenna) 3(External antenna)	902.4 MHz 915.0 MHz 927.6 MHz

* Port 2 is for internal antenna port (temporary for test).

*After the result of Output power test for Antenna port 1, 2 and port 3 were compared, all the tests were performed only with worst case condition.

For Conducted Emission, Radiated Spurious Emission tests, they were also tested on port 2.

4.2 Configuration and peripherals

[Conducted emission test]

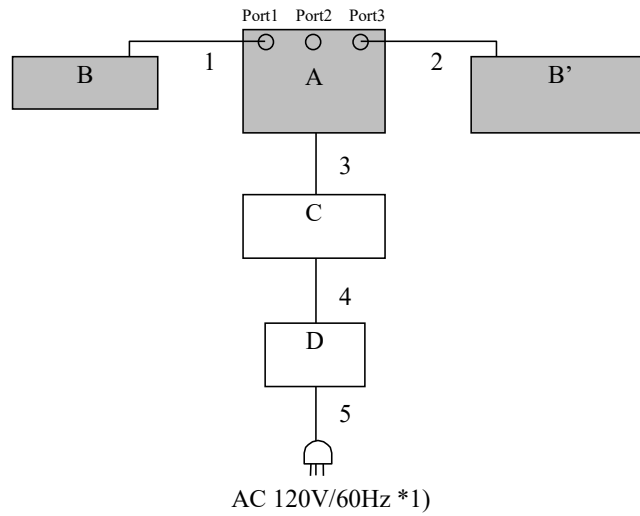

[Other tests except for Conducted emission test]

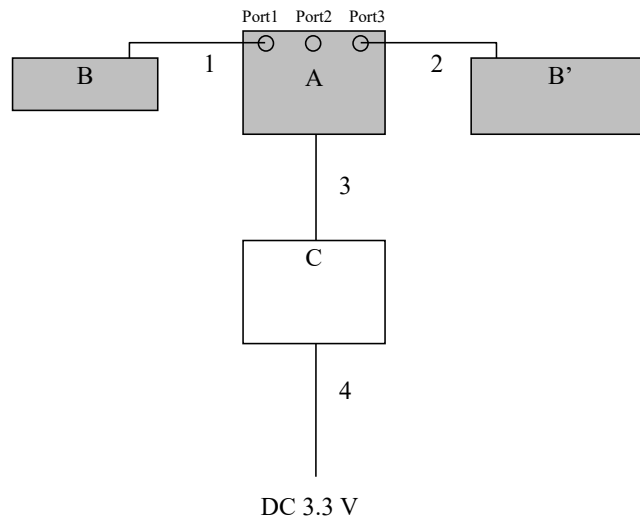

* Cabling and setup(s) were taken into consideration and test data was taken under worse case conditions.

* For combination of antennas connected to port 1 and port 3, the test was performed with a representative one.

*1) Conducted emission test was performed with this port.

Description of EUT and Support equipment

No.	Item	Model number	Serial number	Manufacturer	Remarks
A	RF Module	MH920-MOD-F	1810YY00004	Oki Electric Industry Co., Ltd.	EUT
B	Sleeve antenna	MH920-ANT-F<S>	003	Oki Electric Industry Co., Ltd.	EUT *1)
	$\lambda/4$ Monopole Antenna	MH920-ANT-F<R>	003		
	Film antenna	MH920-ANT-F<D>	001		
B'	Sleeve antenna	MH920-ANT-F<S>	004	Oki Electric Industry Co., Ltd.	EUT
	Film antenna	MH920-ANT-F<D>	002		
	$\lambda/4$ Monopole Antenna	MH920-ANT-F<R>	004		
C	Jig	YU1260-1081	S025	Oki Electric Industry Co., Ltd.	*2)
D	DC Power supply	PMC35-2A	RM000298	KIKUSUI	for CE only

*1) Terminated in Internal Antenna transmission

*2) The input voltage was supplied to the EUT (A) through the jig board, but the voltage was not regulated inside the Jig board

List of cables used

No.	Name	Length (m)	Shield		Remarks
			Cable	Connector	
1	Antenna Cable	0.07	Shielded	Shielded	-
2	Antenna Cable	0.07	Shielded	Shielded	-
3	Flat Cable	0.20	Unshielded	Unshielded	-
4	DC Cable	2.50	Unshielded	Unshielded	-
5	AC Cable	1.90	Unshielded	Unshielded	for CE only

*CE: Conducted emission test

UL Japan, Inc.

Ise EMC Lab.

4383-326 Asama-cho, Ise-shi, Mie-ken 516-0021 JAPAN

Telephone : +81 596 24 8999

Facsimile : +81 596 24 8124

SECTION 5: Conducted Emission

Test Procedure and conditions

EUT was placed on a urethane platform of nominal size, 1.0 m by 1.5 m, raised 0.8 m above the conducting ground plane.

The rear of tabletop was located 40 cm to the vertical conducting plane. The rear of EUT, including peripherals aligned and flushed with rear of tabletop. All other surfaces of tabletop were at least 80cm from any other grounded conducting surface. EUT was located 80 cm from a Line Impedance Stabilization Network (LISN) / Artificial mains Network (AMN) and excess AC cable was bundled in center.

For the tests on EUT with other peripherals (as a whole system)

I/O cables that were connected to the peripherals were bundled in center. They were folded back and forth forming a bundle 30 cm to 40 cm long and were hanged at a 40 cm height to the ground plane. All unused 50ohm connectors of the LISN (AMN) were resistivity terminated in 50 ohm when not connected to the measuring equipment.

The AC Mains Terminal Continuous disturbance Voltage has been measured with the EUT in a Semi Anechoic Chamber.

The EUT was connected to a LISN (AMN).

An overview sweep with peak detection has been performed.

The test results and limit are rounded off to one decimal place, so some differences might be observed.

Detector : QP and CISPR AV
Measurement range : 0.15 MHz – 30 MHz
Test data : APPENDIX
Test result : Pass

SECTION 6: Radiated Spurious Emission

Test Procedure

It was measured based on "11.0 Emissions in non-restricted frequency bands" of "KDB 558074 D01 DTS Meas Guidance v04".

[For below 1 GHz]

EUT was placed on a urethane platform of nominal size, 0.5 m by 1.0 m (except for Film antenna), 1.0 m by 1.5 m (Film antenna), raised 0.8 m above the conducting ground plane. The Radiated Electric Field Strength has been measured in a Semi Anechoic Chamber with a ground plane.

[For above 1 GHz]

EUT was placed on a urethane platform of nominal size, 0.5 m by 0.5 m, raised 1.5 m above the conducting ground plane.

The Radiated Electric Field Strength has been measured in a Semi Anechoic Chamber with absorbent materials lined on a ground plane.

The height of the measuring antenna varied between 1 and 4 m and EUT was rotated a full revolution in order to obtain the maximum value of the electric field strength.

The measurements were performed for both vertical and horizontal antenna polarization with the Test Receiver, or the Spectrum Analyzer.

The measurements were made with the following detector function of the test receiver and the Spectrum analyzer (in linear mode).

The test was made with the detector (RBW/VBW) in the following table.

When using Spectrum analyzer, the test was made with adjusting span to zero by using peak hold.

Test Antennas are used as below;

Frequency	30 MHz to 200 MHz	200 MHz to 1 GHz	Above 1 GHz
Antenna Type	Biconical	Logperiodic	Horn

In any 100 kHz bandwidth outside the restricted band in which the spread spectrum intentional radiator is operating, the radio frequency power that is produced by the intentional radiator confirmed 20 dB below that in the 100 kHz bandwidth within the band that contains the highest level of the desired power, based on a radiated measurement.

20 dBc was applied to the frequency over the limit of FCC 15.209 / Table 4 of RSS-Gen 8.9(IC) and outside the restricted band of FCC15.205 / Table 6 of RSS-Gen 8.10 (IC).

Frequency	Below 1 GHz	Above 1 GHz		20 dBc
Instrument used	Test Receiver	Spectrum Analyzer		Spectrum Analyzer
Detector	QP	PK	AV *1)	PK
IF Bandwidth	BW 120 kHz	RBW: 1 MHz VBW: 3 MHz	Average Power Method: RBW: 1 MHz VBW: 3 MHz Detector: Power Averaging (RMS) Trace: 100 traces If duty cycle was less than 98%, a duty factor was added to the results.	RBW: 100 kHz VBW: 300kHz
Test Distance	3 m	3 m *2) (1 GHz – 10 GHz)		3 m *2) (1 GHz – 10 GHz)

*1) Average Power Measurement was performed based on 6.0 & 12.2.5 of "KDB 558074 D01 DTS Meas Guidance v04".

*2) Distance Factor: $20 \times \log(4.0 \text{ m} / 3.0 \text{ m}) = 2.5 \text{ dB}$ (except for Film antenna)
 $20 \times \log(3.75 \text{ m} / 3.0 \text{ m}) = 1.94 \text{ dB}$ (Film antenna)

UL Japan, Inc.

Ise EMC Lab.

4383-326 Asama-cho, Ise-shi, Mie-ken 516-0021 JAPAN

Telephone : +81 596 24 8999

Facsimile : +81 596 24 8124

- The carrier level and noise levels were confirmed at each position of X, Y and Z axes of EUT to see the position of maximum noise, and the test was made at the position that has the maximum noise.

The test results and limit are rounded off to one decimal place, so some differences might be observed.

Measurement range : 30 MHz - 10 GHz
Test data : APPENDIX
Test result : Pass

SECTION 7: Antenna Terminal Conducted Tests

Test Procedure

The tests were made with below setting connected to the antenna port.

Test	Span	RBW	VBW	Sweep time	Detector	Trace	Instrument used
6dB Bandwidth	1 MHz	100 kHz	300 kHz	Auto	Peak	Max Hold	Spectrum Analyzer
99% Occupied Bandwidth *1)	Enough width to display emission skirts	1 to 5 % of OBW	Three times of RBW	Auto	Peak	Max Hold	Spectrum Analyzer
Maximum Peak Output Power	-	-	-	Auto	Peak/Average *2)	-	Power Meter (Sensor: 50 MHz BW)
Peak Power Density	1.5 times the 6dB Bandwidth	3 kHz	10 kHz	Auto	Peak	Max Hold	Spectrum Analyzer *3)
Conducted Spurious Emission *4)	9kHz to 150kHz	200 Hz	620 Hz	Auto	Peak	Max Hold	Spectrum Analyzer
	150kHz to 30MHz	9.1 kHz	27 kHz				
*1) Peak hold was applied as Worst-case measurement. *2) Reference data *3) Section 10.2 Method PKPSD (peak PSD) of "KDB 558074 D01 DTS Meas Guidance v04". *4) In the frequency range below 30MHz, RBW was narrowed to separate the noise contents. Then, wide-band noise near the limit was checked separately, however the noise was low enough as shown in the chart. (9 kHz - 150 kHz: RBW = 200 Hz, 150 kHz - 30 MHz: RBW = 9.1 kHz).							

The test results and limit are rounded off to two decimals place, so some differences might be observed.

Test data : APPENDIX
Test result : Pass

APPENDIX 1: Test data

Conducted Emission

Test place : Ise EMC Lab. No.3 Semi Anechoic Chamber
Report No. : 12160939H
Date : February 28, 2018
Temperature / Humidity : 23 deg. C / 27 % RH
Engineer : Yuta Moriya
Mode : Tx 915MHz Film Ant (Ant1)

LIMIT : FCC15.207 QP
FCC15.207 AV

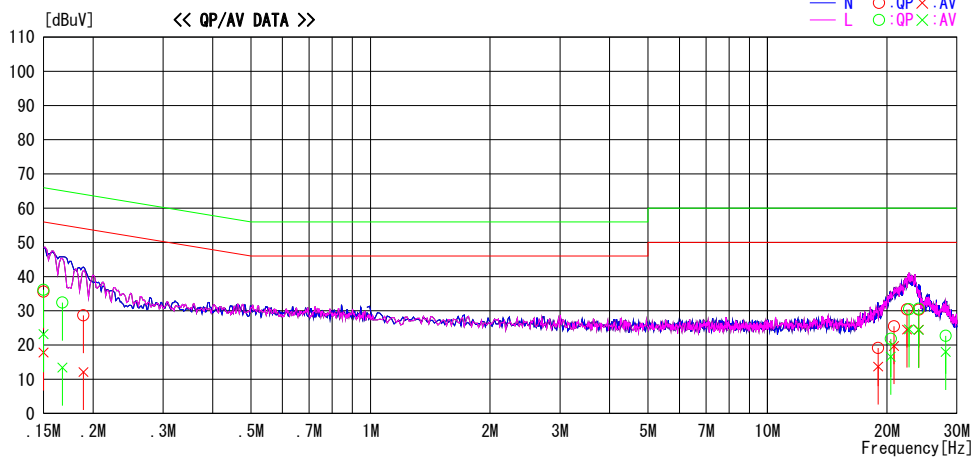

Frequency [MHz]	Reading Level		Corr. Factor	Results		Limit		Margin		Phase	Comment
	QP [dBuV]	AV [dBuV]		QP [dBuV]	AV [dBuV]	QP [dBuV]	AV [dBuV]	QP [dB]	AV [dB]		
0.15000	22.4	4.6	13.2	35.6	17.8	66.0	56.0	30.4	38.2	N	
0.15000	22.9	10.0	13.2	36.1	23.2	66.0	56.0	29.9	32.8	L	
0.16740	19.2	0.2	13.2	32.4	13.4	65.1	55.1	32.7	41.7	L	
0.18915	15.5	-1.1	13.2	28.7	12.1	64.1	54.1	35.4	42.0	N	
18.98860	4.8	-0.6	14.3	19.1	13.7	60.0	50.0	40.9	36.3	N	
20.44286	7.5	2.3	14.3	21.8	16.6	60.0	50.0	38.2	33.4	L	
20.84300	11.1	5.3	14.4	25.5	19.7	60.0	50.0	34.5	30.3	N	
22.45600	15.9	10.0	14.5	30.4	24.5	60.0	50.0	29.6	25.5	N	
22.73180	16.0	10.1	14.5	30.5	24.6	60.0	50.0	29.5	25.4	L	
24.01560	16.1	9.9	14.5	30.6	24.4	60.0	50.0	29.4	25.6	L	
24.04420	15.8	10.0	14.5	30.3	24.5	60.0	50.0	29.7	25.5	N	
28.12871	8.1	3.4	14.6	22.7	18.0	60.0	50.0	37.3	32.0	L	

Conducted Emission

Test place : Ise EMC Lab. No.3 Semi Anechoic Chamber
Report No. : 12160939H
Date : February 28, 2018
Temperature / Humidity : 23 deg. C / 27 % RH
Engineer : Yuta Moriya
Mode : Tx Sleeve Ant (Ant1)

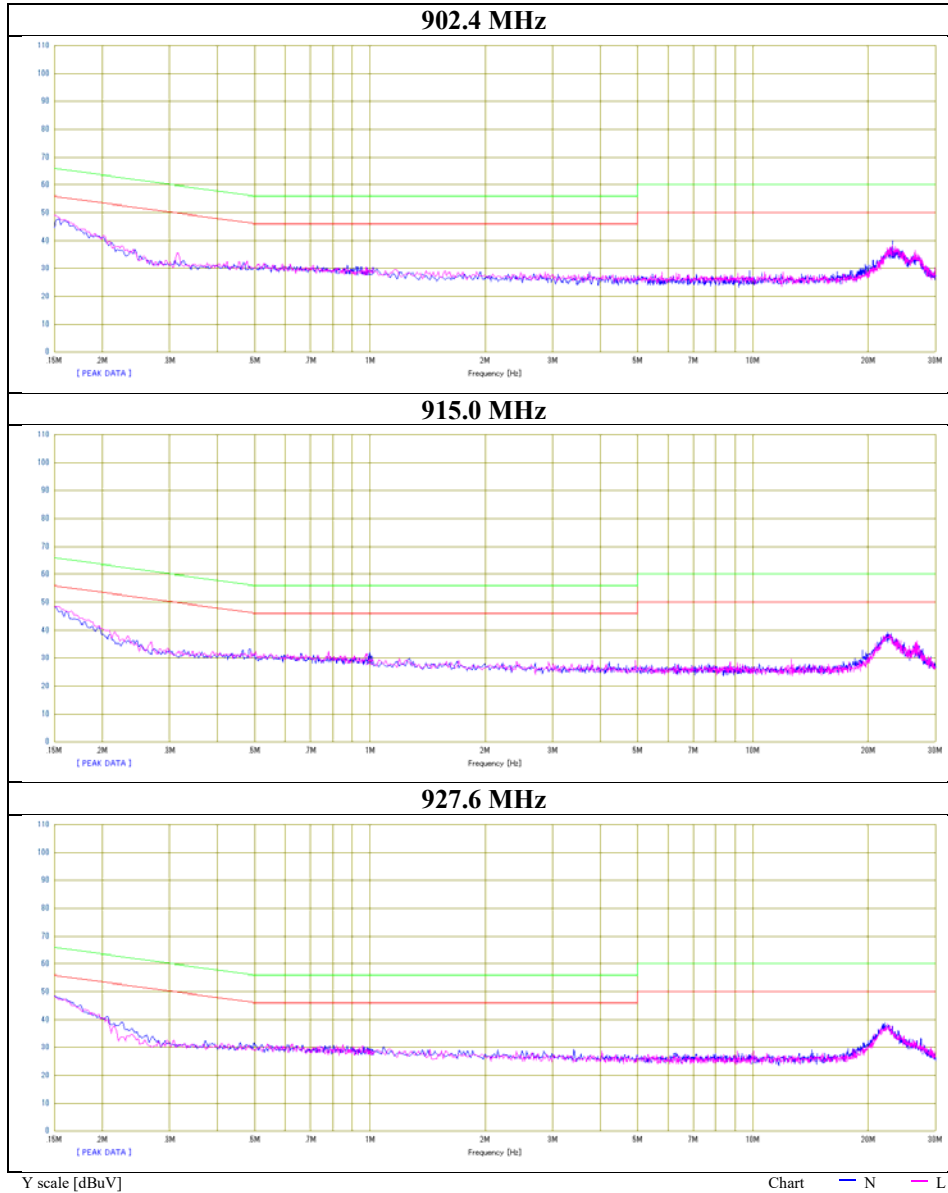

UL Japan, Inc.

Ise EMC Lab.

4383-326 Asama-cho, Ise-shi, Mie-ken 516-0021 JAPAN

Telephone : +81 596 24 8999

Facsimile : +81 596 24 8124

Conducted Emission

Test place	Ise EMC Lab. No.3 Semi Anechoic Chamber
Report No.	12160939H
Date	February 28, 2018
Temperature / Humidity	23 deg. C / 27 % RH
Engineer	Yuta Moriya
Mode	Tx $\lambda/4$ Monopole Ant (Ant1)

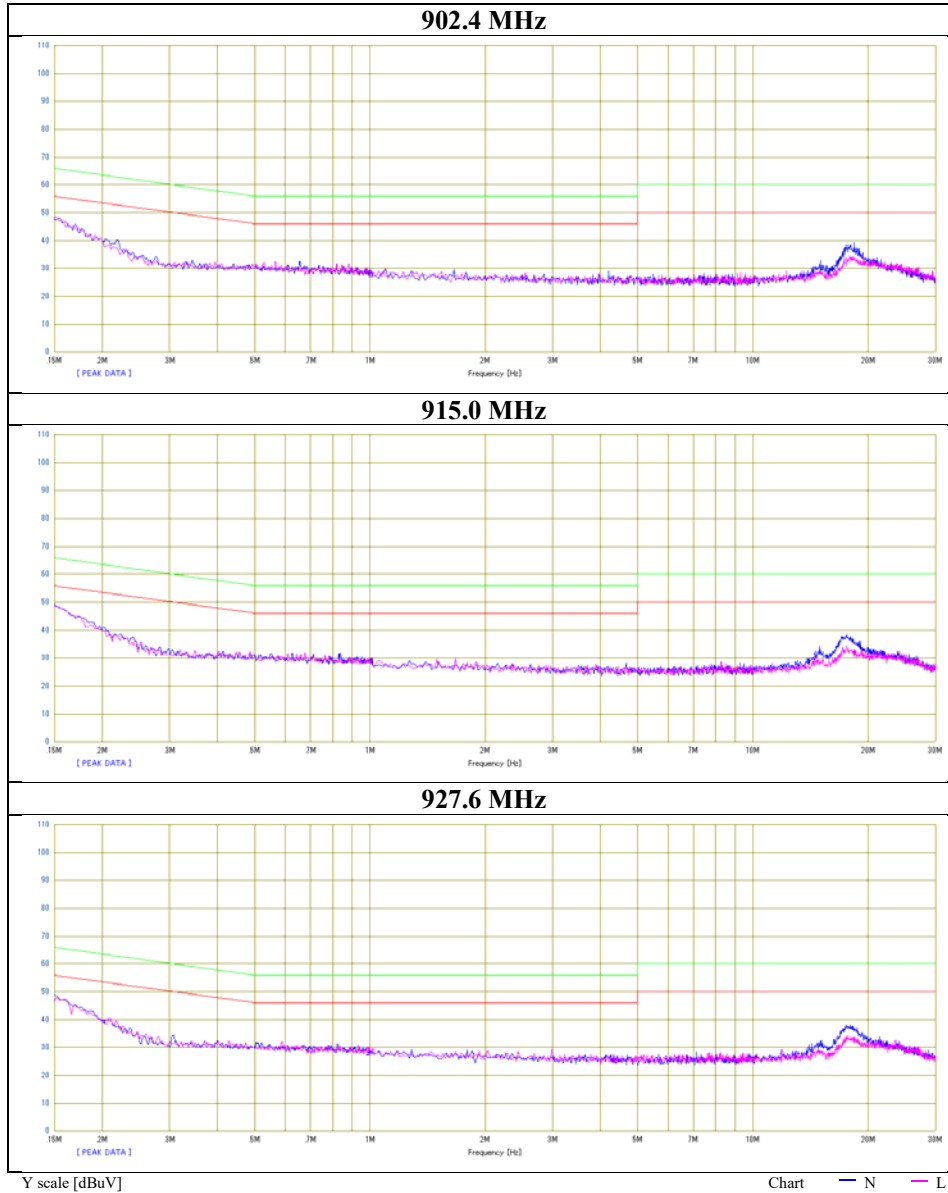

UL Japan, Inc.

Ise EMC Lab.

4383-326 Asama-cho, Ise-shi, Mie-ken 516-0021 JAPAN

Telephone : +81 596 24 8999

Facsimile : +81 596 24 8124

Conducted Emission

Test place : Ise EMC Lab. No.3 Semi Anechoic Chamber
Report No. : 12160939H
Date : February 28, 2018
Temperature / Humidity : 23 deg. C / 27 % RH
Engineer : Yuta Moriya
Mode : Tx Film Ant (Ant1)

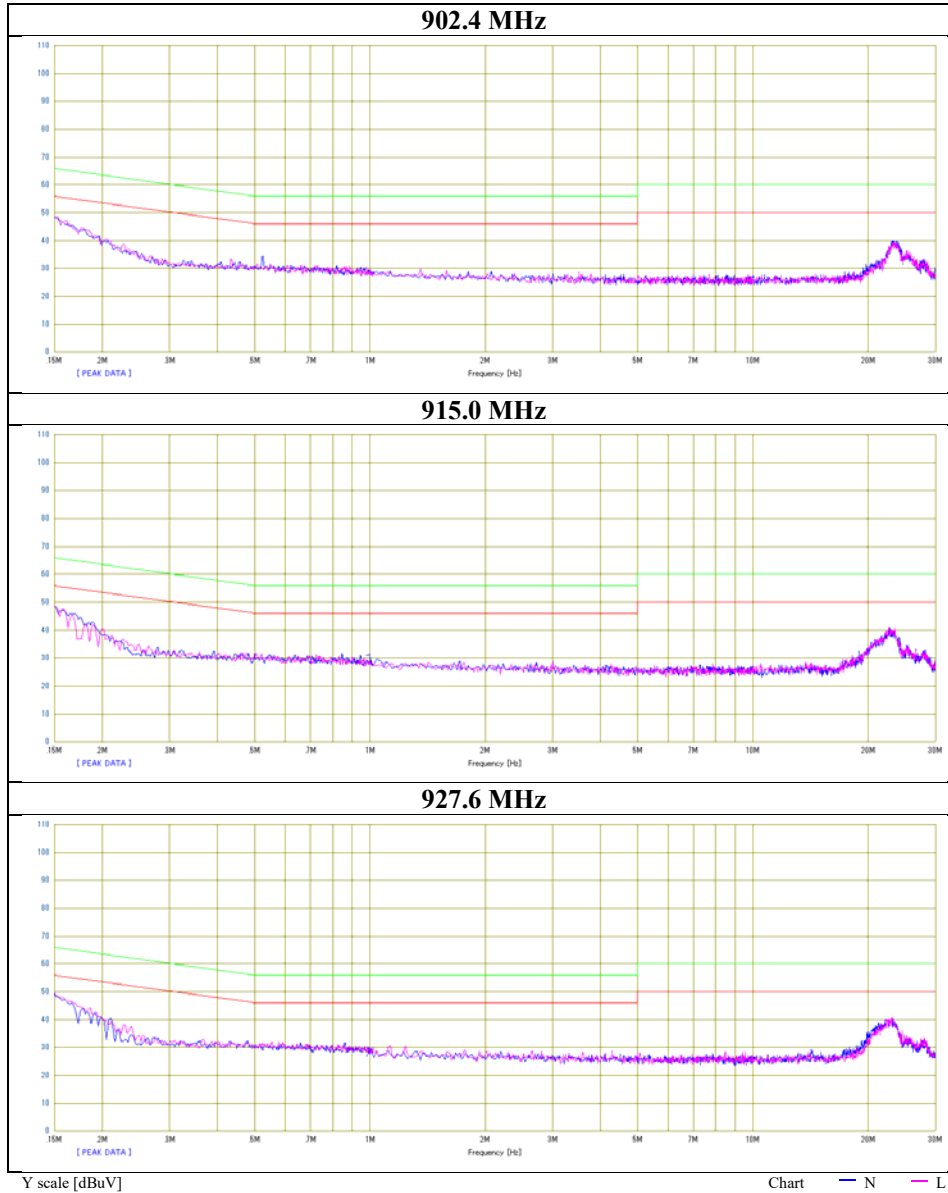

UL Japan, Inc.

Ise EMC Lab.

4383-326 Asama-cho, Ise-shi, Mie-ken 516-0021 JAPAN

Telephone : +81 596 24 8999

Facsimile : +81 596 24 8124

Conducted Emission

Test place : Ise EMC Lab. No.3 Semi Anechoic Chamber
Report No. : 12160939H
Date : February 28, 2018
Temperature / Humidity : 23 deg. C / 27 % RH
Engineer : Yuta Moriya
Mode : Tx 927.6MHz Internal Ant2

LIMIT : FCC15.207 QP
FCC15.207 AV

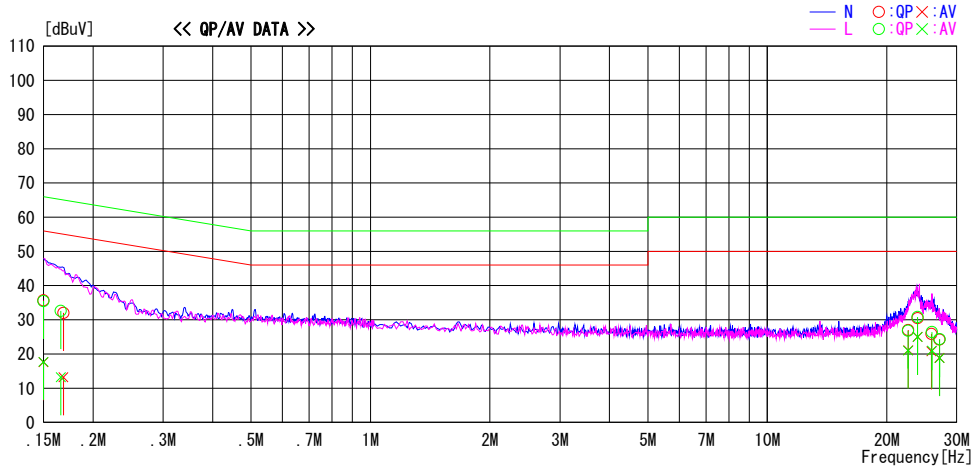

Frequency [MHz]	Reading Level		Corr. Factor [dB]	Results		Limit		Margin		Phase	Comment
	QP [dBuV]	AV [dBuV]		QP [dBuV]	AV [dBuV]	QP [dBuV]	AV [dBuV]	QP [dB]	AV [dB]		
0.15000	22.5	4.4	13.2	35.7	17.6	66.0	56.0	30.3	38.4	N	
0.15000	22.3	4.5	13.2	35.5	17.7	66.0	56.0	30.5	38.3	L	
0.16594	19.4	0.0	13.2	32.6	13.2	65.2	55.2	32.6	42.0	L	
0.16840	18.8	0.0	13.2	32.0	13.2	65.0	55.0	33.0	41.8	N	
22.60124	12.3	6.5	14.5	26.8	21.0	60.0	50.0	33.2	29.0	L	
22.63600	12.5	6.6	14.5	27.0	21.1	60.0	50.0	33.0	28.9	N	
23.90484	16.0	10.5	14.5	30.5	25.0	60.0	50.0	29.5	25.0	N	
23.89972	16.3	10.5	14.5	30.8	25.0	60.0	50.0	29.2	25.0	L	
25.90468	11.4	6.3	14.5	25.9	20.8	60.0	50.0	34.1	29.2	N	
25.98888	11.9	6.5	14.5	26.4	21.0	60.0	50.0	33.6	29.0	L	
27.13365	9.7	4.4	14.5	24.2	18.9	60.0	50.0	35.8	31.1	N	
27.15840	9.8	4.3	14.5	24.3	18.8	60.0	50.0	35.7	31.2	L	

Conducted Emission

Test place	Ise EMC Lab. No.3 Semi Anechoic Chamber
Report No.	12160939H
Date	February 28, 2018
Temperature / Humidity	23 deg. C / 27 % RH
Engineer	Yuta Moriya
Mode	Tx Internal Ant2

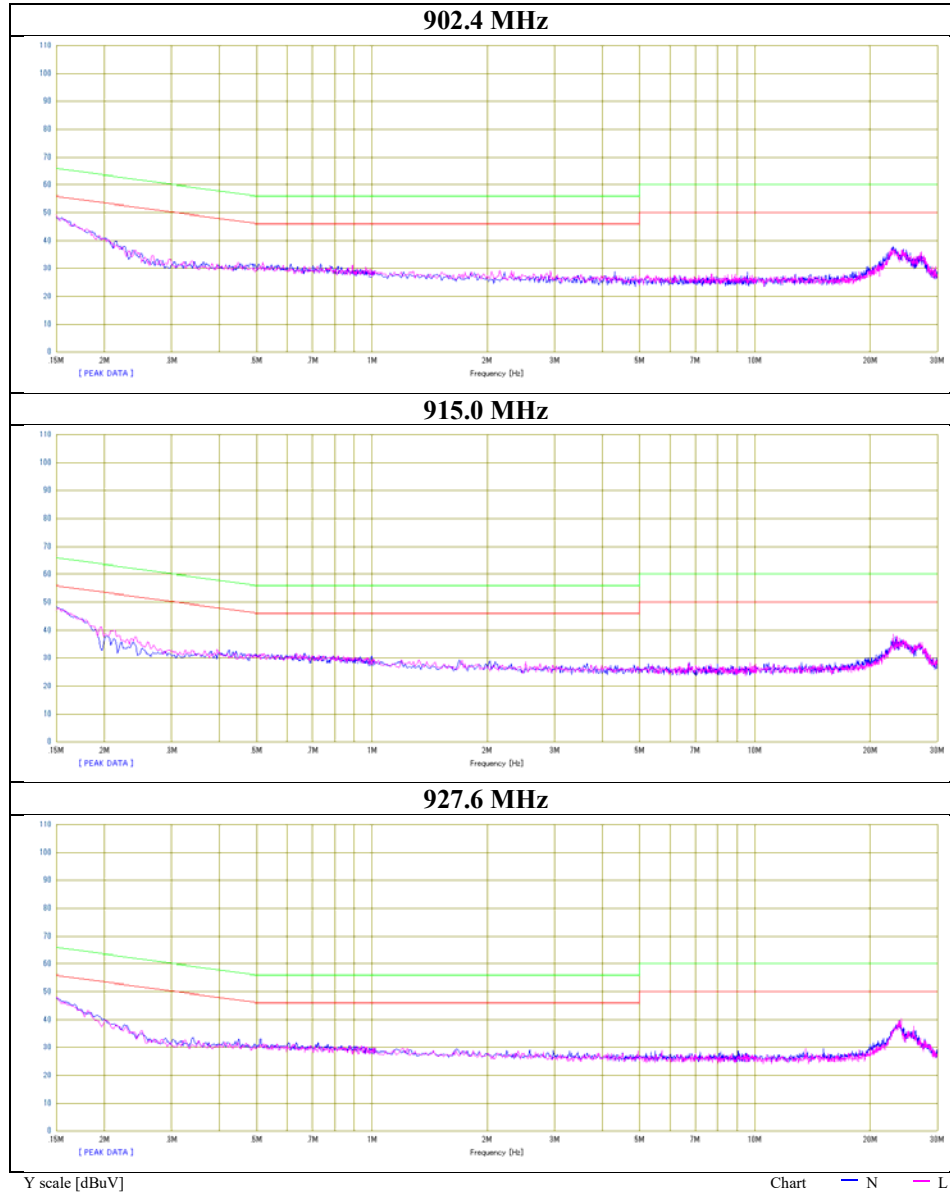

UL Japan, Inc.

Ise EMC Lab.

4383-326 Asama-cho, Ise-shi, Mie-ken 516-0021 JAPAN

Telephone : +81 596 24 8999

Facsimile : +81 596 24 8124

Conducted Emission

Test place : Ise EMC Lab. No.3 Semi Anechoic Chamber
Report No. : 12160939H
Date : February 28, 2018
Temperature / Humidity : 23 deg. C / 27 % RH
Engineer : Yuta Moriya
Mode : Tx 902.4MHz Film Ant (Ant3)

LIMIT : FCC15.207 QP
FCC15.207 AV

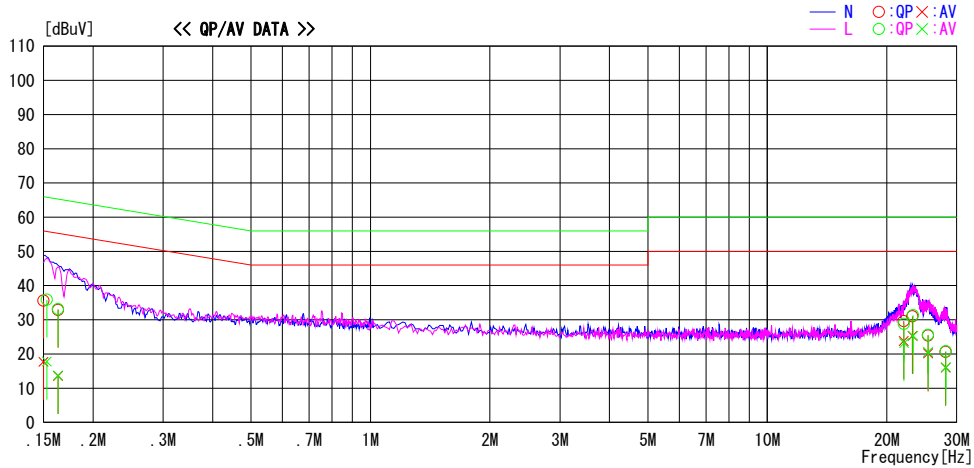

Frequency [MHz]	Reading Level		Corr. Factor	Results		Limit		Margin		Phase	Comment
	QP [dBuV]	AV [dBuV]		QP [dBuV]	AV [dBuV]	QP [dBuV]	AV [dBuV]	QP [dB]	AV [dB]		
0.15000	22.4	4.5	13.2	35.6	17.7	66.0	56.0	30.4	38.3	N	
0.16315	19.7	0.4	13.2	32.9	13.6	65.3	55.3	32.4	41.7	N	
22.04668	15.2	9.4	14.4	29.6	23.8	60.0	50.0	30.4	26.2	N	
23.19456	16.5	10.8	14.5	31.0	25.3	60.0	50.0	29.0	24.7	N	
25.38408	10.9	5.7	14.5	25.4	20.2	60.0	50.0	34.6	29.8	N	
28.11940	6.0	1.4	14.6	20.6	16.0	60.0	50.0	39.4	34.0	N	
0.15290	22.7	4.6	13.2	35.9	17.8	65.8	55.8	29.9	38.0	L	
0.16324	19.9	0.5	13.2	33.1	13.7	65.3	55.3	32.2	41.6	L	
22.08948	14.4	8.8	14.4	28.8	23.2	60.0	50.0	31.2	26.8	L	
23.27216	16.8	10.8	14.5	31.3	25.3	60.0	50.0	28.7	24.7	L	
25.39214	11.1	6.1	14.5	25.6	20.6	60.0	50.0	34.4	29.4	L	
28.16132	6.2	1.5	14.6	20.8	16.1	60.0	50.0	39.2	33.9	L	

Conducted Emission

Test place	Ise EMC Lab. No.3 Semi Anechoic Chamber
Report No.	12160939H
Date	February 28, 2018
Temperature / Humidity	23 deg. C / 27 % RH
Engineer	Yuta Moriya
Mode	Tx Sleeve Ant (Ant3)

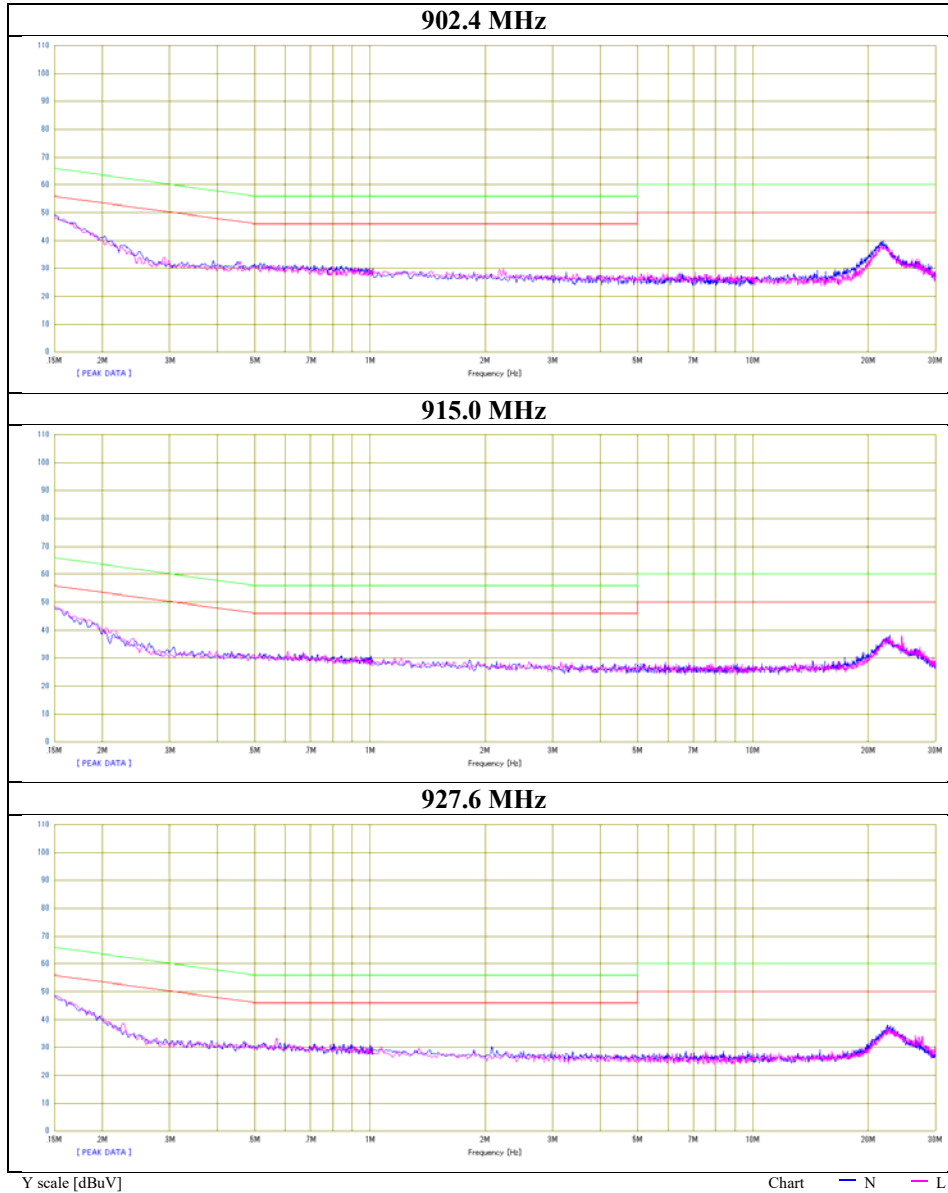

UL Japan, Inc.

Ise EMC Lab.

4383-326 Asama-cho, Ise-shi, Mie-ken 516-0021 JAPAN

Telephone : +81 596 24 8999

Facsimile : +81 596 24 8124

Conducted Emission

Test place : Ise EMC Lab. No.3 Semi Anechoic Chamber
Report No. : 12160939H
Date : February 28, 2018
Temperature / Humidity : 23 deg. C / 27 % RH
Engineer : Yuta Moriya
Mode : Tx $\lambda/4$ Monopole Ant (Ant3)

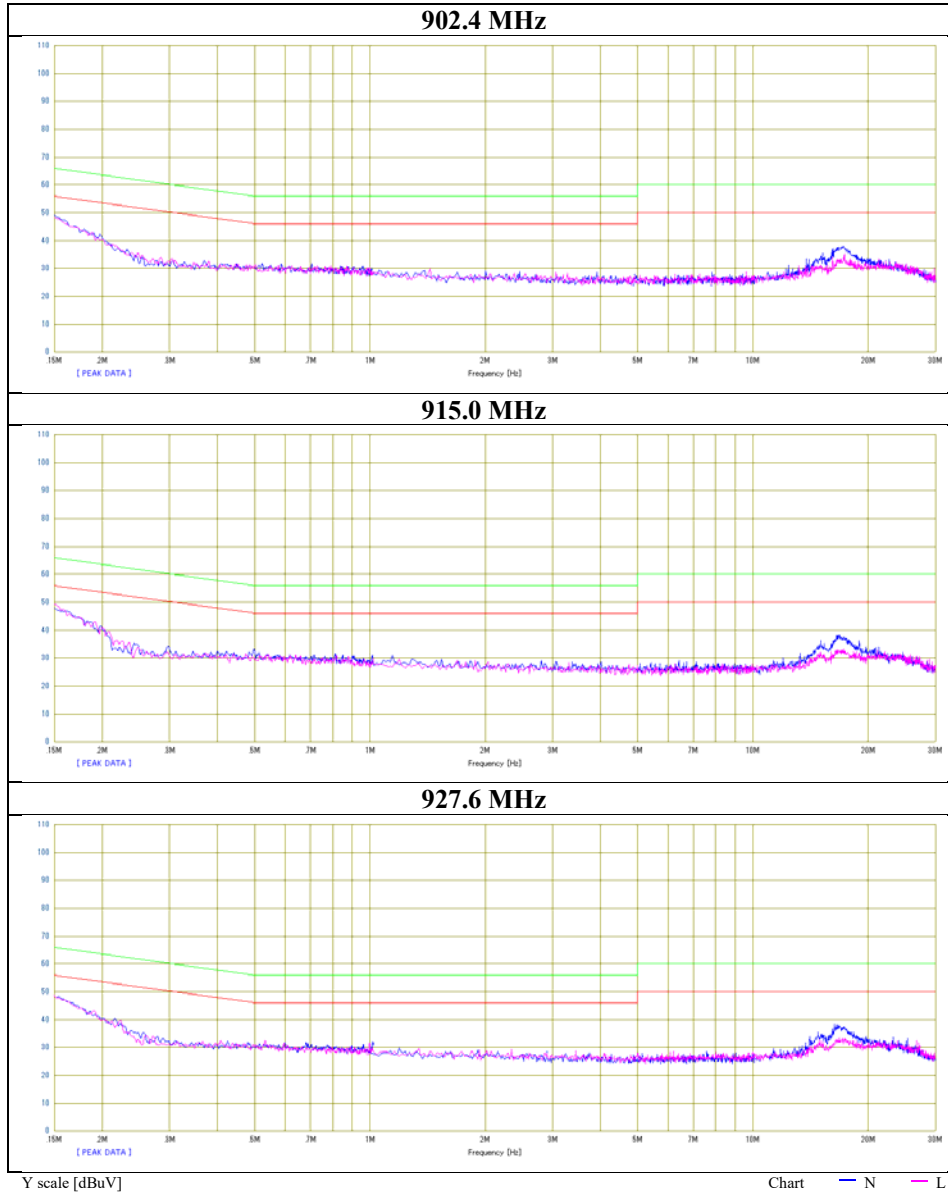

UL Japan, Inc.

Ise EMC Lab.

4383-326 Asama-cho, Ise-shi, Mie-ken 516-0021 JAPAN

Telephone : +81 596 24 8999

Facsimile : +81 596 24 8124

Conducted Emission

Test place : Ise EMC Lab. No.3 Semi Anechoic Chamber
Report No. : 12160939H
Date : February 28, 2018
Temperature / Humidity : 23 deg. C / 27 % RH
Engineer : Yuta Moriya
Mode : Tx Film Ant (Ant3)

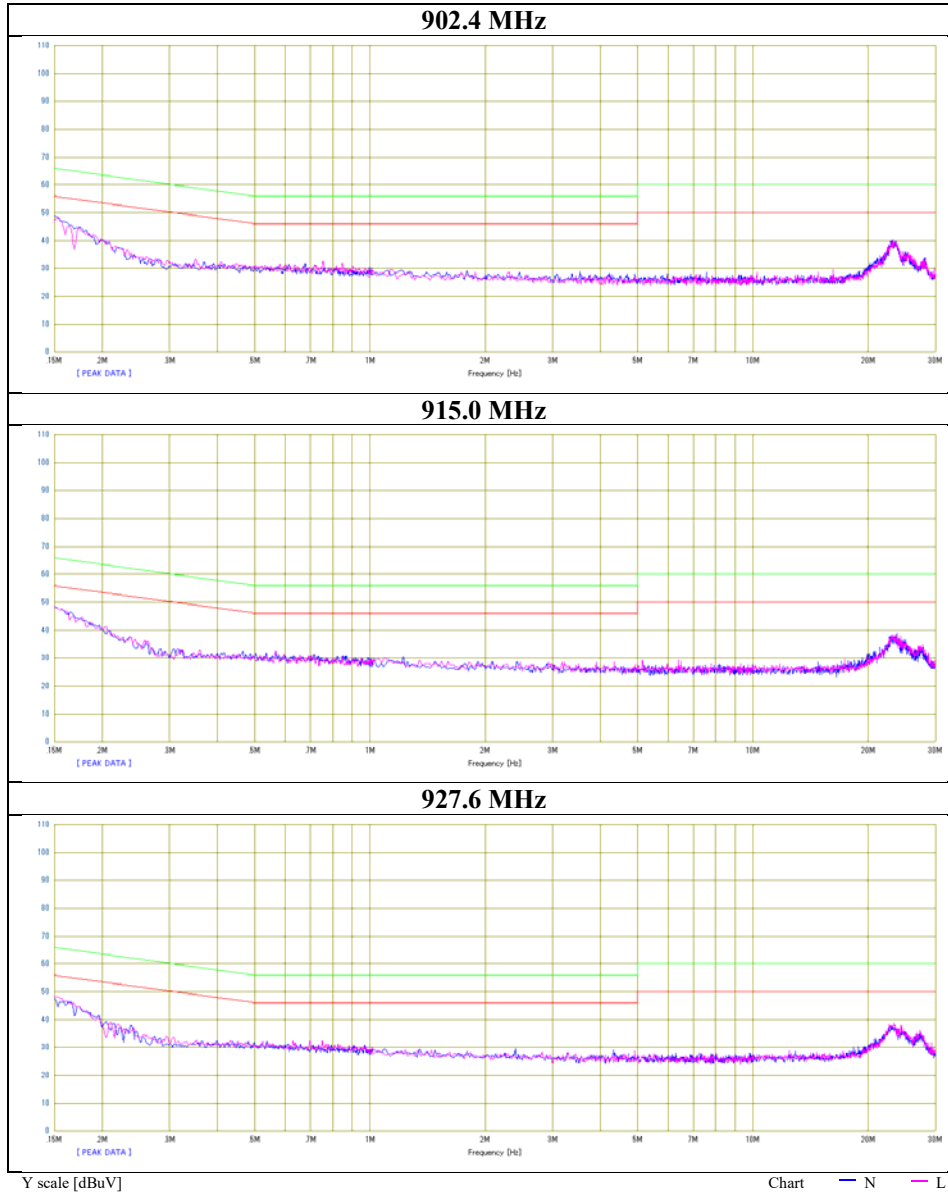

UL Japan, Inc.

Ise EMC Lab.

4383-326 Asama-cho, Ise-shi, Mie-ken 516-0021 JAPAN

Telephone : +81 596 24 8999

Facsimile : +81 596 24 8124

6dB Bandwidth

Test place Ise EMC Lab. No.6 Shielded Room
Report No. 12160939H
Date February 19, 2018
Temperature / Humidity 25 deg. C / 31 % RH
Engineer Yuta Moriya
Mode Tx

Frequency [MHz]	99% Occupied Bandwidth [kHz]	6 dB Bandwidth [MHz]	Limit for 6 dB Bandwidth [MHz]
902.4	428.7	0.514	> 0.5000
915.0	448.3	0.513	> 0.5000
927.6	428.5	0.510	> 0.5000

6dB Bandwidth

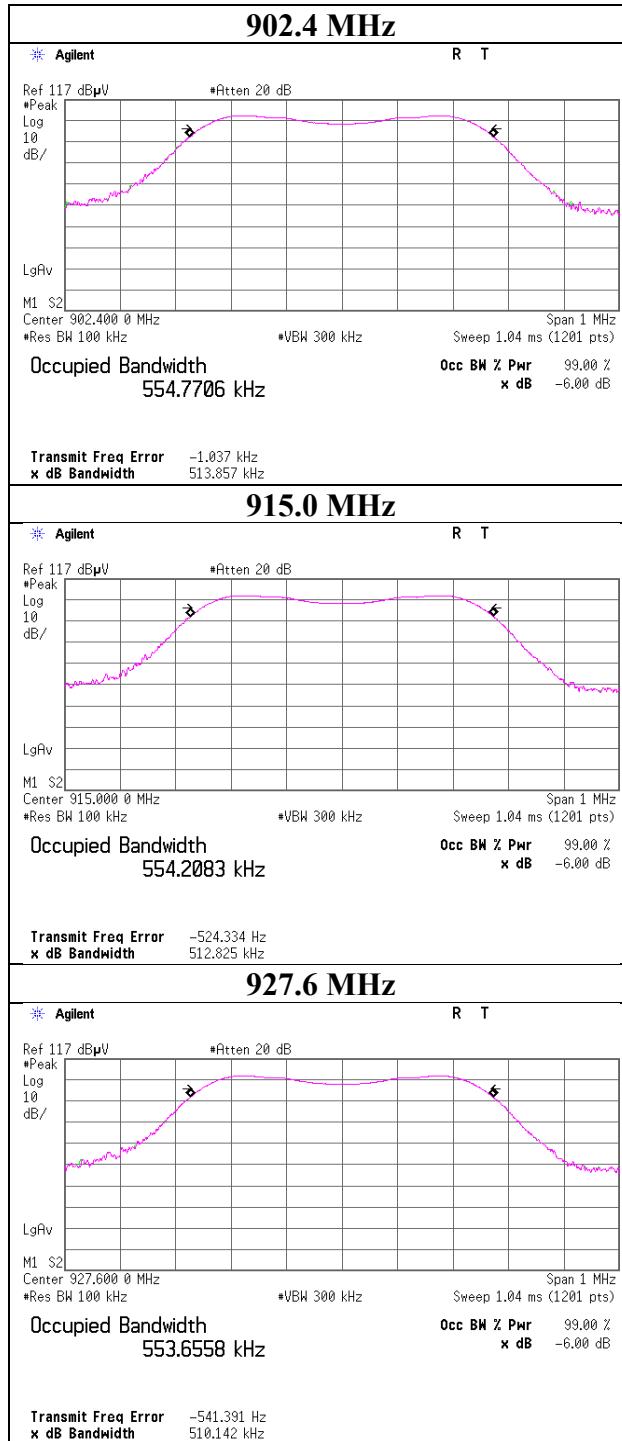

99%Occupied Bandwidth

Test place	Ise EMC Lab. No.6 Shielded Room
Report No.	12160939H
Date	February 19, 2018
Temperature / Humidity	25 deg. C / 31 % RH
Engineer	Yuta Moriya
Mode	Tx

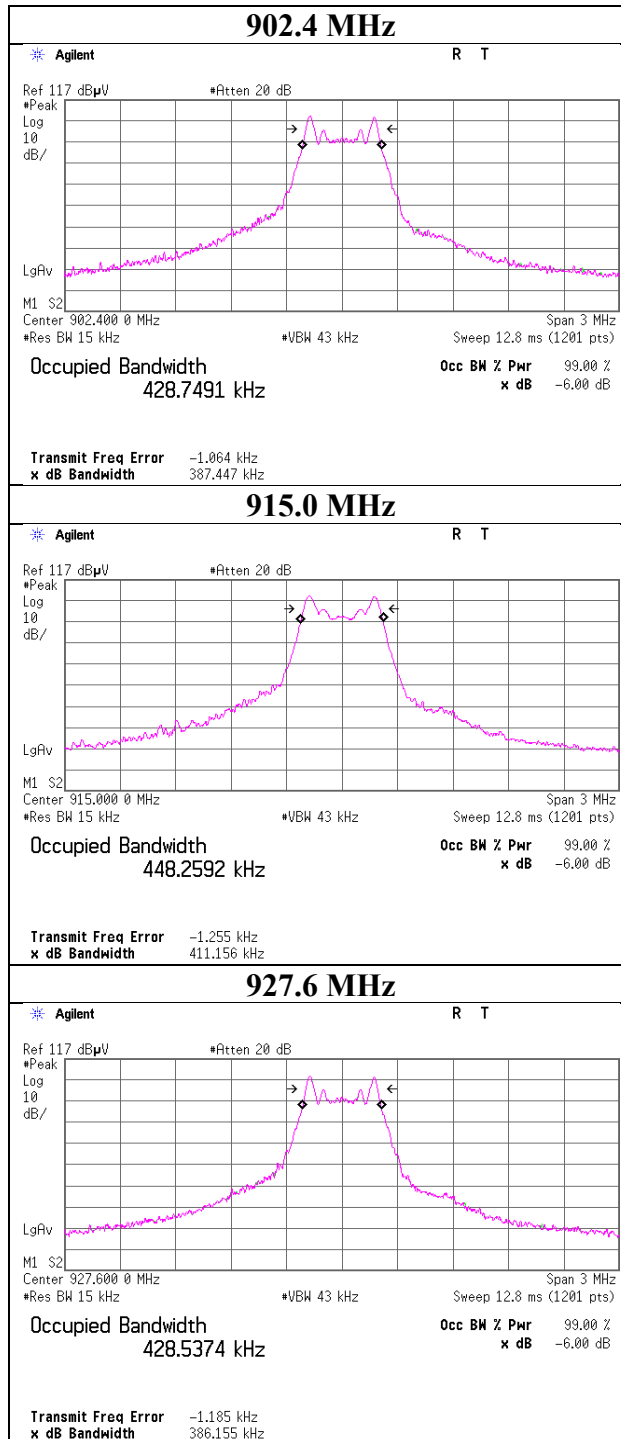

Maximum Peak Output Power

Test place	Ise EMC Lab. No.6 Shielded Room	
Report No.	12160939H	
Date	February 19, 2018	February 23, 2018
Temperature / Humidity	25 deg. C / 31 % RH	21 deg. C / 30 % RH
Engineer	Yuta Moriya	Shinya Watanabe
Mode	Tx (Antenna port 1,2)	Tx (Antenna port 3)

Antenna port 1

Freq. [MHz]	Reading [dBm]	Cable Loss [dB]	Atten. Loss [dB]	Result		Limit		Margin [dB]
				[dBm]	[mW]	[dBm]	[mW]	
902.4	1.89	0.20	9.91	12.00	15.85	30.00	1000	18.00
915.0	1.68	0.20	9.91	11.79	15.10	30.00	1000	18.21
927.6	1.46	0.20	9.91	11.57	14.35	30.00	1000	18.43

Antenna port 2

Freq. [MHz]	Reading [dBm]	Cable Loss [dB]	Atten. Loss [dB]	Result		Limit		Margin [dB]
				[dBm]	[mW]	[dBm]	[mW]	
902.4	1.24	0.30	9.91	11.45	13.96	30.00	1000	18.55
915.0	1.04	0.30	9.91	11.25	13.34	30.00	1000	18.75
927.6	0.84	0.30	9.91	11.05	12.74	30.00	1000	18.95

Antenna port 3

Freq. [MHz]	Reading [dBm]	Cable Loss [dB]	Atten. Loss [dB]	Result		Limit		Margin [dB]
				[dBm]	[mW]	[dBm]	[mW]	
902.4	1.37	0.20	9.91	11.48	14.06	30.00	1000	18.52
915.0	1.14	0.20	9.91	11.25	13.34	30.00	1000	18.75
927.6	0.89	0.20	9.91	11.00	12.59	30.00	1000	19.00

Sample Calculation:

Result = Reading + Cable Loss (including the cable(s) customer supplied) + Attenuator Loss

Average Output Power
(Reference data for RF Exposure)

Test place : Ise EMC Lab. No.6 Shielded Room
Report No. : 12160939H
Date : February 19, 2018 February 23, 2018
Temperature / Humidity : 25 deg. C / 31 % RH 21 deg. C / 30 % RH
Engineer : Yuta Moriya Shinya Watanabe
Mode : Tx (Antenna port 1,2) Tx (Antenna port 3)

Antenna port 1

Freq. [MHz]	Reading [dBm]	Cable Loss [dB]	Atten. Loss [dB]	Result (Time average)		Duty factor [dB]	Result (Burst power average)	
				[dBm]	[mW]		[dBm]	[mW]
902.4	1.80	0.20	9.91	11.91	15.52	0.00	11.91	15.52
915.0	1.61	0.20	9.91	11.72	14.86	0.00	11.72	14.86
927.6	1.39	0.20	9.91	11.50	14.13	0.00	11.50	14.13

Antenna port 2

Freq. [MHz]	Reading [dBm]	Cable Loss [dB]	Atten. Loss [dB]	Result (Time average)		Duty factor [dB]	Result (Burst power average)	
				[dBm]	[mW]		[dBm]	[mW]
902.4	1.13	0.30	9.91	11.34	13.61	0.00	11.34	13.61
915.0	0.96	0.30	9.91	11.17	13.09	0.00	11.17	13.09
927.6	0.75	0.30	9.91	10.96	12.47	0.00	10.96	12.47

Antenna port 3

Freq. [MHz]	Reading [dBm]	Cable Loss [dB]	Atten. Loss [dB]	Result (Time average)		Duty factor [dB]	Result (Burst power average)	
				[dBm]	[mW]		[dBm]	[mW]
902.4	1.27	0.20	9.91	11.38	13.74	0.00	11.38	13.74
915.0	1.05	0.20	9.91	11.16	13.06	0.00	11.16	13.06
927.6	0.80	0.20	9.91	10.91	12.33	0.00	10.91	12.33

Sample Calculation:

Result (Time average) = Reading + Cable Loss (including the cable(s) customer supplied) + Attenuator Loss

Result (Burst power average) = Time average + Duty factor

Burst rate confirmation

Test place Ise EMC Lab. No.4 Semi Anechoic Chamber
Report No. 12160939H
Date February 9, 2018
Temperature / Humidity 21 deg. C / 34 % RH
Engineer Takafumi Noguchi
Mode Tx

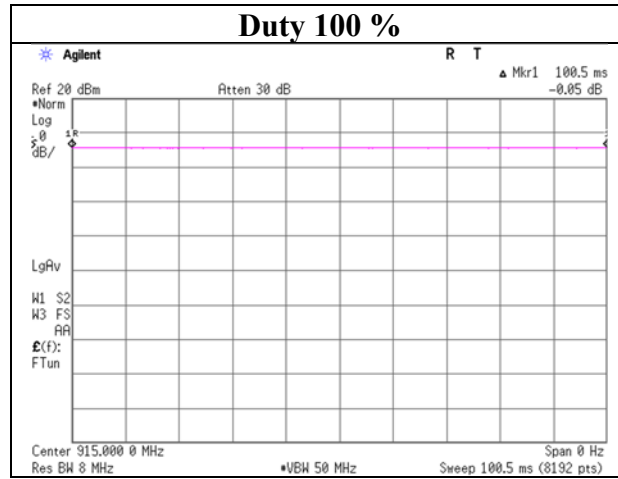

Radiated Spurious Emission
(Internal Antenna)

Test place	Ise EMC Lab.	
Report No.	12160939H	
Semi Anechoic Chamber	No.1	No.4
Date	February 13, 2018	February 9, 2018
Temperature / Humidity	21 deg. C / 37 % RH	21 deg. C / 34 % RH
Engineer	Koji Yamamoto (Below 1 GHz)	Takafumi Noguchi (Above 1 GHz)
Mode	Tx 902.4 MHz	

Polarity	Frequency [MHz]	Detector	Reading [dBuV]	Ant.Fac. [dB/m]	Loss [dB]	Gain [dB]	Duty Factor [dB]	Result [dBuV/m]	Limit [dBuV/m]	Margin [dB]	Remark
Hori	56.815	QP	32.1	8.3	7.8	38.7	-	9.5	40.0	30.5	
Hori	68.821	QP	31.7	6.2	8.0	38.7	-	7.2	40.0	32.8	
Hori	98.326	QP	30.8	9.6	8.5	38.8	-	10.1	43.5	33.4	
Hori	960.000	QP	27.6	22.1	14.7	37.7	-	26.7	46.0	19.3	
Hori	1804.800	PK	41.1	26.3	5.4	32.7	-	40.1	73.9	33.8	Floor noise
Hori	2707.200	PK	46.8	27.8	5.7	31.9	-	48.4	73.9	25.5	
Hori	3609.600	PK	41.3	28.6	6.7	31.7	-	44.9	73.9	29.0	
Hori	4512.000	PK	39.9	30.5	8.1	31.4	-	47.1	73.9	26.8	Floor noise
Hori	5414.400	PK	39.8	32.2	8.4	31.3	-	49.1	73.9	24.8	Floor noise
Hori	6316.800	PK	43.3	34.3	8.9	31.7	-	54.8	73.9	19.1	
Hori	7219.200	PK	41.1	36.5	9.5	32.4	-	54.7	73.9	19.2	Floor noise
Hori	8121.600	PK	40.3	36.9	9.6	32.7	-	54.1	73.9	19.8	Floor noise
Hori	9024.000	PK	41.1	36.9	10.0	32.3	-	55.7	73.9	18.2	Floor noise
Hori	1804.800	AV	33.1	26.3	5.4	32.7	-	32.1	53.9	21.8	Floor noise
Hori	2707.200	AV	40.7	27.8	5.7	31.9	-	42.3	53.9	11.6	
Hori	3609.600	AV	33.0	28.6	6.7	31.7	-	36.6	53.9	17.3	
Hori	4512.000	AV	31.9	30.5	8.1	31.4	-	39.1	53.9	14.8	Floor noise
Hori	5414.400	AV	31.7	32.2	8.4	31.3	-	41.0	53.9	12.9	Floor noise
Hori	6316.800	AV	34.2	34.3	8.9	31.7	-	45.7	53.9	8.2	
Hori	7219.200	AV	33.5	36.5	9.5	32.4	-	47.1	53.9	6.8	Floor noise
Hori	8121.600	AV	33.1	36.9	9.6	32.7	-	46.9	53.9	7.0	Floor noise
Hori	9024.000	AV	33.2	36.9	10.0	32.3	-	47.8	53.9	6.1	Floor noise
Vert	56.815	QP	37.2	8.3	7.8	38.7	-	14.6	40.0	25.4	
Vert	68.821	QP	33.5	6.2	8.0	38.7	-	9.0	40.0	31.0	
Vert	98.326	QP	33.5	9.6	8.5	38.8	-	12.8	43.5	30.7	
Vert	960.000	QP	27.5	22.1	14.7	37.7	-	26.6	46.0	19.4	
Vert	1804.800	PK	41.0	26.3	5.4	32.7	-	40.0	73.9	33.9	Floor noise
Vert	2707.200	PK	44.7	27.8	5.7	31.9	-	46.3	73.9	27.6	
Vert	3609.600	PK	40.1	28.6	6.7	31.7	-	43.7	73.9	30.2	Floor noise
Vert	4512.000	PK	40.0	30.5	8.1	31.4	-	47.2	73.9	26.7	Floor noise
Vert	5414.400	PK	40.3	32.2	8.4	31.3	-	49.6	73.9	24.3	Floor noise
Vert	6316.800	PK	42.7	34.3	8.9	31.7	-	54.2	73.9	19.7	
Vert	7219.200	PK	40.6	36.5	9.5	32.4	-	54.2	73.9	19.7	Floor noise
Vert	8121.600	PK	41.6	36.9	9.6	32.7	-	55.4	73.9	18.5	Floor noise
Vert	9024.000	PK	40.9	36.9	10.0	32.3	-	55.5	73.9	18.4	Floor noise
Vert	1804.800	AV	33.2	26.3	5.4	32.7	-	32.2	53.9	21.7	Floor noise
Vert	2707.200	AV	37.6	27.8	5.7	31.9	-	39.2	53.9	14.7	
Vert	3609.600	AV	32.2	28.6	6.7	31.7	-	35.8	53.9	18.1	Floor noise
Vert	4512.000	AV	31.7	30.5	8.1	31.4	-	38.9	53.9	15.0	Floor noise
Vert	5414.400	AV	31.9	32.2	8.4	31.3	-	41.2	53.9	12.7	Floor noise
Vert	6316.800	AV	34.2	34.3	8.9	31.7	-	45.7	53.9	8.2	
Vert	7219.200	AV	33.3	36.5	9.5	32.4	-	46.9	53.9	7.0	Floor noise
Vert	8121.600	AV	33.2	36.9	9.6	32.7	-	47.0	53.9	6.9	Floor noise
Vert	9024.000	AV	33.2	36.9	10.0	32.3	-	47.8	53.9	6.1	Floor noise

Result = Reading + Ant Factor + Loss (Cable+Attenuator+Filter+Distance factor(above 1 GHz)) - Gain(Amplifier)

*Other frequency noises omitted in this report were not seen or had enough margin (more than 20 dB).

Distance factor: 1 GHz - 10 GHz 20log(4.0 m / 3.0 m) = 2.5 dB

UL Japan, Inc.

Ise EMC Lab.

4383-326 Asama-cho, Ise-shi, Mie-ken 516-0021 JAPAN

Telephone : +81 596 24 8999

Facsimile : +81 596 24 8124

Radiated Spurious Emission
(Internal Antenna)

Test place : Ise EMC Lab.
Report No. : 12160939H
Semi Anechoic Chamber : No.1
Date : February 13, 2018
Temperature / Humidity : 21 deg. C / 37 % RH
Engineer : Koji Yamamoto
(Below 1 GHz)
Mode : Tx 902.4 MHz

20dBc Data Sheet

Polarity	Frequency [MHz]	Detector	Reading [dBuV]	Ant Factor [dB/m]	Loss [dB]	Gain [dB]	Result [dBuV/m]	Limit [dBuV/m]	Margin [dB]	Remark
Hori	902.400	PK	110.6	21.8	14.4	38.0	108.8	-	-	Carrier
Hori	902.000	PK	77.1	21.8	14.4	38.0	75.3	88.8	13.5	
Vert	902.400	PK	108.2	21.8	14.4	38.0	106.4	-	-	Carrier
Vert	902.000	PK	74.6	21.8	14.4	38.0	72.8	86.4	13.6	

Result = Reading + Ant Factor + Loss (Cable + Attenuator + Distance factor (above 1 GHz)) - Gain (Amprifier)

UL Japan, Inc.

Ise EMC Lab.

4383-326 Asama-cho, Ise-shi, Mie-ken 516-0021 JAPAN

Telephone : +81 596 24 8999

Facsimile : +81 596 24 8124

Radiated Spurious Emission
Reference Plot for band-edge (Internal Antenna)

Test place : Ise EMC Lab.
Report No. : 12160939H
Semi Anechoic Chamber : No.1
Date : February 13, 2018
Temperature / Humidity : 21 deg. C / 37 % RH
Engineer : Koji Yamamoto
(Below 1 GHz)
Mode : Tx 902.4 MHz

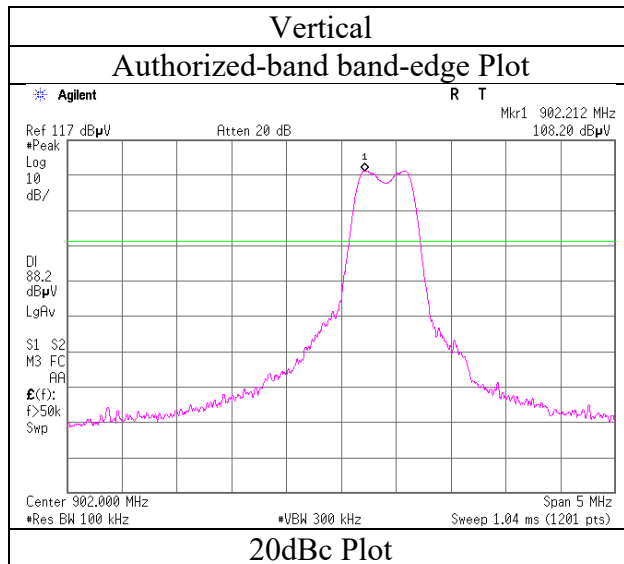
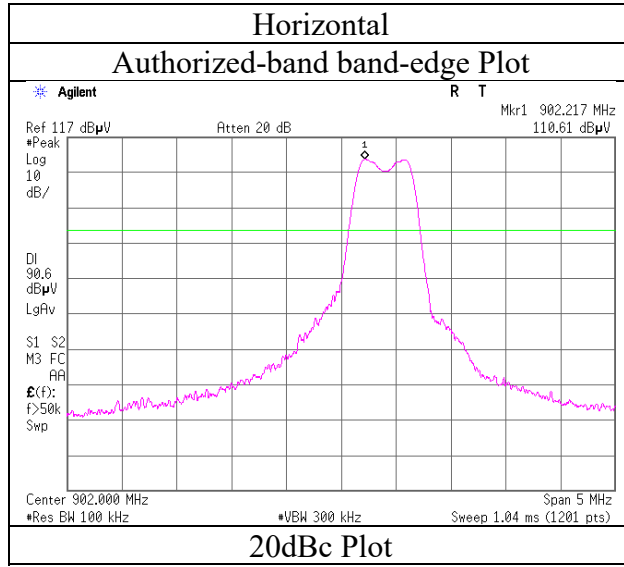

* Final result of restricted band edge was shown in tabular data.

Radiated Spurious Emission
(Internal Antenna)

Test place	Ise EMC Lab.	
Report No.	12160939H	
Semi Anechoic Chamber	No.1	No.4
Date	February 13, 2018	February 9, 2018
Temperature / Humidity	21 deg. C / 37 % RH	21 deg. C / 34 % RH
Engineer	Koji Yamamoto (Below 1 GHz)	Takafumi Noguchi (Above 1 GHz)
Mode	Tx 915.0 MHz	

Polarity	Frequency [MHz]	Detector	Reading [dBuV]	Ant.Fac. [dB/m]	Loss [dB]	Gain [dB]	Duty Factor [dB]	Result [dBuV/m]	Limit [dBuV/m]	Margin [dB]	Remark
Hori	49.158	QP	32.8	10.9	7.7	38.7	-	12.7	40.0	27.3	
Hori	56.815	QP	31.7	8.3	7.8	38.7	-	9.1	40.0	30.9	
Hori	98.337	QP	32.9	9.6	8.5	38.8	-	12.2	43.5	31.3	
Hori	228.869	QP	29.1	11.5	9.9	38.8	-	11.7	46.0	34.3	
Hori	516.722	QP	28.3	17.8	12.1	38.3	-	19.9	46.0	26.1	
Hori	960.000	QP	27.5	22.1	14.7	37.7	-	26.6	46.0	19.4	
Hori	1830.000	PK	43.3	26.4	5.4	32.6	-	42.5	73.9	31.4	
Hori	2745.000	PK	47.4	27.9	5.8	31.9	-	49.2	73.9	24.7	
Hori	3660.000	PK	41.3	28.7	6.7	31.6	-	45.1	73.9	28.8	Floor noise
Hori	4575.000	PK	39.8	30.8	8.1	31.3	-	47.4	73.9	26.5	Floor noise
Hori	5490.000	PK	39.9	32.2	8.4	31.3	-	49.2	73.9	24.7	Floor noise
Hori	6405.000	PK	40.4	34.6	9.0	31.8	-	52.2	73.9	21.7	Floor noise
Hori	7320.000	PK	41.2	36.6	9.5	32.4	-	54.9	73.9	19.0	Floor noise
Hori	8235.000	PK	42.1	36.7	9.7	32.7	-	55.8	73.9	18.1	Floor noise
Hori	9150.000	PK	41.1	37.2	10.0	32.4	-	55.9	73.9	18.0	Floor noise
Hori	1830.000	AV	34.2	26.4	5.4	32.6	-	33.4	53.9	20.5	
Hori	2745.000	AV	41.5	27.9	5.8	31.9	-	43.3	53.9	10.6	
Hori	3660.000	AV	32.2	28.7	6.7	31.6	-	36.0	53.9	17.9	Floor noise
Hori	4575.000	AV	31.9	30.8	8.1	31.3	-	39.5	53.9	14.4	Floor noise
Hori	5490.000	AV	31.3	32.2	8.4	31.3	-	40.6	53.9	13.3	Floor noise
Hori	6405.000	AV	32.4	34.6	9.0	31.8	-	44.2	53.9	9.7	Floor noise
Hori	7320.000	AV	33.4	36.6	9.5	32.4	-	47.1	53.9	6.8	Floor noise
Hori	8235.000	AV	33.2	36.7	9.7	32.7	-	46.9	53.9	7.0	Floor noise
Hori	9150.000	AV	33.0	37.2	10.0	32.4	-	47.8	53.9	6.1	Floor noise
Vert	49.158	QP	33.2	10.9	7.7	38.7	-	13.1	40.0	26.9	
Vert	56.815	QP	35.1	8.3	7.8	38.7	-	12.5	40.0	27.5	
Vert	98.337	QP	33.8	9.6	8.5	38.8	-	13.1	43.5	30.4	
Vert	228.869	QP	28.6	11.5	9.9	38.8	-	11.2	46.0	34.8	
Vert	516.722	QP	28.6	17.8	12.1	38.3	-	20.2	46.0	25.8	
Vert	960.000	QP	27.5	22.1	14.7	37.7	-	26.6	46.0	19.4	
Vert	1830.000	PK	40.3	26.4	5.4	32.6	-	39.5	73.9	34.4	Floor noise
Vert	2745.000	PK	44.3	27.9	5.8	31.9	-	46.1	73.9	27.8	
Vert	3660.000	PK	40.3	28.7	6.7	31.6	-	44.1	73.9	29.8	Floor noise
Vert	4575.000	PK	40.6	30.8	8.1	31.3	-	48.2	73.9	25.7	Floor noise
Vert	5490.000	PK	40.4	32.2	8.4	31.3	-	49.7	73.9	24.2	Floor noise
Vert	6405.000	PK	41.3	34.6	9.0	31.8	-	53.1	73.9	20.8	
Vert	7320.000	PK	41.2	36.6	9.5	32.4	-	54.9	73.9	19.0	Floor noise
Vert	8235.000	PK	40.5	36.7	9.7	32.7	-	54.2	73.9	19.7	Floor noise
Vert	9150.000	PK	40.4	37.2	10.0	32.4	-	55.2	73.9	18.7	Floor noise
Vert	1830.000	AV	33.3	26.4	5.4	32.6	-	32.5	53.9	21.4	Floor noise
Vert	2745.000	AV	37.4	27.9	5.8	31.9	-	39.2	53.9	14.7	
Vert	3660.000	AV	32.5	28.7	6.7	31.6	-	36.3	53.9	17.6	Floor noise
Vert	4575.000	AV	32.1	30.8	8.1	31.3	-	39.7	53.9	14.2	Floor noise
Vert	5490.000	AV	31.8	32.2	8.4	31.3	-	41.1	53.9	12.8	Floor noise
Vert	6405.000	AV	34.0	34.6	9.0	31.8	-	45.8	53.9	8.1	
Vert	7320.000	AV	33.4	36.6	9.5	32.4	-	47.1	53.9	6.8	Floor noise
Vert	8235.000	AV	33.1	36.7	9.7	32.7	-	46.8	53.9	7.1	Floor noise
Vert	9150.000	AV	33.0	37.2	10.0	32.4	-	47.8	53.9	6.1	Floor noise

Result = Reading + Ant Factor + Loss (Cable+Attenuator+Filter+Distance factor(above 1 GHz)) - Gain(Amplifier)

*Other frequency noises omitted in this report were not seen or had enough margin (more than 20 dB).

Distance factor: 1 GHz - 10 GHz $20\log(4.0\text{ m} / 3.0\text{ m}) = 2.5\text{ dB}$

UL Japan, Inc.

Ise EMC Lab.

4383-326 Asama-cho, Ise-shi, Mie-ken 516-0021 JAPAN

Telephone : +81 596 24 8999

Facsimile : +81 596 24 8124

Radiated Spurious Emission
(Internal Antenna)

Test place	Ise EMC Lab.	
Report No.	12160939H	
Semi Anechoic Chamber	No.1	No.4
Date	February 13, 2018	February 9, 2018
Temperature / Humidity	21 deg. C / 37 % RH	21 deg. C / 34 % RH
Engineer	Koji Yamamoto (Below 1 GHz)	Takafumi Noguchi (Above 1 GHz)
Mode	Tx 927.6 MHz	

Polarity	Frequency [MHz]	Detector	Reading [dBuV]	Ant.Fac. [dB/m]	Loss [dB]	Gain [dB]	Duty Factor [dB]	Result [dBuV/m]	Limit [dBuV/m]	Margin [dB]	Remark
Hori	56.815	QP	31.5	8.3	7.8	38.7	-	8.9	40.0	31.1	
Hori	98.326	QP	31.3	9.6	8.5	38.8	-	10.6	43.5	32.9	
Hori	228.570	QP	31.7	11.5	9.9	38.8	-	14.3	46.0	31.7	
Hori	960.000	QP	27.6	22.1	14.7	37.7	-	26.7	46.0	19.3	
Hori	1855.200	PK	42.0	26.5	5.5	32.6	-	41.4	73.9	32.5	
Hori	2782.800	PK	46.4	28.0	5.8	31.9	-	48.3	73.9	25.6	
Hori	3710.400	PK	40.6	28.8	6.9	31.6	-	44.7	73.9	29.2	Floor noise
Hori	4638.000	PK	39.5	31.0	8.2	31.3	-	47.4	73.9	26.5	Floor noise
Hori	5565.600	PK	39.1	32.3	8.5	31.4	-	48.5	73.9	25.4	Floor noise
Hori	6493.200	PK	41.3	34.9	9.1	31.9	-	53.4	73.9	20.5	
Hori	7420.800	PK	41.0	36.7	9.5	32.5	-	54.7	73.9	19.2	Floor noise
Hori	8348.400	PK	41.5	36.6	9.7	32.6	-	55.2	73.9	18.7	Floor noise
Hori	9276.000	PK	40.4	37.4	10.1	32.5	-	55.4	73.9	18.5	Floor noise
Hori	1855.200	AV	34.5	26.5	5.5	32.6	-	33.9	53.9	20.0	
Hori	2782.800	AV	40.8	28.0	5.8	31.9	-	42.7	53.9	11.2	
Hori	3710.400	AV	32.2	28.8	6.9	31.6	-	36.3	53.9	17.6	Floor noise
Hori	4638.000	AV	31.9	31.0	8.2	31.3	-	39.8	53.9	14.1	Floor noise
Hori	5565.600	AV	31.6	32.3	8.5	31.4	-	41.0	53.9	12.9	Floor noise
Hori	6493.200	AV	33.4	34.9	9.1	31.9	-	45.5	53.9	8.4	
Hori	7420.800	AV	33.2	36.7	9.5	32.5	-	46.9	53.9	7.0	Floor noise
Hori	8348.400	AV	33.9	36.6	9.7	32.6	-	47.6	53.9	6.3	Floor noise
Hori	9276.000	AV	32.5	37.4	10.1	32.5	-	47.5	53.9	6.4	Floor noise
Vert	56.815	QP	36.6	8.3	7.8	38.7	-	14.0	40.0	26.0	
Vert	98.326	QP	35.2	9.6	8.5	38.8	-	14.5	43.5	29.0	
Vert	228.570	QP	29.9	11.5	9.9	38.8	-	12.5	46.0	33.5	
Vert	960.000	QP	27.5	22.1	14.7	37.7	-	26.6	46.0	19.4	
Vert	1855.200	PK	41.1	26.5	5.5	32.6	-	40.5	73.9	33.4	Floor noise
Vert	2782.800	PK	44.4	28.0	5.8	31.9	-	46.3	73.9	27.6	
Vert	3710.400	PK	40.7	28.8	6.9	31.6	-	44.8	73.9	29.1	Floor noise
Vert	4638.000	PK	39.6	31.0	8.2	31.3	-	47.5	73.9	26.4	Floor noise
Vert	5565.600	PK	39.8	32.3	8.5	31.4	-	49.2	73.9	24.7	Floor noise
Vert	6493.200	PK	41.6	34.9	9.1	31.9	-	53.7	73.9	20.2	
Vert	7420.800	PK	40.2	36.7	9.5	32.5	-	53.9	73.9	20.0	Floor noise
Vert	8348.400	PK	40.5	36.6	9.7	32.6	-	54.2	73.9	19.7	Floor noise
Vert	9276.000	PK	40.9	37.4	10.1	32.5	-	55.9	73.9	18.0	Floor noise
Vert	1855.200	AV	33.5	26.5	5.5	32.6	-	32.9	53.9	21.0	Floor noise
Vert	2782.800	AV	37.1	28.0	5.8	31.9	-	39.0	53.9	14.9	
Vert	3710.400	AV	32.5	28.8	6.9	31.6	-	36.6	53.9	17.3	Floor noise
Vert	4638.000	AV	31.7	31.0	8.2	31.3	-	39.6	53.9	14.3	Floor noise
Vert	5565.600	AV	31.6	32.3	8.5	31.4	-	41.0	53.9	12.9	Floor noise
Vert	6493.200	AV	33.0	34.9	9.1	31.9	-	45.1	53.9	8.8	
Vert	7420.800	AV	33.3	36.7	9.5	32.5	-	47.0	53.9	6.9	Floor noise
Vert	8348.400	AV	33.8	36.6	9.7	32.6	-	47.5	53.9	6.4	Floor noise
Vert	9276.000	AV	32.5	37.4	10.1	32.5	-	47.5	53.9	6.4	Floor noise

Result = Reading + Ant Factor + Loss (Cable+Attenuator+Filter+Distance factor(above 1 GHz)) - Gain(Amplifier)

*Other frequency noises omitted in this report were not seen or had enough margin (more than 20 dB).

Distance factor: 1 GHz - 10 GHz $20\log(4.0\text{ m} / 3.0\text{ m}) = 2.5\text{ dB}$

UL Japan, Inc.

Ise EMC Lab.

4383-326 Asama-cho, Ise-shi, Mie-ken 516-0021 JAPAN

Telephone : +81 596 24 8999

Facsimile : +81 596 24 8124

Radiated Spurious Emission
(Internal Antenna)

Test place : Ise EMC Lab.
Report No. : 12160939H
Semi Anechoic Chamber : No.1
Date : February 13, 2018
Temperature / Humidity : 21 deg. C / 37 % RH
Engineer : Koji Yamamoto
(Below 1 GHz)
Mode : Tx 927.6 MHz

20dBc Data Sheet

Polarity	Frequency [MHz]	Detector	Reading [dBuV]	Ant Factor [dB/m]	Loss [dB]	Gain [dB]	Result [dBuV/m]	Limit [dBuV/m]	Margin [dB]	Remark
Hori	927.600	PK	107.8	21.9	14.6	37.9	106.4	-	-	Carrier
Hori	928.000	PK	70.6	21.9	14.6	37.9	69.2	86.4	17.2	
Vert	927.600	PK	108.5	21.9	14.6	37.9	107.1	-	-	Carrier
Vert	928.000	PK	70.8	21.9	14.6	37.9	69.4	87.1	17.7	

Result = Reading + Ant Factor + Loss (Cable + Attenuator + Distance factor (above 1 GHz)) - Gain (Amprifier)

Radiated Spurious Emission
Reference Plot for band-edge (Internal Antenna)

Test place : Ise EMC Lab.
Report No. : 12160939H
Semi Anechoic Chamber : No.1
Date : February 13, 2018
Temperature / Humidity : 21 deg. C / 37 % RH
Engineer : Koji Yamamoto
(Below 1 GHz)
Mode : Tx 927.6 MHz

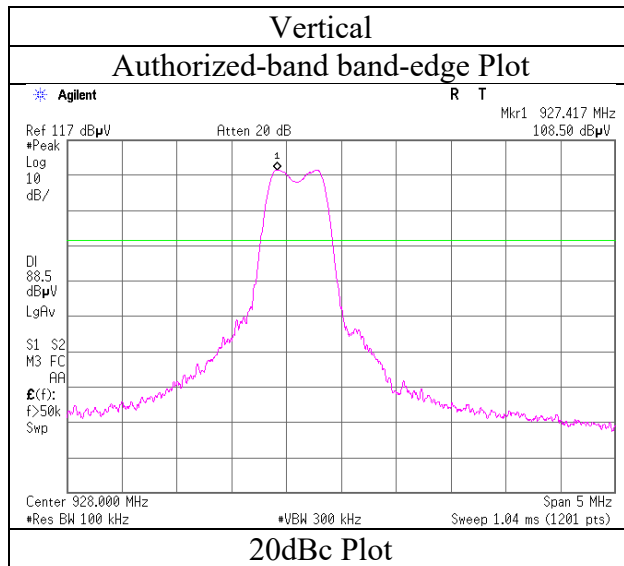
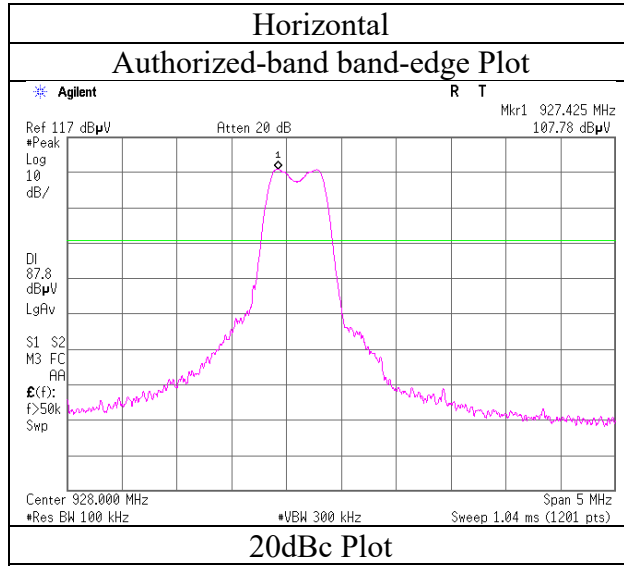

* Final result of restricted band edge was shown in tabular data.

Radiated Spurious Emission
(Sleeve Antenna)

Test place	Ise EMC Lab.	
Report No.	12160939H	
Semi Anechoic Chamber	No.1	No.4
Date	February 14, 2018	February 15, 2018
Temperature / Humidity	24 deg. C / 40 % RH	22 deg. C / 39 % RH
Engineer	Ken Fujita (Below 1 GHz)	Koji Yamamoto (Above 1 GHz)
Mode	Tx 902.4 MHz	

Polarity	Frequency [MHz]	Detector	Reading [dBuV]	Ant.Fac. [dB/m]	Loss [dB]	Gain [dB]	Duty Factor [dB]	Result [dBuV/m]	Limit [dBuV/m]	Margin [dB]	Remark
Hori	32.267	QP	29.6	16.9	17.5	38.7	-	25.3	40.0	14.7	
Hori	65.417	QP	29.3	6.6	18.2	38.7	-	15.4	40.0	24.6	
Hori	96.017	QP	34.4	9.3	18.6	38.8	-	23.5	43.5	20.0	
Hori	141.917	QP	29.0	14.4	19.2	38.9	-	23.7	43.5	19.8	
Hori	288.000	QP	39.5	13.0	20.6	38.8	-	34.3	46.0	11.7	
Hori	1804.800	PK	42.2	26.3	5.7	32.7	-	41.5	73.9	32.4	Floor noise
Hori	2707.200	PK	46.6	27.8	6.0	31.9	-	48.5	73.9	25.4	
Hori	3609.600	PK	41.6	28.6	6.4	31.7	-	44.9	73.9	29.0	Floor noise
Hori	4512.000	PK	41.2	30.5	6.8	31.4	-	47.1	73.9	26.8	Floor noise
Hori	5414.400	PK	41.8	32.2	7.3	31.3	-	50.0	73.9	23.9	Floor noise
Hori	6316.800	PK	44.7	34.3	7.7	31.7	-	55.0	73.9	18.9	
Hori	7219.200	PK	40.8	36.5	8.0	32.4	-	52.9	73.9	21.0	Floor noise
Hori	8121.600	PK	42.2	36.9	8.2	32.7	-	54.6	73.9	19.3	Floor noise
Hori	9024.000	PK	40.8	36.9	8.4	32.3	-	53.8	73.9	20.1	Floor noise
Hori	1804.800	AV	33.3	26.3	5.7	32.7	-	32.6	53.9	21.3	Floor noise
Hori	2707.200	AV	37.8	27.8	6.0	31.9	-	39.7	53.9	14.2	
Hori	3609.600	AV	32.2	28.6	6.4	31.7	-	35.5	53.9	18.4	Floor noise
Hori	4512.000	AV	31.6	30.5	6.8	31.4	-	37.5	53.9	16.4	Floor noise
Hori	5414.400	AV	31.6	32.2	7.3	31.3	-	39.8	53.9	14.1	Floor noise
Hori	6316.800	AV	34.3	34.3	7.7	31.7	-	44.6	53.9	9.3	
Hori	7219.200	AV	33.1	36.5	8.0	32.4	-	45.2	53.9	8.7	Floor noise
Hori	8121.600	AV	33.1	36.9	8.2	32.7	-	45.5	53.9	8.4	Floor noise
Hori	9024.000	AV	32.9	36.9	8.4	32.3	-	45.9	53.9	8.0	Floor noise
Vert	32.267	QP	29.0	16.9	17.5	38.7	-	24.7	40.0	15.3	
Vert	65.133	QP	29.3	6.7	18.2	38.7	-	15.5	40.0	24.5	
Vert	96.017	QP	34.8	9.3	18.6	38.8	-	23.9	43.5	19.6	
Vert	142.484	QP	29.2	14.4	19.2	38.9	-	23.9	43.5	19.6	
Vert	288.000	QP	35.8	13.0	20.6	38.8	-	30.6	46.0	15.4	
Vert	1804.800	PK	41.7	26.3	5.7	32.7	-	41.0	73.9	32.9	Floor noise
Vert	2707.200	PK	47.1	27.8	6.0	31.9	-	49.0	73.9	24.9	
Vert	3609.600	PK	41.0	28.6	6.4	31.7	-	44.3	73.9	29.6	Floor noise
Vert	4512.000	PK	41.5	30.5	6.8	31.4	-	47.4	73.9	26.5	Floor noise
Vert	5414.400	PK	42.0	32.2	7.3	31.3	-	50.2	73.9	23.7	Floor noise
Vert	6316.800	PK	44.3	34.3	7.7	31.7	-	54.6	73.9	19.3	
Vert	7219.200	PK	40.6	36.5	8.0	32.4	-	52.7	73.9	21.2	Floor noise
Vert	8121.600	PK	42.5	36.9	8.2	32.7	-	54.9	73.9	19.0	Floor noise
Vert	9024.000	PK	41.2	36.9	8.4	32.3	-	54.2	73.9	19.7	Floor noise
Vert	1804.800	AV	33.5	26.3	5.7	32.7	-	32.8	53.9	21.1	Floor noise
Vert	2707.200	AV	39.5	27.8	6.0	31.9	-	41.4	53.9	12.5	
Vert	3609.600	AV	31.8	28.6	6.4	31.7	-	35.1	53.9	18.8	Floor noise
Vert	4512.000	AV	31.8	30.5	6.8	31.4	-	37.7	53.9	16.2	Floor noise
Vert	5414.400	AV	31.7	32.2	7.3	31.3	-	39.9	53.9	14.0	Floor noise
Vert	6316.800	AV	34.9	34.3	7.7	31.7	-	45.2	53.9	8.7	
Vert	7219.200	AV	33.5	36.5	8.0	32.4	-	45.6	53.9	8.3	Floor noise
Vert	8121.600	AV	33.2	36.9	8.2	32.7	-	45.6	53.9	8.3	Floor noise
Vert	9024.000	AV	32.7	36.9	8.4	32.3	-	45.7	53.9	8.2	Floor noise

Result = Reading + Ant Factor + Loss (Cable+Attenuator+Filter+Distance factor(above 1 GHz)) - Gain(Amplifier)
*Other frequency noises omitted in this report were not seen or had enough margin (more than 20 dB).

Distance factor: 1 GHz - 10 GHz 20log (4.0 m / 3.0 m) = 2.5 dB

UL Japan, Inc.

Ise EMC Lab.

4383-326 Asama-cho, Ise-shi, Mie-ken 516-0021 JAPAN

Telephone : +81 596 24 8999

Facsimile : +81 596 24 8124

Radiated Spurious Emission
(Sleeve Antenna)

Test place : Ise EMC Lab.
Report No. : 12160939H
Semi Anechoic Chamber : No.1
Date : February 13, 2018
Temperature / Humidity : 21 deg. C / 37 % RH
Engineer : Ken Fujita
(Below 1 GHz)
Mode : Tx 902.4 MHz

20dBc Data Sheet

Polarity	Frequency [MHz]	Detector	Reading [dBuV]	Ant Factor [dB/m]	Loss [dB]	Gain [dB]	Result [dBuV/m]	Limit [dBuV/m]	Margin [dB]	Remark
Hori	902.400	PK	103.2	21.8	14.4	38.0	101.4	-	-	Carrier
Hori	902.000	PK	77.1	21.8	14.4	38.0	75.3	81.4	6.1	
Vert	902.400	PK	103.2	21.8	14.4	38.0	101.4	-	-	Carrier
Vert	902.000	PK	74.6	21.8	14.4	38.0	72.8	81.4	8.6	

Result = Reading + Ant Factor + Loss (Cable + Attenuator + Distance factor (above 1 GHz)) - Gain (Amprifier)

Radiated Spurious Emission
Reference Plot for band-edge (Sleeve Antenna)

Test place : Ise EMC Lab.
Report No. : 12160939H
Semi Anechoic Chamber : No.1
Date : February 13, 2018
Temperature / Humidity : 21 deg. C / 37 % RH
Engineer : Ken Fujita
(Below 1 GHz)
Mode : Tx 902.4 MHz

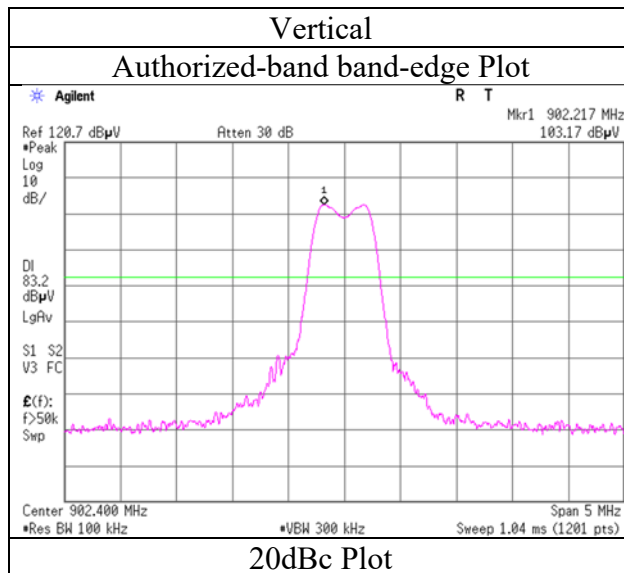
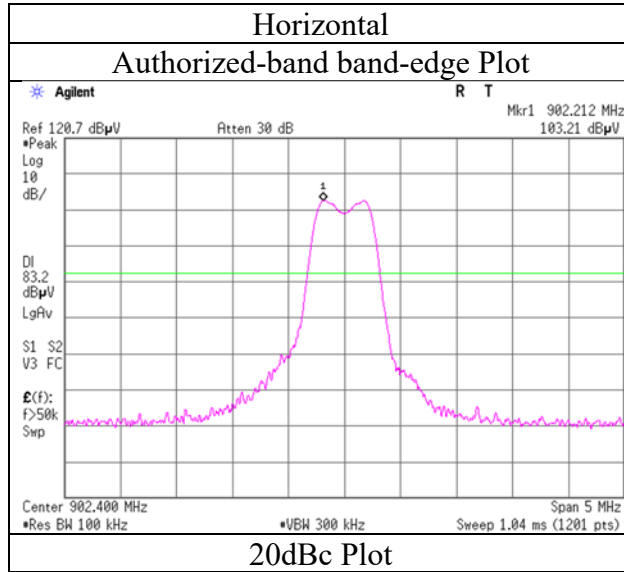

* Final result of restricted band edge was shown in tabular data.

Radiated Spurious Emission
(Sleeve Antenna)

Test place	Ise EMC Lab.	
Report No.	12160939H	
Semi Anechoic Chamber	No.1	No.4
Date	February 14, 2018	February 15, 2018
Temperature / Humidity	24 deg. C / 40 % RH	22 deg. C / 39 % RH
Engineer	Ken Fujita (Below 1 GHz)	Koji Yamamoto (Above 1 GHz)
Mode	Tx 915.0 MHz	

Polarity	Frequency [MHz]	Detector	Reading [dBuV]	Ant.Fac. [dB/m]	Loss [dB]	Gain [dB]	Duty Factor [dB]	Result [dBuV/m]	Limit [dBuV/m]	Margin [dB]	Remark
Hori	32.321	QP	29.3	16.9	17.5	38.7	-	25.0	40.0	15.0	
Hori	65.421	QP	29.4	6.6	18.2	38.7	-	15.5	40.0	24.5	
Hori	96.012	QP	34.2	9.3	18.6	38.8	-	23.3	43.5	20.2	
Hori	141.998	QP	29.1	14.4	19.2	38.9	-	23.8	43.5	19.7	
Hori	288.012	QP	39.3	13.0	20.6	38.8	-	34.1	46.0	11.9	
Hori	758.665	QP	31.2	20.2	23.9	38.0	-	37.3	46.0	8.7	
Hori	1830.000	PK	42.5	26.4	5.7	32.6	-	42.0	73.9	31.9	Floor noise
Hori	2745.000	PK	45.8	27.9	6.1	31.9	-	47.9	73.9	26.0	
Hori	3660.000	PK	40.6	28.7	6.4	31.6	-	44.1	73.9	29.8	Floor noise
Hori	4575.000	PK	41.1	30.8	6.8	31.3	-	47.4	73.9	26.5	Floor noise
Hori	5490.000	PK	40.8	32.2	7.3	31.3	-	49.0	73.9	24.9	Floor noise
Hori	6405.000	PK	43.5	34.6	7.7	31.8	-	54.0	73.9	19.9	
Hori	7320.000	PK	42.0	36.6	8.0	32.4	-	54.2	73.9	19.7	Floor noise
Hori	8235.000	PK	42.2	36.7	8.2	32.7	-	54.4	73.9	19.5	Floor noise
Hori	9150.000	PK	41.9	37.2	8.4	32.4	-	55.1	73.9	18.8	Floor noise
Hori	1830.000	AV	32.8	26.4	5.7	32.6	-	32.3	53.9	21.6	Floor noise
Hori	2745.000	AV	38.7	27.9	6.1	31.9	-	40.8	53.9	13.1	
Hori	3660.000	AV	31.8	28.7	6.4	31.6	-	35.3	53.9	18.6	Floor noise
Hori	4575.000	AV	32.5	30.8	6.8	31.3	-	38.8	53.9	15.1	Floor noise
Hori	5490.000	AV	31.5	32.2	7.3	31.3	-	39.7	53.9	14.2	Floor noise
Hori	6405.000	AV	33.3	34.6	7.7	31.8	-	43.8	53.9	10.1	
Hori	7320.000	AV	31.9	36.6	8.0	32.4	-	44.1	53.9	9.8	Floor noise
Hori	8235.000	AV	32.5	36.7	8.2	32.7	-	44.7	53.9	9.2	Floor noise
Hori	9150.000	AV	31.8	37.2	8.4	32.4	-	45.0	53.9	8.9	Floor noise
Vert	32.267	QP	29.2	16.9	17.5	38.7	-	24.9	40.0	15.1	
Vert	65.133	QP	29.4	6.7	18.2	38.7	-	15.6	40.0	24.4	
Vert	96.017	QP	34.6	9.3	18.6	38.8	-	23.7	43.5	19.8	
Vert	142.484	QP	29.4	14.4	19.2	38.9	-	24.1	43.5	19.4	
Vert	288.012	QP	35.7	13.0	20.6	38.8	-	30.5	46.0	15.5	
Vert	761.331	QP	29.9	20.2	23.9	38.0	-	36.0	46.0	10.0	
Vert	1830.000	PK	41.9	26.4	5.7	32.6	-	41.4	73.9	32.5	Floor noise
Vert	2745.000	PK	46.5	27.9	6.1	31.9	-	48.6	73.9	25.3	
Vert	3660.000	PK	41.0	28.7	6.4	31.6	-	44.5	73.9	29.4	Floor noise
Vert	4575.000	PK	40.8	30.8	6.8	31.3	-	47.1	73.9	26.8	Floor noise
Vert	5490.000	PK	40.9	32.2	7.3	31.3	-	49.1	73.9	24.8	Floor noise
Vert	6405.000	PK	43.6	34.6	7.7	31.8	-	54.1	73.9	19.8	
Vert	7320.000	PK	41.7	36.6	8.0	32.4	-	53.9	73.9	20.0	Floor noise
Vert	8235.000	PK	43.2	36.7	8.2	32.7	-	55.4	73.9	18.5	Floor noise
Vert	9150.000	PK	42.1	37.2	8.4	32.4	-	55.3	73.9	18.6	Floor noise
Vert	1830.000	AV	32.5	26.4	5.7	32.6	-	32.0	53.9	21.9	Floor noise
Vert	2745.000	AV	39.2	27.9	6.1	31.9	-	41.3	53.9	12.6	
Vert	3660.000	AV	31.6	28.7	6.4	31.6	-	35.1	53.9	18.8	Floor noise
Vert	4575.000	AV	32.7	30.8	6.8	31.3	-	39.0	53.9	14.9	Floor noise
Vert	5490.000	AV	31.5	32.2	7.3	31.3	-	39.7	53.9	14.2	Floor noise
Vert	6405.000	AV	33.5	34.6	7.7	31.8	-	44.0	53.9	9.9	
Vert	7320.000	AV	31.6	36.6	8.0	32.4	-	43.8	53.9	10.1	Floor noise
Vert	8235.000	AV	32.2	36.7	8.2	32.7	-	44.4	53.9	9.5	Floor noise
Vert	9150.000	AV	31.3	37.2	8.4	32.4	-	44.5	53.9	9.4	Floor noise

Result = Reading + Ant Factor + Loss (Cable+Attenuator+Filter+Distance factor(above 1 GHz)) - Gain(Amplifier)

*Other frequency noises omitted in this report were not seen or had enough margin (more than 20 dB).

Distance factor: 1 GHz - 10 GHz 20log(4.0 m / 3.0 m) = 2.5 dB

UL Japan, Inc.

Ise EMC Lab.

4383-326 Asama-cho, Ise-shi, Mie-ken 516-0021 JAPAN

Telephone : +81 596 24 8999

Facsimile : +81 596 24 8124

Radiated Spurious Emission
(Sleeve Antenna)

Test place	Ise EMC Lab.	
Report No.	12160939H	
Semi Anechoic Chamber	No.1	No.4
Date	February 14, 2018	February 15, 2018
Temperature / Humidity	24 deg. C / 40 % RH	22 deg. C / 39 % RH
Engineer	Ken Fujita (Below 1 GHz)	Koji Yamamoto (Above 1 GHz)
Mode	Tx 927.6 MHz	

Polarity	Frequency [MHz]	Detector	Reading [dBuV]	Ant.Fac. [dB/m]	Loss [dB]	Gain [dB]	Duty Factor [dB]	Result [dBuV/m]	Limit [dBuV/m]	Margin [dB]	Remark
Hori	32.321	QP	29.3	16.9	17.5	38.7	-	25.0	40.0	15.0	
Hori	65.421	QP	29.4	6.6	18.2	38.7	-	15.5	40.0	24.5	
Hori	96.012	QP	34.2	9.3	18.6	38.8	-	23.3	43.5	20.2	
Hori	141.998	QP	29.1	14.4	19.2	38.9	-	23.8	43.5	19.7	
Hori	288.012	QP	39.3	13.0	20.6	38.8	-	34.1	46.0	11.9	
Hori	758.665	QP	31.2	20.2	23.9	38.0	-	37.3	46.0	8.7	
Hori	1855.200	PK	42.5	26.5	5.8	32.6	-	42.2	73.9	31.7	Floor noise
Hori	2782.800	PK	44.5	28.0	6.0	31.9	-	46.6	73.9	27.3	
Hori	3710.400	PK	40.3	28.8	6.5	31.6	-	44.0	73.9	29.9	Floor noise
Hori	4638.000	PK	41.6	31.0	6.9	31.3	-	48.2	73.9	25.7	Floor noise
Hori	5565.600	PK	40.6	32.3	7.4	31.4	-	48.9	73.9	25.0	Floor noise
Hori	6493.200	PK	44.6	34.9	7.8	31.9	-	55.4	73.9	18.5	
Hori	7420.800	PK	41.8	36.7	8.1	32.5	-	54.1	73.9	19.8	Floor noise
Hori	8348.400	PK	42.2	36.6	8.2	32.6	-	54.4	73.9	19.5	Floor noise
Hori	9276.000	PK	40.1	37.4	8.5	32.5	-	53.5	73.9	20.4	Floor noise
Hori	1855.200	AV	32.8	26.5	5.8	32.6	-	32.5	53.9	21.4	Floor noise
Hori	2782.800	AV	37.2	28.0	6.0	31.9	-	39.3	53.9	14.6	
Hori	3710.400	AV	32.5	28.8	6.5	31.6	-	36.2	53.9	17.7	Floor noise
Hori	4638.000	AV	31.5	31.0	6.9	31.3	-	38.1	53.9	15.8	Floor noise
Hori	5565.600	AV	31.3	32.3	7.4	31.4	-	39.6	53.9	14.3	Floor noise
Hori	6493.200	AV	36.0	34.9	7.8	31.9	-	46.8	53.9	7.1	
Hori	7420.800	AV	32.6	36.7	8.1	32.5	-	44.9	53.9	9.0	Floor noise
Hori	8348.400	AV	32.3	36.6	8.2	32.6	-	44.5	53.9	9.4	Floor noise
Hori	9276.000	AV	31.2	37.4	8.5	32.5	-	44.6	53.9	9.3	Floor noise
Vert	32.270	QP	29.5	16.9	17.5	38.7	-	25.2	40.0	14.8	
Vert	65.111	QP	29.2	6.7	18.2	38.7	-	15.4	40.0	24.6	
Vert	96.089	QP	34.5	9.3	18.6	38.8	-	23.6	43.5	19.9	
Vert	142.498	QP	29.3	14.4	19.2	38.9	-	24.0	43.5	19.5	
Vert	288.211	QP	35.4	13.0	20.6	38.8	-	30.2	46.0	15.8	
Vert	1855.200	PK	42.3	26.5	5.8	32.6	-	42.0	73.9	31.9	Floor noise
Vert	2782.800	PK	45.2	28.0	6.0	31.9	-	47.3	73.9	26.6	
Vert	3710.400	PK	40.1	28.8	6.5	31.6	-	43.8	73.9	30.1	Floor noise
Vert	4638.000	PK	40.7	31.0	6.9	31.3	-	47.3	73.9	26.6	Floor noise
Vert	5565.600	PK	41.1	32.3	7.4	31.4	-	49.4	73.9	24.5	Floor noise
Vert	6493.200	PK	44.1	34.9	7.8	31.9	-	54.9	73.9	19.0	
Vert	7420.800	PK	41.5	36.7	8.1	32.5	-	53.8	73.9	20.1	Floor noise
Vert	8348.400	PK	41.5	36.6	8.2	32.6	-	53.7	73.9	20.2	Floor noise
Vert	9276.000	PK	40.3	37.4	8.5	32.5	-	53.7	73.9	20.2	Floor noise
Vert	1855.200	AV	33.1	26.5	5.8	32.6	-	32.8	53.9	21.1	Floor noise
Vert	2782.800	AV	37.5	28.0	6.0	31.9	-	39.6	53.9	14.3	
Vert	3710.400	AV	31.1	28.8	6.5	31.6	-	34.8	53.9	19.1	Floor noise
Vert	4638.000	AV	31.2	31.0	6.9	31.3	-	37.8	53.9	16.1	Floor noise
Vert	5565.600	AV	32.8	32.3	7.4	31.4	-	41.1	53.9	12.8	Floor noise
Vert	6493.200	AV	35.3	34.9	7.8	31.9	-	46.1	53.9	7.8	
Vert	7420.800	AV	32.8	36.7	8.1	32.5	-	45.1	53.9	8.8	Floor noise
Vert	8348.400	AV	32.3	36.6	8.2	32.6	-	44.5	53.9	9.4	Floor noise
Vert	9276.000	AV	30.8	37.4	8.5	32.5	-	44.2	53.9	9.7	Floor noise

Result = Reading + Ant Factor + Loss (Cable+Attenuator+Filter+Distance factor(above 1 GHz)) - Gain(Amplifier)

*Other frequency noises omitted in this report were not seen or had enough margin (more than 20 dB).

Distance factor: 1 GHz - 10 GHz 20log(4.0 m / 3.0 m) = 2.5 dB

UL Japan, Inc.

Ise EMC Lab.

4383-326 Asama-cho, Ise-shi, Mie-ken 516-0021 JAPAN

Telephone : +81 596 24 8999

Facsimile : +81 596 24 8124

Radiated Spurious Emission
(Sleeve Antenna)

Test place : Ise EMC Lab.
Report No. : 12160939H
Semi Anechoic Chamber : No.1
Date : February 13, 2018
Temperature / Humidity : 21 deg. C / 37 % RH
Engineer : Ken Fujita
(Below 1 GHz)
Mode : Tx 927.6 MHz

20dBc Data Sheet

Polarity	Frequency [MHz]	Detector	Reading [dBuV]	Ant Factor [dB/m]	Loss [dB]	Gain [dB]	Result [dBuV/m]	Limit [dBuV/m]	Margin [dB]	Remark
Hori	927.600	PK	101.7	21.9	14.6	37.9	100.3	-	-	Carrier
Hori	928.000	PK	70.6	21.9	14.6	37.9	69.2	80.3	11.1	
Vert	927.600	PK	102.7	21.9	14.6	37.9	101.3	-	-	Carrier
Vert	928.000	PK	70.8	21.9	14.6	37.9	69.4	81.3	11.9	

Result = Reading + Ant Factor + Loss (Cable + Attenuator + Distance factor (above 1 GHz)) - Gain (Amprifier)

Radiated Spurious Emission
Reference Plot for band-edge (Sleeve Antenna)

Test place : Ise EMC Lab.
Report No. : 12160939H
Semi Anechoic Chamber : No.1
Date : February 13, 2018
Temperature / Humidity : 21 deg. C / 37 % RH
Engineer : Ken Fujita
(Below 1 GHz)
Mode : Tx 927.6 MHz

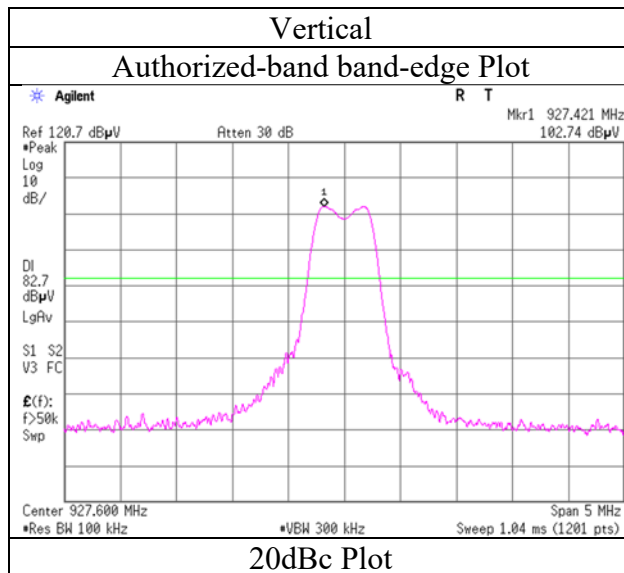
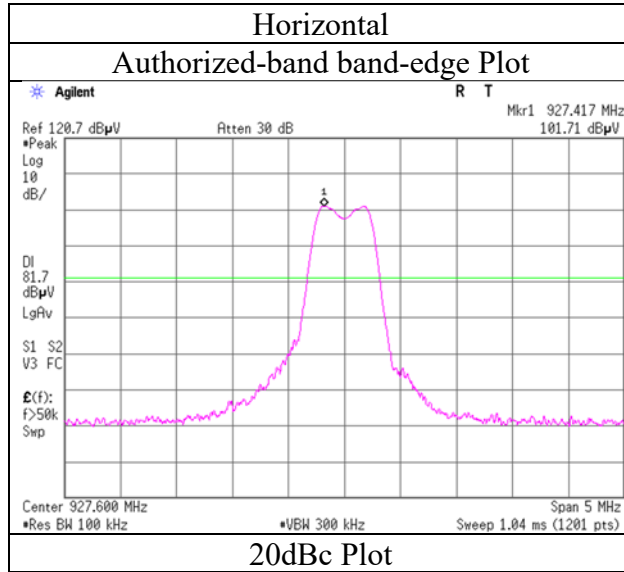

* Final result of restricted band edge was shown in tabular data.

Radiated Spurious Emission
(λ/4 Monopole Antenna)

Test place	Ise EMC Lab.	
Report No.	12160939H	
Semi Anechoic Chamber	No.1	No.4
Date	February 13, 2018	February 9, 2018
Temperature / Humidity	21 deg. C / 37 % RH	21 deg. C / 34 % RH
Engineer	Koji Yamamoto (Below 1 GHz)	Takafumi Noguchi (Above 1 GHz)
Mode	Tx 902.4 MHz	

Polarity	Frequency [MHz]	Detector	Reading [dBuV]	Ant.Fac. [dB/m]	Loss [dB]	Gain [dB]	Duty Factor [dB]	Result [dBuV/m]	Limit [dBuV/m]	Margin [dB]	Remark
Hori	96.000	QP	41.9	9.2	8.4	38.8	-	20.7	43.5	22.8	
Hori	192.000	QP	33.3	16.2	9.5	38.7	-	20.3	43.5	23.2	
Hori	287.993	QP	33.0	13.0	10.4	38.8	-	17.6	46.0	28.4	
Hori	960.000	QP	27.5	22.1	14.7	37.7	-	26.6	46.0	19.4	
Hori	1804.800	PK	41.8	26.3	5.4	32.7	-	40.8	73.9	33.1	Floor noise
Hori	2707.200	PK	48.6	27.8	5.7	31.9	-	50.2	73.9	23.7	
Hori	3609.600	PK	41.7	28.6	6.7	31.7	-	45.3	73.9	28.6	Floor noise
Hori	4512.000	PK	40.6	30.5	8.1	31.4	-	47.8	73.9	26.1	Floor noise
Hori	5414.400	PK	40.6	32.2	8.4	31.3	-	49.9	73.9	24.0	Floor noise
Hori	6316.800	PK	43.6	34.3	8.9	31.7	-	55.1	73.9	18.8	
Hori	7219.200	PK	41.9	36.5	9.5	32.4	-	55.5	73.9	18.4	Floor noise
Hori	8121.600	PK	41.7	36.9	9.6	32.7	-	55.5	73.9	18.4	Floor noise
Hori	9024.000	PK	41.0	36.9	10.0	32.3	-	55.6	73.9	18.3	Floor noise
Hori	1804.800	AV	33.5	26.3	5.4	32.7	-	32.5	53.9	21.4	Floor noise
Hori	2707.200	AV	43.8	27.8	5.7	31.9	-	45.4	53.9	8.5	
Hori	3609.600	AV	32.2	28.6	6.7	31.7	-	35.8	53.9	18.1	Floor noise
Hori	4512.000	AV	31.7	30.5	8.1	31.4	-	38.9	53.9	15.0	Floor noise
Hori	5414.400	AV	31.7	32.2	8.4	31.3	-	41.0	53.9	12.9	Floor noise
Hori	6316.800	AV	34.9	34.3	8.9	31.7	-	46.4	53.9	7.5	
Hori	7219.200	AV	33.7	36.5	9.5	32.4	-	47.3	53.9	6.6	Floor noise
Hori	8121.600	AV	33.5	36.9	9.6	32.7	-	47.3	53.9	6.6	Floor noise
Hori	9024.000	AV	33.0	36.9	10.0	32.3	-	47.6	53.9	6.3	Floor noise
Vert	96.000	QP	38.2	9.2	8.4	38.8	-	17.0	43.5	26.5	
Vert	192.000	QP	39.5	16.2	9.5	38.7	-	26.5	43.5	17.0	
Vert	287.993	QP	33.3	13.0	10.4	38.8	-	17.9	46.0	28.1	
Vert	960.000	QP	27.7	22.1	14.7	37.7	-	26.8	46.0	19.2	
Vert	1804.800	PK	40.8	26.3	5.4	32.7	-	39.8	73.9	34.1	Floor noise
Vert	2707.200	PK	49.2	27.8	5.7	31.9	-	50.8	73.9	23.1	
Vert	3609.600	PK	40.0	28.6	6.7	31.7	-	43.6	73.9	30.3	Floor noise
Vert	4512.000	PK	39.8	30.5	8.1	31.4	-	47.0	73.9	26.9	Floor noise
Vert	5414.400	PK	39.4	32.2	8.4	31.3	-	48.7	73.9	25.2	Floor noise
Vert	6316.800	PK	43.9	34.3	8.9	31.7	-	55.4	73.9	18.5	
Vert	7219.200	PK	41.7	36.5	9.5	32.4	-	55.3	73.9	18.6	Floor noise
Vert	8121.600	PK	42.2	36.9	9.6	32.7	-	56.0	73.9	17.9	Floor noise
Vert	9024.000	PK	41.9	36.9	10.0	32.3	-	56.5	73.9	17.4	Floor noise
Vert	1804.800	AV	33.5	26.3	5.4	32.7	-	32.5	53.9	21.4	Floor noise
Vert	2707.200	AV	44.4	27.8	5.7	31.9	-	46.0	53.9	7.9	
Vert	3609.600	AV	31.9	28.6	6.7	31.7	-	35.5	53.9	18.4	Floor noise
Vert	4512.000	AV	31.6	30.5	8.1	31.4	-	38.8	53.9	15.1	Floor noise
Vert	5414.400	AV	31.8	32.2	8.4	31.3	-	41.1	53.9	12.8	Floor noise
Vert	6316.800	AV	35.6	34.3	8.9	31.7	-	47.1	53.9	6.8	
Vert	7219.200	AV	33.8	36.5	9.5	32.4	-	47.4	53.9	6.5	Floor noise
Vert	8121.600	AV	33.3	36.9	9.6	32.7	-	47.1	53.9	6.8	Floor noise
Vert	9024.000	AV	33.1	36.9	10.0	32.3	-	47.7	53.9	6.2	Floor noise

Result = Reading + Ant Factor + Loss (Cable+Attenuator+Filter+Distance factor(above 1 GHz)) - Gain(Amplifier)

*Other frequency noises omitted in this report were not seen or had enough margin (more than 20 dB).

Distance factor: 1 GHz - 10 GHz 20log(4.0 m / 3.0 m) = 2.5 dB

Radiated Spurious Emission
(λ/4 Monopole Antenna)

Test place : Ise EMC Lab.
Report No. : 12160939H
Semi Anechoic Chamber : No.1
Date : February 13, 2018
Temperature / Humidity : 21 deg. C / 37 % RH
Engineer : Koji Yamamoto
(Below 1 GHz)
Mode : Tx 902.4 MHz

20dBc Data Sheet

Polarity	Frequency [MHz]	Detector	Reading [dBuV]	Ant Factor [dB/m]	Loss [dB]	Gain [dB]	Result [dBuV/m]	Limit [dBuV/m]	Margin [dB]	Remark
Hori	902.400	PK	110.7	21.8	14.4	38.0	108.9	-	-	Carrier
Hori	902.000	PK	76.5	21.8	14.4	38.0	74.7	88.9	14.2	
Vert	902.400	PK	109.8	21.8	14.4	38.0	108.0	-	-	Carrier
Vert	902.000	PK	75.5	21.8	14.4	38.0	73.7	88.0	14.3	

Result = Reading + Ant Factor + Loss (Cable + Attenuator + Distance factor (above 1 GHz)) - Gain (Amprifier)

Radiated Spurious Emission
Reference Plot for band-edge ($\lambda/4$ Monopole Antenna)

Test place : Ise EMC Lab.
Report No. : 12160939H
Semi Anechoic Chamber : No.1
Date : February 13, 2018
Temperature / Humidity : 21 deg. C / 37 % RH
Engineer : Koji Yamamoto
(Below 1 GHz)
Mode : Tx 902.4 MHz

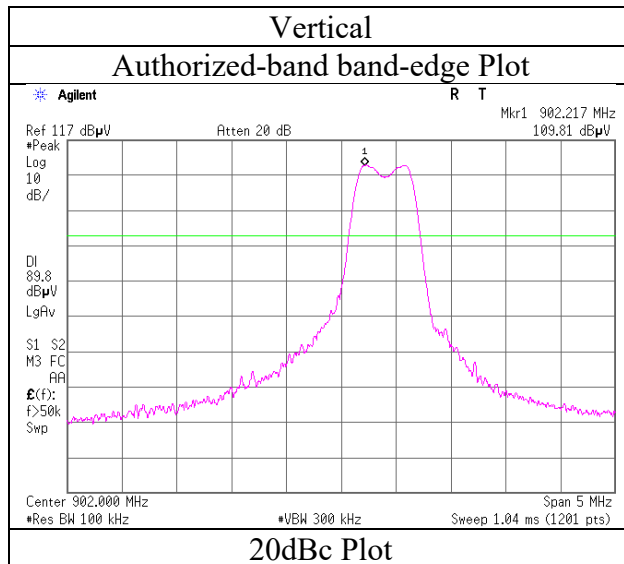
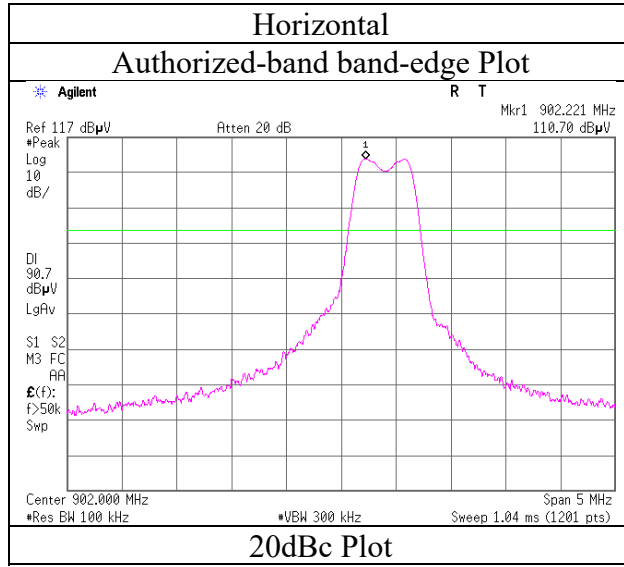

* Final result of restricted band edge was shown in tabular data.

Radiated Spurious Emission
(λ/4 Monopole Antenna)

Test place	Ise EMC Lab.	
Report No.	12160939H	
Semi Anechoic Chamber	No.1	No.4
Date	February 13, 2018	February 9, 2018
Temperature / Humidity	21 deg. C / 37 % RH	21 deg. C / 34 % RH
Engineer	Koji Yamamoto (Below 1 GHz)	Takafumi Noguchi (Above 1 GHz)
Mode	Tx 915.0 MHz	

Polarity	Frequency [MHz]	Detector	Reading [dBuV]	Ant.Fac. [dB/m]	Loss [dB]	Gain [dB]	Duty Factor [dB]	Result [dBuV/m]	Limit [dBuV/m]	Margin [dB]	Remark
Hori	96.000	QP	41.8	9.2	8.4	38.8	-	20.6	43.5	22.9	
Hori	192.000	QP	33.3	16.2	9.5	38.7	-	20.3	43.5	23.2	
Hori	287.998	QP	33.2	13.0	10.4	38.8	-	17.8	46.0	28.2	
Hori	452.772	QP	28.6	16.6	11.6	38.4	-	18.4	46.0	27.6	
Hori	960.000	QP	27.6	22.1	14.7	37.7	-	26.7	46.0	19.3	
Hori	1830.000	PK	46.1	26.4	5.4	32.6	-	45.3	73.9	28.6	
Hori	2745.000	PK	47.3	27.9	5.8	31.9	-	49.1	73.9	24.8	
Hori	3660.000	PK	40.7	28.7	6.7	31.6	-	44.5	73.9	29.4	Floor noise
Hori	4575.000	PK	41.6	30.8	8.1	31.3	-	49.2	73.9	24.7	
Hori	5490.000	PK	40.0	32.2	8.4	31.3	-	49.3	73.9	24.6	Floor noise
Hori	6405.000	PK	43.1	34.6	9.0	31.8	-	54.9	73.9	19.0	
Hori	7320.000	PK	42.3	36.6	9.5	32.4	-	56.0	73.9	17.9	Floor noise
Hori	8235.000	PK	41.1	36.7	9.7	32.7	-	54.8	73.9	19.1	Floor noise
Hori	9150.000	PK	42.0	37.2	10.0	32.4	-	56.8	73.9	17.1	Floor noise
Hori	1830.000	AV	36.5	26.4	5.4	32.6	-	35.7	53.9	18.2	
Hori	2745.000	AV	41.9	27.9	5.8	31.9	-	43.7	53.9	10.2	
Hori	3660.000	AV	32.3	28.7	6.7	31.6	-	36.1	53.9	17.8	Floor noise
Hori	4575.000	AV	32.8	30.8	8.1	31.3	-	40.4	53.9	13.5	
Hori	5490.000	AV	31.2	32.2	8.4	31.3	-	40.5	53.9	13.4	Floor noise
Hori	6405.000	AV	34.5	34.6	9.0	31.8	-	46.3	53.9	7.6	
Hori	7320.000	AV	33.6	36.6	9.5	32.4	-	47.3	53.9	6.6	Floor noise
Hori	8235.000	AV	33.3	36.7	9.7	32.7	-	47.0	53.9	6.9	Floor noise
Hori	9150.000	AV	33.1	37.2	10.0	32.4	-	47.9	53.9	6.0	Floor noise
Vert	96.000	QP	37.0	9.2	8.4	38.8	-	15.8	43.5	27.7	
Vert	192.000	QP	39.5	16.2	9.5	38.7	-	26.5	43.5	17.0	
Vert	287.998	QP	33.5	13.0	10.4	38.8	-	18.1	46.0	27.9	
Vert	452.772	QP	28.2	16.6	11.6	38.4	-	18.0	46.0	28.0	
Vert	960.000	QP	27.5	22.1	14.7	37.7	-	26.6	46.0	19.4	
Vert	1830.000	PK	40.7	26.4	5.4	32.6	-	39.9	73.9	34.0	Floor noise
Vert	2745.000	PK	47.5	27.9	5.8	31.9	-	49.3	73.9	24.6	
Vert	3660.000	PK	40.4	28.7	6.7	31.6	-	44.2	73.9	29.7	Floor noise
Vert	4575.000	PK	40.3	30.8	8.1	31.3	-	47.9	73.9	26.0	Floor noise
Vert	5490.000	PK	40.3	32.2	8.4	31.3	-	49.6	73.9	24.3	Floor noise
Vert	6405.000	PK	43.0	34.6	9.0	31.8	-	54.8	73.9	19.1	
Vert	7320.000	PK	41.7	36.6	9.5	32.4	-	55.4	73.9	18.5	Floor noise
Vert	8235.000	PK	41.4	36.7	9.7	32.7	-	55.1	73.9	18.8	Floor noise
Vert	9150.000	PK	41.0	37.2	10.0	32.4	-	55.8	73.9	18.1	Floor noise
Vert	1830.000	AV	33.1	26.4	5.4	32.6	-	32.3	53.9	21.6	Floor noise
Vert	2745.000	AV	42.5	27.9	5.8	31.9	-	44.3	53.9	9.6	
Vert	3660.000	AV	32.5	28.7	6.7	31.6	-	36.3	53.9	17.6	Floor noise
Vert	4575.000	AV	31.8	30.8	8.1	31.3	-	39.4	53.9	14.5	Floor noise
Vert	5490.000	AV	31.5	32.2	8.4	31.3	-	40.8	53.9	13.1	Floor noise
Vert	6405.000	AV	35.8	34.6	9.0	31.8	-	47.6	53.9	6.3	
Vert	7320.000	AV	33.6	36.6	9.5	32.4	-	47.3	53.9	6.6	Floor noise
Vert	8235.000	AV	33.4	36.7	9.7	32.7	-	47.1	53.9	6.8	Floor noise
Vert	9150.000	AV	33.0	37.2	10.0	32.4	-	47.8	53.9	6.1	Floor noise

Result = Reading + Ant Factor + Loss (Cable+Attenuator+Filter+Distance factor(above 1 GHz)) - Gain(Amplifier)

*Other frequency noises omitted in this report were not seen or had enough margin (more than 20 dB).

Distance factor: 1 GHz - 10 GHz 20log(4.0 m / 3.0 m) = 2.5 dB

UL Japan, Inc.

Ise EMC Lab.

4383-326 Asama-cho, Ise-shi, Mie-ken 516-0021 JAPAN

Telephone : +81 596 24 8999

Facsimile : +81 596 24 8124

Radiated Spurious Emission
(λ/4 Monopole Antenna)

Test place : Ise EMC Lab.
Report No. : 12160939H
Semi Anechoic Chamber : No.1 No.4
Date : February 13, 2018 February 9, 2018
Temperature / Humidity : 21 deg. C / 37 % RH 21 deg. C / 34 % RH
Engineer : Koji Yamamoto Takafumi Noguchi
(Below 1 GHz) (Above 1 GHz)
Mode : Tx 927.6 MHz

Polarity	Frequency [MHz]	Detector	Reading [dBuV]	Ant.Fac. [dB/m]	Loss [dB]	Gain [dB]	Duty Factor [dB]	Result [dBuV/m]	Limit [dBuV/m]	Margin [dB]	Remark
Hori	96.000	QP	42.1	9.2	8.4	38.8	-	20.9	43.5	22.6	
Hori	192.000	QP	33.1	16.2	9.5	38.7	-	20.1	43.5	23.4	
Hori	550.000	QP	28.1	18.3	12.3	38.2	-	20.5	46.0	25.5	
Hori	960.000	QP	27.5	22.1	14.7	37.7	-	26.6	46.0	19.4	
Hori	1855.200	PK	43.1	26.5	5.5	32.6	-	42.5	73.9	31.4	
Hori	2782.800	PK	44.9	28.0	5.8	31.9	-	46.8	73.9	27.1	
Hori	3710.400	PK	41.4	28.8	6.9	31.6	-	45.5	73.9	28.4	Floor noise
Hori	4638.000	PK	40.3	31.0	8.2	31.3	-	48.2	73.9	25.7	Floor noise
Hori	5565.600	PK	40.1	32.3	8.5	31.4	-	49.5	73.9	24.4	Floor noise
Hori	6493.200	PK	42.1	34.9	9.1	31.9	-	54.2	73.9	19.7	
Hori	7420.800	PK	41.7	36.7	9.5	32.5	-	55.4	73.9	18.5	Floor noise
Hori	8348.400	PK	42.2	36.6	9.7	32.6	-	55.9	73.9	18.0	Floor noise
Hori	9276.000	PK	40.5	37.4	10.1	32.5	-	55.5	73.9	18.4	Floor noise
Hori	1855.200	AV	35.2	26.5	5.5	32.6	-	34.6	53.9	19.3	
Hori	2782.800	AV	38.6	28.0	5.8	31.9	-	40.5	53.9	13.4	
Hori	3710.400	AV	32.3	28.8	6.9	31.6	-	36.4	53.9	17.5	Floor noise
Hori	4638.000	AV	31.9	31.0	8.2	31.3	-	39.8	53.9	14.1	Floor noise
Hori	5565.600	AV	31.8	32.3	8.5	31.4	-	41.2	53.9	12.7	Floor noise
Hori	6493.200	AV	33.9	34.9	9.1	31.9	-	46.0	53.9	7.9	
Hori	7420.800	AV	33.7	36.7	9.5	32.5	-	47.4	53.9	6.5	Floor noise
Hori	8348.400	AV	33.9	36.6	9.7	32.6	-	47.6	53.9	6.3	Floor noise
Hori	9276.000	AV	32.9	37.4	10.1	32.5	-	47.9	53.9	6.0	Floor noise
Vert	96.000	QP	36.5	9.2	8.4	38.8	-	15.3	43.5	28.2	
Vert	192.000	QP	39.1	16.2	9.5	38.7	-	26.1	43.5	17.4	
Vert	550.000	QP	28.0	18.3	12.3	38.2	-	20.4	46.0	25.6	
Vert	960.000	QP	27.6	22.1	14.7	37.7	-	26.7	46.0	19.3	
Vert	1855.200	PK	41.0	26.5	5.5	32.6	-	40.4	73.9	33.5	Floor noise
Vert	2782.800	PK	45.1	28.0	5.8	31.9	-	47.0	73.9	26.9	
Vert	3710.400	PK	40.8	28.8	6.9	31.6	-	44.9	73.9	29.0	Floor noise
Vert	4638.000	PK	40.1	31.0	8.2	31.3	-	48.0	73.9	25.9	Floor noise
Vert	5565.600	PK	40.3	32.3	8.5	31.4	-	49.7	73.9	24.2	Floor noise
Vert	6493.200	PK	41.8	34.9	9.1	31.9	-	53.9	73.9	20.0	
Vert	7420.800	PK	41.2	36.7	9.5	32.5	-	54.9	73.9	19.0	Floor noise
Vert	8348.400	PK	42.0	36.6	9.7	32.6	-	55.7	73.9	18.2	Floor noise
Vert	9276.000	PK	41.4	37.4	10.1	32.5	-	56.4	73.9	17.5	Floor noise
Vert	1855.200	AV	33.2	26.5	5.5	32.6	-	32.6	53.9	21.3	Floor noise
Vert	2782.800	AV	39.2	28.0	5.8	31.9	-	41.1	53.9	12.8	
Vert	3710.400	AV	32.5	28.8	6.9	31.6	-	36.6	53.9	17.3	Floor noise
Vert	4638.000	AV	32.1	31.0	8.2	31.3	-	40.0	53.9	13.9	Floor noise
Vert	5565.600	AV	31.5	32.3	8.5	31.4	-	40.9	53.9	13.0	Floor noise
Vert	6493.200	AV	33.6	34.9	9.1	31.9	-	45.7	53.9	8.2	
Vert	7420.800	AV	33.6	36.7	9.5	32.5	-	47.3	53.9	6.6	Floor noise
Vert	8348.400	AV	33.9	36.6	9.7	32.6	-	47.6	53.9	6.3	Floor noise
Vert	9276.000	AV	32.9	37.4	10.1	32.5	-	47.9	53.9	6.0	Floor noise

Result = Reading + Ant Factor + Loss (Cable+Attenuator+Filter+Distance factor(above 1 GHz)) - Gain(Amplifier)

*Other frequency noises omitted in this report were not seen or had enough margin (more than 20 dB).

Distance factor: 1 GHz - 10 GHz 20log (4.0 m / 3.0 m) = 2.5 dB

Radiated Spurious Emission
($\lambda/4$ Monopole Antenna)

Test place : Ise EMC Lab.
Report No. : 12160939H
Semi Anechoic Chamber : No.1
Date : February 13, 2018
Temperature / Humidity : 21 deg. C / 37 % RH
Engineer : Koji Yamamoto
(Below 1 GHz)
Mode : Tx 927.6 MHz

20dBc Data Sheet

Polarity	Frequency [MHz]	Detector	Reading [dBuV]	Ant Factor [dB/m]	Loss [dB]	Gain [dB]	Result [dBuV/m]	Limit [dBuV/m]	Margin [dB]	Remark
Hori	927.600	PK	110.4	21.9	14.6	37.9	109.0	-	-	Carrier
Hori	928.000	PK	72.2	21.9	14.6	37.9	70.8	89.0	18.2	
Vert	927.600	PK	110.5	21.9	14.6	37.9	109.1	-	-	Carrier
Vert	928.000	PK	72.9	21.9	14.6	37.9	71.5	89.1	17.6	

Result = Reading + Ant Factor + Loss (Cable + Attenuator + Distance factor (above 1 GHz)) - Gain (Amprifier)

Radiated Spurious Emission
Reference Plot for band-edge ($\lambda/4$ Monopole Antenna)

Test place : Ise EMC Lab.
Report No. : 12160939H
Semi Anechoic Chamber : No.1
Date : February 13, 2018
Temperature / Humidity : 21 deg. C / 37 % RH
Engineer : Koji Yamamoto
(Below 1 GHz)
Mode : Tx 927.6 MHz

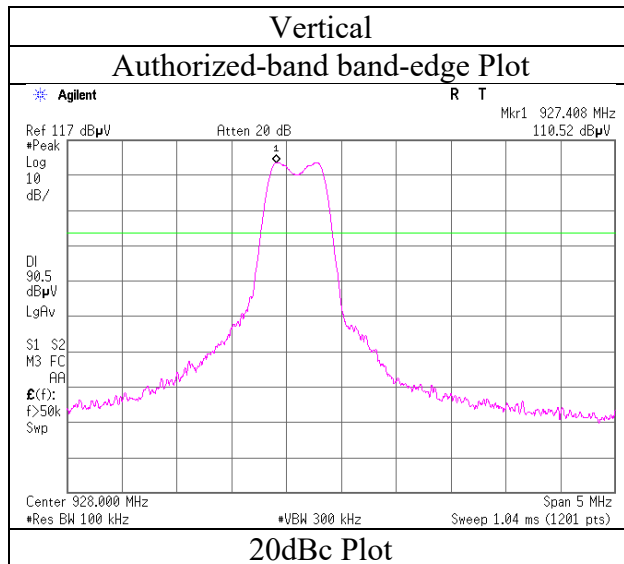
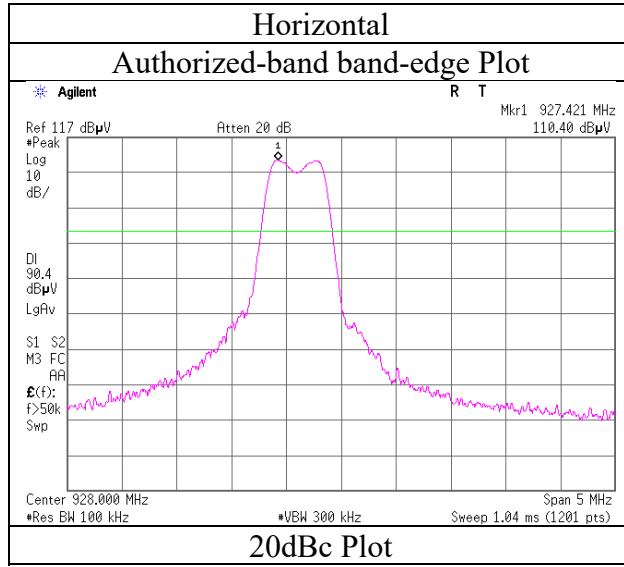

* Final result of restricted band edge was shown in tabular data.

Radiated Spurious Emission
(Film Antenna)

Test place : Ise EMC Lab.
Report No. : 12160939H
Semi Anechoic Chamber : No.2
Date : February 26, 2018
Temperature / Humidity : 25 deg. C / 33 % RH
Engineer : Yuta Moriya
Mode : Tx 902.4 MHz

Polarity	Frequency [MHz]	Detector	Reading [dBuV]	Ant.Fac. [dB/m]	Loss [dB]	Gain [dB]	Duty Factor [dB]	Result [dBuV/m]	Limit [dBuV/m]	Margin [dB]	Remark
Hori	48.000	QP	24.9	11.6	6.9	30.4	-	13.0	40.0	27.0	
Hori	79.017	QP	24.2	6.6	7.3	30.4	-	7.7	40.0	32.3	
Hori	96.017	QP	30.6	9.5	7.4	30.3	-	17.2	43.5	26.3	
Hori	249.333	QP	23.3	11.7	8.5	29.3	-	14.2	46.0	31.8	
Hori	397.334	QP	23.4	15.5	9.4	29.7	-	18.6	46.0	27.4	
Hori	576.001	QP	23.3	18.8	10.1	29.8	-	22.4	46.0	23.6	
Hori	1804.800	PK	53.7	26.3	5.0	34.7	-	50.3	73.9	23.6	
Hori	2707.200	PK	43.6	27.8	5.3	34.4	-	42.3	73.9	31.6	Floor noise
Hori	3609.600	PK	43.4	28.6	5.7	33.8	-	43.9	73.9	30.0	Floor noise
Hori	4512.000	PK	42.1	30.5	6.1	33.6	-	45.1	73.9	28.8	Floor noise
Hori	5414.400	PK	41.5	32.2	6.6	33.4	-	46.9	73.9	27.0	Floor noise
Hori	6316.800	PK	42.9	34.3	7.0	33.6	-	50.6	73.9	23.3	Floor noise
Hori	7219.200	PK	41.3	36.5	7.2	33.6	-	51.4	73.9	22.5	Floor noise
Hori	8121.600	PK	43.1	36.9	7.5	33.7	-	53.8	73.9	20.1	Floor noise
Hori	9024.000	PK	42.2	36.9	7.7	33.8	-	53.0	73.9	20.9	Floor noise
Hori	1804.800	AV	50.3	26.3	5.0	34.7	-	46.9	53.9	7.0	
Hori	2707.200	AV	35.6	27.8	5.3	34.4	-	34.3	53.9	19.6	Floor noise
Hori	3609.600	AV	35.0	28.6	5.7	33.8	-	35.5	53.9	18.4	Floor noise
Hori	4512.000	AV	34.1	30.5	6.1	33.6	-	37.1	53.9	16.8	Floor noise
Hori	5414.400	AV	33.6	32.2	6.6	33.4	-	39.0	53.9	14.9	Floor noise
Hori	6316.800	AV	34.1	34.3	7.0	33.6	-	41.8	53.9	12.1	Floor noise
Hori	7219.200	AV	33.7	36.5	7.2	33.6	-	43.8	53.9	10.1	Floor noise
Hori	8121.600	AV	34.2	36.9	7.5	33.7	-	44.9	53.9	9.0	Floor noise
Hori	9024.000	AV	34.6	36.9	7.7	33.8	-	45.4	53.9	8.5	Floor noise
Vert	48.000	QP	28.5	11.6	6.9	30.4	-	16.6	40.0	23.4	
Vert	78.450	QP	24.1	6.6	7.3	30.4	-	7.6	40.0	32.4	
Vert	95.999	QP	26.8	9.5	7.4	30.3	-	13.4	43.5	30.1	
Vert	248.101	QP	22.9	11.7	8.5	29.3	-	13.8	46.0	32.2	
Vert	394.668	QP	23.0	15.4	9.4	29.7	-	18.1	46.0	27.9	
Vert	577.334	QP	23.2	18.8	10.1	29.8	-	22.3	46.0	23.7	
Vert	1804.800	PK	51.7	26.3	5.0	34.7	-	48.3	73.9	25.6	
Vert	2707.200	PK	43.8	27.8	5.3	34.4	-	42.5	73.9	31.4	Floor noise
Vert	3609.600	PK	43.0	28.6	5.7	33.8	-	43.5	73.9	30.4	Floor noise
Vert	4512.000	PK	41.9	30.5	6.1	33.6	-	44.9	73.9	29.0	Floor noise
Vert	5414.400	PK	42.4	32.2	6.6	33.4	-	47.8	73.9	26.1	Floor noise
Vert	6316.800	PK	41.4	34.3	7.0	33.6	-	49.1	73.9	24.8	Floor noise
Vert	7219.200	PK	41.3	36.5	7.2	33.6	-	51.4	73.9	22.5	Floor noise
Vert	8121.600	PK	42.2	36.9	7.5	33.7	-	52.9	73.9	21.0	Floor noise
Vert	9024.000	PK	43.2	36.9	7.7	33.8	-	54.0	73.9	19.9	Floor noise
Vert	1804.800	AV	41.7	26.3	5.0	34.7	-	38.3	53.9	15.6	
Vert	2707.200	AV	35.3	27.8	5.3	34.4	-	34.0	53.9	19.9	Floor noise
Vert	3609.600	AV	35.4	28.6	5.7	33.8	-	35.9	53.9	18.0	Floor noise
Vert	4512.000	AV	34.1	30.5	6.1	33.6	-	37.1	53.9	16.8	Floor noise
Vert	5414.400	AV	33.8	32.2	6.6	33.4	-	39.2	53.9	14.7	Floor noise
Vert	6316.800	AV	34.2	34.3	7.0	33.6	-	41.9	53.9	12.0	Floor noise
Vert	7219.200	AV	33.8	36.5	7.2	33.6	-	43.9	53.9	10.0	Floor noise
Vert	8121.600	AV	34.1	36.9	7.5	33.7	-	44.8	53.9	9.1	Floor noise
Vert	9024.000	AV	34.7	36.9	7.7	33.8	-	45.5	53.9	8.4	Floor noise

Result = Reading + Ant Factor + Loss (Cable+Attenuator+Filter+Distance factor(above 1 GHz)) - Gain(Amplifier)

*Other frequency noises omitted in this report were not seen or had enough margin (more than 20 dB).

Distance factor: 1 GHz - 10 GHz 20log (3.75 m / 3.0 m) = 1.94 dB

Radiated Spurious Emission
(Film Antenna)

Test place : Ise EMC Lab.
Report No. : 12160939H
Semi Anechoic Chamber : No.2
Date : February 26, 2018
Temperature / Humidity : 25 deg. C / 33 % RH
Engineer : Yuta Moriya
Mode : Tx 902.4 MHz

20dBc Data Sheet

Polarity	Frequency [MHz]	Detector	Reading [dBuV]	Ant Factor [dB/m]	Loss [dB]	Gain [dB]	Result [dBuV/m]	Limit [dBuV/m]	Margin [dB]	Remark
Hori	902.400	PK	97.0	21.9	11.3	28.1	102.1	-	-	Carrier
Hori	902.000	PK	63.9	21.9	11.3	28.1	69.0	82.1	13.1	
Vert	902.400	PK	95.7	21.9	11.3	28.1	100.8	-	-	Carrier
Vert	902.000	PK	63.2	21.9	11.3	28.1	68.3	80.8	12.5	

Result = Reading + Ant Factor + Loss (Cable + Attenuator + Distance factor (above 1 GHz)) - Gain (Amplifier)

Radiated Spurious Emission
Reference Plot for band-edge (Film Antenna)

Test place	Ise EMC Lab.
Report No.	12160939H
Semi Anechoic Chamber	No.2
Date	February 26, 2018
Temperature / Humidity	25 deg. C / 33 % RH
Engineer	Yuta Moriya
Mode	Tx 902.4 MHz

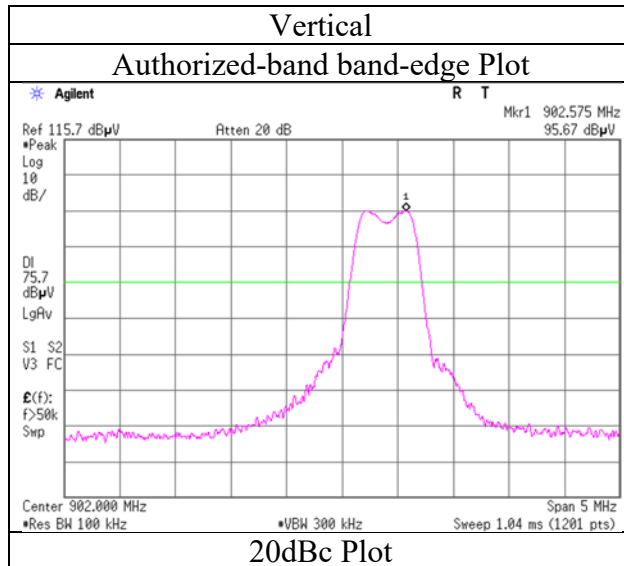
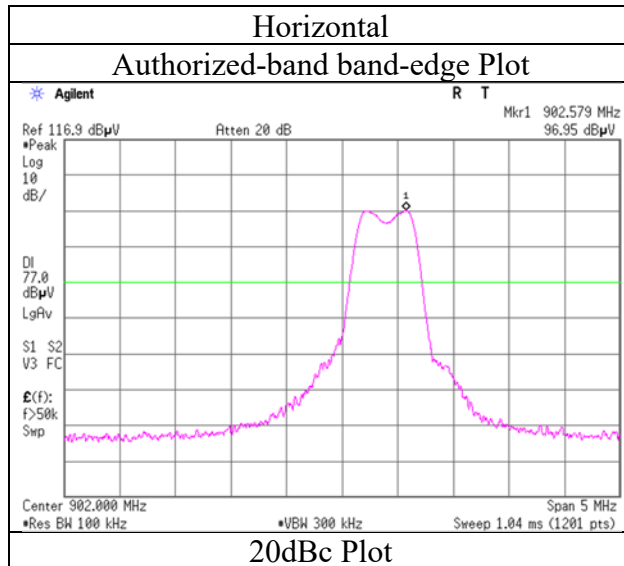

* Final result of restricted band edge was shown in tabular data.

Radiated Spurious Emission
(Film Antenna)

Test place : Ise EMC Lab.
Report No. : 12160939H
Semi Anechoic Chamber : No.2
Date : February 26, 2018
Temperature / Humidity : 25 deg. C / 33 % RH
Engineer : Yuta Moriya
Mode : Tx 915.0 MHz

Polarity	Frequency [MHz]	Detector	Reading [dBuV]	Ant.Fac. [dB/m]	Loss [dB]	Gain [dB]	Duty Factor [dB]	Result [dBuV/m]	Limit [dBuV/m]	Margin [dB]	Remark
Hori	48.000	QP	24.8	11.6	6.9	30.4	-	12.9	40.0	27.1	
Hori	79.017	QP	24.5	6.6	7.3	30.4	-	8.0	40.0	32.0	
Hori	96.999	QP	30.4	9.7	7.4	30.3	-	17.2	43.5	26.3	
Hori	249.333	QP	22.9	11.7	8.5	29.3	-	13.8	46.0	32.2	
Hori	389.258	QP	22.9	15.3	9.4	29.7	-	17.9	46.0	28.1	
Hori	576.125	QP	23.2	18.8	10.1	29.8	-	22.3	46.0	23.7	
Hori	1830.000	PK	49.7	26.4	5.1	34.7	-	46.5	73.9	27.4	
Hori	2745.000	PK	43.9	27.9	5.3	34.4	-	42.7	73.9	31.2	Floor noise
Hori	3660.000	PK	43.3	28.7	5.7	33.8	-	43.9	73.9	30.0	Floor noise
Hori	4575.000	PK	42.5	30.8	6.1	33.6	-	45.8	73.9	28.1	Floor noise
Hori	5490.000	PK	41.6	32.2	6.6	33.4	-	47.0	73.9	26.9	Floor noise
Hori	6405.000	PK	41.8	34.6	7.0	33.6	-	49.8	73.9	24.1	Floor noise
Hori	7320.000	PK	42.7	36.6	7.3	33.6	-	53.0	73.9	20.9	Floor noise
Hori	8235.000	PK	43.1	36.7	7.4	33.7	-	53.5	73.9	20.4	Floor noise
Hori	9150.000	PK	44.0	37.2	7.8	33.8	-	55.2	73.9	18.7	Floor noise
Hori	1830.000	AV	44.1	26.4	5.1	34.7	-	40.9	53.9	13.0	
Hori	2745.000	AV	35.4	27.9	5.3	34.4	-	34.2	53.9	19.7	Floor noise
Hori	3660.000	AV	34.7	28.7	5.7	33.8	-	35.3	53.9	18.6	Floor noise
Hori	4575.000	AV	34.1	30.8	6.1	33.6	-	37.4	53.9	16.5	Floor noise
Hori	5490.000	AV	33.4	32.2	6.6	33.4	-	38.8	53.9	15.1	Floor noise
Hori	6405.000	AV	33.6	34.6	7.0	33.6	-	41.6	53.9	12.3	Floor noise
Hori	7320.000	AV	33.8	36.6	7.3	33.6	-	44.1	53.9	9.8	Floor noise
Hori	8235.000	AV	34.6	36.7	7.4	33.7	-	45.0	53.9	8.9	Floor noise
Hori	9150.000	AV	34.8	37.2	7.8	33.8	-	46.0	53.9	7.9	Floor noise
Vert	48.000	QP	28.4	11.6	6.9	30.4	-	16.5	40.0	23.5	
Vert	78.450	QP	23.9	6.6	7.3	30.4	-	7.4	40.0	32.6	
Vert	95.999	QP	26.7	9.5	7.4	30.3	-	13.3	43.5	30.2	
Vert	247.956	QP	23.4	11.7	8.5	29.3	-	14.3	46.0	31.7	
Vert	395.987	QP	23.0	15.5	9.4	29.7	-	18.2	46.0	27.8	
Vert	577.334	QP	23.3	18.8	10.1	29.8	-	22.4	46.0	23.6	
Vert	1830.000	PK	49.4	26.4	5.1	34.7	-	46.2	73.9	27.7	
Vert	2745.000	PK	43.9	27.9	5.3	34.4	-	42.7	73.9	31.2	Floor noise
Vert	3660.000	PK	43.3	28.7	5.7	33.8	-	43.9	73.9	30.0	Floor noise
Vert	4575.000	PK	42.5	30.8	6.1	33.6	-	45.8	73.9	28.1	Floor noise
Vert	5490.000	PK	41.6	32.2	6.6	33.4	-	47.0	73.9	26.9	Floor noise
Vert	6405.000	PK	41.8	34.6	7.0	33.6	-	49.8	73.9	24.1	Floor noise
Vert	7320.000	PK	42.7	36.6	7.3	33.6	-	53.0	73.9	20.9	Floor noise
Vert	8235.000	PK	43.1	36.7	7.4	33.7	-	53.5	73.9	20.4	Floor noise
Vert	9150.000	PK	44.0	37.2	7.8	33.8	-	55.2	73.9	18.7	Floor noise
Vert	1830.000	AV	44.4	26.4	5.1	34.7	-	41.2	53.9	12.7	
Vert	2745.000	AV	35.4	27.9	5.3	34.4	-	34.2	53.9	19.7	Floor noise
Vert	3660.000	AV	34.7	28.7	5.7	33.8	-	35.3	53.9	18.6	Floor noise
Vert	4575.000	AV	34.1	30.8	6.1	33.6	-	37.4	53.9	16.5	Floor noise
Vert	5490.000	AV	33.4	32.2	6.6	33.4	-	38.8	53.9	15.1	Floor noise
Vert	6405.000	AV	33.6	34.6	7.0	33.6	-	41.6	53.9	12.3	Floor noise
Vert	7320.000	AV	33.8	36.6	7.3	33.6	-	44.1	53.9	9.8	Floor noise
Vert	8235.000	AV	34.6	36.7	7.4	33.7	-	45.0	53.9	8.9	Floor noise
Vert	9150.000	AV	34.8	37.2	7.8	33.8	-	46.0	53.9	7.9	Floor noise

Result = Reading + Ant Factor + Loss (Cable+Attenuator+Filter+Distance factor(above 1 GHz)) - Gain(Amplifier)

*Other frequency noises omitted in this report were not seen or had enough margin (more than 20 dB).

Distance factor: 1 GHz - 10 GHz 20log (3.75 m / 3.0 m) = 1.94 dB

Radiated Spurious Emission
(Film Antenna)

Test place : Ise EMC Lab.
Report No. : 12160939H
Semi Anechoic Chamber : No.2
Date : February 26, 2018
Temperature / Humidity : 25 deg. C / 33 % RH
Engineer : Yuta Moriya
Mode : Tx 927.6 MHz

Polarity	Frequency [MHz]	Detector	Reading [dBuV]	Ant.Fac. [dB/m]	Loss [dB]	Gain [dB]	Duty Factor [dB]	Result [dBuV/m]	Limit [dBuV/m]	Margin [dB]	Remark
Hori	48.000	QP	24.9	11.6	6.9	30.4	-	13.0	40.0	27.0	
Hori	79.017	QP	24.1	6.6	7.3	30.4	-	7.6	40.0	32.4	
Hori	96.999	QP	30.6	9.7	7.4	30.3	-	17.4	43.5	26.1	
Hori	252.638	QP	23.0	11.8	8.5	29.3	-	14.0	46.0	32.0	
Hori	389.586	QP	23.0	15.3	9.4	29.7	-	18.0	46.0	28.0	
Hori	576.125	QP	23.2	18.8	10.1	29.8	-	22.3	46.0	23.7	
Hori	1855.200	PK	46.2	26.5	5.1	34.7	-	43.1	73.9	30.8	
Hori	2782.800	PK	45.6	28.0	5.2	34.4	-	44.4	73.9	29.5	
Hori	3710.400	PK	42.4	28.8	5.7	33.7	-	43.2	73.9	30.7	Floor noise
Hori	4638.000	PK	41.6	31.0	6.1	33.7	-	45.0	73.9	28.9	Floor noise
Hori	5565.600	PK	41.6	32.3	6.7	33.4	-	47.2	73.9	26.7	Floor noise
Hori	6493.200	PK	41.4	34.9	7.0	33.6	-	49.7	73.9	24.2	Floor noise
Hori	7420.800	PK	42.1	36.7	7.3	33.6	-	52.5	73.9	21.4	Floor noise
Hori	8348.400	PK	42.6	36.6	7.5	33.7	-	53.0	73.9	20.9	Floor noise
Hori	9276.000	PK	42.3	37.4	7.8	33.8	-	53.7	73.9	20.2	Floor noise
Hori	1855.200	AV	39.6	26.5	5.1	34.7	-	36.5	53.9	17.4	
Hori	2782.800	AV	38.7	28.0	5.2	34.4	-	37.5	53.9	16.4	
Hori	3710.400	AV	34.5	28.8	5.7	33.7	-	35.3	53.9	18.6	Floor noise
Hori	4638.000	AV	34.6	31.0	6.1	33.7	-	38.0	53.9	15.9	Floor noise
Hori	5565.600	AV	34.1	32.3	6.7	33.4	-	39.7	53.9	14.2	Floor noise
Hori	6493.200	AV	33.5	34.9	7.0	33.6	-	41.8	53.9	12.1	Floor noise
Hori	7420.800	AV	33.8	36.7	7.3	33.6	-	44.2	53.9	9.7	Floor noise
Hori	8348.400	AV	34.6	36.6	7.5	33.7	-	45.0	53.9	8.9	Floor noise
Hori	9276.000	AV	34.5	37.4	7.8	33.8	-	45.9	53.9	8.0	Floor noise
Vert	48.000	QP	28.9	11.6	6.9	30.4	-	17.0	40.0	23.0	
Vert	78.450	QP	24.0	6.6	7.3	30.4	-	7.5	40.0	32.5	
Vert	95.999	QP	26.5	9.5	7.4	30.3	-	13.1	43.5	30.4	
Vert	247.956	QP	23.3	11.7	8.5	29.3	-	14.2	46.0	31.8	
Vert	395.987	QP	22.9	15.5	9.4	29.7	-	18.1	46.0	27.9	
Vert	577.334	QP	23.2	18.8	10.1	29.8	-	22.3	46.0	23.7	
Vert	1855.200	PK	47.1	26.5	5.1	34.7	-	44.0	73.9	29.9	
Vert	2782.800	PK	46.5	28.0	5.2	34.4	-	45.3	73.9	28.6	
Vert	3710.400	PK	42.4	28.8	5.7	33.7	-	43.2	73.9	30.7	Floor noise
Vert	4638.000	PK	41.6	31.0	6.1	33.7	-	45.0	73.9	28.9	Floor noise
Vert	5565.600	PK	41.6	32.3	6.7	33.4	-	47.2	73.9	26.7	Floor noise
Vert	6493.200	PK	43.8	34.9	7.0	33.6	-	52.1	73.9	21.8	
Vert	7420.800	PK	42.1	36.7	7.3	33.6	-	52.5	73.9	21.4	Floor noise
Vert	8348.400	PK	42.6	36.6	7.5	33.7	-	53.0	73.9	20.9	Floor noise
Vert	9276.000	PK	42.3	37.4	7.8	33.8	-	53.7	73.9	20.2	Floor noise
Vert	1855.200	AV	37.7	26.5	5.1	34.7	-	34.6	53.9	19.3	
Vert	2782.800	AV	38.9	28.0	5.2	34.4	-	37.7	53.9	16.2	
Vert	3710.400	AV	34.5	28.8	5.7	33.7	-	35.3	53.9	18.6	Floor noise
Vert	4638.000	AV	34.6	31.0	6.1	33.7	-	38.0	53.9	15.9	Floor noise
Vert	5565.600	AV	34.1	32.3	6.7	33.4	-	39.7	53.9	14.2	Floor noise
Vert	6493.200	AV	36.4	34.9	7.0	33.6	-	44.7	53.9	9.2	
Vert	7420.800	AV	33.8	36.7	7.3	33.6	-	44.2	53.9	9.7	Floor noise
Vert	8348.400	AV	34.6	36.6	7.5	33.7	-	45.0	53.9	8.9	Floor noise
Vert	9276.000	AV	34.5	37.4	7.8	33.8	-	45.9	53.9	8.0	Floor noise

Result = Reading + Ant Factor + Loss (Cable+Attenuator+Filter+Distance factor(above 1 GHz)) - Gain(Amplifier)

*Other frequency noises omitted in this report were not seen or had enough margin (more than 20 dB).

Distance factor: 1 GHz - 10 GHz 20log (3.75 m / 3.0 m) = 1.94 dB

Radiated Spurious Emission
(Film Antenna)

Test place : Ise EMC Lab.
Report No. : 12160939H
Semi Anechoic Chamber : No.2
Date : February 26, 2018
Temperature / Humidity : 25 deg. C / 33 % RH
Engineer : Yuta Moriya
Mode : Tx 927.6 MHz

20dBc Data Sheet

Polarity	Frequency [MHz]	Detector	Reading [dBuV]	Ant Factor [dB/m]	Loss [dB]	Gain [dB]	Result [dBuV/m]	Limit [dBuV/m]	Margin [dB]	Remark
Hori	927.600	PK	101.0	22.0	11.4	27.9	106.5	-	-	Carrier
Hori	928.000	PK	64.1	22.0	11.4	27.9	69.6	86.5	16.9	
Vert	927.600	PK	100.5	22.0	11.4	27.9	106.0	-	-	Carrier
Vert	928.000	PK	63.2	22.0	11.4	27.9	68.7	86.0	17.3	

Result = Reading + Ant Factor + Loss (Cable + Attenuator + Distance factor (above 1 GHz)) - Gain (Amprifier)

Radiated Spurious Emission
Reference Plot for band-edge (Film Antenna)

Test place	Ise EMC Lab.
Report No.	12160939H
Semi Anechoic Chamber	No.2
Date	February 26, 2018
Temperature / Humidity	25 deg. C / 33 % RH
Engineer	Yuta Moriya
Mode	Tx 927.6 MHz

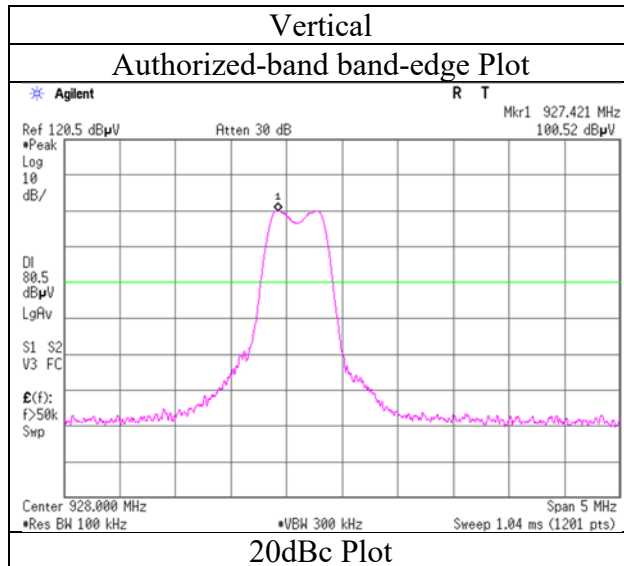
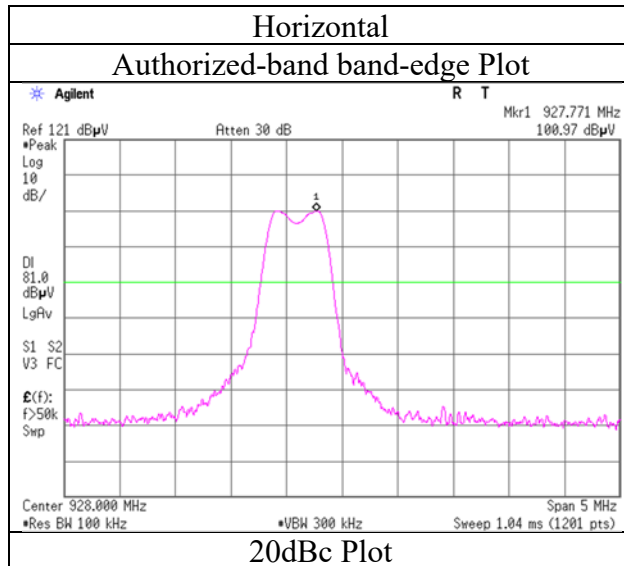

* Final result of restricted band edge was shown in tabular data.

Radiated Spurious Emission
 Plot data, Worst case (Internal Antenna)

Test place	Ise EMC Lab.	
Report No.	12160939H	
Semi Anechoic Chamber	No.1	No.4
Date	February 13, 2018	February 9, 2018
Temperature / Humidity	21 deg. C / 37 % RH	21 deg. C / 34 % RH
Engineer	Koji Yamamoto (Below 1 GHz)	Takafumi Noguchi (Above 1 GHz)
Mode	Tx 902.4 MHz	

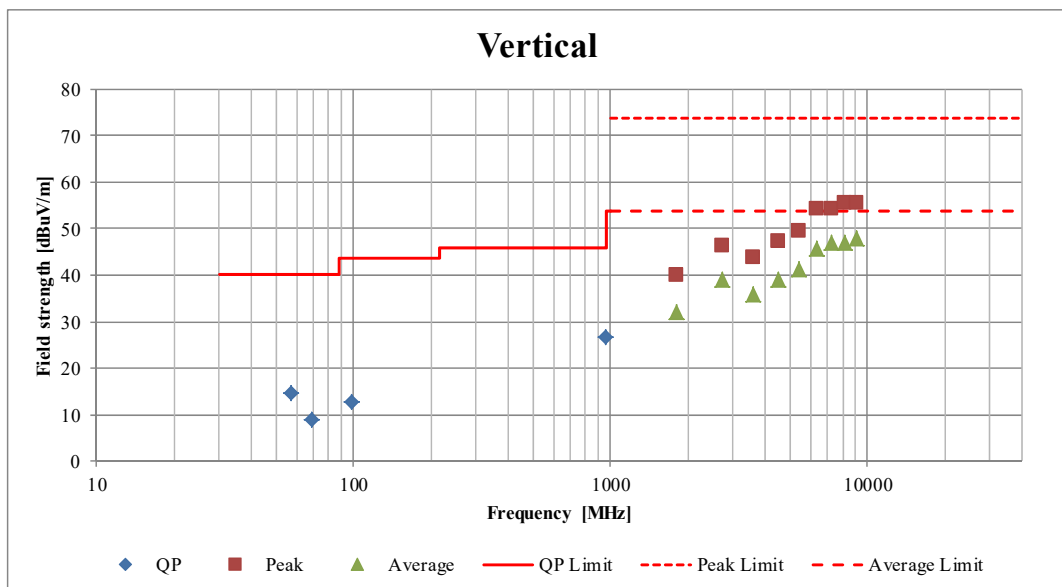
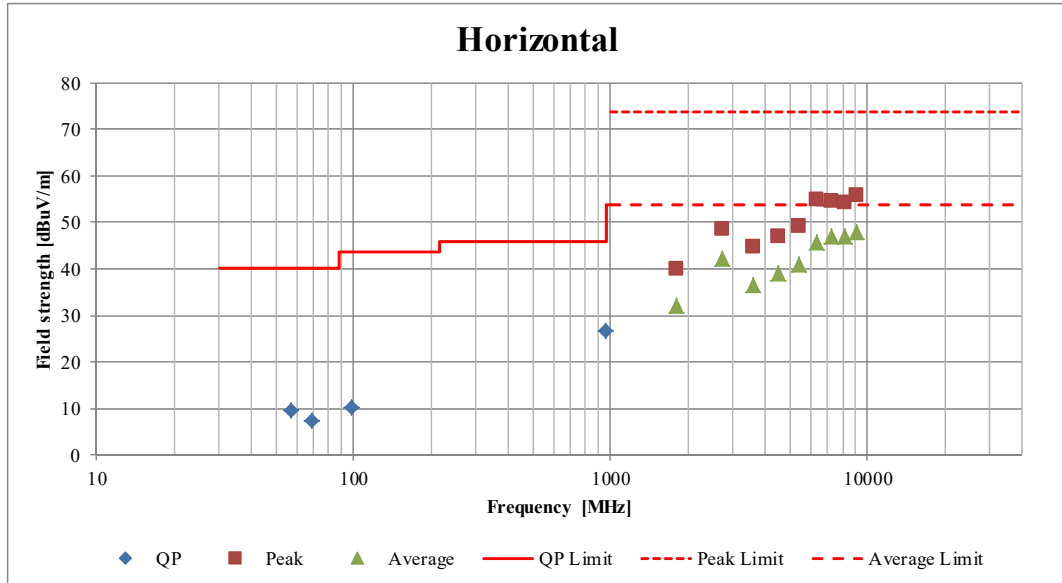

*These plots data contains sufficient number to show the trend of characteristic features for EUT.

Radiated Spurious Emission
Plot data, Worst case (Sleeve Antenna)

Test place	Ise EMC Lab.	
Report No.	12160939H	
Semi Anechoic Chamber	No.1	No.4
Date	February 14, 2018	February 15, 2018
Temperature / Humidity	24 deg. C / 40 % RH	22 deg. C / 39 % RH
Engineer	Ken Fujita (Below 1 GHz)	Koji Yamamoto (Above 1 GHz)
Mode	Tx 902.4 MHz	

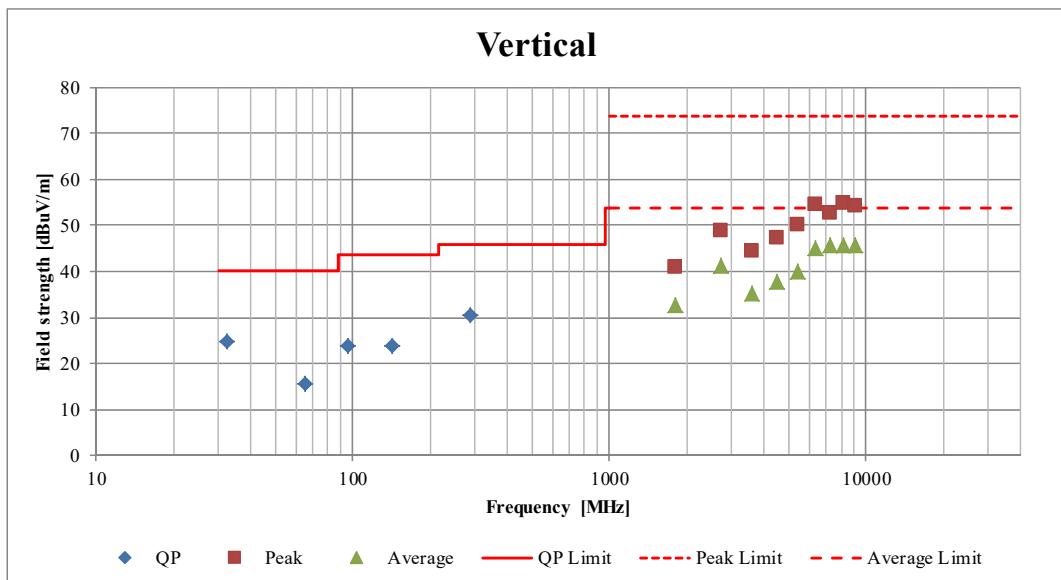
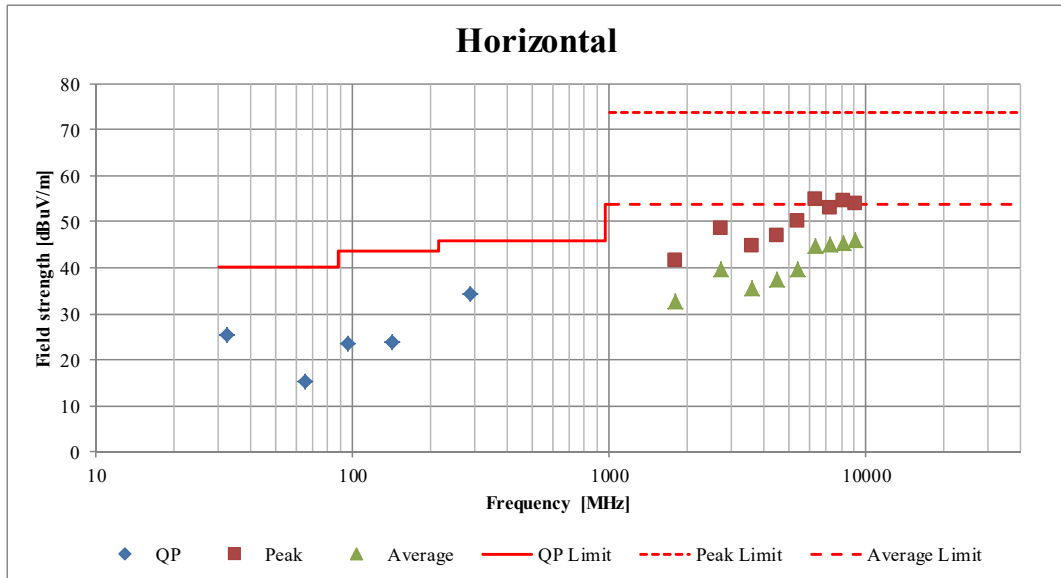

*These plots data contains sufficient number to show the trend of characteristic features for EUT.

Radiated Spurious Emission
 Plot data, Worst case ($\lambda/4$ Monopole Antenna)

Test place	Ise EMC Lab.	
Report No.	12160939H	
Semi Anechoic Chamber	No.1	No.4
Date	February 13, 2018	February 9, 2018
Temperature / Humidity	21 deg. C / 37 % RH	21 deg. C / 34 % RH
Engineer	Koji Yamamoto (Below 1 GHz)	Takafumi Noguchi (Above 1 GHz)
Mode	Tx 902.4 MHz	

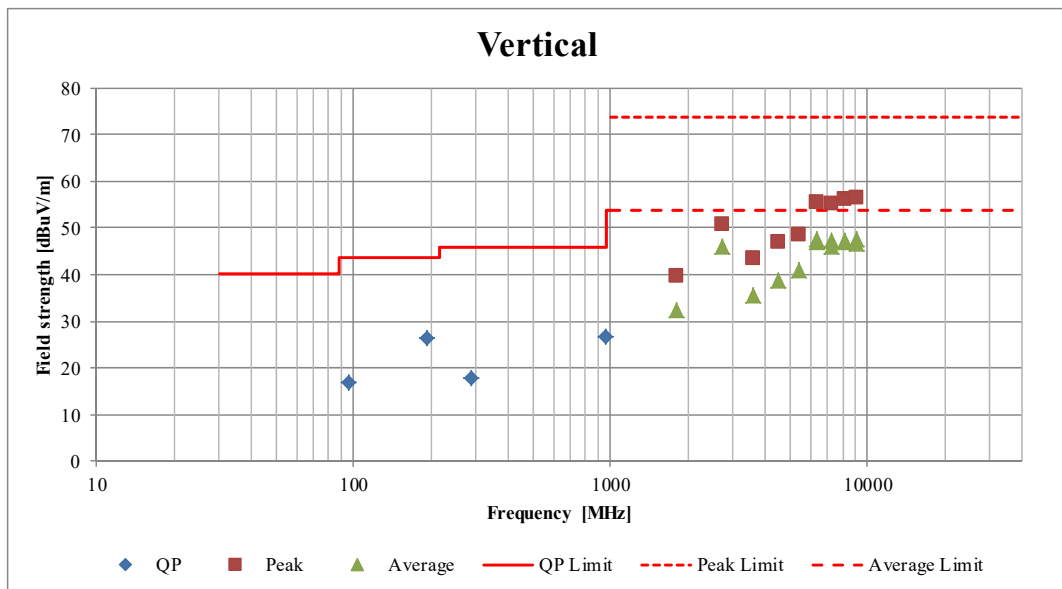
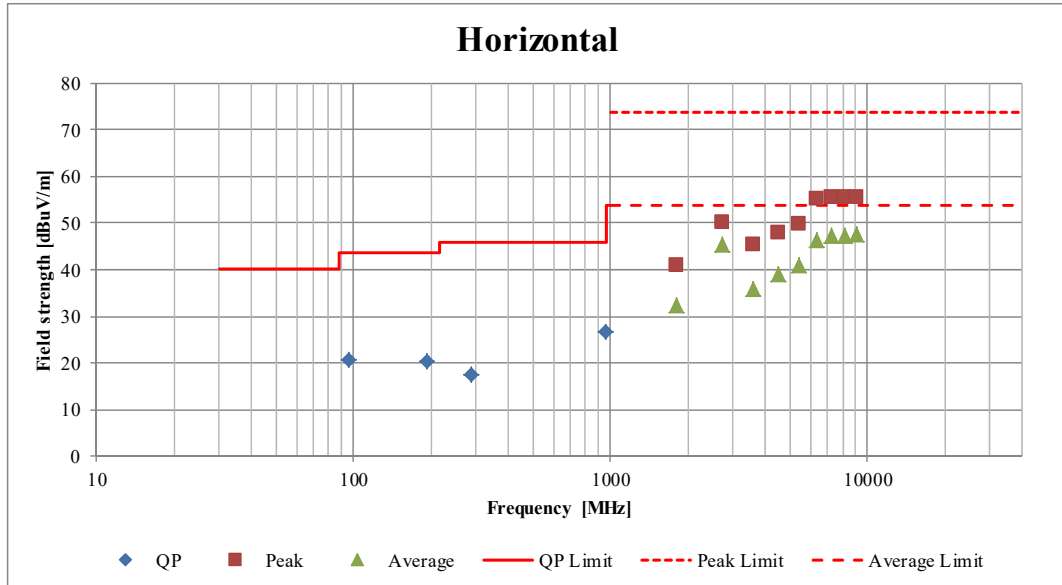

*These plots data contains sufficient number to show the trend of characteristic features for EUT.

Radiated Spurious Emission
 Plot data, Worst case (Film Antenna)

Test place	Ise EMC Lab.
Report No.	12160939H
Semi Anechoic Chamber	No.2
Date	February 26, 2018
Temperature / Humidity	25 deg. C / 33 % RH
Engineer	Yuta Moriya
Mode	Tx 902.4 MHz

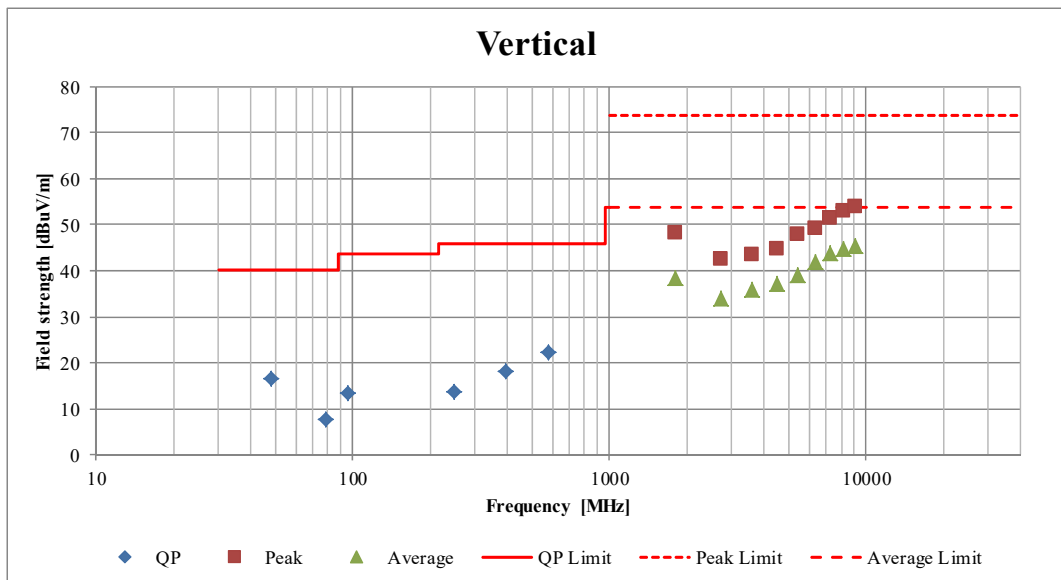
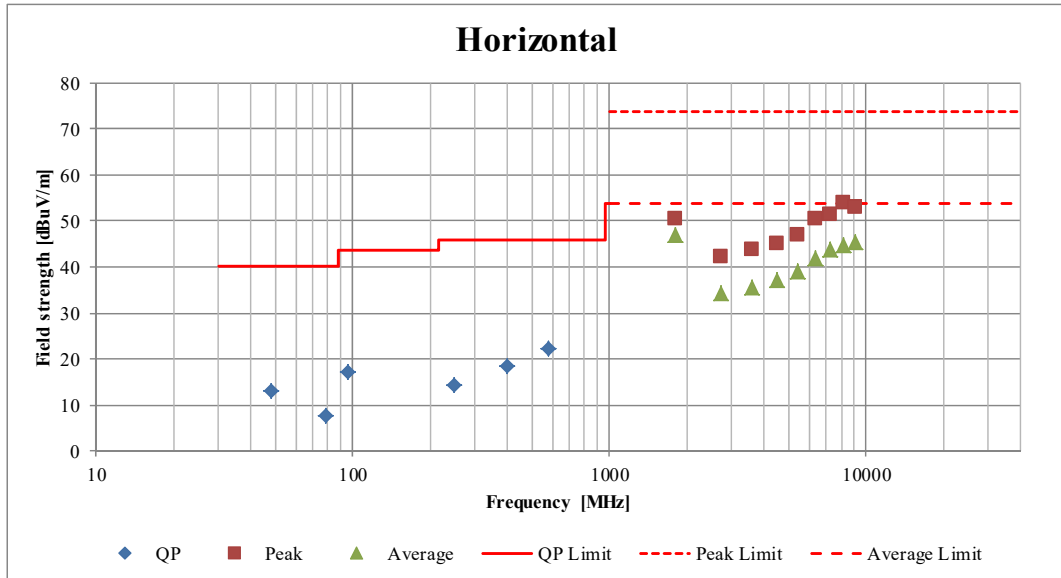

*These plots data contains sufficient number to show the trend of characteristic features for EUT.

Conducted Spurious Emission

Test place	Ise EMC Lab. No.6 Shielded Room
Report No.	12160939H
Date	February 19, 2018
Temperature / Humidity	25 deg. C / 31 % RH
Engineer	Yuta Moriya
Mode	Tx 902.4 MHz

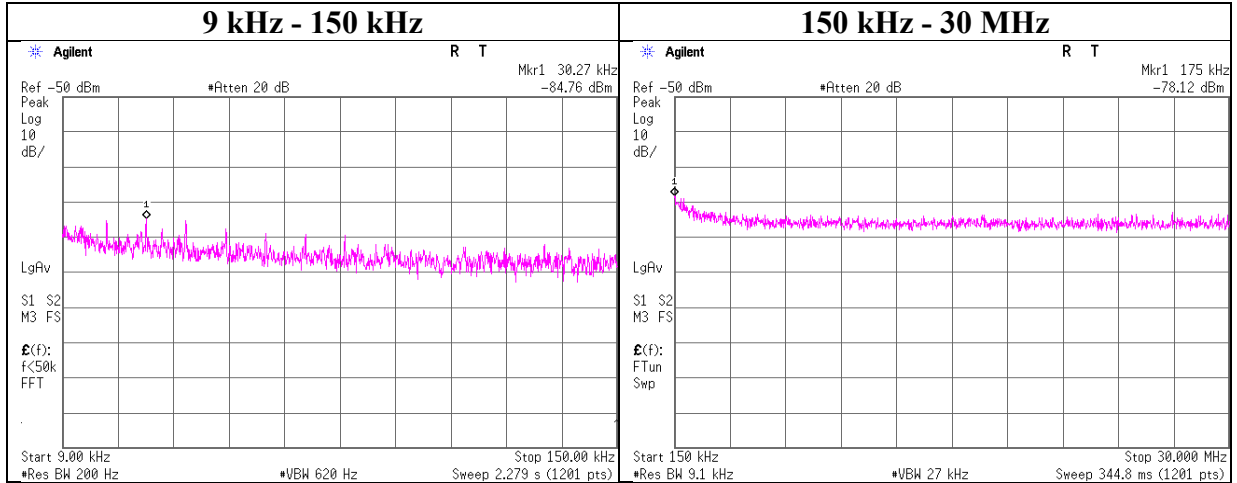

Frequency [kHz]	Reading [dBm]	Cable Loss [dB]	Attenuator Loss [dB]	Antenna Gain* [dBi]	N (Number of Output)	EIRP [dBm]	Distance [m]	Ground bounce [dB]	E (field strength) [dBuV/m]	Limit [dBuV/m]	Margin [dB]	Remark
30.27	-84.8	0.20	9.8	2.0	1	-72.7	300	6.0	-11.5	37.9	49.4	
175.00	-78.1	0.20	9.8	2.0	1	-66.1	300	6.0	-4.8	22.7	27.5	

$$E \text{ [dBuV/m]} = \text{EIRP [dBm]} - 20 \log(\text{Distance [m]}) + \text{Ground bounce [dB]} + 104.8 \text{ [dBuV/m]}$$

$$\text{EIRP [dBm]} = \text{Reading [dBm]} + \text{Cable loss [dB]} + \text{Attenuator Loss [dB]} + \text{Antenna gain [dBi]} + 10 * \log(N)$$

N: Number of output

UL Japan, Inc.

Ise EMC Lab.

4383-326 Asama-cho, Ise-shi, Mie-ken 516-0021 JAPAN

Telephone : +81 596 24 8999

Facsimile : +81 596 24 8124

Conducted Spurious Emission

Test place	Ise EMC Lab. No.6 Shielded Room
Report No.	12160939H
Date	February 19, 2018
Temperature / Humidity	25 deg. C / 31 % RH
Engineer	Yuta Moriya
Mode	Tx 915.0 MHz

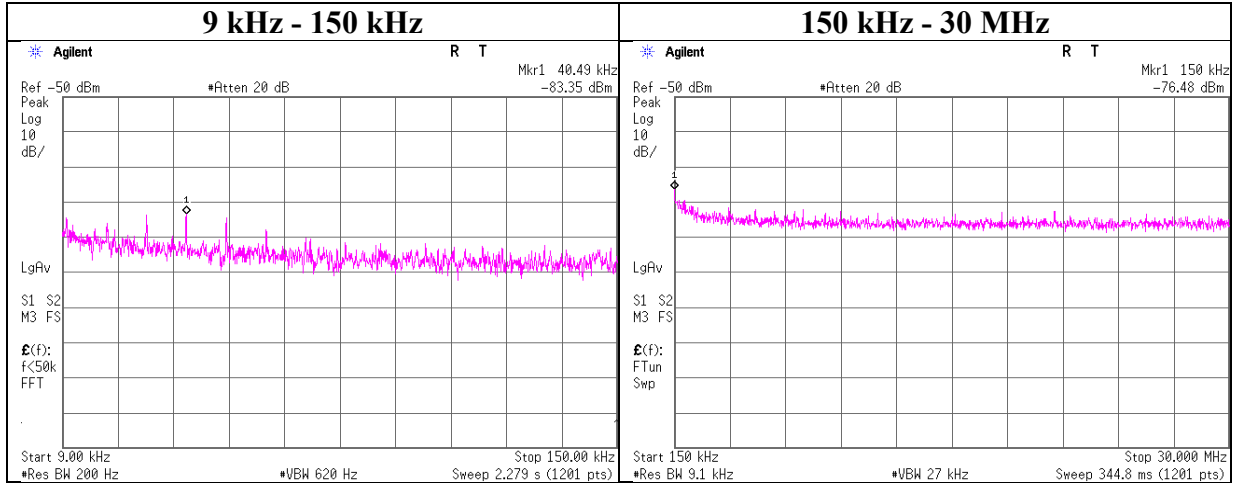

Frequency [kHz]	Reading [dBm]	Cable Loss [dB]	Attenuator Loss [dB]	Antenna Gain* [dBi]	N (Number of Output)	EIRP [dBm]	Distance [m]	Ground bounce [dB]	E (field strength) [dBuV/m]	Limit [dBuV/m]	Margin [dB]	Remark
40.49	-83.4	0.20	9.8	2.0	1	-71.3	300	6.0	-10.1	35.4	45.5	
150.00	-76.5	0.20	9.8	2.0	1	-64.5	300	6.0	-3.2	24.0	27.2	

$$E \text{ [dBuV/m]} = \text{EIRP [dBm]} - 20 \log(\text{Distance [m]}) + \text{Ground bounce [dB]} + 104.8 \text{ [dBuV/m]}$$

$$\text{EIRP [dBm]} = \text{Reading [dBm]} + \text{Cable loss [dB]} + \text{Attenuator Loss [dB]} + \text{Antenna gain [dBi]} + 10 * \log(N)$$

N: Number of output

UL Japan, Inc.

Ise EMC Lab.

4383-326 Asama-cho, Ise-shi, Mie-ken 516-0021 JAPAN

Telephone : +81 596 24 8999

Facsimile : +81 596 24 8124

Conducted Spurious Emission

Test place	Ise EMC Lab. No.6 Shielded Room
Report No.	12160939H
Date	February 19, 2018
Temperature / Humidity	25 deg. C / 31 % RH
Engineer	Yuta Moriya
Mode	Tx 927.6MHz

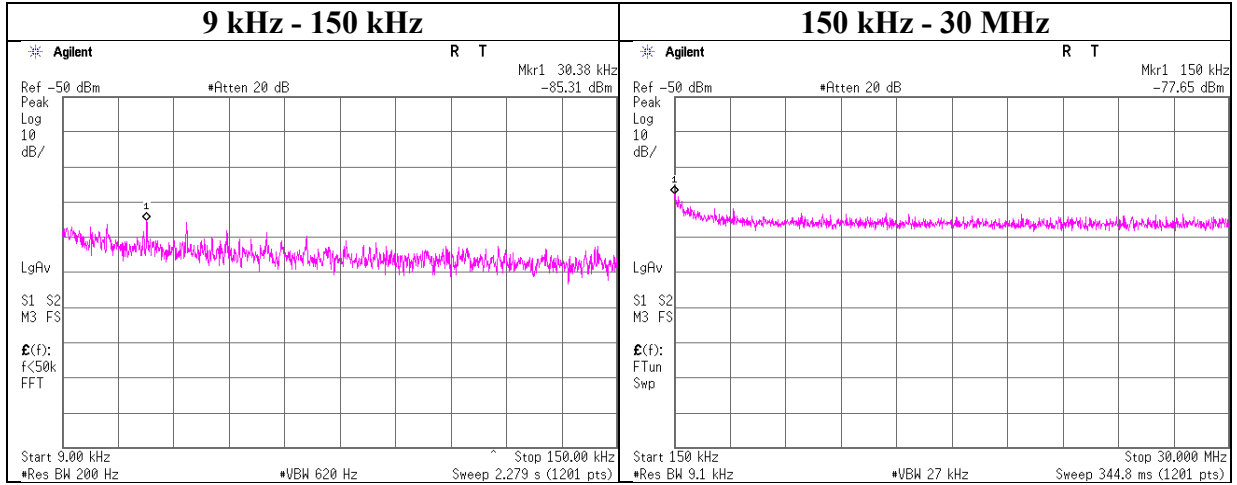

Frequency [kHz]	Reading [dBm]	Cable Loss [dB]	Attenuator Loss [dB]	Antenna Gain* [dBi]	N (Number of Output)	EIRP [dBm]	Distance [m]	Ground bounce [dB]	E (field strength) [dBuV/m]	Limit [dBuV/m]	Margin [dB]	Remark
30.38	-85.3	0.20	9.8	2.0	1	-73.3	300	6.0	-12.0	37.9	49.9	
150.00	-77.7	0.20	9.8	2.0	1	-65.6	300	6.0	-4.4	24.0	28.4	

$$E \text{ [dBuV/m]} = \text{EIRP [dBm]} - 20 \log(\text{Distance [m]}) + \text{Ground bounce [dB]} + 104.8 \text{ [dBuV/m]}$$

$$\text{EIRP [dBm]} = \text{Reading [dBm]} + \text{Cable loss [dB]} + \text{Attenuator Loss [dB]} + \text{Antenna gain [dBi]} + 10 * \log(N)$$

N: Number of output

UL Japan, Inc.

Ise EMC Lab.

4383-326 Asama-cho, Ise-shi, Mie-ken 516-0021 JAPAN

Telephone : +81 596 24 8999

Facsimile : +81 596 24 8124

Power Density

Test place Ise EMC Lab. No.6 Shielded Room
Report No. 12160939H
Date February 19, 2018
Temperature / Humidity 25 deg. C / 31 % RH
Engineer Yuta Moriya
Mode Tx

Antenna Port 1

Freq.	Reading	Cable Loss	Atten. Loss	Result	Limit	Margin
[MHz]	[dBm]	[dB]	[dB]	[dBm]	[dBm]	[dB]
902.4	-3.67	0.50	9.91	6.74	8.00	1.26
915.0	-3.87	0.50	9.91	6.54	8.00	1.46
927.6	-4.07	0.50	9.91	6.34	8.00	1.66

Sample Calculation:

Result = Reading + Cable Loss (including the cable(s) customer supplied) + Attenuator Loss

Power Density

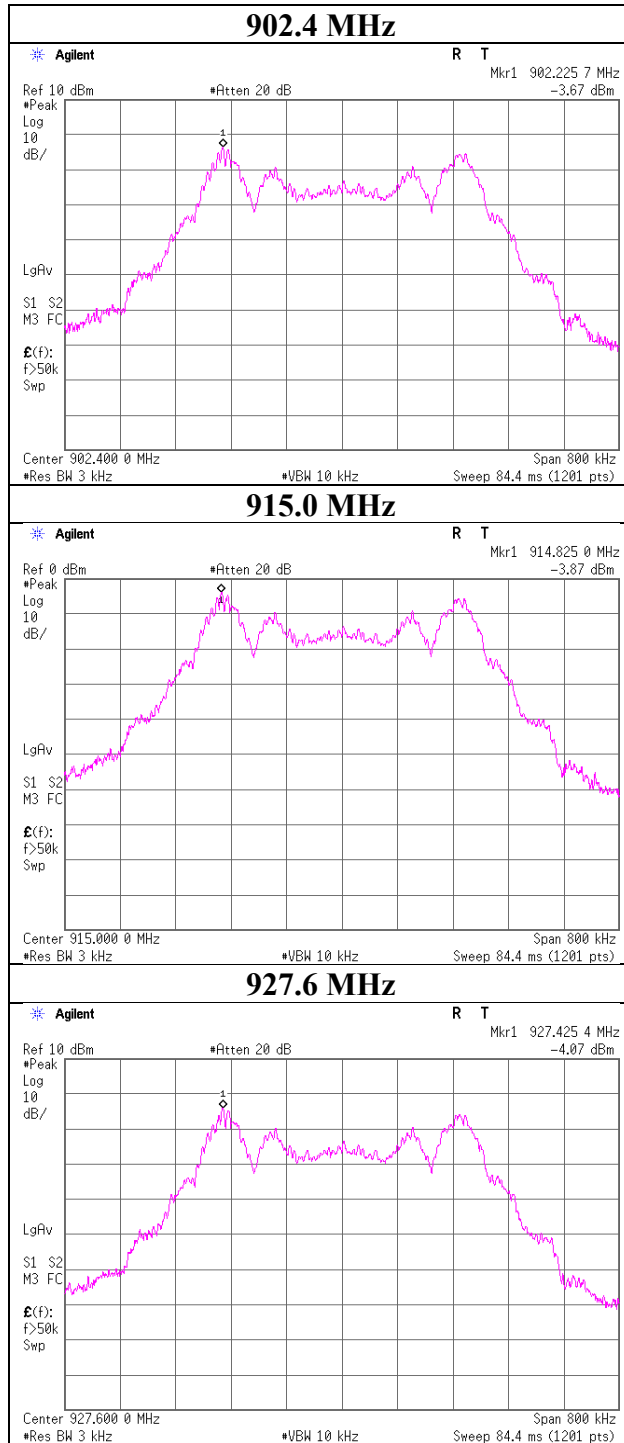

APPENDIX 2: Test instruments

Test equipment (1/2)

Control No.	Instrument	Manufacturer	Model No	Serial No	Test Item	Calibration Date * Interval(month)
MAEC-03	Semi Anechoic Chamber(NSA)	TDK	Semi Anechoic Chamber 3m	DA-10005	CE	2017/10/31 * 12
MOS-13	Thermo-Hygrometer	Custom	CTH-180	1301	CE	2018/01/24 * 12
MJM-16	Measure	KOMELON	KMC-36	-	CE	-
COTS-MEMI	EMI measurement program	TSJ	TEPTO-DV	-	CE/RE	-
MTR-08	Test Receiver	Rohde & Schwarz	ESCI	100767	CE	2017/08/22 * 12
MLS-23	LISN(AMN)	Schwarzbeck	NSLK8127	8127-729	CE(EUT)	2017/07/24 * 12
MTA-31	Terminator	TME	CT-01	-	CE	2017/12/11 * 12
MCC-112	Coaxial cable	Fujikura/Suhner/TSJ	5D-2W(10m)/ SFM141(3m)/ suoform141-PE(1m)/ 421-010(1.5m)/ RFM-E321(Switcher)	-/00640	CE	2017/07/12 * 12
MAT-66	Attenuator(13dB)	JFW Industries, Inc.	50FP-013H2 N	-	CE	2017/12/19 * 12
MTA-28	Terminator	TME	CT-01	-	CE	2017/11/09 * 12
MMM-08	DIGITAL HiTESTER	Hioki	3805	051201197	CE	2018/01/09 * 12
MAEC-04	Semi Anechoic Chamber(NSA)	TDK	Semi Anechoic Chamber 3m	DA-10005	RE	2017/10/30 * 12
MOS-15	Thermo-Hygrometer	Custom	CTH-180	1501	RE	2018/01/24 * 12
MJM-26	Measure	KOMELON	KMC-36	-	RE	-
MSA-16	Spectrum Analyzer	Agilent	E4440A	MY46186390	RE	2017/09/20 * 12
MHA-21	Horn Antenna 1-18GHz	Schwarzbeck	BBHA9120D	9120D-557	RE	2017/09/15 * 12
MCC-141	Microwave Cable	Junkosha	MWX221	1305S002R(1m) / 1405S146(5m)	RE	2017/06/23 * 12
MPA-12	MicroWave System Amplifier	Agilent	83017A	00650	RE	2017/10/06 * 12
MHF-04	High Pass Filter 1.22-4.60GHz	Mini-Circuit	VHF-1200	10435	RE	2017/08/01 * 12
MHF-26	High Pass Filter 3.5-18.0GHz	UL Japan	HPF SELECTOR	002	RE	2017/09/11 * 12
MMM-10	DIGITAL HiTESTER	Hioki	3805	051201148	RE	2018/01/09 * 12
MAEC-01	Semi Anechoic Chamber(NSA)	TDK	Semi Anechoic Chamber 10m	DA-06881	RE	2017/09/30 * 12
MOS-27	Thermo-Hygrometer	CUSTOM	CTH-201	A08Q26	RE	2018/01/24 * 12
MJM-25	Measure	KOMELON	KMC-36	-	RE	-
MTR-09	EMI Test Receiver	Rohde & Schwarz	ESU26	100412	RE	2017/06/27 * 12
MSA-14	Spectrum Analyzer	Agilent	E4440A	MY48250080	RE	2017/10/18 * 12
KBA-05	Biconical Antenna	Schwarzbeck	BBA9106	2513	RE	2017/11/23 * 12
MLA-20	Logperiodic Antenna(200-1000MHz)	Schwarzbeck	VUSLP9111B	911B-189	RE	2018/01/30 * 12
MAT-08	Attenuator(6dB)	Weinschel Corp	2	BK7971	RE	2017/11/14 * 12
MCC-02	Coaxial Cable	Suhner/storm/Agilent /TSJ	-	-	RE	2017/09/26 * 12
MPA-19	Pre Amplifier	MITEQ	MLA-10K01-B01-35	1237616	RE	2018/02/20 * 12
MMM-03	Digital Tester	Fluke	FLUKE 26-3	78030621	RE	2017/08/07 * 12
MHF-27	High Pass Filter(1.1-10GHz)	TOKYO KEIKI	TF219CD1	1001	RE	2018/01/18 * 12
MAEC-02	Semi Anechoic Chamber(NSA)	TDK	Semi Anechoic Chamber 3m	DA-06902	RE	2017/08/31 * 12
MOS-22	Thermo-Hygrometer	Custom	CTH-201	0003	RE	2017/12/21 * 12
MJM-14	Measure	KOMELON	KMC-36	-	RE	-
MSA-15	Spectrum Analyzer	Agilent	E4440A	MY46187105	RE	2017/10/16 * 12
MTR-03	Test Receiver	Rohde & Schwarz	ESCI	100300	RE	2017/08/21 * 12
MBA-08	Biconical Antenna	Schwarzbeck	VHA9103B	08031	RE	2017/09/13 * 12
MLA-21	Logperiodic Antenna(200-1000MHz)	Schwarzbeck	VUSLP9111B	911B-190	RE	2017/12/10 * 12
MCC-12	Coaxial Cable	Fujikura/Agilent	-	-	RE	2018/02/23 * 12
MAT-07	Attenuator(6dB)	Weinschel Corp	2	BK7970	RE	2017/11/14 * 12

UL Japan, Inc.

Ise EMC Lab.

4383-326 Asama-cho, Ise-shi, Mie-ken 516-0021 JAPAN

Telephone : +81 596 24 8999

Facsimile : +81 596 24 8124

Test equipment (2/2)

Control No.	Instrument	Manufacturer	Model No	Serial No	Test Item	Calibration Date * Interval(month)
MPA-09	Pre Amplifier	Agilent	8447D	2944A10845	RE	2017/09/27 * 12
MMM-01	Digital Tester	Fluke	FLUKE 26-3	78030611	RE	2017/08/07 * 12
MCC-216	Microwave Cable	Junkosha	MWX221	1604S253(1 m) / 1608S087(5 m)	RE	2017/08/04 * 12
MPA-10	Pre Amplifier	Agilent	8449B	3008A02142	RE	2018/01/23 * 12
MSA-04	Spectrum Analyzer	Agilent	E4448A	US44300523	AT	2017/11/14 * 12
MPM-08	Power Meter	Anritsu	ML2495A	6K00003338	AT	2017/10/13 * 12
MPSE-11	Power sensor	Anritsu	MA2411B	011737	AT	2017/10/13 * 12
MOS-14	Thermo-Hygrometer	Custom	CTH-201	1401	AT	2018/01/24 * 12
MAT-10	Attenuator(10dB)	Weinschel Corp	2	BL1173	AT	2017/11/14 * 12

The expiration date of the calibration is the end of the expired month.

All equipment is calibrated with valid calibrations. Each measurement data is traceable to the national or international standards.

As for some calibrations performed after the tested dates, those test equipment have been controlled by means of an unbroken chains of calibrations.

Test Item:
CE: Conducted Emission test
RE: Radiated Emission test
AT: Antenna Terminal Conducted test