

## 10. MAXIMUM CONDUCTED OUTPUT POWER SPECTRAL DENSITY

### 10.1 MEASUREMENT PROCEDURE

- (1). Connect EUT RF output port to the Spectrum Analyzer through an RF attenuator
- (2). Set the EUT Work on the top, the middle and the bottom operation frequency individually.
- (3). Set SPA Trace 1 Max hold, then View.

Note: The method of AVGPSD in the KDB 558074 item 10.3 was used in this testing.

### 10.2 TEST SET-UP (BLOCK DIAGRAM OF CONFIGURATION)

Refer To Section 8.2.

### 10.3 MEASUREMENT EQUIPMENT USED

Refer To Section 6.

### 10.4 LIMITS AND MEASUREMENT RESULT

Mode	Channel	Av.PSD [dBm/20kHz]	Limit[dBm/3kHz]	Verdict
11B	LCH	-4.41	8	PASS
11B	MCH	-3.21	8	PASS
11B	HCH	-1.15	8	PASS
11G	LCH	-7.01	8	PASS
11G	MCH	-7.45	8	PASS
11G	HCH	-7.22	8	PASS
11N20SISO	LCH	-10.45	8	PASS
11N20SISO	MCH	-9.88	8	PASS
11N20SISO	HCH	-9.02	8	PASS

### Test Graph

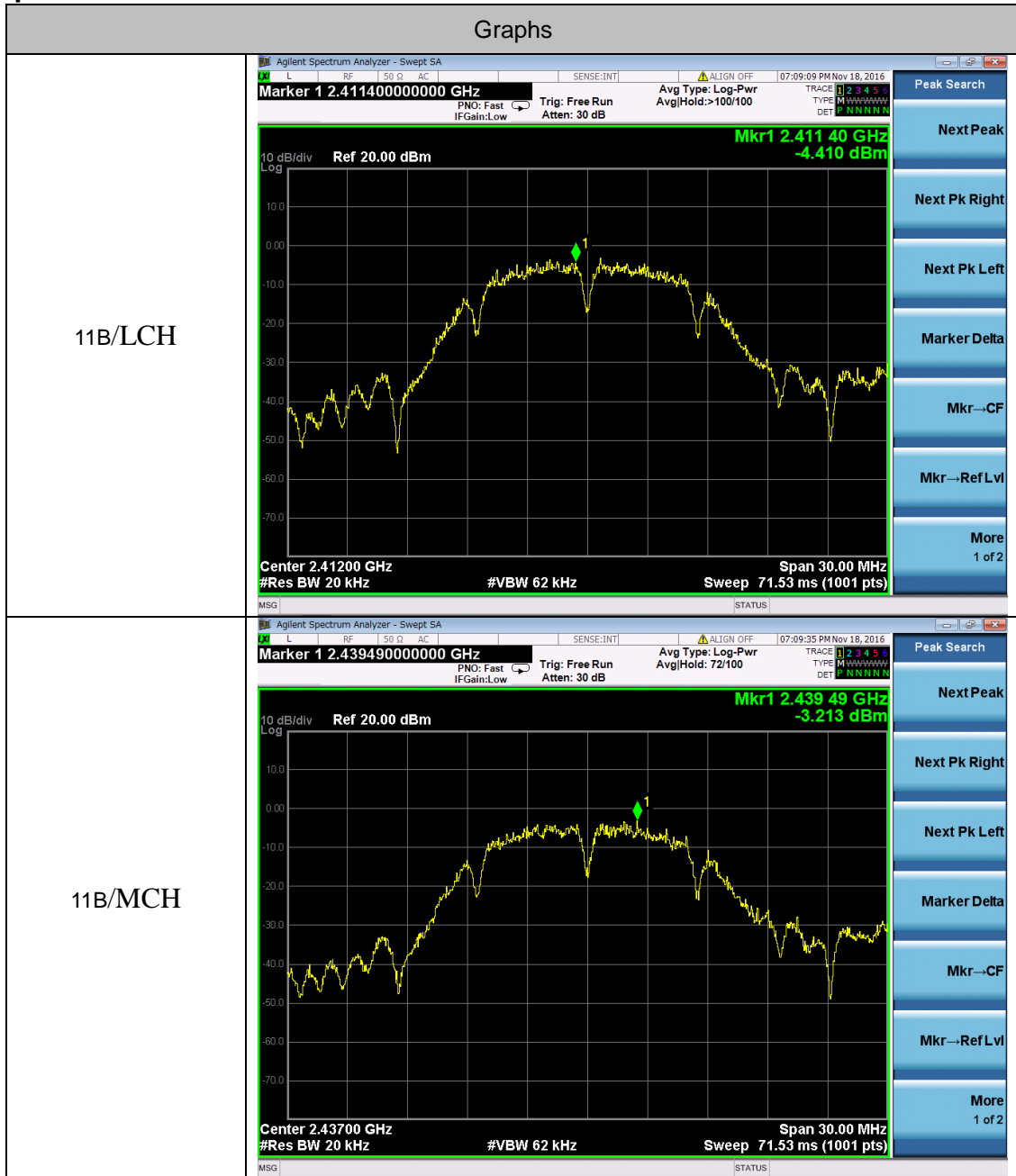







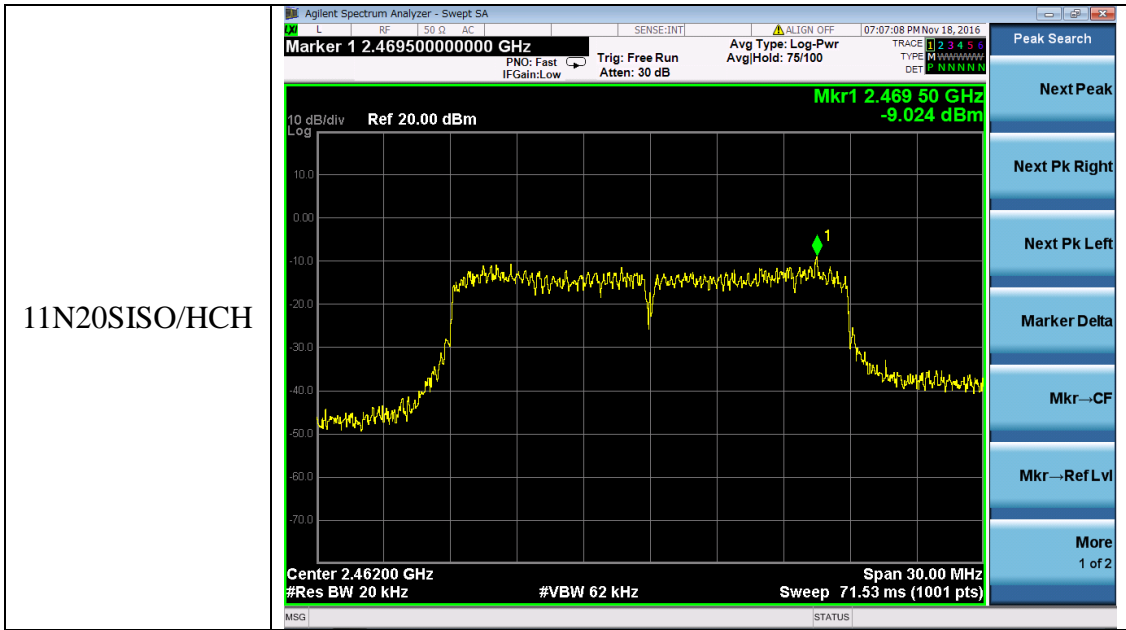

## 11. RADIATED EMISSION

### 11.1. MEASUREMENT PROCEDURE

1. Configure the EUT according to ANSI C63.10. The EUT was placed on the top of the turntable 0.8 meter above ground. The phase center of the receiving antenna mounted on the top of a height-variable antenna tower was placed 3 meters far away from the turntable.
2. Power on the EUT and all the supporting units. The turntable was rotated by 360 degrees to determine the position of the highest radiation.
3. The height of the broadband receiving antenna was varied between one meter and four meters above ground to find the maximum emissions field strength of both horizontal and vertical polarization.
4. For each suspected emissions, the antenna tower was scan (from 1 M to 4 M) and then the turntable was rotated (from 0 degree to 360 degrees) to find the maximum reading.
5. Set the test-receiver system to Peak or CISPR quasi-peak Detect Function with specified bandwidth under Maximum Hold Mode.
6. For emissions above 1GHz, use 1MHz VBW and RBW for peak reading. Then 1MHz RBW and 10Hz VBW for average reading in spectrum analyzer. The EUT was placed on the top of the turntable 1.5 meter above ground. The phase center of the receiving antenna mounted on the top of a height-variable antenna tower was placed 3 meters far away from the turntable.
7. When the radiated emissions limits are expressed in terms of the average value of the emissions, and pulsed operation is employed, the measurement field strength shall be determined by averaging over one complete pulse train, including blanking intervals, as long as the pulse train does not exceed 0.1 seconds. As an alternative (provided the transmitter operates for longer than 0.1 seconds) or in cases where the pulse train exceeds 0.1 seconds, the measured field strength shall be determined from the average absolute voltage during a 0.1 second interval during which the field strength is at its maximum values.
8. If the emissions level of the EUT in peak mode was 3 dB lower than the average limit specified, then testing will be stopped and peak values of EUT will be reported, otherwise, the emissions which do not have 3 dB margin will be repeated one by one using the quasi-peak method for below 1GHz.
9. For testing above 1GHz, the emissions level of the EUT in peak mode was lower than average limit (that means the emissions level in peak mode also complies with the limit in average mode), then testing will be stopped and peak values of EUT will be reported, otherwise, the emissions will be measured in average mode again and reported.
10. In case the emission is lower than 30MHz, loop antenna has to be used for measurement and the recorded data should be QP measured by receiver. High - Low scan is not required in this case.

## 11.2. TEST SETUP

### RADIATED EMISSION TEST SETUP 30MHz-1000MHz

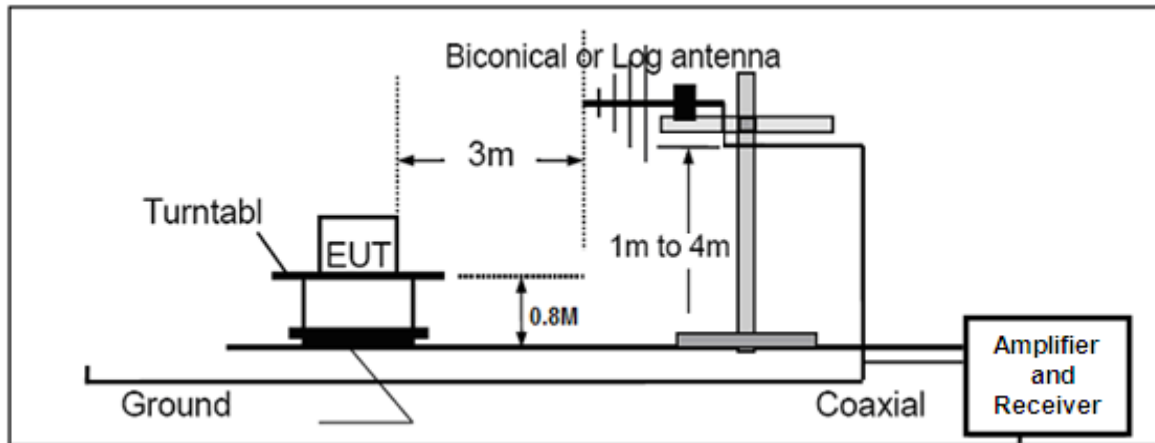

### RADIATED EMISSION TEST SETUP ABOVE 1000MHz

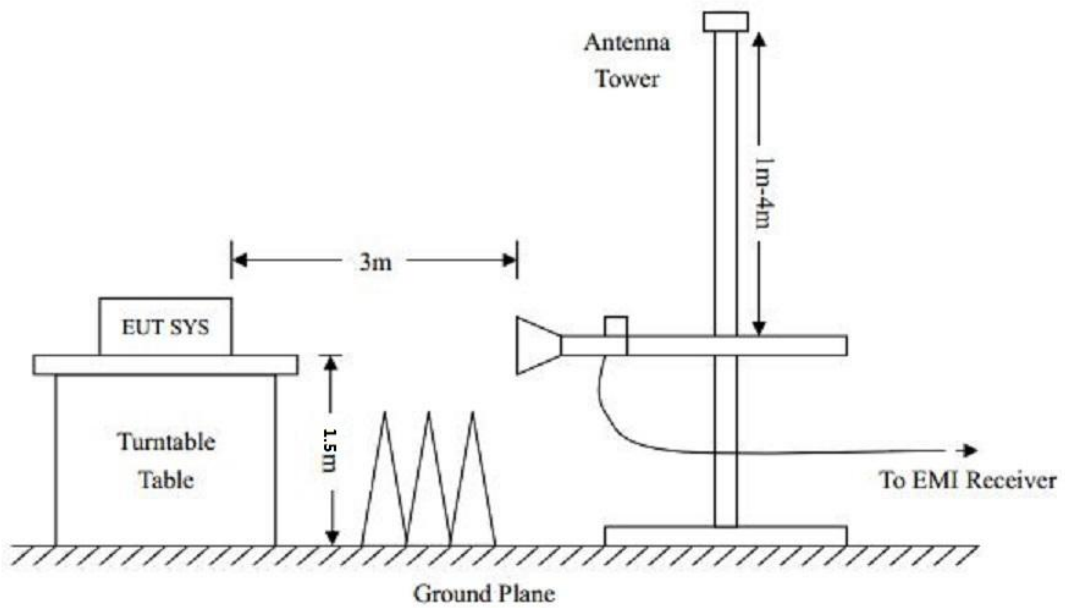



### 11.3. LIMITS AND MEASUREMENT RESULT

15.209(a) Limit in the below table has to be followed

<b>Frequencies (MHz)</b>	<b>Field Strength (micorvolts/meter)</b>	<b>Measurement Distance (meters)</b>
0.009~0.490	2400/F(KHz)	300
0.490~1.705	24000/F(KHz)	30
1.705~30.0	30	30
30~88	100	3
88~216	150	3
216~960	200	3
Above 960	500	3

Note: All modes were tested For restricted band radiated emission,  
the test records reported below are the worst result compared to other modes.

### 11.4. TEST RESULT

#### **RADIATED EMISSION BELOW 30MHZ**

No emission found between lowest internal used/generated frequencies to 30MHz.

**RADIATED EMISSION BELOW 1GHZ**

<b>EUT</b>	Mobile Phone	<b>Model Name</b>	Bluesky Shine Plus S919
<b>Temperature</b>	25°C	<b>Relative Humidity</b>	55.4%
<b>Pressure</b>	960hPa	<b>Test Voltage</b>	Normal Voltage
<b>Test Mode</b>	802.11b with date rate 1 2412MHZ	<b>Antenna</b>	Horizontal

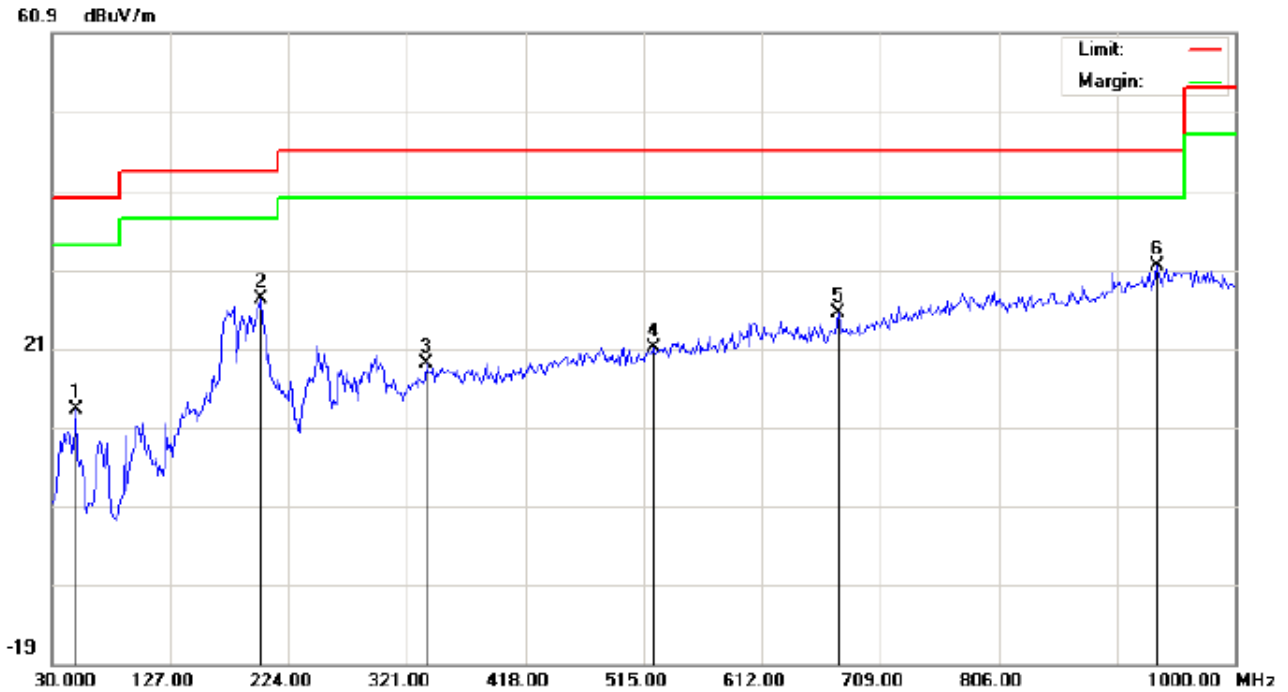

Site: site #1  
 Limit: FCC Class B 3M Radiation  
 EUT: Mobile Phone  
 M/N: Bluesky Shine Plus S919  
 Mode: Low channel TX  
 Note:

Polarization: *Horizontal*  
 Power: AC 120V/60Hz  
 Distance: 3m

Temperature: 24.6  
 Humidity: 54.3 %

No.	Mk	Freq.	Reading	Factor	Measurement	Limit	Over	Detector	Antenna Height	Table Degree	Comment
		MHz	dBuV	dB/m	dBuV/m	dBuV/m	dB		cm	degree	
1		49.4000	1.90	11.28	13.18	40.00	-26.82	peak			
2		201.3667	15.26	11.86	27.12	43.50	-16.38	peak			
3		337.1667	1.17	17.89	19.06	46.00	-26.94	peak			
4		523.0833	-0.66	21.75	21.09	46.00	-24.91	peak			
5		675.0500	0.81	24.52	25.33	46.00	-20.67	peak			
6	*	935.3333	1.74	29.59	31.33	46.00	-14.67	peak			

<b>EUT</b>	Mobile Phone	<b>Model Name</b>	Bluesky Shine Plus S919
<b>Temperature</b>	25°C	<b>Relative Humidity</b>	55.4%
<b>Pressure</b>	960hPa	<b>Test Voltage</b>	Normal Voltage
<b>Test Mode</b>	802.11b with date rate 1 2412MHZ	<b>Antenna</b>	Vertical

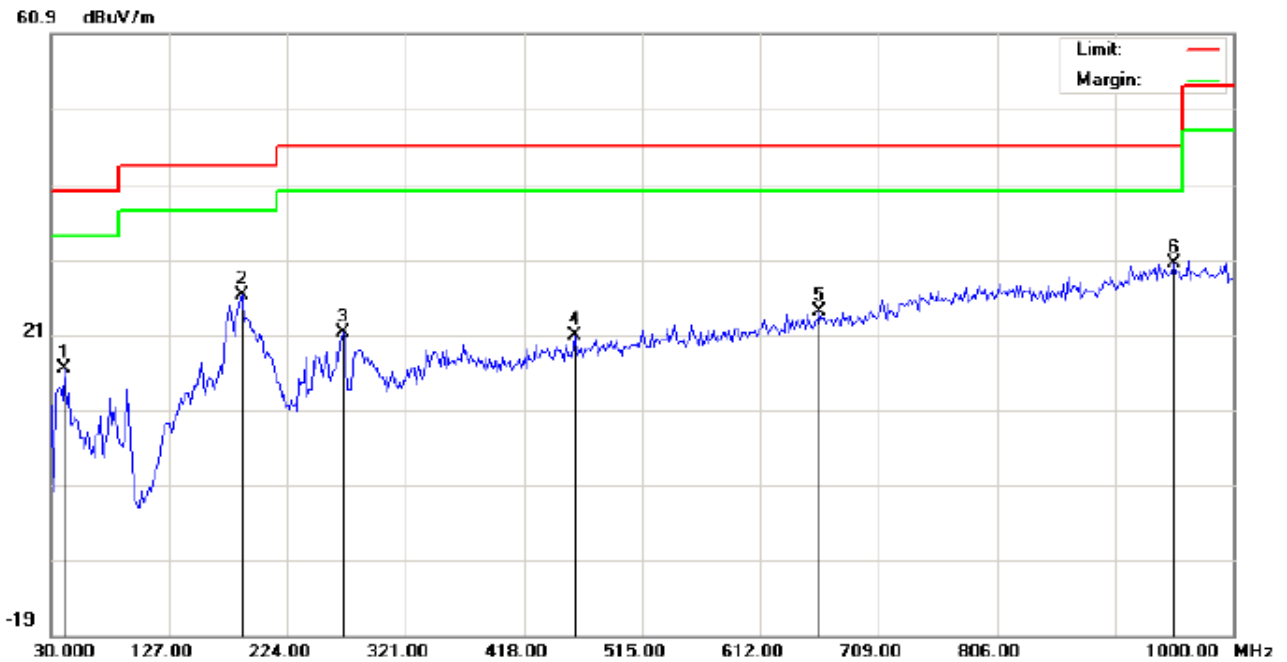

Site: site #1  
Limit: FCC Class B 3M Radiation  
EUT: Mobile Phone  
M/N: Bluesky Shine Plus S919  
Mode: Low channel TX  
Note:

Polarization: *Vertical*  
Power: AC 120V/60Hz  
Distance: 3m

Temperature: 24.6  
Humidity: 54.3 %

No.	Mk	Freq.	Reading	Factor	Measurement	Limit	Over	Detector	Antenna Height	Table Degree	Comment
		MHz	dBuV	dB/m	dBuV/m	dBuV/m	dB		cm	degree	
1		41.3167	7.52	8.81	16.33	40.00	-23.67	peak			
2		186.8167	13.81	12.34	26.15	43.50	-17.35	peak			
3		269.2667	6.80	14.48	21.28	46.00	-24.72	peak			
4		460.0333	0.09	20.70	20.79	46.00	-25.21	peak			
5		660.5000	-0.10	24.13	24.03	46.00	-21.97	peak			
6	*	951.5000	0.40	29.99	30.39	46.00	-15.61	peak			

**RESULT: PASS**

<b>EUT</b>	Mobile Phone	<b>Model Name</b>	Bluesky Shine Plus S919
<b>Temperature</b>	25°C	<b>Relative Humidity</b>	55.4%
<b>Pressure</b>	960hPa	<b>Test Voltage</b>	Normal Voltage
<b>Test Mode</b>	802.11b with date rate 1 2437MHZ	<b>Antenna</b>	Horizontal

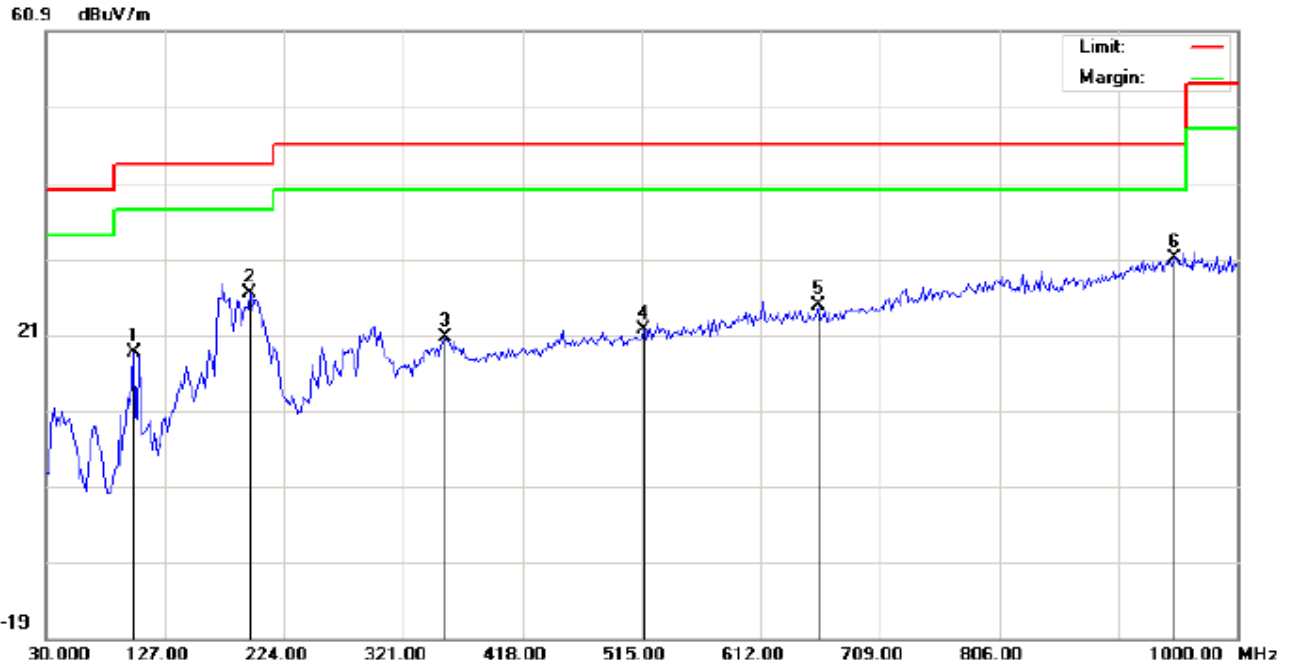

Site: site #1  
 Limit: FCC Class B 3M Radiation  
 EUT: Mobile Phone  
 M/N: Bluesky Shine Plus S919  
 Mode: Middle channel TX  
 Note:

Polarization: *Horizontal*  
 Power: AC 120V/60Hz  
 Distance: 3m

Temperature: 24.6  
 Humidity: 54.3 %

No.	Mk	Freq.	Reading	Factor	Measurement	Limit	Over	Detector	Antenna Height	Table Degree	Comment
		MHz	dBuV	dB/m	dBuV/m	dBuV/m	dB		cm	degree	
1		101.1333	8.45	10.22	18.67	43.50	-24.83	peak			
2		196.5167	14.55	11.84	26.39	43.50	-17.11	peak			
3		354.9500	1.76	18.77	20.53	46.00	-25.47	peak			
4		516.6167	0.00	21.58	21.58	46.00	-24.42	peak			
5		658.8833	0.64	24.09	24.73	46.00	-21.27	peak			
6	*	948.2667	0.99	29.95	30.94	46.00	-15.06	peak			

**RESULT: PASS**

<b>EUT</b>	Mobile Phone	<b>Model Name</b>	Bluesky Shine Plus S919
<b>Temperature</b>	25°C	<b>Relative Humidity</b>	55.4%
<b>Pressure</b>	960hPa	<b>Test Voltage</b>	Normal Voltage
<b>Test Mode</b>	802.11b with date rate 1 2437MHZ	<b>Antenna</b>	Vertical

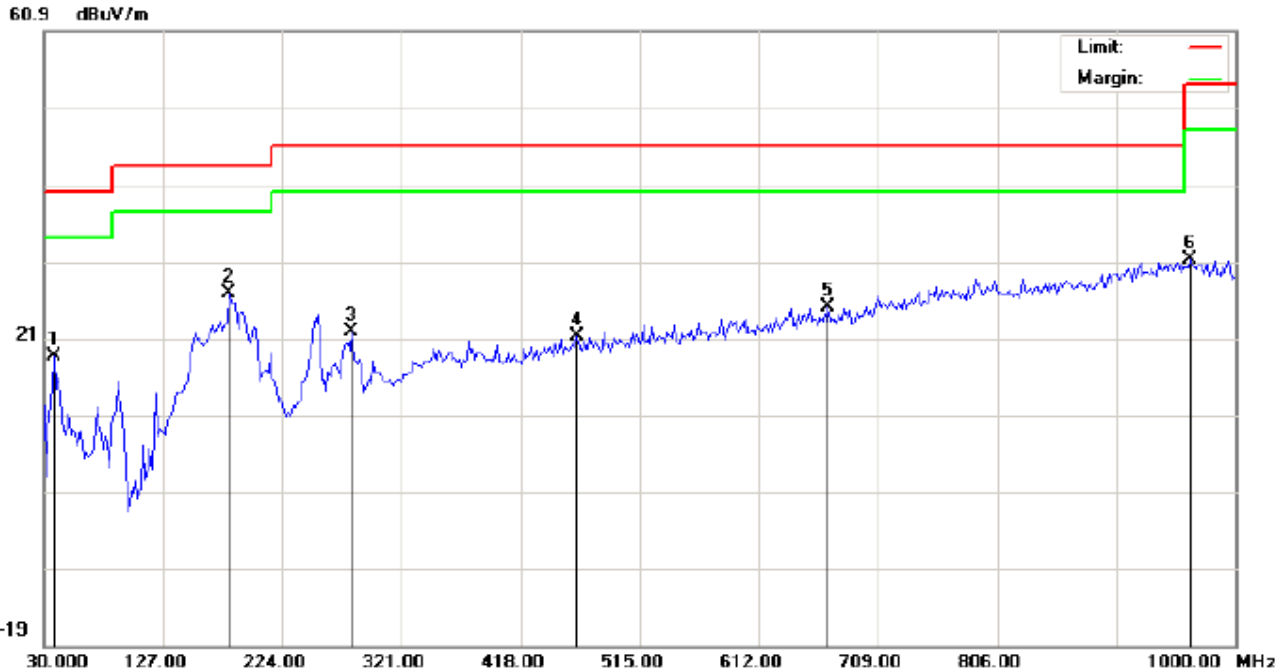

Site: site #1  
 Limit: FCC Class B 3M Radiation  
 EUT: Mobile Phone  
 M/N: Bluesky Shine Plus S919  
 Mode: Middle channel TX  
 Note:

Polarization: *Vertical*  
 Power: AC 120V/60Hz  
 Distance: 3m

Temperature: 24.6  
 Humidity: 54.3 %

No.	Mk	Freq.	Reading	Factor	Measurement	Limit	Over	Detector	Antenna Height	Table Degree	Comment
		MHz	dBuV	dB/m	dBuV/m	dBuV/m	dB		cm	degree	
1		38.0833	12.21	6.39	18.60	40.00	-21.40	peak			
2	*	180.3500	12.84	13.98	26.82	43.50	-16.68	peak			
3		280.5833	6.98	14.82	21.80	46.00	-24.20	peak			
4		463.2667	0.41	20.73	21.14	46.00	-24.86	peak			
5		668.5833	0.75	24.35	25.10	46.00	-20.90	peak			
6		962.8167	1.31	29.88	31.19	54.00	-22.81	peak			

**RESULT: PASS**

<b>EUT</b>	Mobile Phone	<b>Model Name</b>	Bluesky Shine Plus S919
<b>Temperature</b>	25°C	<b>Relative Humidity</b>	55.4%
<b>Pressure</b>	960hPa	<b>Test Voltage</b>	Normal Voltage
<b>Test Mode</b>	802.11b with date rate 1 2462MHZ	<b>Antenna</b>	Horizontal

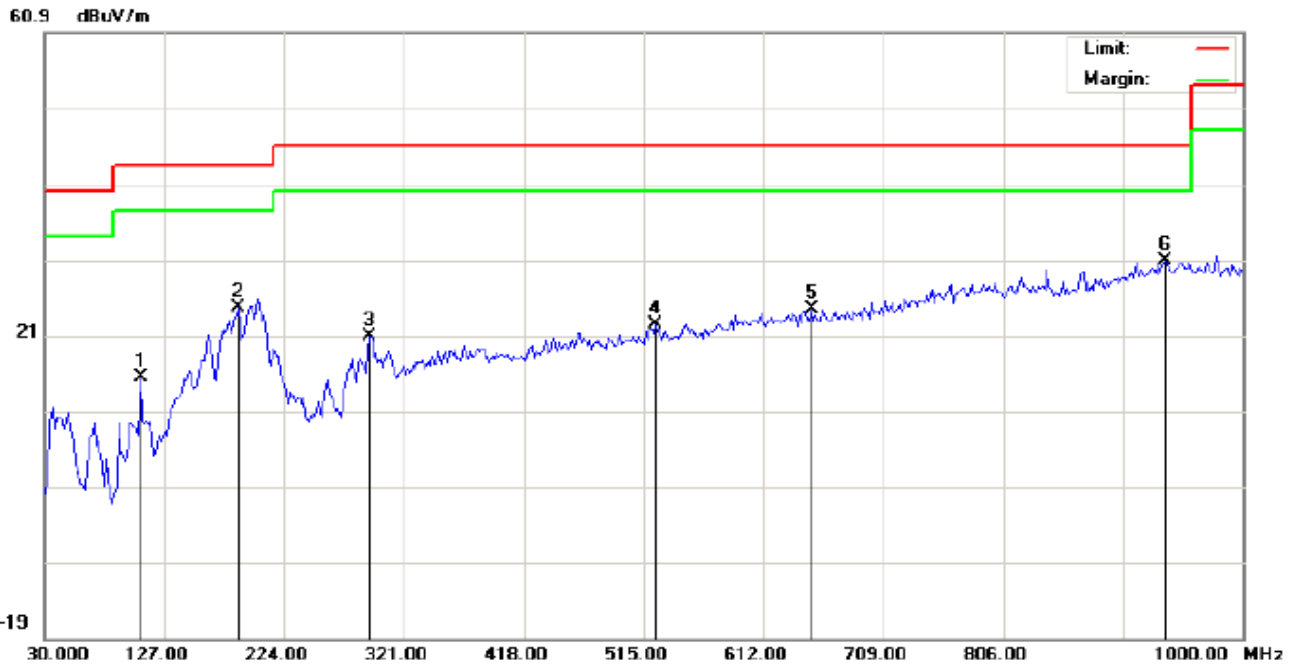

Site: site #1  
 Limit: FCC Class B 3M Radiation  
 EUT: Mobile Phone  
 M/N: Bluesky Shine Plus S919  
 Mode: High channel TX  
 Note:

Polarization: *Horizontal*  
 Power: AC 120V/60Hz  
 Distance: 3m

Temperature: 24.6  
 Humidity: 54.3 %

No.	Mk	Freq.	Reading	Factor	Measurement	Limit	Over	Detector	Antenna Height	Table Degree	Comment
		MHz	dBuV	dB/m	dBuV/m	dBuV/m	dB		cm	degree	
1		107.6000	6.70	8.72	15.42	43.50	-28.08	peak			
2		186.8167	13.18	11.39	24.57	43.50	-18.93	peak			
3		293.5167	6.48	14.31	20.79	46.00	-25.21	peak			
4		524.7000	0.68	21.80	22.48	46.00	-23.52	peak			
5		650.8000	0.50	23.87	24.37	46.00	-21.63	peak			
6	*	936.9500	1.18	29.64	30.82	46.00	-15.18	peak			

<b>EUT</b>	Mobile Phone	<b>Model Name</b>	Bluesky Shine Plus S919
<b>Temperature</b>	25°C	<b>Relative Humidity</b>	55.4%
<b>Pressure</b>	960hPa	<b>Test Voltage</b>	Normal Voltage
<b>Test Mode</b>	802.11b with date rate 1 2462MHZ	<b>Antenna</b>	Vertical

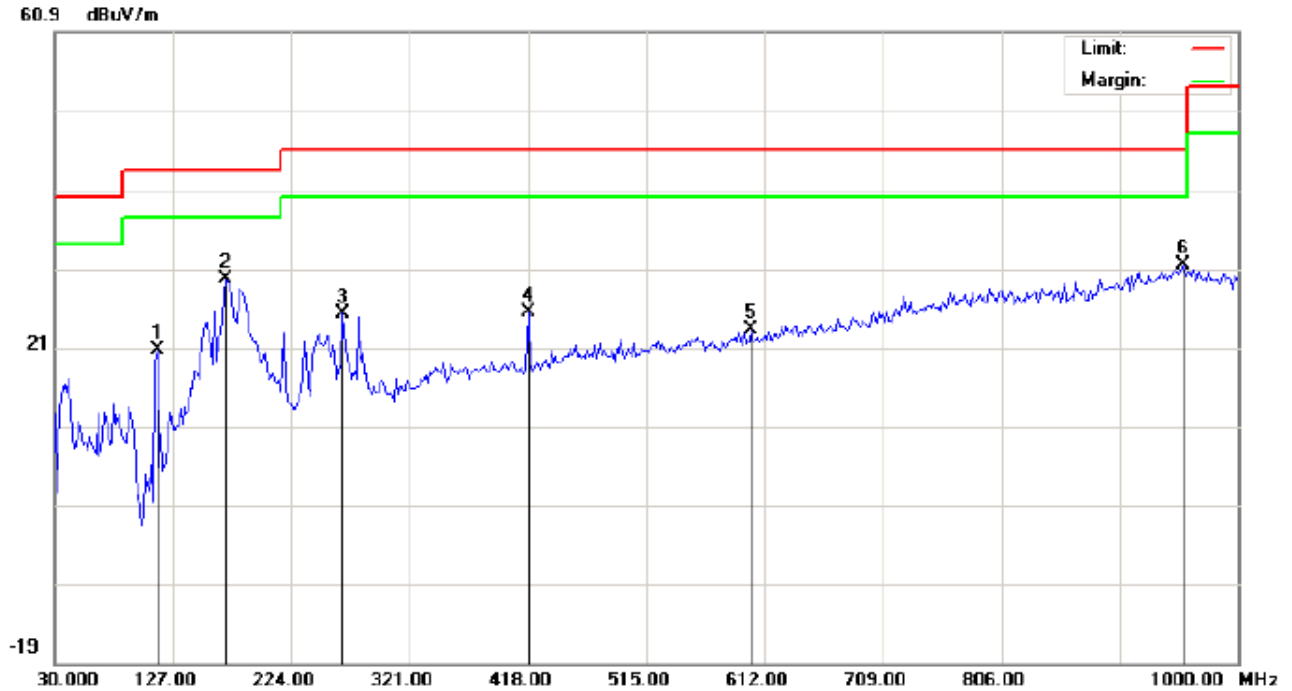

Site: site #1  
 Limit: FCC Class B 3M Radiation  
 EUT: Mobile Phone  
 M/N: Bluesky Shine Plus S919  
 Mode: High channel TX  
 Note:

Polarization: **Vertical**  
 Power: AC 120V/60Hz  
 Distance: 3m

Temperature: 24.6  
 Humidity: 54.3 %

No.	Mk	Freq.	Reading	Factor	Measurement	Limit	Over	Detector	Antenna Height	Table Degree	Comment
		MHz	dBuV	dB/m	dBuV/m	dBuV/m	dB		cm	degree	
1		114.0667	16.65	3.91	20.56	43.50	-22.94	peak			
2	*	170.6500	14.99	14.66	29.65	43.50	-13.85	peak			
3		266.0333	10.90	14.38	25.28	46.00	-20.72	peak			
4		418.0000	5.77	19.62	25.39	46.00	-20.61	peak			
5		600.6833	0.49	22.75	23.24	46.00	-22.76	peak			
6		954.7333	1.48	29.95	31.43	46.00	-14.57	peak			

**RESULT: PASS**

- Note:** 1. Factor=Antenna Factor + Cable loss, Margin= Result -Limit.
2. The “Factor” value can be calculated automatically by software of measurement system.
3. 30MHz~1GHz:(Scan with 11b,11g,11n, the worst case is 11b Mode)



**RADIATED EMISSION ABOVE 1GHZ**

Frequency	Meter Reading	Factor	Emission Level	Limits	Margin	Detector	Comment
(MHz)	(dBµV)	(dB)	(dBµV/m)	(dBµV/m)	(dB)	Type	
TX 11b 2412MHz							
4824.092	41.93	10.44	52.37	74	-21.63	Pk	Horizontal
4824.092	31.27	10.44	41.71	54	-12.29	AV	Horizontal
7236.127	43.74	10.39	54.13	74	-19.87	pk	Horizontal
7236.127	32.43	10.39	42.82	54	-11.18	AV	Horizontal
4824.098	41.05	10.39	51.44	74	-22.56	Pk	Vertical
4824.082	33.01	10.39	43.4	54	-10.6	AV	Vertical
7236.110	49.37	10.68	60.05	74	-13.95	Pk	Vertical
7236.054	34.52	10.68	45.2	54	-8.8	AV	Vertical
TX 11b 2437MHz							
4874.072	49.18	10.39	59.57	74	-14.43	Pk	Horizontal
4874.108	33.71	10.39	44.1	54	-9.9	AV	Horizontal
7311.092	47.52	12.68	60.2	74	-13.8	Pk	Horizontal
7311.131	30.16	12.68	42.84	54	-11.16	AV	Horizontal
4874.098	49.72	10.39	60.11	74	-13.89	Pk	Vertical
4874.044	34.62	10.39	45.01	54	-8.99	AV	Vertical
7311.145	48.55	12.68	61.23	74	-12.77	Pk	Vertical
7311.104	31.24	12.68	43.92	54	-10.08	AV	Vertical
TX 11b 2462MHz							
4924.128	49.35	10.39	59.74	74	-14.26	pk	Horizontal
4924.083	33.74	10.39	44.13	54	-9.87	AV	Horizontal
7386.071	48.34	12.68	61.02	74	-12.98	pk	Horizontal
7386.134	35.26	12.68	47.94	54	-6.06	AV	Horizontal
4924.042	41.29	10.39	51.68	74	-22.32	pk	Vertical
4924.060	33.92	10.39	44.31	54	-9.69	AV	Vertical
7386.051	48.32	12.68	61	74	-13	pk	Vertical
7386.054	30.47	12.68	43.15	54	-10.85	AV	Vertical

**RESULT: PASS**

**Note:** 1~25GHz scan with 11b. No recording in the test report at least have 20dB margin.

Factor = Antenna Factor + Cable Loss – Pre-amplifier.

Emission Level = Meter Reading + Factor

Margin = Emission Level - Limit

## 12. BAND EDGE EMISSION

### 12.1. MEASUREMENT PROCEDURE

1) Radiated restricted band edge measurements

The radiated restricted band edge measurements are measured with an EMI test receiver connected to the receive antenna while the EUT is transmitting

2) Conducted Emissions at the bang edge

a) The transmitter output was connected to the spectrum analyzer

b) Set RBW=100kHz, VBW=300kHz

c) Suitable frequency span including 100kHz bandwidth from band edge

### 12.2. TEST SET-UP

Radiated same as 11.2

Conducted set up

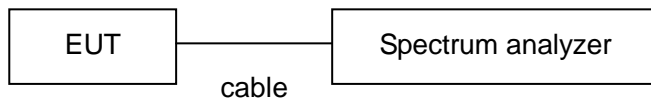

### 12.3. Radiated Test Result

Frequency	Meter Reading	Factor	Emission Level	Limits	Margin	Detector	Comment
(MHz)	(dB $\mu$ V)	(dB)	(dB $\mu$ V/m)	(dB $\mu$ V/m)	(dB)	Type	
TX 11b 2412MHz							
2399.9	78.27	-13	65.27	74	-8.73	peak	Horizontal
2399.9	54.23	-13	41.23	54	-12.77	AVG	Horizontal
2400	79.62	-12.99	66.63	74	-7.37	peak	Horizontal
2400	57.21	-12.99	44.22	54	-9.78	AVG	Horizontal
2399.9	79.49	-12.97	66.52	74	-7.48	peak	Vertical
2399.9	59.52	-12.97	46.55	54	-7.45	AVG	Vertical
2400	78.28	-12.94	65.34	74	-8.66	peak	Vertical
2400	59.76	-12.94	46.82	54	-7.18	AVG	Vertical
TX 11b 2462MHz							
2483.5	78.37	-12.78	65.59	74	-8.41	peak	Horizontal
2483.5	58.23	-12.78	45.45	54	-8.55	AVG	Horizontal
2483.6	72.35	-12.77	59.58	74	-14.42	peak	Horizontal
2483.6	58.59	-12.77	45.82	54	-8.18	AVG	Horizontal
2483.5	79.52	-12.76	66.76	74	-7.24	peak	Vertical
2483.5	54.15	-12.76	41.39	54	-12.61	AVG	Vertical
2483.6	78.66	-12.72	65.94	74	-8.06	peak	Vertical
2483.6	57.21	-12.72	44.49	54	-9.51	AVG	Vertical

#### RESULT: PASS

**Note:** Scan with 11b,11g,11n, the worst case is 11b Mode

Factor=Antenna Factor + Cable loss - Amplifier gain,

Emission Level = Meter Reading + Factor

Margin= Emission Level -Limit.

The "Factor" value can be calculated automatically by software of measurement system.

#### 12.4. Conducted Test Result

Mode	Channel	Carrier Power[dBm]	Max.Spurious Level [dBm]	Limit [dBm]	Verdict
11B	LCH	3.49	-35.28	-16.5	PASS
11B	HCH	2.58	-46.79	-17.4	PASS
11G	LCH	-5.33	-40.28	-25.3	PASS
11G	HCH	-4.52	-45.97	-24.5	PASS
11N20SISO	LCH	-6.14	-45.48	-26.1	PASS
11N20SISO	HCH	-4.87	-46.64	-24.9	PASS

Test Graph

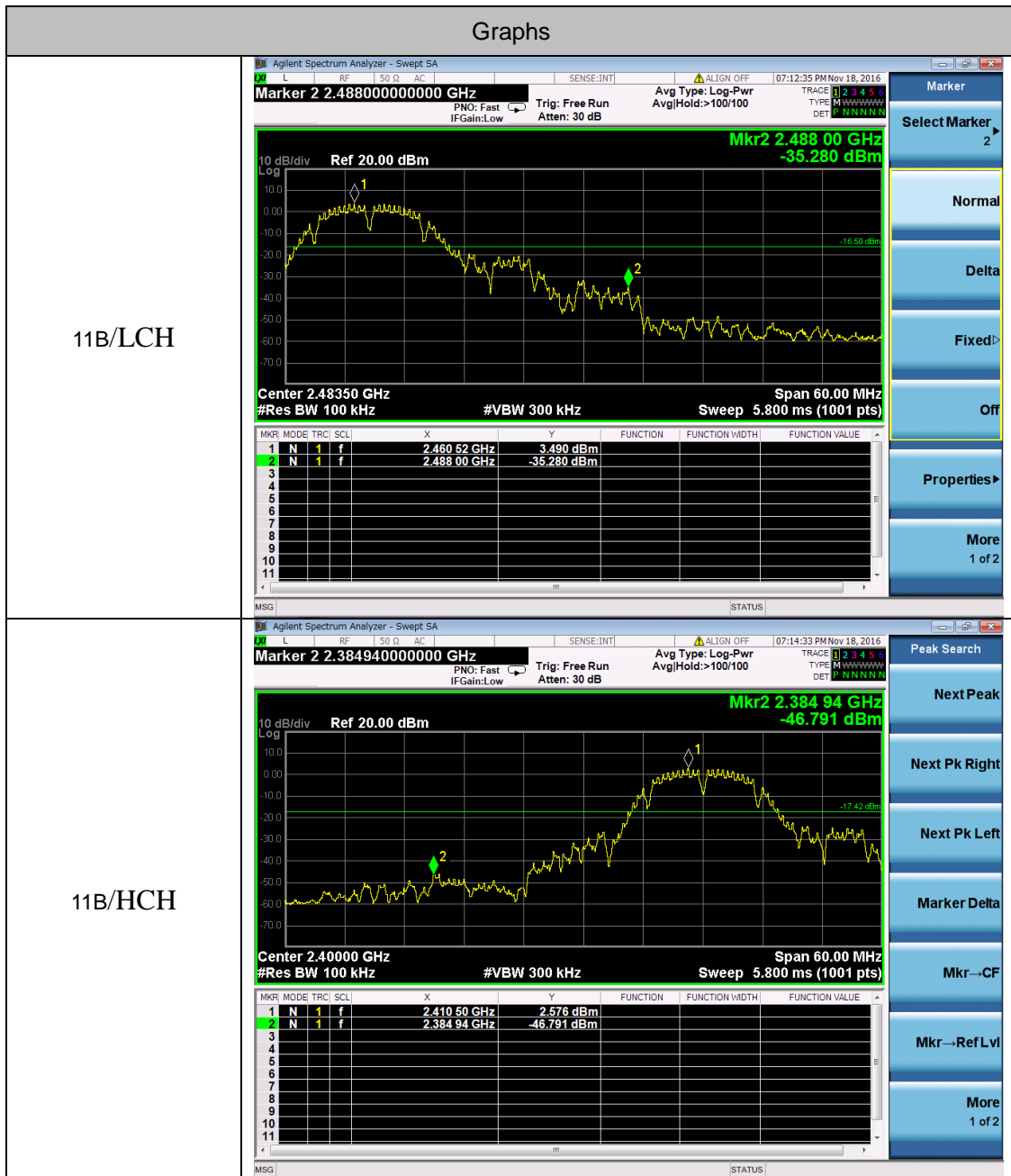

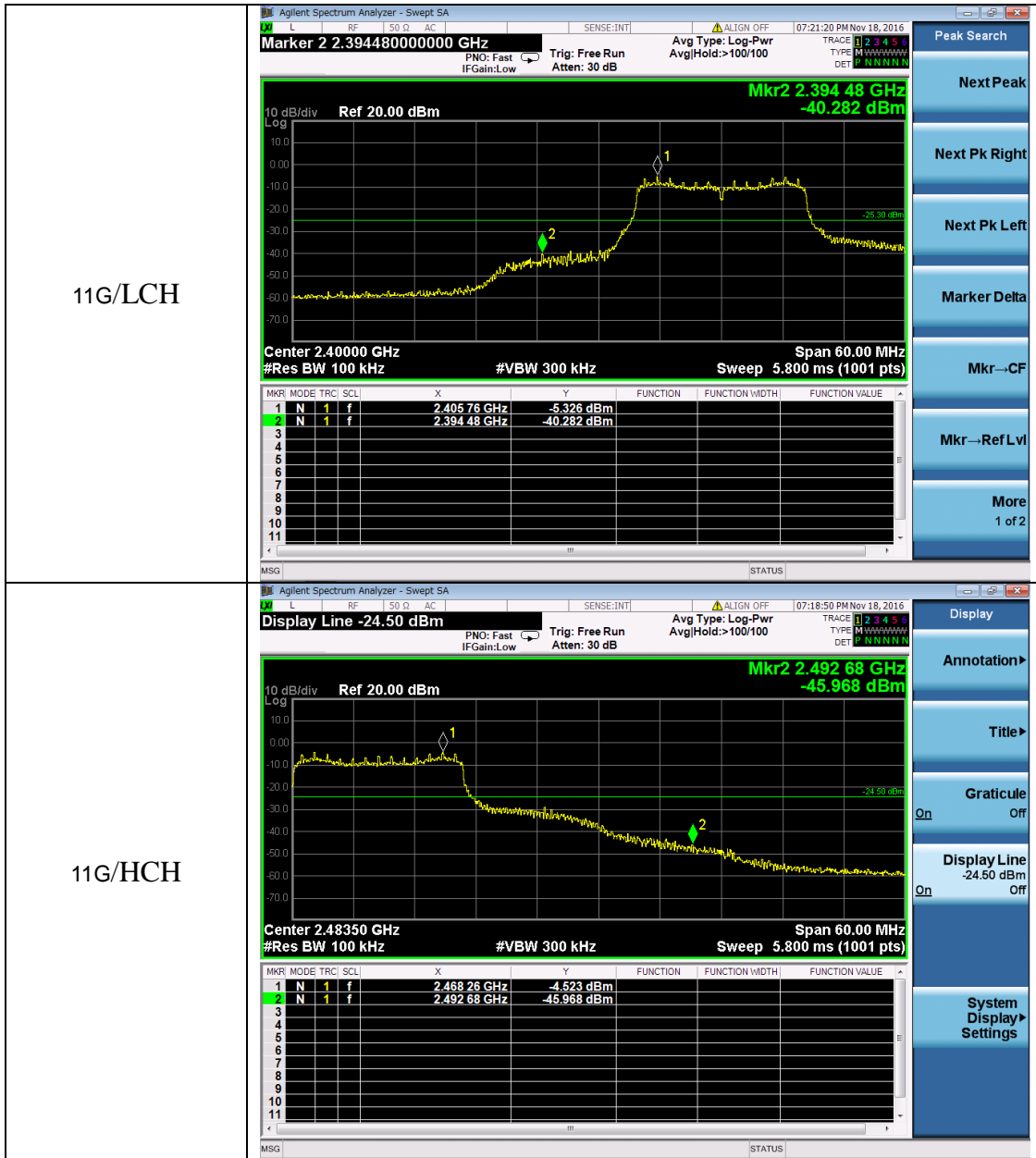

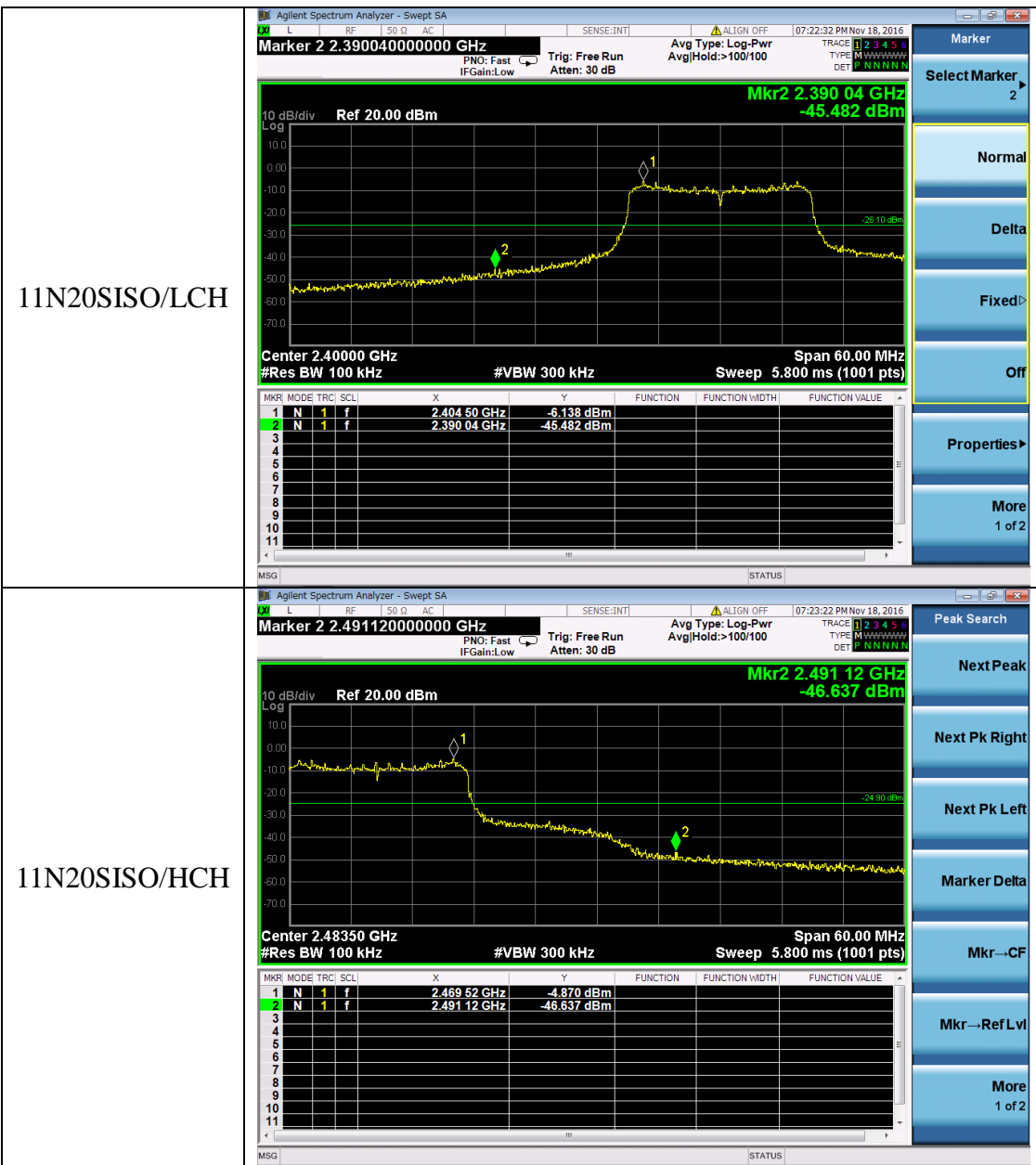

### 13. FCC LINE CONDUCTED EMISSION TEST

#### 13.1. LIMITS OF LINE CONDUCTED EMISSION TEST

Frequency	Maximum RF Line Voltage	
	Q.P.( dBuV)	Average( dBuV)
150kHz~500kHz	66-56	56-46
500kHz~5MHz	56	46
5MHz~30MHz	60	50

Note:

1. The lower limit shall apply at the transition frequency.
2. The limit decreases linearly with the logarithm of the frequency in the range 0.15 MHz to 0.50 MHz.

#### 13.2. BLOCK DIAGRAM OF LINE CONDUCTED EMISSION TEST

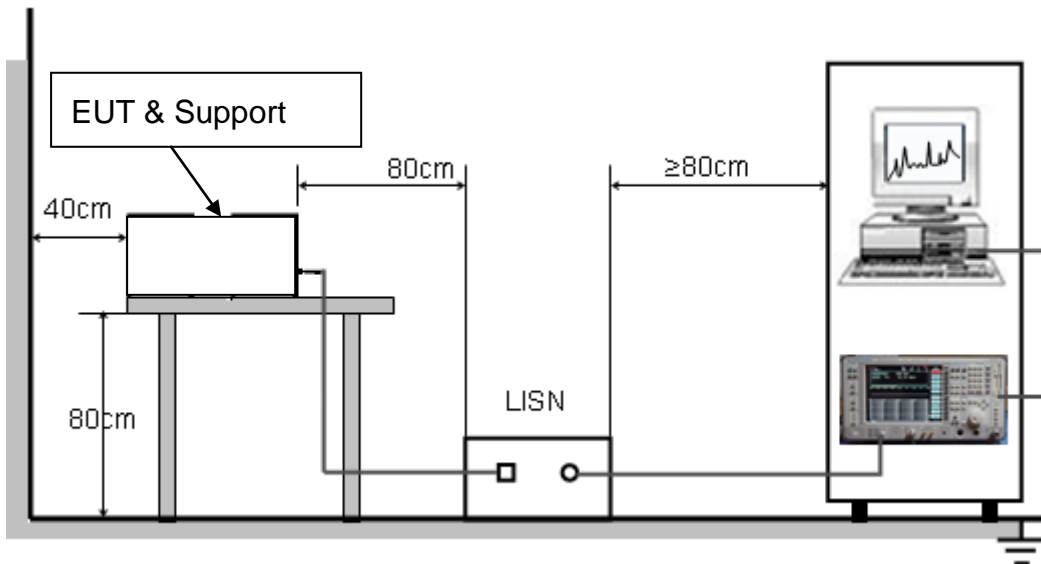



### **13.3. PRELIMINARY PROCEDURE OF LINE CONDUCTED EMISSION TEST**

1. The equipment was set up as per the test configuration to simulate typical actual usage per the user's manual. When the EUT is a tabletop system, a wooden table with a height of 0.8 meters is used and is placed on the ground plane as per ANSI C63.10 (see Test Facility for the dimensions of the ground plane used). When the EUT is a floor-standing equipment, it is placed on the ground plane which has a 3-12 mm non-conductive covering to insulate the EUT from the ground plane.
2. Support equipment, if needed, was placed as per ANSI C63.10.
3. All I/O cables were positioned to simulate typical actual usage as per ANSI C63.10.
4. All support equipments received AC120V/60Hz power from a LISN, if any.
5. The EUT received charging voltage by adapter which received 120V/60Hz power by a LISN..
6. The test program was started. Emissions were measured on each current carrying line of the EUT using a spectrum Analyzer / Receiver connected to the LISN powering the EUT. The LISN has two monitoring points: Line 1 (Hot Side) and Line 2 (Neutral Side). Two scans were taken: one with Line 1 connected to Analyzer / Receiver and Line 2 connected to a 50 ohm load; the second scan had Line 1 connected to a 50 ohm load and Line 2 connected to the Analyzer / Receiver.
7. Analyzer / Receiver scanned from 150 kHz to 30MHz for emissions in each of the test modes.
8. During the above scans, the emissions were maximized by cable manipulation.
9. The test mode(s) were scanned during the preliminary test.

Then, the EUT configuration and cable configuration of the above highest emission level were recorded for reference of final testing.

### **13.4. FINAL PROCEDURE OF LINE CONDUCTED EMISSION TEST**

1. EUT and support equipment was set up on the test bench as per step 2 of the preliminary test.
2. A scan was taken on both power lines, Line 1 and Line 2, recording at least the six highest emissions. Emission frequency and amplitude were recorded into a computer in which correction factors were used to calculate the emission level and compare reading to the applicable limit. If EUT emission level was less -2dB to the A.V. limit in Peak mode, then the emission signal was re-checked using Q.P and Average detector.
3. The test data of the worst case condition(s) was reported on the Summary Data page.

13.5. TEST RESULT OF LINE CONDUCTED EMISSION TEST

LINE CONDUCTED EMISSION TEST LINE 1-L

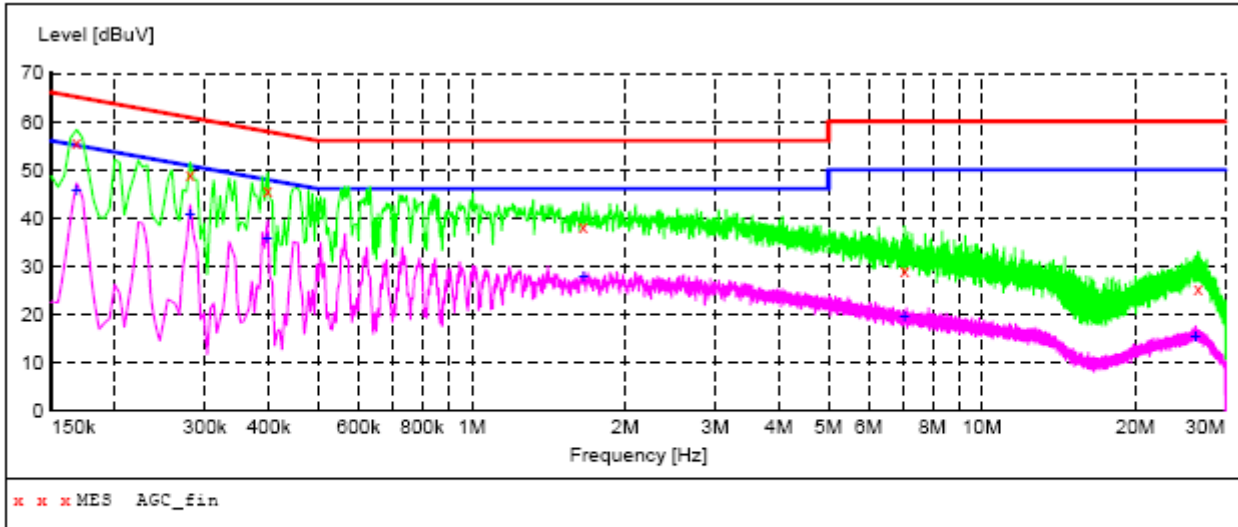

MEASUREMENT RESULT: "AGC\_fin"

2016/11/14 11:10

Frequency	Level	Transd	Limit	Margin	Detector	Line	PE	AUX STATE
MHz	dBuV	dB	dBuV	dB				
0.168000	55.50	10.3	65	9.6	QP	L1	FLO	ON
0.280500	48.80	10.3	61	12.0	QP	L1	FLO	ON
0.397500	45.50	10.3	58	12.4	QP	L1	FLO	ON
1.653000	38.10	10.4	56	17.9	QP	L1	FLO	ON
7.053000	29.10	10.7	60	30.9	QP	L1	FLO	ON
26.506500	25.40	11.9	60	34.6	QP	L1	FLO	ON

MEASUREMENT RESULT: "AGC\_fin2"

2016/11/14 11:10

Frequency	Level	Transd	Limit	Margin	Detector	Line	PE	AUX STATE
MHz	dBuV	dB	dBuV	dB				
0.168000	45.80	10.3	55	9.3	AV	L1	FLO	ON
0.280500	40.70	10.3	51	10.1	AV	L1	FLO	ON
0.397500	35.70	10.3	48	12.2	AV	L1	FLO	ON
1.657500	27.60	10.4	46	18.4	AV	L1	FLO	ON
7.053000	19.30	10.7	50	30.7	AV	L1	FLO	ON
26.218500	15.40	11.9	50	34.6	AV	L1	FLO	ON

Line Conducted Emission Test Line 2-N

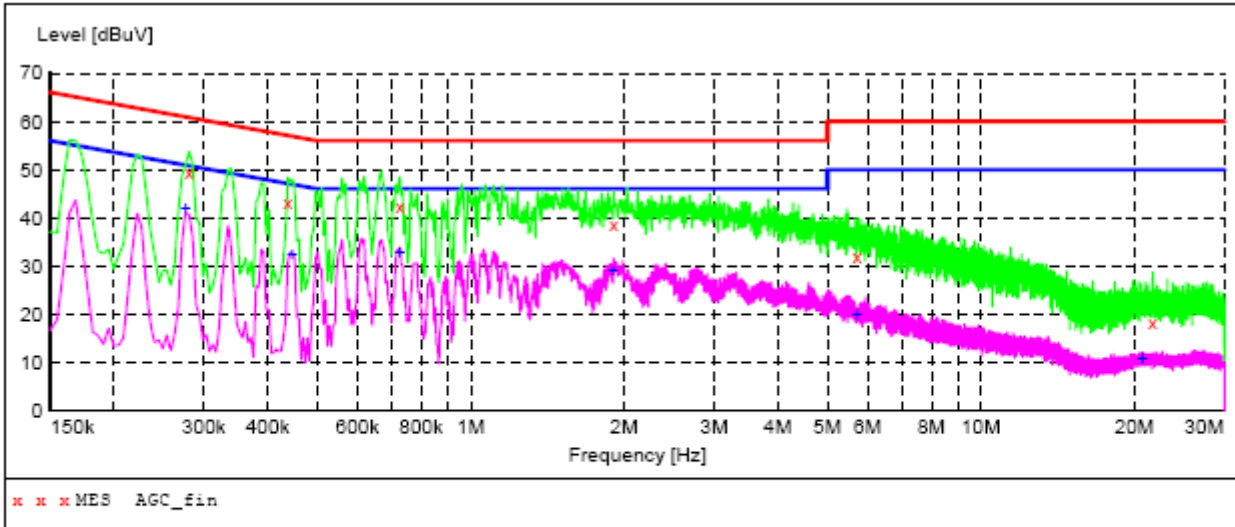

**MEASUREMENT RESULT: "AGC\_fin"**

2016/11/16 17:14

Frequency	Level	Transd	Limit	Margin	Detector	Line	PE	AUX STATE
MHz	dBuV	dB	dBuV	dB				
0.280500	49.40	10.3	61	11.4	QP	N	FLO	ON
0.438000	43.30	10.3	57	13.8	QP	N	FLO	ON
0.726000	42.40	10.3	56	13.6	QP	N	FLO	ON
1.905000	38.80	10.4	56	17.2	QP	N	FLO	ON
5.721000	32.10	10.6	60	27.9	QP	N	FLO	ON
21.709500	18.30	12.0	60	41.7	QP	N	FLO	ON

**MEASUREMENT RESULT: "AGC\_fin2"**

2016/11/16 17:14

Frequency	Level	Transd	Limit	Margin	Detector	Line	PE	AUX STATE
MHz	dBuV	dB	dBuV	dB				
0.276000	41.90	10.3	51	9.0	AV	N	FLO	ON
0.447000	32.20	10.3	47	14.7	AV	N	FLO	ON
0.726000	32.70	10.3	46	13.3	AV	N	FLO	ON
1.905000	28.90	10.4	46	17.1	AV	N	FLO	ON
5.721000	20.00	10.6	50	30.0	AV	N	FLO	ON
20.764500	10.60	12.1	50	39.4	AV	N	FLO	ON

## APPENDIX A: PHOTOGRAPHS OF TEST SETUP

### FCC LINE CONDUCTED EMISSION TEST SETUP

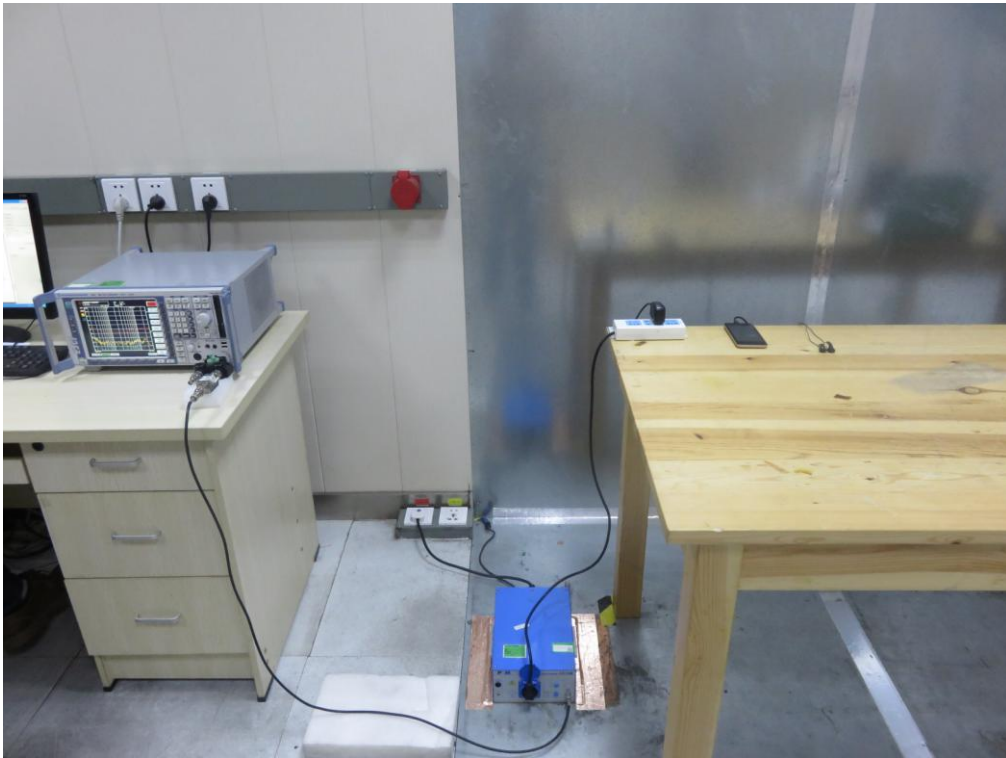

### FCC RADIATED EMISSION TEST SETUP

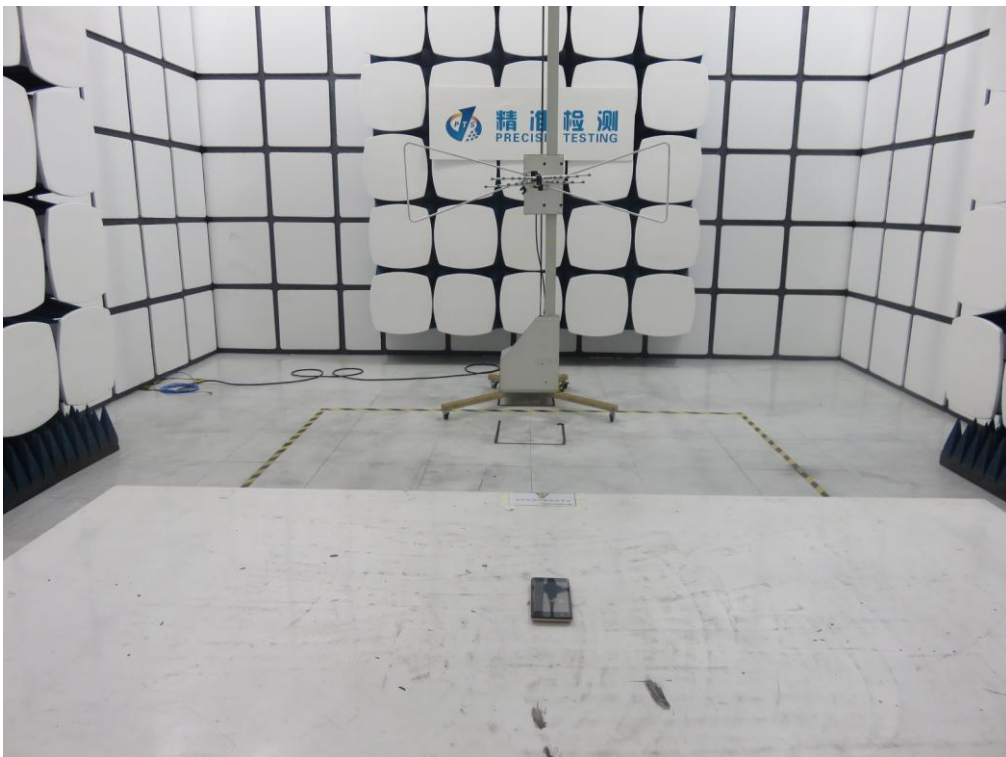

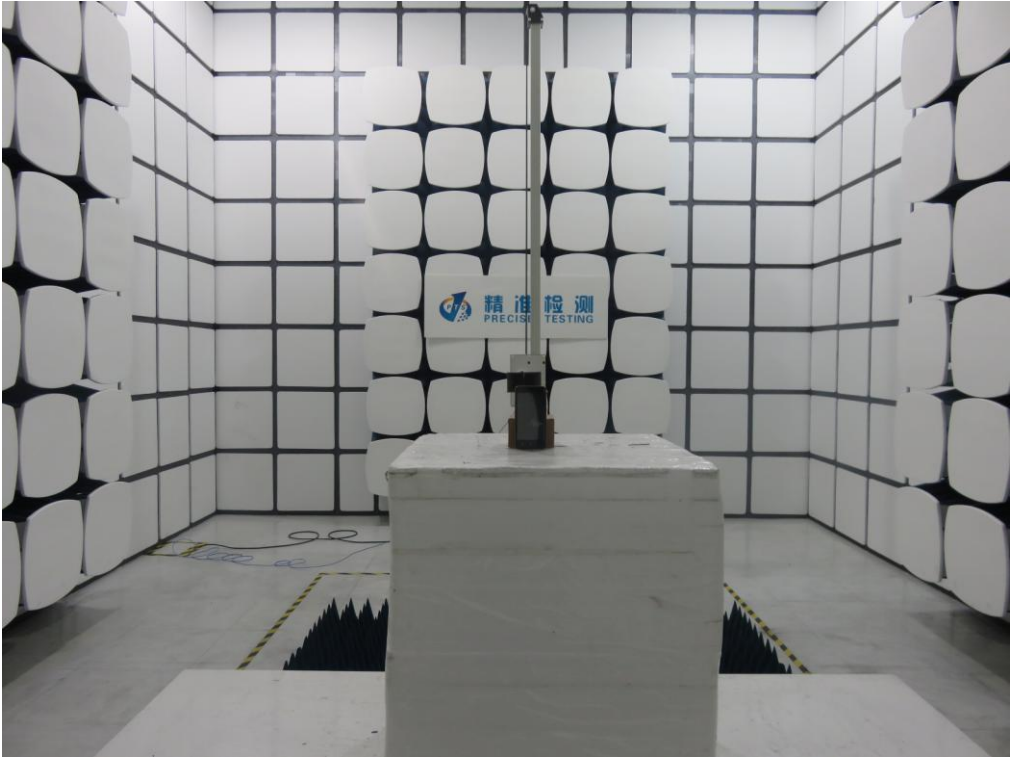

## APPENDIX B: PHOTOGRAPHS OF EUT

### All VIEW OF EUT



THE LABEL OF ADAPTER



### THE LABEL OF BATTERY



### TOP VIEW OF EUT



BOTTOM VIEW OF EUT



FRONT VIEW OF EUT





BACK VIEW OF EUT



LEFT VIEW OF EUT

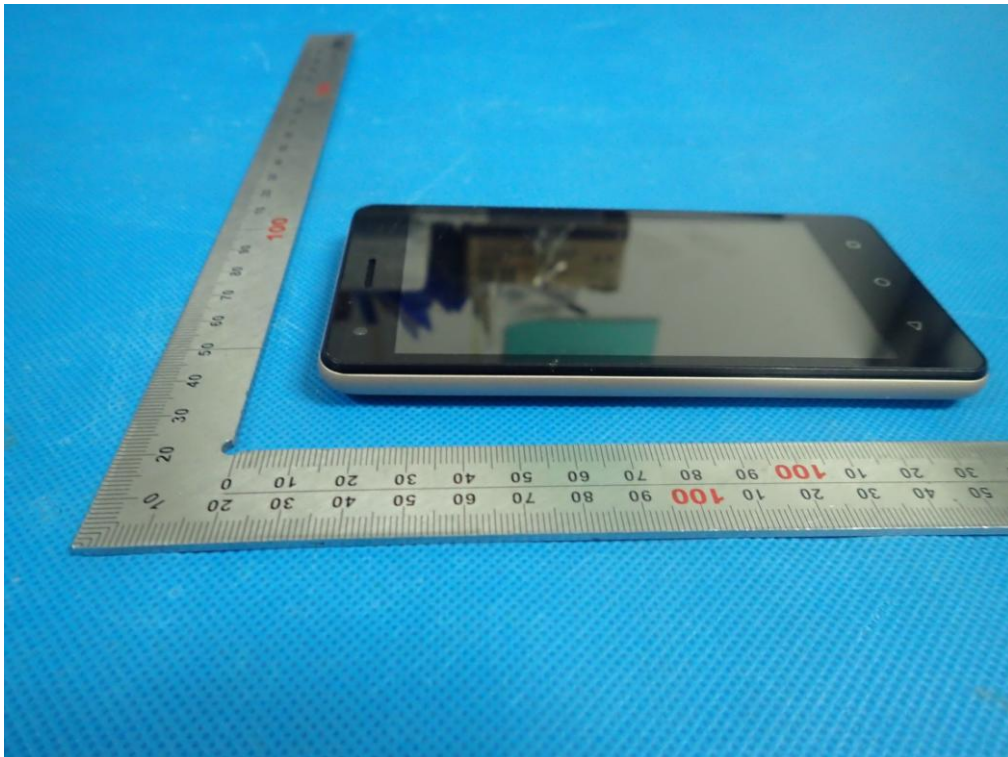

RIGHT VIEW OF EUT

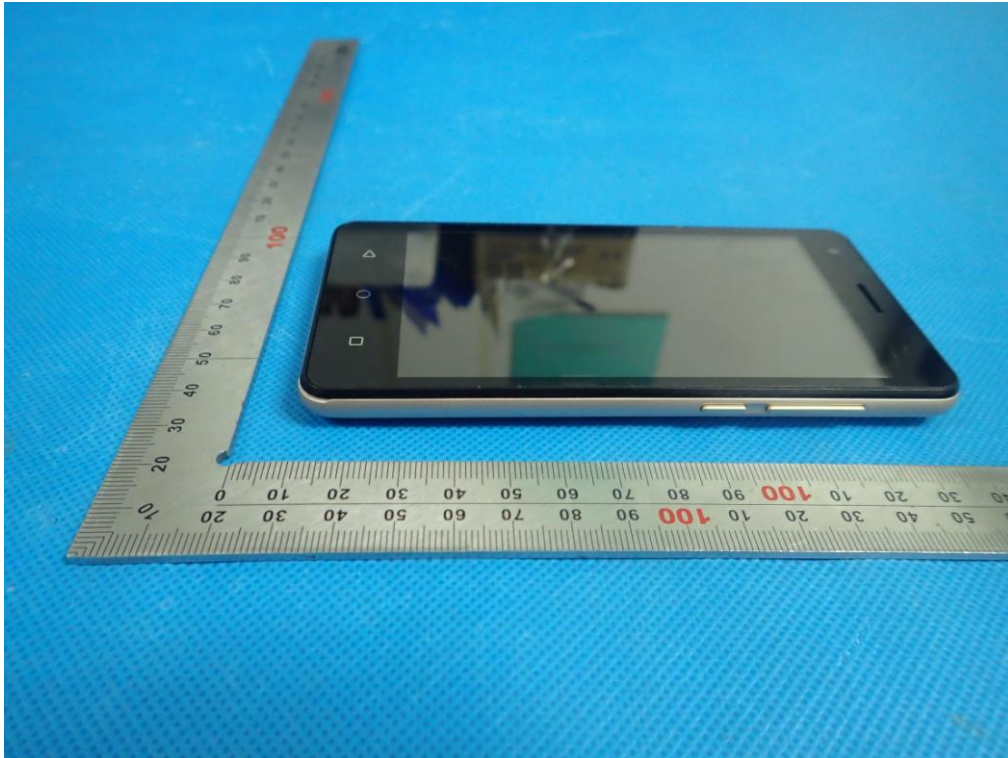

OPEN VIEW OF EUT-1



OPEN VIEW OF EUT-2



OPEN VIEW OF EUT-3

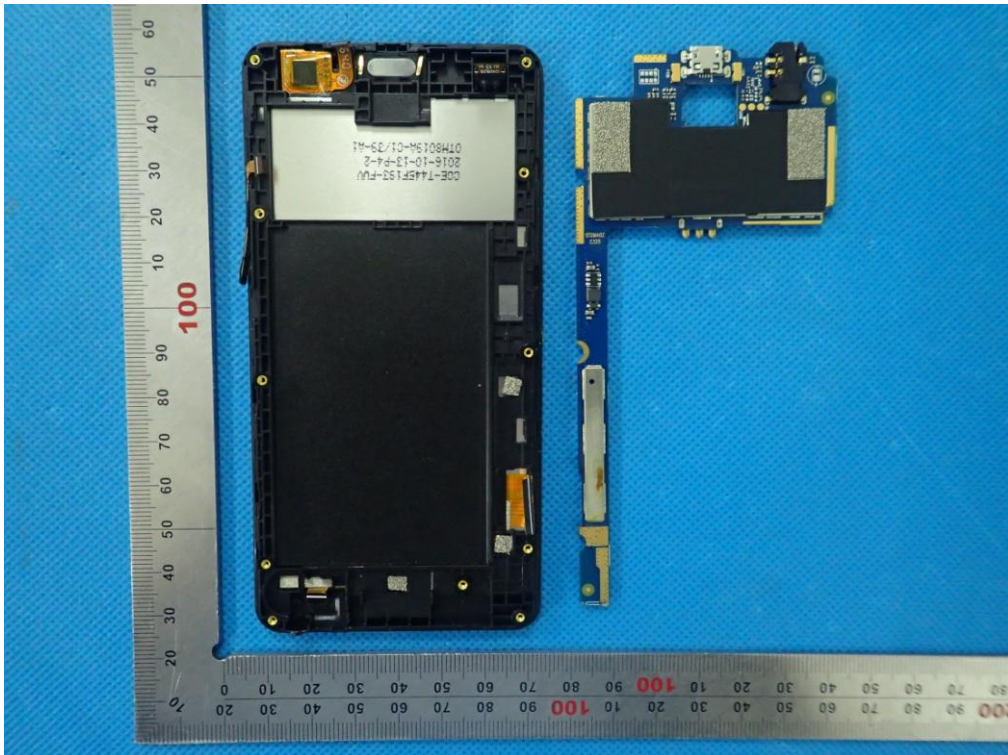

INTERNAL VIEW OF EUT-1

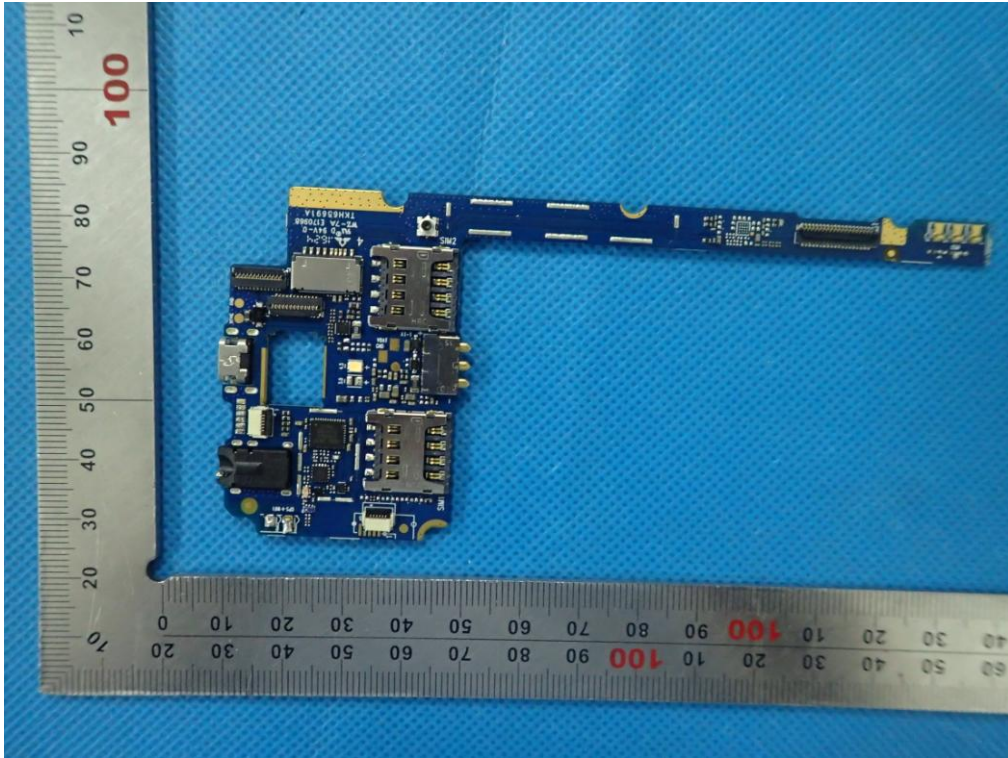

INTERNAL VIEW OF EUT-2

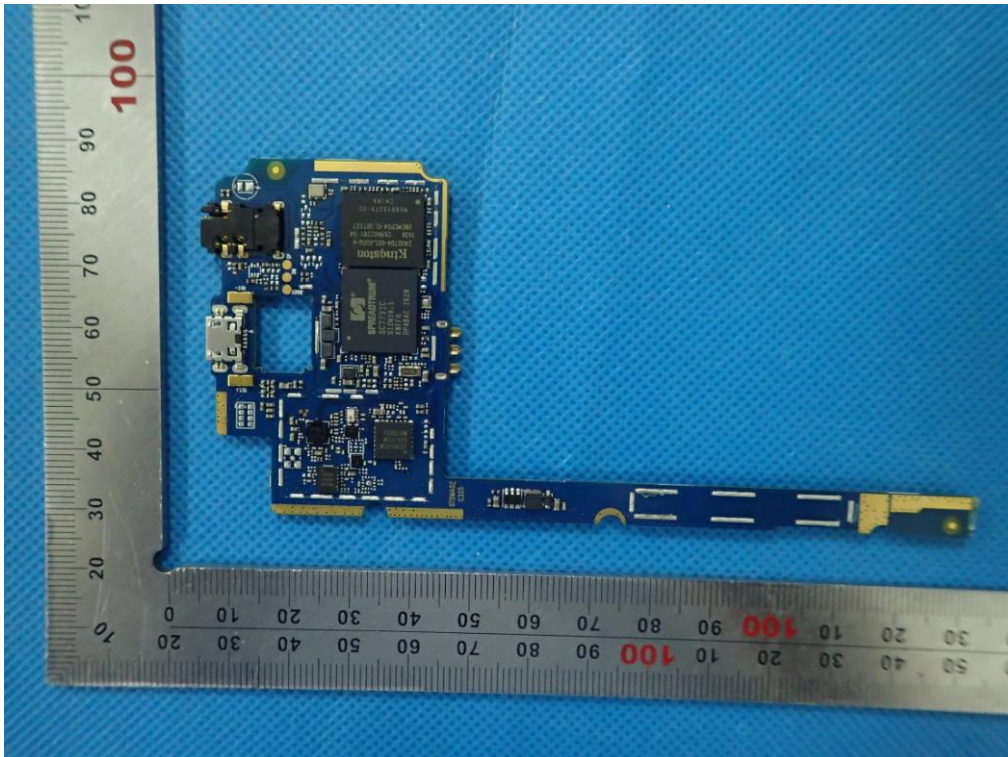

-----END OF REPORT-----