

I. Product Overview

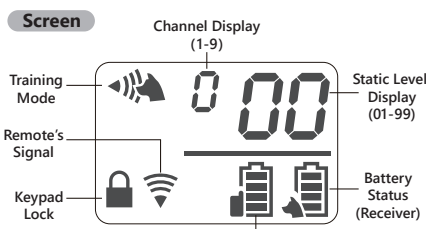

II. Package Content

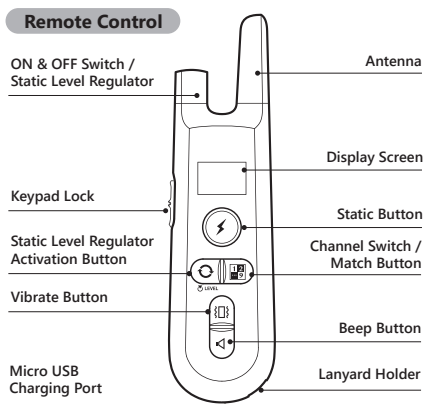
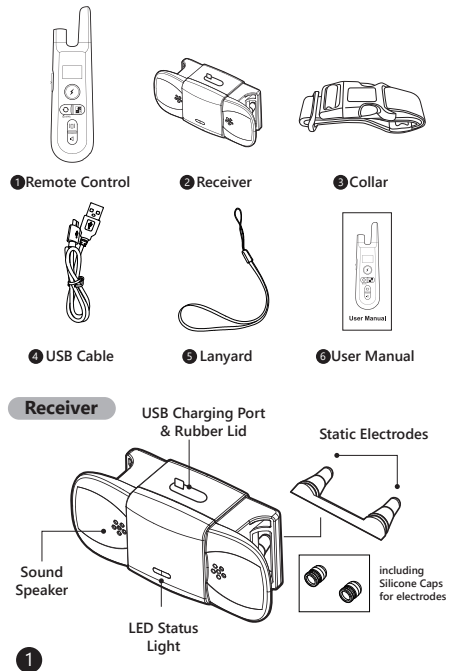

III. Setting Up

1. Charge the devices respectively for 2 hours and above.

Remote Control: Charge the device until the battery icon on the display indicates full bars.

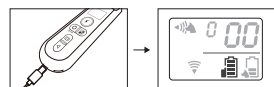

Receiver: Charge the device until the red LED turns green. The display on the Remote will indicate full bars as well.

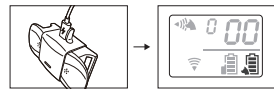

2. Match the Remote Control to the Receiver: *You may skip this step because the set is already paired by factory setting.

2.1. Connect the Receiver to a power source via the USB cable, matching mode can only be activated during charging.

2.2. Press and hold Channel Switch / Match Button for 5 secs. The Receiver will vibrate and beep which indicates the matching is complete. You will see "1" (or subsequent number) in the Channel Display if matching is successful.



Adding multiple Receivers:

2.3. Connect your additional Receiver to a power source. Press and hold **Channel Switch / Match Button for 5 secs** (repeat steps 2.1 and 2.2). The Channel Display will show the subsequent number of the new Receiver. **Note:** Connect only 1 Receiver at a time, do not connect all simultaneously, or the Remote will match all Receivers into a single channel.



3. Removing all Matched Receivers:

Press and hold **Static Level Regulator Activation Button and Beep Button** simultaneously for **8 secs**. The Channel Display

will default to "0". **Note:** Make sure all Receivers you want to remove have power and in the effective range, so that Receivers could receive the remove command.

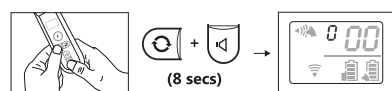

4. Configuring Static Levels:

Press and hold **Static Level Regulator Activation Button** and simultaneously slowly rotate **Static Level Regulator** until the digit on the screen reaches a suitable strength.

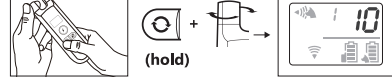

Recommended Static Level strength starts from "10". This is the minimum sensation your dog can feel. The right static level goes down to individual basis which you should find out from your dog's responses. The sensitivity to static depends on your dog's size and weight, amount of fur, and even

IV. Training Modes

1. Vibration Mode:

Press **Vibrate Button**, and the Receiver will vibrate once; hold the button and the vibration persists.



2. Sound Mode:

Press **Beep Button**, and the Receiver will give a "beep" sound; hold the button and the "beep" sound persists.



3. Static Stimulation Mode:

Press the **Static Button**, and the Receiver will give a Static Stimulation to the wearer.



Do not hold the button as it is not recommended to have prolonged shock to your dog. The static, however, will **cut off in 4 secs** automatically to prevent unintentional harm to your pet.

4. Switching Channel:

Press the **Channel Switch Button** to choose which Receiver you want to control if you matched more than one Receiver.



V. Wearing the Receiver Collar

1. Thread the collar through the Receiver.

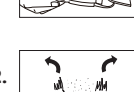

2. If your dog has thick fur, please **separate the fur** at the electrodes with a comb to enable them to reach the skin.



3. When wearing the collar, the tightness is at most fitting if **one finger** can be inserted underneath.

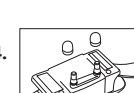

4. The **Silicone Caps** can dull the static sensation, you should decide if you need put them on. The soft caps also protect your dog from direct contact with metal electrodes, which in some cases will cause discomfort to some dogs.

VI. Training Tips

1. **Reward your dog with food** will usually help to achieve the best result.
2. Do not use the device on **dogs aged below 6-month**, old, pregnant, easily frightened, aggressive, in heat, old, and dogs not in best of health.
3. Use **verbal commands** first, and supplement with a corrective stimulus only as needed. Be consistent with your verbal commands, using the same words every time. Work with your pet on **one behavior at a time** to avoid confusion and frustration.
4. Use as little stimulus as possible and only to reinforce verbal commands when necessary. Do not over correct your dog.

5. For example, use the beeps as warning by pressing Beep Button. The dog will **become conditioned to the beep** preceding the corrective stimulus and will soon learn to recognize the beep as a warning along with your verbal command.
6. Do not rely on this product solely to train your dog. Some dogs will not respond to this product. We cannot guarantee the effectiveness of this or any trainer on your dog. If your dog shows signs of **growing, snarling, biting or aggression** while using the collar, discontinue use immediately and contact a professional trainer for advice.

VII. Important Notice

Regarding you and the product:

1. It is strictly prohibited to open the Receiver in any situation. Doing so will likely compromise the waterproof function and thus voiding the product warranty.
2. Please use Remote Control and Receivers from the complete set, do not use other product to match with the Receiver.
3. If you want to test the product, please use professional testing apparatus. **Do not test with hands**, so as to avoid accidental injury.
4. If find water at the charging port, please **wipe it dry before charging**.
5. Beware the interference from the environment can cause the product not to work properly. For examples are places with high voltage facilities, communication towers, thunderstorm, large buildings, and strong electromagnetic interference.
6. Both Remote and Receiver have automatic power-saving mode. They will enter **sleep mode if idling for 5 mins**.
7. The included collar is a basic accessory and is **not necessarily suitable** for all types of dog breeds. Any collar not wider than **24mm** and not thicker than **5mm**, made of soft material, can be a replacement for the current collar.

Regarding well-being of your dog:

1. The Receiver collar is not a regular collar and **not recommended to put on a leash** to walk your dog. (Doing so during pulling may hurt the dog due to protruding electrodes on the Receiver.)
2. Do not put the collar on for over **12 hours**, it may cause rashes or discomfort to your dog's skin.
3. **Do not allow children**, or anyone who has little to no experience with training dogs, to handle this training kit.

4. In order to guarantee normal diving function, please **insert the waterproof rubber lid** over the charging port.
5. Static stimulation is not a pleasant experience for any dogs. **Punishment is harsh** way to train a dog. Always praise and encourage your dog for good behavior. **Note:** With Anti-Misoperation design, Static function always cut-off after **4 secs**, this is a precaution designed to prevent unintentional long-pressed of the button, and potential animal abuse.

VIII. Troubleshooting

1. **Remote/Receiver runs out of power quickly; not charging**
Make sure the charger and Remote/Receiver is securely connected. Try to use other universal android USB cable to charge.
2. **Static is too weak or even completely no static; Static Mode has no effect on my dog.**
Make sure the receiver has enough power when it is low-battery, shock doesn't work; Only both electrodes are simultaneously touched by dog's skin shock will work; Try to increase the static level more than 45. If dog has long hair, you need to separate dog hair to make electrodes touched.
3. **Remote/Receiver does not response**
Recharge the Remote/Receiver, make sure they have enough power. Check the keypad lock (which is on the left side of Remote), unlock the Remote. If Remote is locked, there will be a lock icon on the display. If you try methods above but still fail, please remove all the matching and reconnect Remote with Receivers.
4. **Receiver is fully charged, but Remote Display still shows receiver has empty battery.**
Turn off Remote and turn on Remote again.
5. **Fail to match Receiver with Remote**
Make sure Receiver is connected to a power source (charging mode can only be activated while charging). Must hold Channel Switch more than 5 secs, if not, matching will fail. If you still fail after trying as above, contact us via support@dogcareglobal.com to confirm whether receiver and remote is of the different version, we will solve for you.
6. **Training mode fails to sync up even in a very short distance**
Make sure there is no strong signal interference in your surroundings. Remote's range could

X. Operating Environment & Maintenance

Do not use the product in the circumstances as follow:

1. Do not operate the devices under temperature of 104°F and above, doing so in such high temperature will decrease the performance of the batteries.
2. Do not use the Remote during snowing, this could lead to water sipping in causing damage to the controller.
3. Do not use the set in places with strong electromagnetic interference. This will greatly compromise the performance of the product.
4. Avoid dropping the devices on hard surface inflict excessive force on them.
5. Avoid using the devices in environment flooded with corrosive chemical, this may lead to color degrading, deforming, or cracking of exterior of the devices.

1. When not in use, please wipe clean both the Remote and Receiver with mild detergent. Turn off the Remote, lock the keypad, put on port, the rubber lid on the Receiver's charging and store the set in a cool dry place.

2. During cleaning, wipe with soft cloth and mild detergent. Do not use hard brushes which may scratch the surface of the device.

3. If the Receiver has gotten dirty, secure the charging port rubber lid secured and w

IX. Terms of Use and Limitation of Liability

1. Use of this product means you accept all the terms and conditions.
2. This product is a professional dog training device. You are not recommended to use this product if your dog is clever and less than 8 pounds in weight. If you're not sure whether the product is suitable for your pet dog, please consult a professional handler or contact us.
3. This product is a professional dog training device and should not be used for other purposes. Please do not violate local laws in using this product.

4. We bear no liability for any direct or indirect losses caused by use or misuse of this product; all risks in using this product shall be borne by user.
5. Please contact the dealer for parts warranty, goods return or exchange. We provide technical support only.
6. We reserve the right to change the terms, conditions and notices of this product are offered.

X. FCC Statement

This device complies with Part 15 of the FCC Rules. Operation is subject to the following two conditions:
(1) This device may not cause harmful interference, and (2) This device must accept any interference received, including interference that may cause undesired operation.

Warning: Changes or modifications not expressly approved by the party responsible for compliance could void the user's authority to operate the equipment.

Note: This equipment has been tested and found to comply with the limits for a Class B digital device, pursuant to Part 15 of the FCC Rules. These limits are designed to provide reasonable protection against harmful interference in a residential installation. This equipment generates uses and can radiate radio frequency energy and, if not installed and used in accordance with the instructions, may cause harmful interference to radio communications. However, there is no guarantee that interference will not occur in a particular installation. If this equipment does cause harmful interference to radio or television reception, which can be determined by turning the equipment off and on, the user is encouraged to try to correct the interference by one or more of the following measures:

1. Reorient or relocate the receiving antenna.
2. Increase the separation between the equipment and receiver.
3. Connect the equipment into an outlet on a circuit different from that to which the receiver is connected.
4. Consult the dealer or an experienced radio/TV technician for help.

XII. Product Specification

Model	TC01-C1
Package Dimension	8.6" x 3"x3"
Collar's Dimension	27.6" x0.95"
Receiver's Casing	IP65 waterproof; Rain resistant; Swimming approved
Remote's Casing	Non-waterproof; Keep away from water
Remote / Receiver's Battery	450mAh
Charging Voltage	DC 5V/300mA
Remote / Receiver Charging Time	Full Charge at 2-3 hrs
Charging Port	Micro USB
Operating Environment	32°F-104°F, <95% Rh
Remote / Receiver Standby Time	Remote: 60 days; Receiver: 40 days
Remote to Receiver's Signal Range Distance	656 Ft
Receiver's Battery Sync Distance	164 Ft

DOG TRAINING COLLAR

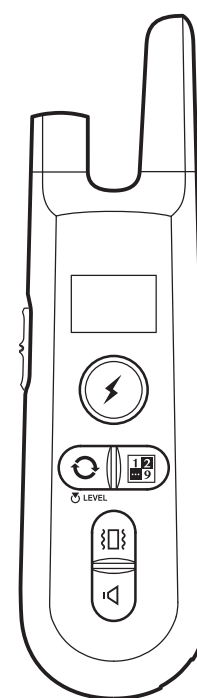

If any quality problems or confusion, feel free to contact us
support@dogcareglobal.com

User Manual

Model: TC01-C1

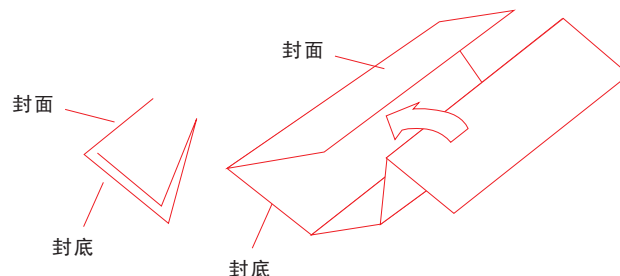

尺寸: 325*200mm