

# LUMARY SMART GIMBAL RECESSED LIGHT START GUIDE



Lumary

## What's in the Box

---



- LUMARY SMART GIMBAL RECESSED LIGHT

## Get Ready

---

- Know your Wi-Fi network and password
- Make sure your mobile device is running iOS 13.3 or higher and Android 9.0 or higher
- Make sure you're connecting to a 2.4GHz Wi-Fi network (Lumary can't connect to 5GHz networks)

## Attention

1. Do handle carefully in transportation.
2. Do not disassemble the fixture for non-professional.
3. The fixture work under AC high voltage and current, it should be installed where can't be touched easily. The connection must be completely sealed and be earthed.
4. the external flexible cable or cord of this luminaire cannot be replaced; if the cord is damaged, the luminaire shall be destroyed.
5. The light source contained in this luminaire shall only be replaced by the manufacturer or his service agent or a similarly qualified person.
6. The surface where it's positioned must be firm enough to ensure safety
7. Ensure the voltage of the electricity system is in the range of working voltage for the fixture. Otherwise, lifetime of fixtures will be influenced.
8. Installation and maintenance should be operated by a professional.

# Installation diagram

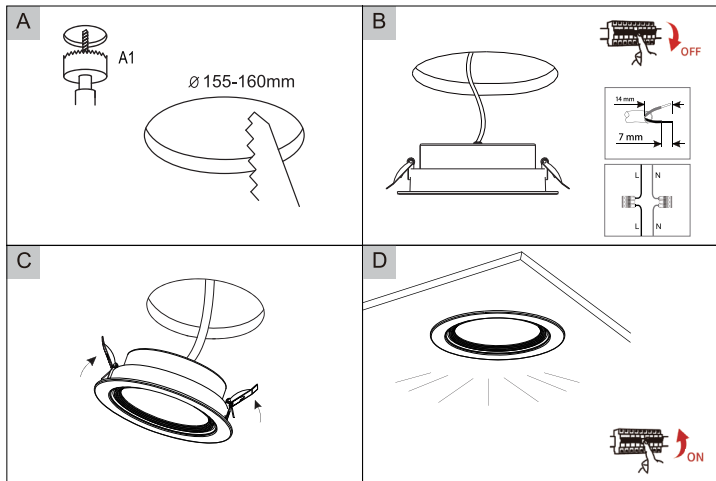

# 1 Download the Lumary App

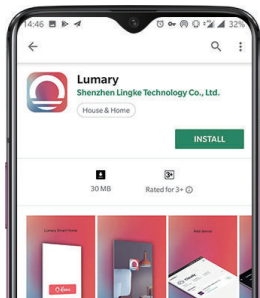
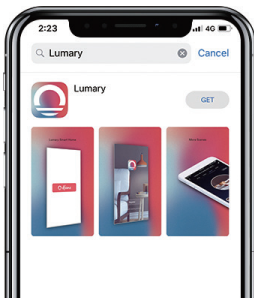

# 2 Register a Lumary account

<

## Register

United Kingdom +44 >

---

eric@lumary.tech

---

Get Verification Code

Enter your mobile phone number or email address.

<

## Log In

United Kingdom +44 >

---

eric@lumary.tech

---

.....

---

Log In

[Login with SMS](#) [Forgot Password](#)

Log into the App.

**Note: Please select your region and country.**

# 3 Connect: Easy Mode

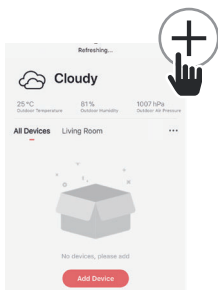

STEP 1

Open the Lumary App. In the top corner of the Devices screen, click (+).



STEP 2

Choose "Light Source(BLE+Wi-Fi)". Select upper right corner "EZ Mode"

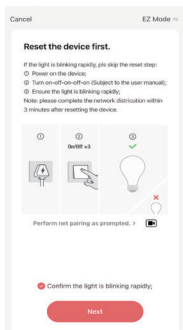

STEP 3

Make sure light is rapidly flashing white.  
If not, reset to reach Easy Mode to connect.  
Press "Next" in the App.

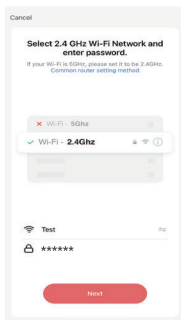

STEP 4

Enter your Wi-Fi network and password.

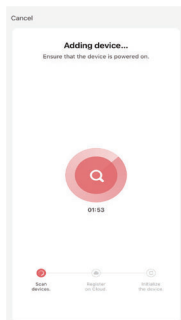

STEP 5

The Lumary App will connect to your devices.

**NOTE: Lumary can't connect to 5GHz networks.  
\*If the connection fails, try to connect using AP Mode.**

# 4 Connect: AP Mode

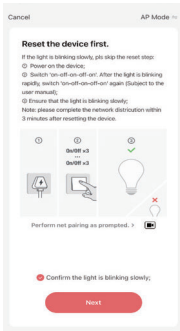

## STEP 1

Open the Lumary App. In the top corner of the Devices screen, click (+). Choose "Light Source(BLE+Wi-Fi)". Select upper right corner "AP Mode"

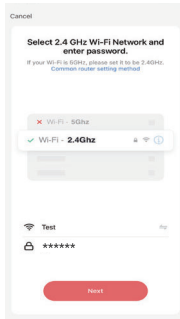

## STEP 2

Make sure light is slowly flashing white. If not, reset to reach AP mode.

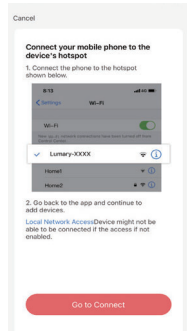

## STEP 3

Press "Next" and enter your Wi-Fi details.

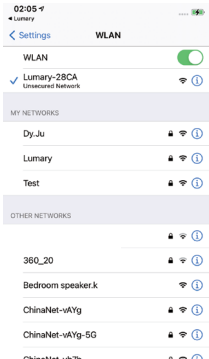

## STEP 4

Follow the instructions to choose the device from your Wi-Fi list.

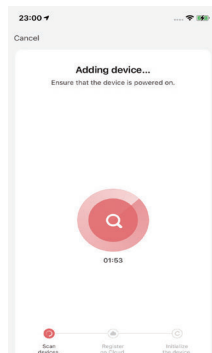

## STEP 5

The Lumary App will connect to your devices .

**NOTE: Lumary can't connect to 5GHz networks.  
\*If the connection fails, try to connect using AP Mode.**

# 5 Connect: Bluetooth

## STEP 1

Open the Lumary App. In the top corner of the Devices screen, click (+). Choose "Light Source(BLE+Wi-Fi)". Select upper right corner "Bluetooth"

## STEP 2

Make sure light is rapidly flashing white. If not, reset to reach Easy Mode to connect. Press "Next" in the App.

## STEP 3

Enter your Wi-Fi network and password.

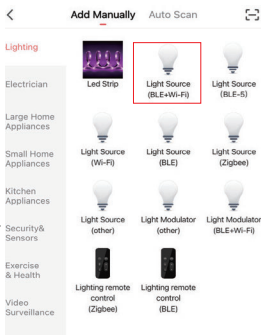

Please follow the application guidelines for the next steps.  
If you have any questions, please contact us in time.

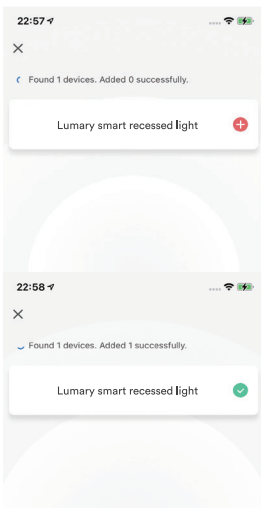
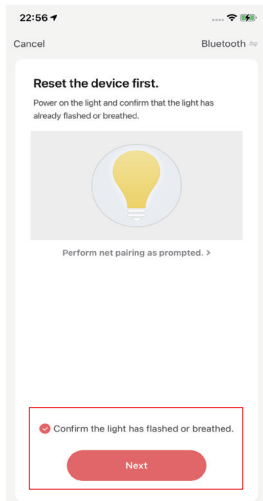

# Frequently Asked Questions

## 1. Can I share with family and friends?

Yes, you can share access to your Switch and any other Lumary device. In the Lumary App, press the "Profile" button and click on "Device Sharing" to give or revoke sharing permissions. In order to share, the other user should already have downloaded the Lumary App and registered an account.

## 2. Can I group multiple Lumary devices together?

Yes, you can group multiple same-type devices by room, location, or however else you want. The same devices can be in multiple groups. For example, if you create a group for "Bedroom" and another group for "Entire House", your Bedroom lights can be included in both groups. From your main device list, click on one of the devices you want to group, press the "⋮" button on the top right for advanced settings, and click "Create Group". You'll be able to name a new group and choose which devices you'd like to group together.

## 3. How many devices can I control?

Lumary App can control an unlimited amount of devices in an unlimited amount of locations. Your router may have a limit of how many devices can be connected to one router.

## 4. My Lumary device has a funny name. How do I rename it?

From your main device list, click on one of the devices you want to rename, press the "⋮" button on the top right for advanced settings, and click "Modify Device Name" (or "Modify Group Name"). You'll then be able to choose a more familiar name.

## 5. What should I do if the device Appears offline or is unreachable?

Make sure your Wi-Fi router is online and in range, and check that you have the latest Lumary functionality by clicking "Check for firmware update" in your device settings. If power is connected but the switch is not responding, hold down the Restart button to cycle the fuse and give the switch a jump start.

## 6. What's the wireless range?

The range of your home Wi-Fi is heavily dependent on your home router and the conditions of the room. Check with your router specifications for exact range data.

## 7. If my Wi-Fi internet goes down, will Lumary App still work?

Lumary products need to be connected to Wi-Fi in order to use them remotely.

## 8. What does the white light mean?

The white light indicates power. If the white light is on, the switch is receiving power; if it is off, it is not receiving power. The white light also indicates connection. If it is solid, the switch is connected; if it is flashing quickly, the switch is ready to connect using the Easy Mode; if it is flashing slowly, the switch is ready to connect using the AP Mode.

## 9. What should I do,when I find a problem with the purchased product?

Please email us ([cs@inlinterk.com](mailto:cs@inlinterk.com)) with your Amazon order ID. We are dedicated to ensuring your 100% satisfaction. Rest assured if the problem is with this product, we'll be more than happy to exchange it for a new one immediately.



# Important Information

## Troubleshooting

---

Cannot connect to your Wi-Fi network.

Make sure you entered the correct Wi-Fi password during the Wi-Fi setup. Check whether there are any Internet connection problems.

If the Wi-Fi signal is too weak, reset your Wi-Fi router and try again.

## Reset the device

---

To reconnect to Wi-Fi, Reset the device through the wall switch, on-off-on-off-on.

- Reset once (press switch on-off-on-off-on) to reach Easy Mode, indicated by rapidly blinking white light. Refer to connect in Easy Mode.
- Reset again (press switch on-off-on-off-on) to reach AP Mode, indicated by slowly blinking white light. Refer to connect in AP Mode.

## Technical Specifications

---

Category	Lumary smart gimbal recessed light
Model	US-GL6A-1/2/4
Size	Ø170*53.5MM
Wattage	13W
Luminous flux	1100 lm
Beam angle	100°
Color temperature	2700~6500K RGB
Input Voltage	100-130VAC
Color rendering index	≥90
Working Temperature	-20 ~ +40°C
Operating life	25000H

- Wi-Fi: IEEE 802.11N, 2.4GHz (not compatible with 5GHz Wi-Fi networks)

Made in China

### Support:

If you encounter any issues, please contact us at:

[cs@inlinter.com](mailto:cs@inlinter.com)

[support@lumary.tech](mailto:support@lumary.tech)

# VOICE CONTROL GUIDE

Name and Control Each Device by Voice



Thank you for purchasing your Lumary smart home product. Make sure your devices are already set up using the Lumary App, then follow these steps.

# Voice Control Quick Guide for Google Assistant



To control your Lumary smart switch or surge protectors, just say “OK Google”, and ask.

Make sure your devices are already set up using the Lumary app.

## Google Assistant

Things you can say\* :

“Hey Google, turn on all the lights in my bedroom.”

“Hey Google, turn off the light.”

“Hey Google, set the bedroom light to orange.”

“Hey Google, turn off the coffee machine.”

“Hey Google, set the living room to 50%.”

“Hey Google, dim porch light.”

\*Some commands require compatible devices.

- 1 Open the Google Home App and go to Home Control in the menu.

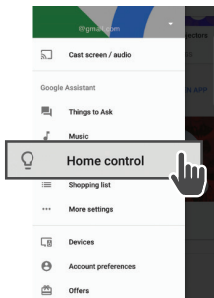

- 2 Tap the “+” button

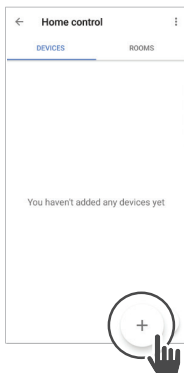

- 3 Choose “Lumary” in the list of Home Control partners.

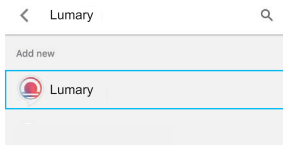

- 4 Authorize your account with Google Assistant using the username and password from your Lumary app.

Now your Google Home app and Lumary devices are linked!

You're now able to say “OK Google” and control your Lumary devices.

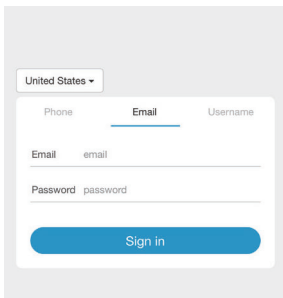

**Note: Please select your region and country.**

At any time, go into the “Home Control” section of the Google Home app to set nicknames and rooms for your devices.

You can rename your devices in the Lumary app, and Google Assistant will refer to them by the same name.

So if you rename a smart bulb to “Living Room” or a nickname like “Blossom”, then Google Assistant will use that same name later on. You can always give it a nickname using the Google Home app as well.

You can also assign switch to a specific room, like “Bedroom” or “Kitchen”.

Google Assistant will be able to control devices by room.

# Amazon Alexa



To control your Lumary smart switch or surge protectors, just ask Alexa.

Make sure your devices are already set up using the Lumary app.

Things you can say\* :

“Alexa, discover my devices.”

“Alexa, turn on the bedroom light.”

“Alexa, set the bedroom light to orange.”

“Alexa, turn off the coffee machine.”

“Alexa, set the living room to 50%.”

“Alexa, dim porch light.”

\*Some commands require compatible devices.

## There are 2 ways to enable "Lumary" Skill:

### Way 1:

1. Log in to Lumary App, click your smart device, click "🔗" in top right corner.
2. Click Alexa in Third-party Control.
3. Sign in with your Alexa account.

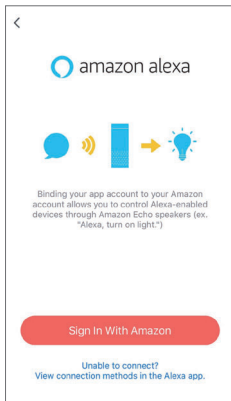
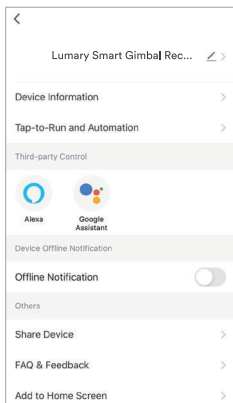

4. Click LINK.

5. Linked successfully, when add new device, it is no need to link again, just discover new device in Alexa.

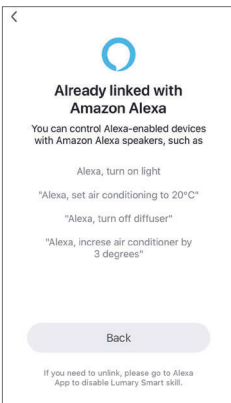
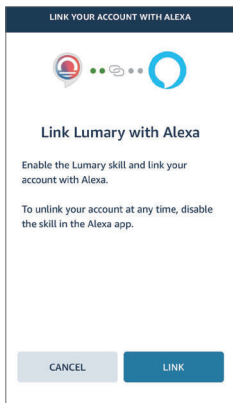

Way 2:

- 1 Open the Alexa App and go to Skills in the menu.

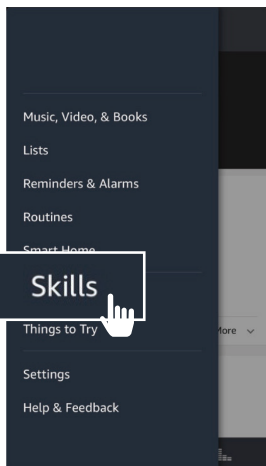

- 2 Search for Lumary then click Enable.

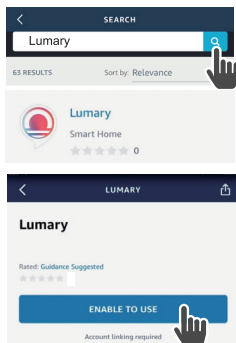

- 3 Authorize your account with Smart Home Skills using the username and password from your Lumary App.

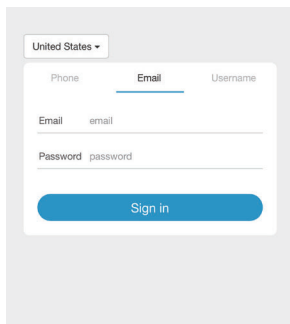

**Note: Please select your region and country.**



- 4 Choose “Discover Devices”. After a few seconds your Lumary devices will be displayed under Smart Home in the Alexa app.

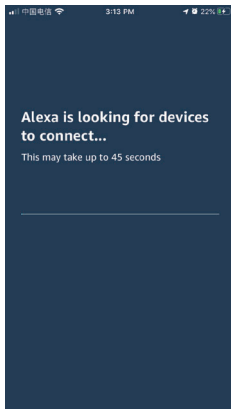
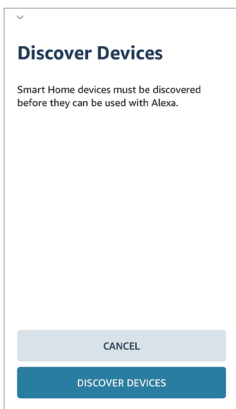

You can rename your devices in the Lumary app, and Alexa will refer to them by the same name.

So if you rename a smart switch to “Living Room” or a nickname like “Blossom”, then Alexa will use that same nickname later on.

Alternatively, you create an Alexa group, like “Bedroom” or “Downstairs”, and add the device to the group.

Alexa will recognize the group name in the Alexa app, or the device name in the Lumary app.

More information is available at:

<http://tinyurl.com/aexa-smart-home-groups>

If you have any questions about use and operation, you can contact us!

Customer Service Email:

support@lumary.tech

cs@inlintek.com

You can also search for our "account name" and "enter URL" on social media platforms or directly scan the following QR code to find us quickly.

- Facebook: US-Smart Home (<https://www.facebook.com/lumary.tech>)
- YouTube: Lumary Official (<https://www.youtube.com/channel/UCcEQnWxockzsPwyPOfSppug>)
- Instagram: lumary Smart Home (<https://www.instagram.com/lumarysmarthome/>)
- Twitter: Lumary @Lumarysmarthome (<https://twitter.com/Lumarysmarthome>)
- Pinterest: Lumary Smart Home (<https://www.pinterest.com/LumarySmartHome/>)



Facebook



Youtube



Instagram



Twitter



Pinterest

Can't connect? Need help?



HAVING AN EASY TALK TO US BEFORE YOU RETURN  
THE PRODUCT WILL FIX A PROBLEM MORE QUICKLY

Lumary support:  
support@lumary.tech

Visit us at: [www.lumary.tech](http://www.lumary.tech)

## **FCC Statement**

This equipment has been tested and found to comply with the limits for a Class B digital device, pursuant to part 15 of the FCC Rules. These limits are designed to provide reasonable protection against harmful interference in a residential installation. This equipment generates, uses and can radiate radio frequency energy and, if not installed and used in accordance with the instructions, may cause harmful interference to radio communications. However, there is no guarantee that interference will not occur in a particular installation. If this equipment does cause harmful interference to radio or television reception, which can be determined by turning the equipment off and on, the user is encouraged to try to correct the interference by one or more of the following measures:

- Reorient or relocate the receiving antenna.
- Increase the separation between the equipment and receiver.
- Connect the equipment into an outlet on a circuit different from that to which the receiver is connected.
- Consult the dealer or an experienced radio/TV technician for help.

Caution: Any changes or modifications to this device not explicitly approved by manufacturer could void your authority to operate this equipment.

This device complies with part 15 of the FCC Rules. Operation is subject to the following two conditions: (1) This device may not cause harmful interference, and (2) this device must accept any interference received, including interference that may cause undesired operation.

## **RF Exposure Information**

This equipment complies with FCC radiation exposure limits set forth for an uncontrolled environment. This equipment should be installed and operated with minimum distance 20cm between the radiator and your body.