

SMART Wi-Fi OUTLET START GUIDE



Lumary

Thank you for purchasing your Lumary smart home product. Ready to get started? Download the Lumary app to manage your CURRENT (and all other Lumary devices) straight from your phone or tablet. Easily connect to your home Wi-Fi and control multiple devices with the touch of your fingertips.

Contents

Download & Register	02-04
Install	05-08
Reset	09
Connect	10-15
FAQ, Troubleshooting, Notices	16-19
Voice Control Guide	20-37

WARNING: RISK OF ELECTRIC SHOCK OR FIRE. Please follow all safety instructions on page 17 before installing, servicing, or removing your CURRENT.

What's in the Box

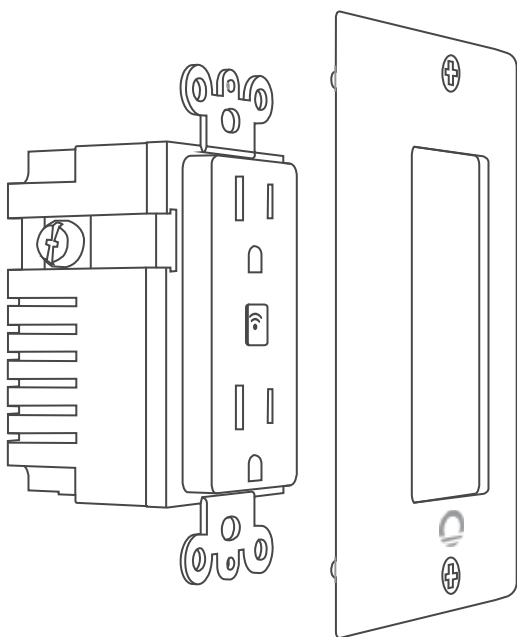

A

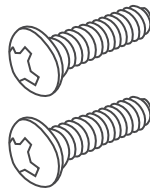

B

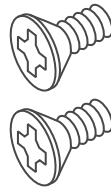

SMART Wi-Fi
OUTLET
START GUIDE

VOICE
CONTROL
GUIDE

- 1 x Smart Wi-Fi Outlet
- 1 x Face Plate
- 2 x Screws for Outlet
- 2 x Screws for Faceplate
- Start Guide
- Voice Control Guide

Get Ready

- Turn OFF AC Power at the circuit breaker or fuse. Use a noncontact voltage tester to ensure that power is off. More than one disconnect CURRENT may be required to turn off power.
- Use Copper Conductors Only.

1 Download the Lumary app

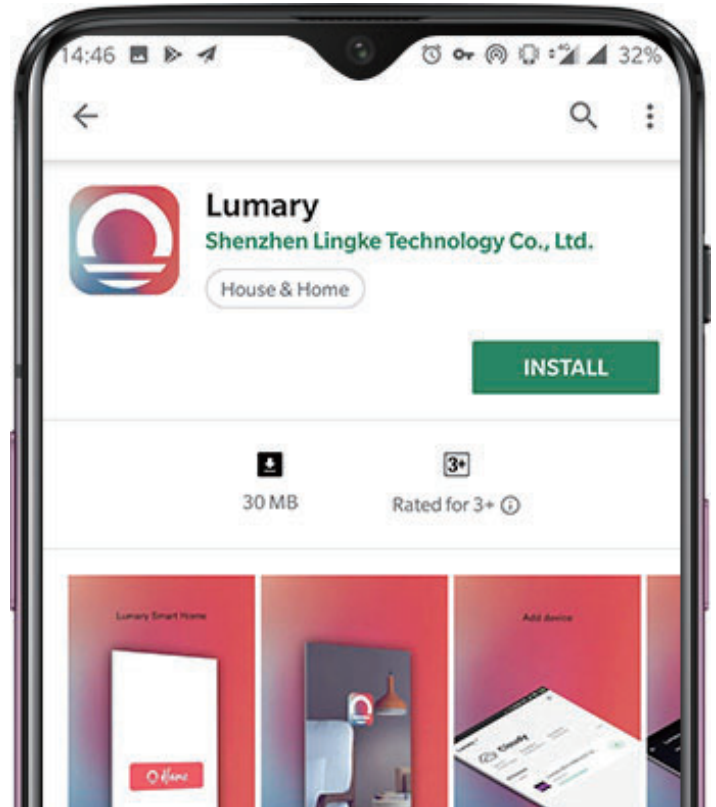
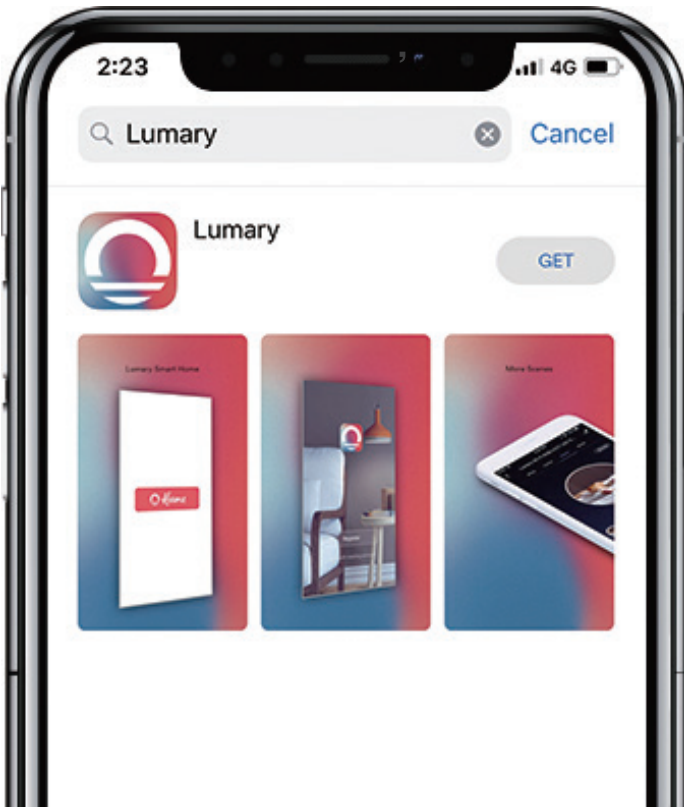

2 Register a Lumary account

<

Register

United States of America >

test@lumary.tech

Get Verification Code

I Agree [User Agreement](#) and [Privacy Policy](#)

STEP 1

Enter your email address.

<

Enter Verification Code

— — — — —

A verification code has been sent to your email
test@jbtled.com, Resend (55s)

STEP 2

Enter the verification code
and create a password.

Reset Password

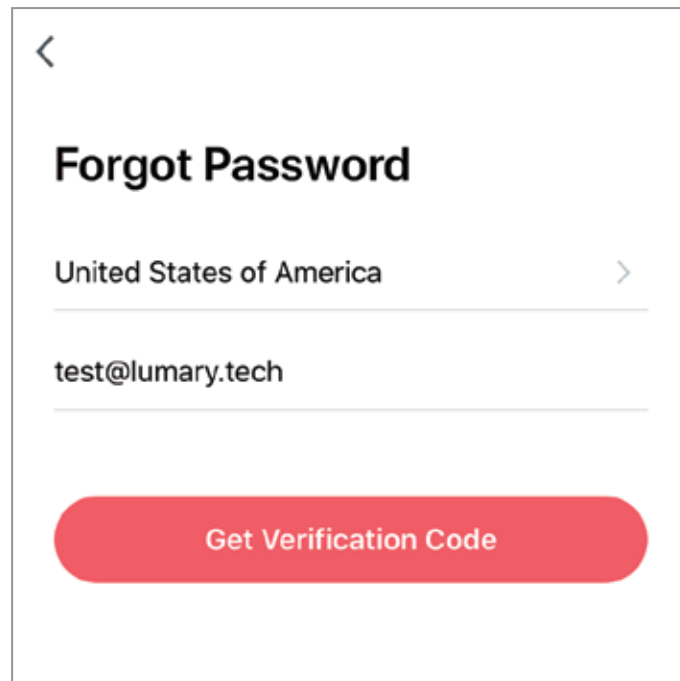

<

Forgot Password

United States of America >

test@lumary.tech

Get Verification Code

STEP 3

Follow the prompts to reset your password.

3 Install

STEP 1

Shut off power at the circuit breaker for the **CURRENT** that you are replacing. More than one disconnection may be required to turn off power. Use a noncontact voltage tester to ensure that power is off.

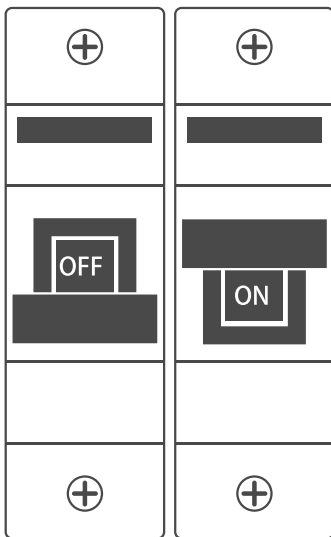

STEP 2

Remove old outlet by disconnecting all wires.

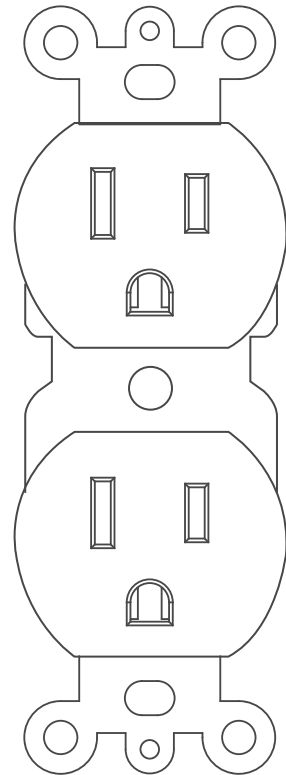

Disconnect all wires.

STEP 3

Connect CURRENT's neutral wire (white) to your home's neutral wire.

Connect CURRENT's line (Black), Neutral (White), and Ground (Green) wires as shown.

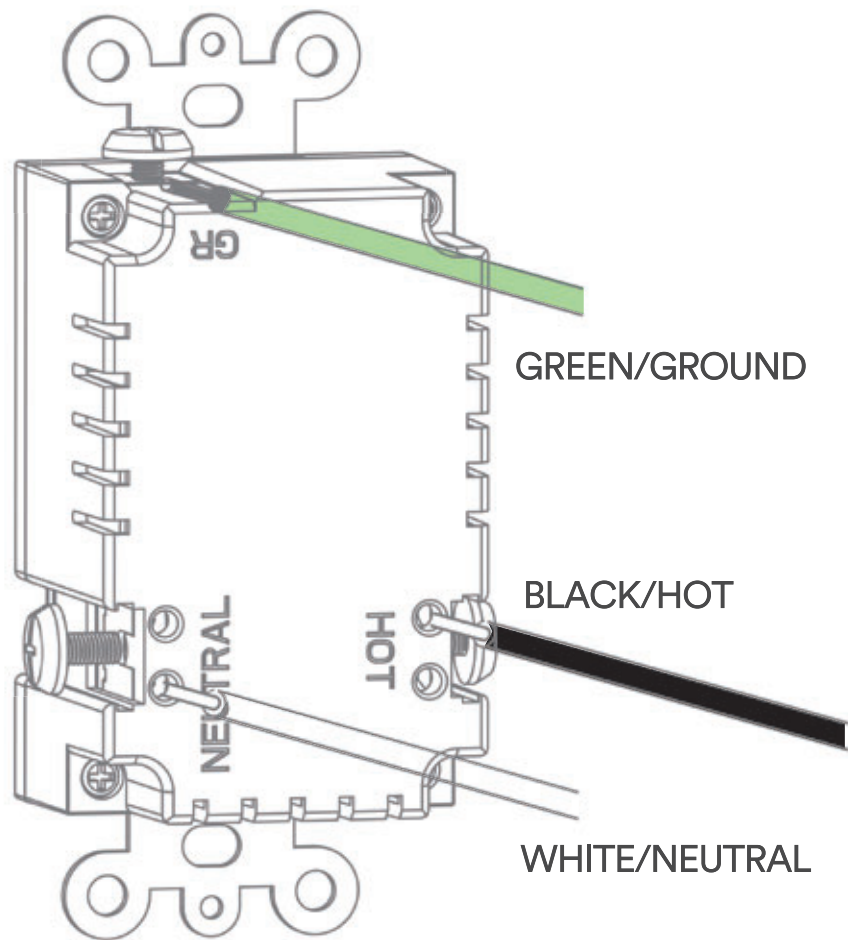
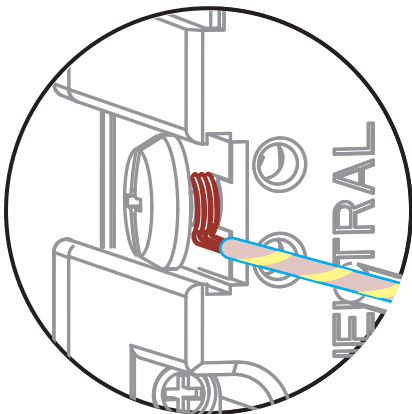

Place stripped wire into the hole and tighten down the screw.

STEP 4

- A** Use the two A screws to secure the CURRENT to the junction box.

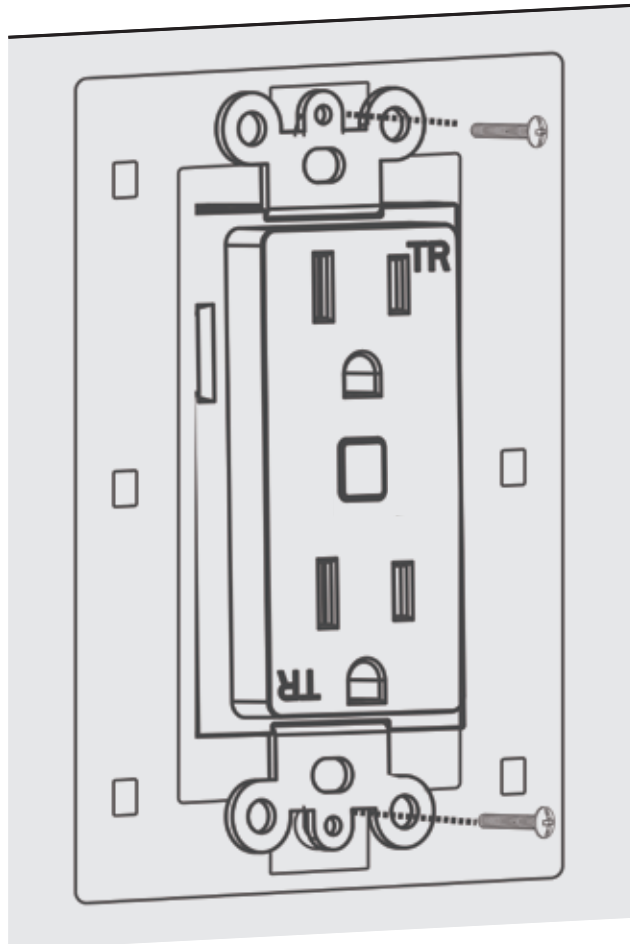

STEP 4

B

Use the two B screws provided to secure the faceplate bracket to the CURRENT.

STEP 5

Restore power by turning the breaker back on.

STEP 6

Once power is connected, the blue indicator light will blink to indicate that CURRENT is ready to connect to Wi-Fi.

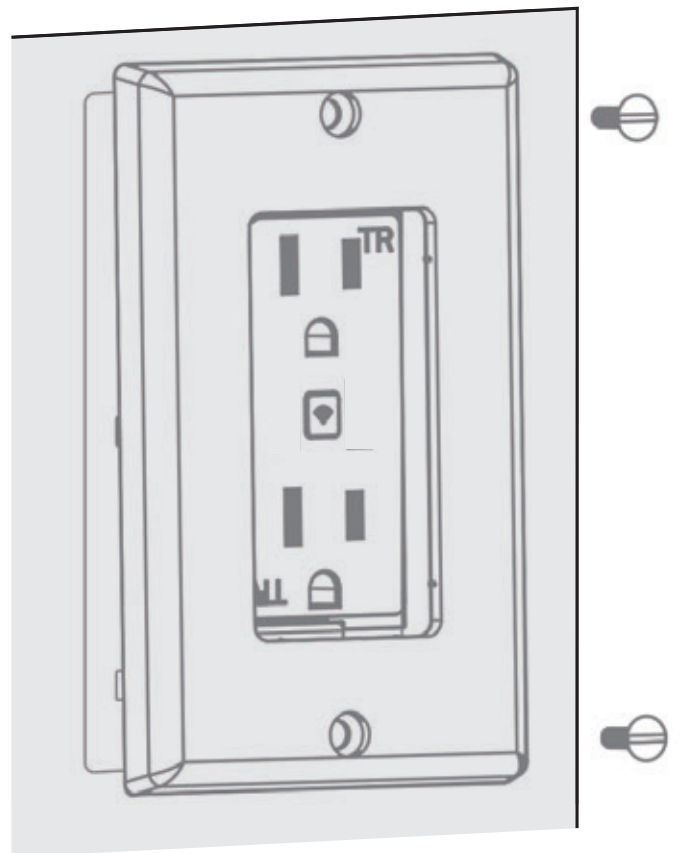

4 Reset and restart, cont.

How do I reset the device and what does the blinking light mean?

Reset CURRENT by pressing and holding the reset button for 5 seconds until the indicator light is flashing rapidly.

- Reset one time (press and hold) to reach Easy mode (Fast blinking blue, 2x per second)
- Reset again (press and hold) to reach AP Mode (Slow blinking blue, every 3 seconds)



Blinking fast: Ready for Easy Mode

Blinking slow: Ready for AP Mode

Solid: Device power on

5 Connect: Easy Mode

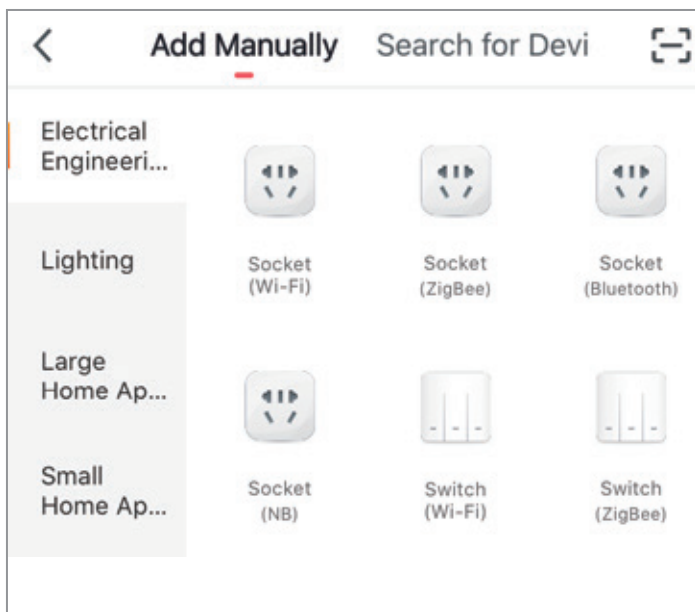

STEP 1

Open the Lumary app. In the top corner of the Devices screen, click (+).

Choose “Socket (Wi-Fi)”

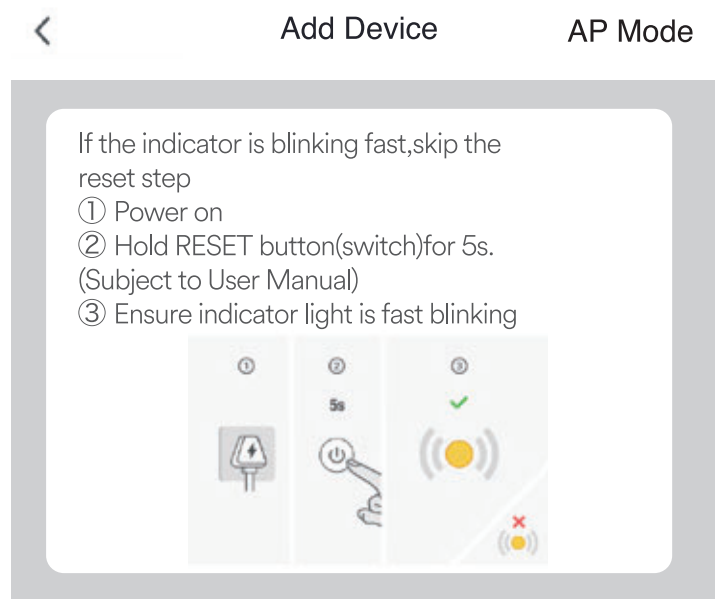

STEP 2

Make sure CURRENT’s light is rapidly flashing blue.

If not, reset to reach Easy Mode to connect (Page 9).

Press “Next Step” in the app.

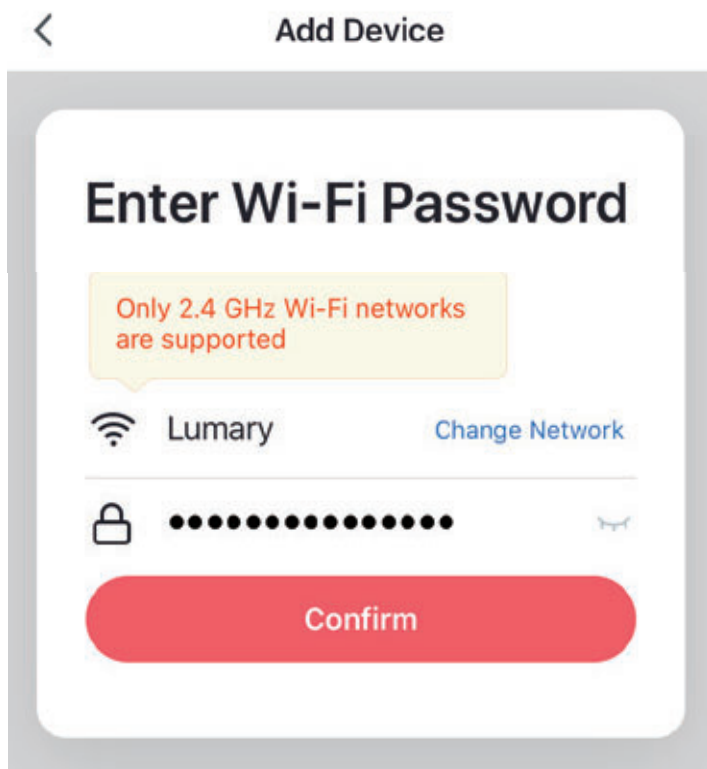

STEP 3

Enter your Wi-Fi network and password.

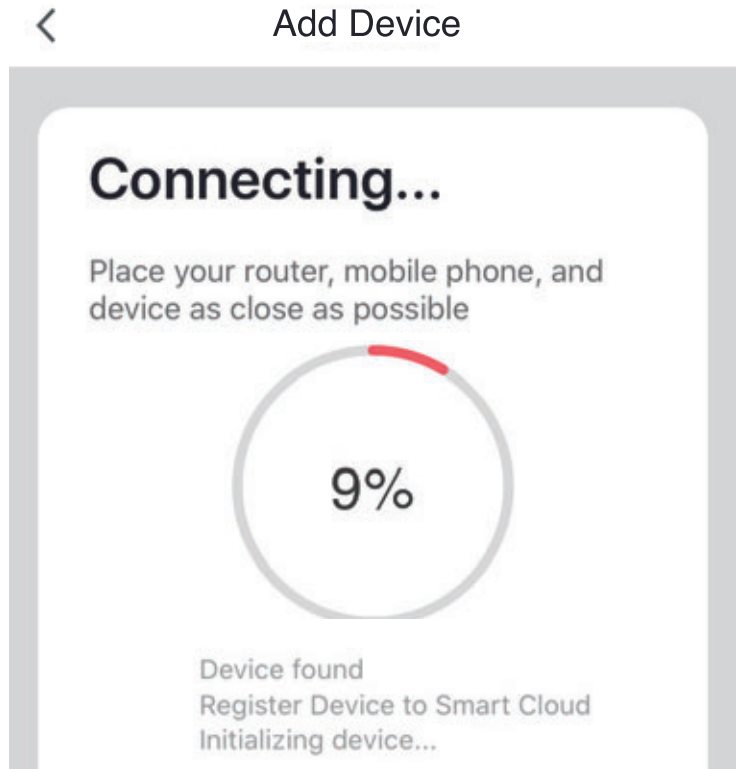

STEP 4

The Lumary app will connect to your CURRENT.

NOTE: Lumary can't connect to 5GHz networks.

***If the connection fails, try to connect using AP Mode.**

6 Connect: AP Mode

STEP 1

Make sure CURRENT's light is slowly flashing blue.
If not, reset to reach AP mode (page 9).

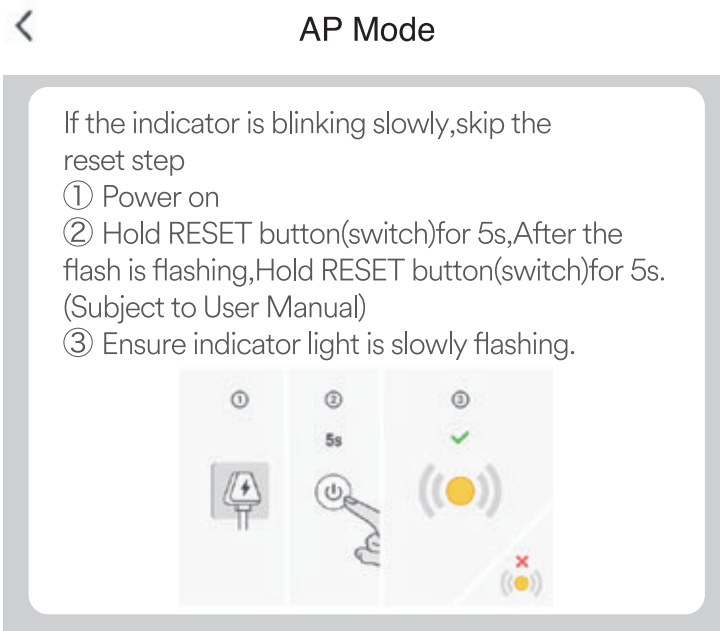

STEP 2

Open the Lumary app. In the top corner of the Devices screen, click (+).
Choose "Socket (Wi-Fi)".
Choose "AP Mode" in the top corner.

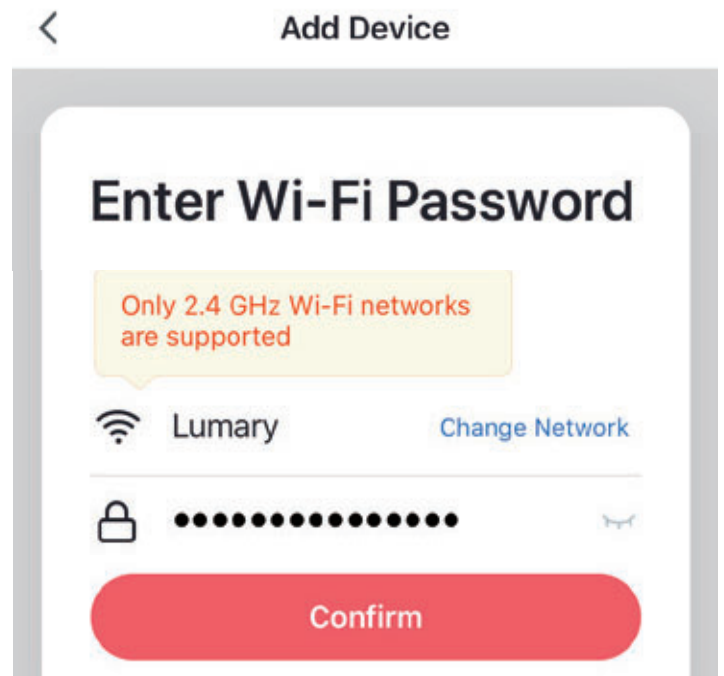

STEP 3

Press "Next" and enter your Wi-Fi details.

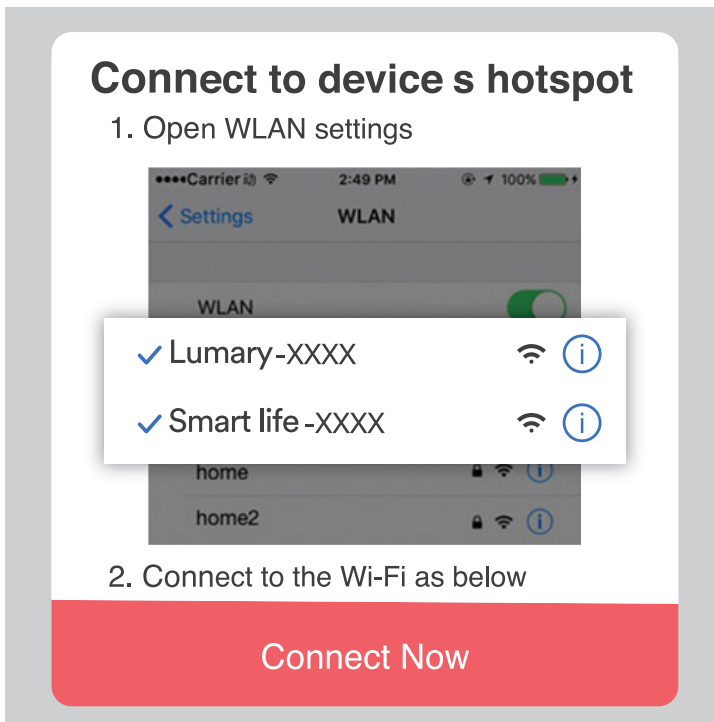

STEP 4

Follow the instructions to choose the device from your Wi-Fi list.

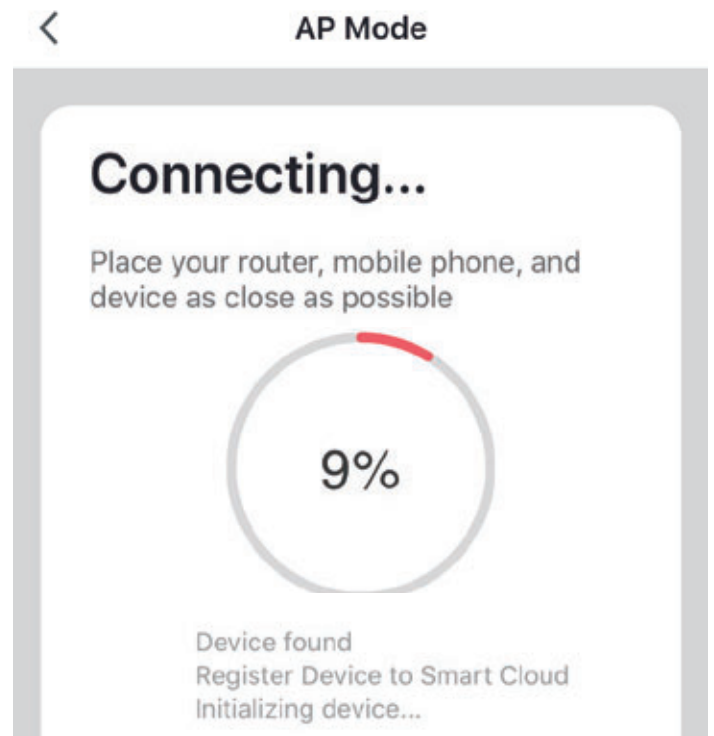

STEP 5

The Lumary app will connect to your CURRENT.

NOTE: Lumary can't connect to 5GHz networks.

7 Connect: Auto Scan

STEP 1

Connect your smart phone to a 2.4GHz Wi-Fi, open the Lumary app. In the top right corner of screen, click (+). Choose “Auto Scan”.

STEP 2

Power on the smart device, press and hold the reset button for 5 seconds until it is rapidly flashing blue.

STEP 3

Click “Start scan”, the app will search for device automatically. Wait 5-20s until the device appears on the screen. Click “Next”, customize the device name as needed, then click “Done” to complete connection.

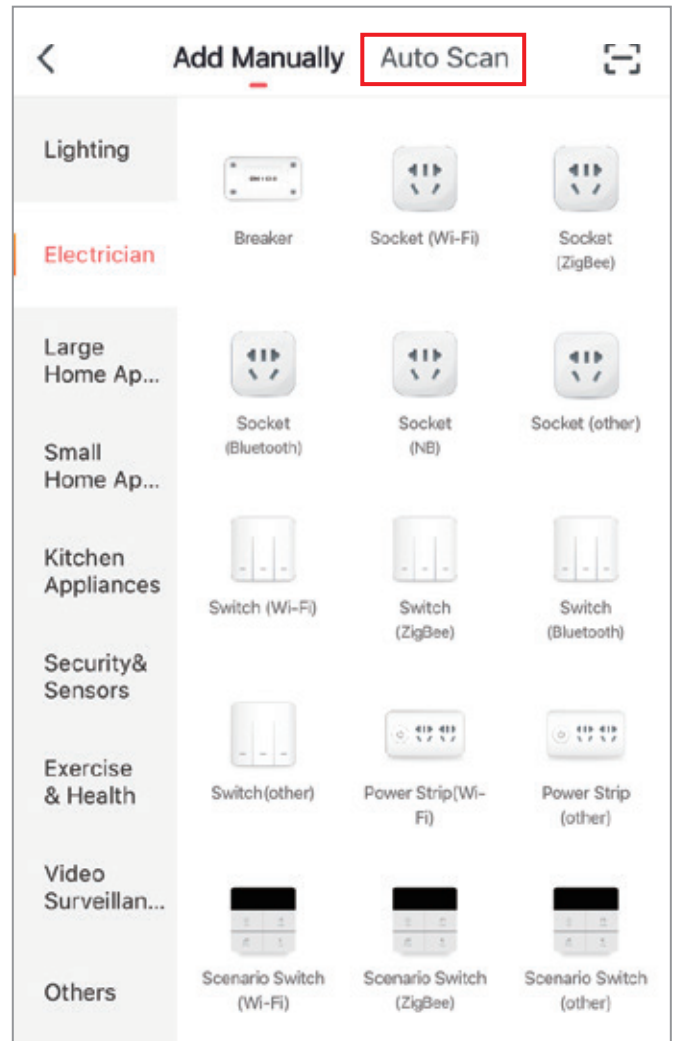

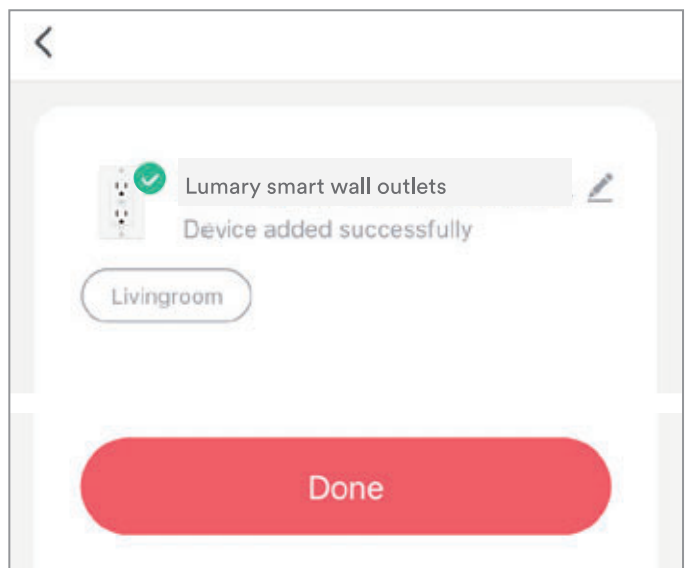
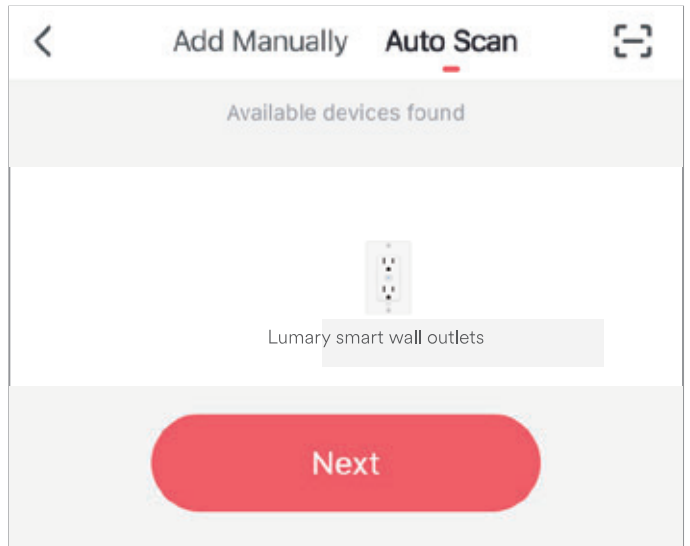
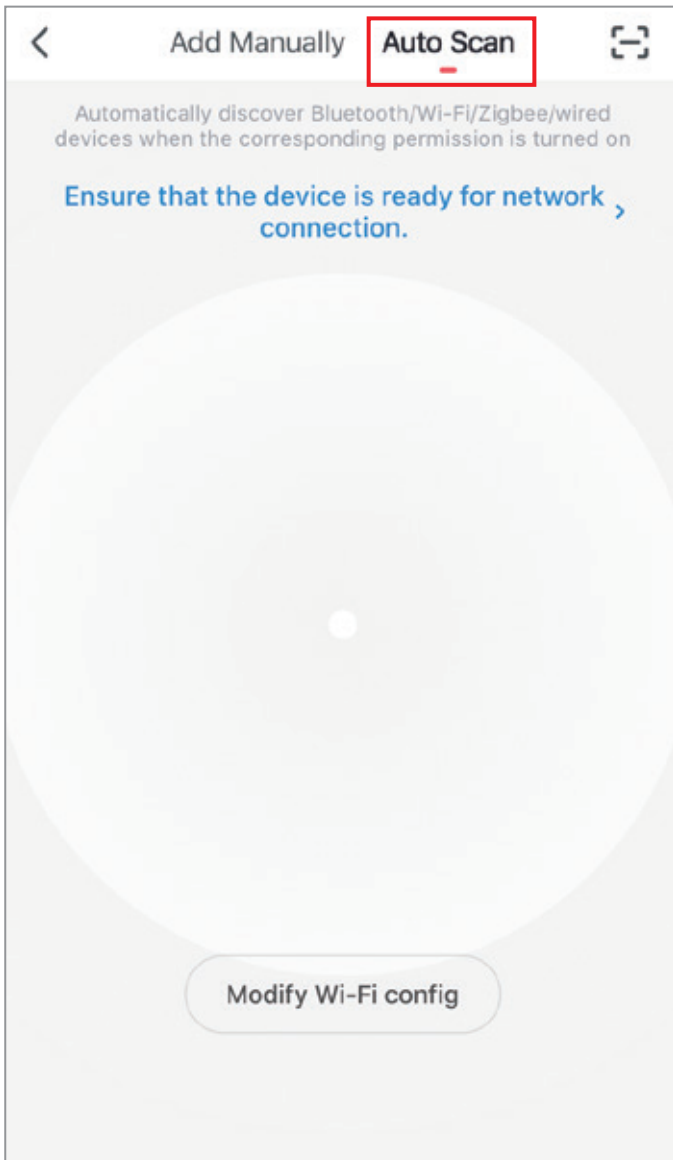

Frequently Asked Questions

1. Can I share with family and friends?

Yes, you can share access to your CURRENT and any other Lumary device. In the Lumary app, press the "Profile" button and click on "Device Sharing" to give or revoke sharing permissions. In order to share, the other user should already have downloaded the Lumary app and registered an account.

2. Can I group multiple Lumary devices together?

Yes, you can group multiple same-type devices by room, location, or however else you want. The same devices can be in multiple groups. For example, if you create a group for "Bedroom" and another group for "Entire House," your Bedroom lights can be included in both groups. From your main device list, click on one of the devices you want to group, press the "✎" button on the top right for advanced settings, and click "Create Group." You'll be able to name a new group and choose which devices you'd like to group together.

3. How many devices can I control?

Lumary app can control an unlimited amount of devices in an unlimited amount of locations. Your router may have a limit of how many devices can be connected to one router.

4. My Lumary device has a funny name. How do I rename it?

From your main device list, click on one of the devices you want to rename, press the "✎" button on the top right for advanced settings, and click "Modify Device Name" (or "Modify Group Name"). You'll then be able to choose a more familiar name.

5. What should I do if the device appears offline or is unreachable?

Make sure your Wi-Fi router is online and in range, and check that you have the latest Lumary functionality by clicking "Check for firmware update" in your device settings. If power is connected but the CURRENT is not responding, hold down the Restart button to cycle the fuse and give the CURRENT a jump start.

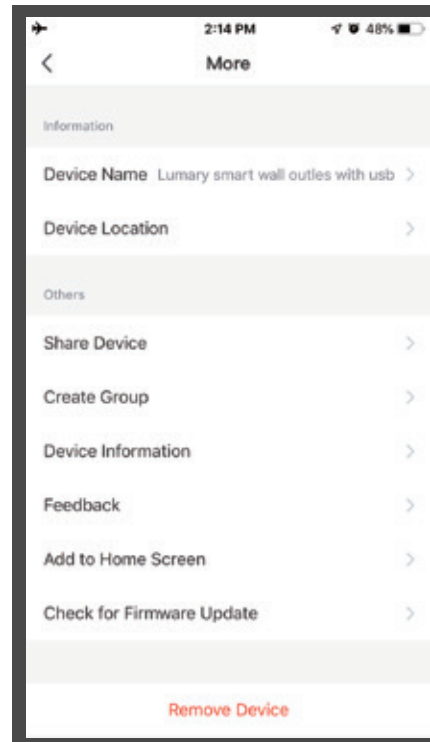
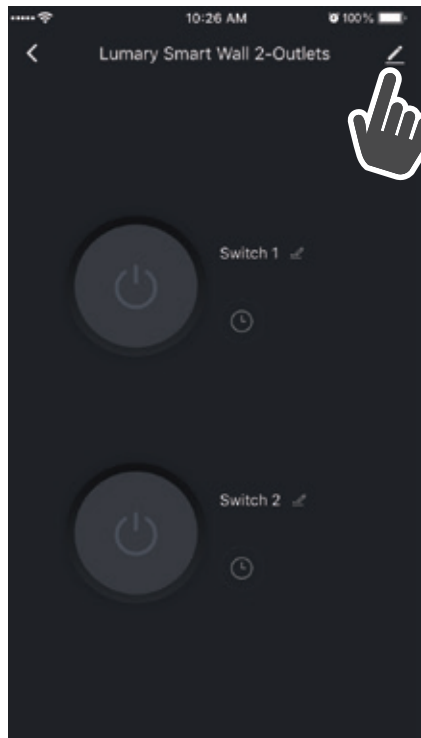

6. What's the wireless range?

The range of your home Wi-Fi is heavily dependent on your home router and the conditions of the room. Check with your router specifications for exact range data.

7. If my Wi-Fi/Internet goes down, will Lumary App still work?

Lumary products need to be connected to Wi-Fi in order to use them remotely.

8. What should I do,when I find a problem with the purchased product?

Please email us (cs@inlinter.com) with your Amazon order ID. We are dedicated to ensuring your 100% satisfaction. Rest assured if the problem is with this product, we'll be more than happy to exchange it for a new one immediately.

Troubleshooting

Can't connect to Wi-Fi? Make sure you entered the correct Wi-Fi password during the Wi-Fi setup.

Check whether there are any Internet connection problems. If the Wi-Fi signal is too weak, reset your Wi-Fi router and try again.

Reset the device

Reset CURRENT by pressing and holding the button for 5 seconds until the indicator light is flashing rapidly.

- Reset one time (press and hold) to reach Easy mode (Fast blinking blue, 2x per second).
- Reset again (press and hold) to reach AP Mode (Slow blinking blue, every 3 seconds).

System Requirements

- Mobile device running iOS®9.0 or higher or Android™ 4.4 or higher
- Existing 2.4GHz Wi-Fi network (not compatible with 5GHz Wi-Fi networks)
- Existing outlet box; the box should be more than 2 inches deep
- Lumary app

IMPORTANT: Please consult a licensed electrician if you are unfamiliar with electrical installations.

Technical Specifications

- Input: 100-130VAC, 60Hz
- Single Output: 15A Max. / outlet
- Total Output : 15A Max.

FCC Notice:

This device complies with Part 15 of the FCC Rules. Operation is subject to the two following conditions:

1. This device may not cause harmful interference.
2. This device must accept any interference received, including interference that may cause undesired operation.

Note: This equipment has been tested and found to comply with the limits for a Class B digital device, pursuant to Part 15 of the FCC Rules. These limits are designed to provide reasonable protection against harmful interference in a residential installation.

Important Information:

Before installing, read and follow all precautions, including the following:

CAUTION: RISK OF ELECTRIC SHOCK OR FIRE

TAP must be installed and used in accordance with the National Electric Code. Please consult a licensed electrician if you are uncomfortable or unfamiliar with electrical work.

Disconnect power before installing or modifying this product.

CAUTION: Suitable for indoor use only.

Support:

If you encounter any issues, please contact us at cs@inlinter.com for help.

To explore our full selection of products, visit us at: www.lumary.tech

Made in China

VOICE CONTROL GUIDE



Name and Control Each Device by Voice



Thank you for purchasing your Lumary smart home product.
Make sure your devices are already set up using the Lumary app,
then follow these steps.

Contents ---

Google Assistant 23 - 28
.....

Amazon Alexa 29 - 37
.....

Voice Control Quick Guide for Google Assistant



To control your Lumary smart switch, plugs,
or surge protectors,
just say “OK Google,” and ask.

Make sure your devices are already
set up using the Lumary app.

Google Assistant

Things you can say*:

Hey Google,turn on all the lights in my bedroom.”

Hey Google,turn off the light.”

Hey Google,set the bedroom light to orange.”

Hey Google,turn off the coffee machine.”

Hey Google,set the living room to 50%.”

“Hey Google,dim porch light.”

*Some commands require compatible devices.

1 Open the Google Home App and go to Home Control in the menu.

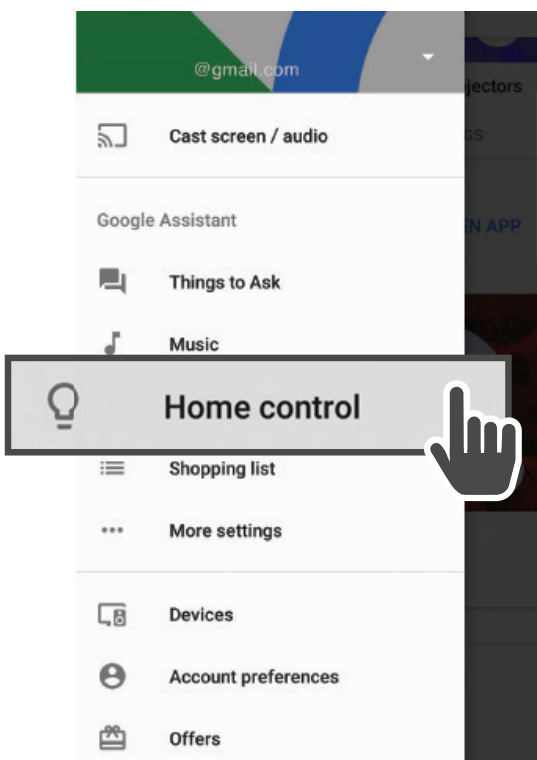

2 Tap the "+" button

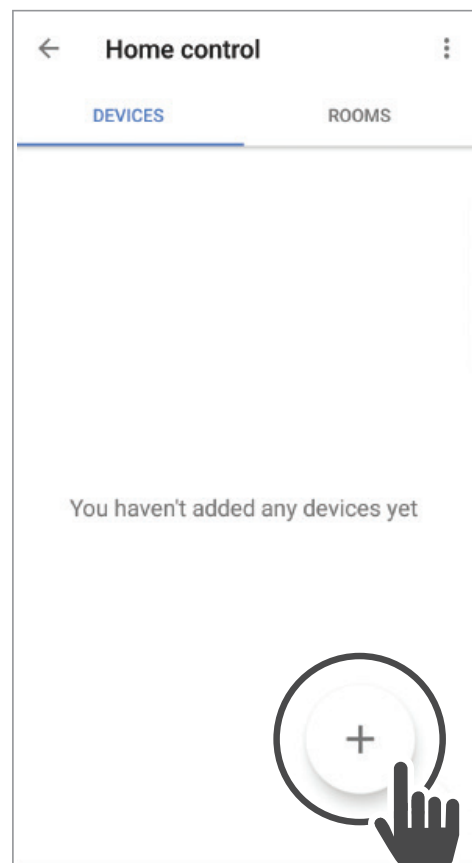

3

Choose “Lumary” in the list of Home Control partners.

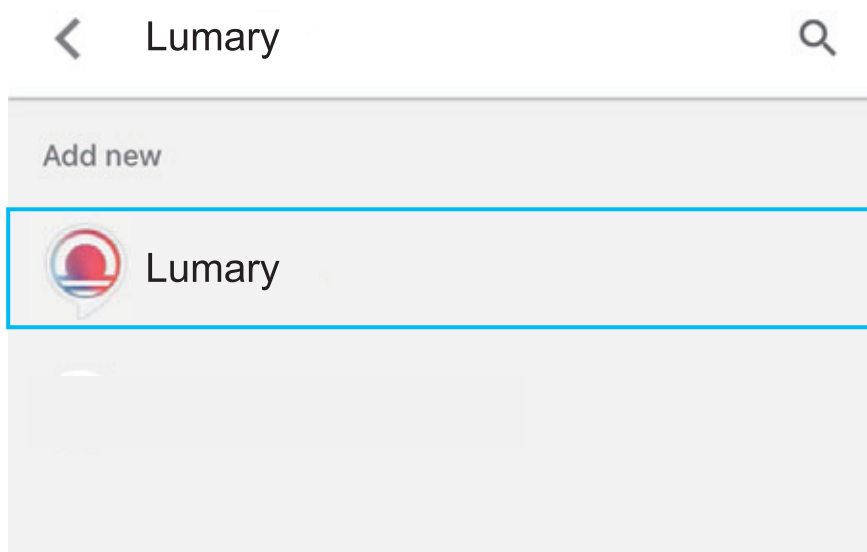

4

Authorize your account with Google Assistant using the username and password from your Lumary app.

Now your Google Home app and Lumary devices are linked!

You're now able to say "OK Google" and control your Lumary devices.

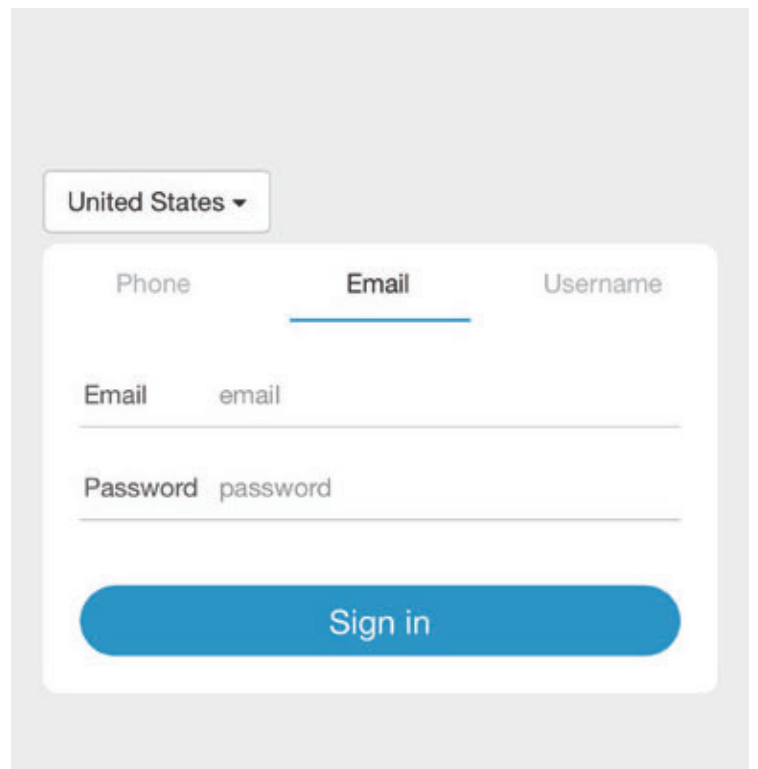

United States ▾

Phone **Email** Username

Email email

Password password

Sign in

At any time, go into the “Home Control” section of the Google Home app to set nicknames and rooms for your devices.

You can rename your devices in the Lumary app, and Google Assistant will refer to them by the same name.

So if you rename a smart bulb to “Living Room” or a nickname like “Blossom”, then Google Assistant will use that same name later on. You can always give it a nickname using the Google Home app as well.

You can also assign switch to a specific room, like “Bedroom” or “Kitchen.”

Google Assistant will be able to control devices by room.

Amazon Alexa



To control your Lumary smart switch, plugs,
or surge protectors, just ask Alexa.
Make sure your devices are already set up
using the Lumary app.

Things you can say*:

“Alexa,discover my devices.”

“Alexa,turn on the bedroom light.”

Alexa,set the bedroom light to orange.”

“Alexa,turn off the coffee machine.”

“Alexa,set the living room to 50%.”

Alexa,dim porch light.

*Some commands require compatible devices.

1. Log in to Lumary app, click your smart device, click “✎” in top right corner
2. Click Alexa in Third-party Control
3. Sign in with your Alexa account

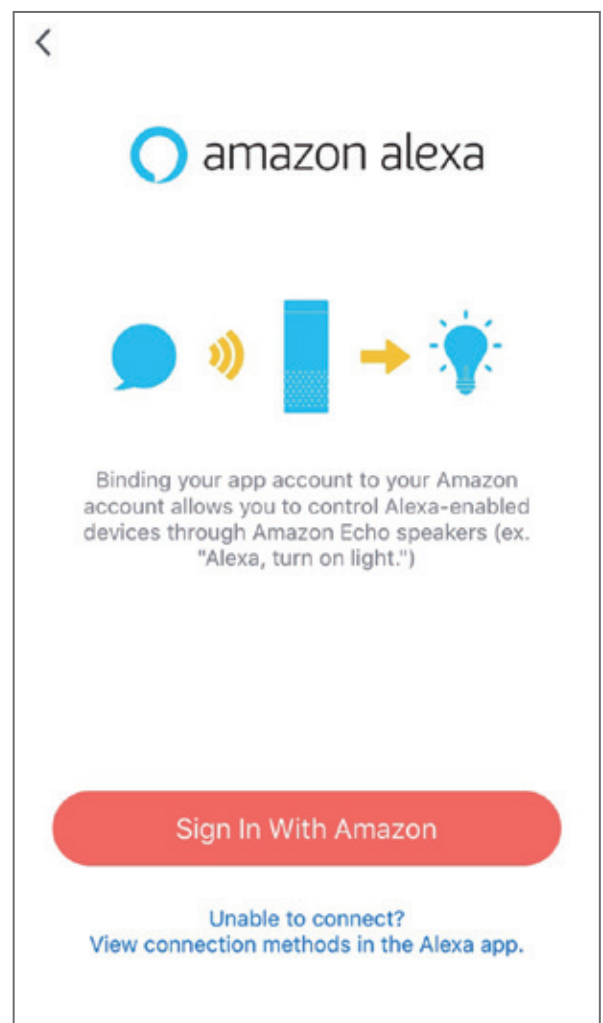
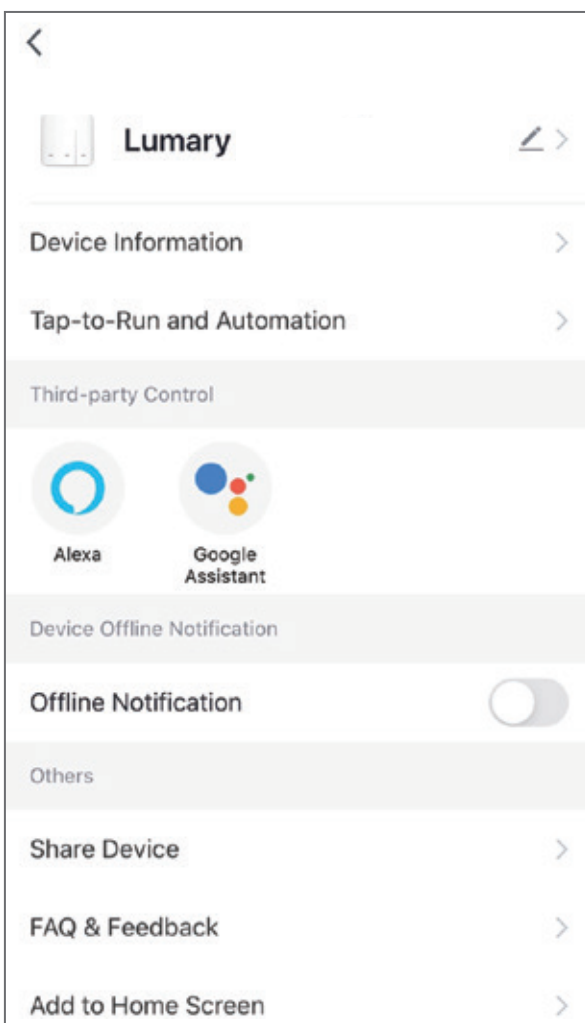

4. Click 'LINK'

5. Linked successfully, when add new device, there is no need to link again, just discover new device in Alexa.

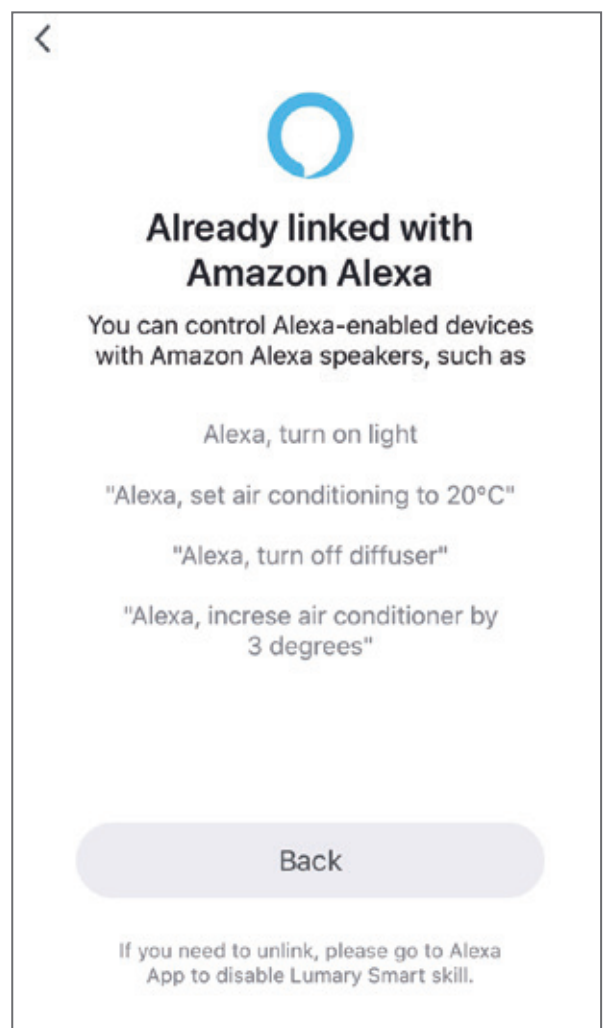
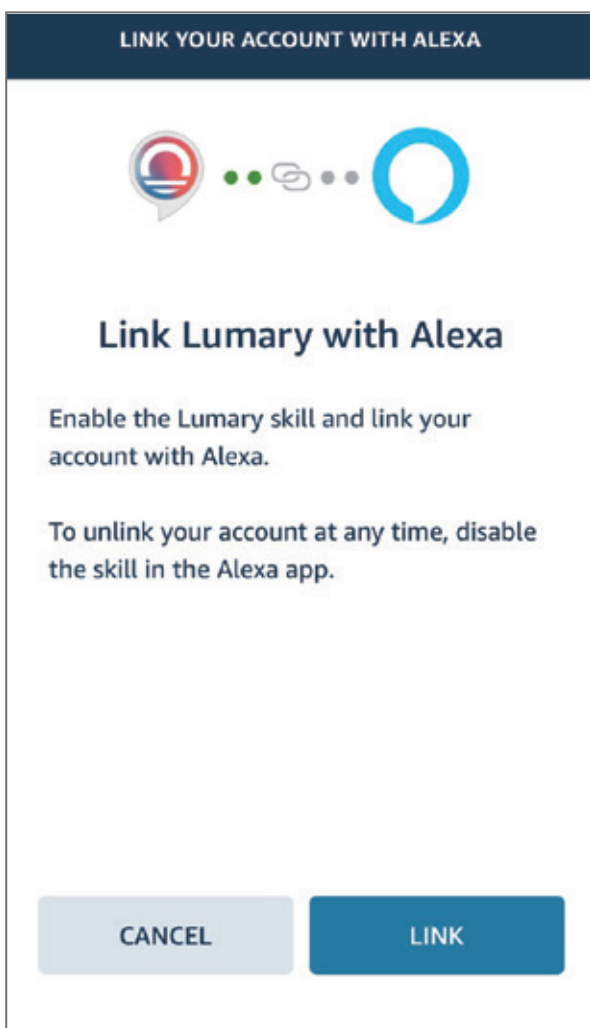

1

Open the Alexa App
and go to Skills
in the menu.

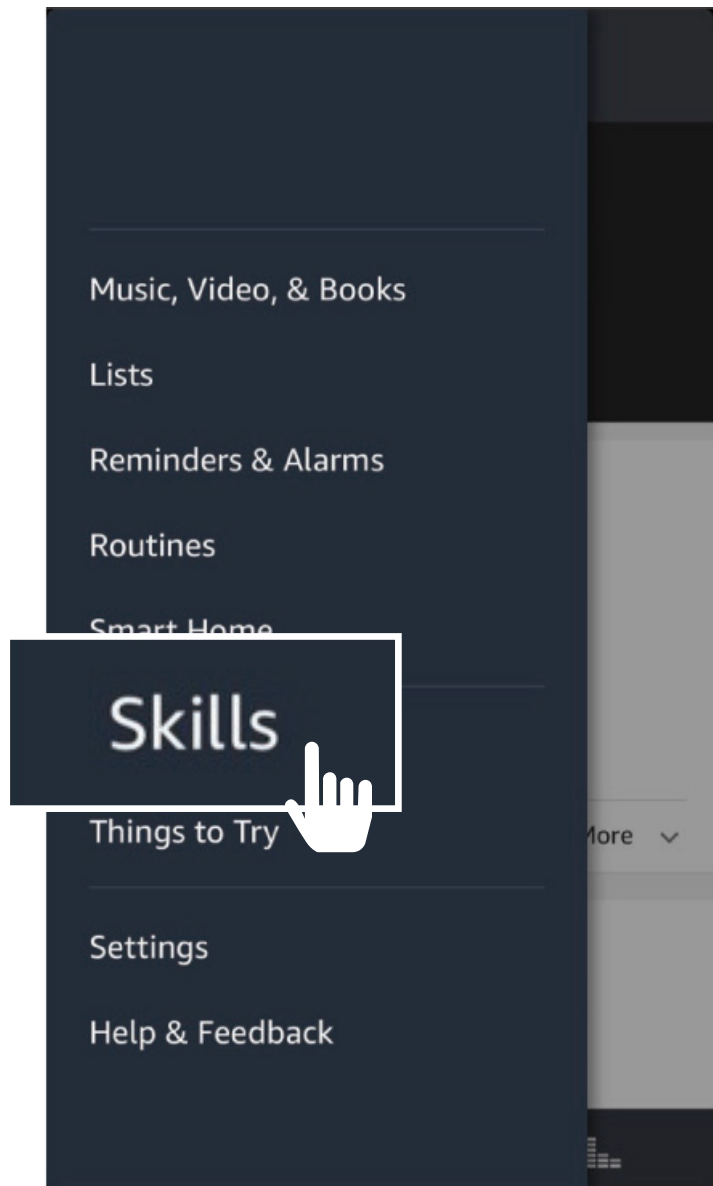

2

Search for Lumary then tap Enable.

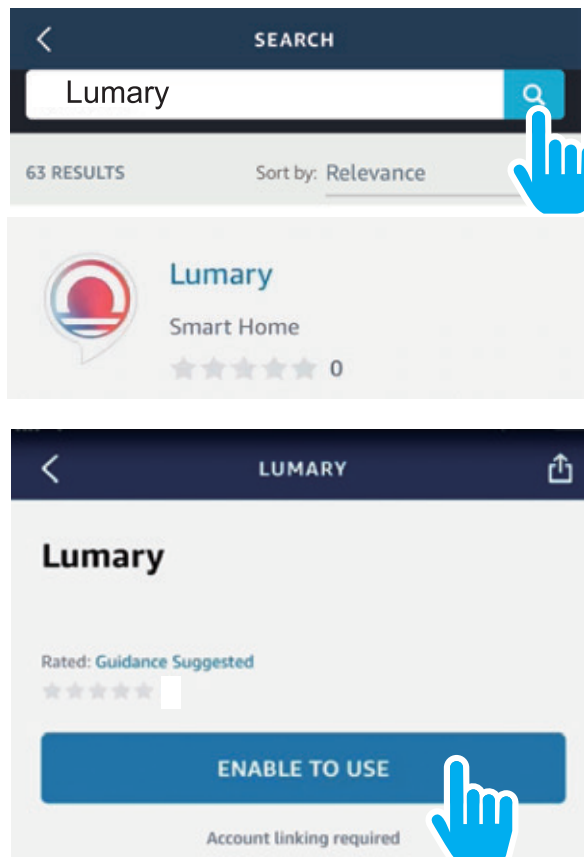

3

Authorize your account with Smart Home Skills using the username and password from your Lumary app.

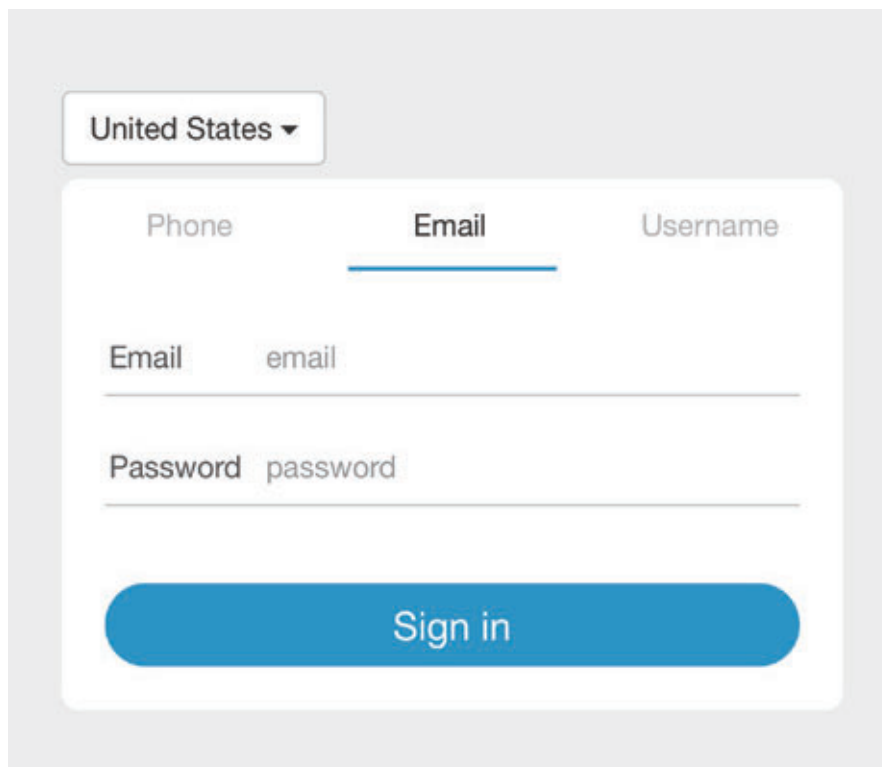

A screenshot of a sign-in form. At the top left, there is a dropdown menu showing "United States" with a downward arrow. Below this is a white rounded rectangle containing three tabs: "Phone", "Email", and "Username". The "Email" tab is selected and underlined. Under the "Email" tab, there is a text input field with the placeholder text "email". Below that is a text input field with the placeholder text "password". At the bottom of the form is a blue rounded button with the text "Sign in".

4

Choose “Discover Devices”. After a few seconds your Lumary devices will be displayed under Smart Home in the Alexa app.

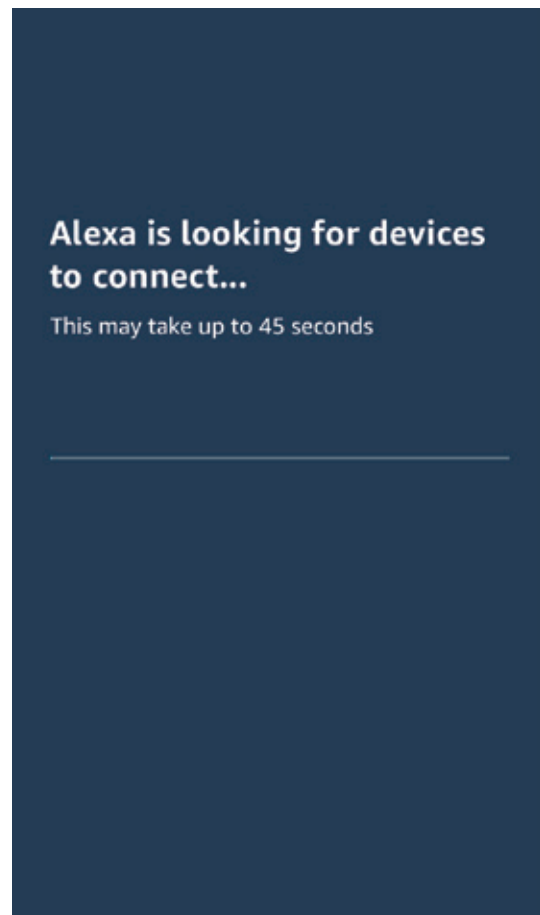

You can rename your devices in the Lumary app, and Alexa will refer to them by the same name.

So if you rename a smart switch to “Living Room” or a nickname like “Blossom,” then Alexa will use that same nickname later on.

Alternatively, you create an Alexa group, like “Bed room” or “Downstairs,” and add the device to the group.

Alexa will recognize the group name in the Alexa app, or the device name in the Lumary app.

More information is available at:

<http://tinyurl.com/alexa-smart-home-groups>

FCC Statement

This equipment has been tested and found to comply with the limits for a Class B digital device, pursuant to part 15 of the FCC Rules. These limits are designed to provide reasonable protection against harmful interference in a residential installation. This equipment generates, uses and can radiate radio frequency energy and, if not installed and used in accordance with the instructions, may cause harmful interference to radio communications. However, there is no guarantee that interference will not occur in a particular installation. If this equipment does cause harmful interference to radio or television reception, which can be determined by turning the equipment off and on, the user is encouraged to try to correct the interference by one or more of the following measures:

- Reorient or relocate the receiving antenna.
- Increase the separation between the equipment and receiver.
- Connect the equipment into an outlet on a circuit different from that to which the receiver is connected.
- Consult the dealer or an experienced radio/TV technician for help.

Caution: Any changes or modifications to this device not explicitly approved by manufacturer could void your authority to operate this equipment.

This device complies with part 15 of the FCC Rules. Operation is subject to the following two conditions: (1) This device may not cause harmful interference, and (2) this device must accept any interference received, including interference that may cause undesired operation.

RF Exposure Information

This equipment complies with FCC radiation exposure limits set forth for an uncontrolled environment. This equipment should be installed and operated with minimum distance 20cm between the radiator and your body.

Can't connect? Need help?



HAVING AN EASY TALK TO US BEFORE YOU RETURN
THE PRODUCT WILL FIX A PROBLEM MORE QUICKLY

Lumary support:
cs@inlntek.com

Visit us at: www.lumary.tech