

# FCC Part 22H & 24E Measurement and Test Report

For

Shenzhen Handheld-Wireless Technology Co., Ltd.

**FCC ID: 2AKFL-C5000**

<b>FCC Rules:</b>	<u>FCC Part 22H, FCC Part 24E</u>	
<b>Product Description:</b>	<u>Mobile Data Terminal</u>	
<b>Tested Model:</b>	<u>C5000</u>	
<b>Report No.:</b>	<u>BSL190312066004RF</u>	
<b>Tested Date:</b>	<u>April 16,2019-April 19,2019</u>	
<b>Issued Date:</b>	<u>April 22, 2019</u>	
<b>Tested By:</b>	<u>Messi Wang / Engineer</u>	<i>Messi Wang</i>
<b>Reviewed By:</b>	<u>Steven Wen / EMC Manager</u>	<i>Steven Wen</i>
<b>Approved &amp; Authorized By:</b>	<u>Mike mo / PSQ Manager</u>	<i>Mike mo</i>
<b>Prepared By:</b>	<b>BSL Testing Co.,LTD.</b>	
	NO. 24, ZH Park, Nantou, Shenzhen, 518000 China	
	Tel: 400-882-9628	Fax: 86- 755-26508703

**TABLE OF CONTENTS**

<b>1. GENERAL INFORMATION.....</b>	<b>3</b>
1.1 PRODUCT DESCRIPTION FOR EQUIPMENT UNDER TEST (EUT).....	3
1.2 TEST STANDARDS.....	5
1.3 TEST METHODOLOGY.....	5
1.4 TEST FACILITY.....	5
1.5 EUT SETUP AND TEST MODE.....	5
1.6 MEASUREMENT UNCERTAINTY.....	6
1.7 EQUIPMENT LIST AND DETAILS.....	6
<b>2. SUMMARY OF TEST RESULTS.....</b>	<b>7</b>
<b>3. RF EXPOSURE.....</b>	<b>8</b>
3.1 STANDARD APPLICABLE.....	8
3.2 TEST RESULT.....	8
<b>4. CONDUCTED AV OUTPUT POWER.....</b>	<b>9</b>
<b>5. PEAK-TO-AVERAGE RATIO.....</b>	<b>11</b>
<b>6. OCCUPY BANDWIDTH.....</b>	<b>13</b>
<b>7. MODULATION CHARACTERISTIC.....</b>	<b>18</b>
<b>8. OUT OF BAND EMISSION AT ANTENNA TERMINALS.....</b>	<b>18</b>
<b>9. ERP, EIRP MEASUREMENT.....</b>	<b>27</b>
<b>10. FIELD STRENGTH OF SPURIOUS RADIATION MEASUREMENT.....</b>	<b>32</b>
<b>11. FREQUENCY STABILITY V.S. TEMPERATURE MEASUREMENT.....</b>	<b>38</b>
<b>12. FREQUENCY STABILITY V.S. VOLTAGE MEASUREMENT.....</b>	<b>41</b>
<b>13. TEST SETUP PHOTO.....</b>	<b>43</b>
<b>14. EUT CONSTRUCTIONAL DETAILS.....</b>	<b>44</b>

## 1. GENERAL INFORMATION

### 1.1 Product Description for Equipment Under Test (EUT)

Applicant:	Shenzhen Handheld-Wireless Technology Co., Ltd.
Address of applicant:	16th Floor, Block B, Dongfangtiande Bldg., Minzhi Street, Longhua New District, Shenzhen, China
Manufacturer:	Shenzhen Handheld-Wireless Technology Co., Ltd.
Address of manufacturer:	16th Floor, Block B, Dongfangtiande Bldg., Minzhi Street, Longhua New District, Shenzhen, China
Product Name:	Mobile Data Terminal
Model No.:	C5000,C5100
Test Model No:	C5000
Remark: All above models are identical in the same PCB layout, interior structure and electrical circuits. The differences are color and model name for commercial purpose.	
Sample(s) Status:	Engineer sample
Quantity of tested samples	1
Hardware Version:	1.0
Software Version:	/
Support Networks:	GSM, GPRS, EDGE UMTS FDD Band II/V
Support Bands:	GSM850/PCS1900/GPRS850/GPRS1900/EDGE850/EDGE1900 UMTS FDD Band II/ V
TX Frequency:	GSM850: 824.20MHz-848.80MHz PCS1900: 1850.20MHz-1909.80MHz WCDMA Band V: 826.40MHz -846.60MHz WCDMA Band II: 1852.40MHz -1907.60MHz
Class:	12
Modulation type:	GMSK for GSM/GPRS; GMSK/8PSK For EGPRS QPSK for WCDMA/HSUPA/HSDPA
Antenna type:	PIFA
Antenna gain:	1.6dBi(max.) For GSM 850 1.6dBi(max.) For PCS 1900 1.6dBi(max.) For WCDMA Band V 1.6dBi(max.) For WCDMA Band II
Power supply:	DC 3.7V by Rechargeable Li-ion Battery(4500mAh) Recharged by DC 5V/2A

**Operation Frequency List:**

GSM 850		PCS1900		WCDMA Band V		WCDMA Band II	
Channel	Frequency (MHz)	Channel	Frequency (MHz)	Channel	Frequency (MHz)	Channel	Frequency (MHz)
128	824.20	512	1850.20	4132	826.40	9262	1852.40
129	824.40	513	1850.40	4133	826.60	9263	1852.60
· ∴	· ∴	· ∴	· ∴	· ∴	· ∴	· ∴	· ∴
189	836.40	660	1879.80	4181	836.20	9399	1879.80
190	836.60	661	1880.00	4182	836.40	9400	1880.00
191	836.80	662	1880.20	4183	836.60	9401	1880.20
· ∴	· ∴	· ∴	· ∴	· ∴	· ∴	· ∴	· ∴
250	848.60	809	1909.60	4232	846.40	9537	1907.40
251	848.80	810	1909.80	4233	846.60	9538	1907.60

Regards to the operating frequency range over 10 MHz, the Lowest frequency, the middle frequency, and the highest frequency of channel were selected to perform the test, and the selected channel see below:

**Final test channel:**

GSM 850		PCS1900		WCDMA Band V		WCDMA Band II	
Channel	Frequency (MHz)	Channel	Frequency (MHz)	Channel	Frequency (MHz)	Channel	Frequency (MHz)
128	824.20	512	1850.20	4132	826.40	9262	1852.40
190	836.60	661	1880.00	4183	836.60	9400	1880.00
251	848.80	810	1909.80	4233	846.60	9538	1907.60

**EUT Cable List and Details**

Cable Description	Length (M)	Shielded/Unshielded	With Core/Without Core
/	/	/	/

**Auxiliary Equipment List and Details**

Description	Manufacturer	Model	Serial Number
/	/	/	/

**Special Cable List and Details**

Cable Description	Length (M)	Shielded/Unshielded	With Core/Without Core
/	/	/	/

## **1.2 EUT Setup and Test Mode**

During all testing, EUT is in link mode with base station emulator at maximum power level. The spurious emission measurements were carried out in semi-anechoic chamber with 3-meter test range, and EUT is rotated on three test planes to find out the worst emission.

## **1.3 Test Standards**

The following report accordance with FCC Part 2 subpart J, FCC Part 22 subpart H and FCC Part 24 subpart E of the Federal Communication Commission rules.

## **1.4 Test Methodology**

Both conducted and radiated testing were performed according to the procedures document on ANSI/TIA-603-E (2016) and FCC CFR 47.1046, 2.1047, 2.1049, 2.1051, 2.1053, 2.1055 and 2.1057, ANSI C63.26-2015,KDB 971168

## **1.5 Test Facility**

BSL Testing Co.,LTD.

NO. 24, ZH Park, Nantou, Shenzhen, 518000 China

Test Firm Registration Number: 866035

Designation Number: CN1217

Tel: Tel: 400-882-9628

Fax: 86- 755-26508703

## 1.6 Measurement Uncertainty

Measurement uncertainty		
Parameter	Conditions	Uncertainty
RF Output Power	Conducted	$\pm 0.42\text{dB}$
Occupied Bandwidth	Conducted	$\pm 1.5\%$
Frequency Stability	Conducted	2.3%
Transmitter Spurious Emissions	Radiated	$\pm 5.1\text{dB}$
Transmitter Spurious Emissions	Conducted	$\pm 0.42\text{dB}$

## 1.7 Equipment List and Details

Description	Manufacturer	Model	Serial No.	Cal Date	Due. Date
Communication Tester	Rohde & Schwarz	CMW500	100358	2018-11-08	2019-11-07
Spectrum Analyzer	R&S	FSP40	100550	2018-10-08	2019-10-07
Test Receiver	R&S	ESCI7	US47140102	2018-10-08	2019-10-07
Signal Generator	HP	83630B	3844A01028	2018-10-08	2019-10-07
Test Receiver	R&S	ESPI-3	100180	2018-10-08	2019-10-07
Amplifier	Agilent	8449B	4035A00116	2018-10-08	2019-10-07
Amplifier	HP	8447E	2945A02770	2018-10-08	2019-10-07
Signal Generator	IFR	2023A	202307/242	2018-10-08	2019-10-07
Broadband Antenna	SCHAFFNER	2774	2774	2018-10-21	2019-10-20
Biconical and log periodic antennas	ELECTRO-METRIC	EM-6917B-1	171	2018-10-21	2019-10-20
Horn Antenna	R&S	HF906	100253	2018-10-21	2019-10-20
Horn Antenna	EM	EM-6961	6462	2018-10-21	2019-10-20
LISN	R&S	ESH3-Z5	100196	2018-10-08	2019-10-07
LISN	COM-POWER	LI-115	02027	2018-10-08	2019-10-07
3m Semi-Anechoic Chamber	Chengyu Electron	9 (L)*6 (W)* 6 (H)	BSL086	2018-10-08	2019-10-07
Horn Antenna	Schwarzbeck	BBHA9170	00814	2018-10-21	2019-10-20
Loop Antenna	Schwarzbeck	FMZB 1519B	9773	2018-10-21	2019-10-20

## 2. SUMMARY OF TEST RESULTS

Test Item	Section in CFR 47	Result
RF Exposure (SAR)	Part 1.1307 Part 2.1093	Pass* (Please refer to SAR Report)
RF Output Power	Part 2.1046 Part 22.913 (a)(2) Part 24.232 (c)	Pass
Peak-to-Average Ratio	Part 2.1046 Part 24.232 (d)	Pass
Modulation Characteristics	Part 2.1047	Pass
99% & -26 dB Occupied Bandwidth	Part 2.1049 Part 22.917 Part 24.238	Pass
Spurious Emissions at Antenna Terminal	Part 2.1051 Part 22.917 (a) Part 24.238 (a)	Pass
Field Strength of Spurious Radiation	Part 2.1053 Part 22.917 (a) Part 24.238 (a)	Pass
Out of band emission, Band Edge	Part 22.917 (a) Part 24.238 (a)	Pass
Frequency stability vs. temperature	Part 2.1055(a)(1)(b)	Pass
Frequency stability vs. voltage	Part 2.1055(d)(1)(2)	Pass

### **3. RF EXPOSURE**

---

#### **3.1 Standard Applicable**

According to § 1.1307 and § 2.1093, the portable transmitter must comply the RF exposure requirements.

#### **3.2 Test Result**

This product complied with the requirement of the RF exposure, please see the SAR report.

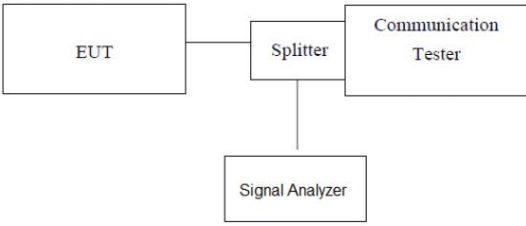

#### 4. CONDUCTED AV OUTPUT POWER

Test Requirement:	FCC part22.913(a) and FCC part24.232(b)
Test Method:	FCC part2.1046
Limit:	GSM850, WCDMA Band V: 7W PCS1900, WCDMA Band II: 2W
Test setup:	 <pre> graph LR     EUT[EUT] --- Splitter[Splitter]     Splitter --- CT[Communication Tester]     Splitter --- SA[Signal Analyzer]   </pre> <p><i>Note: Measurement setup for testing on Antenna connector</i></p>
Test Procedure:	<ol style="list-style-type: none"> <li>1. The transmitter output port was connected to base station.</li> <li>2. The RF output of EUT was connected to the Signal Analyzer by RF cable and attenuator, the path loss was compensated to the results for each measurement.</li> <li>3. Set EUT at maximum power through base station.</li> <li>4. Select lowest, middle, and highest channels for each band and different modulation.</li> <li>5. Measure the maximum burst average power.</li> </ol>
Test Instruments:	Refer to section 1.7 for details
Test mode:	Refer to section 1.2 for details
Test results:	Pass

## Measurement Data

GSM 850		Tune-up	Burst Conducted power (dBm)			Division Factors	Tune-up	Average power (dBm)		
			Channel/Frequency(MHz)					Channel/Frequency(MHz)		
		Max	128/ 824.2	190/ 836.6	251/ 848.8		Max	128/ 824.2	190/ 836.6	251/8 48.8
GSM		32.50	32.17	32.15	32.16	-9.03dB	23.47	23.14	23.12	23.13
GPRS (GMSK)	1TX slot	32.50	31.98	31.94	32.01	-9.03dB	23.47	22.95	22.91	22.98
	2TX slot	31.00	30.67	30.67	30.52	-6.02dB	24.98	24.65	24.65	24.50
	<b>3TX slot</b>	<b>29.50</b>	<b>29.18</b>	<b>29.17</b>	<b>29.41</b>	<b>-4.26dB</b>	<b>25.24</b>	<b>24.92</b>	<b>24.91</b>	<b>25.15</b>
	4TX slot	28.00	27.73	27.73	27.93	-3.01dB	24.99	24.72	24.72	24.92
EGPRS (8PSK)	1TX slot	26.50	25.75	25.75	26.07	-9.03dB	17.47	16.72	16.72	17.04
	2TX slot	24.50	24.26	24.25	23.88	-6.02dB	18.48	18.24	18.23	17.86
	3TX slot	23.00	22.76	22.77	22.33	-4.26dB	18.74	18.50	18.51	18.07
	4TX slot	21.50	21.25	21.25	20.86	-3.01dB	18.49	18.24	18.24	17.85
GSM 1900		Tune-up	Burst Conducted power (dBm)			Division Factors	Tune-up	Average power (dBm)		
			Channel/Frequency(MHz)					Channel/Frequency(MHz)		
		Max	512/ 1850.2	661/ 1880	810/ 1909.8		Max	512/ 1850.2	661/ 1880	810/ 1909. 8
GSM		29.50	29.26	29.24	29.38	-9.03dB	20.47	20.23	20.21	20.35
GPRS (GMSK)	1TX slot	29.50	29.11	29.11	29.06	-9.03dB	20.47	20.08	20.08	20.03
	2TX slot	28.00	27.71	27.70	27.45	-6.02dB	21.98	21.69	21.68	21.43
	<b>3TX slot</b>	<b>27.00</b>	<b>26.24</b>	<b>26.25</b>	<b>26.53</b>	<b>-4.26dB</b>	<b>22.74</b>	<b>21.98</b>	<b>21.99</b>	<b>22.27</b>
	4TX slot	25.50	24.75	24.73	25.05	-3.01dB	22.49	21.74	21.72	22.04
EGPRS (8PSK)	1TX slot	26.00	25.22	25.21	25.50	-9.03dB	16.97	16.19	16.18	16.47
	2TX slot	24.00	23.76	23.73	23.31	-6.02dB	17.98	17.74	17.71	17.29
	3TX slot	22.50	22.24	22.26	21.90	-4.26dB	18.24	17.98	18.00	17.64
	4TX slot	21.00	20.76	20.80	20.36	-3.01dB	17.99	17.75	17.79	17.35

Item	Band	FDD Band V result (dBm)			FDD Band II result (dBm)		
		Test Channel			Test Channel		
		4132/ 826.4	4183/ 836.6	4233/ 846.6	9262/ 1852.4	9400/ 1880	9538/ 1907.6
RMC	12.2kbps	23.53	23.34	23.26	23.73	23.55	23.12
	64kbps	23.14	23.01	22.88	23.62	23.40	23.06
	144kbps	22.76	22.65	22.66	22.53	22.14	22.04
	384kbps	22.63	22.36	22.52	22.17	22.91	22.85
HSDPA	Subtest 1	22.96	22.75	22.33	22.76	22.82	22.69
	Subtest 2	22.93	22.52	22.26	22.49	22.68	22.49
	Subtest 3	22.66	22.24	22.19	22.25	22.47	22.12
	Subtest 4	22.58	22.03	22.03	22.00	22.08	22.06
HSUPA	Subtest 1	22.91	22.76	22.82	22.83	22.66	22.84
	Subtest 2	22.65	22.41	22.69	22.55	22.56	22.59
	Subtest 3	22.59	22.17	22.38	22.42	22.48	22.30
	Subtest 4	22.37	22.13	22.13	22.18	22.19	22.03
	Subtest 5	22.19	22.05	22.02	22.22	22.13	22.00

## 5. PEAK-TO-AVERAGE RATIO

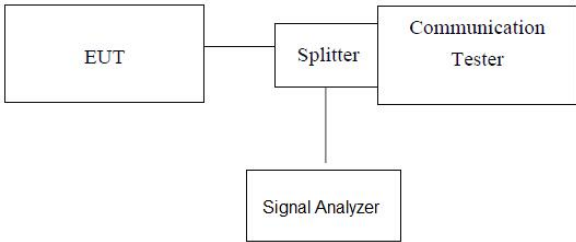
Test Requirement:	FCC part24.232(d)
Test Method:	FCC part2.1046
Limit:	13db
Test setup:	 <p><i>Note: Measurement setup for testing on Antenna connector</i></p>
Test Procedure:	<ol style="list-style-type: none"> <li>1. The transmitter output port was connected to base station.</li> <li>2. The RF output of EUT was connected to the Signal Analyzer by RF cable and attenuator, the path loss was compensated to the results for each measurement.</li> <li>3. Set EUT at maximum power through base station.</li> <li>4. Select lowest, middle, and highest channels for each band and different modulation.</li> <li>5. Measure the maximum burst average power.</li> <li>6. Set the CCDF (Complementary Cumulative Distribution Function) option of the spectrum analyzer. Record the maximum PAPR level associated with a probability of 0.1%.</li> </ol>
Test Instruments:	Refer to section 1.7 for details
Test mode:	Refer to section 1.2 for details
Test results:	Pass

Measurement data

EUT Mode	Channel	Frequency (MHz)	Peak-to-Average Ratio(dB)	Limit (dB)	Result
GSM 850 GMSK	128	824.20	7.63	13	PASS
	190	836.60	7.64	13	
	251	848.80	7.65	13	
GSM 850 GPRS	128	824.20	7.69	13	
	190	836.60	7.66	13	
	251	848.80	7.74	13	
GSM 850 EGPRS	128	824.20	10.42	13	
	190	836.60	10.23	13	
	251	848.80	10.36	13	
PCS 1900 GMSK	512	1850.20	7.69	13	
	661	1880.00	7.78	13	
	810	1909.80	7.76	13	
PCS 1900 GPRS	512	1850.20	7.78	13	
	661	1880.00	7.69	13	
	810	1909.80	7.66	13	
PCS 1900 EGPRS	512	1850.20	7.65	13	
	661	1880.00	10.84	13	
	810	1909.80	10.61	13	

WCDMA Band II WCDMA	9262	1852.40	2.92	13	PASS
	9400	1880.00	3.03	13	
	9538	1907.60	2.96	13	
WCDMA Band II HSDPA	9262	1852.40	3.02	13	
	9400	1880.00	3.25	13	
	9538	1907.60	3.14	13	
WCDMA Band V WCDMA	4132	826.40	3.68	13	
	4183	836.60	3.29	13	
	4233	846.60	3.56	13	
WCDMA Band V HSDPA	4132	826.40	3.73	13	
	4183	836.60	3.25	13	
	4233	846.60	3.69	13	
WCDMA Band V HSUPA	4132	826.40	3.76	13	
	4183	836.60	3.33	13	
	4233	846.60	3.54	13	

## 6. OCCUPY BANDWIDTH

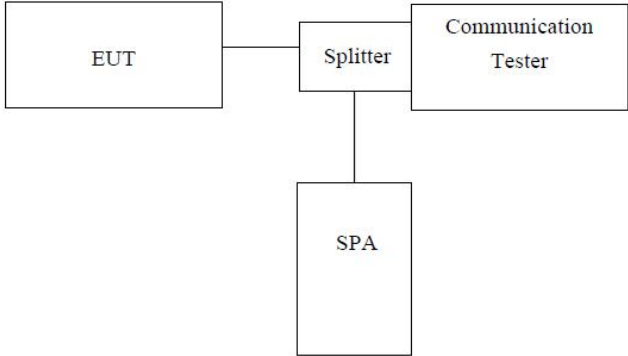
Test Requirement:	FCC part22.913(a) and FCC part24.232(b)
Test Method:	FCC part2.1049
Test setup:	 <p><i>Note: Measurement setup for testing on Antenna connector</i></p>
Test Procedure:	<ol style="list-style-type: none"> <li>1. The EUT's output RF connector was connected with a short cable to the spectrum analyzer</li> <li>2. RBW was set to about 1% of emission BW, VBW= 3 times RBW.</li> <li>3. -26dBc display line was placed on the screen (or 99% bandwidth), the occupied bandwidth is the delta frequency between the two points where the display line intersects the signal trace.</li> </ol>
Test Instruments:	Refer to section 1.7 for details
Test mode:	Refer to section 1.2 for details
Test results:	Pass

Measurement Data(only show the worst case)

EUT Mode	Channel	Frequency (MHz)	99% Occupy bandwidth (KHz)	-26dB bandwidth (KHz)
GSM 850 (GMSK)	128	824.20	245	312
	190	836.60	248	316
	251	848.80	240	314
EGPRS850 (8PSK,1Slot)	128	824.20	240	316
	190	836.60	248	328
	251	848.80	240	321
PCS1900 (GMSK)	512	1850.20	244	306
	661	1880.00	246	314
	810	1909.80	242	311
EGPRS1900 (8PSK,1Slot)	512	1850.20	253	330
	661	1880.00	259	334
	810	1909.80	256	331
WCDMA Band II (QPSK)	9262	1852.40	4189	4716
	9400	1880.00	4208	4719
	9538	1907.60	4203	4715
WCDMA Band V (QPSK)	4132	826.40	4180	4711
	4183	836.60	4188	4717
	4233	846.60	4183	4715

Note: GSM&GPRS use the same modulation technical (GMSK), and with the same channels, so the 99% OBW and the -26dB of GPRS not performed.

Test plot as follows (only show the worst case):

**GSM 850 (GMSK)**

Middle channel

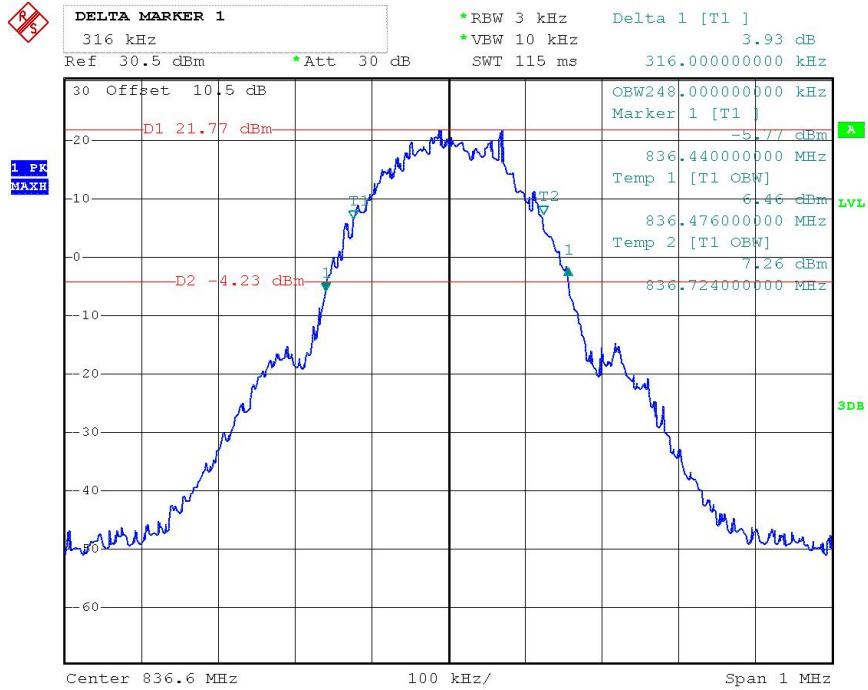

**PCS 1900 (GMSK)**

Middle channel

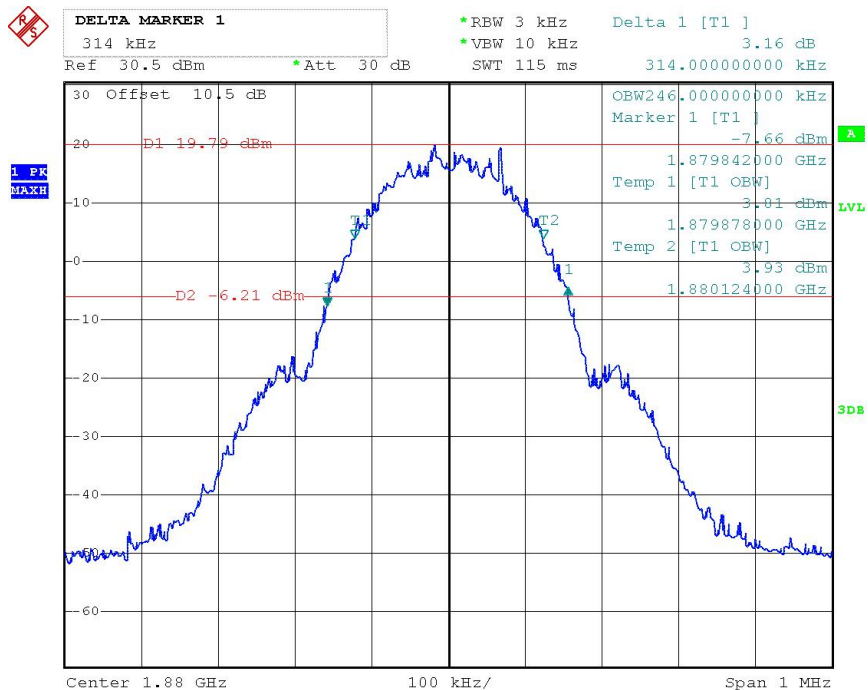

EGPRS850(8PSK,1Slot)

Middle channel

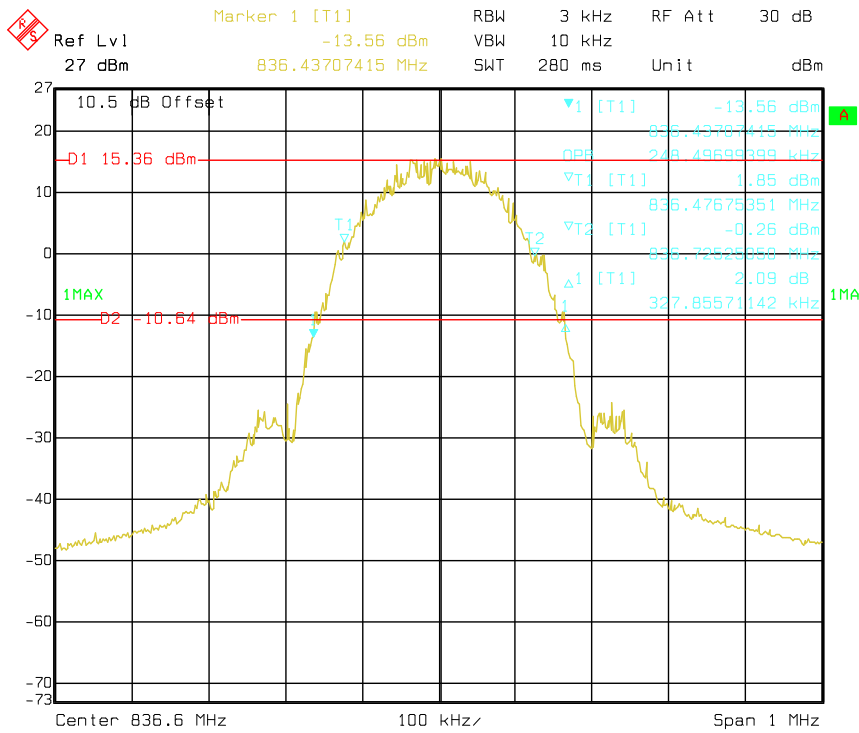

EGPRS1900(8PSK,1Slot)

Middle channel

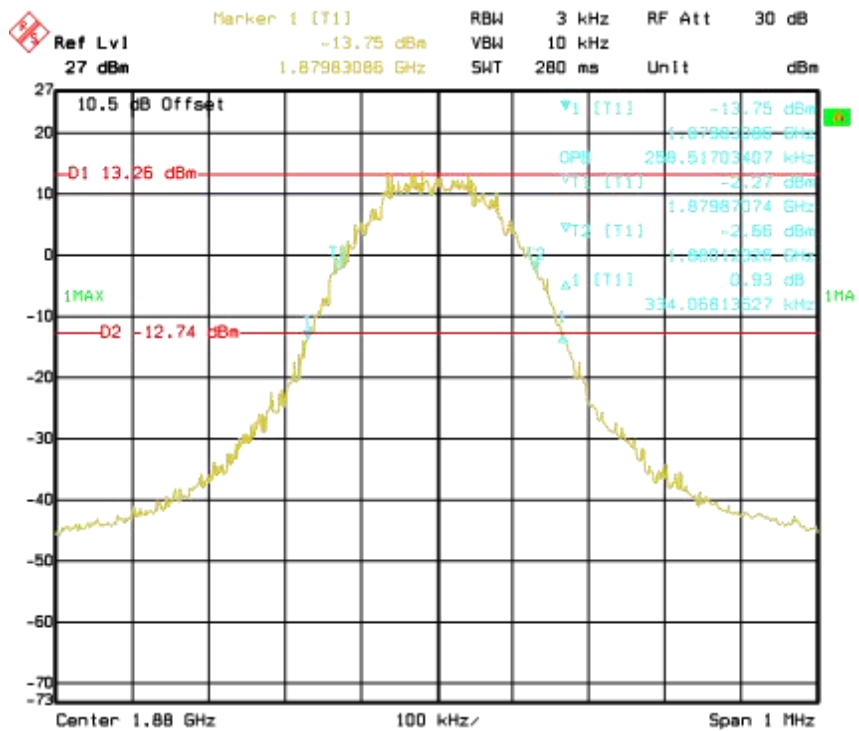



WCDMA Band II (QPSK)

Middle channel

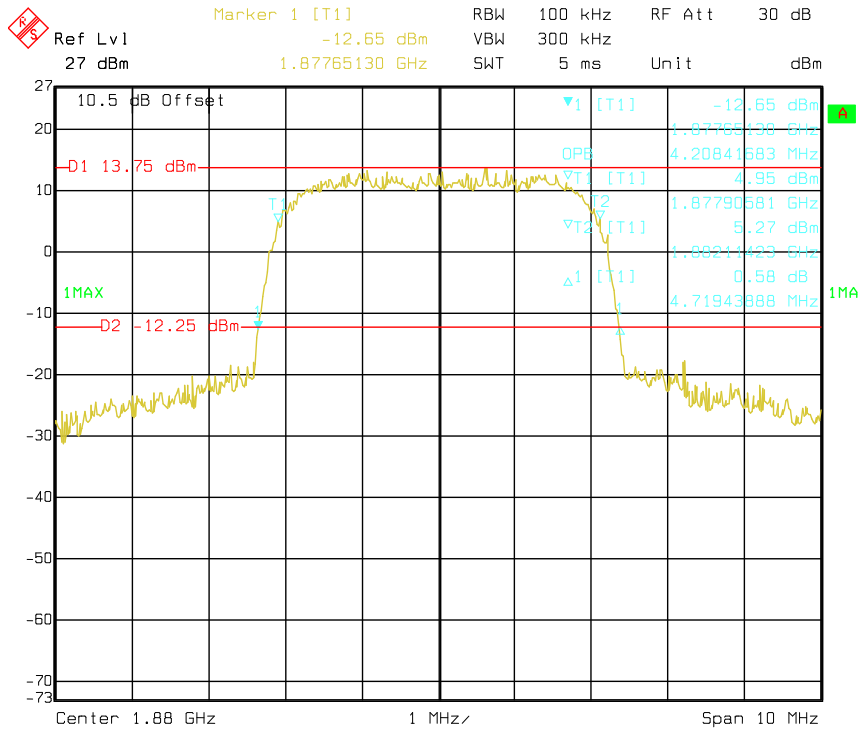

WCDMA Band V (QPSK)

Middle channel

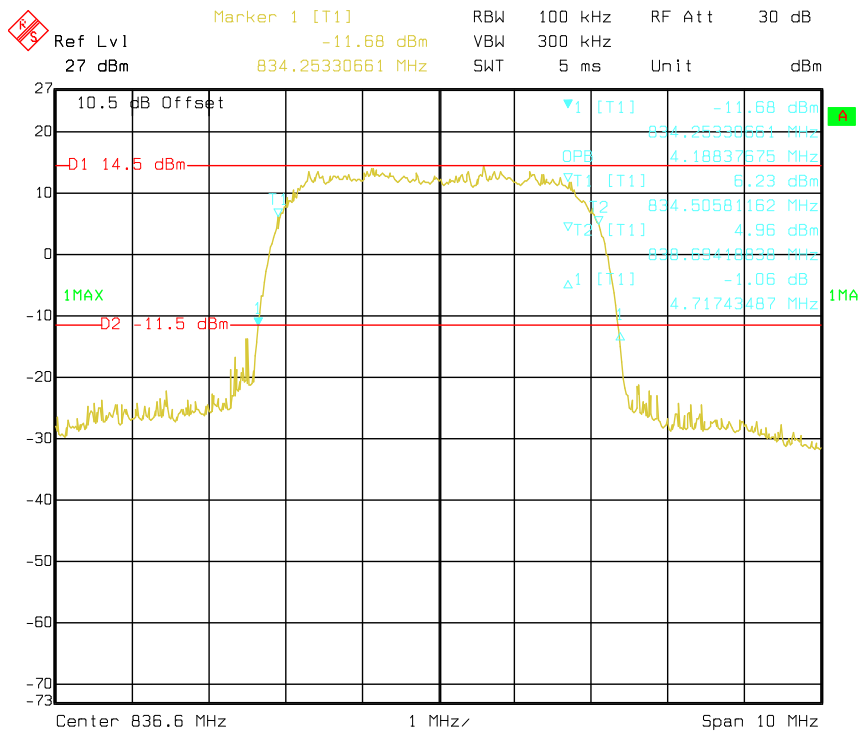

## 7. MODULATION CHARACTERISTIC

---

According to FCC § 2.1047(d), Part 22H & 24E there is no specific requirement for digital modulation, therefore modulation characteristic is not presented.

## 8. OUT OF BAND EMISSION AT ANTENNA TERMINALS

---

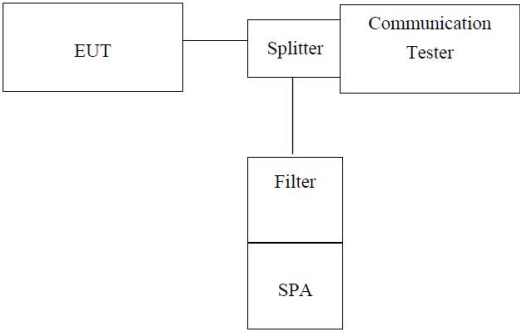
Test Requirement:	FCC part22.917(a) and FCC part24.238(a)
Test Method:	FCC part2.1051
Limit:	-13dBm
Test setup:	 <p><i>Note: Measurement setup for testing on Antenna connector</i></p>
Test Procedure:	<ol style="list-style-type: none"> <li>1 The RF output of the transceiver was connected to a spectrum analyzer through appropriate attenuation.</li> <li>2 The resolution bandwidth of the spectrum analyzer was set at 1MHz, sufficient scans were taken to show the out of band Emissions if any up to 10th harmonic.</li> <li>3 For the out of band: Set the RBW, VBW = 1MHz, Start=30MHz, Stop= 10th harmonic.</li> <li>4 Band Edge Requirements: In the 1 MHz bands immediately outside and adjacent to the frequency block, a resolution bandwidth of at least 1 percent of the emission bandwidth of the fundamental emission of the transmitter may be employed to measure the out of band Emissions.</li> </ol>
Test Instruments:	Refer to section 1.7 for details
Test mode:	Refer to section 1.2 for details
Test results:	Pass

Test plot as follows:

Note: During the conducted spurious emission test, a band filter was used. The information of the filter is reported at section 6.0 (refer to item 24, 25).

Onl show the worst case

**GSM 850-Middle Channel**

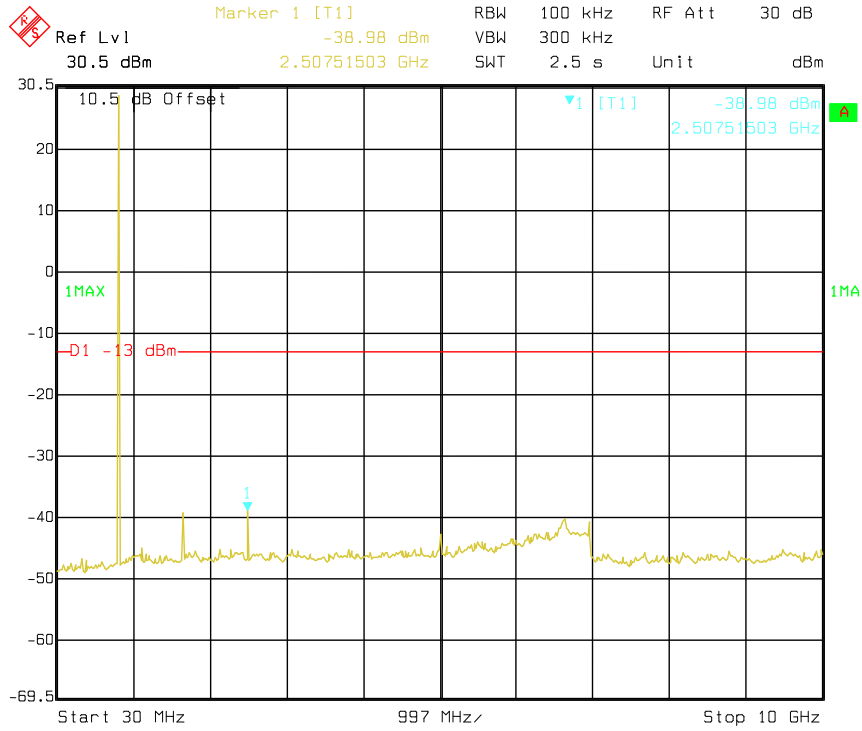

Middle channel

**PCS1900-Middle Channel**

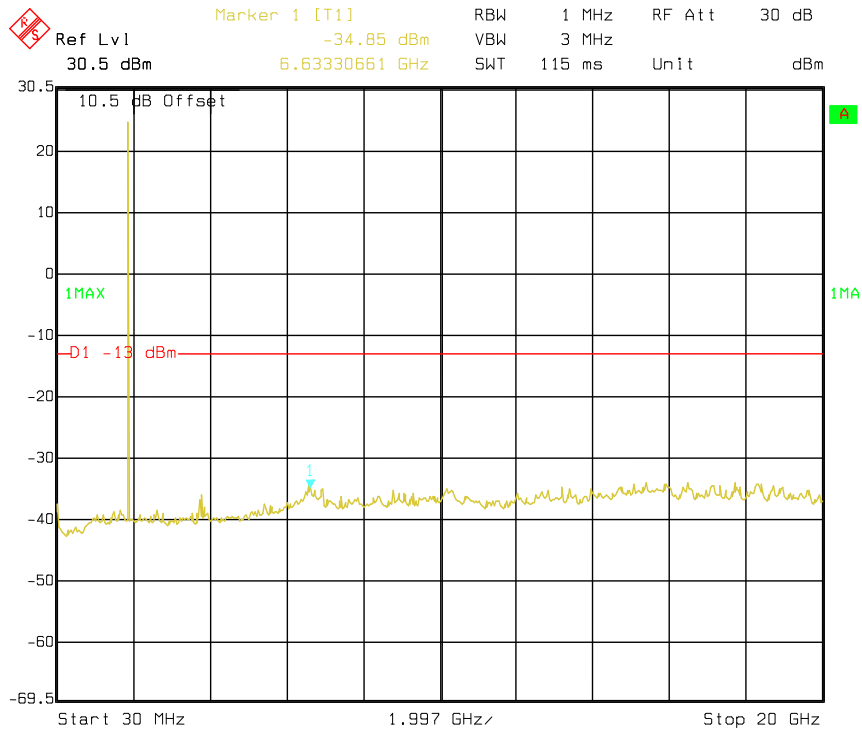

Middle channel

WCDMA Band V-Middle Channel

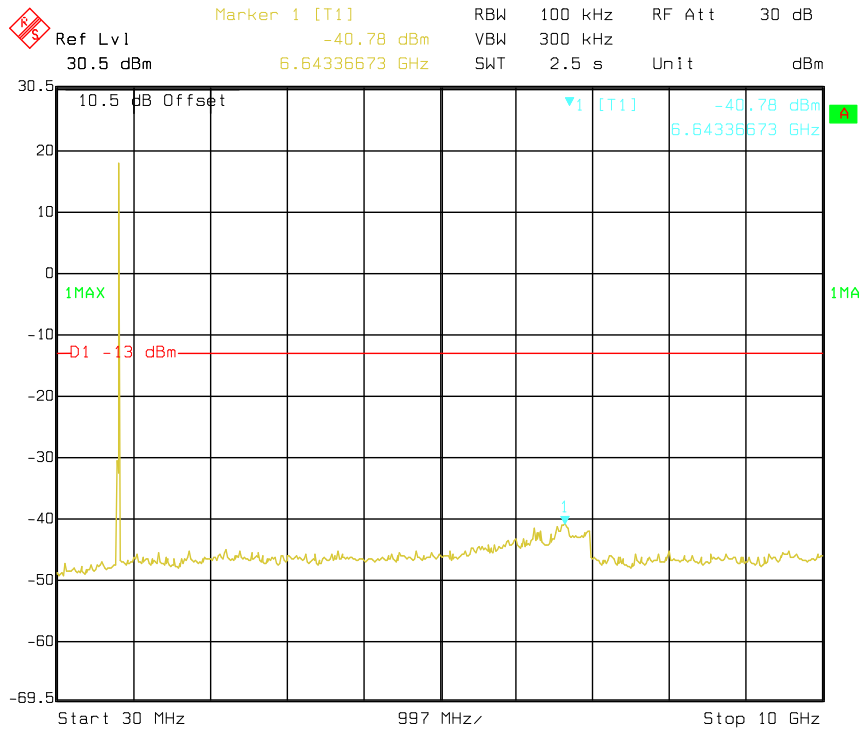

Middle channel

WCDMA Band II-Middle Channel

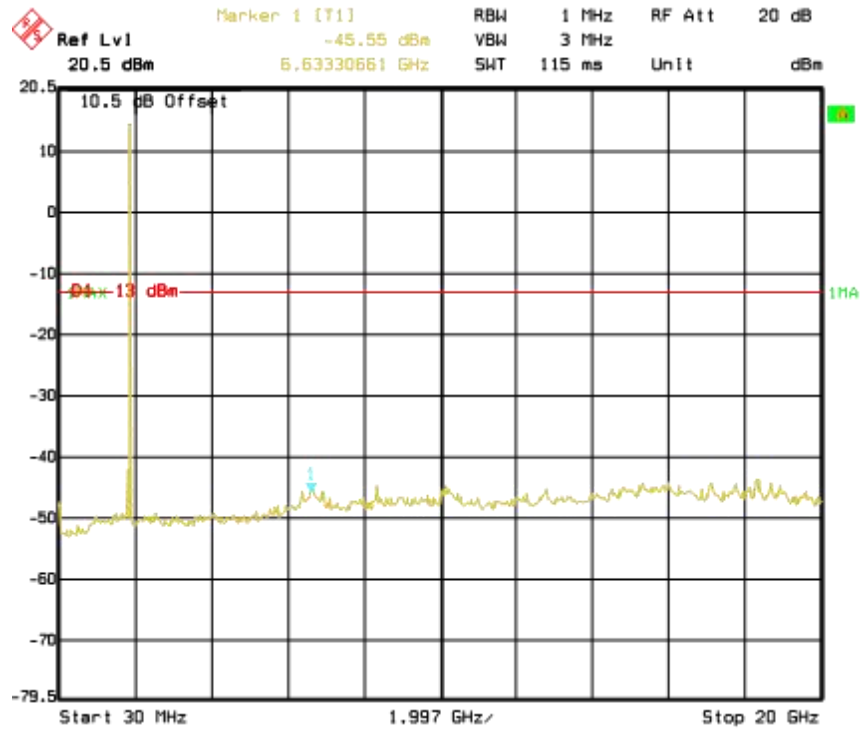

Middle channel

**GSM850**

Channel	Emission (dBm)	Limit (dBm)	Verdict
128	-16.90	-13	Pass
251	-16.18	-13	Pass

**PCS 1900**

Channel	Emission (dBm)	Limit (dBm)	Verdict
512	-19.10	-13	Pass
810	-18.14	-13	Pass

Band Edge:

**GSM850**

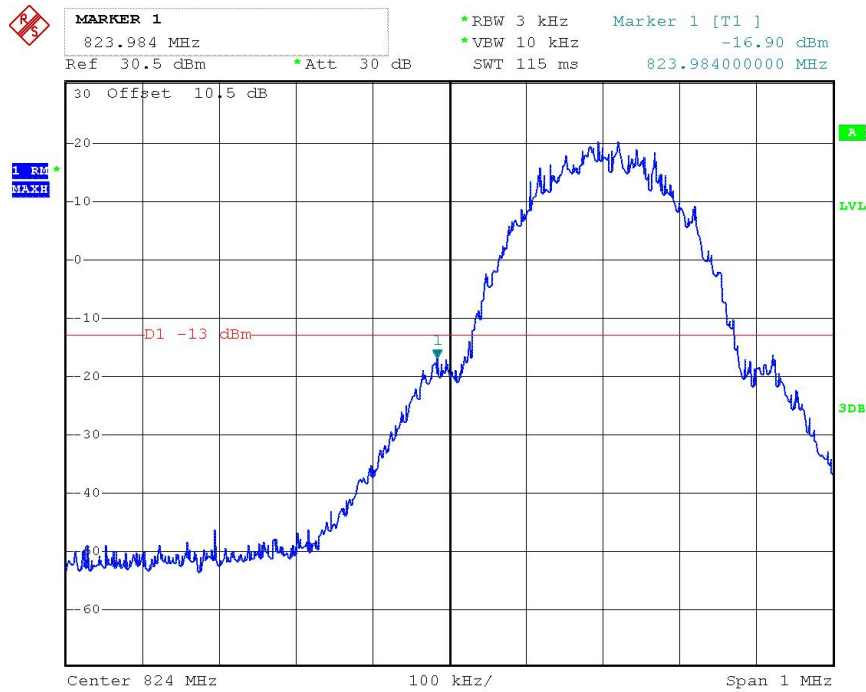

Lowest channel

GSM850

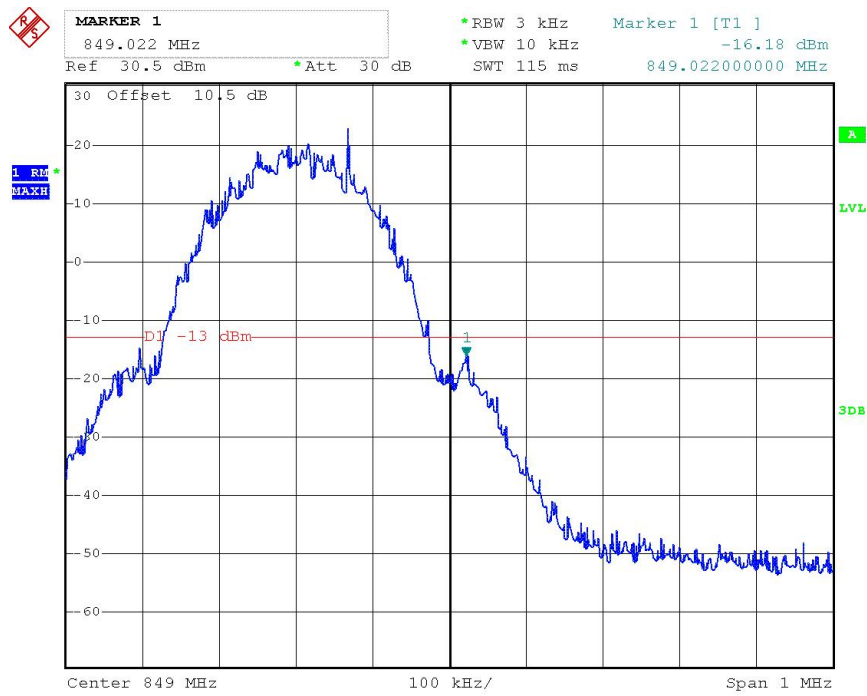

Highest channel

PCS1900

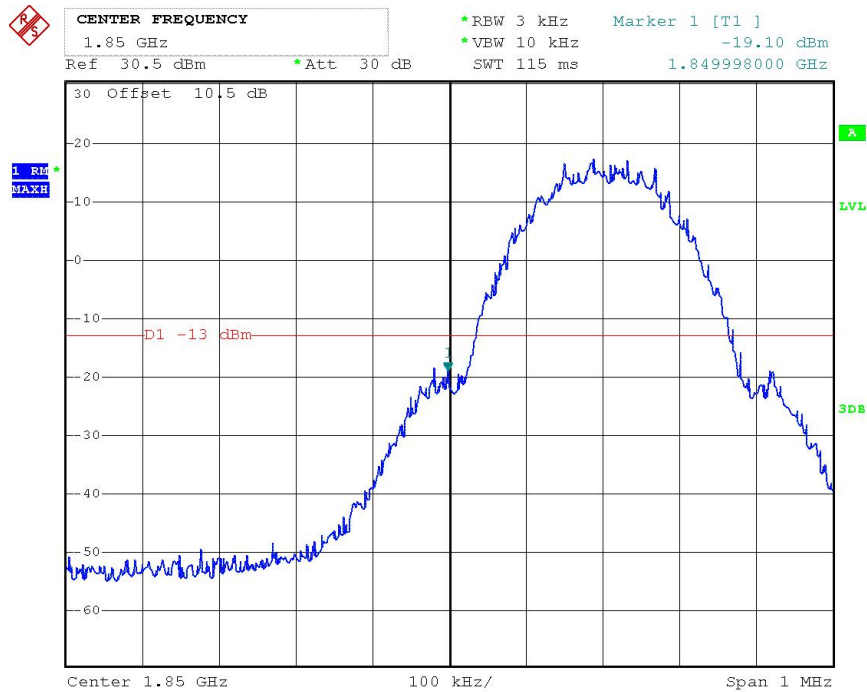

Lowest channel

PCS1900

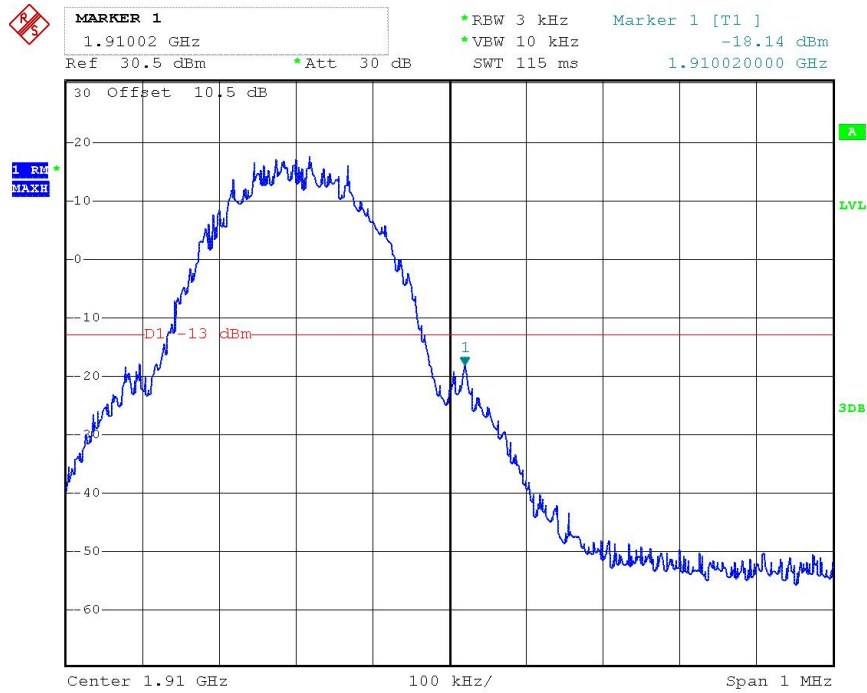

Highest channel

**WCDMA Band II**

Channel	Emission (dBm)	Limit (dBm)	Verdict
4132	-27.92	-13	Pass
4233	-20.01	-13	Pass

**WCDMA Band V**

Channel	Emission (dBm)	Limit (dBm)	Verdict
9262	-20.16	-13	Pass
9538	-22.21	-13	Pass

**WCDMA Band II**

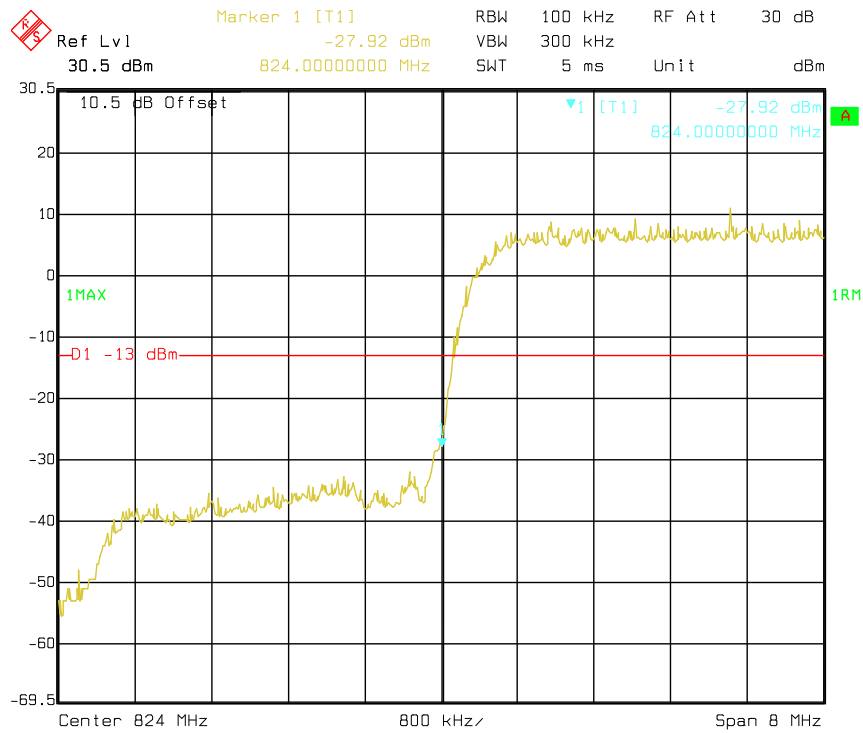

Lowest channel



WCDMA Band II

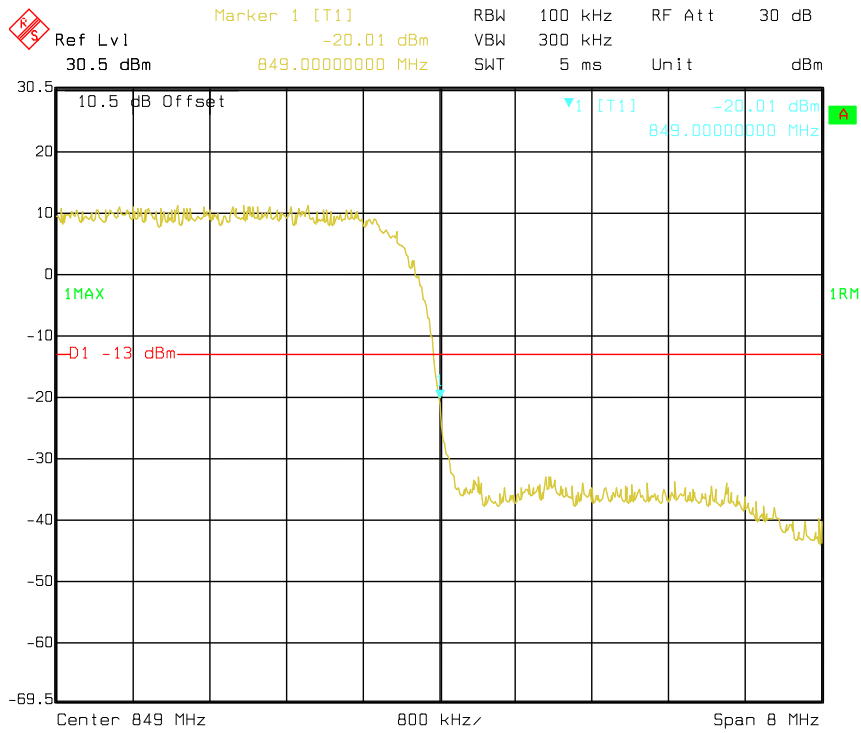

Highest channel

WCDMA Band V

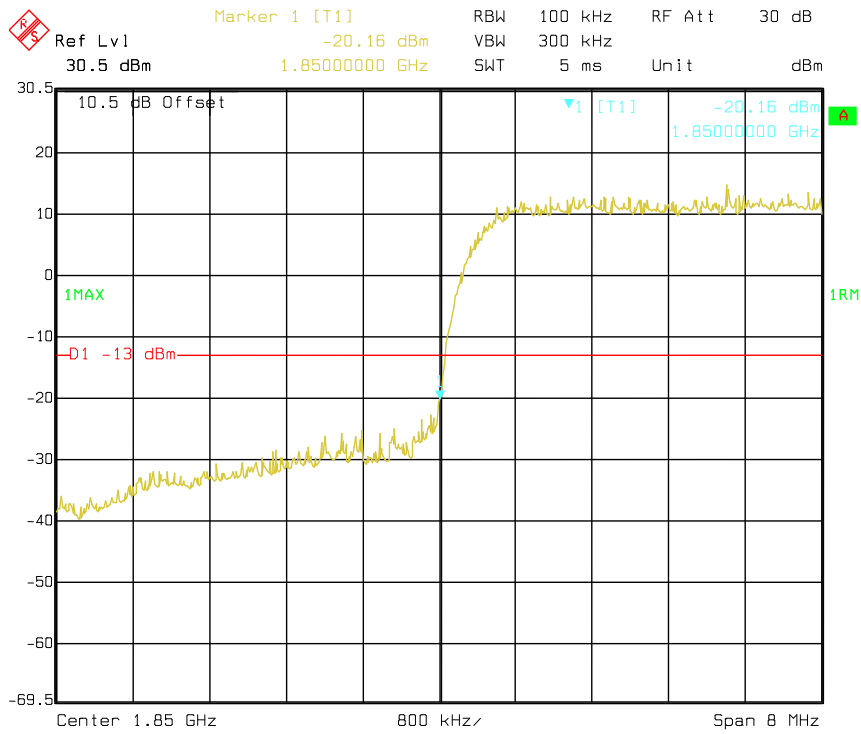

Lowest channel

WCDMA Band V

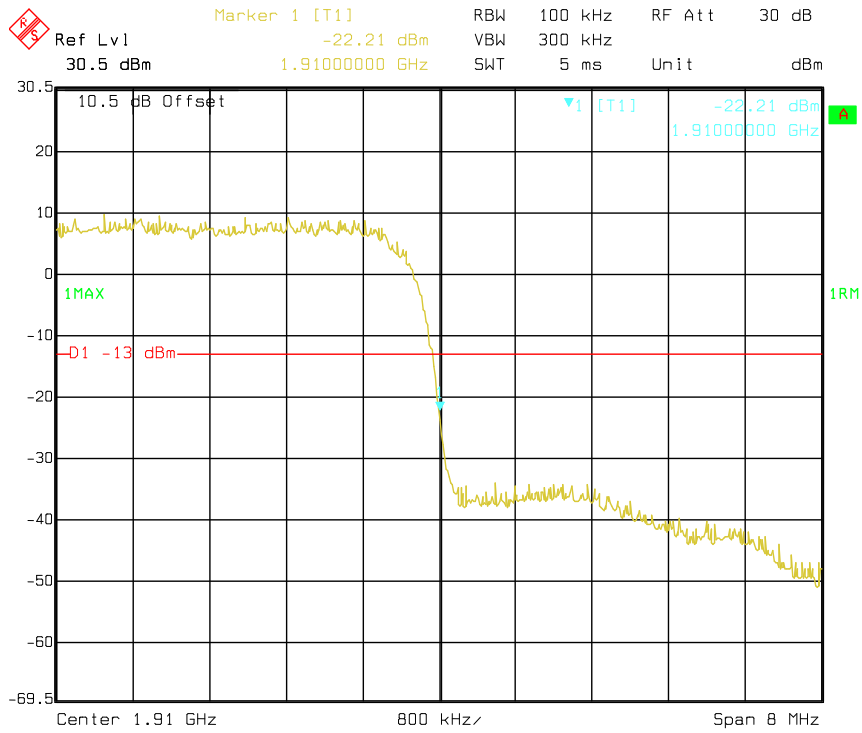

Highest channel

### 9. ERP, EIRP MEASUREMENT

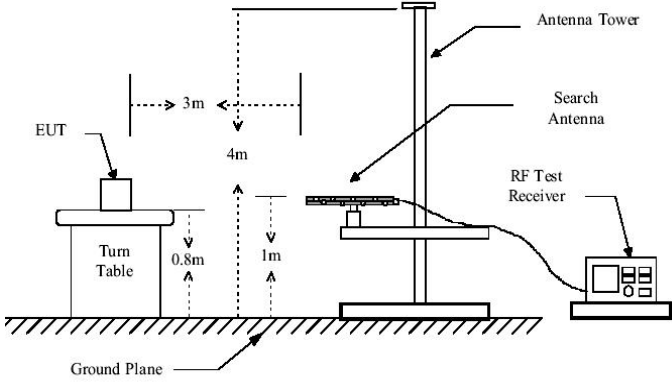
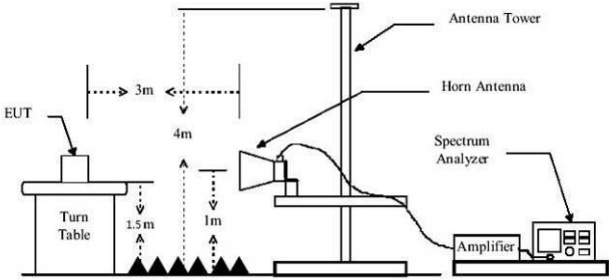
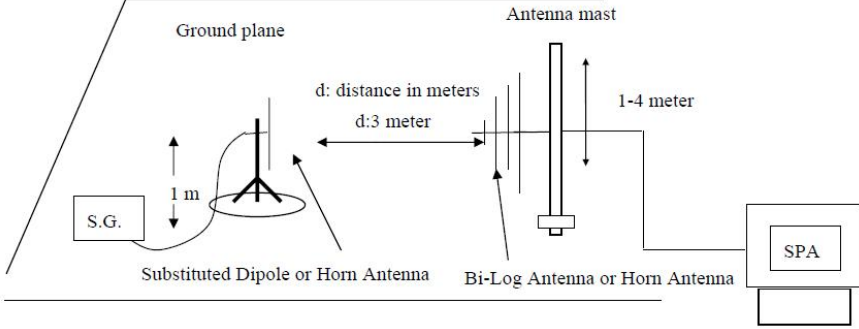
Test Requirement:	FCC part22.913(a) and FCC part24.232(b)
Test Method:	FCC part2.1046
Limit:	GSM850, WCDMA Band V: 7W PCS1900, WCDMA Band II: 2W
Test setup:	<p>Below 1GHz</p>  <p>Above 1GHz</p>  <p>Substituted method:</p> 

Test Procedure:	<ol style="list-style-type: none"> <li>1. The EUT was placed on an non-conductive turntable using a non-conductive support. The radiated emission at the fundamental frequency was measured at 3 m with a test antenna and EMI spectrum analyzer.</li> <li>2. During the measurement, the EUT was communication with the station. The highest emission was recorded with the rotation of the turntable and the lowering of the test antenna from 4m to 1m. The reading was recorded and the field strength (E in dBuV/m) was calculated.</li> <li>3. ERP in frequency band 824.2 –848.80.8MHz were measured using a substitution method. The EUT was replaced by dipole antenna connected, the S.G. output was recorded and ERP was calculated asfollows:  <math display="block">\text{ERP} = \text{S.G. output (dBm)} + \text{Antenna Gain (dBd)} - \text{Cable Loss (dB)}</math> </li> <li>4. EIRP in frequency band 1850.2 –1909.8MHz were measured using a substitution method. The EUT was replaced by or horn antenna connected, the S.G. output was recorded and EIRP was calculated as follows:  <math display="block">\text{EIRP} = \text{S.G. output (dBm)} + \text{Antenna Gain (dBi)} - \text{Cable Loss (dB)}</math> </li> </ol>
Test Instruments:	Refer to section 1.7 for details
Test mode:	Refer to section 1.2 for details
Test results:	Pass

## Measurement Data

Mode	Channel	Antenna Pol.	ERP	Limit (dBm)	Result
GSM850 (GMSK)	128	V	32.25	38.45	Pass
		H	31.36		
	190	V	32.92		
		H	31.96		
	251	V	31.87		
		H	32.10		
GSM850 (GPRS)	128	V	31.86	38.45	Pass
		H	32.25		
	190	V	31.95		
		H	32.32		
	251	V	31.85		
		H	31.78		
GSM850 (EGPRS)	128	V	26.23	38.45	Pass
		H	25.16		
	190	V	26.19		
		H	26.55		
	251	V	25.08		
		H	25.58		

Mode	Channel	Antenna Pol.	EIRP	Limit (dBm)	Result
PCS1900 (GMSK)	512	V	29.04	33.00	Pass
		H	28.97		
	661	V	29.46		
		H	28.51		
	810	V	28.05		
		H	29.23		
PCS1900 (GPRS)	512	V	28.52	33.00	Pass
		H	29.38		
	661	V	28.94		
		H	29.32		
	810	V	28.30		
		H	24.15		
PCS1900 (EGPRS)	512	V	26.24	33.00	Pass
		H	25.20		
	661	V	26.06		
		H	25.03		
	810	V	24.15		
		H	26.20		

Mode	Channel	Antenna Pol.	EIRP	Limit (dBm)	Result
WCDMA Band II (QPSK)	9262	V	23.66	33.00	Pass
		H	22.98		
	9400	V	23.72		
		H	22.77		
	9538	V	22.96		
		H	23.87		

Mode	Channel	Antenna Pol.	ERP	Limit (dBm)	Result
WCDMA Band V (QPSK)	4132	V	22.07	38.45	Pass
		H	21.39		
	4183	V	21.42		
		H	22.06		
	4233	V	22.14		
		H	21.89		

### 10. FIELD STRENGTH OF SPURIOUS RADIATION MEASUREMENT

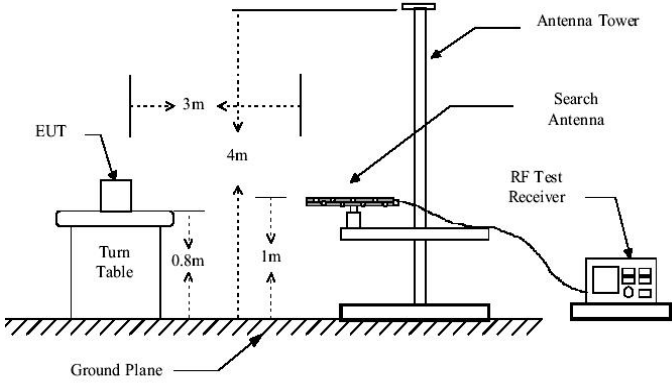
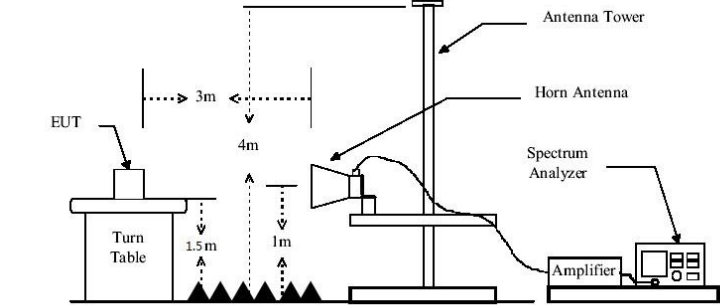
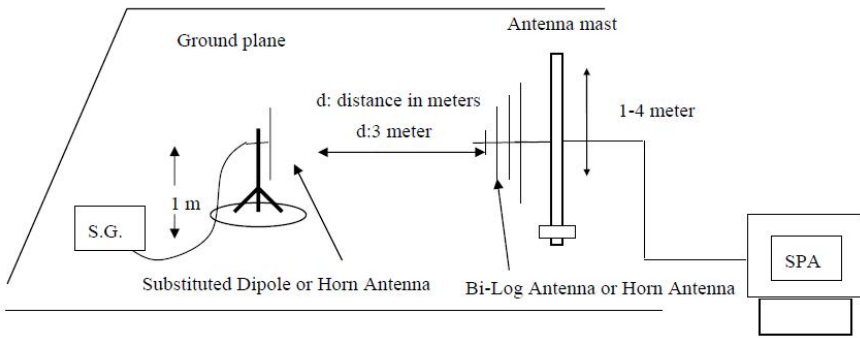
<p>Test Requirement:</p>	<p>FCC part22.917(a) and FCC part24.238(a)</p>
<p>Test Method:</p>	<p>FCC part2.1053</p>
<p>Limit:</p>	<p>-13dBm</p>
<p>Test setup:</p>	<p>Below 1GHz</p>  <p>Above 1GHz</p>  <p>Substituted method:</p> 



Test Procedure:	<ol style="list-style-type: none"> <li>1. The EUT was placed on an non-conductive turntable using a non-conductive support. The radiated emission at the fundamental frequency was measured at 3 m with a test antenna and EMI spectrum analyzer.</li> <li>2. During the tests, the antenna height and the EUT azimuth were varied in order to identify the maximum level of emissions from the EUT. This maximization process was repeated with the EUT positioned in each of its three orthogonal orientations.</li> <li>3. The frequency range up to tenth harmonic was investigated for each of three fundamental frequency (low, middle and high channels). Once spurious emission was identified, the power of the emission was determined using the substitution method.</li> <li>4. The spurious emissions attenuation was calculated as the difference between radiated power at the fundamental frequency and the spurious emissions frequency.  <math display="block">\text{ERP / EIRP} = \text{S.G. output (dBm)} + \text{Antenna Gain(dB/dBi)} - \text{Cable Loss (dB)}</math> <math display="block">\text{Level} = \text{Reading} + \text{Correct Factor.}</math> <math display="block">\text{Correct Factor} = \text{Ant. Factor} + \text{Cable Loss} - \text{Ampl. Gain.}</math> </li> </ol>
Test Instruments:	Refer to section 1.7 for details
Test mode:	Refer to section 1.2 for details
Test results:	Pass

## Measurement Data

<b>Test mode:</b>	<b>GSM850</b>				<b>Test channel:</b>	<b>Lowest</b>
Frequency (MHz)	Spurious Emission				Limit (dBm)	Result
	Reading(dBm)	Factor ( dB )	Level (dBm)	Polarization		
1648.40	-56.08	3.56	-52.52	Vertical	-13.00	Pass
2472.60	-55.10	3.47	-51.63	V		
3296.80	-52.76	4.25	-48.51	V		
4121.00	-50.87	5.62	-45.25	V		
4945.20	-50.32	6.38	-43.94	V		
1648.40	-56.14	3.56	-52.58	Horizontal	-13.00	Pass
2472.60	-55.10	3.47	-51.63	H		
3296.80	-53.09	4.25	-48.84	H		
4121.00	-52.20	5.62	-46.58	H		
4945.20	-47.60	6.38	-41.22	H		
<b>Test mode:</b>	<b>GSM850</b>				<b>Test channel:</b>	<b>Middle</b>
Frequency (MHz)	Spurious Emission				Limit (dBm)	Result
	Reading(dBm)	Factor ( dB )	Level (dBm)	Polarization		
1673.20	-55.72	3.47	-52.25	Vertical	-13.00	Pass
2509.80	-55.33	3.65	-51.68	V		
3346.40	-53.19	4.67	-48.52	V		
4183.00	-51.22	5.87	-45.35	V		
5019.60	-48.68	6.47	-42.21	V		
1673.20	-56.95	3.47	-53.48	Horizontal	-13.00	Pass
2509.80	-56.61	3.65	-52.96	H		
3346.40	-53.02	4.67	-48.35	H		
4183.00	-51.09	5.87	-45.22	H		
5019.60	-49.73	6.47	-43.26	H		
<b>Test mode:</b>	<b>GSM850</b>				<b>Test channel:</b>	<b>Highest</b>
Frequency (MHz)	Spurious Emission				Limit (dBm)	Result
	Reading(dBm)	Factor ( dB )	Level (dBm)	Polarization		
1697.60	-57.10	3.74	-53.36	Vertical	-13.00	Pass
2546.40	-55.14	3.89	-51.25	V		
3395.20	-51.42	4.58	-46.84	V		
4244.00	-51.66	5.71	-45.95	V		
5092.80	-50.51	6.89	-43.62	V		
1697.60	-56.59	3.74	-52.85	Horizontal	-13.00	Pass
2546.40	-54.03	3.89	-50.14	H		
3395.20	-52.83	4.58	-48.25	H		
4244.00	-49.32	5.71	-43.61	H		
5092.80	-47.14	6.89	-40.25	H		

## Remark :

1. The emission behaviour belongs to narrowband spurious emission.
2. Remark"---" means that the emission level is too low to be measured
3. The emission levels of below 1 GHz are very lower than the limit and not show in test report.

<b>Test mode:</b>	<b>PCS1900</b>				<b>Test channel:</b>	<b>Lowest</b>
Frequency (MHz)	Spurious Emission				Limit (dBm)	Result
	Reading(dBm)	Factor (dB)	Level (dBm)	Polarization		
3700.40	-57.81	4.56	-53.25	Vertical	-13.00	Pass
5550.60	-57.15	6.52	-50.63	V		
7400.80	-56.09	8.57	-47.52	V		
9251.00	-54.13	9.62	-44.51	V		
11101.20	-53.32	10.48	-42.84	V		
3700.40	-58.14	4.56	-53.58	Horizontal	-13.00	Pass
5550.60	-58.48	6.52	-51.96	H		
7400.80	-55.82	8.57	-47.25	H		
9251.00	-53.87	9.62	-44.25	H		
11101.20	-52.62	10.48	-42.14	H		
<b>Test mode:</b>	<b>PCS1900</b>				<b>Test channel:</b>	<b>Middle</b>
Frequency (MHz)	Spurious Emission				Limit (dBm)	Result
	Reading(dBm)	Factor (dB)	Level (dBm)	Polarization		
3760.00	-57.87	4.62	-53.25	Vertical	-13.00	Pass
5640.00	-57.65	5.69	-51.96	V		
7520.00	-56.04	8.20	-47.84	V		
9400.00	-55.17	9.66	-45.51	V		
11280.00	-52.71	10.47	-42.24	V		
3760.00	-58.24	4.62	-53.62	Horizontal	-13.00	Pass
5640.00	-57.04	5.69	-51.35	H		
7520.00	-55.41	8.20	-47.21	H		
9400.00	-54.5	9.66	-44.84	H		
11280.00	-53.43	10.47	-42.96	H		
<b>Test mode:</b>	<b>PCS1900</b>				<b>Test channel:</b>	<b>Highest</b>
Frequency (MHz)	Spurious Emission				Limit (dBm)	Result
	Reading(dBm)	Factor (dB)	Level (dBm)	Polarization		
3819.60	-56.05	3.47	-52.58	Vertical	-13.00	Pass
5729.40	-56.53	5.89	-50.64	V		
7639.20	-57.32	8.47	-48.85	V		
9549.00	-54.85	9.90	-44.95	V		
11458.80	-52.87	10.24	-42.63	V		
3819.60	-56.99	3.47	-53.52	Horizontal	-13.00	Pass
5729.40	-56.03	5.89	-50.14	H		
7639.20	-55.72	8.47	-47.25	H		
9549.00	-54.11	9.90	-44.21	H		
11458.80	-52.25	10.24	-42.01	H		

Remark:

1. The emission behaviour belongs to narrowband spurious emission.
2. Remark"---" means that the emission level is too low to be measured
3. The emission levels of below 1 GHz are very lower than the limit and not show in test report.

<b>Test mode:</b>	<b>WCDMA Band V</b>				<b>Test channel:</b>	<b>Lowest</b>
Frequency (MHz)	Spurious Emission				Limit (dBm)	Result
	Reading(dBm)	Factor ( dB )	Level (dBm)	Polarization		
1652.80	-57.10	3.47	-53.63	Vertical	-13.00	Pass
2479.20	-55.98	3.62	-52.36	V		
3305.60	-51.10	3.52	-47.58	V		
4132.00	-49.16	4.20	-44.96	V		
4958.40	-46.35	5.10	-41.25	V		
1652.80	-57.01	3.47	-53.54	Horizontal	-13.00	Pass
2479.20	-54.43	3.62	-50.81	H		
3305.60	-51.11	3.52	-47.59	H		
4132.00	-48.83	4.20	-44.63	H		
4958.40	-47.64	5.10	-42.54	H		
<b>Test mode:</b>	<b>WCDMA Band V</b>				<b>Test channel:</b>	<b>Middle</b>
Frequency (MHz)	Spurious Emission				Limit (dBm)	Result
	Reading(dBm)	Factor ( dB )	Level (dBm)	Polarization		
1672.80	-57.22	3.26	-53.96	Vertical	-13.00	Pass
2509.20	-54.99	3.47	-51.52	V		
3345.60	-51.40	3.26	-48.14	V		
4182.00	-49.80	4.28	-45.52	V		
5018.40	-47.84	5.21	-42.63	V		
1672.80	-56.51	3.26	-53.25	Horizontal	-13.00	Pass
2509.20	-54.72	3.47	-51.25	H		
3345.60	-51.20	3.26	-47.94	H		
4182.00	-48.96	4.28	-44.68	H		
5018.40	-47.73	5.21	-42.52	H		
<b>Test mode:</b>	<b>WCDMA Band V</b>				<b>Test channel:</b>	<b>Highest</b>
Frequency (MHz)	Spurious Emission				Limit (dBm)	Result
	Reading(dBm)	Factor ( dB )	Level (dBm)	Polarization		
1693.20	-56.69	3.44	-53.25	Vertical	-13.00	Pass
2539.80	-55.56	3.62	-51.94	V		
3386.40	-52.48	3.85	-48.63	V		
4233.00	-49.53	4.02	-45.51	V		
5079.60	-46.47	5.22	-41.25	V		
1693.20	-55.44	3.44	-52.00	Horizontal	-13.00	Pass
2539.80	-54.87	3.62	-51.25	H		
3386.40	-51.20	3.85	-47.35	H		
4233.00	-48.23	4.02	-44.21	H		
5079.60	-47.80	5.22	-42.58	H		

Remark :

1. The emission behaviour belongs to narrowband spurious emission.
2. Remark"---" means that the emission level is too low to be measured
3. The emission levels of below 1 GHz are very lower than the limit and not show in test report.

<b>Test mode:</b>	<b>WCDMA Band II</b>				<b>Test channel:</b>	<b>Lowest</b>
Frequency (MHz)	Spurious Emission				Limit (dBm)	Result
	Reading(dBm)	Factor ( dB )	Level (dBm)	Polarization		
3704.80	-57.88	4.25	-53.63	Vertical	-13.00	Pass
5557.20	-57.57	5.62	-51.95	V		
7409.60	-54.77	7.52	-47.25	V		
9262.00	-54.11	9.63	-44.48	V		
11114.40	-53.05	10.47	-42.58	V		
3704.80	-57.90	4.25	-53.65	Horizontal	-13.00	Pass
5557.20	-55.98	5.62	-50.36	H		
7409.60	-54.77	7.52	-47.25	H		
9262.00	-53.78	9.63	-44.15	H		
11114.40	-52.72	10.47	-42.25	H		
<b>Test mode:</b>	<b>WCDMA Band II</b>				<b>Test channel:</b>	<b>Middle</b>
Frequency (MHz)	Spurious Emission				Limit (dBm)	Result
	Reading(dBm)	Factor ( dB )	Level (dBm)	Polarization		
3760.00	-57.77	4.14	-53.63	Vertical	-13.00	Pass
5640.00	-57.36	5.84	-51.52	V		
7520.00	-56.08	7.24	-48.84	V		
9400.00	-55.31	9.36	-45.95	V		
11280.00	-53.44	10.81	-42.63	V		
3760.00	-57.65	4.14	-53.51	Horizontal	-13.00	Pass
5640.00	-56.09	5.84	-50.25	H		
7520.00	-54.45	7.24	-47.21	H		
9400.00	-54.37	9.36	-45.01	H		
11280.00	-53.06	10.81	-42.25	H		
<b>Test mode:</b>	<b>WCDMA Band II</b>				<b>Test channel:</b>	<b>Highest</b>
Frequency (MHz)	Spurious Emission				Limit (dBm)	Result
	Reading(dBm)	Factor ( dB )	Level (dBm)	Polarization		
3815.20	-57.10	3.74	-53.36	Vertical	-13.00	Pass
5722.80	-54.26	4.01	-50.25	V		
7630.40	-55.73	7.25	-48.48	V		
9538.00	-54.31	9.35	-44.96	V		
11445.60	-53.43	10.58	-42.85	V		
3815.20	-56.88	3.74	-53.14	Horizontal	-13.00	Pass
5722.80	-54.26	4.01	-50.25	H		
7630.40	-54.88	7.25	-47.63	H		
9538.00	-54.87	9.35	-45.52	H		
11445.60	-52.72	10.58	-42.14	H		

Remark :

1. The emission behaviour belongs to narrowband spurious emission.
2. Remark"---" means that the emission level is too low to be measured
3. The emission levels of below 1 GHz are very lower than the limit and not show in test report.

## 11. FREQUENCY STABILITY V.S. TEMPERATURE MEASUREMENT

Test Requirement:	FCC Part2.1055(a)(1)(b)
Test Method:	FCC Part2.1055(a)(1)(b)
Limit:	2.5ppm
Test setup:	<div style="text-align: center;"> <p style="text-align: center;">Temperature Chamber</p> <p style="text-align: center;">Spectrum analyzer</p> <p style="text-align: center;">Att.</p> <p style="text-align: center;">EUT</p> <p style="text-align: center;">Variable Power Supply</p> </div> <p><b>Note :</b> Measurement setup for testing on Antenna connector</p>
Test procedure:	<ol style="list-style-type: none"> <li>1. The equipment under test was connected to an external DC power supply and input rated voltage.</li> <li>2. RF output was connected to a frequency counter or spectrum analyzer via feed through attenuators.</li> <li>3. The EUT was placed inside the temperature chamber.</li> <li>4. Set the spectrum analyzer RBW low enough to obtain the desired frequency resolution and measure EUT 25°C operating frequency as reference frequency.</li> <li>5. Turn EUT off and set the chamber temperature to -20°C. After the temperature stabilized for approximately 30 minutes recorded the frequency.</li> <li>6. Repeat step measure with 10°C increased per stage until the highest temperature of +50°C reached.</li> </ol>
Test Instruments:	Refer to section 1.7 for details
Test mode:	Refer to section 1.2 for details
Test results:	Pass

Measurement Data

<b>Reference Frequency: GSM850 (GSM link) Middle channel=190 channel=836.6MHz</b>					
Power supplied (Vdc)	Temperature (°C)	Frequency error		Limit (ppm)	Result
		Hz	ppm		
3.70	-30	6.6	0.008	2.5	Pass
	-20	8.3	0.010		
	-10	9.9	0.012		
	0	5.6	0.007		
	10	3.8	0.005		
	20	6.5	0.008		
	30	4.8	0.006		
	40	3.5	0.004		
	50	6.6	0.008		

<b>Reference Frequency: PCS1900 (GSM link) Middle channel=661 channel=1880MHz</b>					
Power supplied (Vdc)	Temperature (°C)	Frequency error		Limit (ppm)	Result
		Hz	ppm		
3.70	-30	6.6	0.004	2.5	Pass
	-20	9.3	0.005		
	-10	5.6	0.003		
	0	3.5	0.002		
	10	5.8	0.003		
	20	6.5	0.003		
	30	6.4	0.003		
	40	5.2	0.003		
	50	8.5	0.005		

<b>Reference Frequency: WCDMA Band V Middle channel=4183 channel=836.6MHz</b>					
Power supplied (Vdc)	Temperature (°C)	Frequency error		Limit (ppm)	Result
		Hz	ppm		
3.70	-30	5.6	0.007	2.5	Pass
	-20	8.3	0.010		
	-10	6.5	0.008		
	0	8.6	0.010		
	10	4.3	0.005		
	20	2.6	0.003		
	30	5.8	0.007		
	40	6.5	0.008		
	50	7.2	0.009		
<b>Reference Frequency: WCDMA Band II Middle channel=9400 channel=1880.0MHz</b>					
Power supplied (Vdc)	Temperature (°C)	Frequency error		Limit (ppm)	Result
		Hz	ppm		
3.70	-30	6.6	0.004	2.5	Pass
	-20	5.3	0.003		
	-10	6.2	0.003		
	0	4.5	0.002		
	10	5.2	0.003		
	20	6.1	0.003		
	30	5.4	0.003		
	40	3.5	0.002		
	50	4.8	0.003		



## 12. FREQUENCY STABILITY V.S. VOLTAGE MEASUREMENT

Test Requirement:	FCC Part2.1055(d)(1)(2)
Test Method:	FCC Part2.1055(d)(1)(2)
Limit:	2.5ppm
Test setup:	<div style="text-align: center;"> <p>The diagram shows a block labeled 'Spectrum analyzer' on the left, connected to a block labeled 'Att.' (Attenuator). The 'Att.' block is connected to the 'EUT' (Equipment Under Test) block, which is located inside a larger box labeled 'Temperature Chamber'. Below the 'EUT' block, a 'Variable Power Supply' block is connected to it.</p> </div> <p><b>Note :</b> Measurement setup for testing on Antenna connector</p>
Test procedure:	<ol style="list-style-type: none"> <li>1. Set chamber temperature to 25°C. Use a variable DC power source to power the EUT and set the voltage to rated voltage.</li> <li>2. Set the spectrum analyzer RBW low enough to obtain the desired frequency resolution and recorded the frequency.</li> <li>3. Reduce the input voltage to specified extreme voltage variation (+/- 15%) and endpoint, record the maximum frequency change.</li> </ol>
Test Instruments:	Refer to section 1.7 for details
Test mode:	Refer to section 1.2 for details
Test results:	Pass

## Measurement Data

Reference Frequency: GSM850 (GSM link) Middle channel=190 channel=836.6MHz					
Temperature (°C)	Power supplied (Vdc)	Frequency error		Limit (ppm)	Result
		Hz	ppm		
25	4.25	5.6	0.007	2.5	Pass
	3.7	3.5	0.004		
	3.4	4.8	0.006		
Reference Frequency: PCS1900 (GSM link) Middle channel=661 channel=1880MHz					
Temperature (°C)	Power supplied (Vdc)	Frequency error		Limit (ppm)	Result
		Hz	ppm		
25	4.25	6.2	0.003	2.5	Pass
	3.7	3.5	0.002		
	3.4	4.6	0.002		
Reference Frequency: WCDMA Band V Middle channel=4183 channel=836.6MHz					
Temperature (°C)	Power supplied (Vdc)	Frequency error		Limit (ppm)	Result
		Hz	ppm		
25	4.25	5.2	0.006	2.5	Pass
	3.7	3.5	0.004		
	3.4	5.3	0.006		
Reference Frequency: WCDMA Band II Middle channel=940 channel=1880.0MHz					
Temperature (°C)	Power supplied (Vdc)	Frequency error		Limit (ppm)	Result
		Hz	ppm		
25	4.25	4.3	0.002	2.5	Pass
	3.7	2.6	0.001		
	3.4	3.2	0.002		

**13. TEST SETUP PHOTO**

---

Radiated Emission

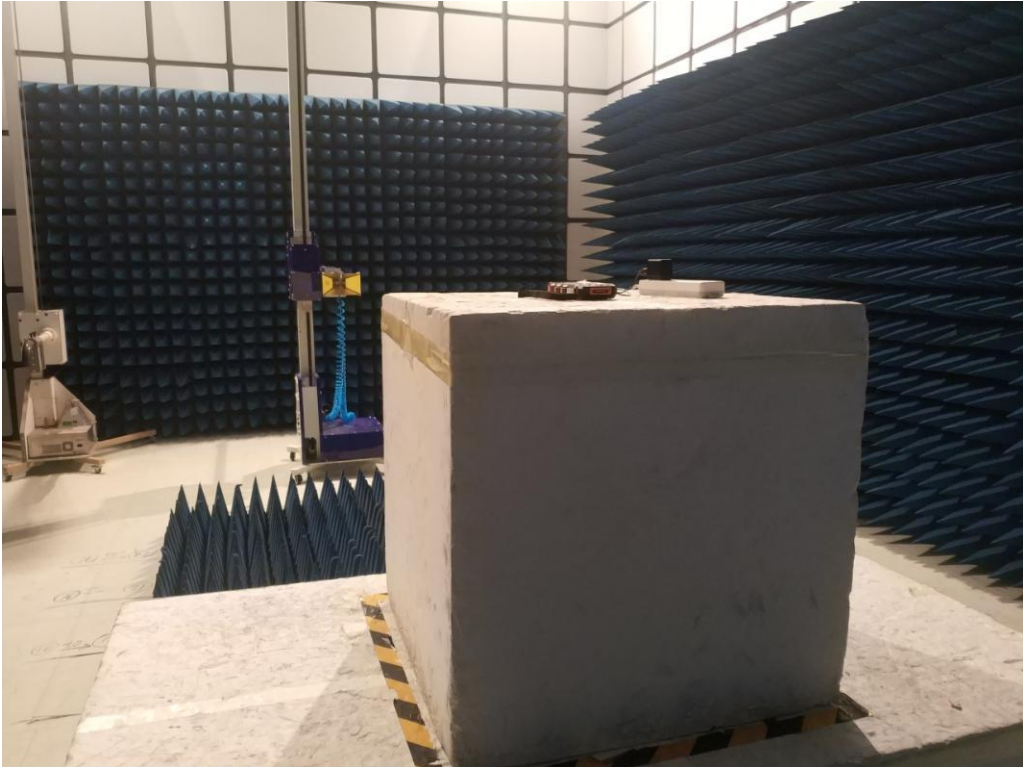
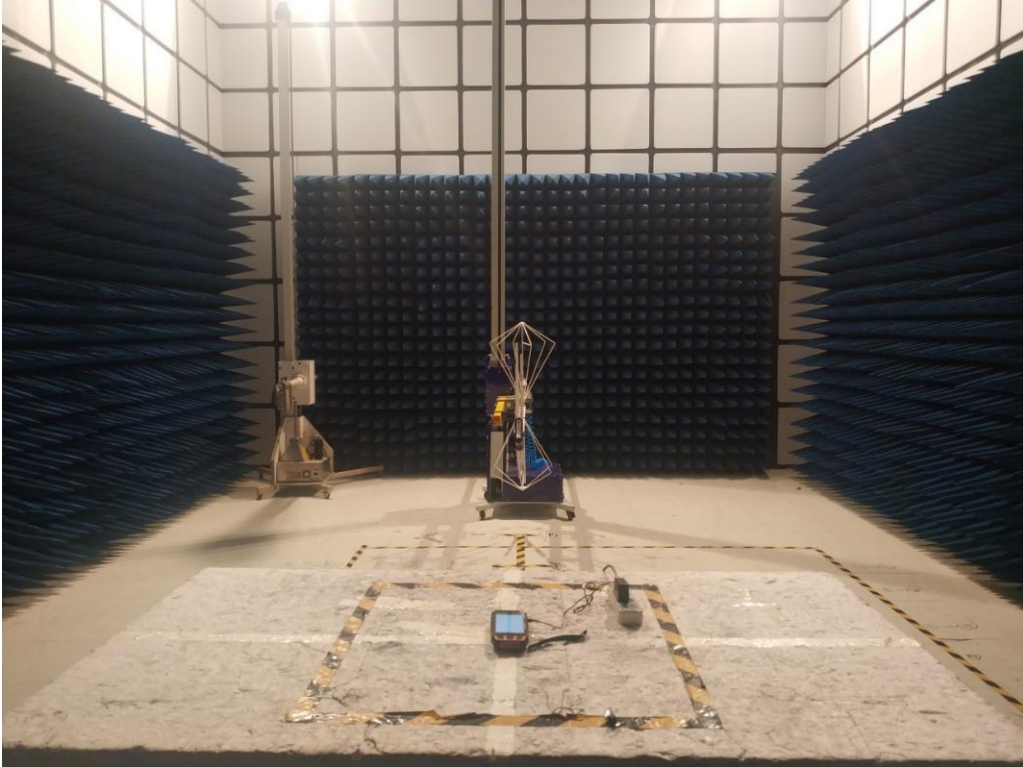

### 14. EUT CONSTRUCTIONAL DETAILS

---

External Photographs:



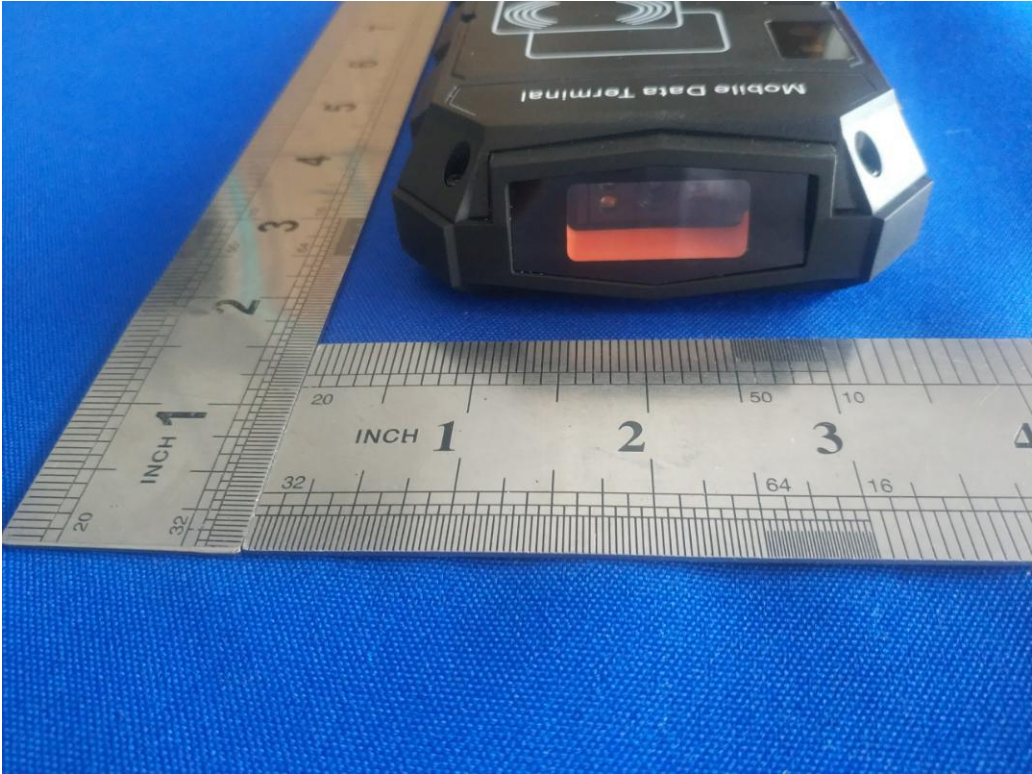

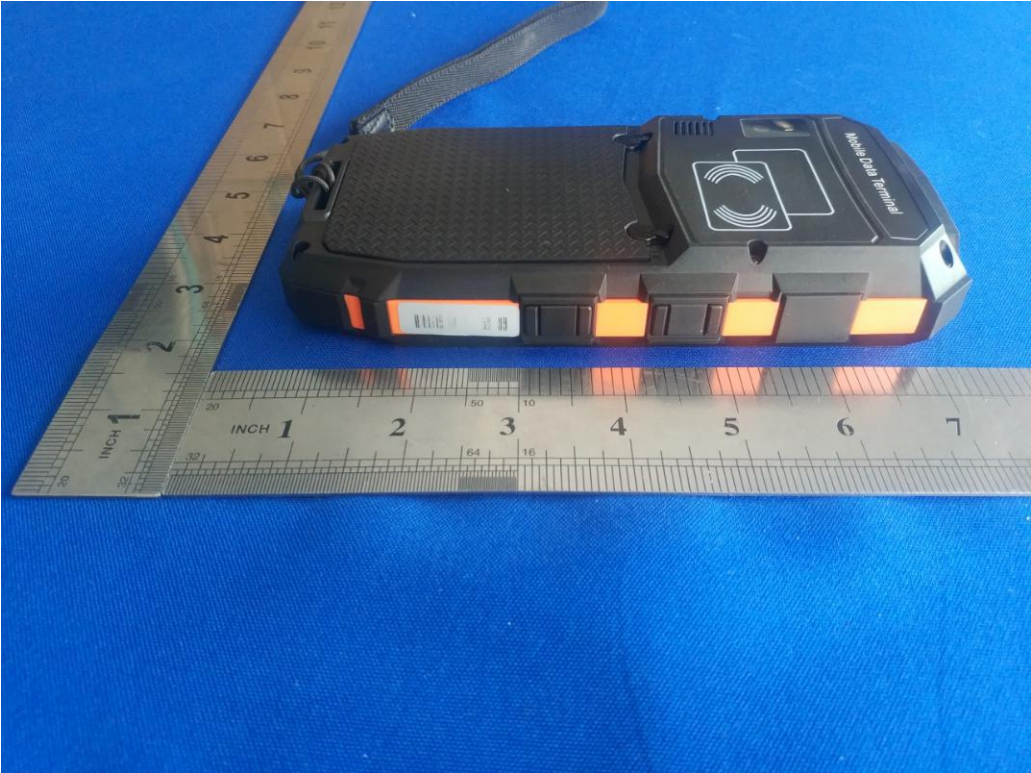



Internal photographs



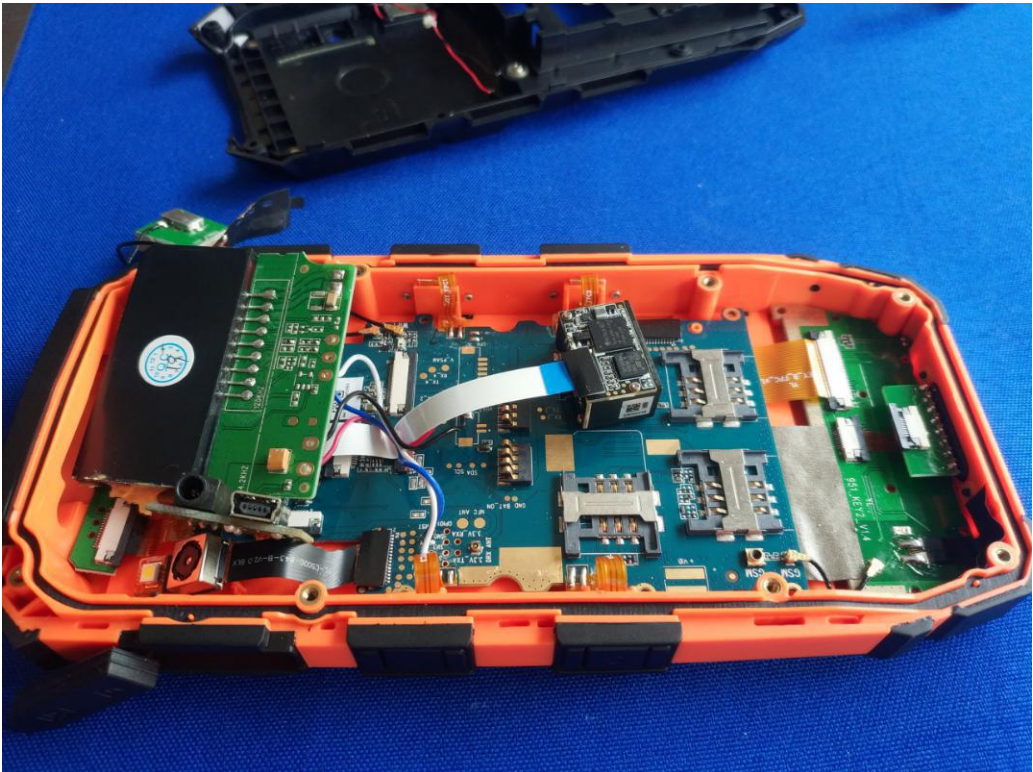



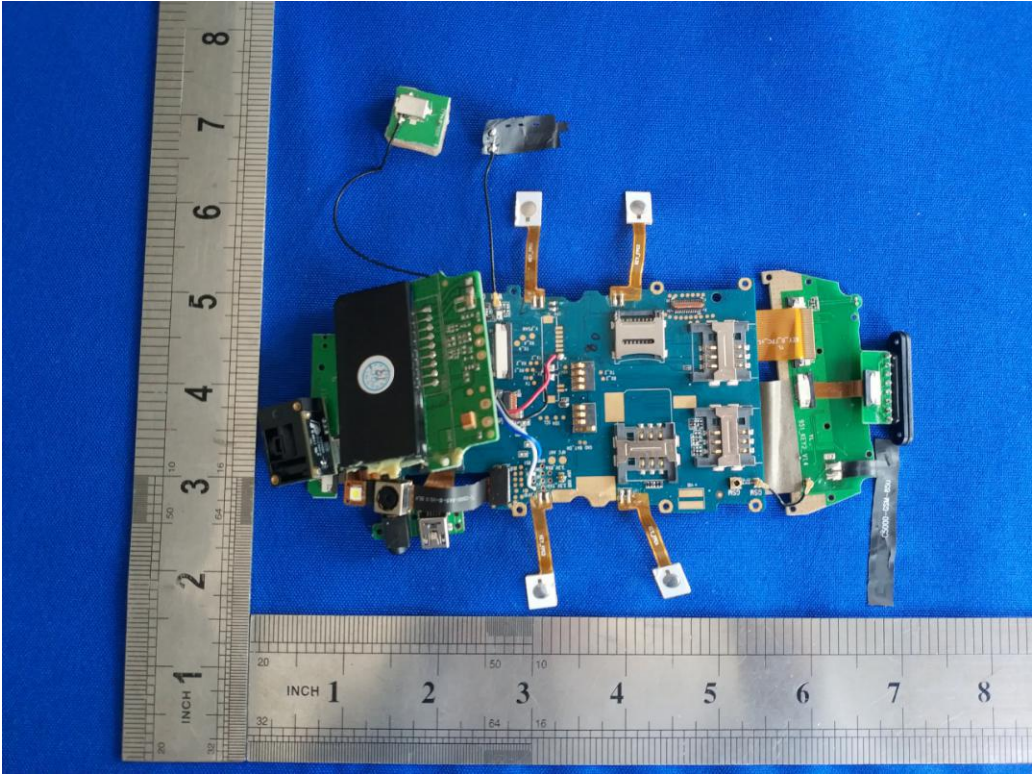

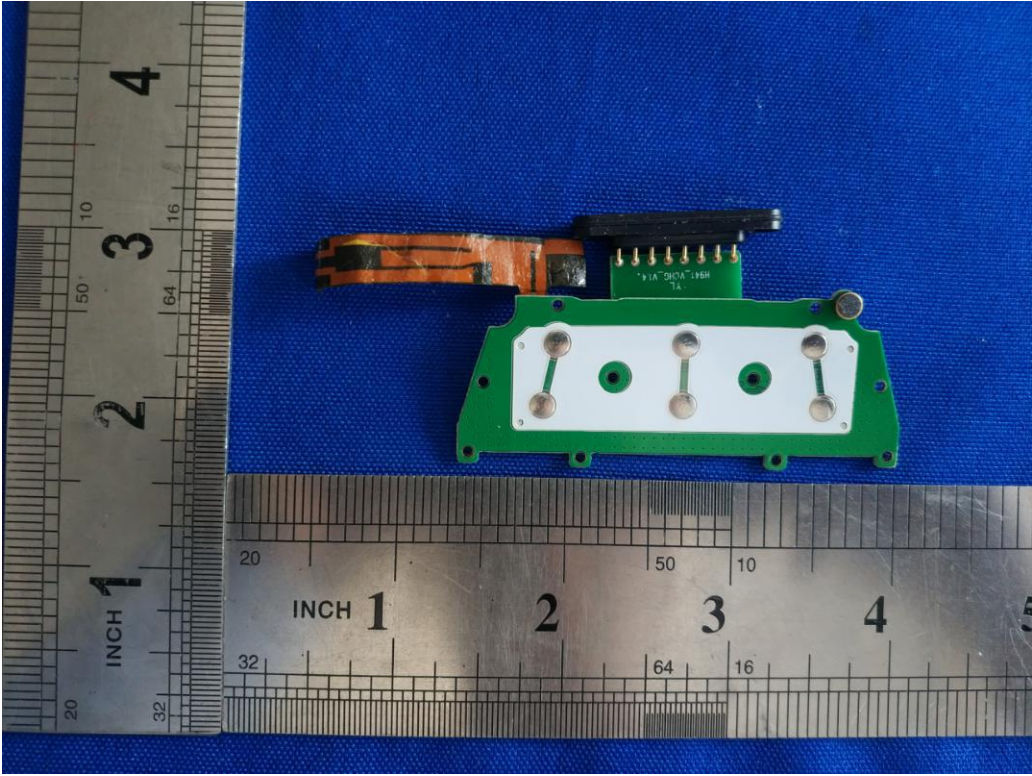
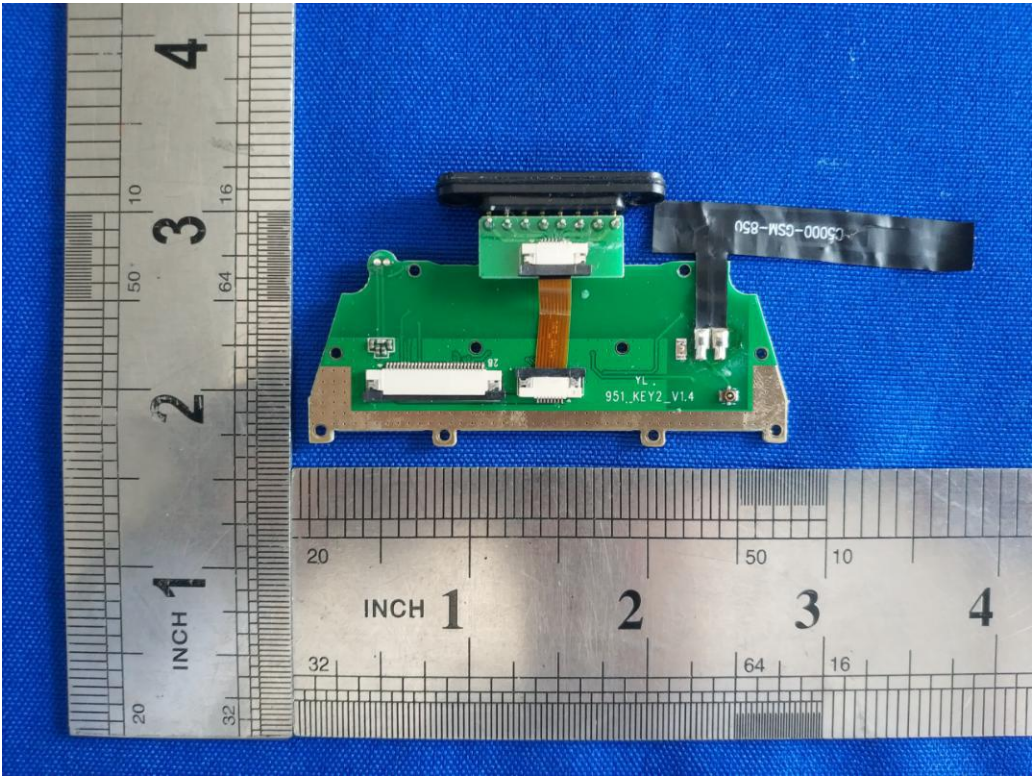

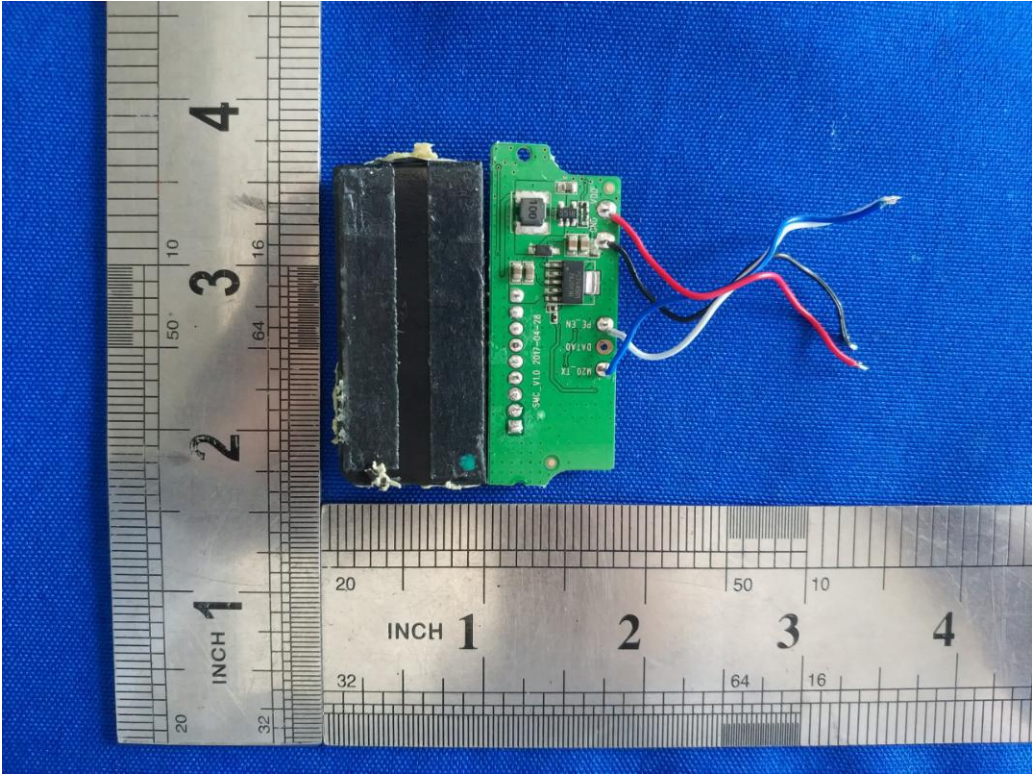
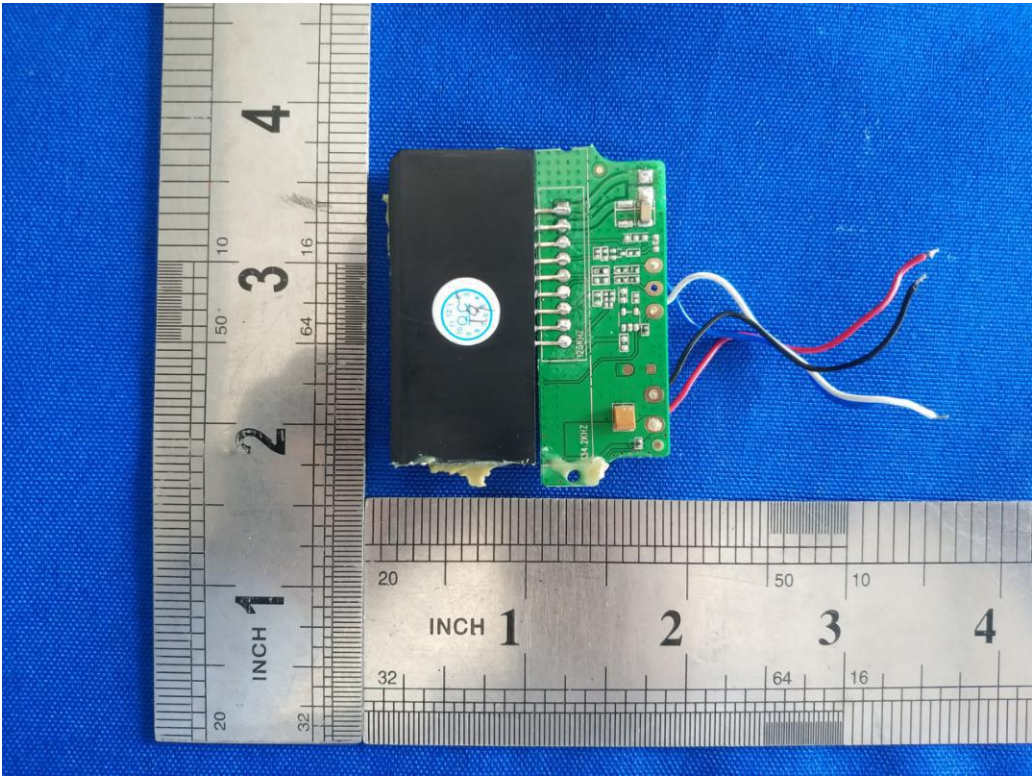

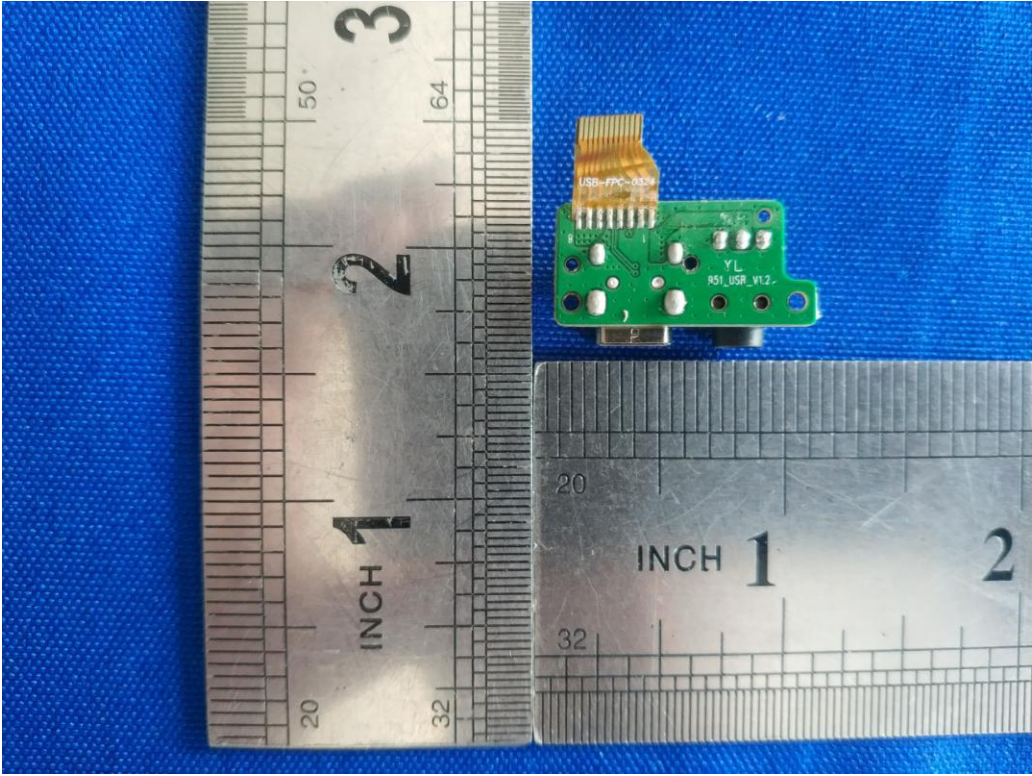
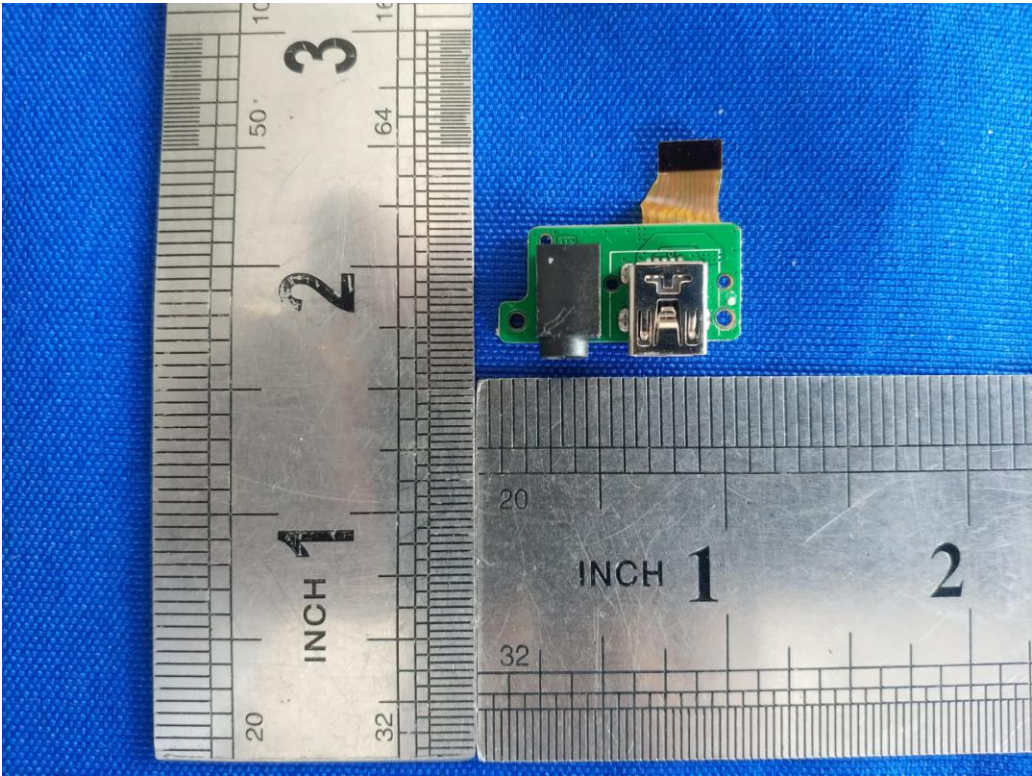

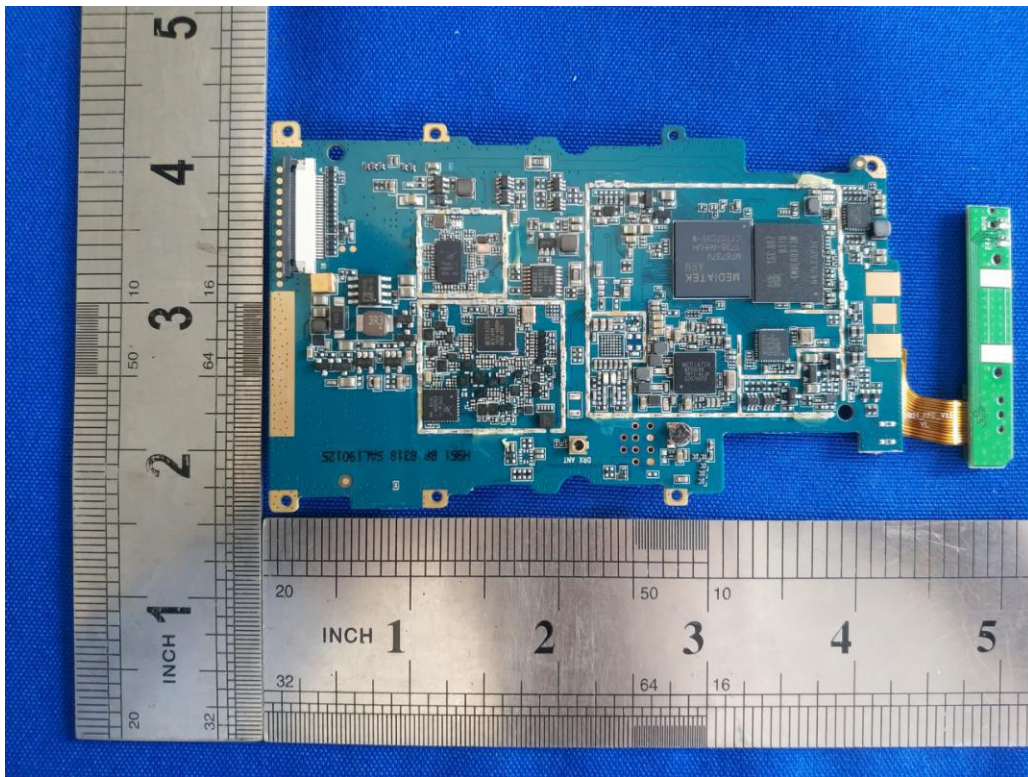
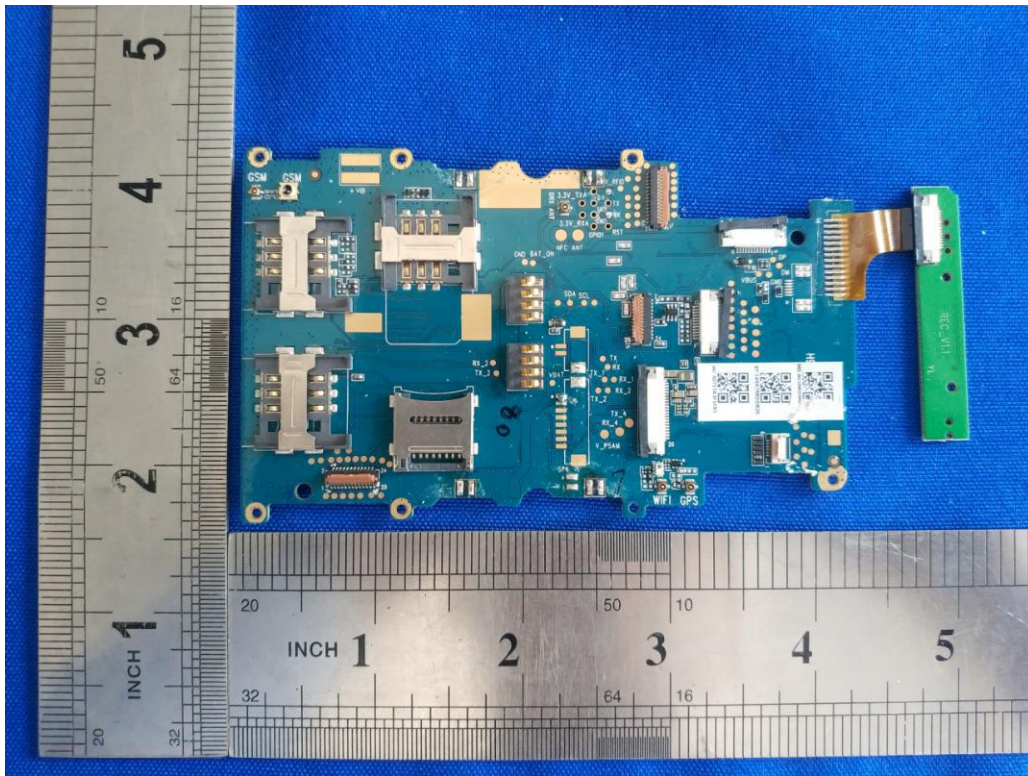

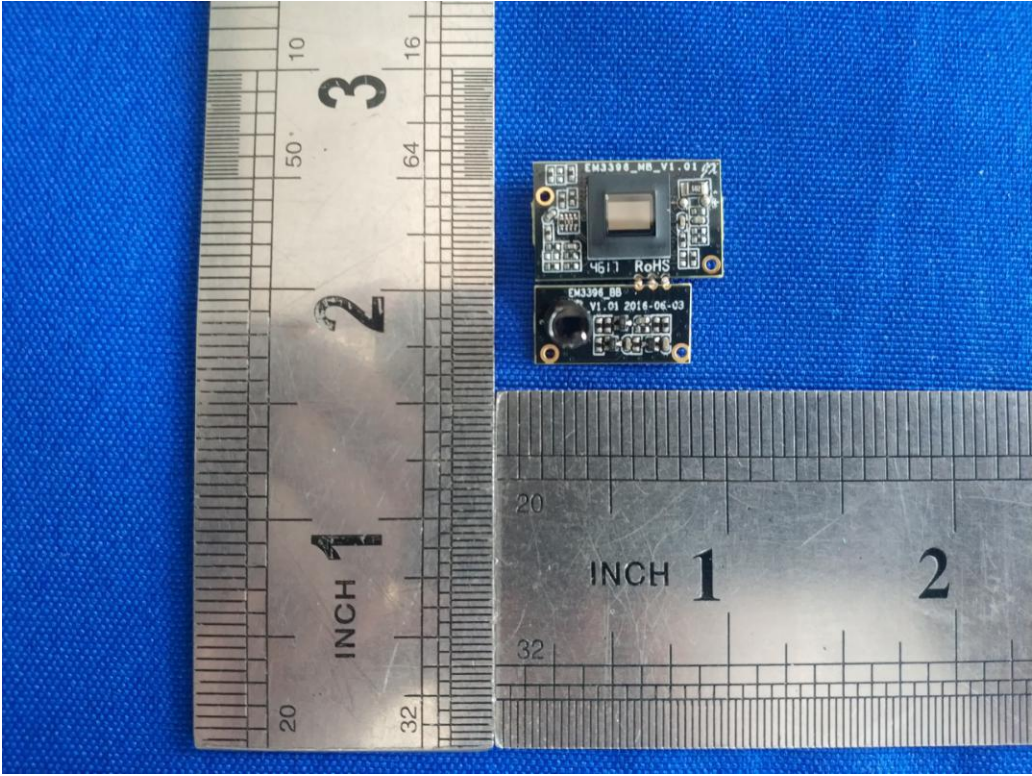
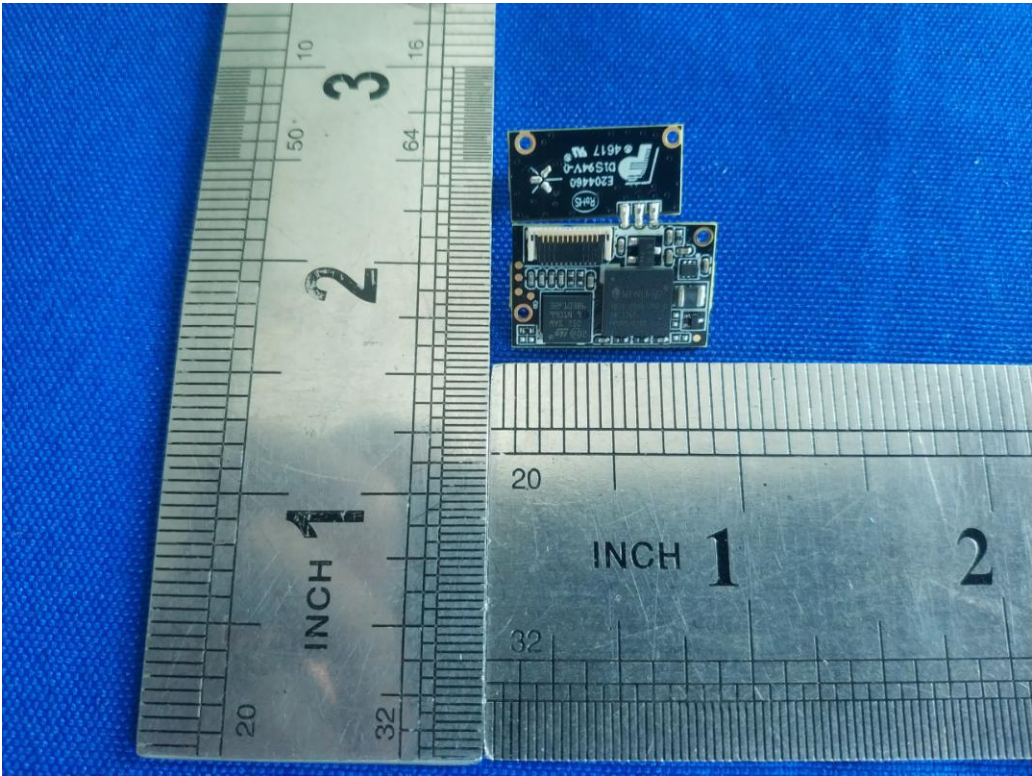

-----End-----