

FCC PART 22/24 TEST REPORT

FCC Part 22 /Part 24 & RSS-132 Issue 3/ RSS-133 Issue 6

Report Reference No..... : LCS1610191262E

FCC ID..... : 2AKEXCDT-901

IC..... : 22167-CDT-901

Date of Issue..... : November 24, 2016

Testing Laboratory Name..... : Shenzhen LCS Compliance Testing Laboratory Ltd.

Address..... : 1/F., Xingyuan Industrial Park, Tongda Road, Bao'an Avenue, Bao'an District, Shenzhen, Guangdong, China

Applicant's name..... : Shenzhen Cenray Technology Co., LTD

Address..... : Room 507, Huashenghui Business Building, Jinhai Road, Xixiang Street, Bao'an, Shenzhen, Guangdong, China

Test specification..... :

FCC Part 22: Public Mobile Services

FCC Part 24: Personal Communication Services

Standard..... : RSS-132 Issue 3: Cellular Telephone Systems Operating in the Bands 824-849 MHz and 869-894 MHz

RSS-133 Issue 6: 2 GHz Personal Communications Services

Test Report Form No..... : LCSEMC-1.0

TRF Originator..... : Shenzhen LCS Compliance Testing Laboratory Ltd.

Master TRF..... : Dated 2011-03

Shenzhen LCS Compliance Testing Laboratory Ltd. All rights reserved.

This publication may be reproduced in whole or in part for non-commercial purposes as long as the Shenzhen LCS Compliance Testing Laboratory Ltd. is acknowledged as copyright owner and source of the material. Shenzhen LCS Compliance Testing Laboratory Ltd. takes no responsibility for and will not assume liability for damages resulting from the reader's interpretation of the reproduced material due to its placement and context.

Test item description..... : 3G USB MODEM

Trade Mark..... : N/A

Model/Type reference..... : CDT-901

Listed Models..... : /

Ratings..... : DC 5.0V, 1.0A

Modulation..... : QPSK

Hardware version..... : WFS300_V1.1

Software version..... : MSM6290_V1.00

Frequency..... : UMTS Band II /UMTS Band V

Result..... : PASS

Compiled by:

Jacky Li/ File administrators

Supervised by:

Glin Lu/ Technique principal

Approved by:

Gavin Liang/ Manager

TEST REPORT

| | | |
|--------------------------|-----------------------|-------------------|
| Test Report No. : | LCS1610191262E | November 24, 2016 |
| | | Date of issue |

Equipment under Test : 3G USB MODEM

Model /Type : CDT-901

Listed Models : /

Applicant : **Shenzhen Cenray Technology Co., LTD**
Address : Room 507, Huashenghui Business Building, Jinhai Road, Xixiang Street, Bao'an, Shenzhen, Guangdong, China

Manufacturer : **Shenzhen Cenray Technology Co., LTD**
Address : Room 507, Huashenghui Business Building, Jinhai Road, Xixiang Street, Bao'an, Shenzhen, Guangdong, China

Factory : **Shenzhen Cenray Technology Co., LTD**
Address : Room 507, Huashenghui Business Building, Jinhai Road, Xixiang Street, Bao'an, Shenzhen, Guangdong, China

| | |
|---------------------|-------------|
| Test Result: | PASS |
|---------------------|-------------|

The test report merely corresponds to the test sample.
It is not permitted to copy extracts of these test result without the written permission of the test laboratory.

Revision History

| Revision | Issue Date | Revisions | Revised By |
|----------|------------|---------------|-------------|
| 00 | 2016-11-24 | Initial Issue | Gavin Liang |
| | | | |
| | | | |

Contents

| | | |
|-----------------|---|------------------|
| <u>1</u> | <u>TEST STANDARDS</u> | <u>5</u> |
| <u>2</u> | <u>SUMMARY</u> | <u>6</u> |
| 2.1 | General Remarks | 6 |
| 2.2 | Product Description | 6 |
| 2.3 | Equipment under Test | 7 |
| 2.4 | Short description of the Equipment under Test (EUT) | 7 |
| 2.5 | Internal Identification of AE used during the test | 7 |
| 2.6 | Normal Accessory setting | 7 |
| 2.7 | EUT configuration | 8 |
| 2.8 | Related Submittal(s) / Grant (s) | 8 |
| 2.9 | Modifications | 8 |
| 2.10 | General Test Conditions/Configurations | 8 |
| <u>3</u> | <u>TEST ENVIRONMENT.....</u> | <u>9</u> |
| 3.1 | Address of the test laboratory | 9 |
| 3.2 | Test Facility | 9 |
| 3.3 | Environmental conditions | 9 |
| 3.4 | Test Description | 9 |
| 3.5 | Equipments Used during the Test | 11 |
| 3.6 | Measurement uncertainty | 12 |
| <u>4</u> | <u>TEST CONDITIONS AND RESULTS</u> | <u>13</u> |
| 4.1 | Output Power | 13 |
| 4.2 | Radiated Spurious Emssion | 17 |
| 4.3 | Occupied Bandwidth and Emission Bandwith | 20 |
| 4.4 | Band Edge Compliance | 22 |
| 4.5 | Spurious Emssion on Antenna Port | 24 |
| 4.6 | Frequency Stability Test | 28 |
| 4.7 | Peak-to-Average Ratio (PAR) | 30 |
| <u>5</u> | <u>TEST SETUP PHOTOS OF THE EUT</u> | <u>32</u> |
| <u>6</u> | <u>EXTERNAL PHOTOS OF THE EUT</u> | <u>32</u> |
| <u>7</u> | <u>INTERNAL PHOTOS OF THE EUT.....</u> | <u>32</u> |

1 TEST STANDARDS

The tests were performed according to following standards:

[FCC Part 22 \(10-1-16 Edition\)](#): Private Land Mobile Radio Services.

[FCC Part 24\(10-1-16 Edition\)](#): Public Mobile Services.

[TIA/EIA 603 D June 2010](#): Land Mobile FM or PM Communications Equipment Measurement and Performance Standards.

[ANSI C63.26-2015](#): American National Standard of Procedures for Compliance Testing of Licensed Transmitters Used in Licensed Radio Service

[47 CFR FCC Part 15 Subpart B](#): Unintentional Radiators.

[FCC Part 2](#): Frequency Allocations And Radio Treaty Matters: General Rules And Regulations.

[ANSI C63.4:2014](#): Methods of Measurement of Radio-Noise Emissions from Low-Voltage Electrical and Electronic Equipment in the Range of 9 kHz to 40 GHz.

[RSS-132 Issue 3 January 2013](#): Cellular Telephone Systems Operating in the Bands 824-849 MHz and 869-894 MHz.

[RSS-133 Issue 6 January 2013](#): 2 GHz Personal Communications Services.

[RSS-Gen Issue 4 November 2014](#): General Requirements for Compliance of Radio Apparatus.

2 SUMMARY

2.1 General Remarks

| | | |
|--------------------------------|---|-------------------|
| Date of receipt of test sample | : | October 19, 2016 |
| | | |
| Testing commenced on | : | November 24, 2016 |
| | | |
| Testing concluded on | : | November 24, 2016 |

2.2 Product Description

The **Shenzhen Cenray Technology Co., LTD**'s Model: CDT-901 or the "EUT" as referred to in this report; more general information as follows, for more details, refer to the user's manual of the EUT.

| | |
|--|---|
| Name of EUT | 3G USB MODEM |
| Model Number | CDT-901 |
| Model Declaration | / |
| Test Model | CDT-901 |
| Hardware version | WFS300_V1.1 |
| Software version | MSM6290_V1.00 |
| GSM/EDGE/GPRS Operation Frequency Band | GSM850/PCS1900/GPRS850/GPRS1900/EDGE850/EDGE1900 |
| UMTS Operation Frequency Band | UMTS FDD Band II/V |
| GSM/EDGE/GPRS | Supported GSM/GPRS/EDGE |
| GSM Release Version | R99 |
| GSM/EDGE/GPRS Power Class | GSM850:Power Class 4/ PCS1900:Power Class 1 |
| GPRS/EDGE Multislot Class | GPRS/EDGE: Multi-slot Class 12 |
| GPRS operation mode | Class B |
| WCDMA Release Version | R99 |
| HSDPA Release Version | Release 10 |
| HSUPA Release Version | Release 6 |
| DC-HSUPA Release Version | Not Supported |
| LTE Release Version | Not Supported |
| LTE/UMTS Power Class | Level 3 |
| Antenna Type | PIFA Antenna |
| Antenna Gain | 0.7dBi(max.) For GSM 850; 3.0dBi(max.) For PCS 1900; 3.0dBi(max.) For WCDMA Band II 0.7dBi(max.) For WCDMA Band V |
| Extreme temp. Tolerance | -30°C to +50°C |
| Extreme vol. Limits | 4.50VDC to 5.50VDC (nominal: 5.00VDC) |

2.3 Equipment under Test

Power supply system utilised

| | | | |
|----------------------|---|---|-----------------------------------|
| Power supply voltage | : | <input type="radio"/> 120V / 60 Hz | <input type="radio"/> 115V / 60Hz |
| | | <input type="radio"/> 12 V DC | <input type="radio"/> 24 V DC |
| | | <input checked="" type="radio"/> Other (specified in blank below) | |

DC 5.00V

Test frequency list

| Test Mode | TX/RX | RF Channel | | |
|---------------|-------|--------------|--------------|--------------|
| | | Low(L) | Middle (M) | High (H) |
| WCDMA Band V | TX | Channel 4132 | Channel 4183 | Channel 4233 |
| | | 826.4 MHz | 836.6 MHz | 846.6 MHz |
| | RX | Channel 4357 | Channel 4407 | Channel 4458 |
| | | 871.4 MHz | 881.4 MHz | 891.6 MHz |
| Test Mode | TX/RX | RF Channel | | |
| | | Low(L) | Middle (M) | High (H) |
| WCDMA Band II | TX | Channel 9262 | Channel 9400 | Channel 9538 |
| | | 1852.4 MHz | 1880.0 MHz | 1907.6 MHz |
| | RX | Channel 9662 | Channel 9800 | Channel 9938 |
| | | 1932.4 MHz | 1960.0 MHz | 1987.6 MHz |

2.4 Short description of the Equipment under Test (EUT)

2.4.1 General Description

QA5616 is subscriber equipment in the WCDMA/GSM system. The HSPA/UMTS frequency band is Band II/V, The GSM/GPRS/EDGE frequency band includes GSM850 and GSM900 and DCS1800 and PCS1900, but only Band II and Band V and GSM850 and PCS1900 bands test data included in this report. The Smart Phone implements such functions as RF signal receiving/transmitting, HSPA/UMTS and GSM/GPRS/EDGE protocol processing, voice, video MMS service and etc. Externally it provides micro SD card interface and SIM card interface.

NOTE: Unless otherwise noted in the report, the functional boards installed in the units shall be selected from the below list, but not means all the functional boards listed below shall be installed in one unit.

2.5 Internal Identification of AE used during the test

| AE ID* | Description |
|--------|-----------------------------|
| AE1 | Working with powered by USB |

AE1
PC Model: Lenovo B470
OUTPUT: DC 5.0V 0.5A

*AE ID: is used to identify the test sample in the lab internally.

2.6 Normal Accessory setting

Connected to PC.

2.7 EUT configuration

The following peripheral devices and interface cables were connected during the measurement:

● - supplied by the manufacturer

○ - supplied by the lab

| | | | |
|-----------------------|-------------|----------------|---|
| <input type="radio"/> | Power Cable | Length (m) : | / |
| | | Shield : | / |
| | | Detachable : | / |
| <input type="radio"/> | Multimeter | Manufacturer : | / |
| | | Model No. : | / |

2.8 Related Submittal(s) / Grant (s)

This submittal(s) (test report) is intended for **FCC ID: 2AKEXCDT-901** filing to comply with FCC Part 22 and Part 24 Rules.

This submittal(s) (test report) is intended for **IC: 22167-CDT-901** filing to comply with RSS-132 Issue 3 and RSS-132 Issue 3.

2.9 Modifications

No modifications were implemented to meet testing criteria.

2.10 General Test Conditions/Configurations

2.10.1 Test Modes

NOTE: The test mode(s) are selected according to relevant radio technology specifications.

| Test Mode | Test Modes Description |
|-----------|-------------------------------|
| UMTS/TM1 | WCDMA system, QPSK modulation |
| UMTS/TM2 | HSDPA system, QPSK modulation |
| UMTS/TM3 | HSUPA system, QPSK modulation |

Note:

1. This EUT owns one SIM card and we recorded the worst tests results in this report.
2. As WCDMA, HSDPA and HSUPA with the same emission designator, test result recorded in this report at the worst case UMTS/TM1 only after exploratory scan.

2.10.2 Test Environment

| Environment Parameter | Selected Values During Tests | |
|-----------------------|------------------------------|---------|
| Relative Humidity | Ambient | |
| Temperature | TN | Ambient |
| Voltage | VL | 4.50V |
| | VN | 5.00V |
| | VH | 5.50V |

NOTE: VL=lower extreme test voltage VN=nominal voltage
VH=upper extreme test voltage TN=normal temperature

3 TEST ENVIRONMENT

3.1 Address of the test laboratory

Shenzhen LCS Compliance Testing Laboratory Ltd

1/F., Xingyuan Industrial Park, Tongda Road, Bao'an Avenue, Bao'an District, Shenzhen, Guangdong, China

The sites are constructed in conformance with the requirements of ANSI C63.4 (2014) and CISPR Publication 22.

3.2 Test Facility

The test facility is recognized, certified, or accredited by the following organizations:

CNAS Registration Number. is L4595.

FCC Registration Number. is 899208.

Industry Canada Registration Number. is 9642A-1.

VCCI Registration Number. is C-4260 and R-3804.

ESMD Registration Number. is ARCB0108.

UL Registration Number. is 100571-492.

TUV SUD Registration Number. is SCN1081.

TUV RH Registration Number. is UA 50296516-001

3.3 Environmental conditions

During the measurement the environmental conditions were within the listed ranges:

| | |
|-----------------------|--------------|
| Temperature: | 15-35 ° C |
| Humidity: | 30-60 % |
| Atmospheric pressure: | 950-1050mbar |

(1)expressed at approximately the 95% confidence level using a coverage factor of k=1.96.

3.4 Test Description

3.4.1 Cellular Band (824-849MHz paired with 869-894MHz)

| Test Item | FCC Rule No. | ISED Rule No. | Requirements | Verdict |
|--|---------------------|---------------|--|---------|
| Effective(Isotropic) Radiated Output Power | §2.1046, §22.913 | RSS-132 §5.4 | FCC: ERP ≤ 7W. ISED: ERP ≤ 11.5W. | Pass |
| Modulation Characteristics | §2.1047 | RSS-132 §5.2 | Digital modulation | N/A |
| Bandwidth | §2.1049 | RSS-GEN | OBW: No limit. EBW: No limit. | Pass |
| Band Edges Compliance | §2.1051, §22.917 | RSS-132 §5.5 | ≤-13dBm/1%*EBW, in 1MHz bands immediately outside and adjacent to The frequency block. | Pass |
| Spurious Emission at Antenna Terminals | §2.1051, §22.917 | RSS-132 §5.5 | ≤ -13dBm/100kHz, from 9kHz to 10th harmonics but outside authorized operating frequency ranges. | Pass |
| Field Strength of Spurious Radiation | §2.1053, §22.917 | RSS-132 §5.5 | ≤ -13dBm/100kHz. | Pass |
| Frequency Stability | §2.1055, §22.355 | RSS-132 §5.3 | ≤ ±2.5ppm. | Pass |
| Peak-Average Ratio | N/A | RSS-132 §5.4 | IC:Limit≤13dB | Pass |
| Receiver Spurious Emissions | N/A | RSS-GEN | -- | Pass |

NOTE 1: For the verdict, the "N/A" denotes "not applicable", the "N/T" de notes "not tested".

3.4.2 PCS Band (1850-1915MHz paired with 1930-1995MHz)

| Test Item | FCC Rule No. | ISED Rule No. | Requirements | Verdict |
|--|---------------------|---------------|---|---------|
| Effective(Isotropic) Radiated Output Power | §2.1046, §24.232 | RSS-133 §6.4 | EIRP ≤ 2W | Pass |
| Peak-Average Ratio | §2.1046, §24.232 | RSS-133 §6.4 | ≤13dB | Pass |
| Modulation Characteristics | §2.1047 | RSS-133 §6.2 | Digital modulation | N/A |
| Bandwidth | §2.1049 | RSS-GEN | OBW: No limit. EBW: No limit. | Pass |
| Band Edges Compliance | §2.1051, §24.238 | RSS-133 §6.5 | ≤ -13dBm/1%*EBW, In 1MHz bands immediately outside and adjacent to The frequency block. | Pass |
| Spurious Emission at Antenna Terminals | §2.1051, §24.238 | RSS-133 §6.5 | ≤-13dBm/1MHz, from 9kHz to10th harmonics but outside authorized Operating frequency ranges. | Pass |
| Field Strength of Spurious Radiation | §2.1053, §24.238 | RSS-133 §6.5 | ≤ -13dBm/1MHz. | Pass |
| Frequency Stability | §2.1055, §24.235 | RSS-133 §6.3 | ≤ ±2.5ppm. | Pass |
| Receiver Spurious Emissions | N/A | RSS-GEN | -- | Pass |

NOTE 1: For the verdict, the "N/A" denotes "not applicable", the "N/T" de notes "not tested".

Remark: 1.The measurement uncertainty is not included in the test result.

3.5 Equipments Used during the Test

| Instrument | Manufacturer | Model No. | Serial No. | Characteristics | Cal Date | Due Date |
|--------------------------------------|----------------|----------------------------------|-------------|-----------------|---------------|---------------|
| EMI Test Software | AUDIX | E3 | N/A | N/A | N/A | N/A |
| EMC Receiver | R&S | ESCS 30 | 100174 | 9kHz – 2.75GHz | June 18,2016 | June 17,2017 |
| Signal analyzer | Agilent | E4448A(External mixers to 40GHz) | US44300469 | 9kHz~40GHz | July 16,2015 | July 15,2016 |
| LISN | MESS Tec | NNB-2/16Z | 99079 | 9KHz-30MHz | June 18,2016 | June 17,2017 |
| LISN (Support Unit) | EMCO | 3819/2NM | 9703-1839 | 9KHz-30MHz | June 18,2016 | June 17,2017 |
| RF Cable-CON | UTIFLEX | 3102-26886-4 | CB049 | 9KHz-30MHz | June 18,2016 | June 17,2017 |
| ISN | SCHAFFNER | ISN ST08 | 21653 | 9KHz-30MHz | June 18,2016 | June 17,2017 |
| 3m Semi Anechoic Chamber | SIDT FRANKONIA | SAC-3M | 03CH03-HY | 30M-1GHz 3m | June 18,2016 | June 17,2017 |
| Amplifier | SCHAFFNER | COA9231A | 18667 | 9kHz-2GHz | June 18,2016 | June 17,2017 |
| Amplifier | Agilent | 8449B | 3008A02120 | 1GHz-26.5GHz | July 16,2016 | July 15,2017 |
| Amplifier | MITEQ | AMF-6F-260400 | 9121372 | 26.5GHz-40GHz | July 16,2016 | July 15,2017 |
| Spectrum Analyzer | Agilent | E4407B | MY41440292 | 9k-26.5GHz | July 16,2016 | July 15,2017 |
| MAX Signal Analyzer | Agilent | N9020A | MY50510140 | 20Hz~26.5GHz | Oct. 27, 2016 | Oct. 26, 2017 |
| Loop Antenna | R&S | HFH2-Z2 | 860004/001 | 9k-30MHz | June 18,2016 | June 17,2017 |
| By-log Antenna | SCHWARZBECK | VULB9163 | 9163-470 | 30MHz-1GHz | June 10,2016 | June 09,2017 |
| Horn Antenna | EMCO | 3115 | 6741 | 1GHz-18GHz | June 10,2016 | June 09,2017 |
| Horn Antenna | SCHWARZBECK | BBHA9170 | BBHA9170154 | 15GHz-40GHz | June 10,2016 | June 09,2017 |
| RF Cable-R03m | Jye Bao | RG142 | CB021 | 30MHz-1GHz | June 18,2016 | June 17,2017 |
| RF Cable-HIGH | SUHNER | SUCOFLEX 106 | 03CH03-HY | 1GHz-40GHz | June 18,2016 | June 17,2017 |
| Spectrum Meter | R&S | FSP 30 | 100023 | 9kHz-30GHz | July 16,2015 | July 15,2016 |
| Power Meter | R&S | NRVS | 100444 | DC-40GHz | June 18,2016 | June 17,2017 |
| Power Sensor | R&S | NRV-Z51 | 100458 | DC-30GHz | June 18,2016 | June 17,2017 |
| Power Sensor | R&S | NRV-Z32 | 10057 | 30MHz-6GHz | June 18,2016 | June 17,2017 |
| RF CABLE-1m | JYE Bao | RG142 | CB034-1m | 20MHz-7GHz | June 18,2016 | June 17,2017 |
| RF CABLE-2m | JYE Bao | RG142 | CB035-2m | 20MHz-1GHz | June 18,2016 | June 17,2017 |
| Vector signal Generator | R&S | SMU200A | 102098 | 100kHz~6GHz | June 18,2016 | June 17,2017 |
| Signal Generator | R&S | SMR40 | 10016 | 10MHz~40GHz | July 16,2016 | July 15,2017 |
| Universal Radio Communication Tester | R&S | CMU200 | 112012 | N/A | July 16,2016 | July 15,2017 |
| DC power Source | GW | GPC-6030D | C671845 | / | June 18,2016 | June 17,2017 |
| Temperature & Humidity Chamber | Wuhuan | HTP205 | / | / | June 18,2016 | June 17,2017 |

Note: All equipment through GRGT EST calibration

3.6 Measurement uncertainty

The data and results referenced in this document are true and accurate. The reader is cautioned that there may be errors within the calibration limits of the equipment and facilities. The measurement uncertainty was calculated for all measurements listed in this test report acc. to ETSI TR 100 028 “ Electromagnetic compatibility and Radio spectrum Matters (ERM); Uncertainties in the measurement of mobile radio equipment characteristics” and is documented in the Shenzhen LCS Compliance Testing Laboratory Ltd. quality system acc. to DIN EN ISO/IEC 17025. Furthermore, component and process variability of devices similar to that tested may result in additional deviation. The manufacturer has the sole responsibility of continued compliance of the device.

Hereafter the best measurement capability for Shenzhen LCS Compliance Testing Laboratory Ltd. is reported:

| Test | Range | Measurement Uncertainty | Notes |
|-------------------------------------|------------|-------------------------|-------|
| Radiated Emission | 30~1000MHz | 3.10 dB | (1) |
| Radiated Emission | 1~18GHz | 3.70 dB | (1) |
| Radiated Emission | 18-40GHz | 3.90 dB | (1) |
| Conducted Disturbance | 0.15~30MHz | 1.63 dB | (1) |
| Conducted Power | 9KHz~18GHz | 0.61 dB | (1) |
| Spurious RF Conducted Emission | 9KHz~40GHz | 1.22 dB | (1) |
| Band Edge Compliance of RF Emission | 9KHz~40GHz | 1.22 dB | (1) |
| Occupied Bandwidth | 9KHz~40GHz | - | (1) |

(1) This uncertainty represents an expanded uncertainty expressed at approximately the 95% confidence level using a coverage factor of k=1.96.

4 TEST CONDITIONS AND RESULTS

4.1 Output Power

TEST APPLICABLE

During the process of testing, the EUT was controlled via R&S Digital Radio Communication tester (CMU200) to ensure max power transmission and proper modulation. This result contains output power and EIRP measurements for the EUT. In all cases, output power is within the specified limits.

4.1.1. Conducted Output Power

TEST CONFIGURATION

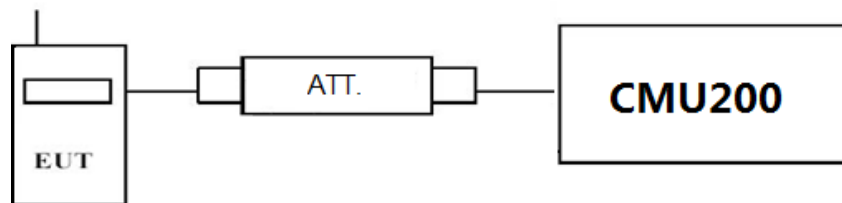

TEST PROCEDURE

Conducted Power Measurement:

- Place the EUT on a bench and set it in transmitting mode.
- Connect a low loss RF cable from the antenna port to a CMU200 by an Att.
- EUT Communicate with CMU200 then selects a channel for testing.
- Add a correction factor to the display CMU200, and then test.

TEST RESULTS

See next page

| Test Mode | Test Channel | Burst Average Conducted power (dBm) | |
|-----------|---------------|-------------------------------------|--------------|
| | | UMTS Band V | UMTS Band II |
| UMTS/TM1 | LCH | 23.54 | 23.63 |
| | MCH | 23.52 | 23.61 |
| | HCH | 23.47 | 23.67 |
| UMTS/TM2 | LCH SubTest-1 | 23.21 | 23.52 |
| | LCH SubTest-2 | 22.45 | 22.43 |
| | LCH SubTest-3 | 21.77 | 21.72 |
| | LCH SubTest-4 | 21.02 | 21.31 |
| | MCH SubTest-1 | 23.27 | 23.57 |
| | MCH SubTest-2 | 22.42 | 22.48 |
| | MCH SubTest-3 | 21.71 | 21.71 |
| | MCH SubTest-4 | 21.07 | 21.34 |
| | HCH SubTest-1 | 23.25 | 23.55 |
| | HCH SubTest-2 | 22.49 | 22.44 |
| | HCH SubTest-3 | 21.78 | 21.78 |
| | HCH SubTest-4 | 21.05 | 21.36 |
| UMTS/TM3 | LCH SubTest-1 | 22.56 | 22.45 |
| | LCH SubTest-2 | 21.64 | 21.75 |
| | LCH SubTest-3 | 22.45 | 21.45 |
| | LCH SubTest-4 | 20.75 | 20.53 |
| | LCH SubTest-5 | 20.14 | 21.12 |
| | MCH SubTest-1 | 22.58 | 22.49 |
| | MCH SubTest-2 | 21.67 | 21.72 |
| | MCH SubTest-3 | 22.46 | 21.48 |
| | MCH SubTest-4 | 20.73 | 20.53 |
| | MCH SubTest-5 | 20.18 | 21.16 |
| | HCH SubTest-1 | 22.57 | 22.44 |
| | HCH SubTest-2 | 21.66 | 21.77 |
| | HCH SubTest-3 | 22.49 | 21.46 |
| | HCH SubTest-4 | 20.72 | 20.52 |
| | HCH SubTest-5 | 20.17 | 21.17 |

4.1.1 Radiated Output Power

TEST DESCRIPTION

This is the test for the maximum radiated power from the EUT.

Rule Part 24.232(c) specifies, "Mobile/portable stations are limited to 2 watts e.i.r.p. Peak power" and 24.232(e) specifies that "Peak transmit power must be measured over any interval of continuous transmission using instrumentation calibrated in terms of an rms-equivalent voltage." Rule Part 22.913(a) specifies "The ERP of mobile transmitters and auxiliary test transmitters must not exceed 7 Watts."

Per Part 27.50(d) (4) specifies, Fixed, mobile, and portable (hand-held) stations operating in the 1710-1755MHz band are limited to 1W EIRP. Fixed stations operating in this band are limited to a maximum antenna height of 10 meters above ground. Mobile and portable stations operating in this band must employ a means for limiting power to the minimum necessary for successful communications.

TEST CONFIGURATION

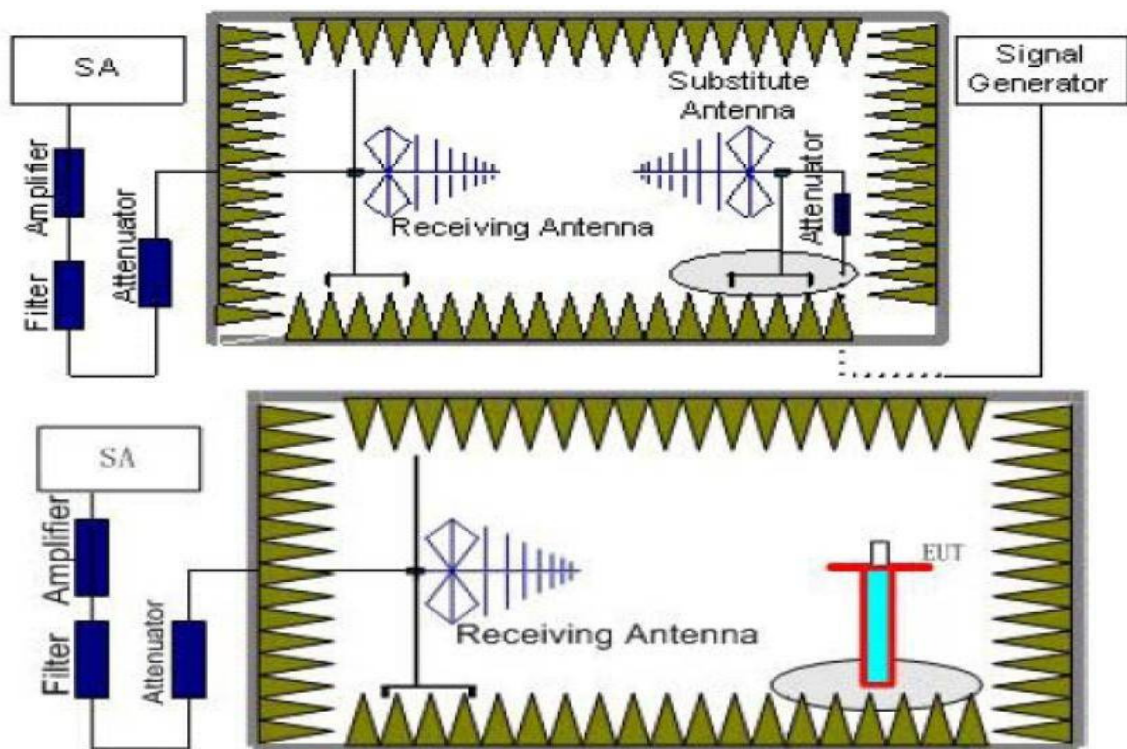

TEST PROCEDURE

1. EUT was placed on a 1.50 meter high non-conductive stand at a 3 meter test distance from the receive antenna. A receiving antenna was placed on the antenna mast 3 meters from the EUT for emission measurements. The height of receiving antenna is 1.50m. Detected emissions were maximized at each frequency by rotating the EUT through 360° and adjusting the receiving antenna polarization. The radiated emission measurements of all transmit frequencies in three channels (High, Middle, Low) were measured with peak detector.
2. A log-periodic antenna or double-ridged waveguide horn antenna shall be substituted in place of the EUT. The log-periodic antenna will be driven by a signal generator and the level will be adjusted till the same power value on the spectrum analyzer or receiver. The level of the spurious emissions can be calculated through the level of the signal generator, cable loss, the gain of the substitution antenna and the reading of the spectrum analyzer or receiver.
3. The EUT is then put into continuously transmitting mode at its maximum power level during the test. Set Test Receiver or Spectrum RBW=10MHz, VBW=10MHz, And the maximum value of the receiver should be recorded as (P_r).
4. The EUT shall be replaced by a substitution antenna. In the chamber, an substitution antenna for the frequency band of interest is placed at the reference point of the chamber. An RF Signal source for the frequency band of interest is connected to the substitution antenna with a cable that has been constructed to not interfere with the radiation pattern of the antenna. A power (P_{Mea}) is applied to the input of the

substitution antenna, and adjust the level of the signal generator output until the value of the receiver reach the previously recorded (P_r). The power of signal source (P_{Mea}) is recorded. The test should be performed by rotating the test item and adjusting the receiving antenna polarization.

5. A amplifier should be connected to the Signal Source output port. And the cable should be connect between the Amplifier and the Substitution Antenna. The cable loss (P_{cl}), the Substitution Antenna Gain (G_a) and the Amplifier Gain (P_{Ag}) should be recorded after test.

The measurement results are obtained as described below:

$$\text{Power(EIRP)} = P_{Mea} - P_{Ag} - P_{cl} + G_a$$

6. This value is EIRP since the measurement is calibrated using an antenna of known gain (2.15 dBi) and known input power.
7. ERP can be calculated from EIRP by subtracting the gain of the dipole, $ERP = EIRP - 2.15\text{dBi}$.

TEST LIMIT

According to 22.913(a), 24.232(c), RSS-132 §5.4 and RSS-132 §6.4, the ERP(EIRP) should be not exceeding following table limits:

| | Burst Average EIRP |
|--------------|--|
| UMTS Band II | FCC: ≤38.45dBm (7W) IC: ≤40.61dBm (11.5W) |

| | Burst Average ERP |
|-------------|--------------------------|
| UMTS Band V | 38.45dBm (7W) |

TEST RESULTS

Remark:

1. We were tested all Configuration refer 3GPP TS134 121.
2. $EIRP = P_{Mea}(\text{dBm}) - P_{cl}(\text{dB}) + P_{Ag}(\text{dB}) + G_a(\text{dBi})$
3. $ERP = EIRP - 2.15\text{dBi}$ as EIRP by subtracting the gain of the dipole.
4. Margin = Emission Level - Limit
5. We test the H direction and V direction recorded worst case.

UMTS/TM1/UMTS Band II

| Frequency (MHz) | P_{Mea} (dBm) | P_{cl} (dB) | G_a Antenna Gain(dB) | P_{Ag} (dB) | EIRP (dBm) | FCC Limit (dBm) | IC Limit (dBm) | FCC Margin (dB) | IC Margin (dB) | PoL. |
|-----------------|-----------------|---------------|------------------------|---------------|--------------|-----------------|----------------|-----------------|----------------|------|
| 1852.4 | -16.69 | 4.03 | 8.38 | 35.51 | 23.17 | 33.01 | 33.01 | -9.84 | -9.84 | V |
| 1880.0 | -17.25 | 4.08 | 8.33 | 35.56 | 22.56 | 33.01 | 33.01 | -10.45 | -10.45 | V |
| 1907.6 | -18.04 | 4.14 | 8.26 | 35.63 | 21.71 | 33.01 | 33.01 | -11.30 | -11.30 | V |

UMTS/TM1/UMTS Band V

| Frequency (MHz) | P_{Mea} (dBm) | P_{cl} (dB) | G_a Antenna Gain(dB) | Correction (dB) | P_{Ag} (dB) | ERP (dBm) | FCC Limit (dBm) | IC Limit (dBm) | FCC Margin (dB) | IC Margin (dB) | Pol. |
|-----------------|-----------------|---------------|------------------------|-----------------|---------------|--------------|-----------------|----------------|-----------------|----------------|------|
| 826.40 | -15.85 | 3.45 | 8.45 | 2.15 | 33.79 | 20.79 | 38.45 | 40.61 | -17.66 | -19.82 | V |
| 836.60 | -16.73 | 3.49 | 8.45 | 2.15 | 33.85 | 19.93 | 38.45 | 40.61 | -18.52 | -20.68 | V |
| 844.60 | -17.20 | 3.55 | 8.36 | 2.15 | 33.88 | 19.34 | 38.45 | 40.61 | -19.11 | -21.27 | V |

4.2 Radiated Spurious Emission

TEST APPLICABLE

According to the TIA/EIA 603D:2010 and FCC Part 2.1033 test method, The Receiver or Spectrum was scanned from lowest frequency frequency generated within the equipment to the 10th harmonic of the highest frequency generated within the equipment, which is the transmitted carrier that can be as high as 1910 MHz. The resolution bandwidth is set as outlined in Part 24.238, Part 22.917, RSS-132 §5.5 and RSS-133 §6.5. The spectrum is scanned with the mobile station transmitting at carrier frequencies that pertain to low, mid and high channels of WCDMA Band II and WCDMA Band V.

TEST CONFIGURATION

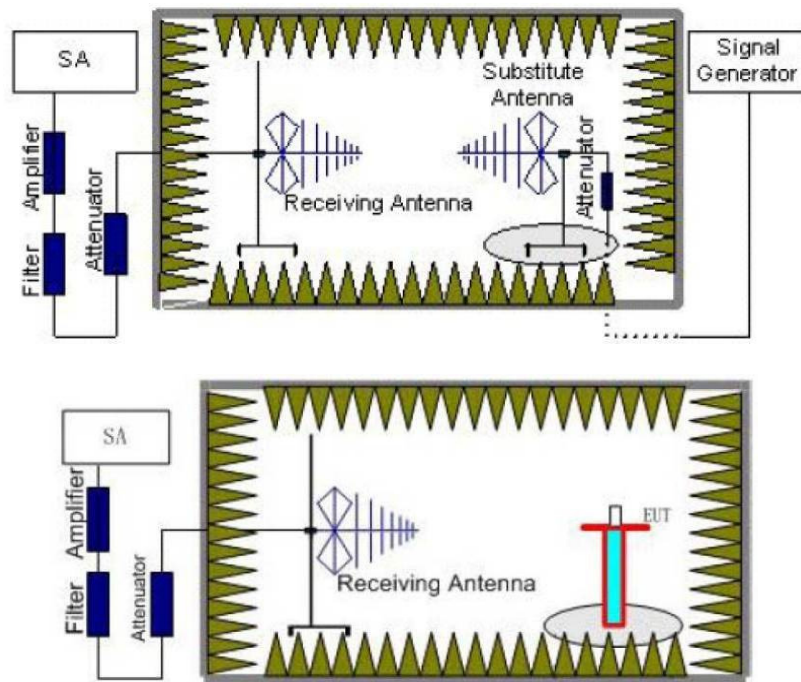

TEST PROCEDURE

1. EUT was placed on a 1.50 meter high non-conductive stand at a 3 meter test distance from the receive antenna. A receiving antenna was placed on the antenna mast 3 meters from the EUT for emission measurements. The height of receiving antenna is 1.50 m. Detected emissions were maximized at each frequency by rotating the EUT through 360° and adjusting the receiving antenna polarization. The radiated emission measurements of all transmit frequencies in three channels (High, Middle, Low) were measured with peak detector.
2. A log-periodic antenna or double-ridged waveguide horn antenna shall be substituted in place of the EUT. The log-periodic antenna will be driven by a signal generator and the level will be adjusted till the same power value on the spectrum analyzer or receiver. The level of the spurious emissions can be calculated through the level of the signal generator, cable loss, the gain of the substitution antenna and the reading of the spectrum analyzer or receiver.
3. The EUT is then put into continuously transmitting mode at its maximum power level during the test. Set Test Receiver or Spectrum RBW=1MHz, VBW=3MHz, And the maximum value of the receiver should be recorded as (P_r).
4. The EUT shall be replaced by a substitution antenna. In the chamber, a substitution antenna for the frequency band of interest is placed at the reference point of the chamber. An RF Signal source for the frequency band of interest is connected to the substitution antenna with a cable that has been constructed to not interfere with the radiation pattern of the antenna. A power (P_{Mea}) is applied to the input of the substitution antenna, and adjust the level of the signal generator output until the value of the receiver reach the previously recorded (P_r). The power of signal source (P_{Mea}) is recorded. The test should be performed by rotating the test item and adjusting the receiving antenna polarization.

5. A amplifier should be connected to the Signal Source output port. And the cable should be connect between the Amplifier and the Substitution Antenna. The cable loss (P_{cl}), the Substitution Antenna Gain (G_a) and the Amplifier Gain (P_{Ag}) should be recorded after test. The measurement results are obtained as described below:
Power(EIRP)= $P_{Mea} - P_{Ag} - P_{cl} + G_a$
6. This value is EIRP since the measurement is calibrated using an antenna of known gain (2.15 dBi) and known input power.
7. ERP can be calculated from EIRP by subtracting the gain of the dipole, ERP = EIRP -2.15dBi.
8. In order to make sure test results more clearly,we set frequency range and sweep time for difference frequency range as follows table:

| Working Frequency | Subrange (GHz) | RBW | VBW | Sweep time (s) |
|----------------------------|----------------|--------|--------|----------------|
| UMTS/TM1/ WCDMA Band V | 0.00009~0.15 | 1KHz | 3KHz | 30 |
| | 0.00015~0.03 | 10KHz | 30KHz | 10 |
| | 0.03~1 | 100KHz | 300KHz | 10 |
| | 1~2 | 1 MHz | 3 MHz | 2 |
| | 2~5 | 1 MHz | 3 MHz | 3 |
| | 5~8 | 1 MHz | 3 MHz | 3 |
| | 8~10 | 1 MHz | 3 MHz | 3 |
| UMTS/TM1/ WCDMA Band II | 0.00009~0.15 | 1KHz | 3KHz | 30 |
| | 0.00015~0.03 | 10KHz | 30KHz | 10 |
| | 0.03~1 | 100KHz | 300KHz | 10 |
| | 1~2 | 1 MHz | 3 MHz | 2 |
| | 2~5 | 1 MHz | 3 MHz | 3 |
| | 5~8 | 1 MHz | 3 MHz | 3 |
| | 8~11 | 1 MHz | 3 MHz | 3 |
| | 11~14 | 1 MHz | 3 MHz | 3 |
| | 14~18 | 1 MHz | 3 MHz | 3 |
| 18~20 | 1 MHz | 3 MHz | 2 | |

TEST LIMITS

According to 24.238, 22.917 and 27.54 specify that the power of any emission outside of the authorized operating frequency ranges must be attenuated below the transmitting power (P) by a factor of at least $43 + 10 \log(P)$ dB.

The specification that emissions shall be attenuated below the transmitter power (P) by at least $43 + 10 \log(P)$ dB, translates in the relevant power range (1 to 0.001 W) to -13 dBm. At 1 W the specified minimum attenuation becomes 43 dB and relative to a 30 dBm (1 W) carrier becomes a limit of -13 dBm. At 0.001 W (0 dBm) the minimum attenuation is 13 dB, which again yields a limit of -13 dBm. In this way a translation of the specification from relative to absolute terms is carried out.

| Frequency | Channel | Frequency Range | Verdict |
|----------------------------|---------|-----------------|---------|
| UMTS/TM1/ WCDMA Band V | Low | 9KHz-10GHz | PASS |
| | Middle | 9KHz -10GHz | PASS |
| | High | 9KHz -10GHz | PASS |
| UMTS/TM1/ WCDMA Band II | Low | 9KHz -20GHz | PASS |
| | Middle | 9KHz -20GHz | PASS |
| | High | 9KHz -20GHz | PASS |

TEST RESULTS

Remark:

1. We were tested all Configuration refer 3GPP TS134 121.
2. $EIRP = P_{Mea}(dBm) - P_{cl}(dB) + P_{Ag}(dB) + G_a(dBi)$
3. $ERP = EIRP - 2.15dBi$ as EIRP by subtracting the gain of the dipole.
4. $Margin = EIRP - Limit$

UMTS/TM1/ WCDMA Band II Low Channel

| Frequency (MHz) | P _{Mea} (dBm) | P _{cl} (dB) | Diatance | Ga Antenna Gain(dB) | Peak EIRP (dBm) | Limit (dBm) | Margin (dB) | Polarization |
|-----------------|------------------------|----------------------|----------|---------------------|-----------------|-------------|-------------|--------------|
| 3704.8 | -43.14 | 5.26 | 3.00 | 9.88 | -38.52 | -13.00 | -25.52 | H |
| 5557.2 | -48.14 | 6.11 | 3.00 | 11.36 | -42.89 | -13.00 | -29.89 | H |
| 3704.8 | -45.85 | 5.26 | 3.00 | 9.88 | -41.23 | -13.00 | -28.23 | V |
| 5557.2 | -49.81 | 6.11 | 3.00 | 11.36 | -44.56 | -13.00 | -31.56 | V |

UMTS/TM1/ WCDMA Band II Middle Channel

| Frequency (MHz) | P _{Mea} (dBm) | P _{cl} (dB) | Diatance | Ga Antenna Gain(dB) | EIRP (dBm) | Limit (dBm) | Margin (dB) | Polarization |
|-----------------|------------------------|----------------------|----------|---------------------|------------|-------------|-------------|--------------|
| 3760.0 | -44.12 | 5.32 | 3.00 | 10.03 | -39.41 | -13.00 | -26.41 | H |
| 5640.0 | -49.00 | 6.19 | 3.00 | 11.41 | -43.78 | -13.00 | -30.78 | H |
| 3760.0 | -45.73 | 5.32 | 3.00 | 10.03 | -41.02 | -13.00 | -28.02 | V |
| 5640.0 | -50.68 | 6.19 | 3.00 | 11.41 | -45.46 | -13.00 | -32.46 | V |

UMTS/TM1/ WCDMA Band II High Channel

| Frequency (MHz) | P _{Mea} (dBm) | P _{cl} (dB) | Diatance | Ga Antenna Gain(dB) | EIRP (dBm) | Limit (dBm) | Margin (dB) | Polarization |
|-----------------|------------------------|----------------------|----------|---------------------|------------|-------------|-------------|--------------|
| 3815.2 | -44.61 | 5.36 | 3.00 | 9.62 | -40.35 | -13.00 | -27.35 | H |
| 5722.8 | -48.47 | 6.24 | 3.00 | 11.46 | -43.25 | -13.00 | -30.25 | H |
| 3815.2 | -46.67 | 5.36 | 3.00 | 9.62 | -42.41 | -13.00 | -29.41 | V |
| 5722.8 | -51.00 | 6.24 | 3.00 | 11.46 | -45.78 | -13.00 | -32.78 | V |

UMTS/TM1/ WCDMA Band V Low Channel

| Frequency (MHz) | P _{Mea} (dBm) | P _{cl} (dB) | Diatance | Ga Antenna Gain(dB) | Peak EIRP (dBm) | Limit (dBm) | Margin (dB) | Polarization |
|-----------------|------------------------|----------------------|----------|---------------------|-----------------|-------------|-------------|--------------|
| 1652.8 | -46.39 | 3.86 | 3.00 | 8.56 | -41.69 | -13.00 | -28.69 | H |
| 2479.2 | -47.25 | 4.29 | 3.00 | 6.98 | -44.56 | -13.00 | -31.56 | H |
| 1652.8 | -45.11 | 3.86 | 3.00 | 8.56 | -40.41 | -13.00 | -27.41 | V |
| 2479.2 | -48.47 | 4.29 | 3.00 | 6.98 | -45.78 | -13.00 | -32.78 | V |

UMTS/TM1/ WCDMA Band V Middle Channel

| Frequency (MHz) | P _{Mea} (dBm) | P _{cl} (dB) | Diatance | Ga Antenna Gain(dB) | EIRP (dBm) | Limit (dBm) | Margin (dB) | Polarization |
|-----------------|------------------------|----------------------|----------|---------------------|------------|-------------|-------------|--------------|
| 1672.8 | -46.31 | 3.90 | 3.00 | 8.58 | -41.63 | -13.00 | -28.63 | H |
| 2509.2 | -46.76 | 4.32 | 3.00 | 6.80 | -44.28 | -13.00 | -31.28 | H |
| 1672.8 | -46.42 | 3.90 | 3.00 | 8.58 | -41.74 | -13.00 | -28.74 | V |
| 2509.2 | -49.37 | 4.32 | 3.00 | 6.80 | -46.89 | -13.00 | -33.89 | V |

UMTS/TM1/ WCDMA Band V High Channel

| Frequency (MHz) | P _{Mea} (dBm) | P _{cl} (dB) | Diatance | Ga Antenna Gain(dB) | EIRP (dBm) | Limit (dBm) | Margin (dB) | Polarization |
|-----------------|------------------------|----------------------|----------|---------------------|------------|-------------|-------------|--------------|
| 1693.2 | -44.28 | 3.91 | 3.00 | 9.06 | -39.13 | -13.00 | -26.13 | H |
| 2539.8 | -45.37 | 4.32 | 3.00 | 6.65 | -43.04 | -13.00 | -30.04 | H |
| 1693.2 | -45.93 | 3.91 | 3.00 | 9.06 | -40.78 | -13.00 | -27.78 | V |
| 2539.8 | -47.88 | 4.32 | 3.00 | 6.65 | -45.55 | -13.00 | -32.55 | V |

4.3 Occupied Bandwidth and Emission Bandwidth

TEST APPLICABLE

Similar to conducted emissions; occupied bandwidth measurements are only provided for selected frequencies in order to reduce the amount of submitted data. The table below lists the measured 99% Bandwidth and -26dBc Bandwidth.

TEST CONFIGURATION

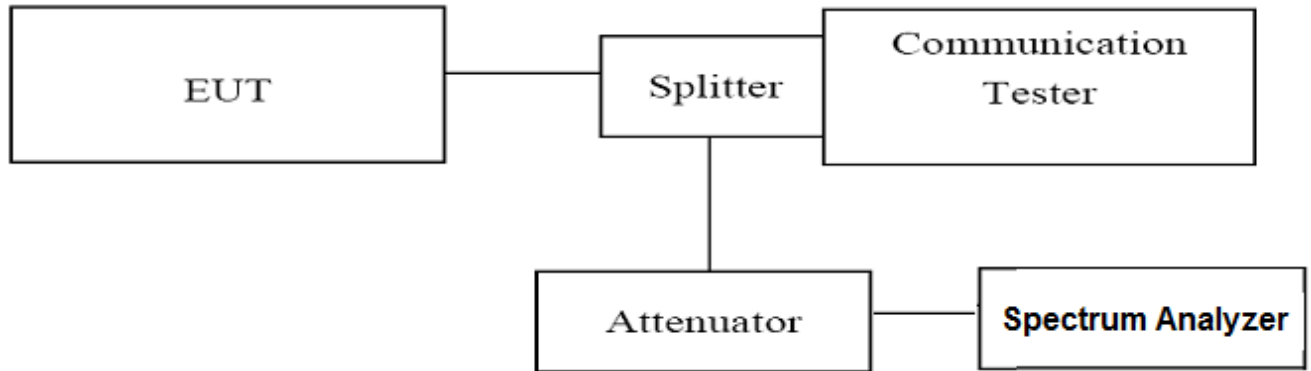

TEST PROCEDURE

1. The EUT was set up for the max output power with pseudo random data modulation;
2. The Occupied bandwidth and Emission Bandwidth were measured with Agilent Spectrum Analyzer N9020A (peak);
3. Set RBW=100KHz,VBW=300KHz,Span=10MHz,SWT=1ms;
4. Set SPA Max hold and View, Set 99% Occupied Bandwidth/ Set -26dBc Occupied Bandwidth
5. These measurements were done at 3 frequencies for WCDMA band II/IV/V. (low, middle and high of operational frequency range).

TEST RESULTS

| Test Mode | Channel | Frequency (MHz) | Occupied Bandwidth (99% BW) (MHz) | Emission Bandwidth (-26 dBc BW) (MHz) | Verdict |
|-------------------------------|---------|-----------------|------------------------------------|--|---------|
| UMTS/TM1/ WCDMA Band V | 4132 | 826.40 | 4.2066 | 4.861 | PASS |
| | 4183 | 836.60 | 4.2085 | 4.847 | PASS |
| | 4233 | 846.60 | 4.2136 | 4.867 | PASS |
| UMTS/TM1/ WCDMA Band II | 9262 | 1852.40 | 4.4535 | 8.463 | PASS |
| | 9400 | 1880.00 | 4.3357 | 5.058 | PASS |
| | 9538 | 1907.60 | 4.3221 | 5.179 | PASS |

Remark:

1. Test results including cable loss;
2. please refer to following plots;

Occupied Bandwidth and Emission Bandwidth

UMTS/TM1/ WCDMA Band V

UMTS/TM1/ WCDMA Band II

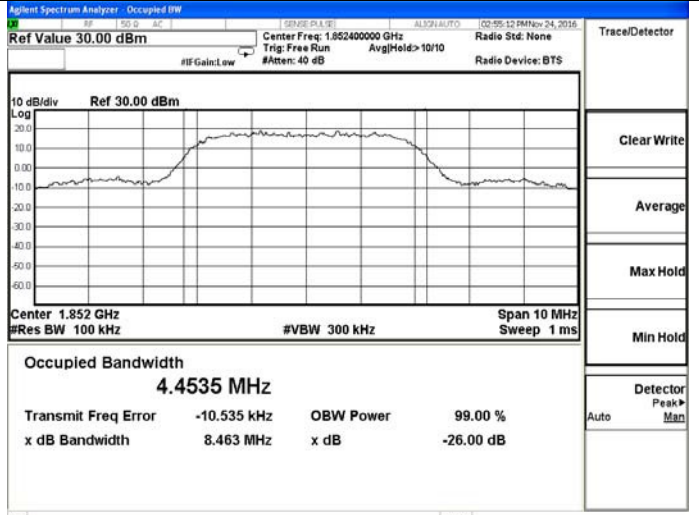
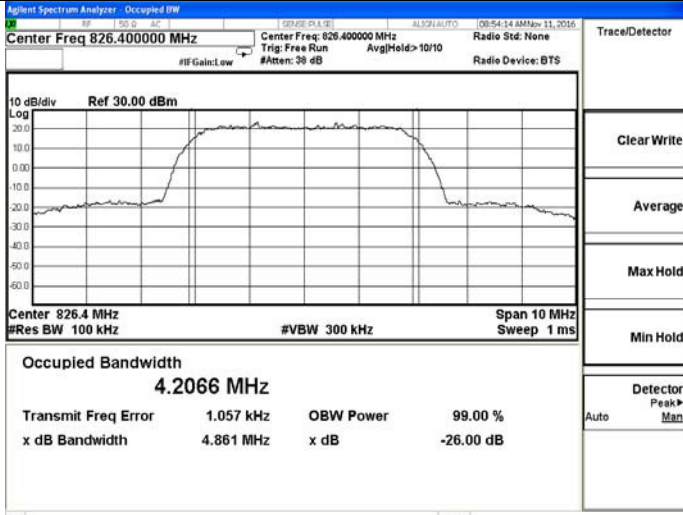

Channel 4132 / 826.4 MHz

Channel 9262 / 1852.4 MHz

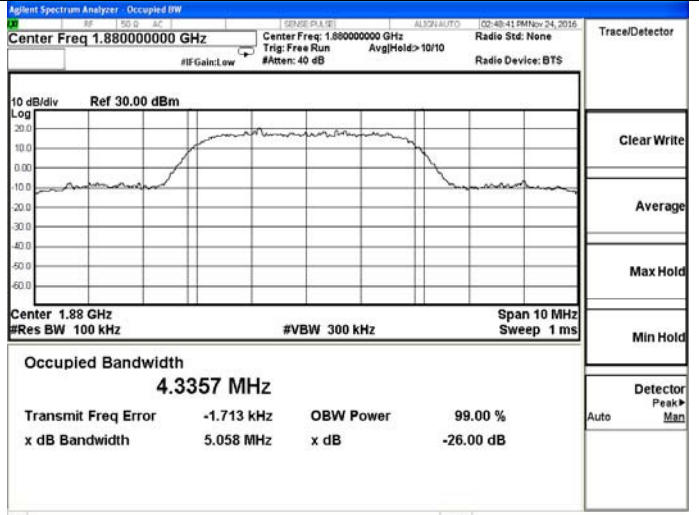
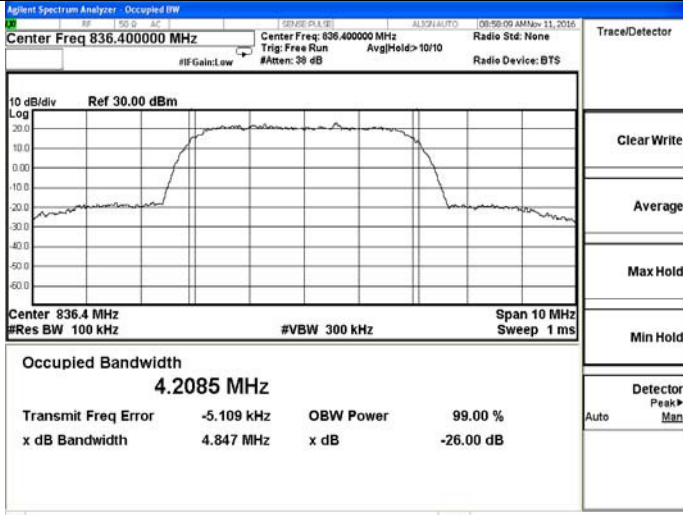

Channel 4183 / 836.6 MHz

Channel 9400 / 1880.0 MHz

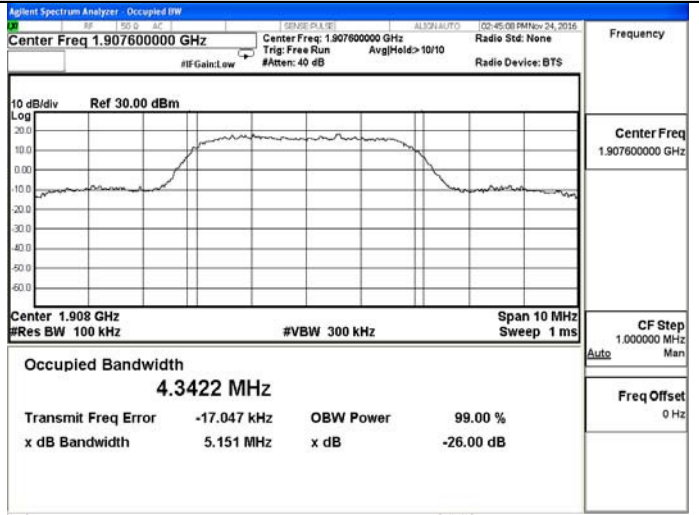
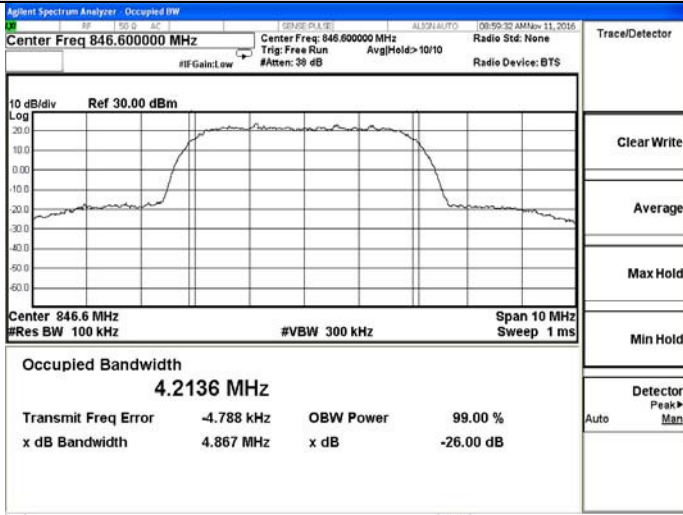

Channel 4233 / 846.6 MHz

Channel 9538 / 1907.6 MHz

4.4 Band Edge Compliance

TEST APPLICABLE

During the process of testing, the EUT was controlled via Digital Radio Communication tester (CMU200) to ensure max power transmission and proper modulation.

TEST CONFIGURATION

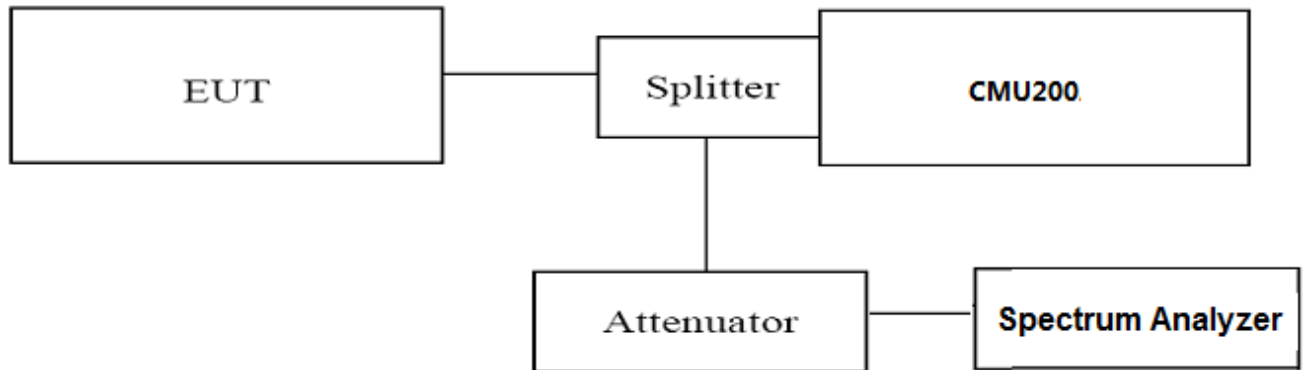

TEST PROCEDURE

1. The EUT was set up for the max output power with pseudo random data modulation;
 2. The power was measured with Spectrum Analyzer N9020A;
 3. Set RBW=100KHz,VBW=300KHz,Span=10MHz,SWT=1.267ms,Detector: RMS;
- These measurements were done at 2 frequencies for WCDMA Band II/IV. (low and high of operational frequency range).

TEST RESULTS

| UMTS/TM1/WCDMA Band V | | | | | |
|------------------------|---------|-----------------|---------------------------|--------------|---------|
| Test Mode | Channel | Frequency (MHz) | Band Edg Compliance (dBm) | Limits (dBm) | Verdict |
| UMTS/TM1/WCDMA Band V | 4132 | 826.40 | <-13dBm | -13dBm | PASS |
| | 4233 | 846.60 | <-13dBm | -13dBm | |
| UMTS/TM1/WCDMA Band II | | | | | |
| Test Mode | Channel | Frequency (MHz) | Band Edg Compliance (dBm) | Limits (dBm) | Verdict |
| UMTS/TM1/WCDMA Band II | 9262 | 1852.40 | <-13dBm | -13dBm | PASS |
| | 9538 | 1907.60 | <-13dBm | -13dBm | |

Remark:

1. Test results including cable loss;
2. please refer to following plots;

Band-edge Compliance

UMTS/TM1/WCDMA Band V

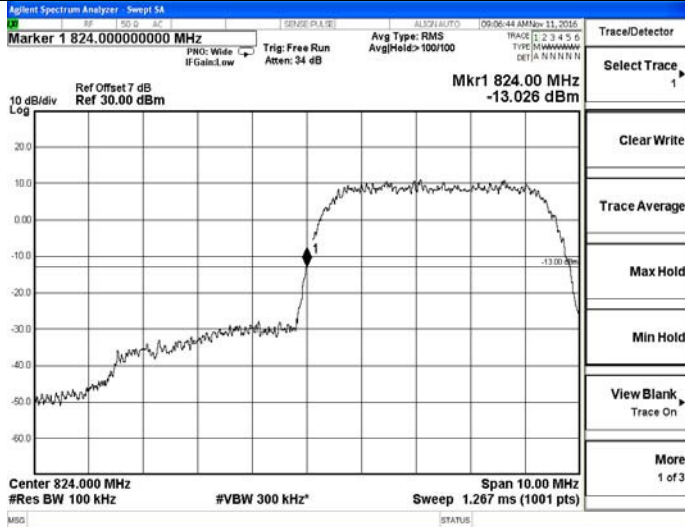

UMTS/TM1/WCDMA Band II

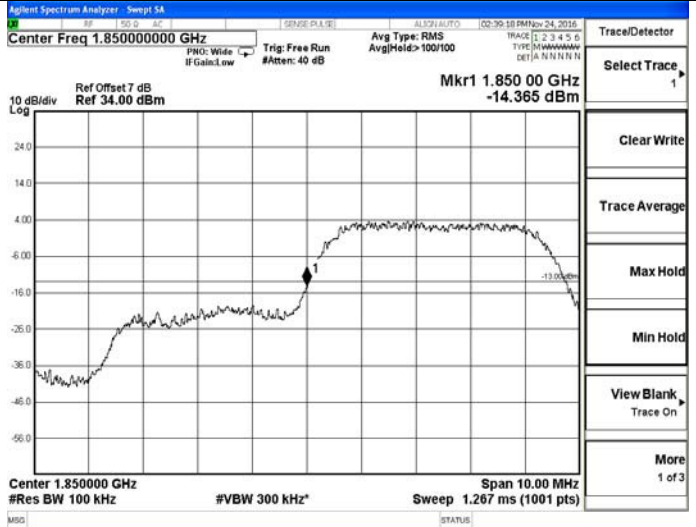

Channel 4132 / 826.4 MHz

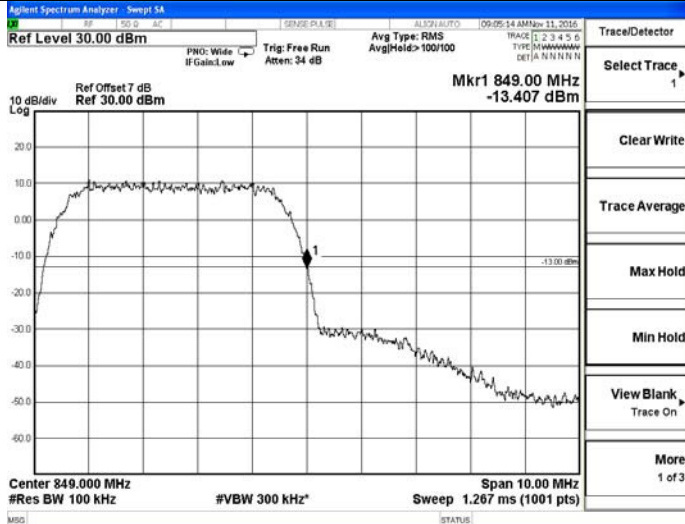

Channel 9262 / 1852.4 MHz



Channel 4233 / 846.6 MHz

Channel 9538 / 1907.6 MHz

4.5 Spurious Emission on Antenna Port

TEST APPLICABLE

The following steps outline the procedure used to measure the conducted emissions from the EUT.

1. Determine frequency range for measurements: From CFR 2.1057 and RSS-GEN the spectrum should be investigated from the lowest radio frequency generated in the equipment up to at least the 10th harmonic of the carrier frequency. For the equipment of WCDMA band II, this equates to a frequency range of 9 KHz to 20GHz, data taken from 30 MHz to 20 GHz. For WCDMA Band V, data taken from 30 MHz to 9 GHz.
2. The sweep time is set automatically by instrument itself. That should be the optimal sweep time for the span and the RBW. If the sweep time is too short, that is sweep is too fast, the sweep result is not accurate; if the sweep time is too long, that is sweep is too low, some frequency components may be lost. The instrument will give an optimal sweep time according the selected span and RBW.
3. The procedure to get the conducted spurious emission is as follows:
The trace mode is set to MaxHold to get the highest signal at each frequency;
Wait 25 seconds;
Get the result.
4. Determine EUT transmit frequencies: below outlines the band edge frequencies pertinent to conducted emissions testing.

TEST CONFIGURATION

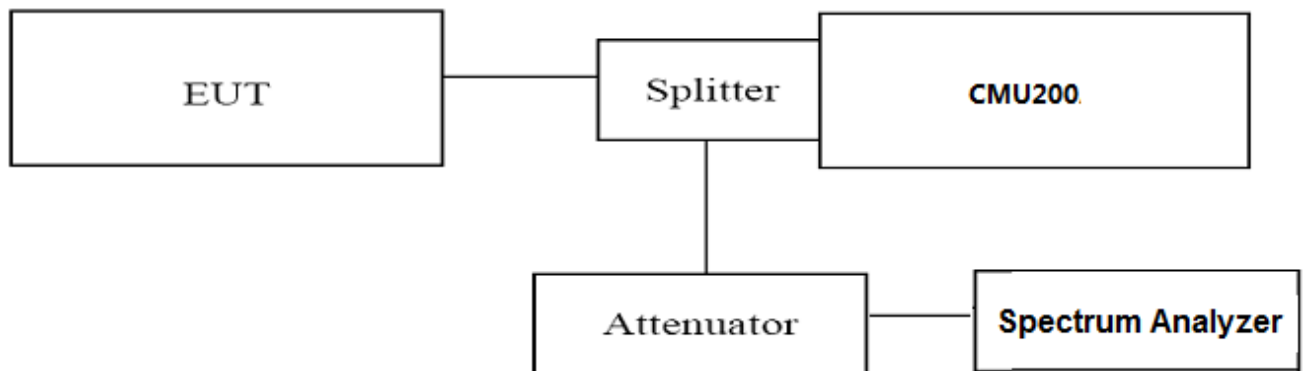

TEST PROCEDURE

1. The EUT was set up for the max output power with pseudo random data modulation;
2. The power was measured with Spectrum Analyzer N9020A;
3. These measurements were done at 3 frequencies for WCDMA band II/IV/V. (low, middle and high of operational frequency range).

TEST LIMIT

Part 24.238, Part 22.917, RSS-132 Issue 3 §5.5 and RSS-133 Issue 6 §6.5 specify that the power of any emission outside of the authorized operating frequency ranges must be attenuated below the transmitting power (P) by a factor of at least $43 + 10 \log(P)$ dB.

The specification that emissions shall be attenuated below the transmitter power (P) by at least $43 + 10 \log(P)$ dB, translates in the relevant power range (1 to 0.001 W) to -13 dBm. At 1 W the specified minimum attenuation becomes 43 dB and relative to a 30 dBm (1 W) carrier becomes a limit of -13 dBm. At 0.001 W (0 dBm) the minimum attenuation is 13 dB, which again yields a limit of -13 dBm. In this way a translation of the specification from relative to absolute terms is carried out.

TEST RESULTS

| Test Mode | Channel | Frequency (MHz) | Spurious RF Conducted Emission (dBm) | Limits (dBm) | Verdict |
|---------------------------|---------|-----------------|--------------------------------------|--------------|---------|
| UMTS/TM1/WCDMA Band V | 4132 | 826.40 | <-13dBm | -13dBm | PASS |
| | 4183 | 836.60 | <-13dBm | -13dBm | |
| | 4233 | 846.60 | <-13dBm | -13dBm | |
| UMTS/TM1/WCDMA Band II | 9262 | 1852.40 | <-13dBm | -13dBm | PASS |
| | 9400 | 1880.00 | <-13dBm | -13dBm | |
| | 9538 | 1907.60 | <-13dBm | -13dBm | |

Remark:

1. Test results including cable loss;
2. Not recored 9 kHz~30MHz as the amplitude of spurious emissions which are attenuated by more than 20 dB below the permissible value.
3. please refer to following plots;

Spurious Emission on Antenna Port
UMTS/TM1/WCDMA Band V

Channel 4132 / 826.4 MHz

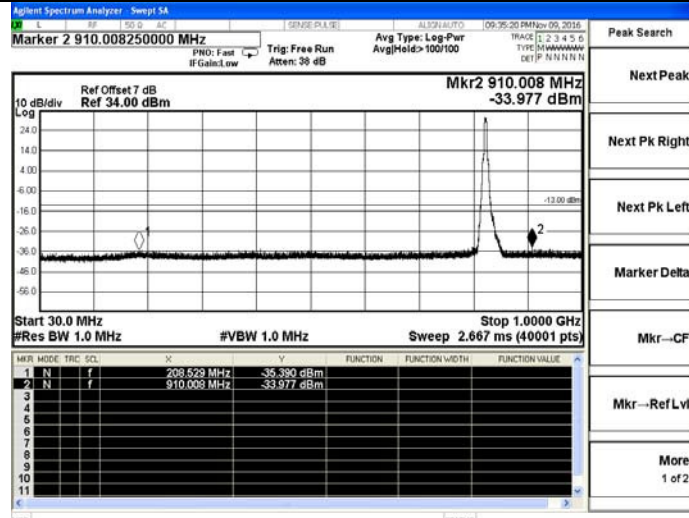

Channel 4183 / 836.6 MHz

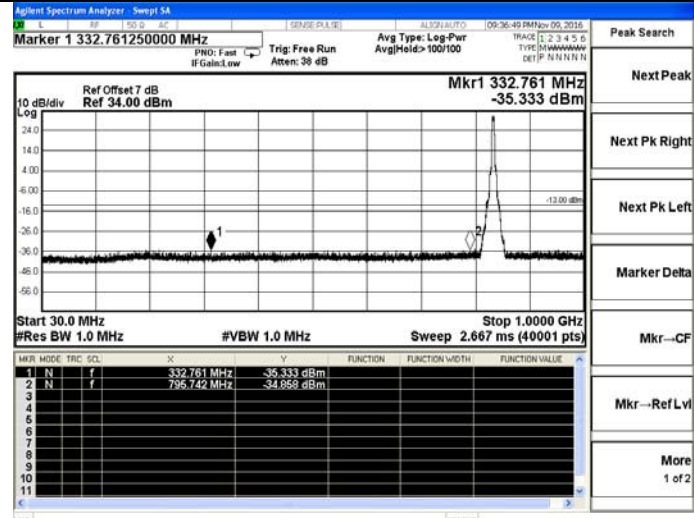

30 MHz – 1000 MHz

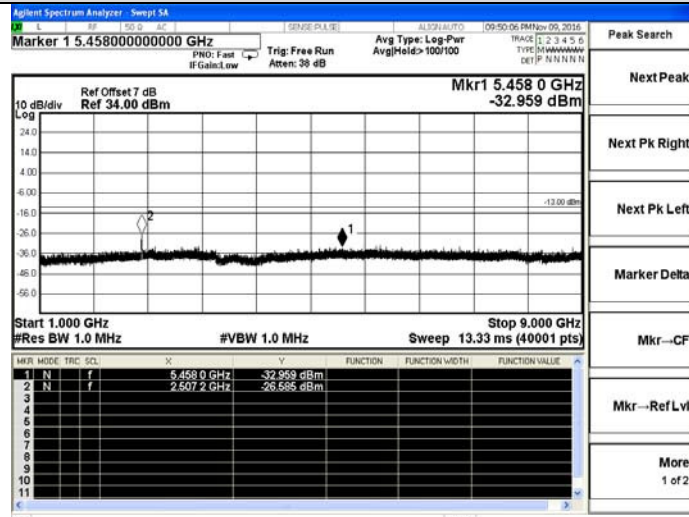

30 MHz – 1000 MHz

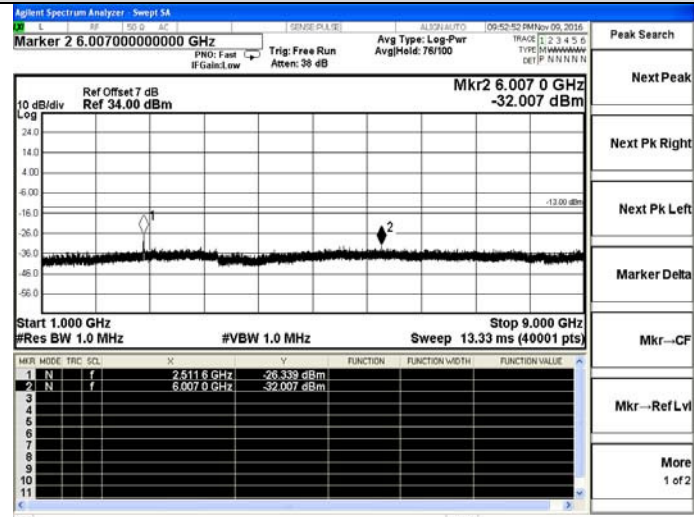

1 GHz – 9 GHz

1 GHz – 9 GHz

UMTS/TM1/WCDMA Band V

Channel 4233 / 846.6 MHz

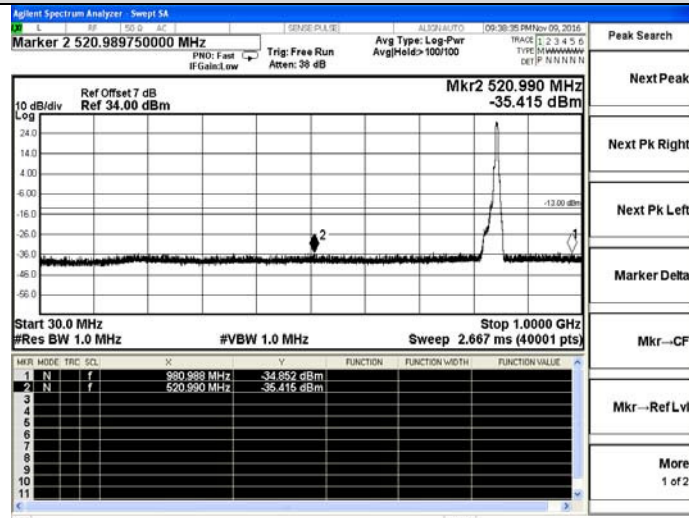

Channel 4233 / 846.6 MHz

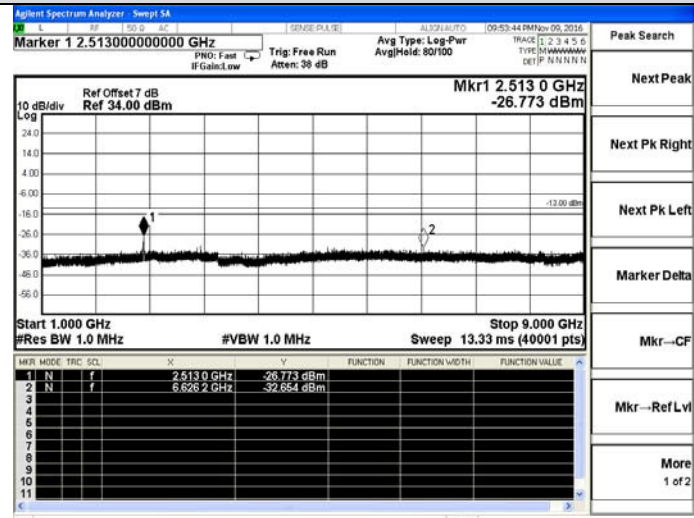

30 MHz – 1000 MHz

1 GHz – 9 GHz

Spurious Emission on Antenna Port
UMTS/TM1/WCDMA Band II

Channel 9262 / 1852.4 MHz

Channel 9400 / 1880.0 MHz

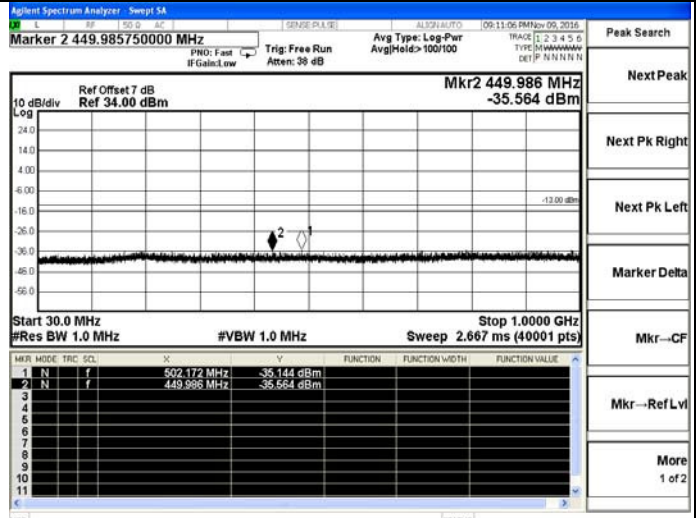
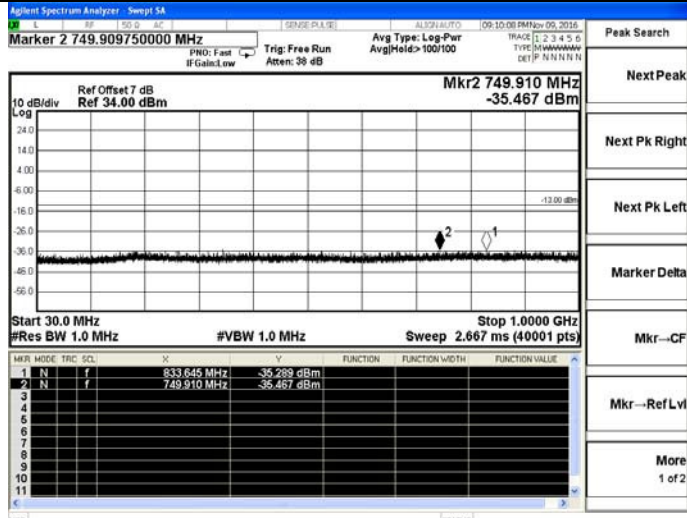

30 MHz – 1000 MHz

30 MHz – 1000 MHz

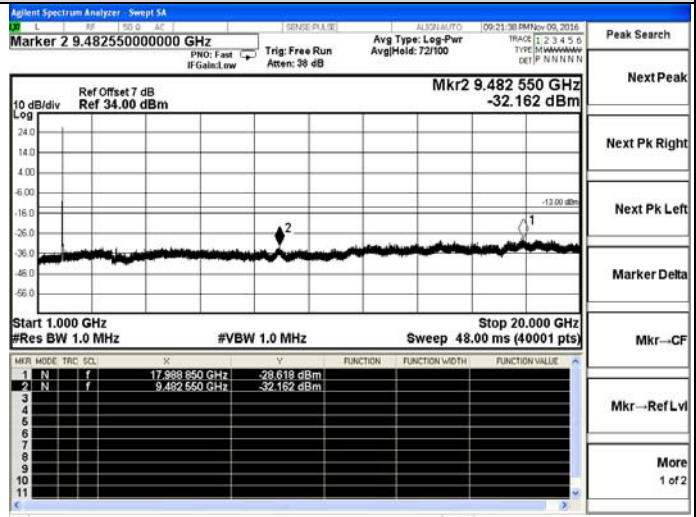
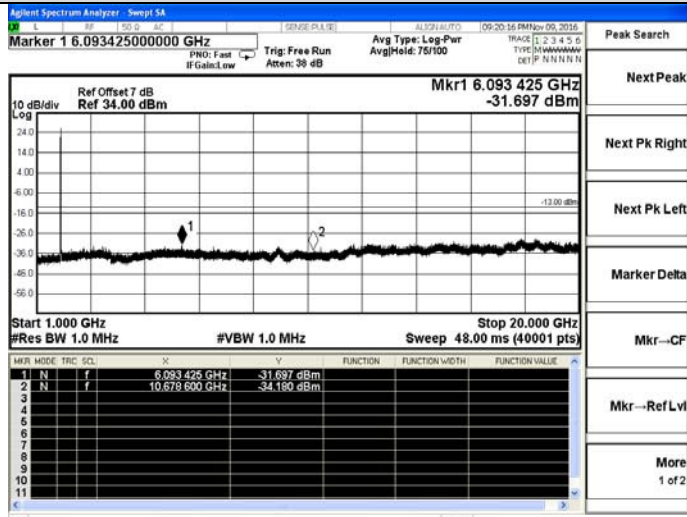

1 GHz – 20 GHz

1 GHz – 20 GHz

UMTS/TM1/WCDMA Band II

Channel 9538 / 1907.6 MHz

Channel 9538 / 1907.6 MHz

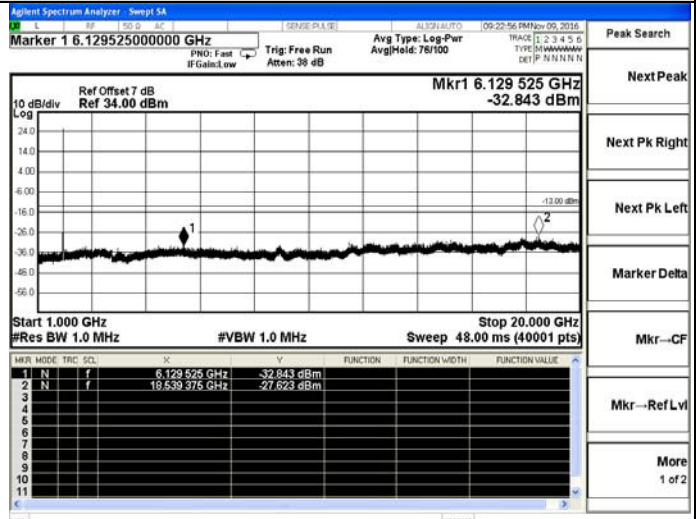
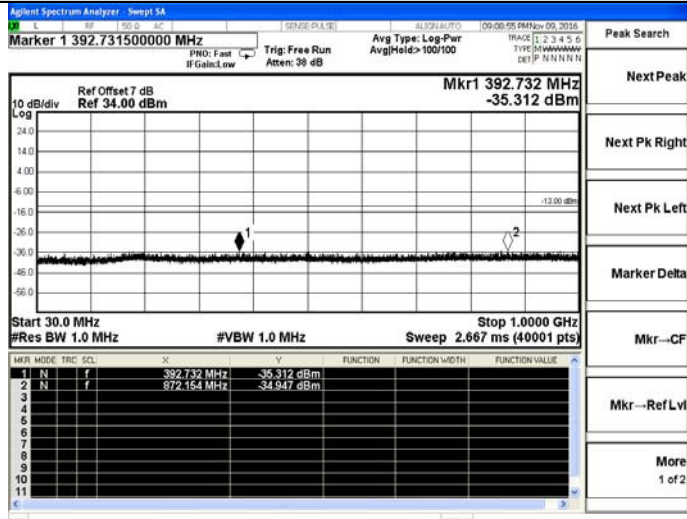

30 MHz – 1000 MHz

1 GHz – 20 GHz

4.6 Frequency Stability Test

TEST APPLICABLE

1. According to FCC Part 2 Section 2.1055 (a)(1) and RSS-GEN, the frequency stability shall be measured with variation of ambient temperature from -30°C to +50°C centigrade.
2. According to FCC Part 2 Section 2.1055 (e)(2) and RSS-GEN, for battery powered equipment, the frequency stability shall be measured with reducing primary supply voltage to the battery operating end point, which is specified by the manufacture.
3. Vary primary supply voltage from 85 to 115 percent of the nominal value for other than hand carried voltage equipment and the end voltage point was 4.50V.

TEST PROCEDURE

In order to measure the carrier frequency under the condition of AFC lock, it is necessary to make measurements with the EUT in a "call mode". This is accomplished with the use of R&S CMU200 DIGITAL RADIO COMMUNICATION TESTER.

1. Measure the carrier frequency at room temperature;
2. Subject the EUT to overnight soak at -30°C;
3. With the EUT, powered via nominal voltage, connected to the CMU200 and in a simulated call on middle channel of WCDMA Band II/IV/V, measure the carrier frequency. These measurements should be made within 2 minutes of Powering up the EUT, to prevent significant self-warming;
4. Repeat the above measurements at 10°C increments from -30°C to +50°C. Allow at least 0.5 hours at each temperature, unpowered, before making measurements;
5. Remeasure carrier frequency at room temperature with nominal voltage. Vary supply voltage from minimum voltage to maximum voltage, in 0.1Volt increments remeasuring carrier frequency at each voltage. Pause at nominal voltage for 0.5 hours unpowered, to allow any self-heating to stabilize, before continuing;
6. Subject the EUT to overnight soak at +50°C;
7. With the EUT, powered via nominal voltage, connected to the CMU200 and in a simulated call on the centre channel, measure the carrier frequency. These measurements should be made within 2 minutes of Powering up the EUT, to prevent significant self-warming;
8. Repeat the above measurements at 10°C increments from +50°C to -30°C. Allow at least 0.5 hours at each temperature, unpowered, before making measurements;
9. At all temperature levels hold the temperature to +/- 0.5°C during the measurement procedure;

TEST CONFIGURATION

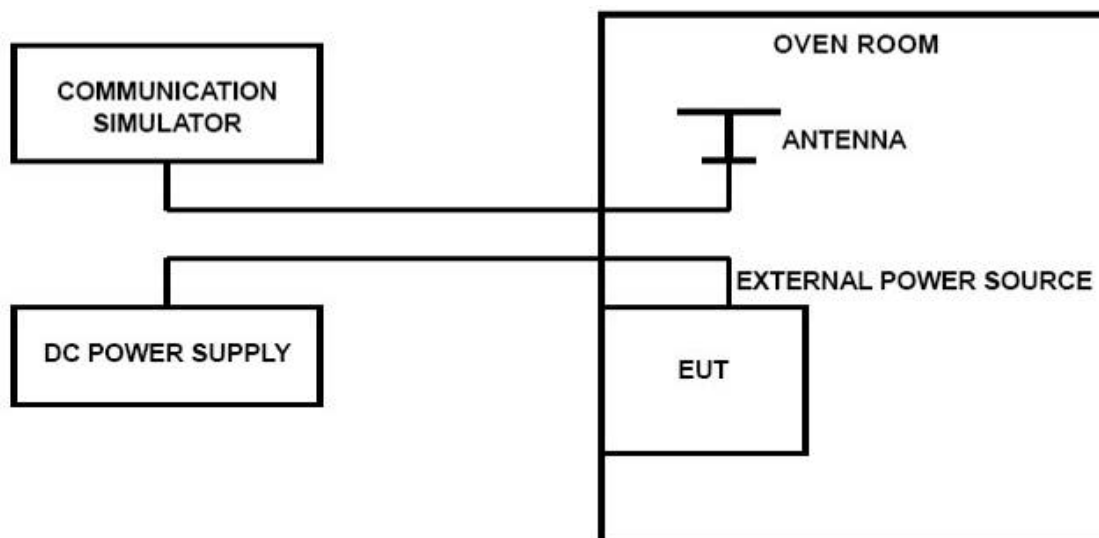

TEST LIMITS**For Hand carried battery powered equipment**

According to the JTC standard the frequency stability of the carrier shall be accurate to within 0.1 ppm of the received frequency from the base station. This accuracy is sufficient to meet Sec. 24.235, Frequency Stability. The frequency stability shall be sufficient to ensure that the fundamental emission stays within the authorized frequency block. As this transceiver is considered "Hand carried, battery powered equipment" Section 2.1055(d)(2) applies. This requires that the lower voltage for frequency stability testing be specified by the manufacturer. This transceiver is specified to operate with an input voltage of between 3.40VDC and 4.20VDC, with a nominal voltage of 3.70DC. Operation above or below these voltage limits is prohibited by transceiver software in order to prevent improper operation as well as to protect components from overstress. These voltages represent a tolerance of -10 % and +12.5 %. For the purposes of measuring frequency stability these voltage limits are to be used.

For equipment powered by primary supply voltage

According to the JTC standard the frequency stability of the carrier shall be accurate to within 0.1 ppm of the received frequency from the base station. This accuracy is sufficient to meet Sec. 24.235, Frequency Stability. The frequency stability shall be sufficient to ensure that the fundamental emission stays within the authorized frequency block. For this EUT section 2.1055(d)(1) applies. This requires varying primary supply voltage from 85 to 115 percent of the nominal value for other than hand carried battery equipment.

TEST RESULTS

| UMTS/TM1/WCDMA Band II | | | | | |
|-------------------------------|-------------------------|----------------------------|-----------------------------|--------------------|----------------|
| DC Power | Temperature (°C) | Frequency error(Hz) | Frequency error(ppm) | Limit (ppm) | Verdict |
| 4.50 | 25 | 15 | 0.018 | 2.50 | PASS |
| 5.00 | 25 | 18 | 0.022 | 2.50 | PASS |
| 5.50 | 25 | 17 | 0.020 | 2.50 | PASS |
| 5.00 | -30 | 12 | 0.014 | 2.50 | PASS |
| 5.00 | -20 | 16 | 0.019 | 2.50 | PASS |
| 5.00 | -10 | 17 | 0.020 | 2.50 | PASS |
| 5.00 | 0 | 15 | 0.018 | 2.50 | PASS |
| 5.00 | 10 | 14 | 0.017 | 2.50 | PASS |
| 5.00 | 20 | 22 | 0.026 | 2.50 | PASS |
| 5.00 | 30 | 16 | 0.019 | 2.50 | PASS |
| 5.00 | 40 | 16 | 0.019 | 2.50 | PASS |
| 5.00 | 50 | 18 | 0.022 | 2.50 | PASS |

| UMTS/TM1/WCDMA Band V | | | | | |
|------------------------------|-------------------------|----------------------------|-----------------------------|--------------------|----------------|
| DC Power | Temperature (°C) | Frequency error(Hz) | Frequency error(ppm) | Limit (ppm) | Verdict |
| 4.50 | 25 | 17 | 0.009 | 2.50 | PASS |
| 5.00 | 25 | 15 | 0.008 | 2.50 | PASS |
| 5.50 | 25 | 18 | 0.010 | 2.50 | PASS |
| 5.00 | -30 | 16 | 0.009 | 2.50 | PASS |
| 5.00 | -20 | 14 | 0.007 | 2.50 | PASS |
| 5.00 | -10 | 12 | 0.006 | 2.50 | PASS |
| 5.00 | 0 | 13 | 0.007 | 2.50 | PASS |
| 5.00 | 10 | 11 | 0.006 | 2.50 | PASS |
| 5.00 | 20 | 16 | 0.009 | 2.50 | PASS |
| 5.00 | 30 | 19 | 0.010 | 2.50 | PASS |
| 5.00 | 40 | 20 | 0.011 | 2.50 | PASS |
| 5.00 | 50 | 17 | 0.009 | 2.50 | PASS |

Note: EUT has been tested to validate that can not work below DC4.5V power supply.

4.7 Peak-to-Average Ratio (PAR)

LIMIT

The Peak-to-Average Ratio (PAR) of the transmission may not exceed 13 dB.

TEST CONFIGURATION

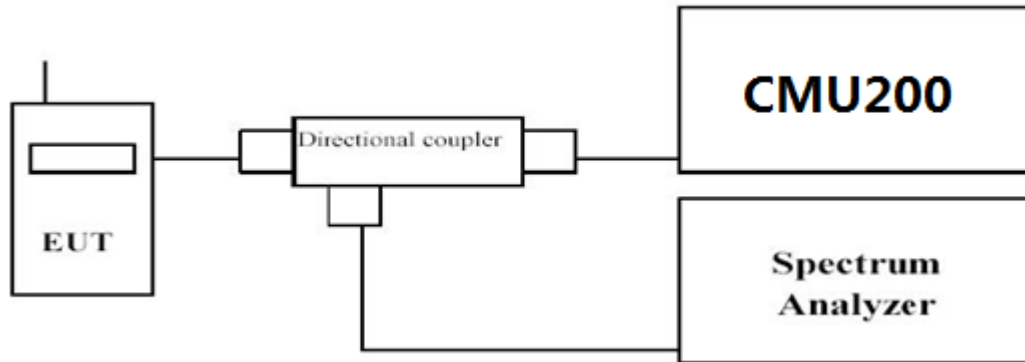

TEST PROCEDURE

1. Refer to instrument's analyzer instruction manual for details on how to use the power statistics/CCDF function;
2. Set resolution/measurement bandwidth \geq signal's occupied bandwidth;
3. Set the number of counts to a value that stabilizes the measured CCDF curve;
4. Set the measurement interval as follows:
 - 1). for continuous transmissions, set to 1 ms,
 - 2). for burst transmissions, employ an external trigger that is synchronized with the EUT burst timing sequence, or use the internal burst trigger with a trigger level that allows the burst to stabilize and set the measurement interval to a time that is less than or equal to the burst duration.
5. Record the maximum PAPR level associated with a probability of 0.1%.

TEST RESULTS

| Test Mode | Channel | Frequency (MHz) | PAPR Value (dB) | Limits (dB) | Verdict |
|----------------------------|---------|-----------------|-----------------|-------------|---------|
| UMTS/TM1/ WCDMA Band II | 9262 | 1852.40 | 1.73 | 13.0 | PASS |
| | 9400 | 1880.00 | 1.81 | 13.0 | PASS |
| | 9538 | 1907.60 | 1.98 | 13.0 | PASS |
| UMTS/TM1/ WCDMA Band V | 4132 | 826.40 | 1.63 | 13.0 | PASS |
| | 4183 | 836.60 | 1.81 | 13.0 | PASS |
| | 4233 | 846.60 | 1.78 | 13.0 | PASS |

Remark:

1. Test results including cable loss;
2. please refer to following plots;

Peak-to-Average Ratio (PAR)

UMTS/TM1/ WCDMA Band II

UMTS/TM1/ WCDMA Band V

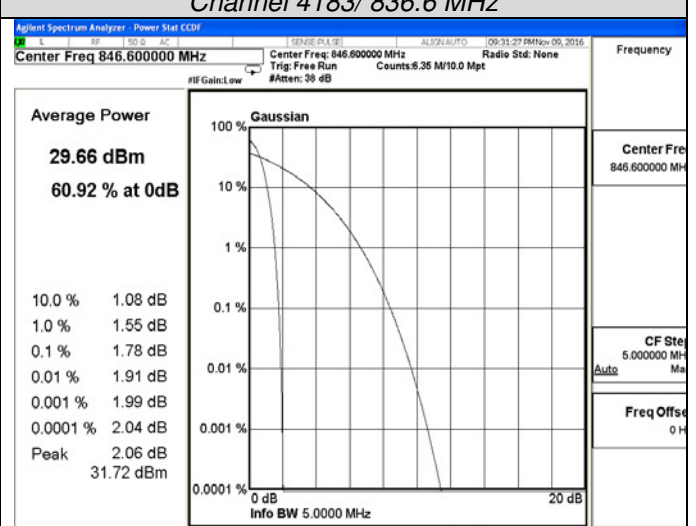
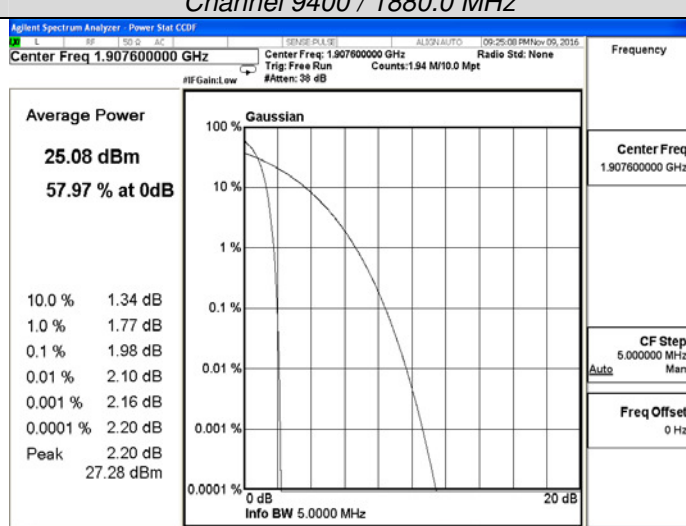
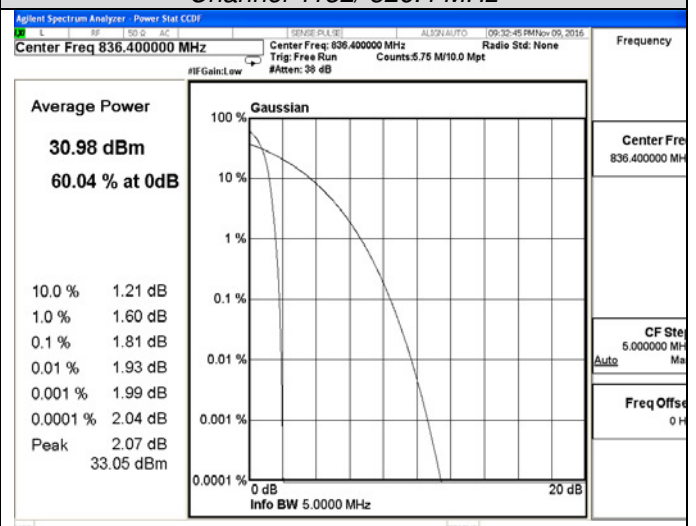
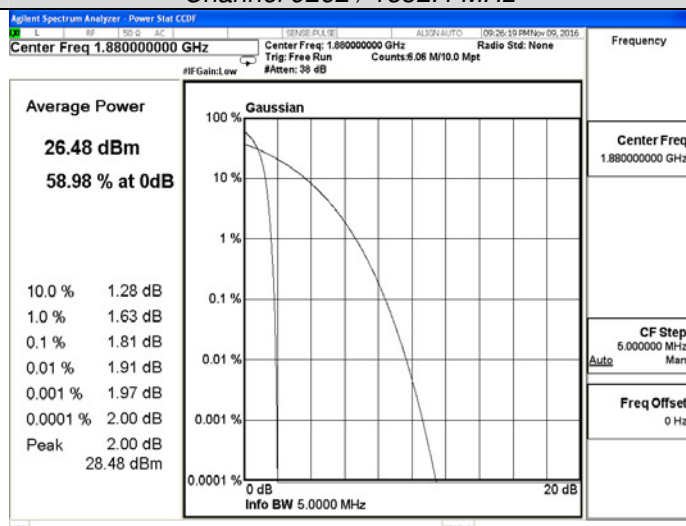
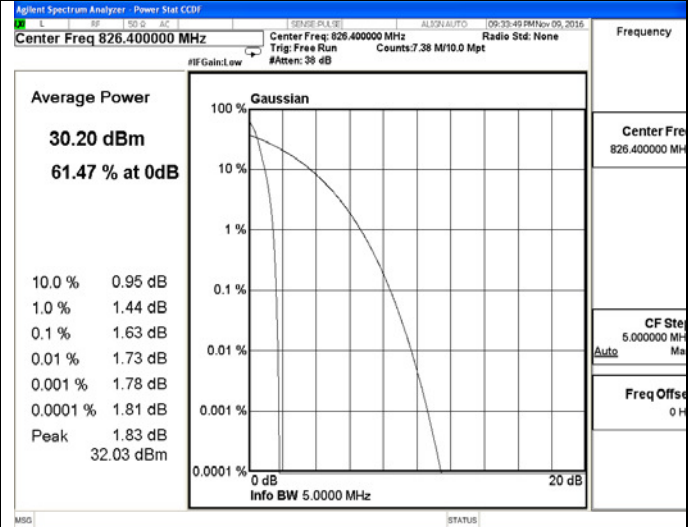
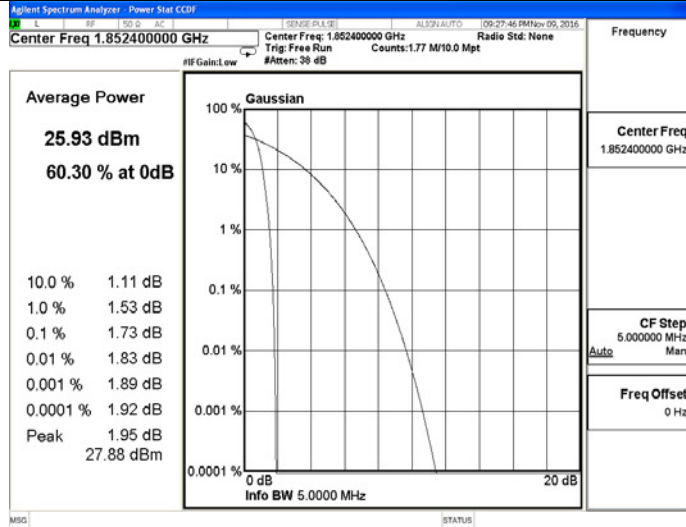

5 Test Setup Photos of the EUT

Please refer to separated files for Test Setup Photos of the EUT.

6 External Photos of the EUT

Please refer to separated files for External Photos of the EUT.

7 Internal Photos of the EUT

Please refer to separated files for Internal Photos of the EUT.

.....**End of Report**.....