



FCC Part 15.247

TEST REPORT

For

Hontus, Ltd.

11450 NW 122ND Street, Building 100 Miami, Florida, USA 33178

Model:
PT001-20IN-SBLK, PT001-20IN-PCFT,
PT001-20IN-PBLK, PT001-20IN-PSLV
FCC ID: 2AKE6SPACECASE-1000

Report Type: Original Report	Product Type: Space Case 1
Report Producer: <u>Kaylee Chiang</u>	<i>Kaylee Chiang</i>
Report Number: <u>RTWA161014001-00A</u>	
Report Date: <u>2016-12-08</u>	
Reviewed By: <u>Jerry Chang</u>	<i>Jerry Chang</i>
Bay Area Compliance Laboratories Corp.(Taiwan) 70, Lane 169, Sec. 2, Datong Road, Xizhi Dist., New Taipei City 22183, Taiwan, R.O.C. Tel: +886 (2) 2647 6898 Fax: +886 (2) 2647 6895 www.bacl.com.tw	

Note: This test report is prepared for the customer shown above and for the device described herein. It may not be duplicated or used in part without prior written consent from Bay Area Compliance Laboratories Corp. (Taiwan)

REVISION HISTORY

Revision	Issue Date	Description
1.0	2016.12.08	Original

TABLE OF CONTENTS

1	GENERAL INFORMATION.....	5
1.1	PRODUCT DESCRIPTION FOR EQUIPMENT UNDER TEST (EUT).....	5
1.2	OBJECTIVE.....	6
1.3	RELATED SUBMITTAL(S)/GRANT(S).....	6
1.4	TEST METHODOLOGY.....	6
1.5	TEST FACILITY.....	6
2	SYSTEM TEST CONFIGURATION.....	7
2.1	DESCRIPTION OF TEST CONFIGURATION.....	7
2.2	EQUIPMENT MODIFICATIONS.....	7
2.3	EUT EXERCISE SOFTWARE.....	7
2.4	SUPPORT EQUIPMENT LIST AND DETAILS.....	7
2.5	EXTERNAL CABLE LIST AND DETAILS.....	7
2.6	BLOCK DIAGRAM OF TEST SETUP.....	8
3	SUMMARY OF TEST RESULTS.....	9
4	FCC §15.247(I) - & 1.1310 & 2.1091 - MAXIMUM PERMISSIBLE EXPOSURE (MPE).....	10
4.1	APPLICABLE STANDARD.....	10
4.2	RF EXPOSURE EVALUATION RESULT.....	11
5	FCC §15.203 – ANTENNA REQUIREMENTS.....	12
5.1	APPLICABLE STANDARD.....	12
5.2	ANTENNA LIST AND DETAILS.....	12
6	FCC §15.207(A) –AC LINE CONDUCTED EMISSIONS.....	13
6.1	APPLICABLE STANDARD.....	13
6.2	MEASUREMENT UNCERTAINTY.....	13
6.3	EUT SETUP.....	13
6.4	EMI TEST RECEIVER SETUP.....	14
6.5	TEST PROCEDURE.....	14
6.6	CORRECTED FACTOR & MARGIN CALCULATION.....	14
6.7	TEST EQUIPMENT LIST AND DETAILS.....	14
6.8	TEST DATA.....	14
7	FCC §15.209, §15.205 , §15.247(D) – SPURIOUS EMISSIONS.....	17
7.1	APPLICABLE STANDARD.....	17
7.2	MEASUREMENT UNCERTAINTY.....	17
7.3	EUT SETUP.....	17
7.4	EMI TEST RECEIVER & SPECTRUM ANALYZER SETUP.....	18
7.5	TEST PROCEDURE.....	18
7.6	CORRECTED FACTOR & MARGIN CALCULATION.....	19
7.7	TEST RESULTS SUMMARY.....	19
7.8	TEST EQUIPMENT LIST AND DETAILS.....	20
7.9	TEST ENVIRONMENTAL CONDITIONS.....	20
7.10	TEST RESULTS.....	21
8	FCC §15.247(A)(1) – 20 DB EMISSION BANDWIDTH.....	40
8.1	APPLICABLE STANDARD.....	40
8.2	TEST PROCEDURE.....	40
8.3	TEST EQUIPMENT LIST AND DETAILS.....	40
8.4	TEST ENVIRONMENTAL CONDITIONS.....	40
8.5	TEST RESULTS.....	41
9	FCC §15.247(A)(1) – CHANNEL SEPARATION TEST.....	46
9.1	APPLICABLE STANDARD.....	46
9.2	TEST PROCEDURE.....	46

9.3	TEST EQUIPMENT LIST AND DETAILS	46
9.4	TEST ENVIRONMENTAL CONDITIONS.....	46
9.5	TEST RESULTS	47
10	FCC §15.247(A)(1)(III) –TIME OF OCCUPANCY (DWELL TIME).....	52
10.1	APPLICABLE STANDARD	52
10.2	TEST PROCEDURE	52
10.3	TEST EQUIPMENT LIST AND DETAILS	52
10.4	TEST ENVIRONMENTAL CONDITIONS.....	52
10.5	TEST RESULTS	53
11	FCC §15.247(A)(1)(III) –QUANTITY OF HOPPING CHANNEL TEST	68
11.1	APPLICABLE STANDARD	68
11.2	TEST PROCEDURE	68
11.3	TEST EQUIPMENT LIST AND DETAILS	68
11.4	TEST ENVIRONMENTAL CONDITIONS.....	68
11.5	TEST RESULTS	69
12	FCC §15.247(B)(1) – MAXIMUM OUTPUT POWER	71
12.1	APPLICABLE STANDARD	71
12.2	TEST PROCEDURE	71
12.3	TEST EQUIPMENT LIST AND DETAILS	71
12.4	TEST ENVIRONMENTAL CONDITIONS.....	71
12.5	TEST RESULTS	72
13	FCC §15.247(D) – 100 KHZ BANDWIDTH OF FREQUENCY BAND EDGE	78
13.1	APPLICABLE STANDARD	78
13.2	TEST PROCEDURE	78
13.3	TEST EQUIPMENT LIST AND DETAILS	78
13.4	TEST ENVIRONMENTAL CONDITIONS.....	78
13.5	TEST RESULTS	79

1 General Information

1.1 Product Description for Equipment Under Test (EUT)

Applicant: Hontus, Ltd.
11450 NW 122ND Street, Building 100 Miami, Florida, USA 33178

Manufacturer: Might Electronic Co., Ltd.
No 40, 2nd Neighborhood, Yuanshan Vlg., Xinfeng Township,
Hsinchu County 30441, Taiwan, R.O.C

Product: Space Case 1

Model: PT001-20IN-SBLK, PT001-20IN-PCFT, PT001-20IN-PBLK,
PT001-20IN-PSLV

Trade Name: PLANET TRAVELER

Frequency Range: 2402-2480 MHz

Transmit Power: BT BDR(GFSK) Mode: 5.32 dBm (0.00340W)
BT EDR($\pi/4$ -DQPSK) Mode: 5.67 dBm(0.00369W)
BT EDR(8-DPSK) Mode: 6.32 dBm (0.00429W)

Modulation Technique: BT BDR Mode: GFSK
BT EDR Mode: $\pi/4$ -DQPSK
BT EDR Mode: 8-DPSK

Transmit Data Rate: BT BDR(GFSK) Mode: 1 Mbps
BT EDR ($\pi/4$ -DQPSK) Mode: 2 Mbps
BT EDR (8-DPSK) Mode: 3 Mbps

Number of Channels: BT Mode: 79 Channels

Antenna Specification: PCB Antenna/Gain: 1.927 dBi

Voltage Range: 5Vdc from USB

Date of Test: Oct 24, 2016~ Dec 08, 2016

**All measurement and test data in this report was gathered from production sample serial number: 161014001
(Assigned by BAACL, Taiwan) The EUT supplied by the applicant was received on 2016-10-14*

Model Difference: The major electrical and mechanical constructions of series models are identical to the basic model, except different appearance color. The model, PT001-20IN-SBLK is the testing sample, and the final test data are shown on this test report.

1.2 Objective

This report is prepared on behalf of *Hontus, Ltd.* in accordance with Part 2, Subpart J, Part 15, Subparts A, B and C of the Federal Communication Commission's rules.

The tests were performed in order to determine the Bluetooth BDR and EDR mode of EUT compliance with FCC Part 15, Subpart C, and section 15.203, 15.205, 15.207, 15.209 and 15.247 rules.

1.3 Related Submittal(s)/Grant(s)

FCC Part 15.247 DTS submission with FCC ID: 2AKE6SPACECASE-1000

1.4 Test Methodology

All measurements contained in this report were conducted with ANSI C63.10-2013, American National Standard of Procedures for Compliance Testing of Unlicensed Wireless Devices

1.5 Test Facility

The Test site used by Bay Area Compliance Laboratories Corp. (Taiwan) to collect test data is located on the 70, Lane 169, Sec. 2, Datong Road, Xizhi Dist., New Taipei City 22183, Taiwan, R.O.C.

Test site at Bay Area Compliance Laboratories Corp. (Taiwan) has been fully described in reports submitted to the Federal Communication Commission (FCC). The details of these reports have been found to be in compliance with the requirements of Section 2.948 of the FCC Rules on December 06, 2014. The facility also complies with the radiated and AC line conducted test site criteria set forth in ANSI C63.10.

The Federal Communications Commission has the reports on file and is listed under FCC Registration No.: 431084. The test site has been approved by the FCC for public use and is listed in the FCC Public Access Link (PAL) database.

2 System Test Configuration

2.1 Description of Test Configuration

For BT mode, 79 channels are provided to testing:

Channel	Frequency (MHz)	Channel	Frequency (MHz)
1	2402	40	2441
2	2403	--	--
3	2404	--	--
4	2405	77	2478
--	--	78	2479
39	2440	79	2480

2.2 Equipment Modifications

No modification was made to the EUT

2.3 EUT Exercise Software

Used "ISrt Ver.2.1.26.4422" software.

Test Software Version		Engineering Mode		
Test Frequency		2402MHz	2441MHz	2480MHz
Power Level Setting	GFSK	0	0	0
	$\pi/4$ -DQPSK	0	0	0
	8DPSK	0	0	0

2.4 Support Equipment List and Details

Description	Manufacturer	Model Number	BSMI	FCC ID	S/N
NB	DELL	E6410	N/A	N/A	10912240367

2.5 External Cable List and Details

Cable Description	Length (m)	From	To
Mini USB Cable	1.5	NB	EUT

2.6 Block Diagram of Test Setup

See test photographs attached in Exhibit A for the actual connections between EUT and support equipment.

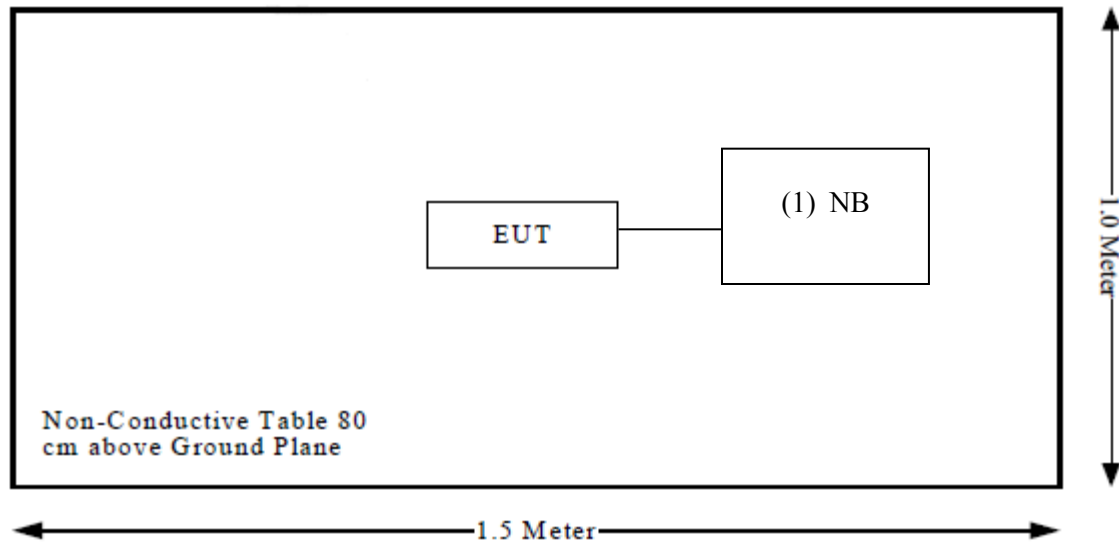

Above 1GHz:

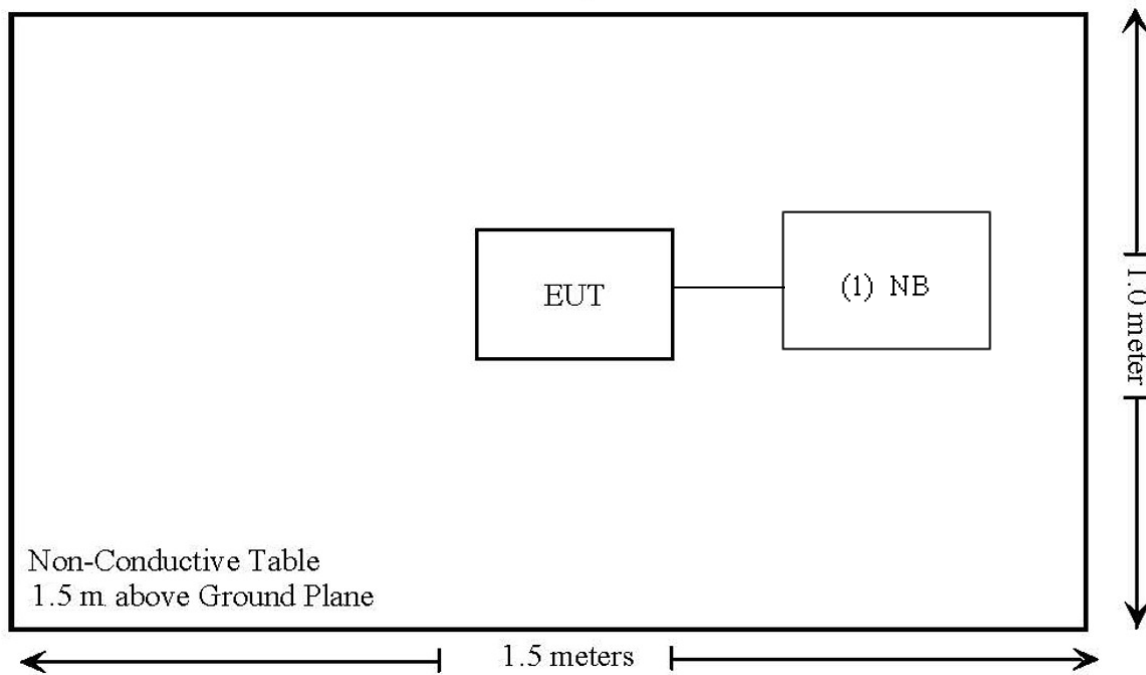

3 Summary of Test Results

FCC Rules	Description of Test	Result
§15.247(i), §1.1310 ,§2.1091	Maximum Permissible Exposure (MPE)	Compliance
§15.203	Antenna Requirement	Compliance
§15.207(a)	AC Line Conducted Emissions	Compliance
§15.205, §15.209, §15.247(d)	Spurious Emissions	Compliance
§15.247(a)(1)	20 dB Emission Bandwidth	Compliance
§15.247 (a)(1)	Channel Separation Test	Compliance
§15.247(a)(1)(iii)	Time of Occupancy (Dwell Time)	Compliance
§15.247(a)(1)(iii)	Quantity of hopping channel Test	Compliance
§15.247(b)(3)	Maximum Peak Output Power	Compliance
§15.247(d)	100 kHz Bandwidth of Frequency Band Edge	Compliance

4 FCC §15.247(i) - & 1.1310 & 2.1091 - MAXIMUM PERMISSIBLE EXPOSURE (MPE)

4.1 Applicable Standard

According to subpart 15.247(i) and subpart §1.1310, systems operating under the provisions of this section shall be operated in a manner that ensures that the public is not exposed to radio frequency energy level in excess of the Commission’s guidelines.

Limits for Maximum Permissible Exposure (MPE) (§1.1310, §2.1091)

(B) Limits for General Population/Uncontrolled Exposure				
Frequency Range (MHz)	Electric Field Strength (V/m)	Magnetic Field Strength (A/m)	Power Density (mW/cm ²)	Averaging Time (minutes)
0.3–1.34	614	1.63	*(100)	30
1.34–30	824/f	2.19/f	*(180/f ²)	30
30–300	27.5	0.073	0.2	30
300–1500	/	/	f/1500	30
1500–100,000	/	/	1.0	30

f = frequency in MHz; * = Plane-wave equivalent power density;

According to §1.1310 and §2.1091 RF exposure is calculated.

Calculated Formulary:

Predication of MPE limit at a given distance

$S = PG/4\pi R^2$ = power density (in appropriate units, e.g. mW/cm²);

P = power input to the antenna (in appropriate units, e.g., mW);

G = power gain of the antenna in the direction of interest relative to an isotropic radiator, the power gain factor, is normally numeric gain;

R = distance to the center of radiation of the antenna (appropriate units, e.g., cm);

For simultaneously transmit system, the calculated power density should comply with:

$$\sum_i \frac{S_i}{S_{Limit,i}} \leq 1$$

4.2 RF Exposure Evaluation Result

3G Module FCC ID: R17HE910GL

Worse case:

MPE evaluation for single transmission:

Mode	Frequency Range (MHz)	Antenna Gain		Tune up Power		Evaluation Distance (cm)	Power Density (mW/cm ²)	MPE Limit (mW/cm ²)
		(dBi)	(numeric)	(dBm)	(mW)			
BT	2402-2480	1.927	1.558	6.5	4.467	20	0.00138	1.0
BLE	2402-2480	3.45	2.213	0	1.000	20	0.00044	1.0
3G	824-849	1.74	1.493	24.00	251.189	20	0.07460	0.56
3G	1850-1910	2.37	1.726	24.00	251.189	20	0.08624	1.0
3G	1710-1755	0.64	1.159	24.00	251.189	20	0.05791	1.0

MPE evaluation for simultaneous transmission:

BT ,BLE and 3G can transmit at the same time, MPE evaluation is as below formula:

$PD1/Limit1+PD2/Limit2+..... < 1$, PD (Power Density)

Worse case MPE evaluation= MPE of BT/1 + MPE of 3G/0.56 = 0.00138/1+0.00044/1+ 0.07460/0.56=0.13503 < 1.0

Result: RF exposure evaluation of single and simultaneous transmission meet FCC limit at 20 cm distance.

5 FCC §15.203 – Antenna Requirements

5.1 Applicable Standard

According to § 15.203,

An intentional radiator shall be designed to ensure that no antenna other than that furnished by the responsible party shall be used with the device. The use of a permanently attached antenna or of an antenna that uses a unique coupling to the intentional radiator shall be considered sufficient to comply with the provisions of this section. The manufacturer may design the unit so that a broken antenna can be replaced by the user, but the user of a standard antenna jack or electrical connector is prohibited.

And according to FCC 47 CFR section 15.247 (b), if the transmitting antennas of directional gain greater than 6dBi are used, the power shall be reduced by the amount in dB that the directional gain of the antenna does not exceed 6 dBi.

5.2 Antenna List and Details

Manufacturer	Model	Type	Antenna Gain	Result
Microchip Technology Inc.	BM23	PCB Antenna	1.927 dBi	Compliance

The EUT has one integral antenna arrangement, which was permanently attached; fulfill the requirement of this section. Please refer to the internal photos.

6 FCC §15.207(a) –AC Line Conducted Emissions

6.1 Applicable Standard

According to §15.207

6.2 Measurement Uncertainty

Input quantities to be considered for conducted disturbance measurements maybe receiver reading, attenuation of the connection between LISN/ISN and receiver, LISN/ISN voltage division factor, LISN/ISN VDF frequency interpolation and receiver related input quantities, etc.

Based on CISPR 16-4-2:2011, the expended combined standard uncertainty of conducted disturbance test at Bay Area Compliance Laboratories Corp. (Taiwan) is shown as below. And the uncertainty will not be taken into consideration for the test data recorded in the report

Table 1 – Values of U_{cispr}

Measurement	U_{cispr}
Conducted disturbance at mains port using AMN (150 kHz to 30 MHz)	2.71B

6.3 EUT Setup

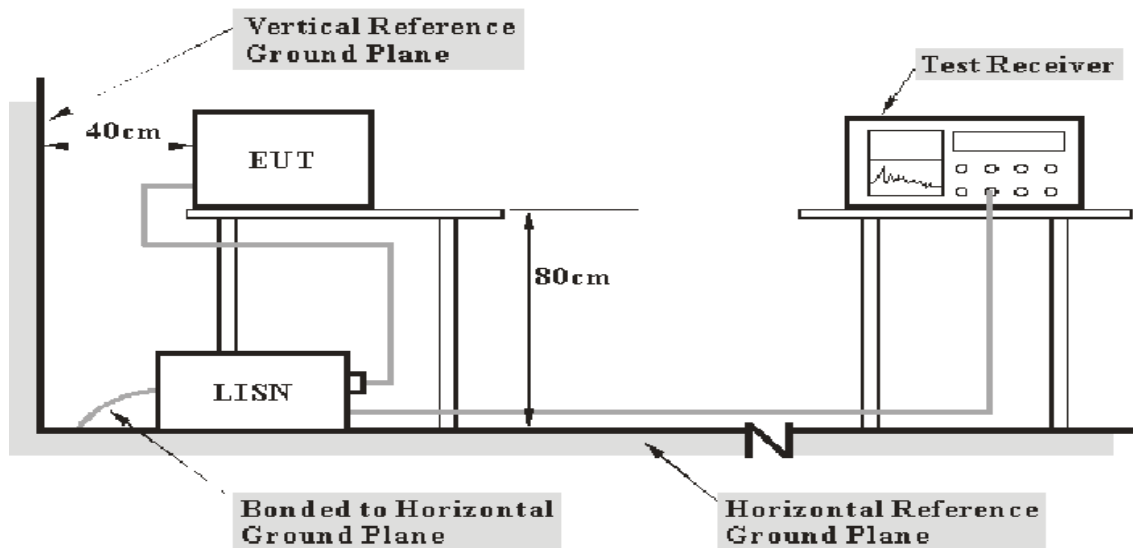

- Note:**
1. Support units were connected to second LISN.
 2. Both of LISNs (AMN) 80 cm from EUT and at the least 80 cm from other units and other metal planes support units.

The setup of EUT is according with per ANSI C63.4-2014 measurement procedure. The specification used was with the FCC Part 15.207 limits.

The spacing between the peripherals was 10 cm.

6.4 EMI Test Receiver Setup

The EMI test receiver was set to investigate the spectrum from 150 kHz to 30 MHz.

During the conducted emission test, the EMI test receiver was set with the following configurations

Frequency Range	IF B/W
150 kHz – 30 MHz	9 kHz

6.5 Test Procedure

During the conducted emission test, the adapter was connected to the outlet of the LISN.

Maximizing procedure was performed on the six (6) highest emissions of the EUT.

All data was recorded in the Quasi-peak and average detection mode.

6.6 Corrected Factor & Margin Calculation

The basic equation is as follows:

$$V_C = V_R + A_c + VDF$$

Herein,

V_C : corrected voltage amplitude

V_R : reading voltage amplitude

A_c : attenuation caused by cable loss

VDF : voltage division factor of AMN or ISN

The “**Over Limit**” column of the following data tables indicates the degree of compliance within the applicable limit. For example, a margin of -7dB means the emission is 7dB below the maximum limit.

The equation for margin calculation is as follows:

$$\text{Over Limit} = \text{Level} - \text{Limit Line}$$

6.7 Test Equipment List and Details

Manufacturer	Description	Model	Serial Number	Calibration Date	Calibration Due Date
LISN	Rohde & Schwarz	ENV216	101248	2016/7/27	2017/7/26
LISN	EMCO	3816/2	75848	2016/8/4	2017/8/3
EMI Test Receiver	Rohde & Schwarz	ESCI	100540	2016/7/22	2017/7/21
Pulse Limiter	Rohde & Schwarz	ESH3Z2	TXZEM025	2016/8/19	2017/8/18
RF Cable	EMEC	EM-CB5D	001	2016/7/27	2017/7/26
Software	AUDIX	E3	V9.150826k	N.C.R	N.C.R

6.8 Test Data

Environmental Conditions

Temperature:	25 °C
Relative Humidity:	55 %
ATM Pressure:	101.0 kPa

The testing was performed by David. Hsu on 2016-11-03.

Test Mode: Transmitting
 AC120 V, 60 Hz, Line:

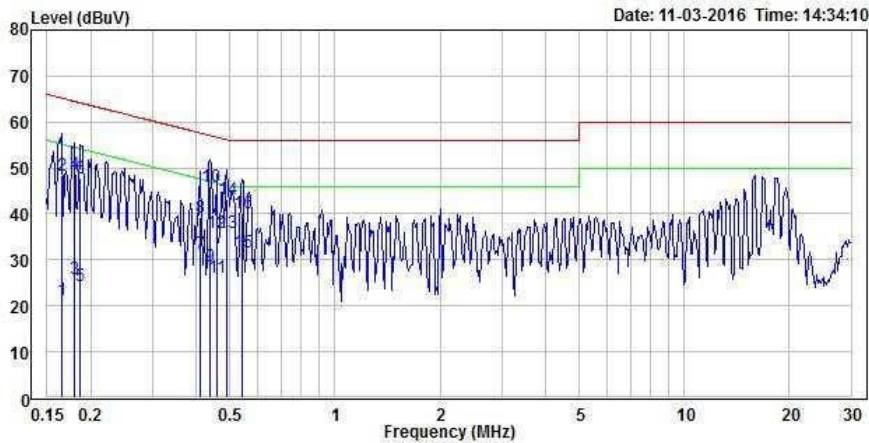

Condition: Line

EUT :

Mode :

Note : 120V/60Hz

	Freq	Level	Limit Line	Over Limit	Factor	Read Level	Remark	Pol/Phase
	MHz	dBuV	dBuV	dB	dB	dBuV		
1	0.165	21.32	55.21	-33.89	19.57	1.75	Average	Line
2	0.165	48.51	65.21	-16.70	19.57	28.94	QP	Line
3	0.180	25.94	54.48	-28.54	19.57	6.37	Average	Line
4	0.180	48.65	64.48	-15.83	19.57	29.08	QP	Line
5	0.186	24.19	54.21	-30.02	19.57	4.62	Average	Line
6	0.186	47.65	64.21	-16.56	19.57	28.08	QP	Line
7	0.413	31.35	47.60	-16.25	19.54	11.81	Average	Line
8	0.413	39.39	57.60	-18.21	19.54	19.85	QP	Line
9	0.440	28.57	47.07	-18.50	19.54	9.03	Average	Line
10	0.440	45.91	57.07	-11.16	19.54	26.37	QP	Line
11	0.458	26.17	46.74	-20.57	19.55	6.62	Average	Line
12	0.458	35.88	56.74	-20.86	19.55	16.33	QP	Line
13	0.492	35.92	46.14	-10.22	19.55	16.37	Average	Line
14	0.492	43.29	56.14	-12.85	19.55	23.74	QP	Line
15	0.541	31.56	46.00	-14.44	19.55	12.01	Average	Line
16	0.541	40.05	56.00	-15.95	19.55	20.50	QP	Line

AC120 V, 60 Hz, Neutral:

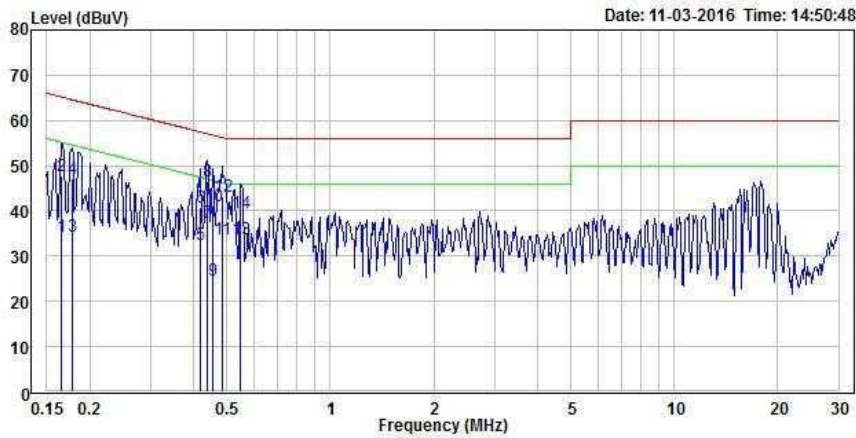

Condition: Neutral

EUT :
 Mode :
 Note : 120V/60Hz

	Freq	Level	Limit	Over	Read			
	MHz	dBuV	dBuV	dB	dB	dBuV	Remark	Pol/Phase
1	0.165	34.27	55.21	-20.94	19.55	14.72	Average	Neutral
2	0.165	47.83	65.21	-17.38	19.55	28.28	QP	Neutral
3	0.177	34.46	54.61	-20.15	19.54	14.92	Average	Neutral
4	0.177	47.27	64.61	-17.34	19.54	27.73	QP	Neutral
5	0.419	32.70	47.46	-14.76	19.54	13.16	Average	Neutral
6	0.419	40.90	57.46	-16.56	19.54	21.36	QP	Neutral
7	0.440	37.40	47.07	-9.67	19.54	17.86	Average	Neutral
8	0.440	46.39	57.07	-10.68	19.54	26.85	QP	Neutral
9	0.454	24.49	46.80	-22.31	19.54	4.95	Average	Neutral
10	0.454	41.14	56.80	-15.66	19.54	21.60	QP	Neutral
11	0.484	33.77	46.27	-12.50	19.55	14.22	Average	Neutral
12	0.484	43.17	56.27	-13.10	19.55	23.62	QP	Neutral
13	0.550	33.62	46.00	-12.38	19.55	14.07	Average	Neutral
14	0.550	39.59	56.00	-16.41	19.55	20.04	QP	Neutral

7 FCC §15.209, §15.205 , §15.247(d) – Spurious Emissions

7.1 Applicable Standard

FCC§15.247 (d); §15.209; §15.205

7.2 Measurement Uncertainty

All measurements involve certain levels of uncertainties, especially in field of EMC. The factors contributing to uncertainties are spectrum analyzer, cable loss, antenna factor calibration, antenna directivity, antenna factor variation with height, antenna phase center variation, antenna factor frequency interpolation, measurement distance variation, site imperfections, mismatch (average), and system repeatability.

Based on CISPR 16-4-2:2011, the expended combined standard uncertainty of radiation emissions at Bay Area Compliance Laboratories Corp. (Taiwan) is shown in below table. And the uncertainty will not be taken into consideration for the test data recorded in the report.

Frequency	Measurement uncertainty
30 MHz~200 MHz	4.21 dB (k=2, 95% level of confidence)
200 MHz~1 GHz	4.41 dB (k=2, 95% level of confidence)
1 GHz~6 GHz	4.51 dB (k=2, 95% level of confidence)
6 GHz~18 GHz	4.88 dB (k=2, 95% level of confidence)
18 GHz~26 GHz	4.30 dB (k=2, 95% level of confidence)
26 GHz~40 GHz	4.30 dB (k=2, 95% level of confidence)

7.3 EUT Setup

Blow 1 GHz:

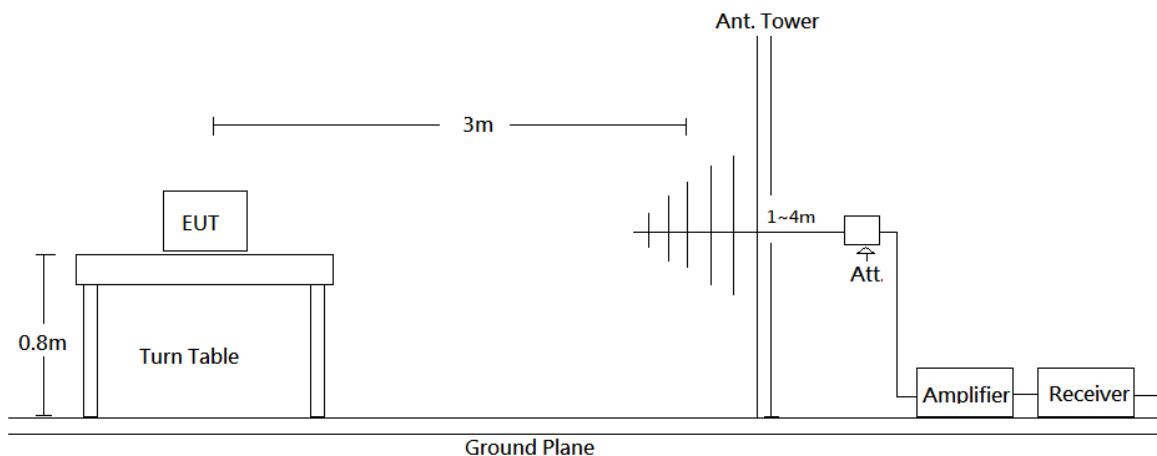

Above 1 GHz:

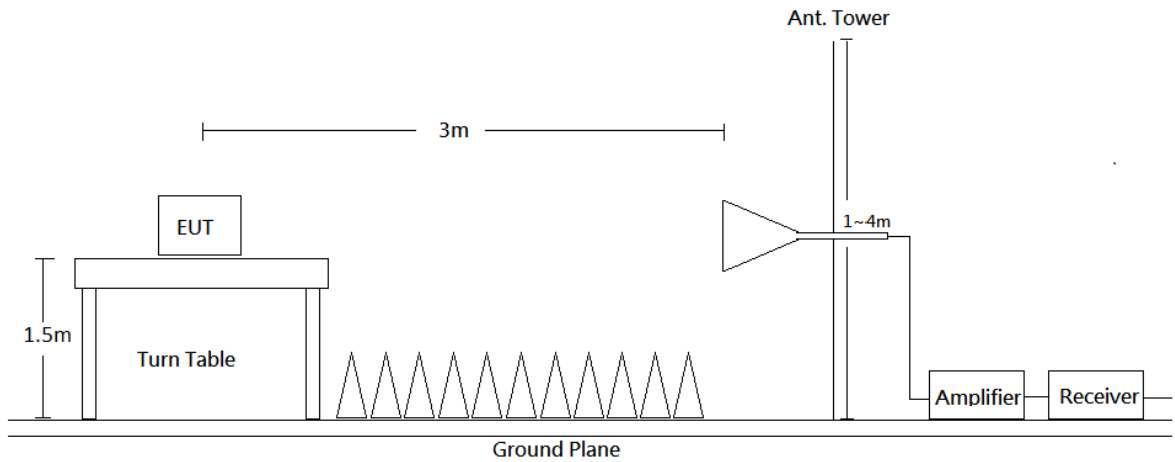

Radiated emission tests were performed in the 3 meters chamber test site, using the setup accordance with the ANSI C63.10-2013. The specification used was the FCC Part 15.209 and FCC 15.247 Limits.

7.4 EMI Test Receiver & Spectrum Analyzer Setup

The system was investigated from 30 MHz to 26.5 GHz. During the radiated emission test, the EMI test receiver was set with the following configurations measurement method 6.3 in ANSI C63.10.

Set RBW = 1 MHz, VBW= 3MHz for $f > 1$ GHz for peak measurement. For average measurement: VBW = 10 Hz, when duty cycle is no less than 98 percent. $VBW \geq 1/T$, when duty cycle is less than 98 percent where T is the minimum transmission duration over which the transmitter is on and is transmitting at its maximum power control level for the tested mode of operation.

Frequency Range	RBW	VBW	IF BW	Detector
30-1000 MHz	100 kHz	300 kHz	120 kHz	QP
Above 1 GHz	1 MHz	3 MHz	/	PK
	1 MHz	10 Hz	/	Ave

7.5 Test Procedure

Maximizing procedure was performed on the highest emissions to ensure that the EUT complied with all installation combinations.

All data was recorded in the Quasi-peak detector mode from 30 MHz to 1 GHz and PK and average detector modes for frequencies above 1 GHz.

7.6 Corrected Factor & Margin Calculation

The Correct Factor is calculated by adding the Antenna Factor and Cable Loss, and subtracting the Amplifier Gain from the Meter Reading. The basic equation is as follows:

$$\text{Correct Factor} = \text{Antenna Factor} + \text{Cable Loss} - \text{Amplifier Gain}$$

The “Margin” column of the following data tables indicates the degree of compliance with the applicable limit. For example, a margin of -7 dB means the emission is 7 dB below the limit. The equation for margin calculation is as follows:

$$\text{Margin} = \text{Result} - \text{Limit}$$

7.7 Test Results Summary

According to the data in the following table, the EUT complied with the FCC §15.209 Limit. Refer to CISPR16-4-2:2011 and CISPR 16-4-1:2009, the measured level complies with the limit if

$$L_m + U(L_m) \leq L_{lim} + U_{cispr}$$

In BACL, $U(L_m)$ is less than U_{cispr} , if L_m is less than L_{lim} , it implies that the EUT complies with the limit.

7.8 Test Equipment List and Details

Description	Manufacturer	Model	Serial Number	Calibration Date	Calibration Due Date
Broadband Antenna	Sunol Sciences	JB6	A050115	2015/12/8	2016/12/7
Amplifier	Sonoma	310N	130602	2016/7/15	2017/7/14
EMI Test Receiver	Rohde & Schwarz	ESR7	101419	2016/11/3	2017/11/2
Mircoflex Cable	UTIFLEX	UFB311A-Q-1440-300300	220490-006	2016/11/3	2017/11/2
Mircoflex Cable	UTIFLEX	UFB197C-1-2362-70U-70U	225757-001	2016/7/15	2017/7/14
Mircoflex Cable	UTIFLEX	UFA210A-1-3149-300300	MFR64639 226389-001	2015/12/2	2016/12/1
Turn Table	Champro	TT-2000	060772-T	N.C.R	N.C.R
Antenna Tower	Champro	AM-BS-4500-B	060772-A	N.C.R	N.C.R
Controller	Champro	EM1000	060772	N.C.R	N.C.R
Software	Farad	EZ EMC	BACL-03A1	N.C.R	N.C.R
Horn Antenna	EMCO	3115	9311-4158	2016/5/10	2017/5/9
Horn Antenna	ETS-Lindgren	3116	00062638	2016/9/5	2017/9/4
Preamplifier	EMEC	EM01G18G	060657	2015/12/21	2016/12/20
Preamplifier	EMEC	EM18G40G	060656	2015/12/21	2016/12/20
Spectrum Analyzer	Rohde & Schwarz	FSEK30	825084/006	2015/12/24	2016/12/23
Mircoflex Cable	ROSNAL	K1K50-UP0264-K1K50-80CM	160309-2	2016/3/24	2017/3/23
Mircoflex Cable	ROSNAL	K1K50-UP0264-K1K50-450CM	160309-1	2016/3/24	2017/3/23
Spectrum Analyzer	Rohde & Schwarz	FSU26	200268	2016/5/7	2017/5/6
Cable	WOKEN	SFL402	00100A1F6A192 S	2015/12/18	2016/12/17

***Statement of Traceability:** Bay Area Compliance Laboratories Corp. (Taiwan) attests that all calibrations have been performed in accordance to requirements that traceable to National Primary Standards and International System of Units (SI).

7.9 Test Environmental Conditions

Temperature:	25 °C
Relative Humidity:	55 %
ATM Pressure:	101.0 kPa

The Radiated Spurious emission testing was performed by David Hsu on 2016-11-10.

The Conducted Spurious Emissions testing was performed by David Hsu on 2016-10-25 to 2016-11-10.

7.10 Test Results

Mode: Test Mode

*(Scan with GFSK, $\pi/4$ -DQPSK, 8-DPSK Mode, the worst case is BDR (GFSK) Mode and EDR (8-DPSK) Mode)***BDR Mode (30MHz ~25GHz)****2402 MHz****Horizontal**

Frequency (MHz)	Reading (dB μ V)	Cord. Factor (dB/m)	Result	Limit	Margin (dB)	Ant. Height (cm)	Table Degree	Remark (PK/QP/Ave.)
			(dB μ V/m)					
32.9100	39.21	-5.74	33.47	40.00	-6.53	100	91	QP
119.2400	32.91	-11.10	21.81	43.50	-21.69	100	49	QP
127.9700	39.22	-10.76	28.46	43.50	-15.04	100	48	QP
288.0200	39.70	-10.19	29.51	46.00	-16.49	100	88	QP
480.0800	34.35	-6.26	28.09	46.00	-17.91	100	131	QP
797.2700	36.32	-1.11	35.21	46.00	-10.79	100	269	QP
2387.615	59.09	-5.28	53.81	74.00	-20.19	100	149	PK
2387.615	47.30	-5.28	42.02	54.00	-11.98	100	149	Ave
2401.865	102.00	-5.25	96.75	N/A	N/A	100	242	PK
2401.865	94.00	-5.25	88.75	N/A	N/A	100	242	Ave
4876.000	41.49	0.91	42.40	74.00	-31.60	100	135	PK
4876.000	35.22	0.91	36.13	54.00	-17.87	100	135	Ave

Note: Result = Reading + Factor

Margin = Result - Limit

Correct Factor = Antenna Factor + Cable Loss - Amplifier Gain

The other emission levels were very low against the limit.

Vertical

Frequency (MHz)	Reading (dB μ V)	Cord. Factor (dB/m)	Result	Limit	Margin (dB)	Ant. Height (cm)	Table Degree	Remark (PK/QP/Ave.)
			(dB μ V/m)					
127.9700	46.17	-10.76	35.41	43.50	-8.09	100	100	QP
159.9800	47.00	-11.47	35.53	43.50	-7.97	100	103	QP
191.9900	48.90	-12.37	36.53	43.50	-6.97	100	88	QP
288.0200	49.37	-10.19	39.18	46.00	-6.82	100	28	QP
480.0800	39.82	-6.26	33.56	46.00	-12.44	100	246	QP
799.2100	33.10	-1.06	32.04	46.00	-13.96	100	19	QP
2379.920	59.57	-5.30	54.27	74.00	-19.73	100	306	PK
2379.920	48.35	-5.30	43.05	54.00	-10.95	100	306	Ave
2401.865	101.81	-5.25	96.56	N/A	N/A	100	237	PK
2401.865	95.21	-5.25	89.96	N/A	N/A	100	237	Ave
4876.000	44.35	0.91	45.26	74.00	-28.74	100	173	PK
4876.000	38.22	0.91	39.13	54.00	-14.87	100	173	Ave

Note: Result = Reading + Factor

Margin = Result – Limit

Correct Factor = Antenna Factor + Cable Loss – Amplifier Gain

The other emission levels were very low against the limit.

2441MHz**Horizontal**

Frequency (MHz)	Reading (dB μ V)	Cord. Factor (dB/m)	Result	Limit	Margin (dB)	Ant. Height (cm)	Table Degree	Remark (PK/QP/Ave.)
			(dB μ V/m)					
191.9900	44.69	-12.37	32.32	43.50	-11.18	100	75	QP
288.0200	48.78	-10.19	38.59	46.00	-7.41	100	29	QP
320.0300	39.85	-9.61	30.24	46.00	-15.76	100	258	QP
416.0600	36.65	-7.56	29.09	46.00	-16.91	100	338	QP
480.0800	34.05	-6.26	27.79	46.00	-18.21	100	263	QP
879.7200	31.49	0.64	32.13	46.00	-13.87	100	13	QP
2440.800	102.00	-5.16	96.84	N/A	N/A	100	239	PK
2440.800	94.45	-5.16	89.26	N/A	N/A	100	239	Ave
4882.000	41.25	0.91	42.16	74.00	-31.84	100	229	PK
4882.000	35.84	0.91	36.75	54.00	-17.25	100	229	Ave

Note: Result = Reading + Factor

Margin = Result - Limit

Correct Factor = Antenna Factor + Cable Loss - Amplifier Gain

The other emission levels were very low against the limit.

Vertical

Frequency (MHz)	Reading (dB μ V)	Cord. Factor (dB/m)	Result	Limit	Margin (dB)	Ant. Height (cm)	Table Degree	Remark (PK/QP/Ave.)
			(dB μ V/m)					
32.9100	39.60	-5.74	33.86	40.00	-6.14	100	77	QP
127.9700	39.07	-10.76	28.31	43.50	-15.19	100	53	QP
288.0200	38.70	-10.19	28.51	46.00	-17.49	100	16	QP
480.0800	34.78	-6.26	28.52	46.00	-17.48	100	122	QP
598.4200	31.17	-4.34	26.83	46.00	-19.17	100	348	QP
799.2100	36.33	-1.06	35.27	46.00	-10.73	100	207	QP
2440.800	100.68	-5.16	95.52	N/A	N/A	100	237	PK
2440.800	92.55	-5.16	87.39	N/A	N/A	100	237	Ave
4876.000	45.03	0.91	45.94	74.00	-28.06	100	183	PK
4876.000	38.54	0.91	39.45	54.00	-14.55	100	183	Ave

Note: Result = Reading + Factor

Margin = Result – Limit

Correct Factor = Antenna Factor + Cable Loss – Amplifier Gain

The other emission levels were very low against the limit.

2480 MHz**Horizontal**

Frequency (MHz)	Reading (dB μ V)	Cord. Factor (dB/m)	Result	Limit	Margin (dB)	Ant. Height (cm)	Table Degree	Remark (PK/QP/Ave.)
			(dB μ V/m)					
32.9100	32.48	-5.74	26.74	40.00	-13.26	100	355	QP
175.5000	43.44	-12.92	30.52	43.50	-12.98	100	105	QP
191.9900	44.89	-12.37	32.52	43.50	-10.98	100	75	QP
288.0200	48.95	-10.19	38.76	46.00	-7.24	100	29	QP
800.1800	33.55	-1.05	32.50	46.00	-13.50	100	16	QP
879.7200	32.01	0.64	32.65	46.00	-13.35	100	13	QP
2479.990	98.59	-5.06	93.53	N/A	N/A	100	241	PK
2479.990	92.18	-5.06	87.12	N/A	N/A	100	241	Ave
2483.500	57.19	-5.05	52.14	74.00	-21.86	100	187	PK
2483.500	46.83	-5.05	41.78	54.00	-12.22	100	187	Ave
4995.000	40.28	1.37	41.65	74.00	-32.35	100	352	PK
4995.000	32.64	1.37	34.01	54.00	-19.19	100	352	Ave

Note: Result = Reading + Factor

Margin = Result - Limit

Correct Factor = Antenna Factor + Cable Loss - Amplifier Gain

The other emission levels were very low against the limit.

Vertical

Frequency (MHz)	Reading (dB μ V)	Cord. Factor (dB/m)	Result	Limit	Margin (dB)	Ant. Height (cm)	Table Degree	Remark (PK/QP/Ave.)
			(dB μ V/m)					
127.9700	39.07	-10.76	28.31	43.50	-15.19	100	53	QP
191.9900	35.90	-12.37	23.53	43.50	-19.97	100	47	QP
288.0200	38.70	-10.19	28.51	46.00	-17.49	100	16	QP
399.5700	31.82	-7.97	23.85	46.00	-22.15	100	73	QP
480.0800	34.78	-6.26	28.52	46.00	-17.48	100	122	QP
799.2100	36.33	-1.06	35.27	46.00	-10.73	100	207	QP
2479.810	101.14	-5.06	96.08	N/A	N/A	100	238	PK
2479.810	94.62	-5.06	89.56	N/A	N/A	100	238	Ave
2483.500	56.96	-5.05	51.91	74.00	-22.09	100	152	PK
2483.500	47.24	-5.05	42.19	54.00	-11.81	100	152	Ave
4961.000	43.25	1.23	44.48	74.00	-29.52	100	204	PK
4961.000	38.15	1.23	39.38	54.00	-14.62	100	204	Ave

Note: Result = Reading + Factor

Margin = Result - Limit

Correct Factor = Antenna Factor + Cable Loss - Amplifier Gain

The other emission levels were very low against the limit.

EDR Mode (30MHz ~25GHz)
2402 MHz

Horizontal

Frequency (MHz)	Reading (dB μ V)	Cord. Factor (dB/m)	Result	Limit	Margin (dB)	Ant. Height (cm)	Table Degree	Remark (PK/QP/Ave.)
			(dB μ V/m)					
32.9100	31.88	-5.74	26.14	40.00	-13.86	100	355	QP
159.9800	40.20	-11.47	28.73	43.50	-14.77	100	92	QP
175.5000	42.81	-12.92	29.89	43.50	-13.61	100	105	QP
191.9900	44.65	-12.37	32.28	43.50	-11.22	100	75	QP
288.0200	48.94	-10.19	38.75	46.00	-7.25	100	29	QP
799.2100	32.74	-1.06	31.68	46.00	-14.32	100	2	QP
2367.855	59.51	-5.33	54.18	74.00	-19.82	100	124	PK
2367.855	46.82	-5.33	41.49	54.00	-12.51	100	124	Ave
2402.055	102.18	-5.25	96.93	N/A	N/A	100	238	PK
2402.055	92.56	-5.25	87.31	N/A	N/A	100	238	Ave
4808.000	42.55	0.65	43.20	74.00	-30.80	100	142	PK
4808.000	38.68	0.65	39.33	54.00	-14.67	100	142	Ave

Note: Result = Reading + Factor

Margin = Result – Limit

Correct Factor = Antenna Factor + Cable Loss – Amplifier Gain

The other emission levels were very low against the limit.

Vertical

Frequency (MHz)	Reading (dB μ V)	Cord. Factor (dB/m)	Result	Limit	Margin (dB)	Ant. Height (cm)	Table Degree	Remark (PK/QP/Ave.)
			(dB μ V/m)					
127.9700	36.39	-10.76	25.63	43.50	-17.87	100	53	QP
288.0200	38.19	-10.19	28.00	46.00	-18.00	100	16	QP
320.0300	35.33	-9.61	25.72	46.00	-20.28	100	184	QP
352.0400	32.17	-8.94	23.23	46.00	-22.77	100	186	QP
598.4200	30.34	-4.34	26.00	46.00	-20.00	100	348	QP
797.2700	29.20	-1.11	28.09	46.00	-17.91	100	215	QP
2371.275	59.34	-5.32	54.02	74.00	-19.98	100	70	PK
2371.275	48.57	-5.32	43.25	54.00	-10.75	100	70	Ave
2402.055	102.02	-5.25	96.77	N/A	N/A	100	235	PK
2402.055	92.49	-5.25	87.24	N/A	N/A	100	235	Ave
4808.000	44.97	0.65	45.62	74.00	-28.38	100	222	PK
4808.000	37.31	0.65	37.96	54.00	-16.04	100	222	Ave

Note: Result = Reading + Factor

Margin = Result – Limit

Correct Factor = Antenna Factor + Cable Loss – Amplifier Gain

The other emission levels were very low against the limit.

2441MHz**Horizontal**

Frequency (MHz)	Reading (dB μ V)	Cord. Factor (dB/m)	Result	Limit	Margin (dB)	Ant. Height (cm)	Table Degree	Remark (PK/QP/Ave.)
			(dB μ V/m)					
32.9100	32.60	-5.74	26.86	40.00	-13.14	100	355	QP
175.5000	42.32	-12.92	29.40	43.50	-14.10	100	105	QP
191.9900	44.72	-12.37	32.35	43.50	-11.15	100	75	QP
288.0200	48.97	-10.19	38.78	46.00	-7.22	100	29	QP
416.0600	36.89	-7.56	29.33	46.00	-16.67	100	338	QP
825.4000	32.85	-0.55	32.30	46.00	-13.70	100	5	QP
2441.000	100.95	-5.16	95.79	N/A	N/A	100	240	PK
2441.000	90.25	-5.16	85.09	N/A	N/A	100	240	Ave
4893.000	40.75	0.97	41.72	74.00	-32.28	100	91	PK
4893.000	34.64	0.97	35.61	54.00	-18.39	100	91	Ave

Note: Result = Reading + Factor

Margin = Result - Limit

Correct Factor = Antenna Factor + Cable Loss - Amplifier Gain

The other emission levels were very low against the limit.

Vertical

Frequency (MHz)	Reading (dB μ V)	Cord. Factor (dB/m)	Result	Limit	Margin (dB)	Ant. Height (cm)	Table Degree	Remark (PK/QP/Ave.)
			(dB μ V/m)					
127.9700	37.80	-10.76	27.04	43.50	-16.46	100	53	QP
137.6700	36.78	-10.96	25.82	43.50	-17.68	100	132	QP
288.0200	37.57	-10.19	27.38	46.00	-18.62	100	16	QP
352.0400	32.75	-8.94	23.81	46.00	-22.19	100	186	QP
800.1800	29.93	-1.05	28.88	46.00	-17.12	100	249	QP
942.7700	27.95	2.27	30.22	46.00	-15.78	100	194	QP
2441.000	102.25	-5.16	97.09	N/A	N/A	100	238	PK
2441.000	93.46	-5.16	88.30	N/A	N/A	100	238	Ave
4876.000	44.81	0.91	45.72	74.00	-28.28	100	190	PK
4876.000	37.45	0.91	38.36	54.00	-15.64	100	190	Ave

Note: Result = Reading + Factor

Margin = Result – Limit

Correct Factor = Antenna Factor + Cable Loss – Amplifier Gain

The other emission levels were very low against the limit.

2480 MHz**Horizontal**

Frequency (MHz)	Reading (dB μ V)	Cord. Factor (dB/m)	Result	Limit	Margin (dB)	Ant. Height (cm)	Table Degree	Remark (PK/QP/Ave.)
			(dB μ V/m)					
58.1300	56.76	-17.51	39.25	40.00	-0.75	300	115	QP
64.9200	49.67	-17.41	32.26	40.00	-7.74	300	131	QP
108.5700	49.06	-12.42	36.64	43.50	-6.86	100	299	QP
227.8800	47.73	-13.01	34.72	46.00	-11.28	233	0	QP
437.4000	41.76	-7.95	33.81	46.00	-12.19	100	187	QP
603.2700	35.03	-5.63	29.40	46.00	-16.60	200	150	QP
2479.990	98.91	-5.06	93.85	N/A	N/A	100	241	PK
2479.990	88.14	-5.06	83.08	N/A	N/A	100	241	Ave
2483.500	56.80	-5.05	51.75	74.00	-22.25	100	270	PK
2483.500	45.24	-5.05	40.19	54.00	-13.81	100	270	Ave
4995.000	40.79	0.78	41.57	74.00	-32.43	100	156	PK
4995.000	35.23	0.78	36.01	54.00	-17.99	100	156	Ave

Note: Result = Reading + Factor

Margin = Result – Limit

Correct Factor = Antenna Factor + Cable Loss – Amplifier Gain

The other emission levels were very low against the limit.

Vertical

Frequency (MHz)	Reading (dB μ V)	Cord. Factor (dB/m)	Result	Limit	Margin (dB)	Ant. Height (cm)	Table Degree	Remark (PK/QP/Ave.)
			(dB μ V/m)					
127.9700	36.71	-10.76	25.95	43.50	-17.55	100	53	QP
288.0200	38.19	-10.19	28.00	46.00	-18.00	100	16	QP
320.0300	35.30	-9.61	25.69	46.00	-20.31	100	184	QP
352.0400	32.70	-8.94	23.76	46.00	-22.24	100	186	QP
597.4500	32.03	-4.36	27.67	46.00	-18.33	100	140	QP
798.2400	31.54	-1.09	30.45	46.00	-15.55	100	230	QP
2480.050	101.48	-5.06	96.42	N/A	N/A	100	238	PK
2480.050	92.56	-5.06	87.50	N/A	N/A	100	238	Ave
2483.500	57.23	-5.05	52.18	74.00	-21.82	100	77	PK
2483.500	46.16	-5.05	41.11	54.00	-12.89	100	77	Ave
4995.000	42.34	0.78	43.12	74.00	-30.88	100	264	PK
4995.000	37.57	0.78	38.35	54.00	-15.65	100	264	Ave

Note: Result = Reading + Factor

Margin = Result - Limit

Correct Factor = Antenna Factor + Cable Loss - Amplifier Gain

The other emission levels were very low against the limit.

Test Mode: simultaneous transmissions (WCDMA+BT+BLE)**Horizontal**

Frequency (MHz)	Reading (dB μ V)	Cord. Factor (dB/m)	Result	Limit	Margin (dB)	Ant. Height (cm)	Table Degree	Remark (PK/QP/Ave.)
			(dB μ V/m)					
58.1300	56.35	-17.51	38.84	40.00	-1.16	400	203	QP
65.8900	50.12	-17.34	32.78	40.00	-7.22	300	190	QP
110.5100	43.24	-12.00	31.24	43.50	-12.26	400	5	QP
207.5100	51.36	-13.16	38.20	43.50	-5.30	100	207	QP
224.9700	54.06	-13.16	40.90	46.00	-5.10	100	184	QP
299.6600	47.76	-10.85	36.91	46.00	-9.09	100	95	QP
1673.000	66.89	-7.56	59.33	74.00	-14.67	100	70	PK
1673.000	30.26	-7.56	22.70	54.00	-31.30	100	70	Ave
3346.000	42.13	-1.75	40.38	74.00	-33.62	300	48	PK
3346.000	27.52	-1.75	25.77	54.00	-28.23	300	48	Ave
4808.000	41.65	0.65	42.30	74.00	-31.70	200	103	PK
4808.000	37.57	0.65	38.22	54.00	-15.78	200	103	Ave

Note: Result = Reading + Factor

Margin = Result - Limit

Correct Factor = Antenna Factor + Cable Loss - Amplifier Gain

The other emission levels were very low against the limit.

Vertical

Frequency (MHz)	Reading (dB μ V)	Cord. Factor (dB/m)	Result	Limit	Margin (dB)	Ant. Height (cm)	Table Degree	Remark (PK/QP/Ave.)
			(dB μ V/m)					
127.9700	36.71	-10.76	25.95	43.50	-17.55	100	53	QP
288.0200	38.19	-10.19	28.00	46.00	-18.00	100	16	QP
320.0300	35.30	-9.61	25.69	46.00	-20.31	100	184	QP
352.0400	32.70	-8.94	23.76	46.00	-22.24	100	186	QP
597.4500	32.03	-4.36	27.67	46.00	-18.33	100	140	QP
798.2400	31.54	-1.09	30.45	46.00	-15.55	100	230	QP
1673.000	60.81	-7.56	53.25	74.00	-20.75	400	103	peak
1673.000	28.41	-7.56	20.85	54.00	-33.15	400	103	AVG
4808.000	41.31	0.65	41.96	74.00	-32.04	121	0	peak
4808.000	36.48	0.65	37.13	54.00	-16.87	121	0	AVG

Note: Result = Reading + Factor

Margin = Result – Limit

Correct Factor = Antenna Factor + Cable Loss – Amplifier Gain

The other emission levels were very low against the limit.

Conducted Spurious Emissions:

Channel	Frequency (MHz)	Delta Peak to Band Emission (dBc)	Limit (dBc)	RESULT
<i>BDR Mode (GFSK)</i>				
Low	2402	46.21	≥ 20	PASS
Mid	2441	46.79	≥ 20	PASS
High	2480	45.70	≥ 20	PASS
<i>EDR Mode (π/4-DQPSK):</i>				
Low	2402	46.63	≥ 20	PASS
Mid	2441	44.53	≥ 20	PASS
High	2480	44.10	≥ 20	PASS
<i>EDR Mode (8DPSK):</i>				
Low	2402	45.34	≥ 20	PASS
Mid	2441	43.22	≥ 20	PASS
High	2480	44.45	≥ 20	PASS

BDR Mode (GFSK)

Low Channel

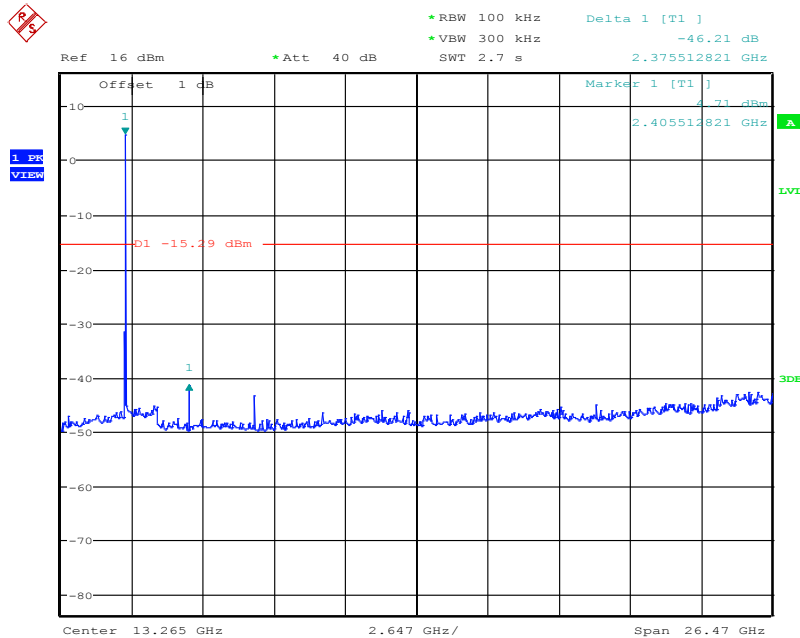

Date: 25.OCT.2016 11:24:39

Middle Channel

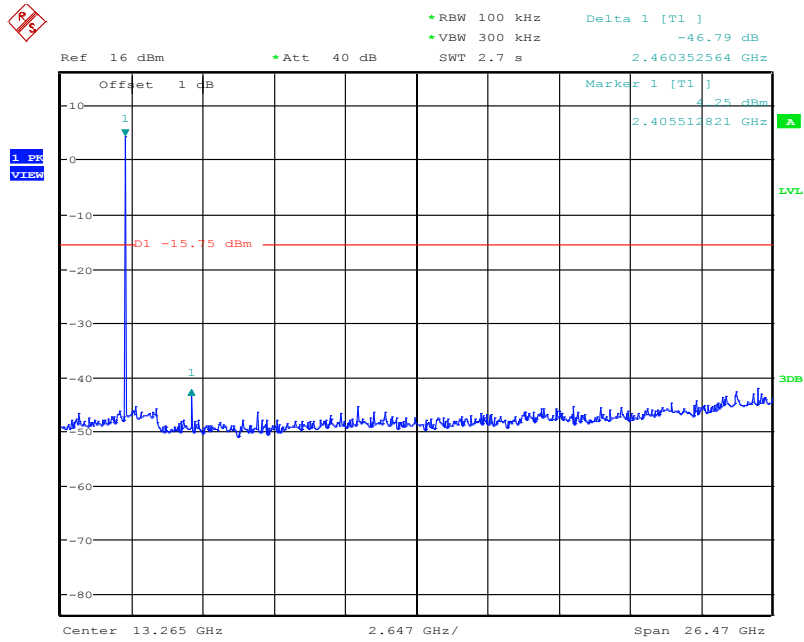

Date: 25.OCT.2016 11:21:44

High Channel

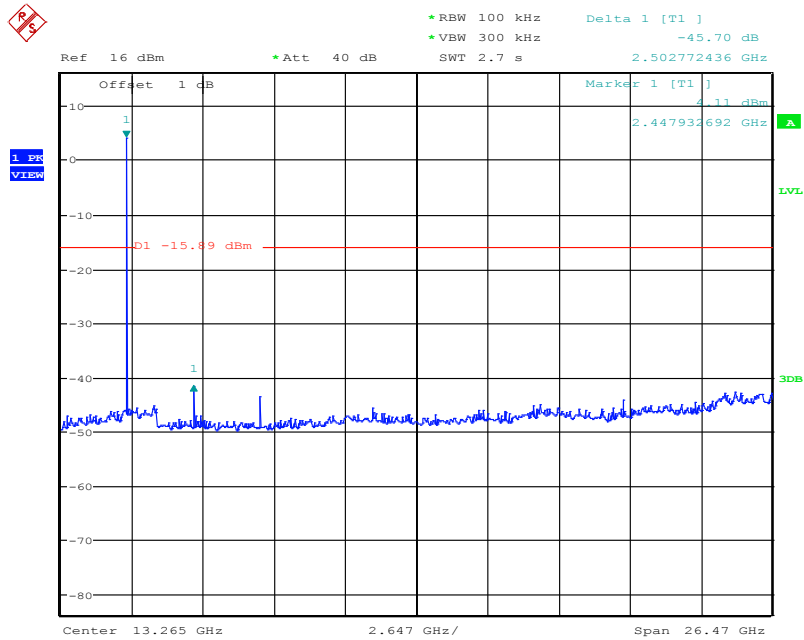

Date: 25.OCT.2016 11:19:28

EDR Mode ($\pi/4$ -DQPSK)

Low Channel

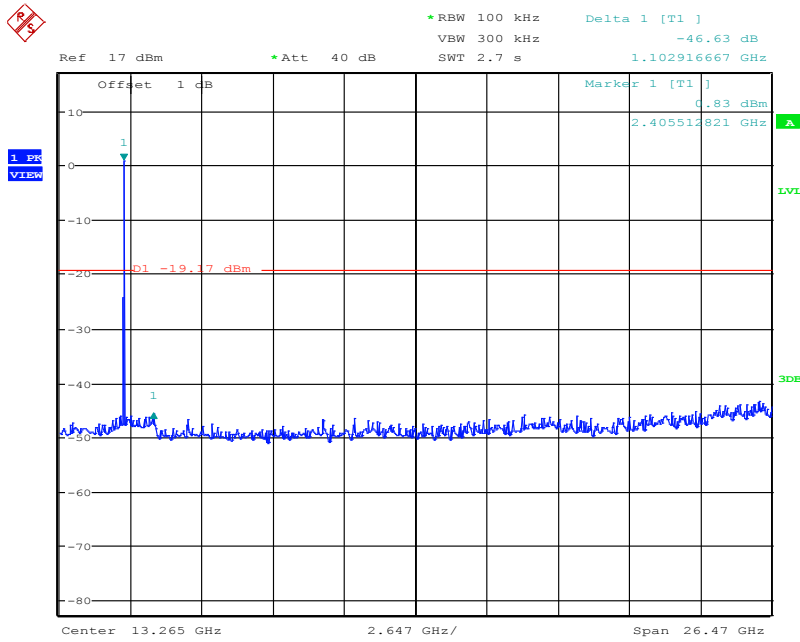

Date: 10.NOV.2016 09:37:59

Middle Channel

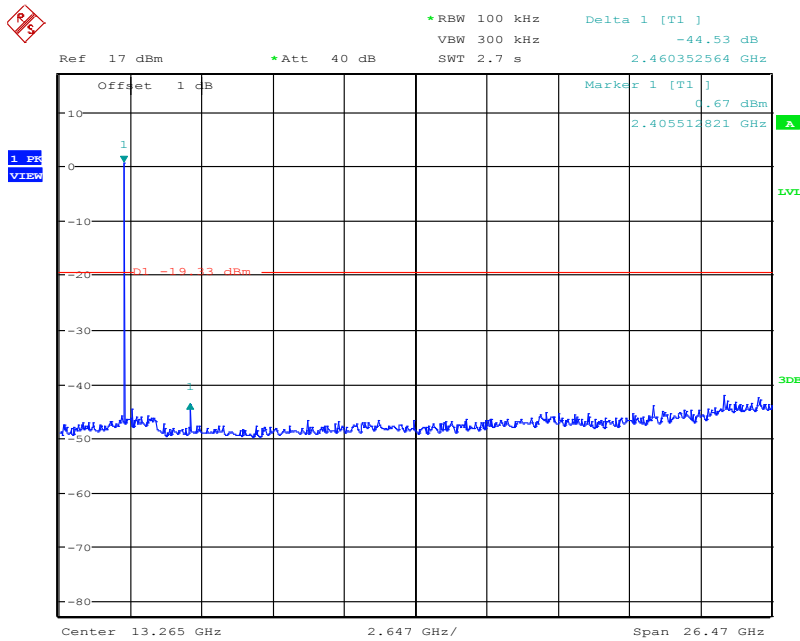

Date: 10.NOV.2016 09:35:06

High Channel

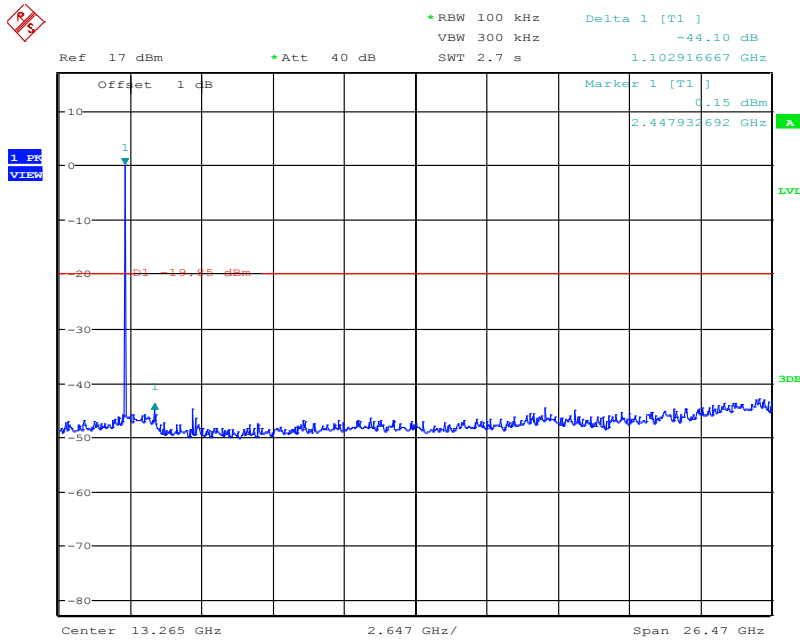

Date: 10.NOV.2016 09:23:15

EDR Mode (8-DPSK)

Low Channel

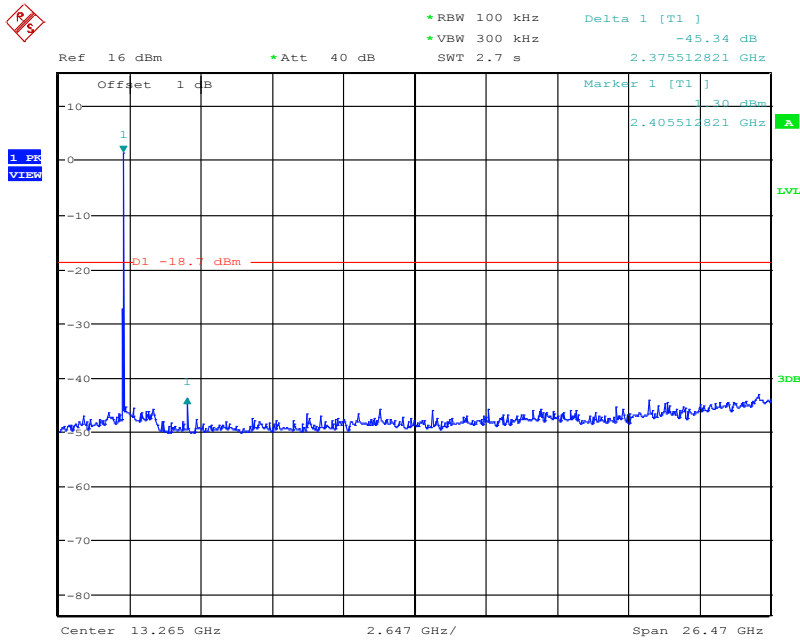

Date: 25.OCT.2016 14:16:06

Middle Channel

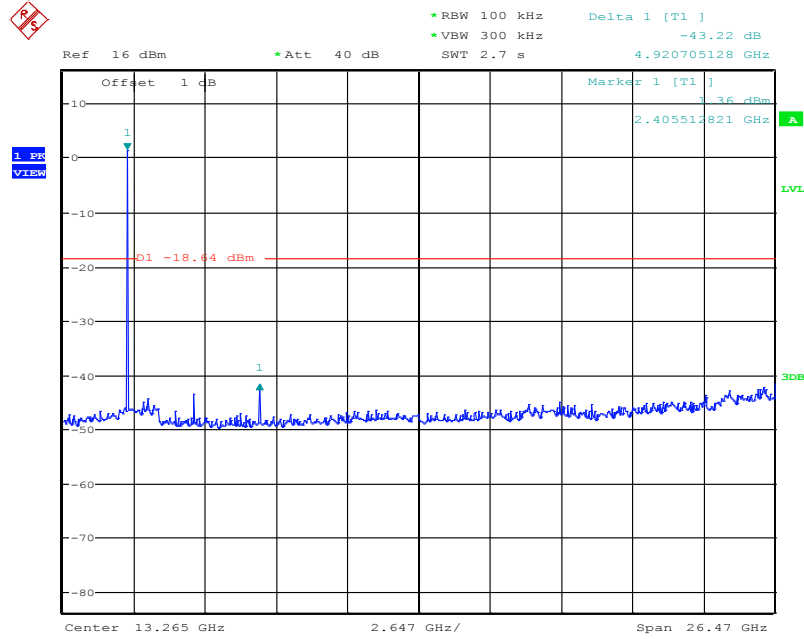

Date: 25.OCT.2016 14:11:29

High Channel

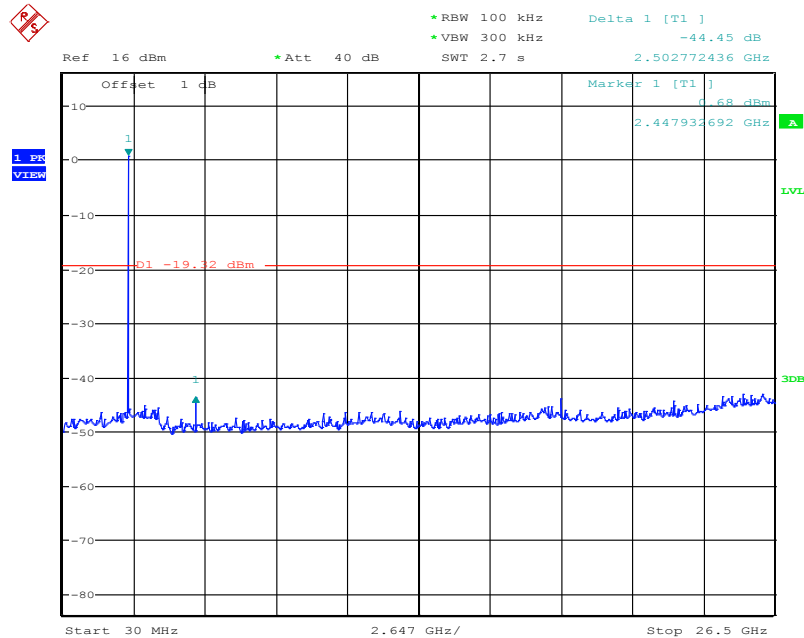

Date: 25.OCT.2016 14:09:40

8 FCC §15.247(a)(1) – 20 dB Emission Bandwidth

8.1 Applicable Standard

According to FCC §15.247(a) (1).

Alternatively, frequency hopping systems operating in the 2400–2483.5 MHz band may have hopping channel carrier frequencies that are separated by 25 kHz or two-thirds of the 20 dB bandwidth of the hopping channel, whichever is greater, provided the systems operate with an output power no greater than 125 mW.

8.2 Test Procedure

1. Check the calibration of the measuring instrument using either an internal calibrator or a known signal from an external generator.
2. Position the EUT without connection to measurement instrument. Turn on the EUT and connect it to measurement instrument. Then set it to any one convenient frequency within its operating range. Set a reference level on the measuring instrument equal to the highest peak value.
3. Measure the frequency difference of two frequencies that were attenuated 20 dB from the reference level. Record the frequency difference as the emission bandwidth.
4. Repeat above procedures until all frequencies measured were complete.



8.3 Test Equipment List and Details

Descriptions	Manufacturers	Models	Serial Numbers	Calibration Date	Calibration Due Date
Spectrum Analyzer	Rohde & Schwarz	FSU26	200268	2016/5/7	2017/5/6
Cable	WOKEN	SFL402	00100A1F6A192S	2015/12/18	2016/12/17

***Statement of Traceability:** Bay Area Compliance Laboratories Corp. (Taiwan) attests that all calibrations have been performed in accordance to requirements that traceable to National Primary Standards and International System of Units (SI).

8.4 Test Environmental Conditions

Temperature:	25 °C
Relative Humidity:	55 %
ATM Pressure:	101.0 kPa

The testing was performed by David Hsu on 2016-10-25 to 2016-11-10.

8.5 Test Results

Channel	Frequency (MHz)	20 dBc BW (MHz)
<i>BDR Mode (GFSK)</i>		
Low	2402	0.96
Middle	2441	0.96
High	2480	0.88
<i>EDR Mode ($\pi/4$-DQPSK)</i>		
Low	2402	1.27
Middle	2441	1.27
High	2480	1.27
<i>EDR Mode (8-DPSK)</i>		
Low	2402	1.28
Middle	2441	1.28
High	2480	1.29

Please refer to the following plots

BDR Mode (GFSK)

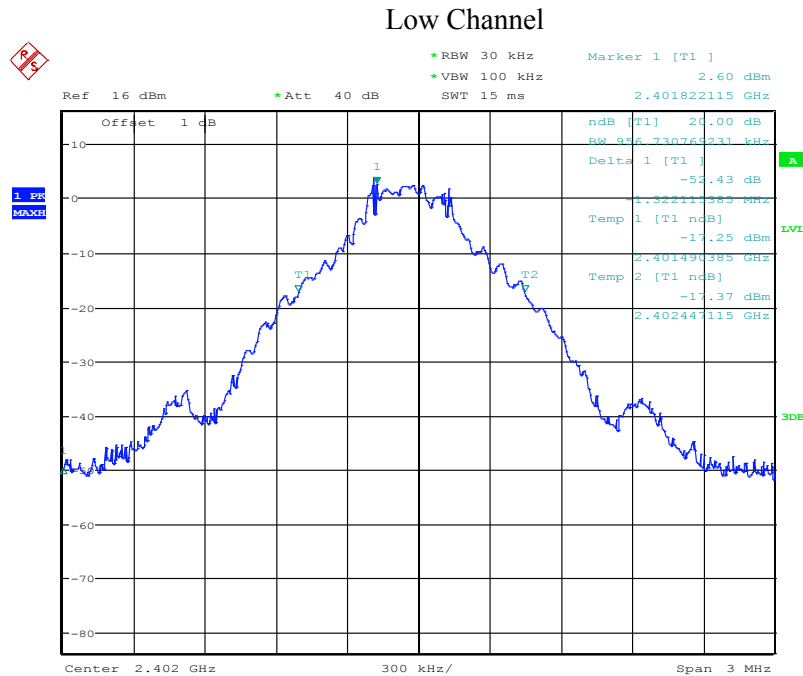

Date: 25.OCT.2016 10:48:43

Middle Channel

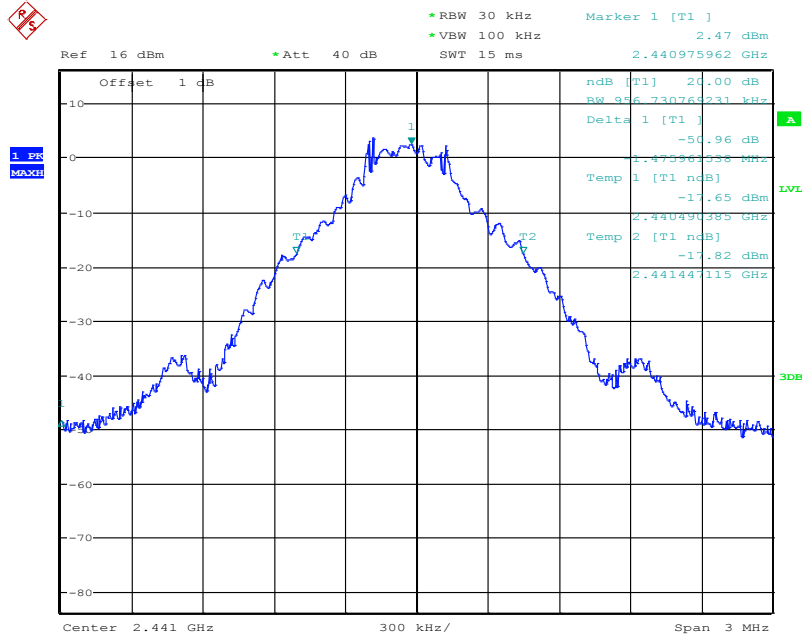

Date: 25.OCT.2016 10:52:49

High Channel

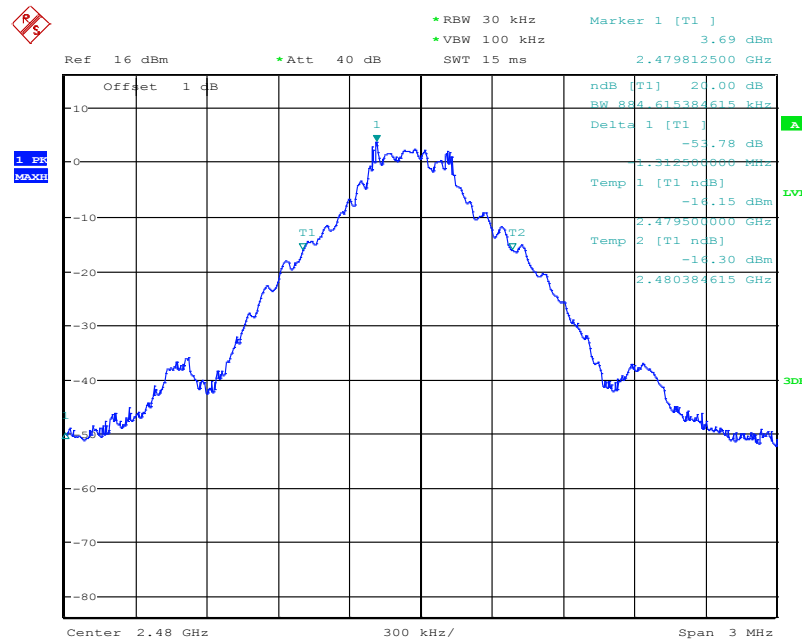

Date: 25.OCT.2016 10:54:31

EDR Mode ($\pi/4$ -DQPSK)

Low Channel

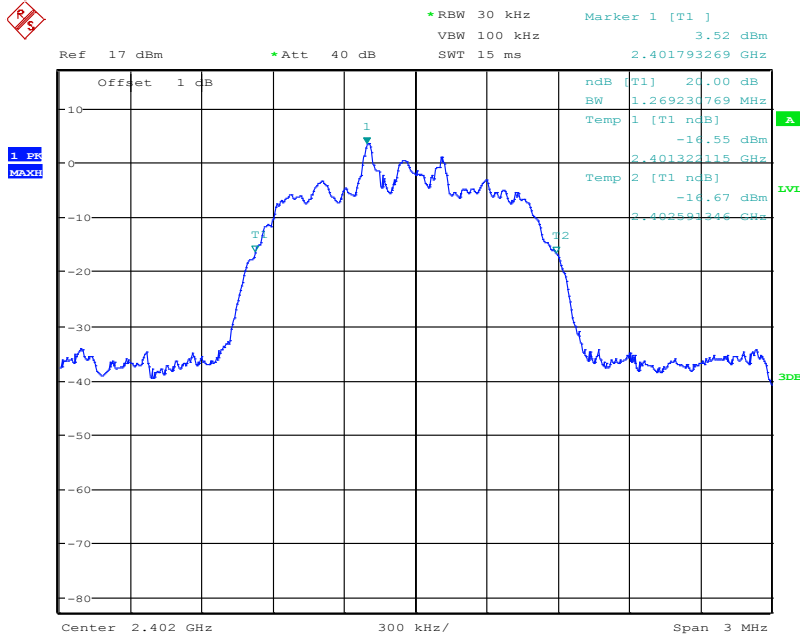

Date: 10.NOV.2016 08:59:19

Middle Channel

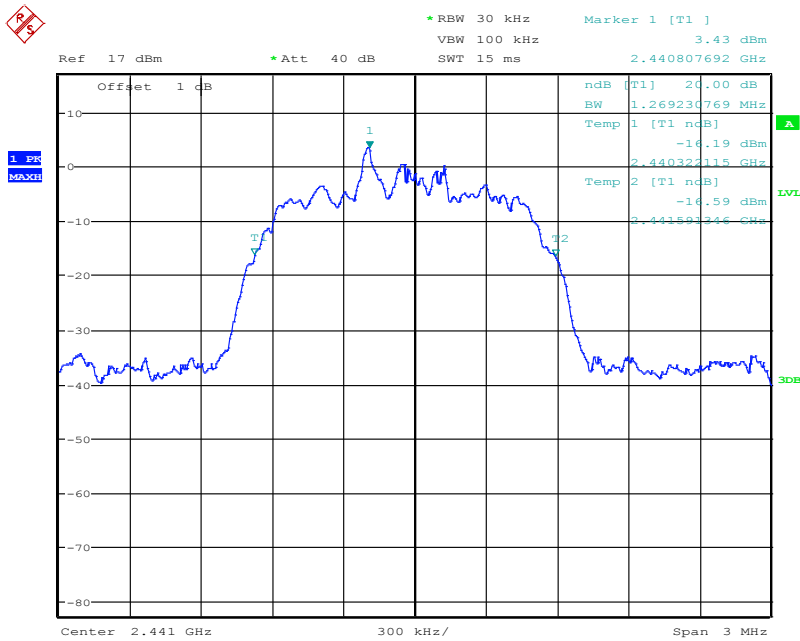

Date: 10.NOV.2016 09:03:48

High Channel

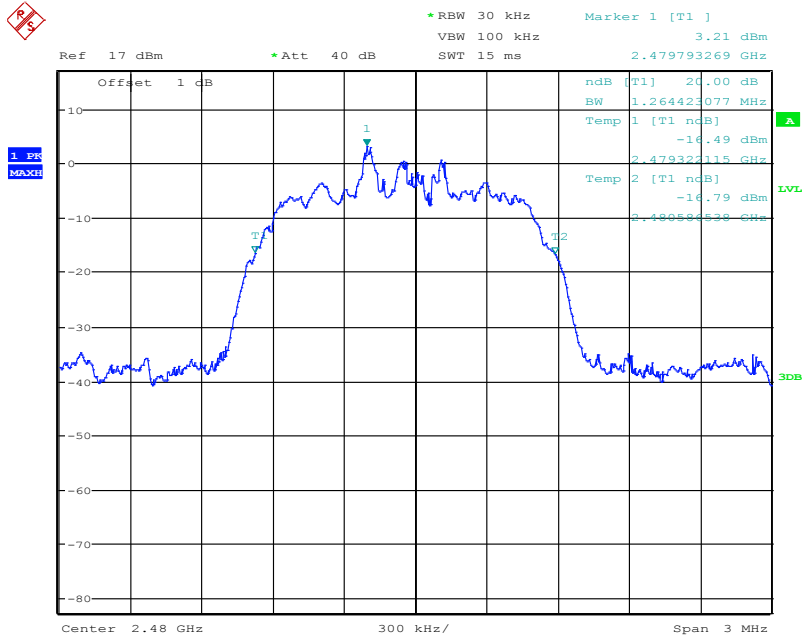

Date: 10.NOV.2016 09:05:46

EDR Mode (8-DPSK)

Low Channel

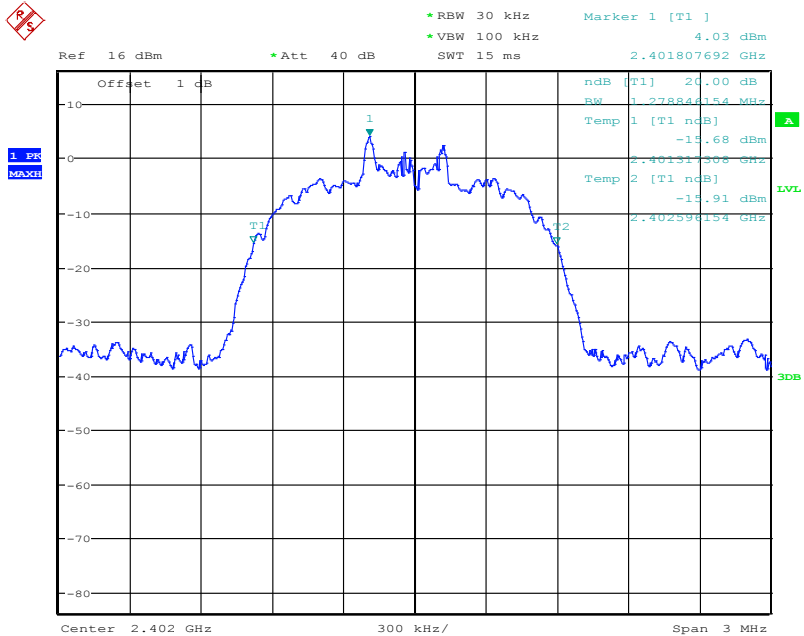

Date: 25.OCT.2016 13:59:11

Middle Channel

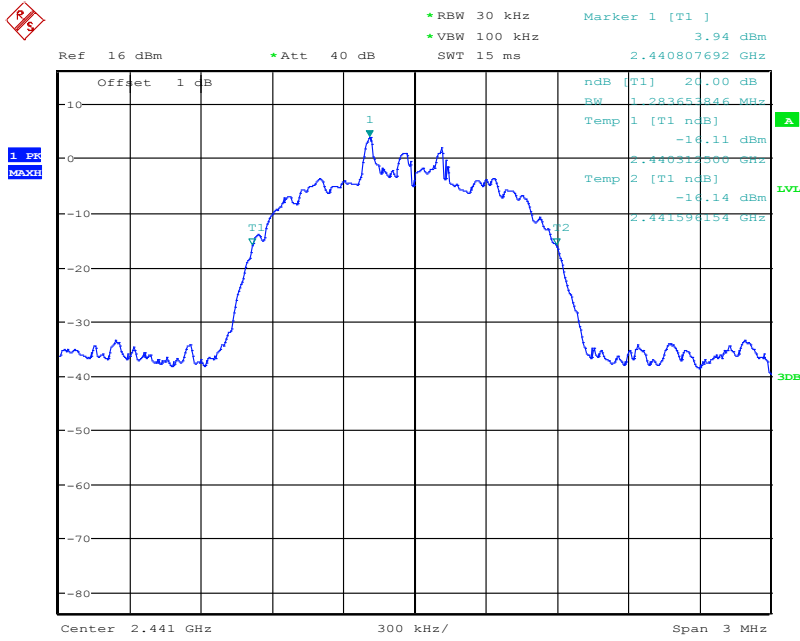

Date: 25.OCT.2016 13:58:26

High Channel

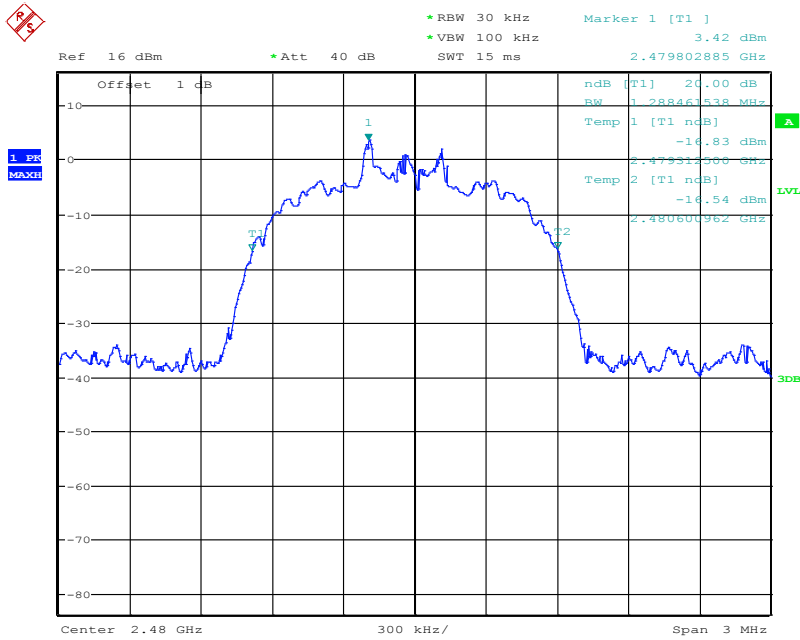

Date: 25.OCT.2016 13:55:38

9 FCC §15.247(a)(1) – Channel Separation Test

9.1 Applicable Standard

According to FCC §15.247(a) (1).

Alternatively, frequency hopping systems operating in the 2400–2483.5 MHz band may have hopping channel carrier frequencies that are separated by 25 kHz or two-thirds of the 20 dB bandwidth of the hopping channel, whichever is greater, provided the systems operate with an output power no greater than 125 mW.

9.2 Test Procedure

1. Set the EUT in transmitting mode, max hold the channel.
2. Set the adjacent channel of the EUT and max hold another trace.
3. Measure the channel separation.

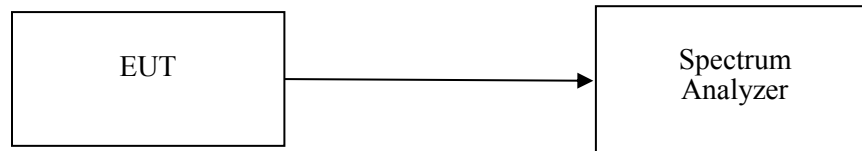

9.3 Test Equipment List and Details

Descriptions	Manufacturers	Models	Serial Numbers	Calibration Date	Calibration Due Date
Spectrum Analyzer	Rohde & Schwarz	FSU26	200268	2016/5/7	2017/5/6
Cable	WOKEN	SFL402	00100A1F6A192S	2015/12/18	2016/12/17

***Statement of Traceability:** Bay Area Compliance Laboratories Corp. (Taiwan) attests that all calibrations have been performed in accordance to requirements that traceable to National Primary Standards and International System of Units (SI).

9.4 Test Environmental Conditions

Temperature:	25 °C
Relative Humidity:	55 %
ATM Pressure:	101.0 kPa

The testing was performed by David Hsu on 2016-12-07 to 2016-12-08.

9.5 Test Results

Mode	Channel Separation (MHz)	20 dBc BW (MHz)	Two-thirds of the 20 dB bandwidth (MHz)	Channel Separation Limit	Result
GFSK	1	0.96	0.640	>two-thirds of the 20 dB bandwidth	Compliance
$\pi/4$ -DQPSK	1	1.27	0.847	>two-thirds of the 20 dB bandwidth	Compliance
8-DPSK	1	1.29	0.860	>two-thirds of the 20 dB bandwidth	Compliance

Please refer to the following plots

BDR Mode (GFSK)

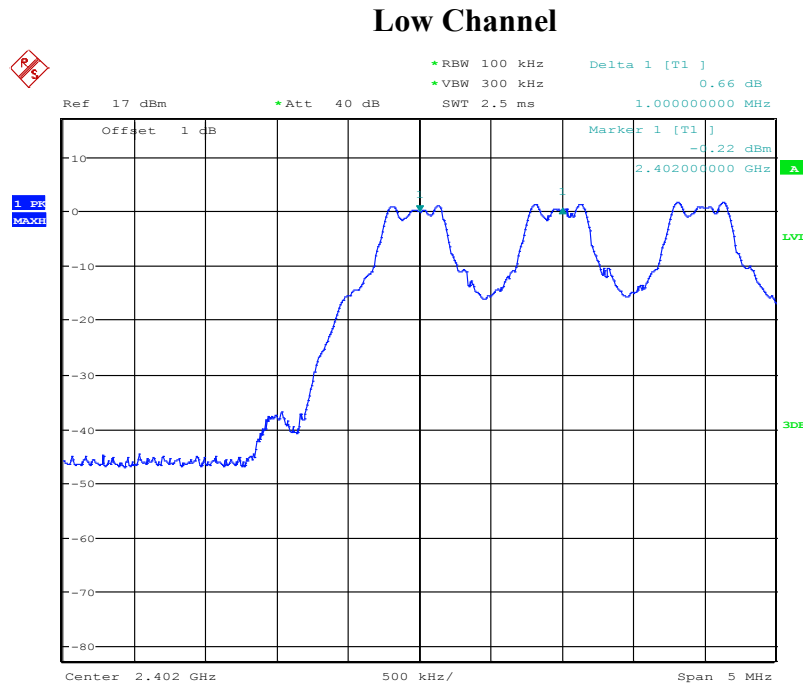

Date: 7.DEC.2016 16:24:58

Middle Channel

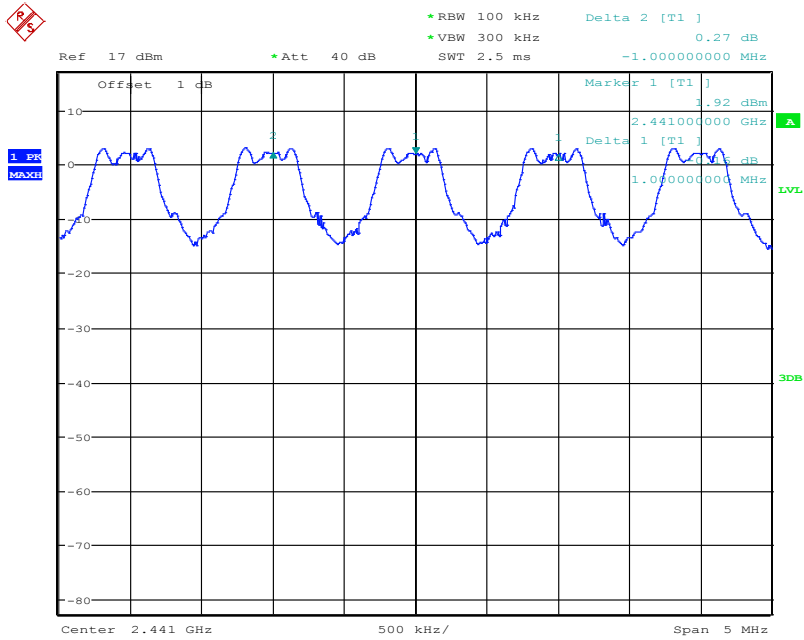

Date: 7.DEC.2016 16:28:47

High Channel

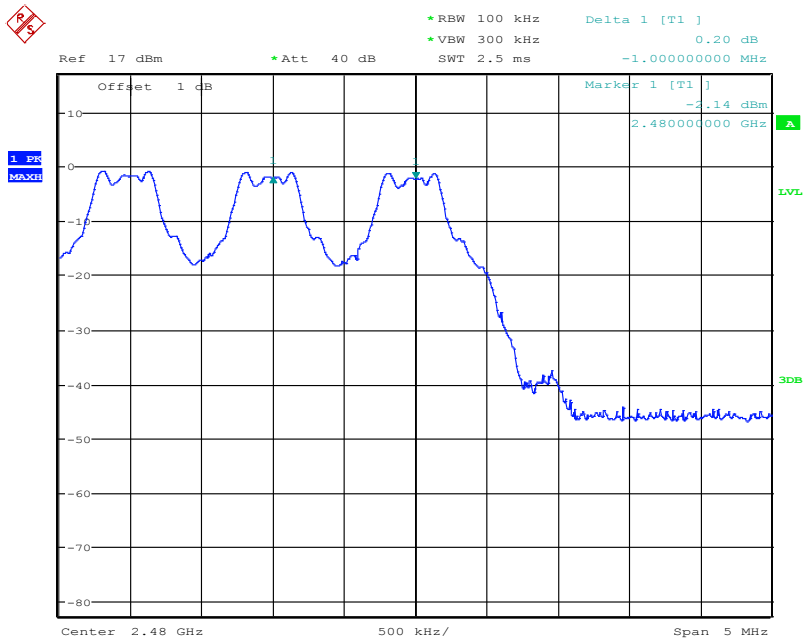

Date: 7.DEC.2016 16:38:11

EDR Mode ($\pi/4$ -DQPSK)

Low Channel

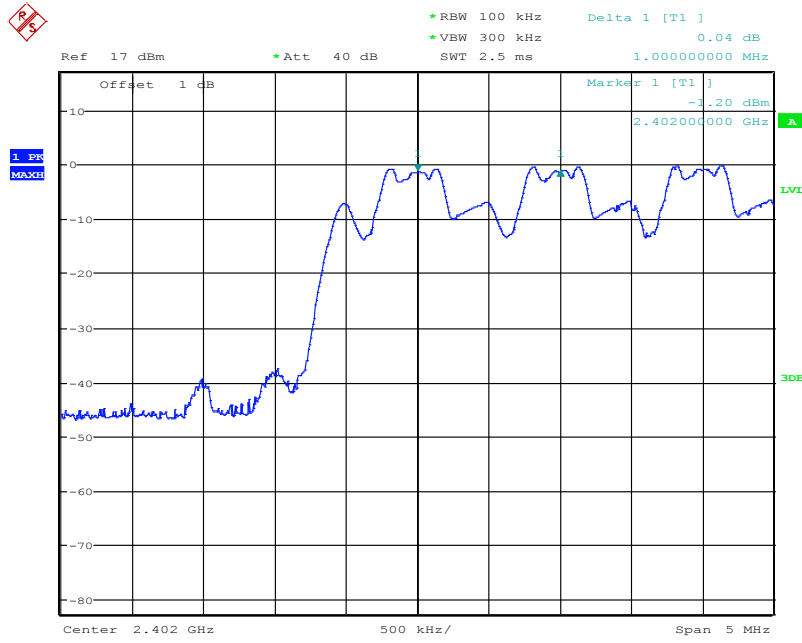

Date: 7.DEC.2016 17:09:40

Middle Channel

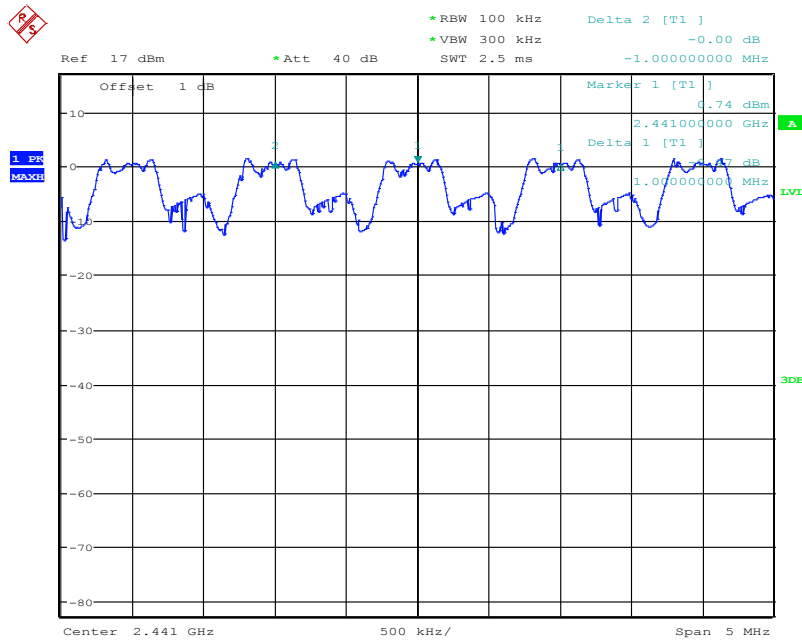

Date: 7.DEC.2016 17:19:30

High Channel

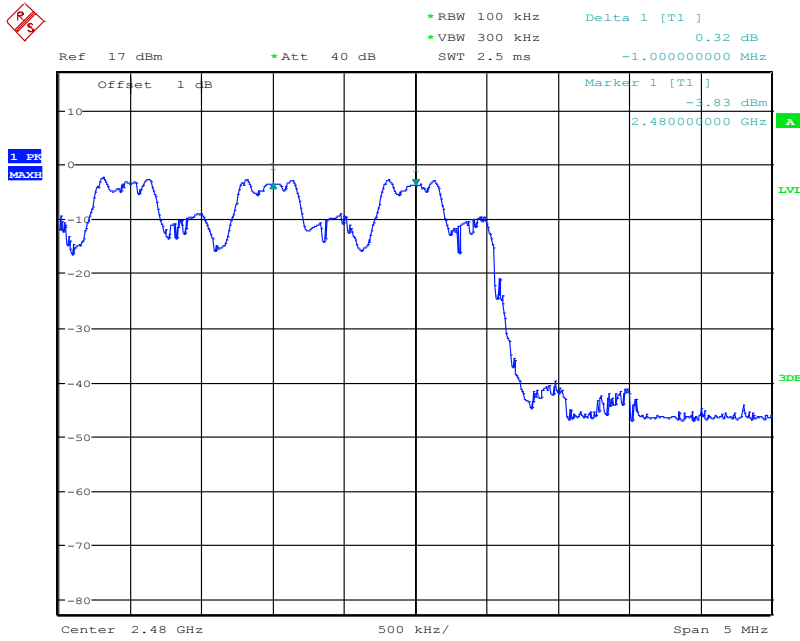

Date: 8.DEC.2016 08:25:47

EDR Mode (8-DPSK)

Low Channel

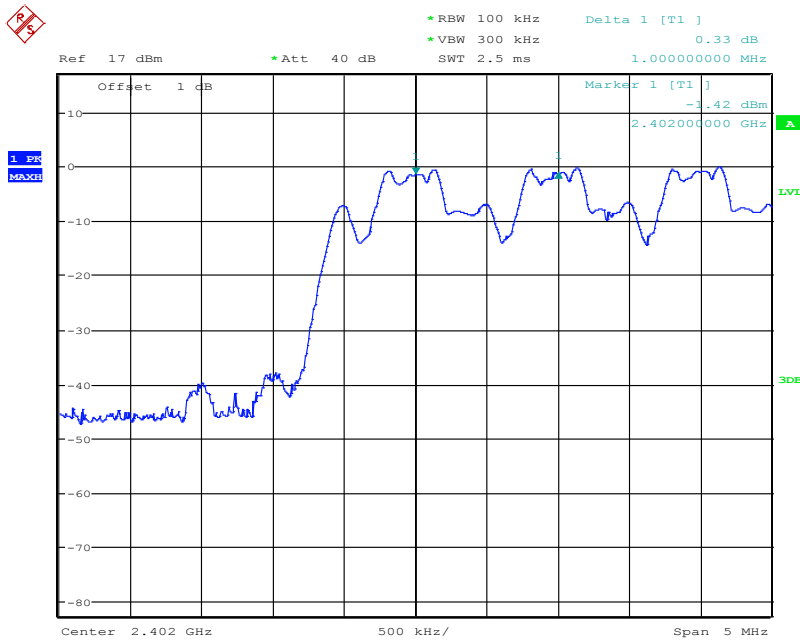

Date: 7.DEC.2016 17:06:11

Middle Channel

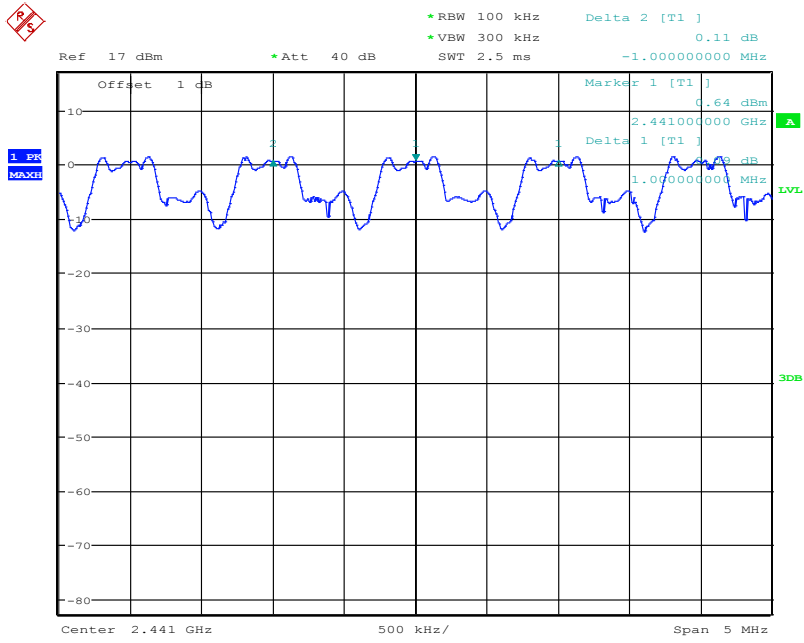

Date: 7.DEC.2016 16:58:09

High Channel

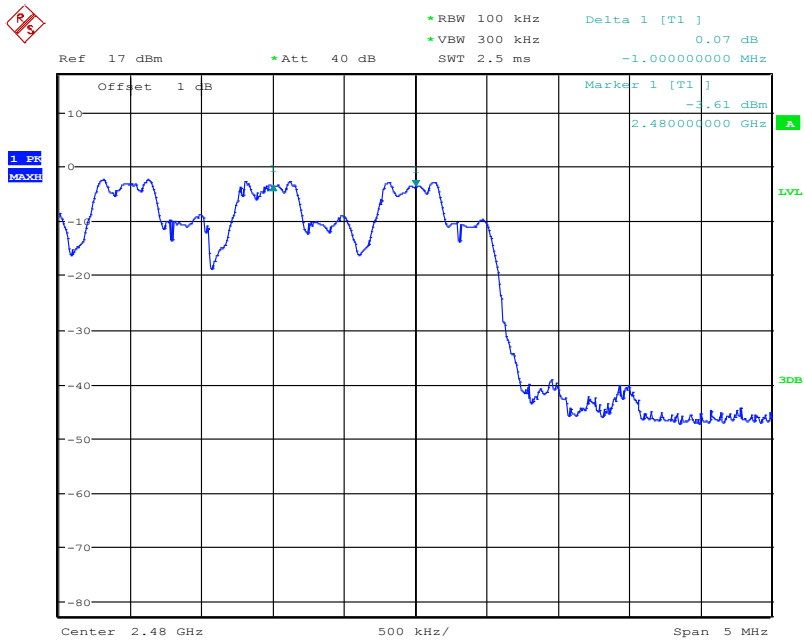

Date: 7.DEC.2016 16:42:11

10 FCC §15.247(a)(1)(iii) –Time of Occupancy (Dwell Time)

10.1 Applicable Standard

According to FCC §15.247(a) (1)(iii).

Frequency hopping systems in the 2400–2483.5 MHz band shall use at least 15 channels. The average time of occupancy on any channel shall not be greater than 0.4 seconds within a period of 0.4 seconds multiplied by the number of hopping channels employed. Frequency hopping systems may avoid or suppress transmissions on a particular hopping frequency provided that a minimum of 15 channels are used.

10.2 Test Procedure

The EUT was worked in channel hopping; Spectrum SPAN was set as 0. Sweep was set as 0.4 * channel no. (s), the quantity of pulse was get from single sweep. In addition, the time of single pulses was tested.

Dwell Time= time slot length * hope rate/ number of hopping channels * 31.6s

Hop rate=1600/s

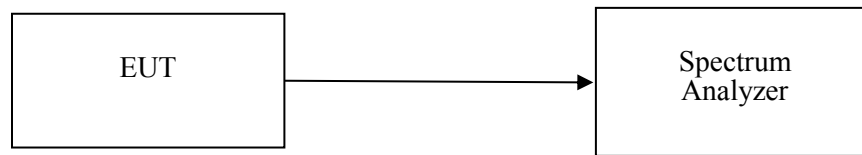

10.3 Test Equipment List and Details

Descriptions	Manufacturers	Models	Serial Numbers	Calibration Date	Calibration Due Date
Spectrum Analyzer	Rohde & Schwarz	FSU26	200268	2016/5/7	2017/5/6
Cable	WOKEN	SFL402	00100A1F6A192S	2015/12/18	2016/12/17

***Statement of Traceability:** Bay Area Compliance Laboratories Corp. (Taiwan) attests that all calibrations have been performed in accordance to requirements that traceable to National Primary Standards and International System of Units (SI).

10.4 Test Environmental Conditions

Temperature:	25 °C
Relative Humidity:	55 %
ATM Pressure:	101.0 kPa

The testing was performed by David Hsu on 2016-10-25 to 2016-11-10.

10.5 Test Results

Test mode: BT mode / 2402 ~ 2480MHz(GFSK)						
Mode	Pulse Time (ms)	Hopping Number	Period Time (s)	Total of Dwell (ms)	Limit (ms)	RESULT
DH1	0.369	280	31.6	103.32	<400	PASS
DH3	1.638	180	31.6	294.84	<400	PASS
DH5	2.884	120	31.6	346.08	<400	PASS
Test mode: EDR mode / 2402 ~ 2480MHz ($\pi/4$-DQPSK)						
Mode	Pulse Time (ms)	Hopping Number	Period Time (s)	Total of Dwell (ms)	Limit (ms)	RESULT
2DH1	0.380	320	31.6	121.60	<400	PASS
2DH3	1.642	180	31.6	295.56	<400	PASS
2DH5	2.900	120	31.6	348.00	<400	PASS
Test mode: EDR mode / 2402 ~ 2480MHz (8-DPSK)						
Mode	Pulse Time (ms)	Hopping Number	Period Time (s)	Total of Dwell (ms)	Limit (ms)	RESULT
3DH1	0.380	320	31.6	121.60	<400	PASS
3DH3	1.642	180	31.6	295.56	<400	PASS
3DH5	2.884	120	31.6	346.08	<400	PASS

Note: Dwell time=Pulse time (ms) × Hopping Number

Please refer to the following plots

BDR Mode (GFSK)

DH1: Pulse Width

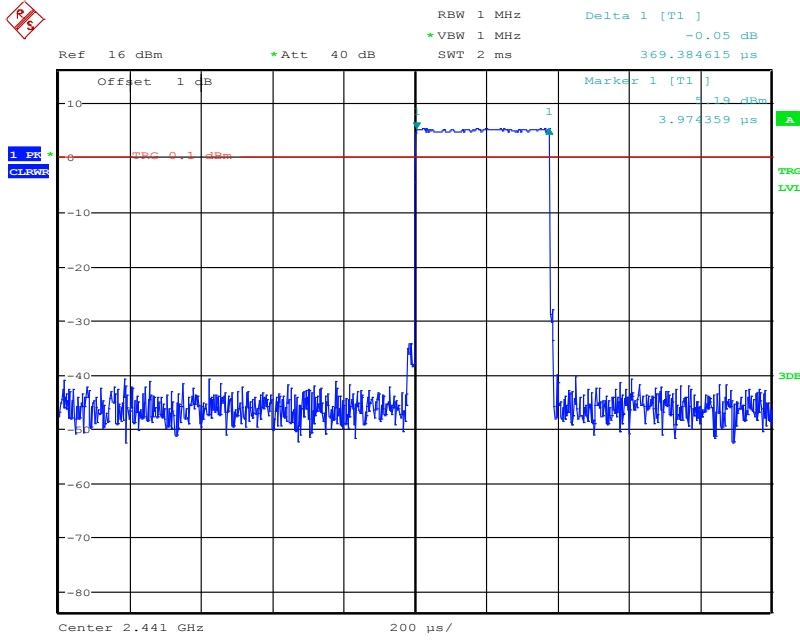

Date: 25.OCT.2016 13:24:46

DH1: Hopping Number

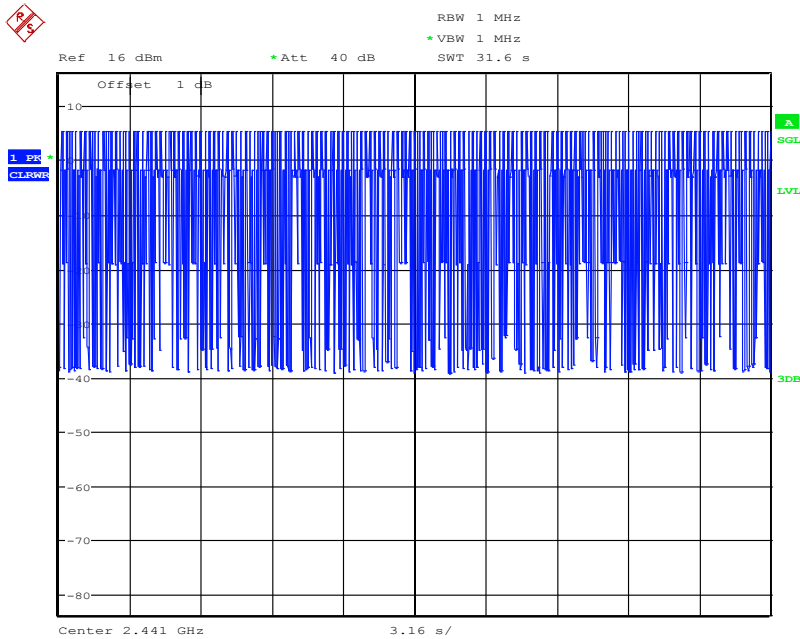

Date: 25.OCT.2016 13:26:07

DH1: Hopping Number /10

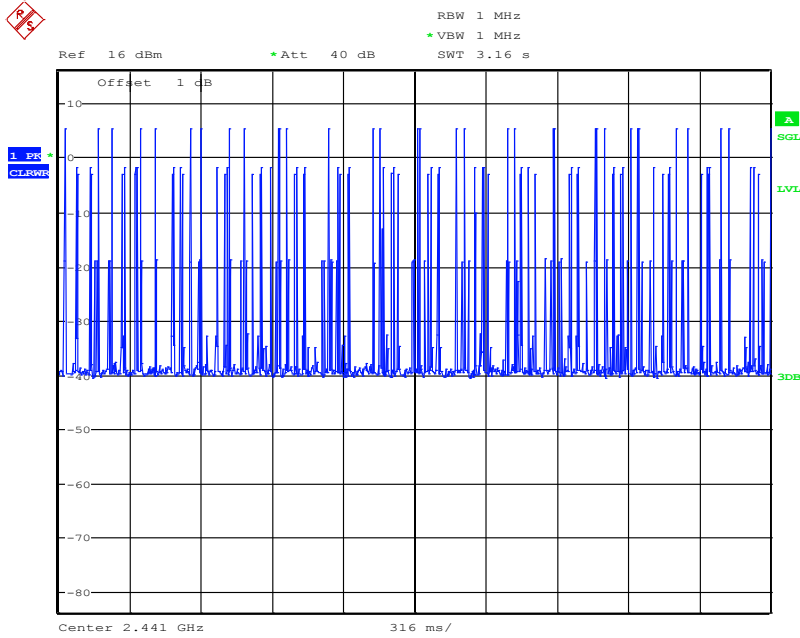

Date: 25.OCT.2016 13:26:33

DH3: Pulse Width

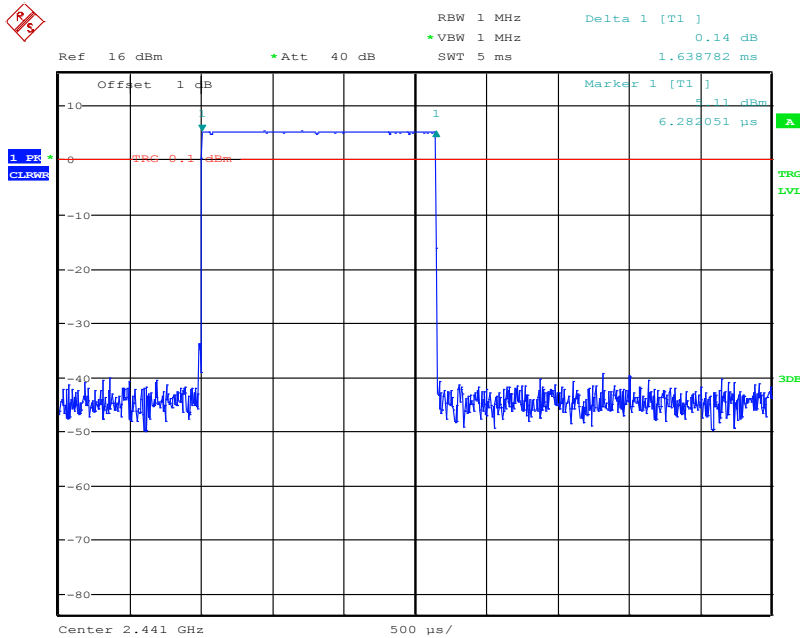

Date: 25.OCT.2016 13:27:47

DH3: Hopping Number

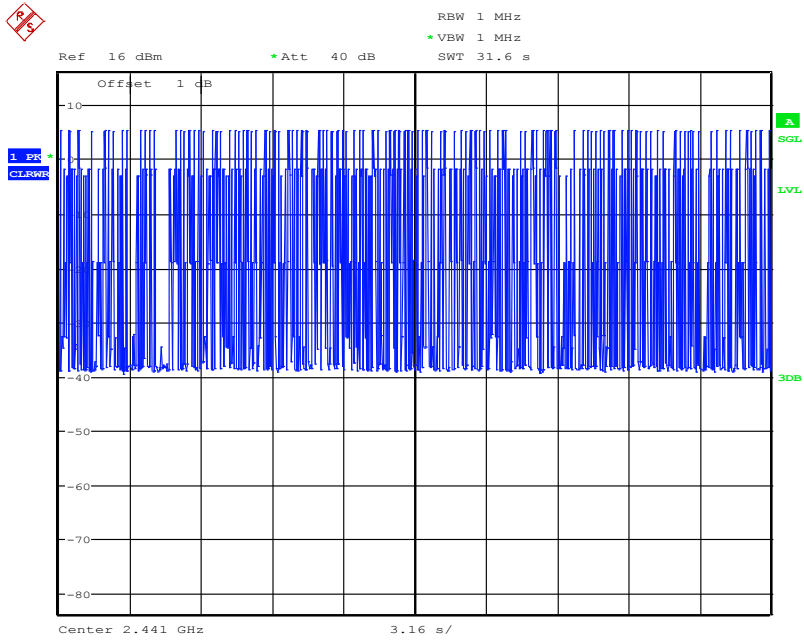

Date: 25.OCT.2016 13:28:54

DH3: Hopping Number /10

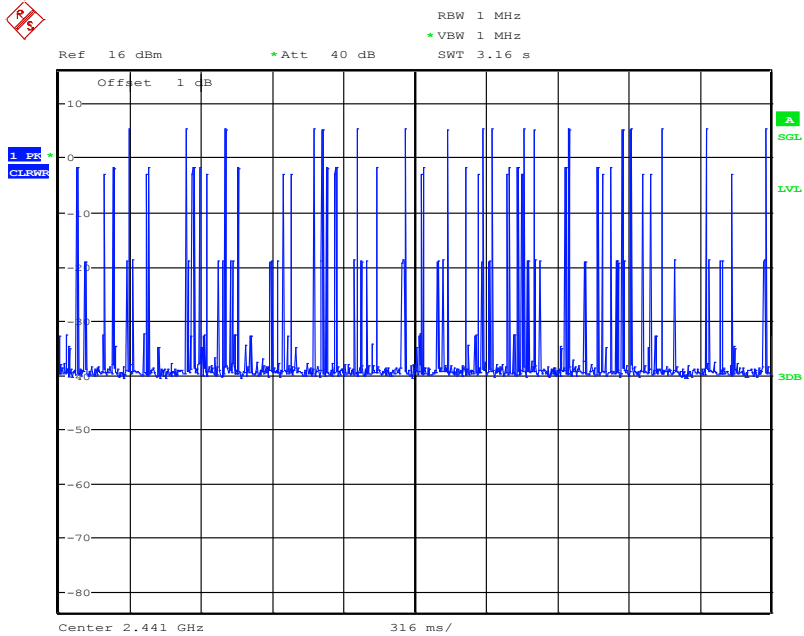

Date: 25.OCT.2016 13:29:17

DH5: Pulse Width

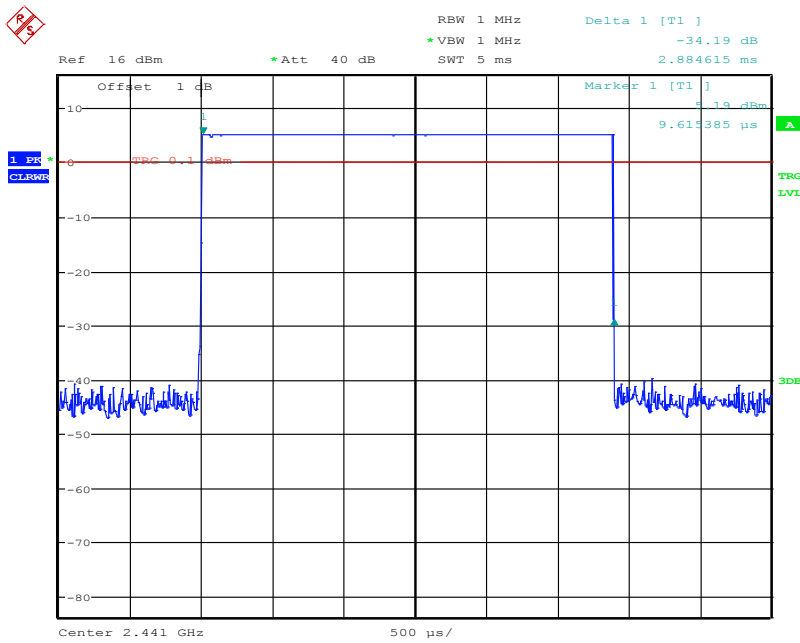

Date: 25.OCT.2016 13:17:41

DH5: Hopping Number

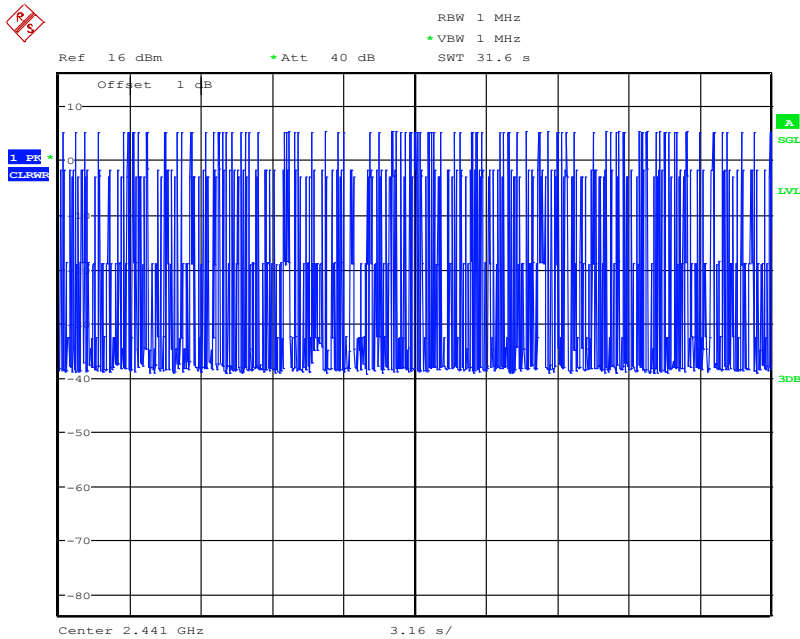

Date: 25.OCT.2016 13:22:39

DH5: Hopping Number /10

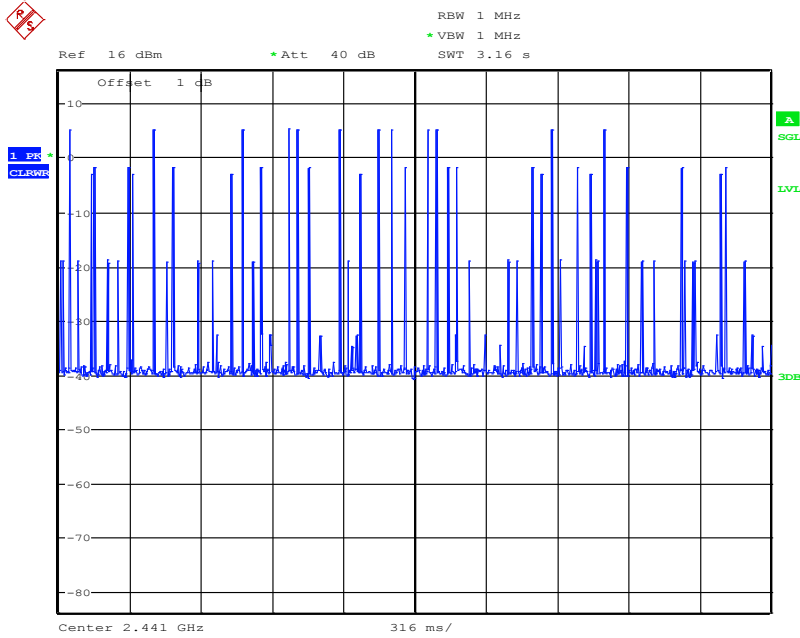

Date: 25.OCT.2016 13:21:48

EDR Mode ($\pi/4$ -DQPSK)

2DH1: Pulse Width

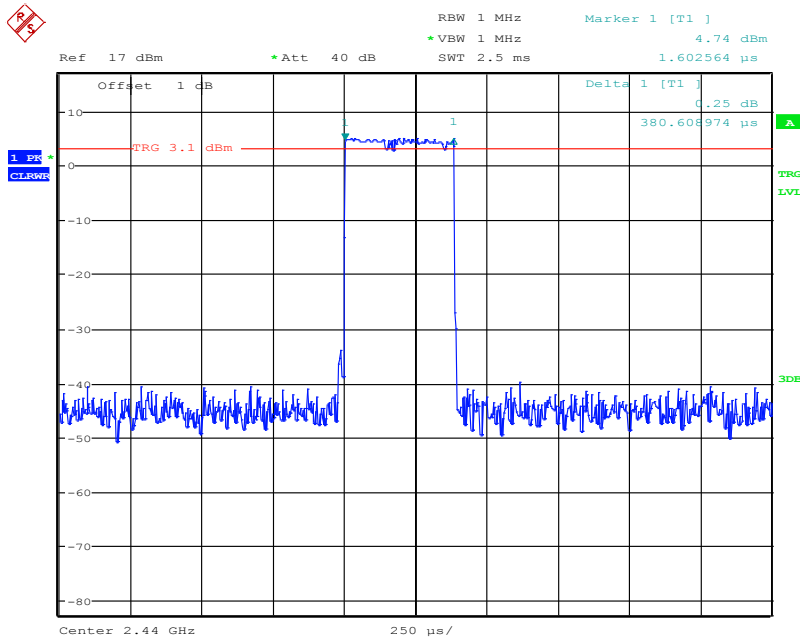

Date: 10.NOV.2016 10:08:54

2DH1: Hopping Number

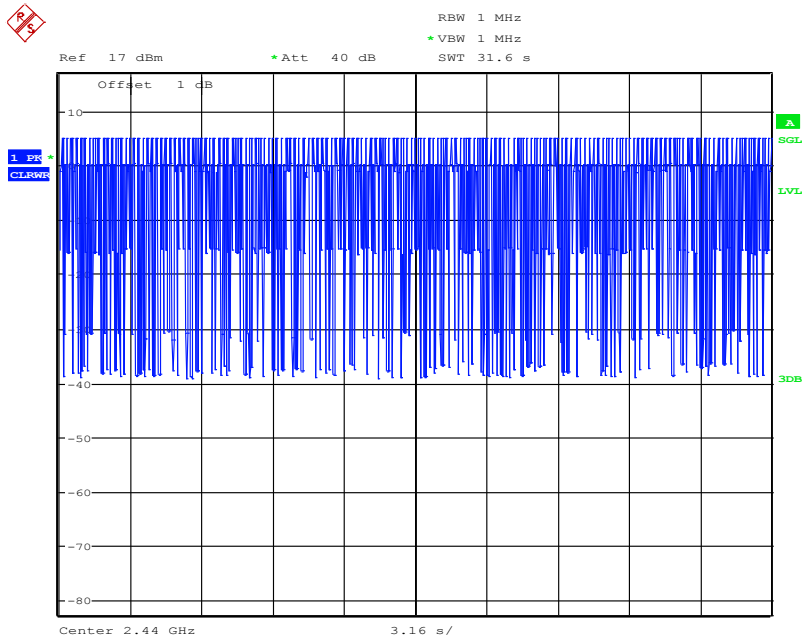

Date: 10.NOV.2016 10:11:44

2DH1: Hopping Number /10

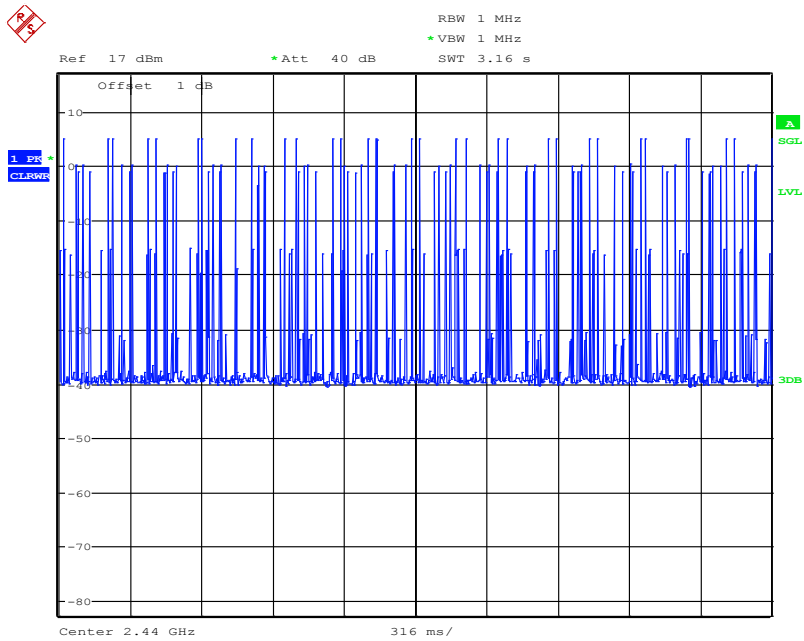

Date: 10.NOV.2016 10:12:22

2DH3: Pulse Width

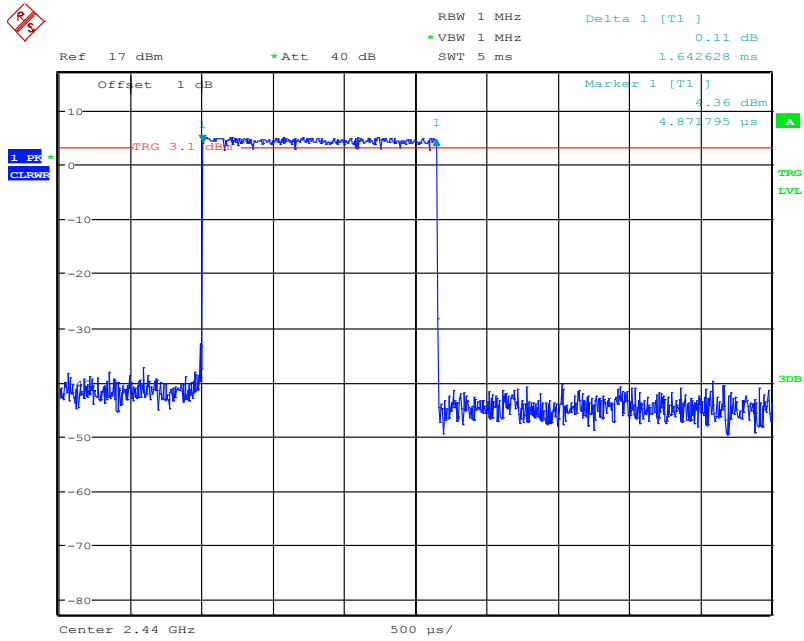

Date: 10.NOV.2016 10:14:48

2DH3: Hopping Number

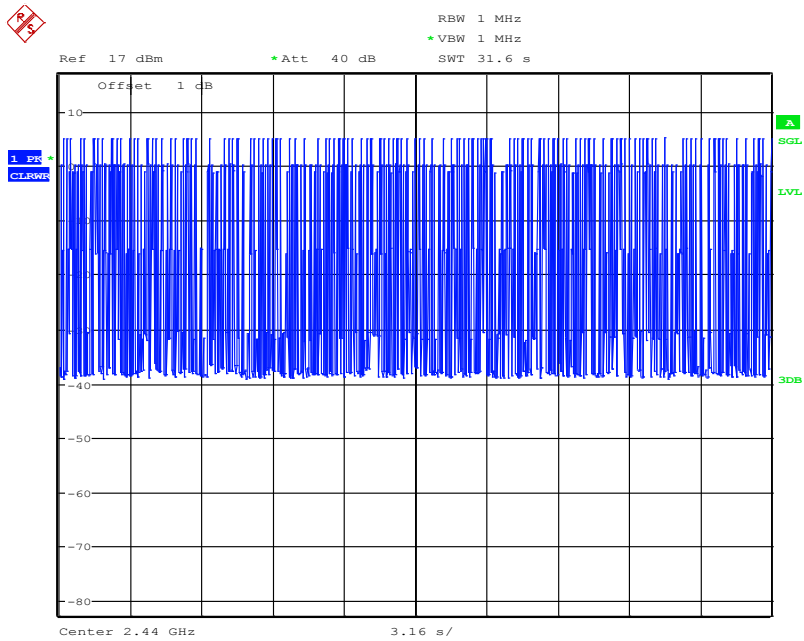

Date: 10.NOV.2016 10:13:56

2DH3: Hopping Number /10

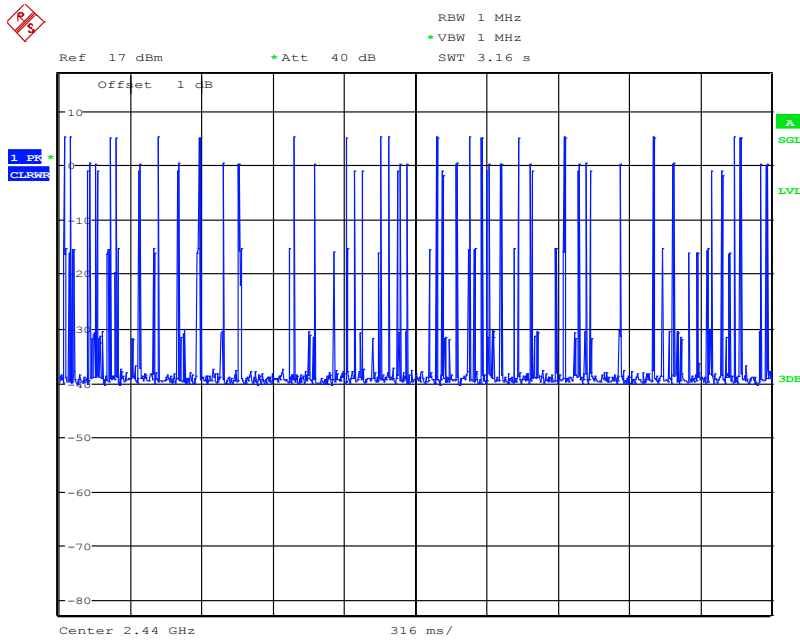

Date: 10.NOV.2016 10:12:55

2DH5: Pulse Width

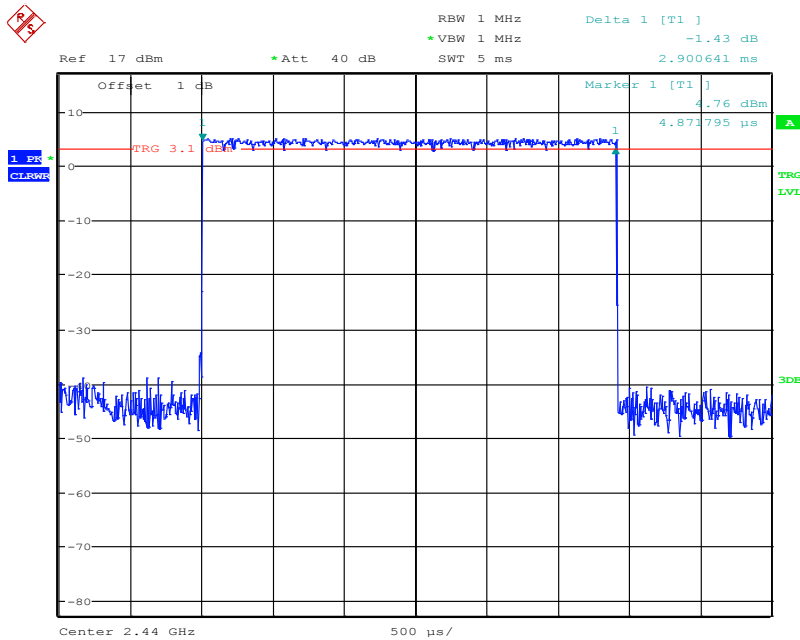

Date: 10.NOV.2016 10:15:21

2DH5: Hopping Number

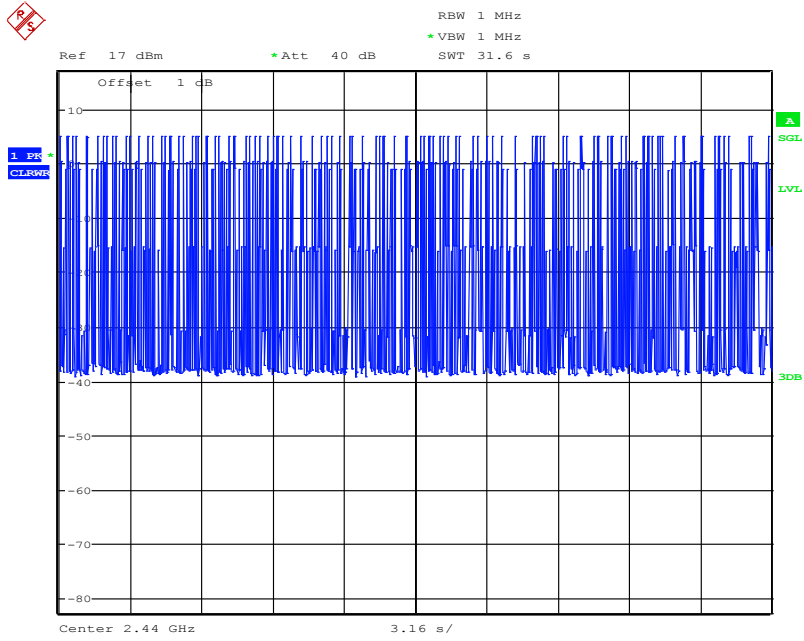

Date: 10.NOV.2016 10:16:27

2DH5: Hopping Number /10

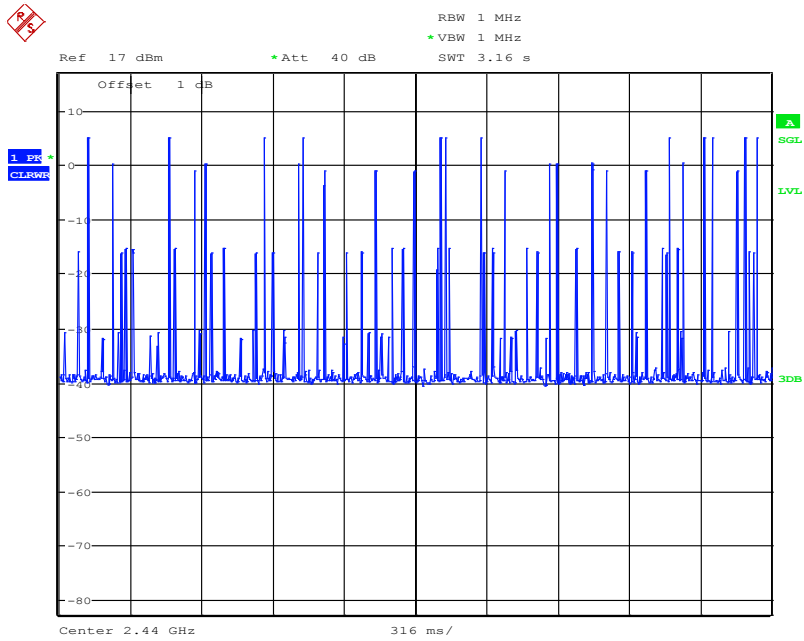

Date: 10.NOV.2016 10:16:47

EDR Mode (8-DPSK)

3DH1: Pulse Width

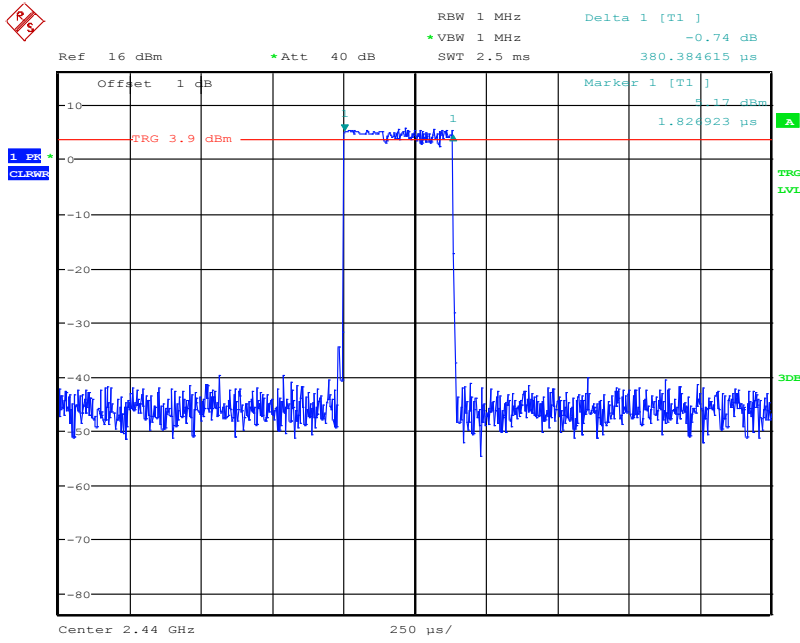

Date: 25.OCT.2016 14:53:21

3DH1: Hopping Number

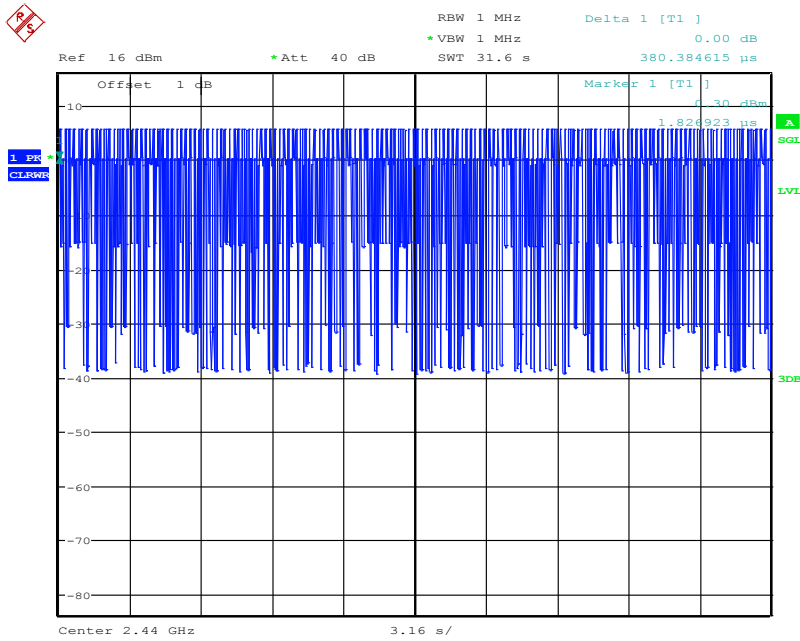

Date: 25.OCT.2016 14:54:34

3DH1: Hopping Number /10

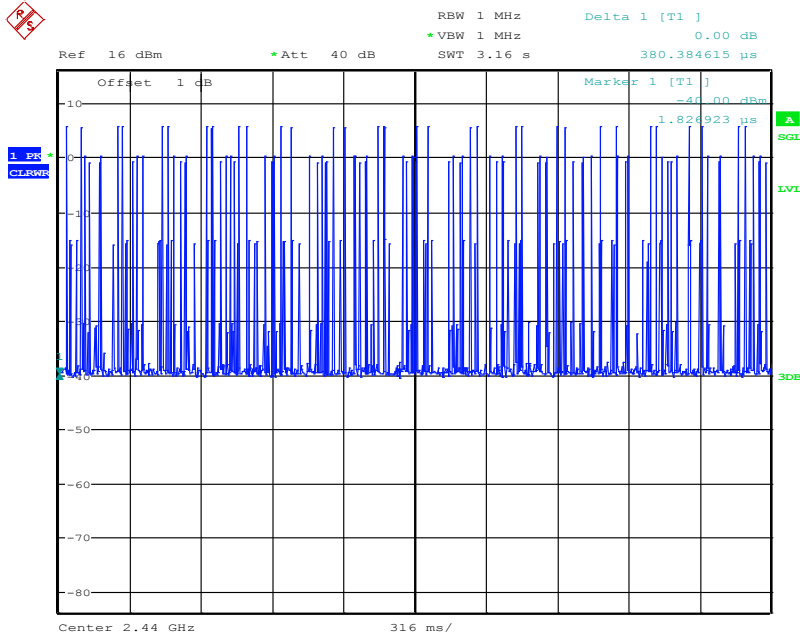

Date: 25.OCT.2016 14:54:54

3DH3: Pulse Width

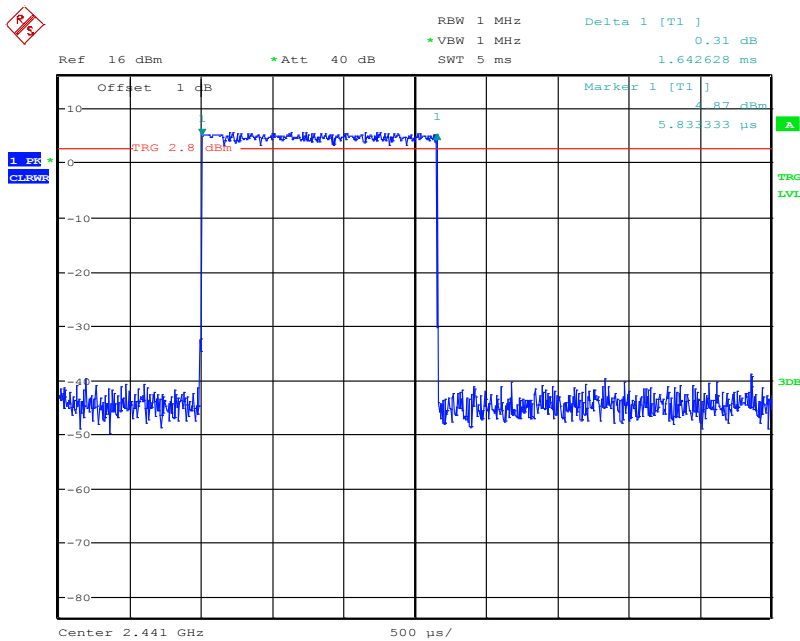

Date: 25.OCT.2016 14:39:15

3DH3: Hopping Number

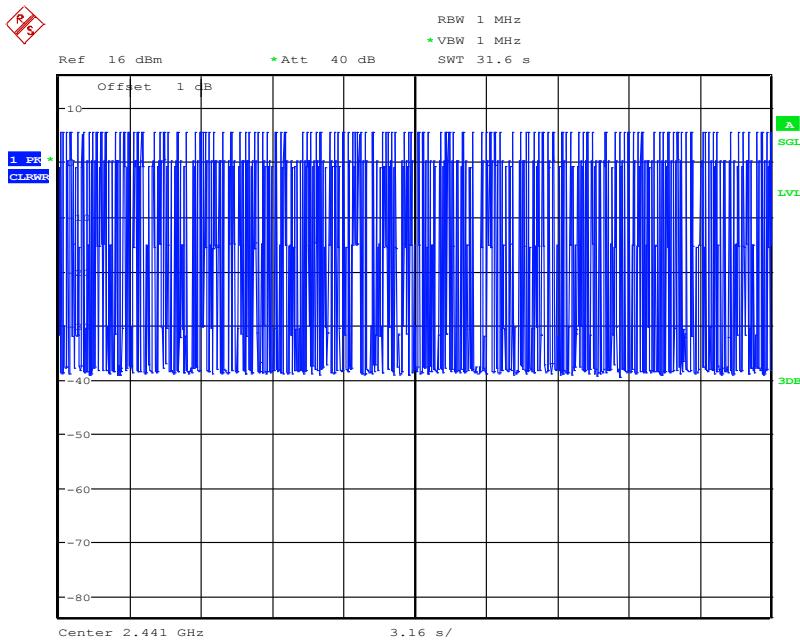

Date: 25.OCT.2016 14:38:21

3DH3: Hopping Number /10

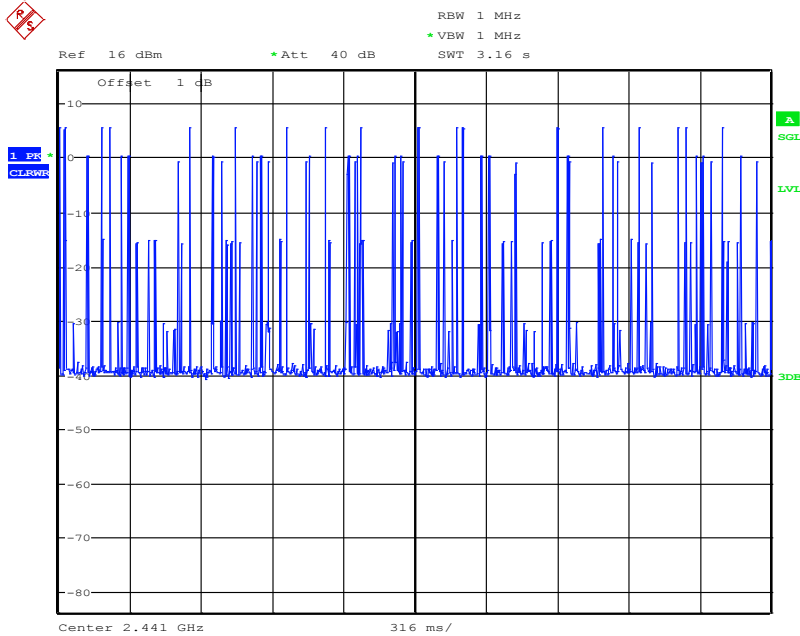

Date: 25.OCT.2016 14:37:13

3DH5: Pulse Width

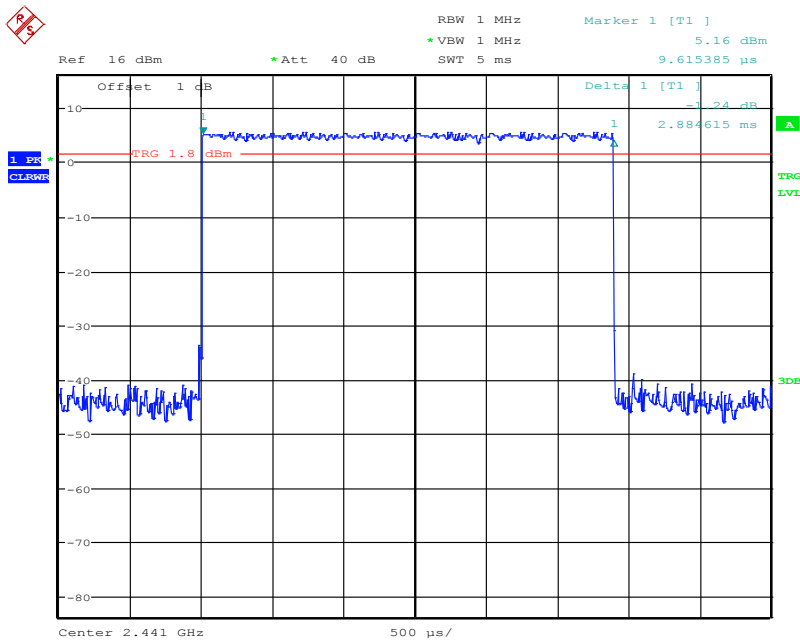

Date: 25.OCT.2016 14:34:37

3DH5: Hopping Number

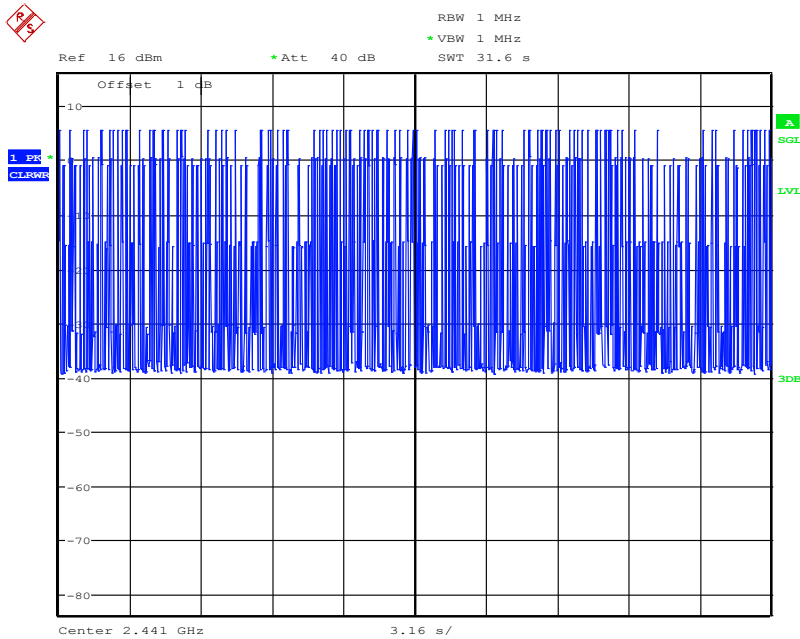

Date: 25.OCT.2016 14:36:16

3DH5: Hopping Number /10

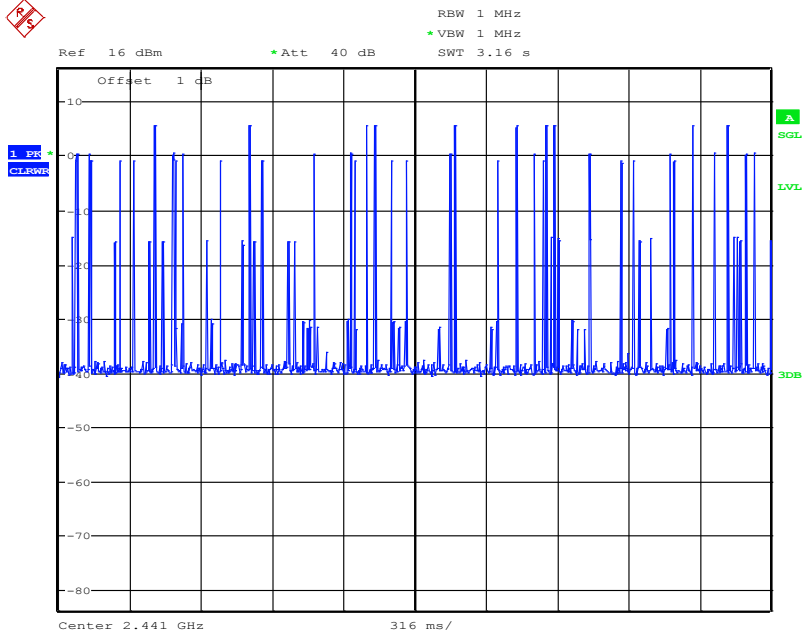

Date: 25.OCT.2016 14:36:36

11 FCC §15.247(a)(1)(iii) –Quantity of hopping channel Test

11.1 Applicable Standard

According to FCC §15.247(a) (1) (iii).

Frequency hopping systems in the 2400–2483.5 MHz band shall use at least 15 channels. The average time of occupancy on any channel shall not be greater than 0.4 seconds within a period of 0.4 seconds multiplied by the number of hopping channels employed. Frequency hopping systems may avoid or suppress transmissions on a particular hopping frequency provided that a minimum of 15 channels are used.

11.2 Test Procedure

1. Check the calibration of the measuring instrument (SA) using either an internal calibrator or a known signal from an external generator.
2. Set the EUT in hopping mode from first channel to last.
3. By using the Max-Hold function record the Quantity of the channel.

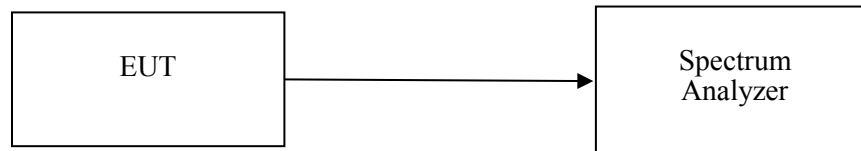

11.3 Test Equipment List and Details

Descriptions	Manufacturers	Models	Serial Numbers	Calibration Date	Calibration Due Date
Spectrum Analyzer	Rohde & Schwarz	FSU26	200268	2016/5/7	2017/5/6
Cable	WOKEN	SFL402	00100A1F6A192S	2015/12/18	2016/12/17

***Statement of Traceability:** Bay Area Compliance Laboratories Corp. (Taiwan) attests that all calibrations have been performed in accordance to requirements that traceable to National Primary Standards and International System of Units (SI).

11.4 Test Environmental Conditions

Temperature:	25 °C
Relative Humidity:	55 %
ATM Pressure:	101.0 kPa

The testing was performed by David Hsu on 2016-10-25 to 2016-11-10.

11.5 Test Results

Mode	Frequency Range (MHz)	Number of Hopping Channel (CH)	Limit (CH)	Result
GFSK	2402-2480	79	>15	Compliance
$\pi/4$ -DQPSK	2402-2480	79	>15	Compliance
8DPSK	2402-2480	79	>15	Compliance

BDR Mode (GFSK)

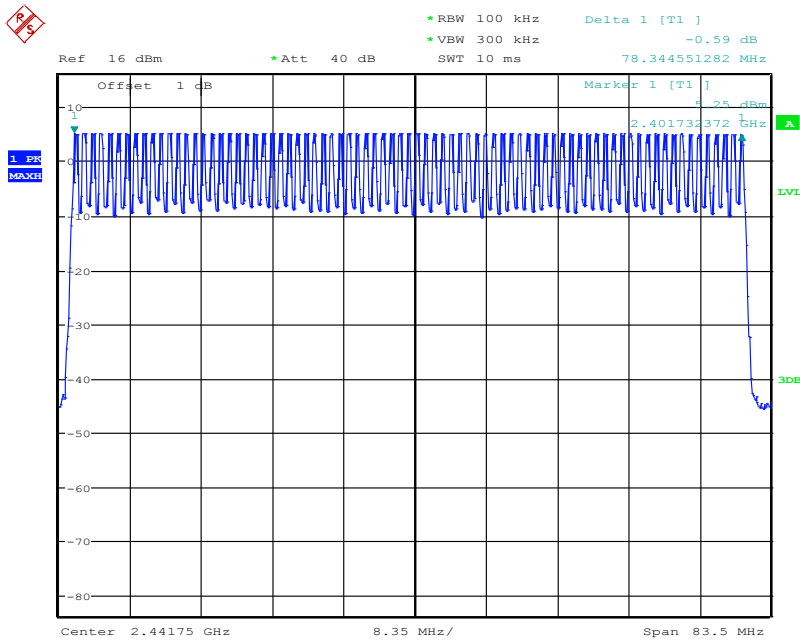

Date: 25.OCT.2016 12:52:41

EDR Mode ($\pi/4$ -DQPSK)

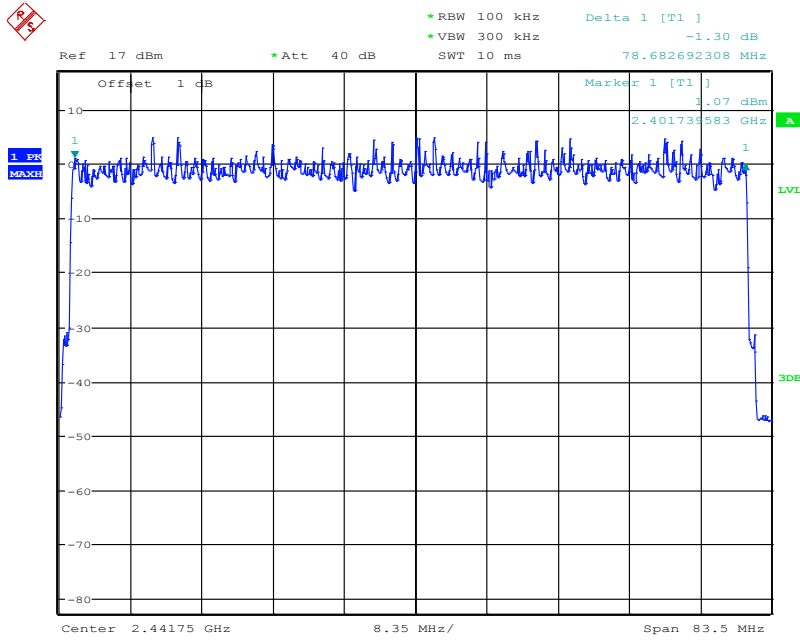

Date: 10.NOV.2016 10:05:41

EDR Mode (8-DPSK)

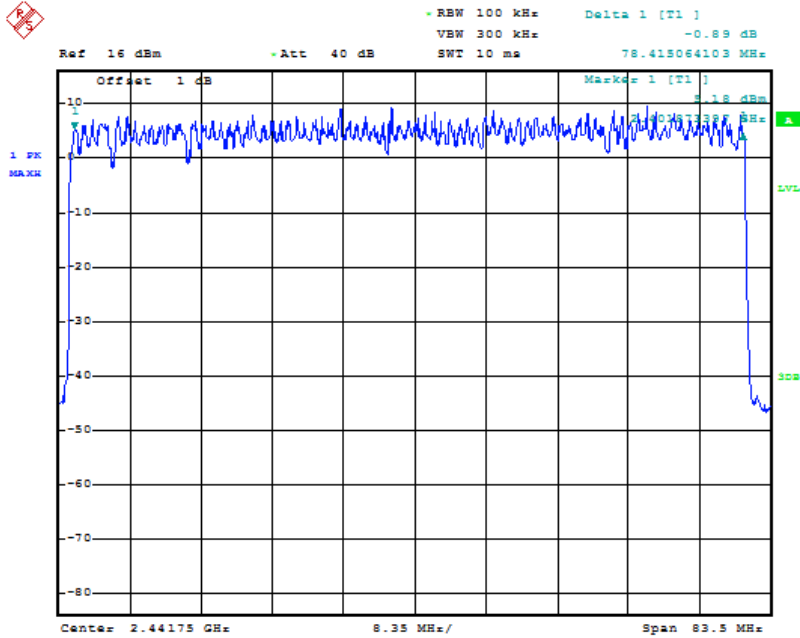

Date: 25.OCT.2016 09:57:33

12 FCC §15.247(b)(1) – Maximum Output Power

12.1 Applicable Standard

According to FCC §15.247(b) (1).

Frequency hopping systems operating in the 2400–2483.5 MHz band employing at least 75 non-overlapping hopping channels, and all frequency hopping systems in the 5725- 5850 MHz band: 1 watt. For all other frequency hopping systems in the 2400–2483.5 MHz band: 0.125 watts.

12.2 Test Procedure

1. Place the EUT on a bench and set in transmitting mode.
2. Remove the antenna from the EUT and then connect a low loss RF cable from the antenna port to an EMI test receiver.
3. Add a correction factor to the display.

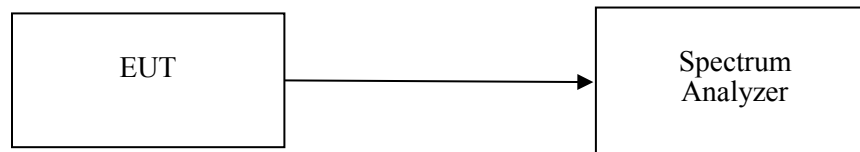

12.3 Test Equipment List and Details

Descriptions	Manufacturers	Models	Serial Numbers	Calibration Date	Calibration Due Date
Spectrum Analyzer	Rohde & Schwarz	FSU26	200268	2016/5/7	2017/5/6
Cable	WOKEN	SFL402	00100A1F6A192S	2015/12/18	2016/12/17

***Statement of Traceability:** Bay Area Compliance Laboratories Corp. (Taiwan) attests that all calibrations have been performed in accordance to requirements that traceable to National Primary Standards and International System of Units (SI).

12.4 Test Environmental Conditions

Temperature:	25 °C
Relative Humidity:	55 %
ATM Pressure:	101.0 kPa

The testing was performed by David Hsu on 2016-10-25 to 2016-11-10.

12.5 Test Results

Channel	Frequency (MHz)	Conducted Output Power (dBm)	Conducted Output Power (W)	Limit (W)	Result
<i>BDR Mode (GFSK)</i>					
Low	2402	5.32	0.00340	1	Compliance
Middle	2441	5.25	0.00335	1	Compliance
High	2480	5.10	0.00324	1	Compliance
<i>EDR Mode ($\pi/4$-DQPSK)</i>					
Low	2402	5.67	0.00369	1	Compliance
Middle	2441	5.50	0.00355	1	Compliance
High	2480	5.43	0.00349	1	Compliance
<i>EDR Mode (8-DPSK)</i>					
Low	2402	6.32	0.00429	1	Compliance
Middle	2441	6.17	0.00414	1	Compliance
High	2480	6.10	0.00407	1	Compliance

Please refer to the following plots

BDR Mode (GFSK)

Low Channel

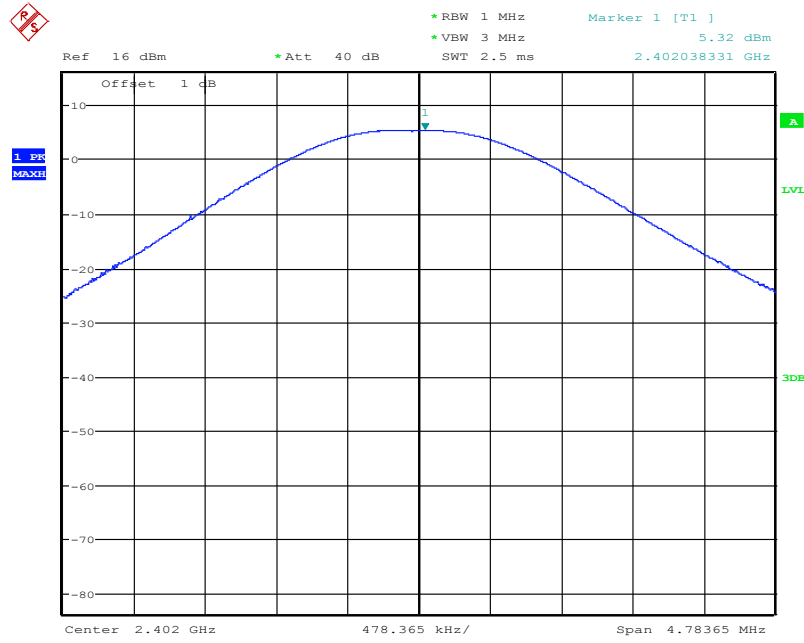

Date: 25.OCT.2016 11:13:14

Middle Channel

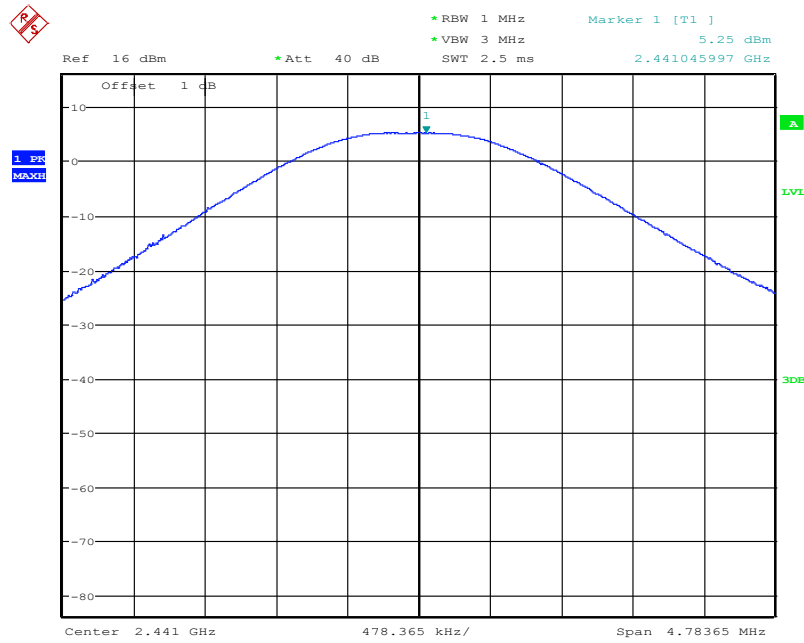

Date: 25.OCT.2016 11:15:17

High Channel

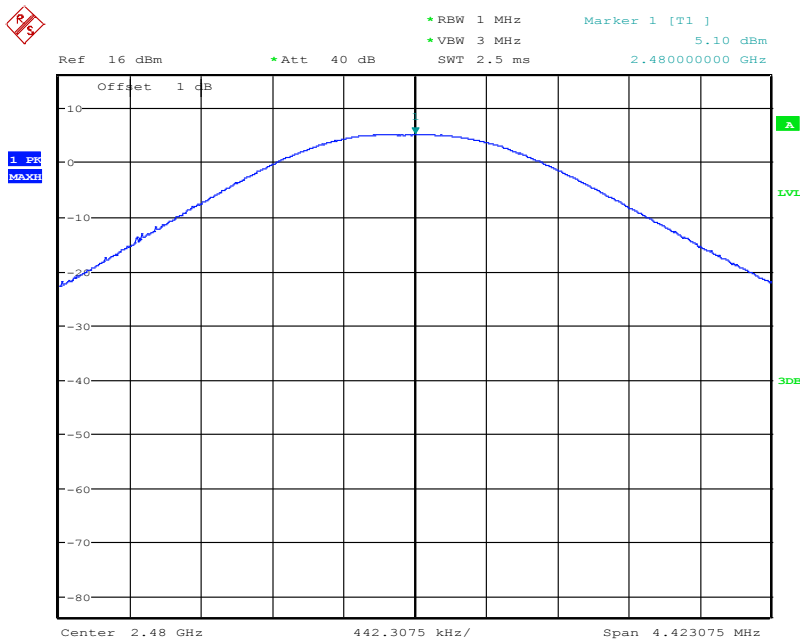

Date: 25.OCT.2016 11:16:27

EDR Mode ($\pi/4$ -DQPSK)

Low Channel

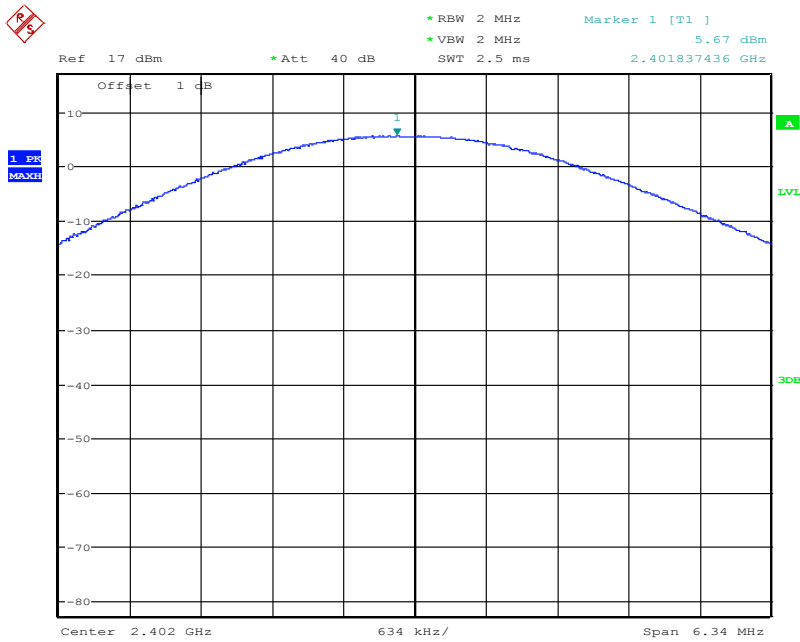

Date: 10.NOV.2016 09:45:08

Middle Channel

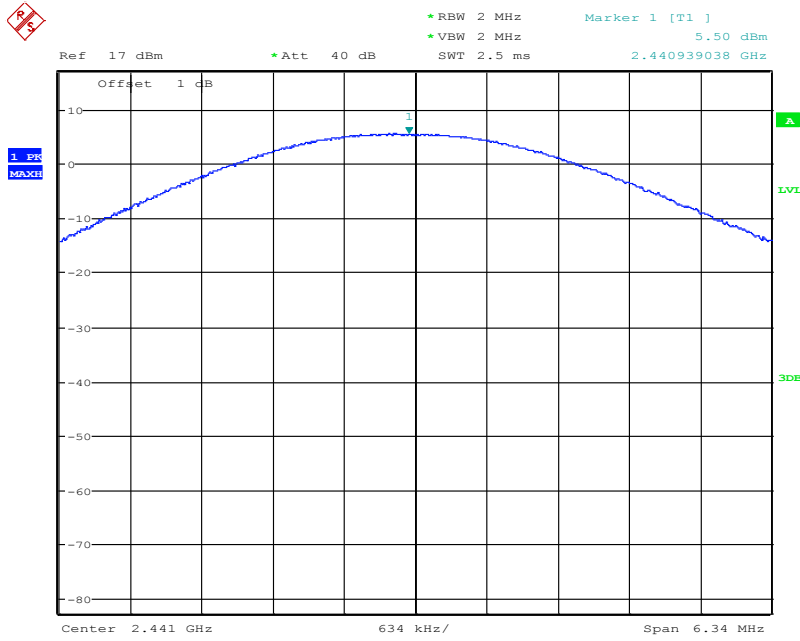

Date: 10.NOV.2016 09:49:52

High Channel

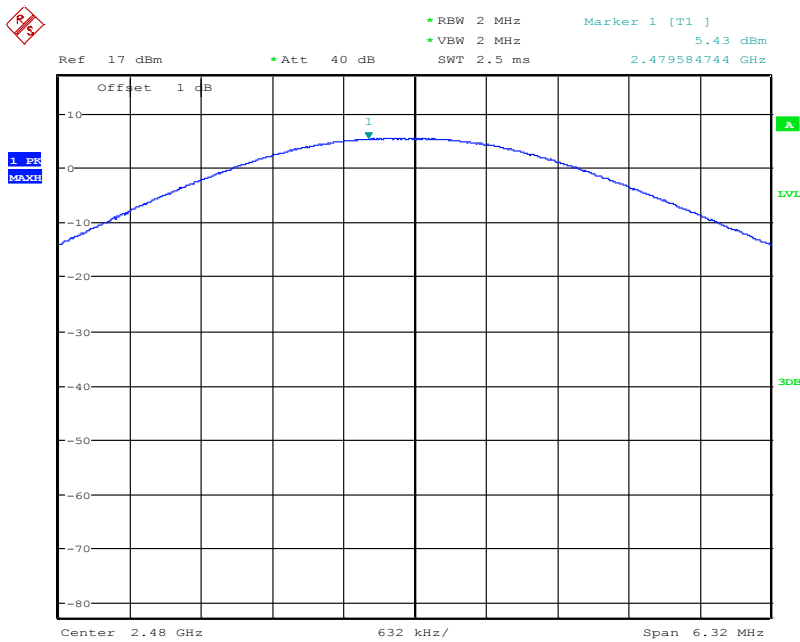

Date: 10.NOV.2016 09:52:49

EDR Mode (8-DPSK)

Low Channel

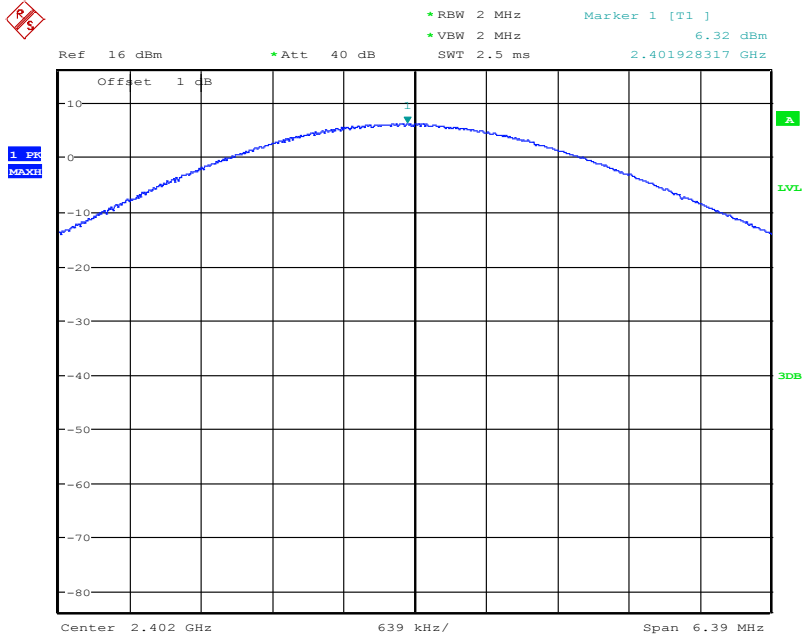

Date: 25.OCT.2016 14:04:30

Middle Channel

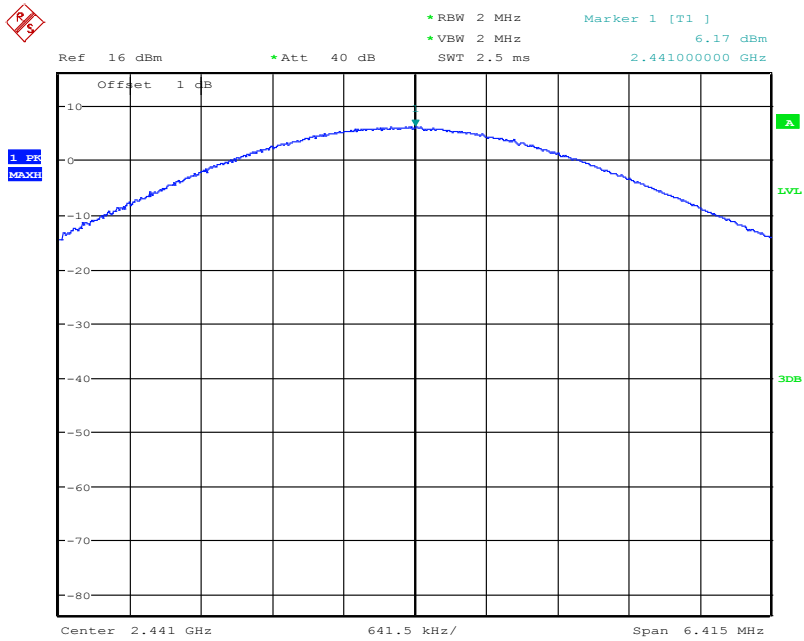

Date: 25.OCT.2016 14:06:21

High Channel

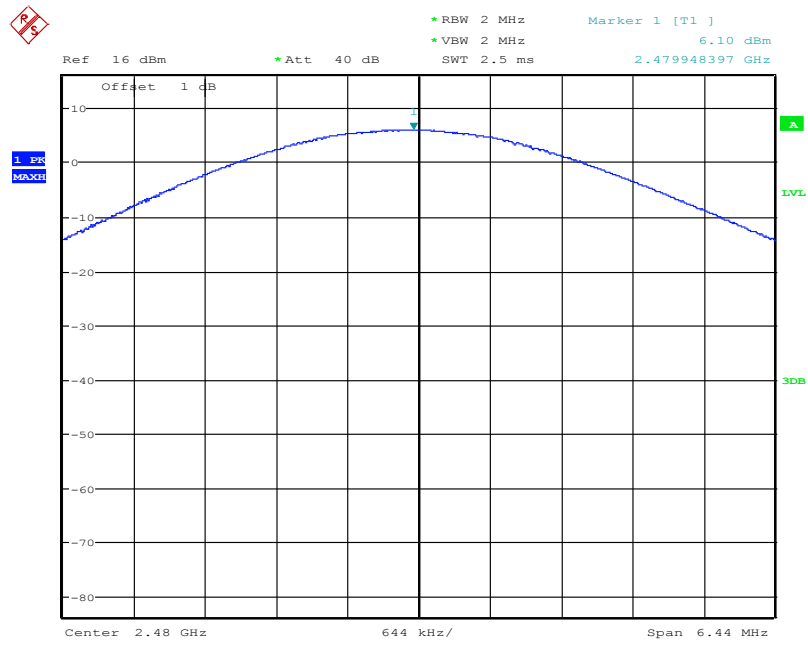

Date: 25.OCT.2016 14:07:24

13 FCC §15.247(d) – 100 kHz Bandwidth of Frequency Band Edge

13.1 Applicable Standard

According to FCC §15.247(d).

In any 100 kHz bandwidth outside the frequency band in which the spread spectrum or digitally modulated intentional radiator is operating, the radio frequency power that is produced by the intentional radiator shall be at least 20 dB below that in the 100 kHz bandwidth within the band that contains the highest level of the desired power, based on either an RF conducted or a radiated measurement, provided the transmitter demonstrates compliance with the peak conducted power limits. If the transmitter complies with the conducted power limits based on the use of RMS averaging over a time interval, as permitted under paragraph (b)(3) of this section, the attenuation required under this paragraph shall be 30 dB instead of 20 dB. Attenuation below the general limits specified in §15.209(a) is not required. In addition, radiated emissions which fall in the restricted bands, as defined in §15.205(a), must also comply with the radiated emission limits specified in §15.209(a) (see §15.205(c)).

13.2 Test Procedure

1. Check the calibration of the measuring instrument using either an internal calibrator or a known signal from an external generator.
2. Position the EUT without connection to measurement instrument. Turn on the EUT and connect its antenna terminal to measurement instrument via a low loss cable. Then set it to any one measured frequency within its operating range, and make sure the instrument is operated in its linear range.
3. Set RBW to 100 kHz and VBW of spectrum analyzer to 300 kHz with a convenient frequency span including 100 kHz bandwidth from band edge.
4. Measure the highest amplitude appearing on spectral display and set it as a reference level. Plot the graph with marking the highest point and edge frequency.
5. Repeat above procedures until all measured frequencies were complete.

13.3 Test Equipment List and Details

Descriptions	Manufacturers	Models	Serial Numbers	Calibration Date	Calibration Due Date
Spectrum Analyzer	Rohde & Schwarz	FSU26	200268	2016/5/7	2017/5/6
Cable	WOKEN	SFL402	00100A1F6A192S	2015/12/18	2016/12/17

***Statement of Traceability:** Bay Area Compliance Laboratories Corp. (Taiwan) attests that all calibrations have been performed in accordance to requirements that traceable to National Primary Standards and International System of Units (SI).

13.4 Test Environmental Conditions

Temperature:	25 °C
Relative Humidity:	55 %
ATM Pressure:	101.0 kPa

The testing was performed by David Hsu on 2016-10-25 to 2016-11-10.

13.5 Test Results

Channel	Frequency (MHz)	Delta Peak to Band Emission (dBc)	Limit (dBc)	RESULT
<i>BDR Mode (GFSK)</i>				
Low	2402	49.56	≥ 20	PASS
High	2480	51.33	≥ 20	PASS
<i>BDR Hopping Mode (GFSK)</i>				
Low	2402-2480	50.32	≥ 20	PASS
High	2402-2480	49.97	≥ 20	PASS
<i>EDR Mode ($\pi/4$-DQPSK)</i>				
Low	2402	49.05	≥ 20	PASS
High	2480	50.35	≥ 20	PASS
<i>EDR Hopping Mode ($\pi/4$-DQPSK)</i>				
Low	2402-2480	50.85	≥ 20	PASS
High	2402-2480	48.13	≥ 20	PASS
<i>EDR Mode (8-DPSK)</i>				
Low	2402	49.45	≥ 20	PASS
High	2480	49.22	≥ 20	PASS
<i>EDR Hopping Mode (8-DPSK)</i>				
Low	2402-2480	51.39	≥ 20	PASS
High	2402-2480	46.56	≥ 20	PASS

Please refer to the following plots

BDR Mode (GFSK)

Band Edge, CH Low

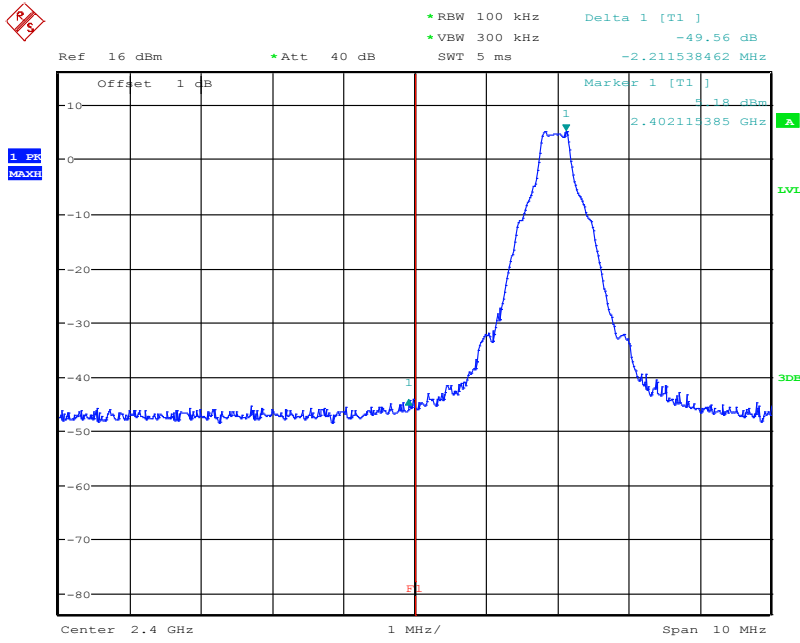

Date: 25.OCT.2016 11:29:10

Band Edge, CH High

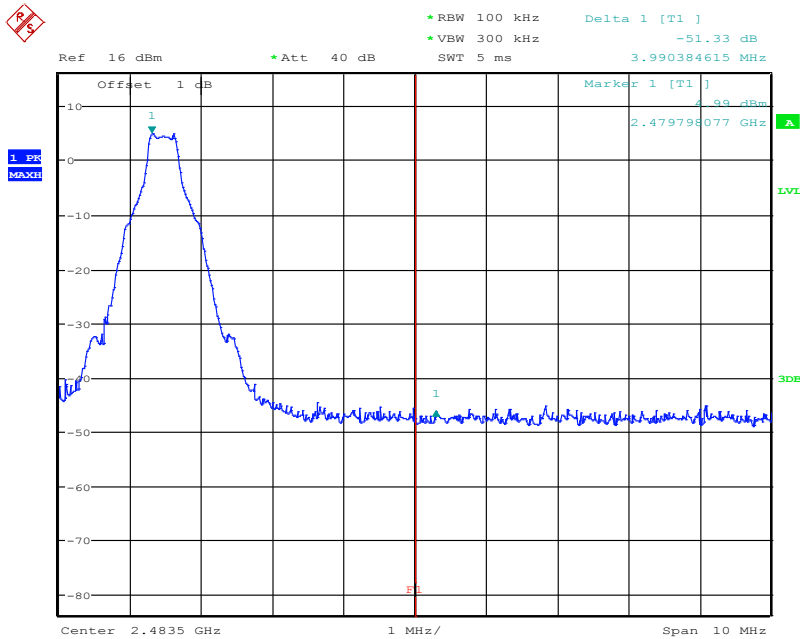

Date: 25.OCT.2016 11:36:53

BDR Hopping Mode (GFSK)

Band Edge, CH Low

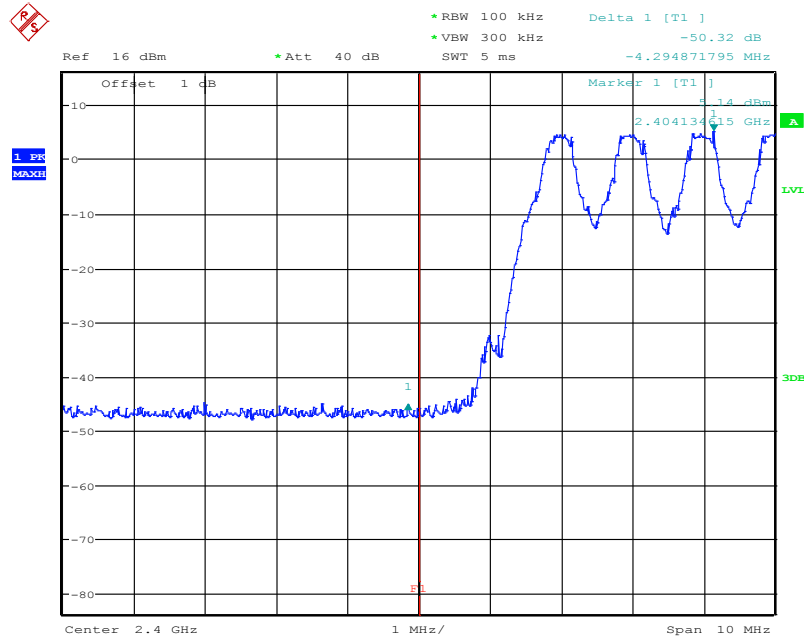

Date: 25.OCT.2016 11:31:09

Band Edge, CH High

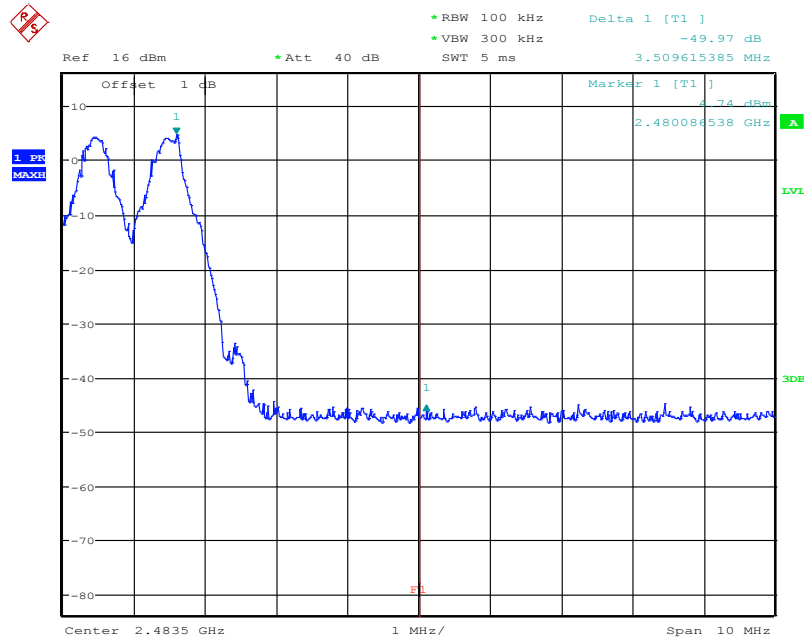

Date: 25.OCT.2016 11:35:56

EDR Mode ($\pi/4$ -DQPSK)

Band Edge, CH Low

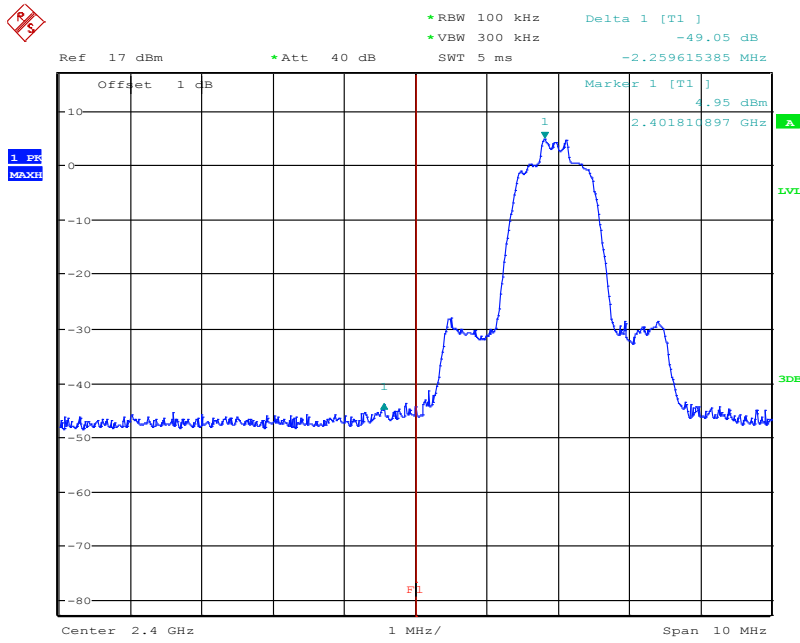

Date: 10.NOV.2016 09:59:07

Band Edge, CH High

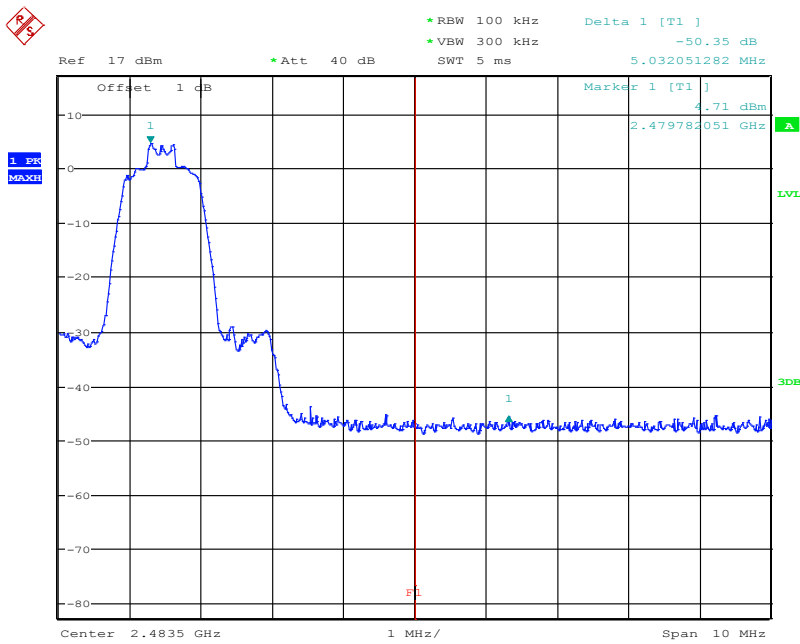

Date: 10.NOV.2016 09:55:00

EDR Hopping Mode ($\pi/4$ -DQPSK)

Band Edge, CH Low

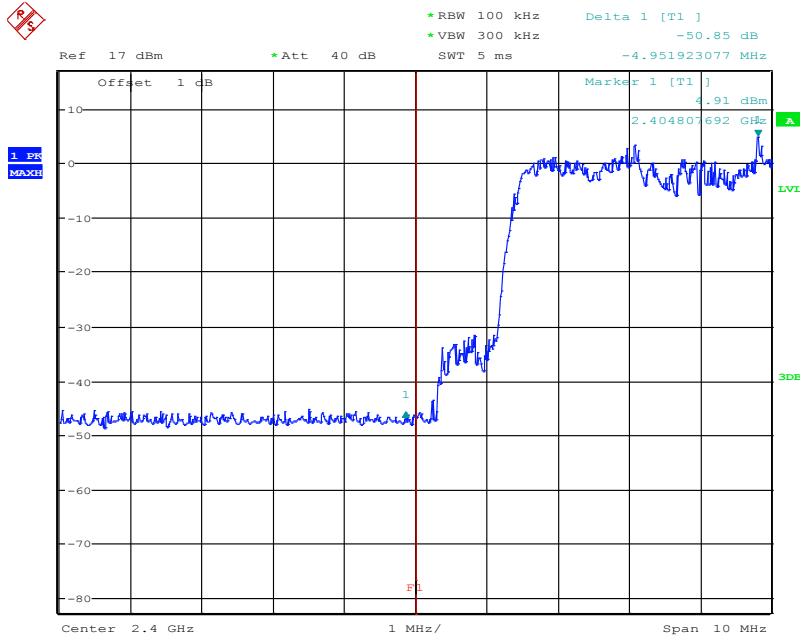

Date: 10.NOV.2016 10:00:03

Band Edge, CH High

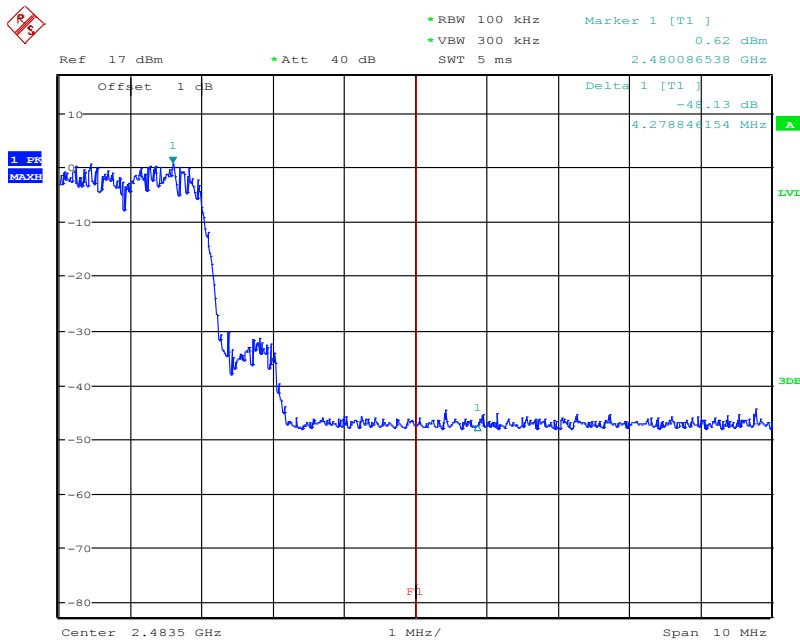

Date: 10.NOV.2016 09:57:06

EDR Mode (8-DPSK)

Band Edge, CH Low

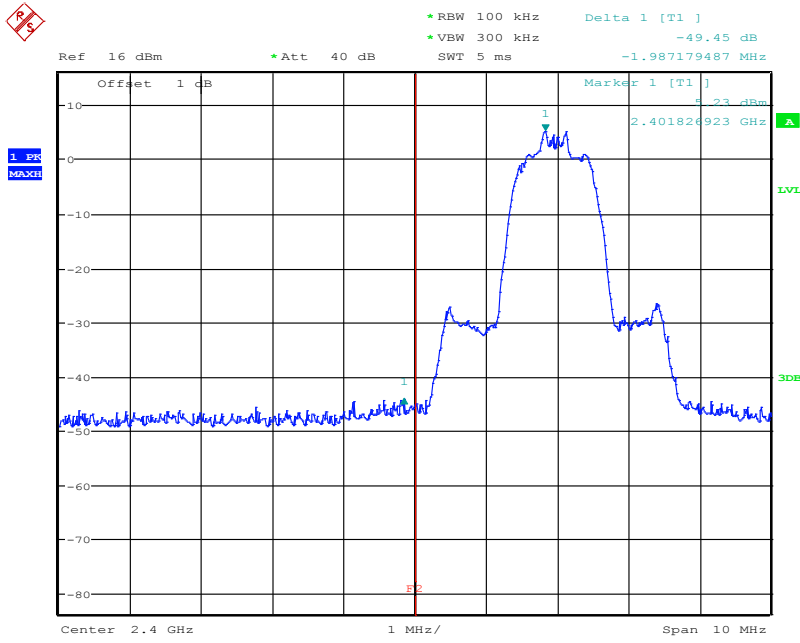

Date: 25.OCT.2016 14:17:42

Band Edge, CH High

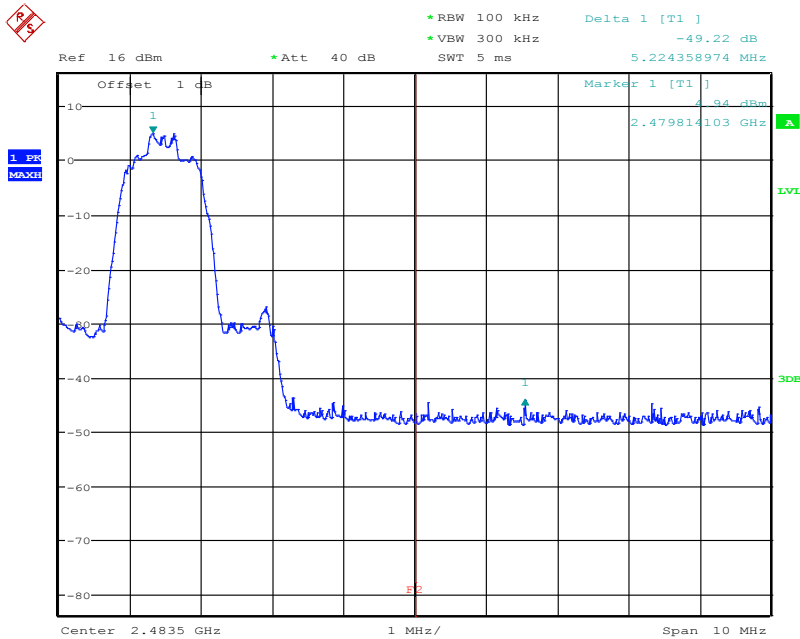

Date: 25.OCT.2016 14:20:59

EDR Hopping Mode (8-DPSK)

Band Edge, CH Low

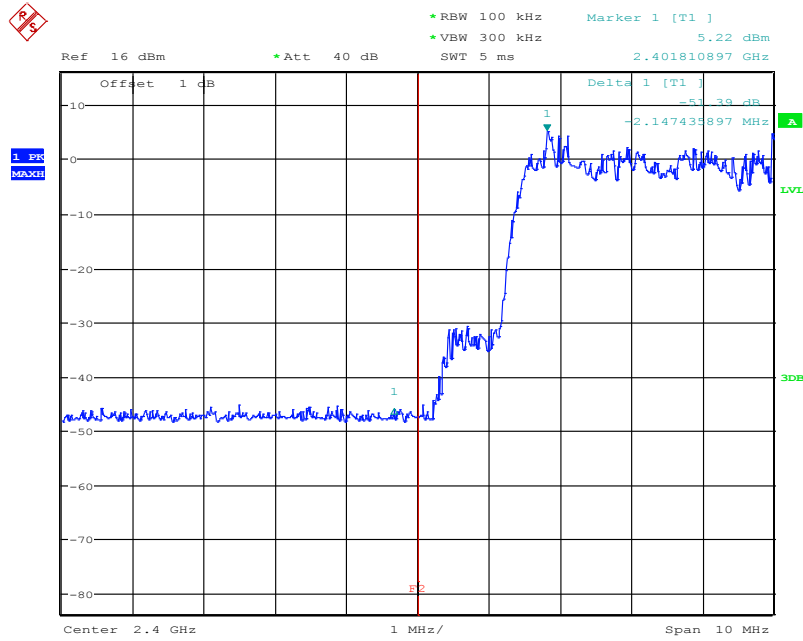

Date: 25.OCT.2016 14:18:50

Band Edge, CH High

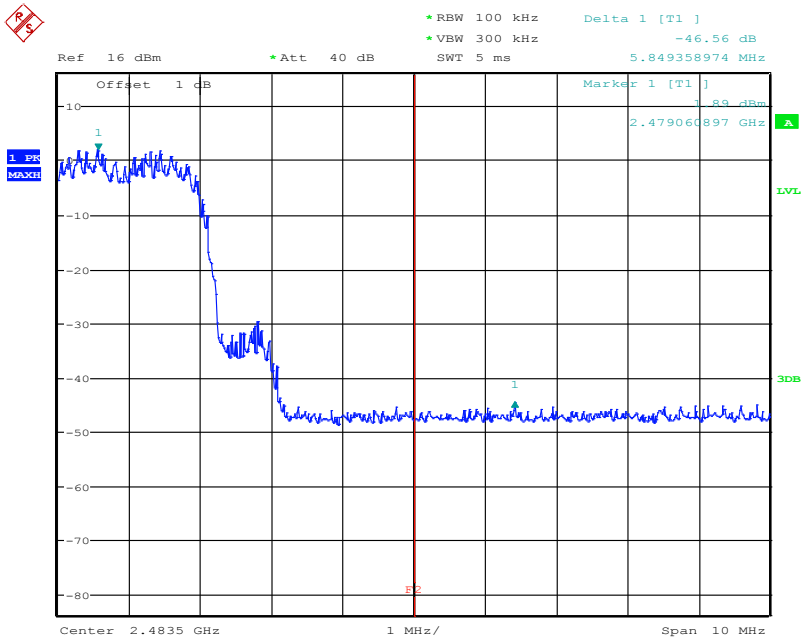

Date: 25.OCT.2016 14:20:11

----- END OF REPORT -----