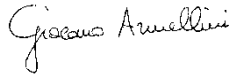
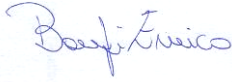

TEST REPORT

APPLICANT:	MUNDO READER, S.L. CALLE SOFIA, 10 P.I EUROPOLIS Las Rozas - Madrid, 28232 Spain	
APPLICANT REFEREE:	MR. IVAN GARCIA	
EUT DESCRIPTION	WIFI MODULE	
EUT MODEL	BQ410	
EUT FCC ID	2AKDW-BQ410	
EUT TRADEMARK	MUNDO READER	
MANUFACTURER	MUNDO READER, S.L.	
REFERENCE STANDARDS	47 CFR FCC part 15.247	
TEST REPORT NUMBER	FCCTR_170239-5	
TEST REPORT ISSUE DATE	30/07/2017	
TESTING LABORATORY	Prima Ricerca & Sviluppo S.r.l. Via Campagna, 92 -22020 Faloppio (Co) – Italy FCC test registration number: 421808	
TESTING LOCATION	As Above	
DATE OF TEST SAMPLE RECEIPT	February 2017	
DATE OF TEST	February 2017	
TESTED BY	Giacomo ARMELLINI Responsabile Laboratorio EMC e RADIO/ EMC and RADIO Laboratory Manager	
APPROVED BY	Enrico Banfi Laboratory Manager	

The test results reported in this test report shall refer only to the sample actually tested and shall not refer or be deemed to refer to bulk from which such a sample may be said to have been obtained.
Reproduction of this Test Report, should not be reproduced, except in full, without the written authorization of the Laboratory

0. CONTENTS

	Page
0. CONTENTS	2
1. RELEASE CONTROL RECORD	2
2. TECHNICAL INFORMATION OF EQUIPMENT UNDER TEST (EUT).....	3
2.1 IDENTIFICATION	3
2.2 TECHNICAL DATA.....	4
2.3 PORTS IDENTIFICATION.....	5
2.4 AUXILIARY EQUIPMENT.....	5
3. OPERATING TEST MODES AND CONDITIONS	6
4. REFERENCE STANDARD / DOCUMENT FOR PERFORMED TESTS	7
5. SUMMARY OF TEST RESULTS.....	7
6. TEST RESULTS	8
7. LIST OF EQUIPMENT USED.....	131

1. RELEASE CONTROL RECORD

TEST REPORT NUMBER	REASON OF CHANGE	DATE OF ISSUE
FCCTR_170239-0	Original release	27/03/2017
FCCTR_170239-1	Editorial Change	30/03/2017
FCCTR_170239-2	Editorial Change	30/07/2017
FCCTR_170239-3	Editorial Change	30/07/2017
FCCTR_170239-4	Editorial Change	30/07/2017
FCCTR_170239-5	Editorial Change	30/07/2017

2. TECHNICAL INFORMATION OF EQUIPMENT UNDER TEST (EUT)

2.1 Identification

Trademark:	MUNDO READER
Manufacturer:	MUNDO READER, S.L.
Type of Equipment :	WiFi Radio module
Model name:	BQ410
Serial number :	prototype
FCC ID :	2AKDW-BQ410
Country of manufacturer:	SPAIN



2.2 Technical data

Product type:	Radio Equipment
Radio type:	Intentional radiators
Product description / application	The EUT is 2.4GHz WiFi Transceiver
Power supply requirements :	3,7V (powered by demoboard connected to PC USB port)
Operating Frequency range	2400-2483,5MHz
Operating Frequency:	From 2412MHz to 2462MHz
Channel bandwidth	22MHz
Channel spacing	5MHz
Number of Channel	11 (from 1 to 11)
Type of modulation :	CCK, DQPSK, DBPSK for DSSS 64QAM, 16QAM, QPSK, BPSK for OFDM
Transfer Rate:	802.11b: up to 11Mbps 802.11a/g: up to 54Mbps 802.11n: up to 65Mbps
Antenna Type	Integral PCB Printed antenna
Power Control Setting	RF GAIN 21



2.3 Ports identification

This section contains descriptions of all signal ports and AC/DC power input/output ports, the length and the type of the cable provided by manufacturer needed for the tests. Moreover it is specified if the ports are ever or optionally connected.

Port		Description	Connection
1	Enclosure	Not present (electronic PCB board only)	Plug-in electronic board
2	AC Power Supply	Not present	---
3	DC power supply	3.7Vdc	Plug-in electronic board
4	Signal lines	Signal line	Plug-in electronic board
5	Telecomm. Lines	Not present	---
6	Antenna port	Not present	---

Note: During the tests all cables must be what provided the manufacturer or the same that used in the real employment of the EUT.

2.4 Auxiliary equipment

- Evaluation Board used during the session to power supply the EUT and for channel and mode setting

3. OPERATING TEST MODES AND CONDITIONS

In the following table there are the operating conditions adopted during tests identified by an indicator (#..) at which has been referred the item "Operating condition of the equipment under test"

<i>Operating condition</i>	<i>Description</i>
#1	<i>Continuous transmission, modulated carrier,</i>
#2	<i>Receiver mode</i>

Special Test Software: Special software and hardware by the Applicant to operate the EUT at each channel frequency continuously. For example, the transmitter will be operated at each of the lowest, middle and highest frequencies individually continuously during testing. (QRCT.exe)

Special Hardware Used: The RF Module has been tested by an evaluation board supplied by BQ (See Photographic documentation).

Transmitter Test Antenna: The EUT has been tested with the antenna fitted in a manner typical of normal intended use as integral antenna equipment as described with the test results.

4. REFERENCE STANDARD / DOCUMENT FOR PERFORMED TESTS

Cfr 47 part 15 subpart C par. 15.247	Radio Frequency Devices – Intentional Radiators Operation within the bands 902-928 MHz, 2400-2483.5 MHz, and 5725-5850 MHz
ANSI C63.10:2013	American National Standard for Testing Unlicensed Wireless Devices
558074 D01 DTS Meas Guidance v04	Guidance for performing Compliance measurements on Digital Transmission Systems (DTS) Operating under §15.247

5. SUMMARY OF TEST RESULTS

Port	Phenomena	Basic standard	Operating condition ¹	Result
Antenna port	Antenna requirement	FCC Part 15 §15.203, §15.204	---	Compliant
	Maximum Peak Output Power	FCC Part 15 §15.247 (b) (3)	#1 #2	Within the limit
	6 dB Bandwidth	FCC Part 15 §15.247 (a) (2)	#1 #2	Within the limit
	Power Spectral Density	FCC Part 15 §15.247 €	#1 #2	Within the limit
	Radiated Emissions in restricted frequency bands	FCC Part 15 § 15.247 (d)	#1 #2	Within the limit
	Radiated Emissions in non restricted frequency bands	FCC Part 15 § 15.247 (d)	#1 #2	Within the limit
AC Mains ²	AC Conducted Emissions	FCC Part 15 § 15.207	#1	Within the limit

¹ See chapter 3

² AC mains of AC/DC host device adapter
TRFCC_15.247



6. TEST RESULTS

ANTENNA REQUIREMENTS.....	9
MAXIMUM CONDUCTED OUTPUT POWER	10
6DB CHANNEL BANDWIDTH.....	13
POWER SPECTRAL DENSITY.....	16
RADIATED EMISSIONS RESTRICTED FREQUENCY BANDS	19
RADIATED EMISSIONS IN NON RESTRICTED FREQUENCY BANDS.....	77
AC CONDUCTED EMISSIONS	128

**TEST
1.**

ANTENNA REQUIREMENTS

**REFERENCE
DOCUMENT**

According to §15.203 / 15.204

An intentional radiator shall be designed to ensure that no antenna other than that furnished by the responsible party shall be used with the device. The use of a permanently attached antenna or of an antenna that uses a unique coupling to the intentional radiator shall be considered sufficient to comply with the provisions of this section. The manufacturer may design the unit so that a broken antenna can be replaced by the user, but the use of a standard antenna jack or electrical connector is prohibited. This requirement does not apply to carrier current devices or to devices operated under the provisions of Sec. 15.211, Sec. 15.213, Sec. 15.217, Sec. 15.219, or Sec. 15.221. Further, this requirement does not apply to intentional radiators that must be professionally installed, such as perimeter protection systems and some field disturbance sensors, or to other intentional radiators which, in accordance with Sec. 15.31(d), must be measured at the installation site. However, the installer shall be responsible for ensuring that the proper antenna is employed so that the limits in this part are not exceeded

Antenna requirement
The EUT has an integrated PCB Printed antenna
RESULT: COMPLIANT

**TEST
2.**

MAXIMUM CONDUCTED OUTPUT POWER

**REFERENCE
DOCUMENT**

According to §15.247(b) (3), For systems using digital modulation in the 902-928 MHz, 2400-2483.5 MHz, and 5725-5850 MHz bands: 1 Watt. As an alternative to a peak power measurement, compliance with the one Watt limit can be based on a measurement of the maximum conducted output power. Maximum Conducted Output Power is defined as the total transmit power delivered to all antennas and antenna elements averaged across all symbols in the signaling alphabet when the transmitter is operating at its maximum power control level. Power must be summed across all antennas and antenna elements. The average must not include any time intervals during which the transmitter is off or is transmitting at a reduced power level. If multiple modes of operation are possible (e.g., alternative modulation methods), the maximum conducted output power is the highest total transmit power occurring in any mode.

TEST SETUP	In according to ref std
TEST LOCATION	Semi Anechoic Chamber / Radio test Area
TEST METHOD	KDB 558074 D01 par. 9.2.3.1 Maximum conducted output power (Method AVGPM) KDB 558074 D01 sec 3 par. 2
TYPE OF MEASUREMENT	RADIATED
TEST EQUIPMENT	Emi Receiver / Spectrum Analyzer Rohde&Schwarz mod. ESU40 Horn Antenna EMCO-6961
TEST PERFORMED BY	Giacomo Armellini
TESTING DATE	February 2017

TEST CONDITIONS:	MEASURED
Ambient temperature : 23°C ± 5°C	24°C
Ambient humidity : 25 – 75 %rH	45%
Pressure : 85 – 106 kPa (860 mbar – 1060 mbar)	960mbar

OPERATING CONDITION	#1, DUTY CYCLE 100%
----------------------------	---------------------

TEST RESULT	WITHIN THE LIMITS
--------------------	--------------------------



MEASUREMENT PARAMETER	
Duty Cycle:	100%
Duty Cycle Correction Factor	0
Integration Period	10s
Detector:	Average

TEST DESCRIPTION

Measurement is made at a semi-anechoic chamber that incorporates a turntable allowing a EUT rotation of 360°. A continuously - rotating, remotely - controlled turntable is installed at the test site to support the EUT and facilitate determination of the direction of maximum radiation for each EUT emission frequency. The EUT is placed at test table.

For emissions testing at or below 1 GHz, the table height is 80 cm above the reference ground plane. For emission measurements above 1 GHz, the table height is 1.5 m

Measurement is made with the antenna positioned in both the horizontal and vertical planes of polarization. The measurement antenna is varied in height (1m~4m) above the reference ground plane to obtain the maximum signal strength. Distance between EUT and antenna is 3m.

This investigation is performed with the EUT rotated 360°, the antenna height scanned between 1 m and 4 m, and the antenna rotated to repeat the measurements for both the horizontal and vertical antenna polarizations.

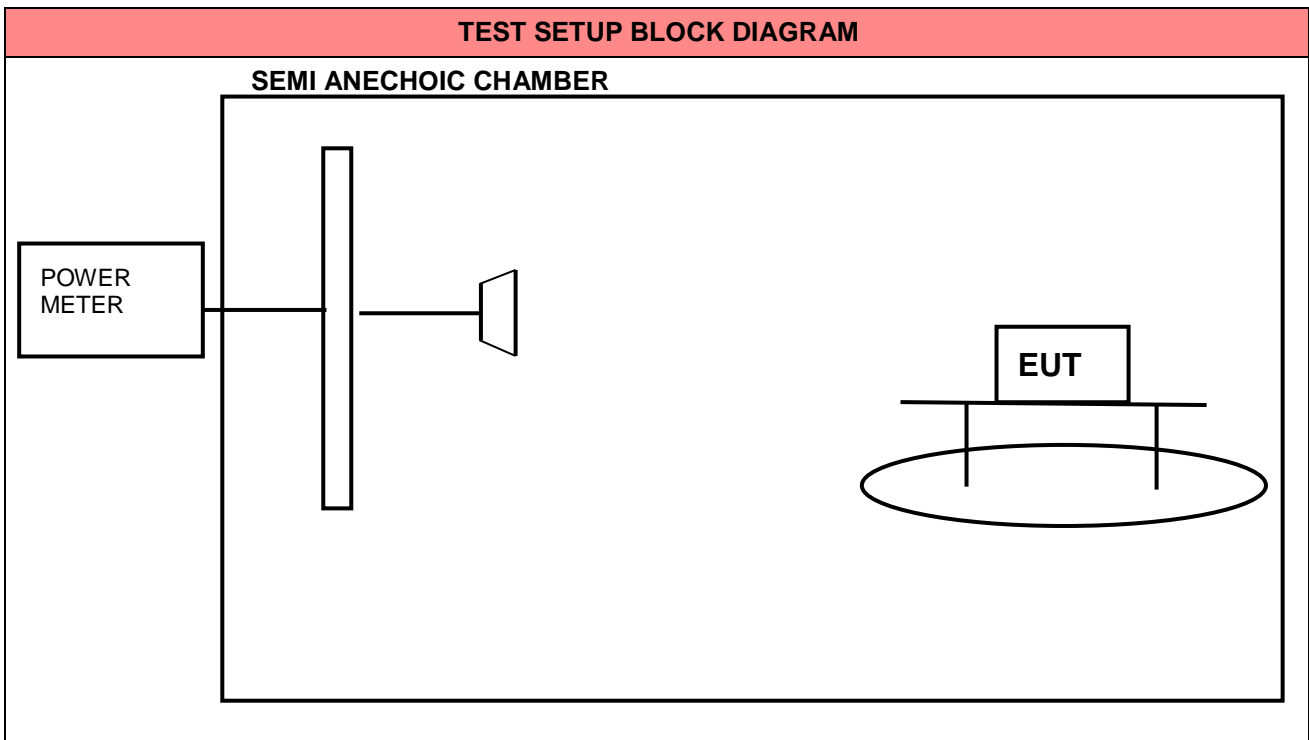



Mode	Channel	Frequency (MHz)	EIRP (dBm)	Antenna Gain (dBi)	Max Conducted Output power	Limit (dBm)	Result
b	1	2412	-1.34	3	-4.34	30	WITHIN THE LIMITS
	6	2437	2.61	3	-0.39		
	11	2462	2.79	3	-0.21		
g	1	2412	-2.46	3	-5.46		
	6	2437	-0.56	3	-3.56		
	11	2462	1.87	3	-1.13		
n	1	2412	-2.04	3	-5.04		
	6	2437	-3.78	3	-6.78		
	11	2462	1.43	3	-1.57		
Incertezza di misura / Measurement Uncertainty : ± 3 dB							

**TEST
3.**

6dB CHANNEL BANDWIDTH

REFERENCE DOCUMENT According to §15,247(a)(2), Systems using digital modulation techniques may operate in the 902-928 MHz, 2400-2483,5 MHz, and 5725-5850 MHz bands, The minimum 6 dB bandwidth shall be at least 500 kHz,

TEST SETUP	In according to ref std
TEST LOCATION	Radio test area
TEST METHOD	KDB 558074 D01 par. 8.2 DTS Bandwidth Option 2
TYPE OF MEASUREMENT	RADIATED
TEST EQUIPMENT	Spectrum Analyzer Rohde&Schwarz mod. FSP40 SYSTEM DC POWER SUPPLY HP mod. 6623A Horn Antenna EMCO-6961
TEST PERFORMED BY	Giacomo Armellini
TESTING DATE	February 2017

TEST CONDITIONS:	MEASURED
Ambient temperature : 23°C ± 5°C	24°C
Ambient humidity : 25 - 75 %rH	45%
Pressure : 85 - 106 kPa (860 mbar - 1060 mbar)	960mbar

OPERATING CONDITION	#1, DUTY CYCLE 100%
----------------------------	---------------------

TEST RESULT	WITHIN THE LIMITS
--------------------	--------------------------



MEASUREMENT PARAMETER	
Resolution bandwidth:	100kHz
Video bandwidth:	300kHz
Span:	10MHz
Sweep time	Auto couple
Detector:	Peak
Trace-Mode:	Max. hold

TEST DESCRIPTION

Allow the trace to stabilize.
Measure the maximum width of the emission that is constrained by the frequencies associated with the two outermost amplitude points (upper and lower frequencies) that are attenuated by 6 dB relative to the maximum level measured in the fundamental emission

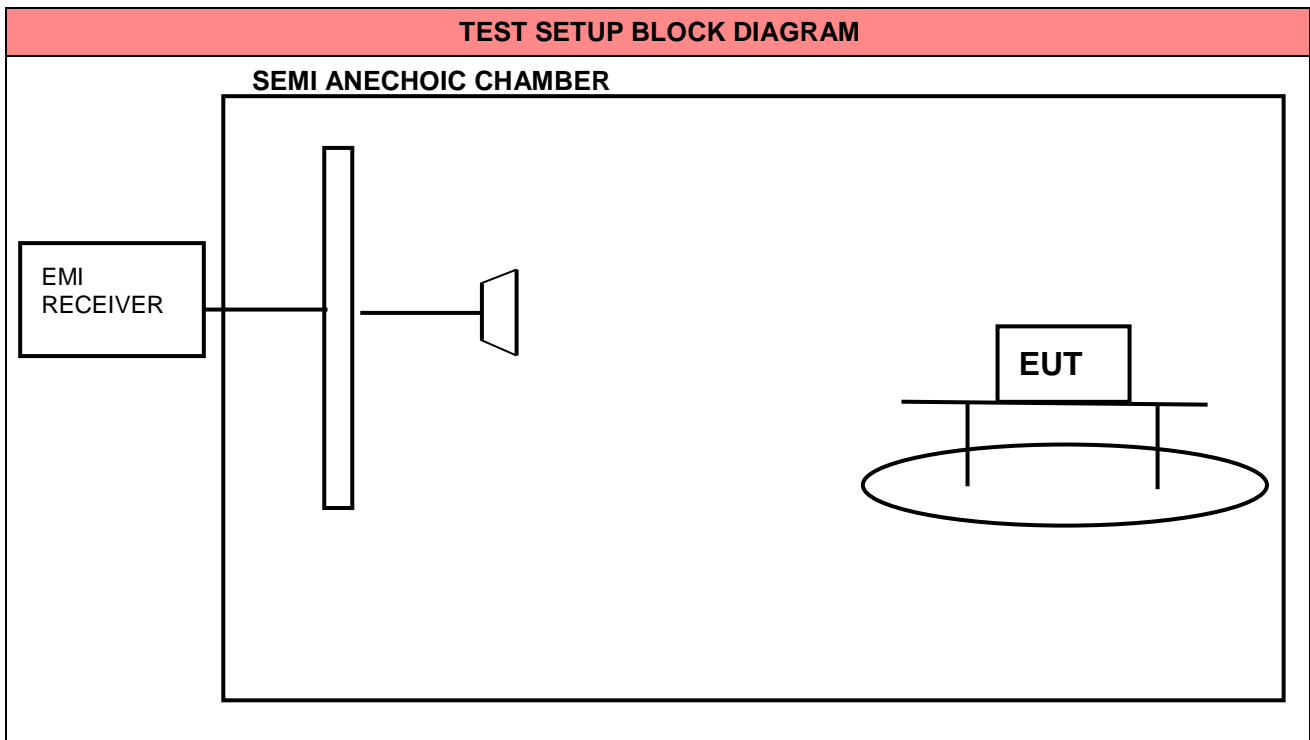



Measurement Result

Mode	Channel	Frequency (MHz)	6dB Channel Bandwidth (kHz)	Limit (kHz)	Result
b	1	2412	16350	>500	WITHIN THE LIMITS
	6	2437	16450		
	11	2462	16550		
g	1	2412	16550		
	6	2437	16550		
	11	2462	16550		
n	1	2412	16550		
	6	2437	16600		
	11	2462	16550		

Incertezza di misura / Measurement Uncertainty : ± 1 KHz

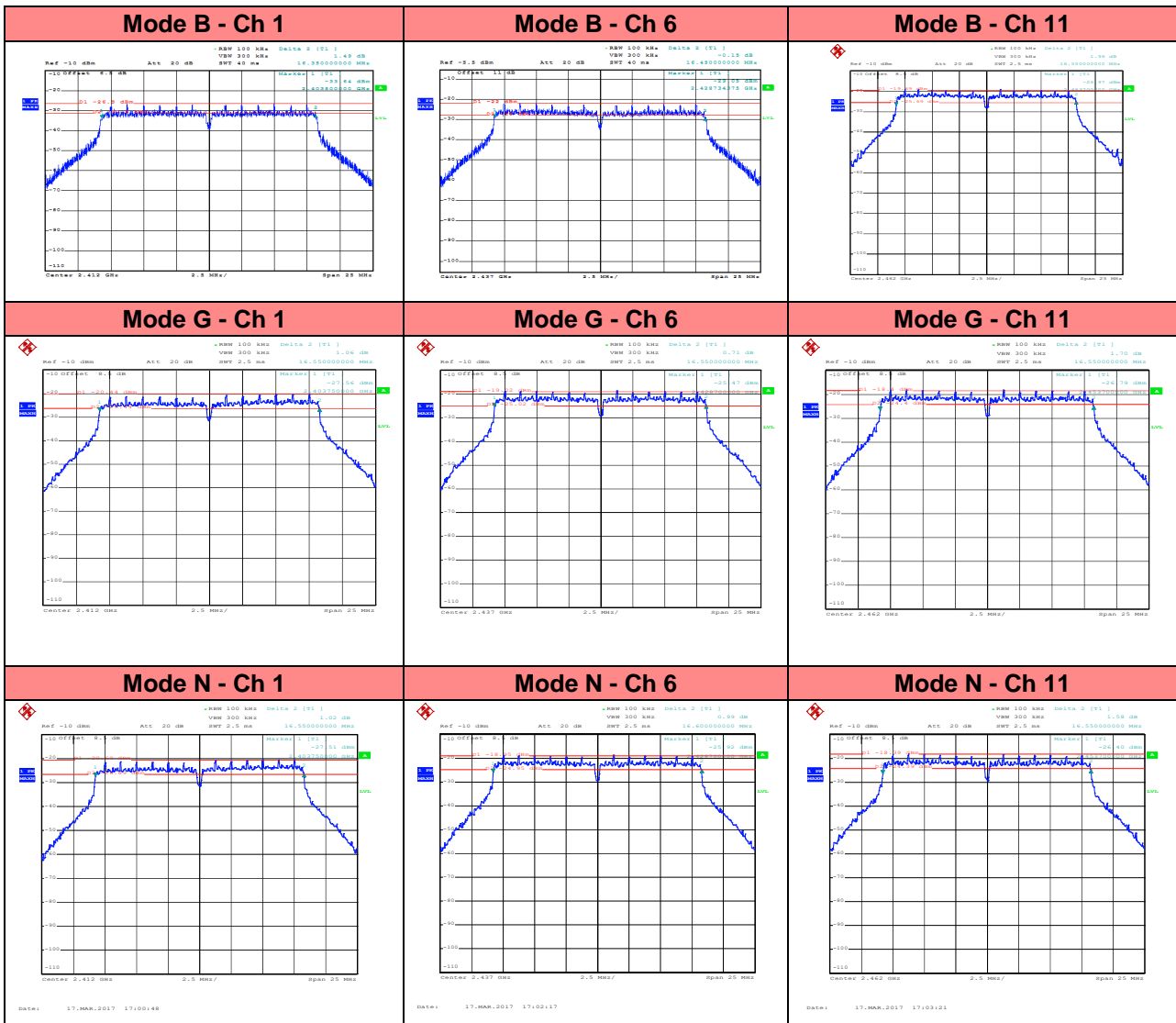

**TEST
4.**

POWER SPECTRAL DENSITY

**REFERENCE
DOCUMENT**

According to §15,247) (e) For digitally modulated systems, the power spectral density conducted from the intentional radiator to the antenna shall not be greater than 8 dBm in any 3 kHz band during any time interval of continuous transmission, This power spectral density shall be determined in accordance with the provisions of paragraph (b) of this section, The same method of determining the conducted output power shall be used to determine the power spectral density,

TEST SETUP	In according to ref std
TEST LOCATION	Radio test area
TYPE OF MEASUREMENT	RADIATED
	KDB 558074 D01 par. 10.2 Method PKPSD (peak PSD)
TEST EQUIPMENT	Spectrum Analyzer Rohde&Schwarz mod. FSP40 SYSTEM DC POWER SUPPLY HP mod. 6623A Horn Antenna EMCO-6961
TEST PERFORMED BY	Giacomo Armellini
TESTING DATE	February 2017

TEST CONDITIONS:	MEASURED
Ambient temperature : 23°C ± 5°C	24°C
Ambient humidity : 25 - 75 %rH	45%
Pressure : 85 - 106 kPa (860 mbar - 1060 mbar)	960mbar

OPERATING CONDITION	#1, DUTY CYCLE 100%
----------------------------	---------------------

TEST RESULT	WITHIN THE LIMITS
--------------------	--------------------------



MEASUREMENT PARAMETER	
Resolution bandwidth:	100kHz
Video bandwidth:	300kHz
Span:	1MHz
Sweep time	Auto couple
Detector:	Peak
Trace-Mode:	Max. hold

TEST DESCRIPTION

Allow trace to fully stabilize.
Use the peak marker function to determine the maximum amplitude level within the RBW.
If measured value exceeds limit, reduce RBW (no less than 3 kHz) and repeat

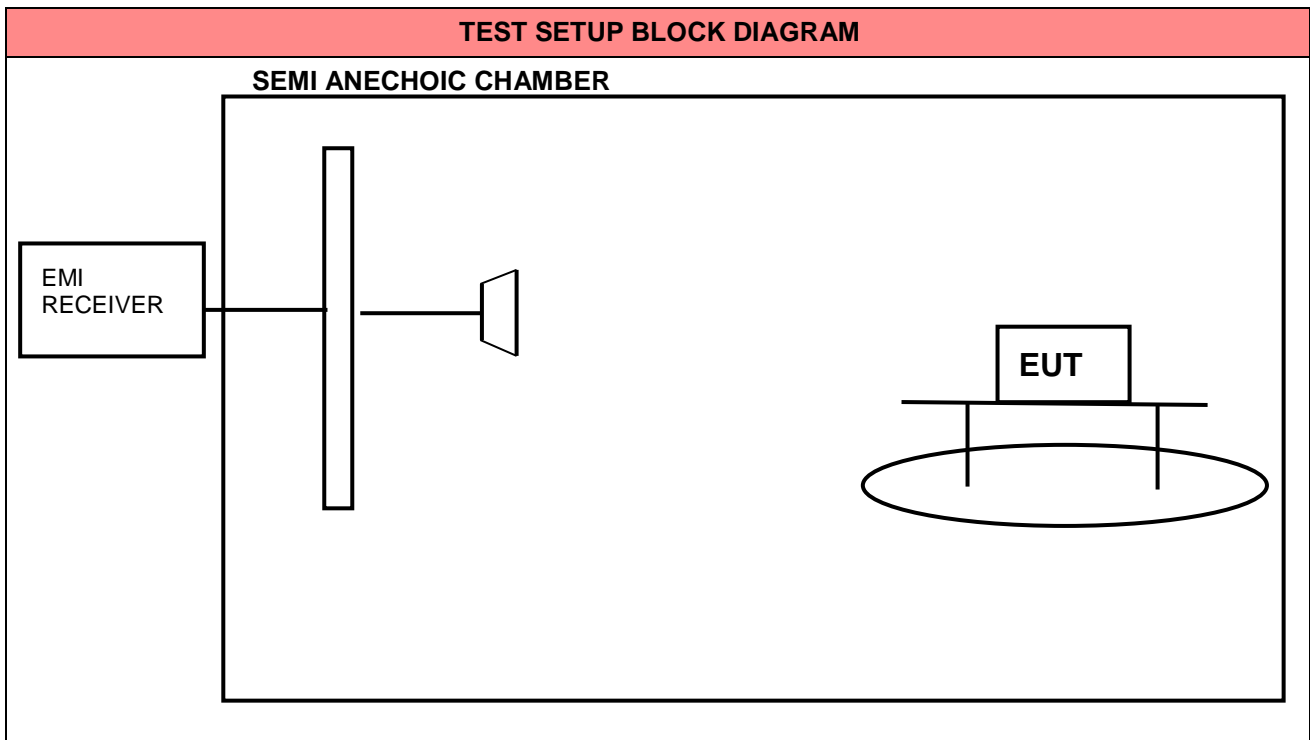



Measurement Result

Mode	Channel	Frequency (MHz)	PSD (dBm)	Limit (dBm)	Margin (dB)	Result
b	1	2412	-20.85	8	28.85	WITHIN THE LIMITS
	6	2437	-18.88		26.88	
	11	2462	-18.37		26.37	
g	1	2412	-21.37		29.37	
	6	2437	-19.08		27.08	
	11	2462	-18.30		26.30	
n	1	2412	-21.11		29.11	
	6	2437	-19.08		27.08	
	11	2462	-18.31		26.31	

Incertezza di misura / Measurement Uncertainty : ± 1 dB

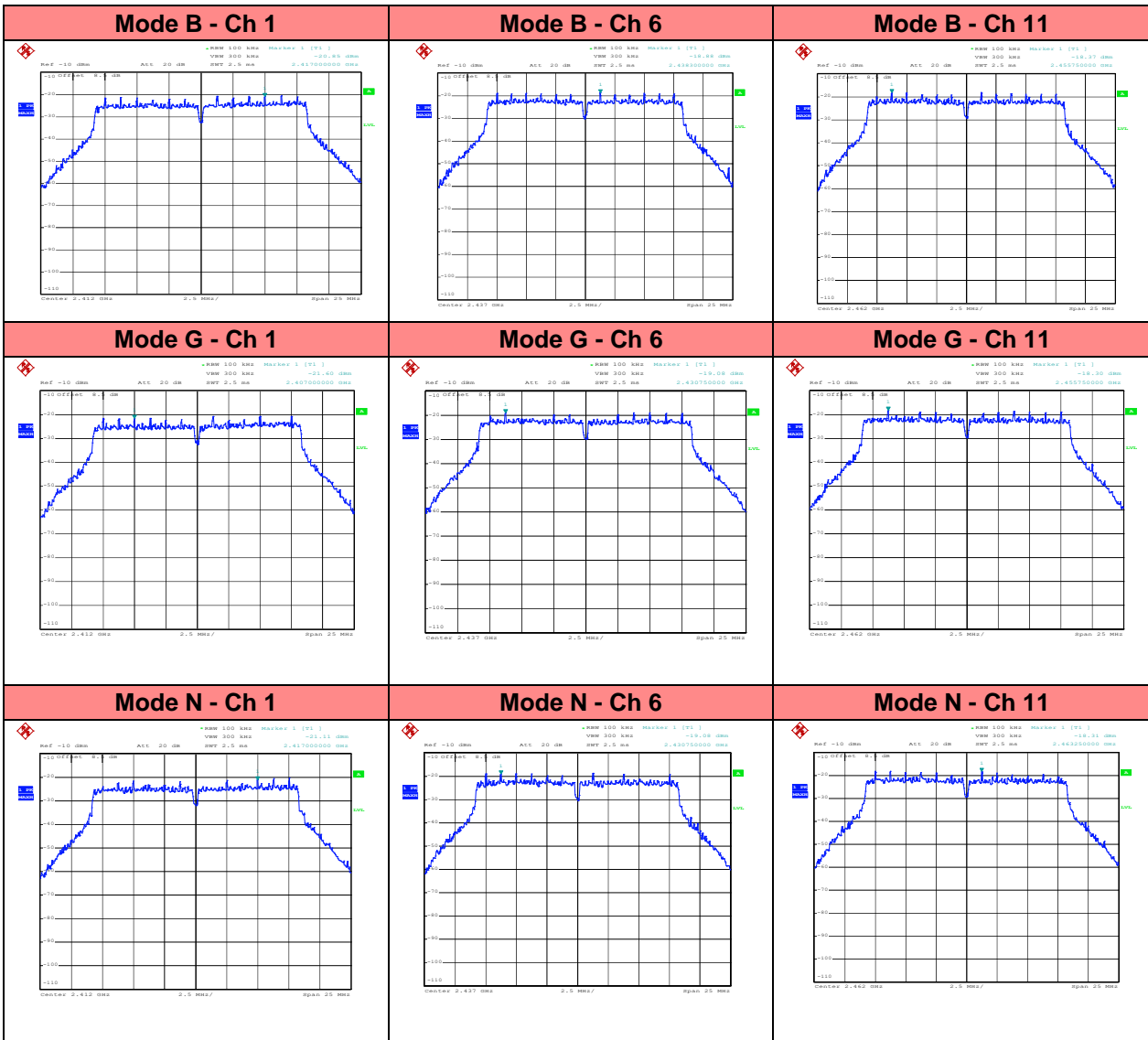

**TEST
5.**

RADIATED EMISSIONS RESTRICTED FREQUENCY BANDS

REFERENCE DOCUMENT

According to §15,247(d), In any 100 kHz bandwidth outside the frequency band in which the spread spectrum or digitally modulated intentional radiator is operating, the radio frequency power that is produced by the intentional radiator shall be at least 20 dB below that in the 100 kHz bandwidth within the band that contains the highest level of the desired power, based on either an RF conducted or a radiated measurement, provided the transmitter demonstrates compliance with the peak conducted power limits, If the transmitter complies with the conducted power limits based on the use of RMS averaging over a time interval, as permitted under paragraph (b)(3) of this section, the attenuation required under this paragraph shall be 30 dB instead of 20 dB, Attenuation below the general limits specified in Sec, 15,209(a) is not required, In addition, radiated emissions which fall in the restricted bands, as defined in Sec, 15,205(a), must also comply with the radiated emission limits specified in Sec, 15,209(a) (see Sec, 15,205(c)),

TEST SETUP	In according to ref std
TEST LOCATION	Semi Anechoic Chamber
TEST METHOD	KDB 558074 D01 par. 12
TYPE OF MEASUREMENT	RADIATED
TEST EQUIPMENT	EMI receiver Rohde & Schwarz Mod, ESU 40 Loop Antenna R&S HFH2-Z2 Bilog Antenna CBL6111C Horn Antenna EMCO-6961 Horn Antenna with preamplifier: Schwarbeck mod BBHA 9170 Tunable notch filter Wainwright mod, WRCT2200/2500-5/40-10SK High pass filter Wainwright WHNX 2,8/18G-10SS
TEST PERFORMED BY	Giacomo Armellini
TESTING DATE	February 2017
UNCERTAINTY OF MEASURE:	Combined uncertainty = $\pm 1,75$ dB Total uncertainty = (k=2) $\pm 3,5$ dB

TEST CONDITIONS:	MEASURED
Ambient temperature : 23°C \pm 5°C	24°C
Ambient humidity : 25 - 75 %rH	45%
Pressure : 85 - 106 kPa (860 mbar - 1060 mbar)	960mbar

OPERATING CONDITION	#1, DUTY CYCLE 100%
----------------------------	---------------------

TEST RESULT	WITHIN THE LIMITS
--------------------	--------------------------

MEASUREMENT PARAMETER	
Detector:	Peak / Quasi Peak / Average
Resolution bandwidth:	300Hz (f<150kHz) 10kHz (150kHz< f< 30MHz) 100kHz (30MHz< f <1GHz) 1MHz (f>1GHz)
Video bandwidth:	1kHz (f<150kHz) 30kHz (150kHz< f< 30MHz) 300kHz (30MHz< f <1GHz) 3MHz (f>1GHz)
Span:	see plots
Trace-Mode:	Max. hold

TEST DESCRIPTION
<p>Measurement is made at a semi-anechoic chamber that incorporates a turntable allowing a EUT rotation of 360°. A continuously - rotating, remotely - controlled turntable is installed at the test site to support the EUT and facilitate determination of the direction of maximum radiation for each EUT emission frequency. The EUT is placed at test table.</p> <p>For emissions testing at or below 1 GHz, the table height is 80 cm above the reference ground plane. For emission measurements above 1 GHz, the table height is 1.5 m</p> <p>Measurement is made with the antenna positioned in both the horizontal and vertical planes of polarization. The measurement antenna is varied in height (1m~4m) above the reference ground plane to obtain the maximum signal strength. Distance between EUT and antenna is 3m.</p> <p>This investigation is performed with the EUT rotated 360°, the antenna height scanned between 1 m and 4 m, and the antenna rotated to repeat the measurements for both the horizontal and vertical antenna polarizations.</p>

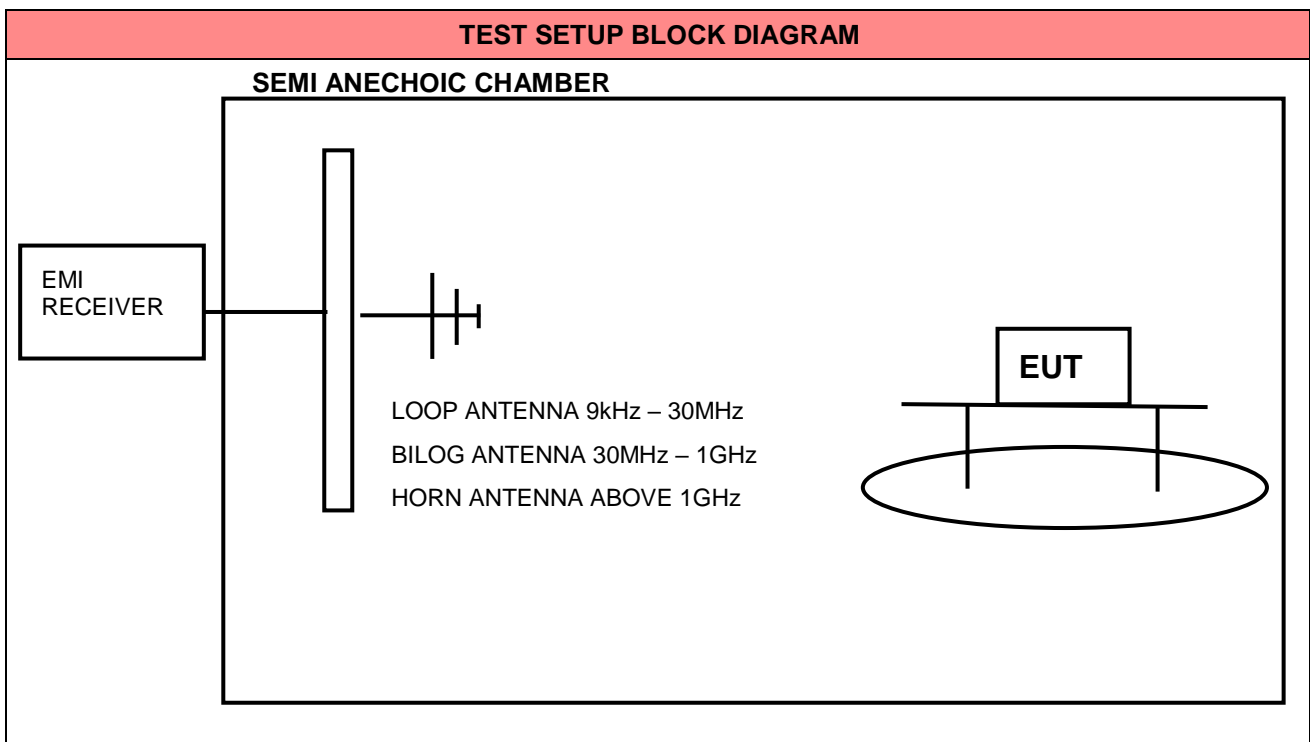



MODE	B
CHANNEL	1
FREQUENCY RANGE	9kHz - 30MHz
POLARIZATION	VERTICAL

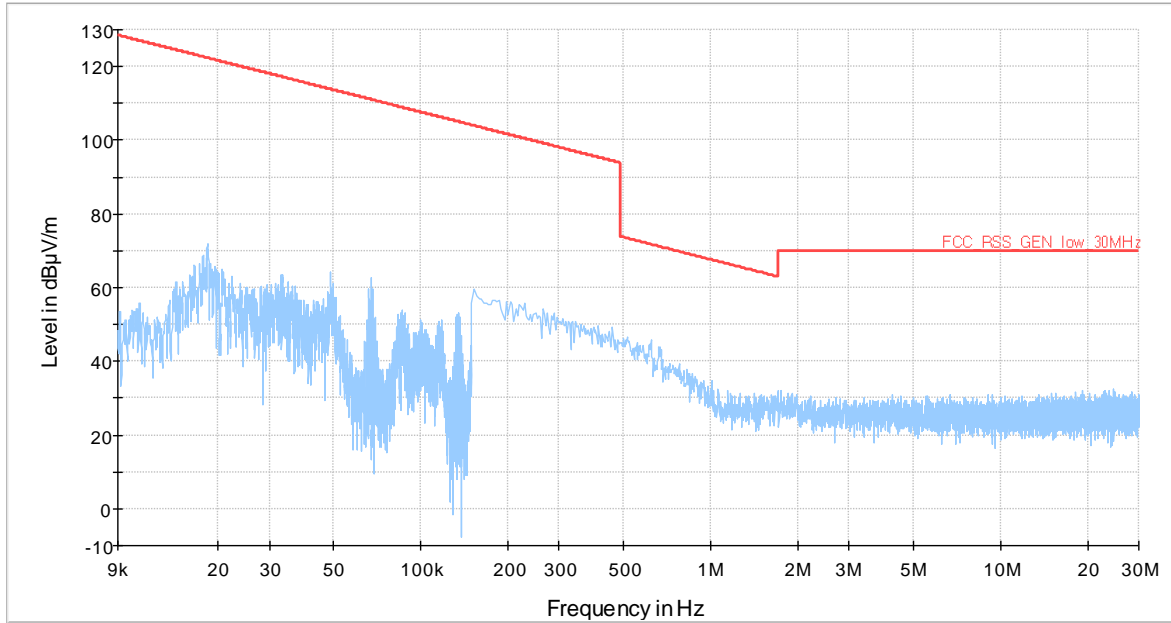



MODE	B
CHANNEL	1
FREQUENCY RANGE	30MHz – 1GHz
POLARIZATION	VERTICAL

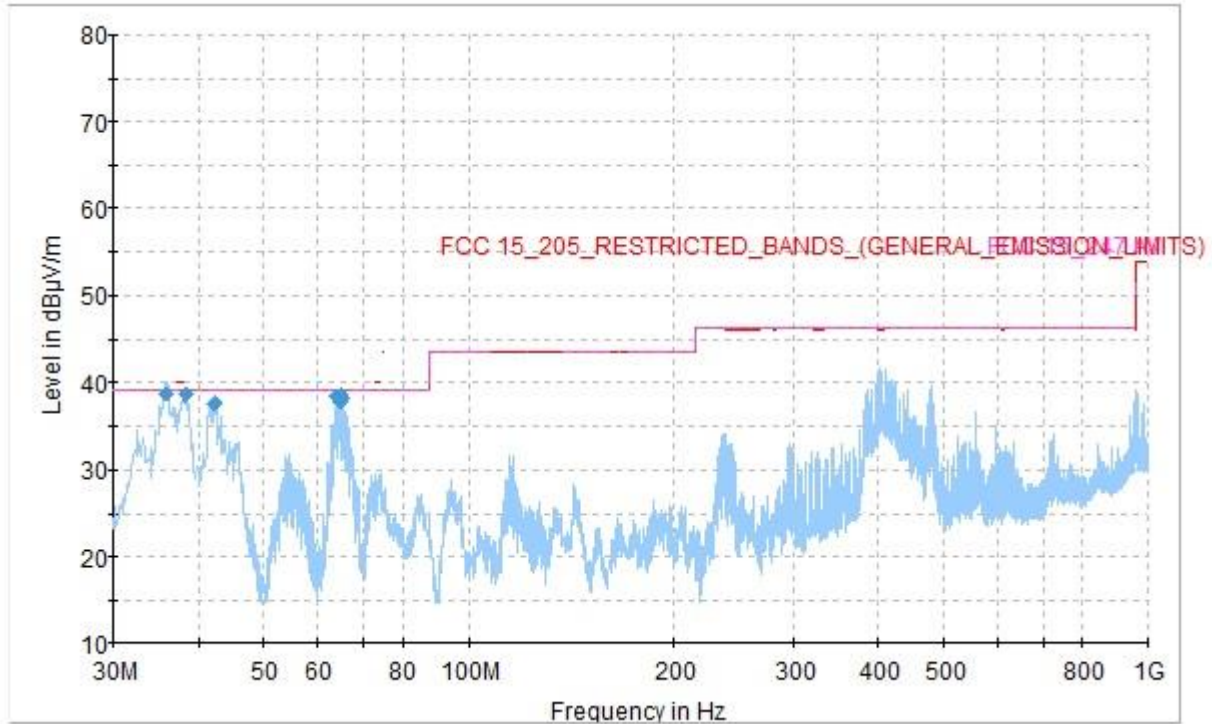

Blue trace Peak detector, Blue Marker Quasi-Peak detector

Final Result

Frequency (MHz)	QuasiPeak (dBµV/m)	Limit (dBµV/m)	Margin (dB)	Height (cm)	Pol	Azimuth (deg)
35.917000	38.72	39.00	0.28	102.0	V	-10.0
38.342000	38.63	39.00	0.37	102.0	V	45.0
42.319000	37.60	39.00	1.40	104.0	V	51.0
64.047000	38.39	39.00	0.61	112.0	V	-4.0
64.726000	37.81	39.00	1.19	123.0	V	135.0
65.114000	38.51	39.00	0.49	132.0	V	135.0
65.502000	38.22	39.00	0.78	140.0	V	159.0



MODE	B
CHANNEL	1
FREQUENCY RANGE	1-2.8GHz
POLARIZATION	VERTICAL

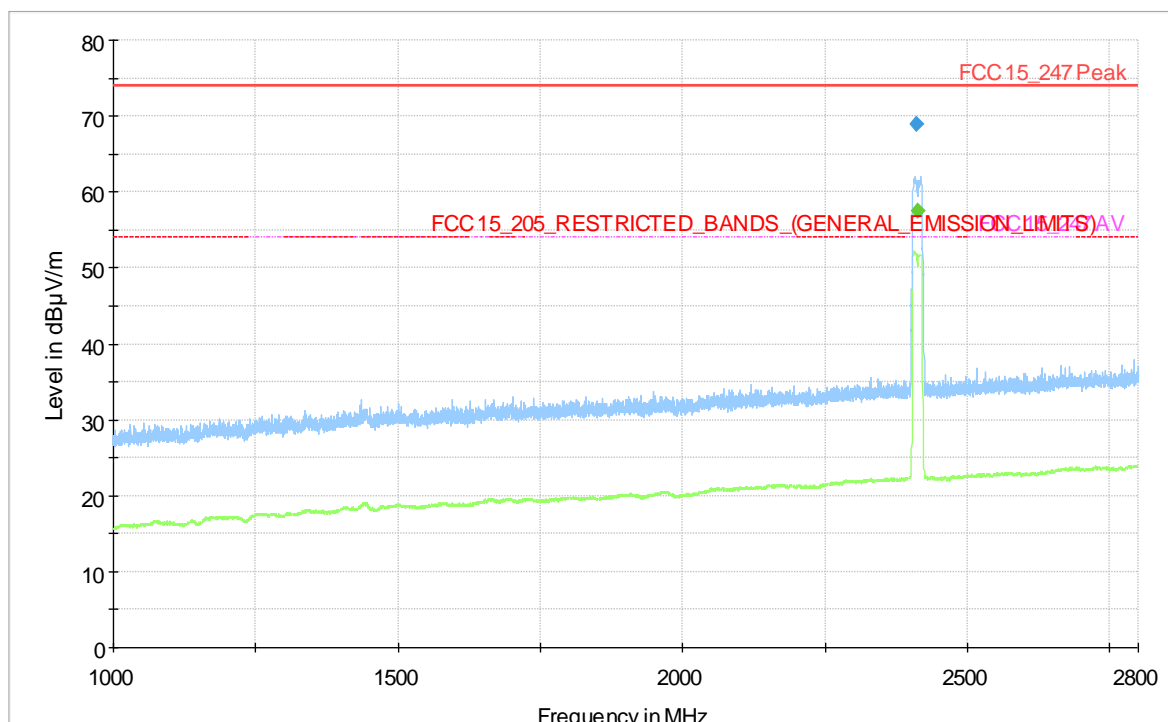

Blue trace Peak detector, Blue Marker Quasi-Peak detector; Green trace average detector, Green Marker average detector

Average Final Result

Frequency (MHz)	Average (dBµV/m)	Limit (dBµV/m)	Margin (dB)	Height (cm)	Pol	Azimuth (deg)	Note
2411.920000	57.54	54.00	-3.54	186.0	V	92.0	Carrier



MODE	B
CHANNEL	1
FREQUENCY RANGE	2.8-18GHz
POLARIZATION	VERTICAL

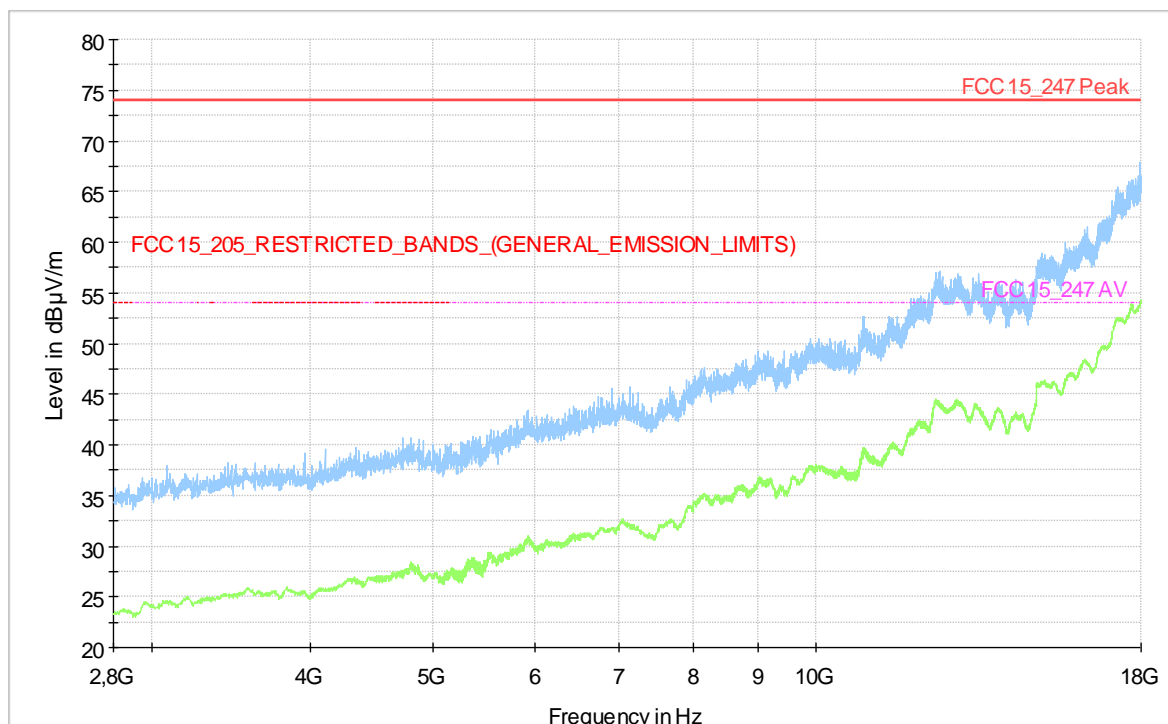

Blue trace Peak detector, Green trace average detector



MODE	B
CHANNEL	1
FREQUENCY RANGE	18-26GHz
POLARIZATION	VERTICAL

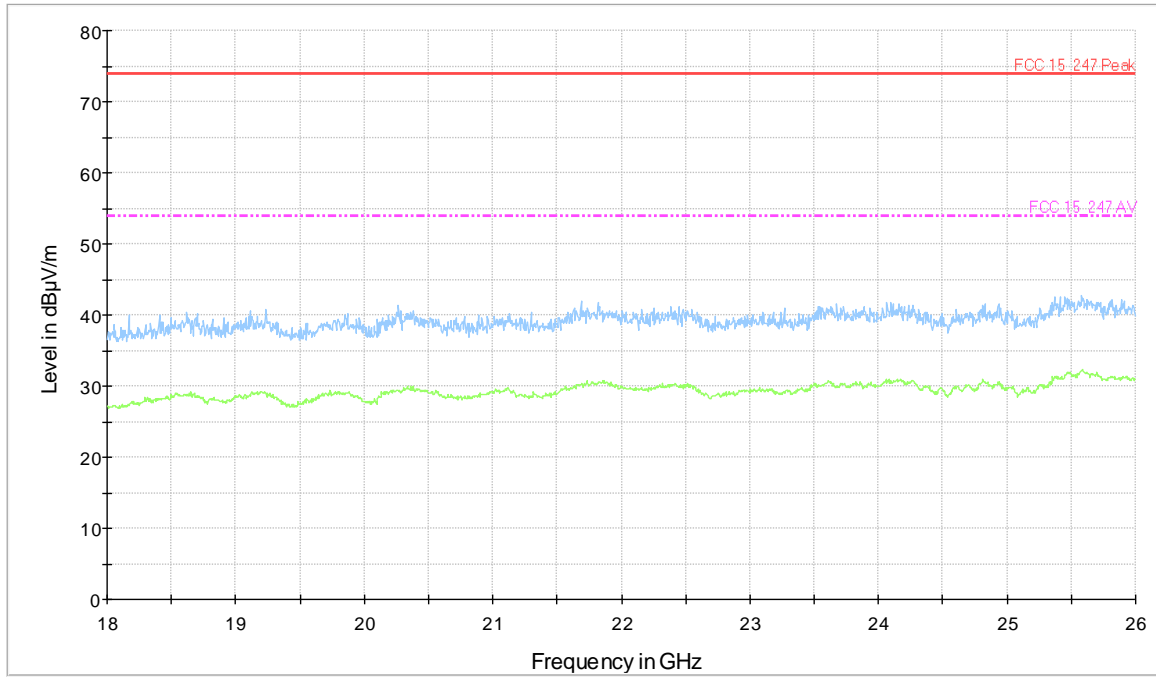



MODE	B
CHANNEL	1
FREQUENCY RANGE	30MHz – 1GHz
POLARIZATION	HORIZONTAL

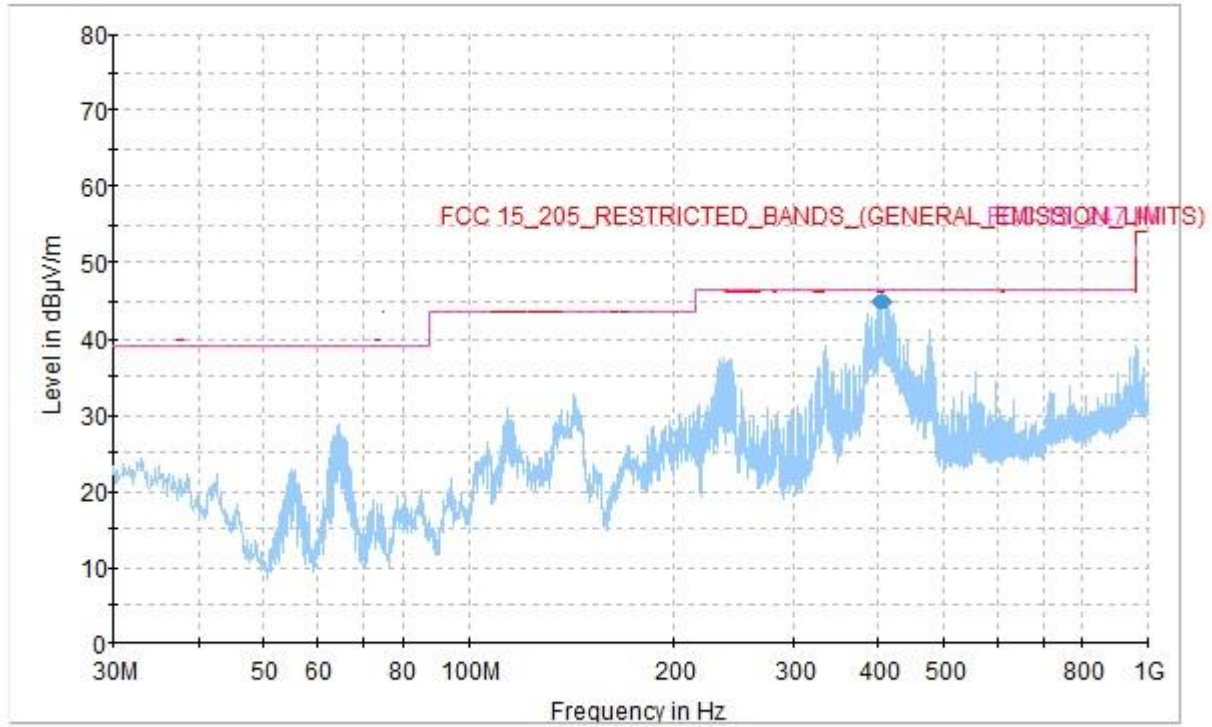

Blue trace Peak detector, Blue Marker Quasi-Peak detector

Final Result

Frequency (MHz)	MaxPeak (dBµV/m)	Limit (dBµV/m)	Margin (dB)	Height (cm)	Pol	Azimuth (deg)
403.159000	44.81	46.40	1.59	106.0	H	118.0
406.360000	45.03	46.40	1.37	100.0	H	105.0
409.561000	44.82	46.40	1.58	100.0	H	105.0



MODE	B
CHANNEL	1
FREQUENCY RANGE	1-2.8GHz
POLARIZATION	HORIZONTAL

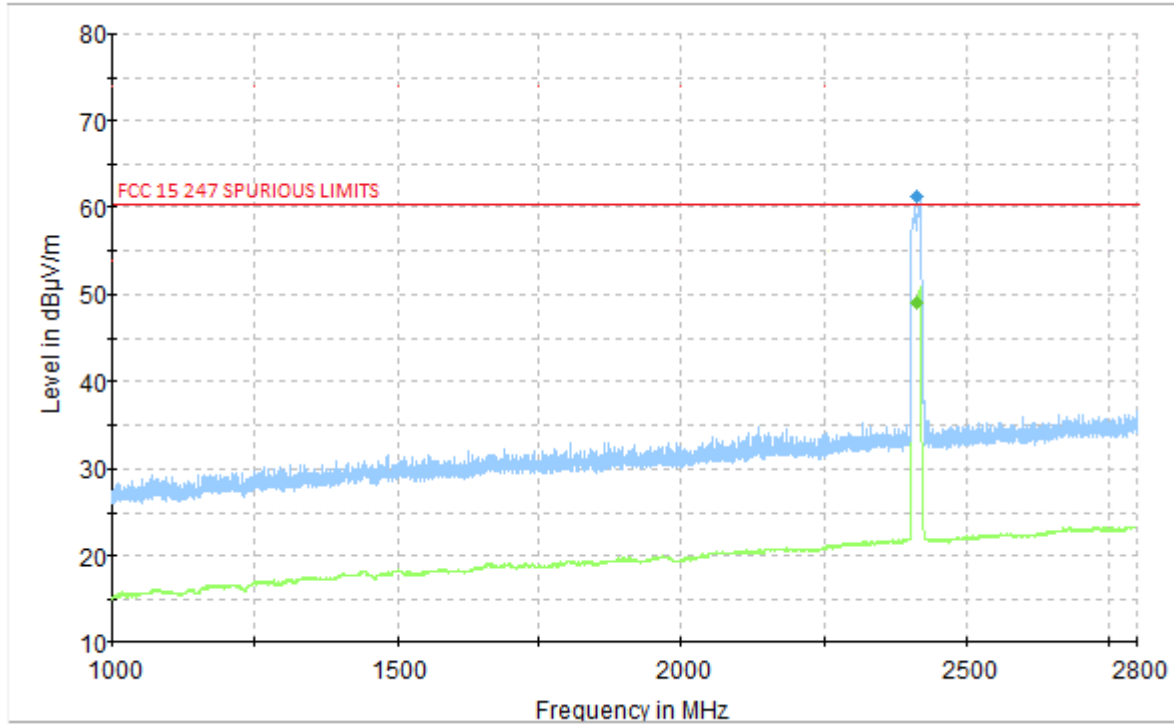

Blue trace Peak detector, Blue Marker Quasi-Peak detector; Green trace average detector, Green Marker average detector

Average Final Result

Frequency (MHz)	Average (dBµV/m)	Limit (dBµV/m)	Margin (dB)	Height (cm)	Pol	Azimuth (deg)
2411.92000	48.99	60.89	11.9	100.0	H	37.0



MODE	B
CHANNEL	1
FREQUENCY RANGE	2.8-18GHz
POLARIZATION	HORIZONTAL

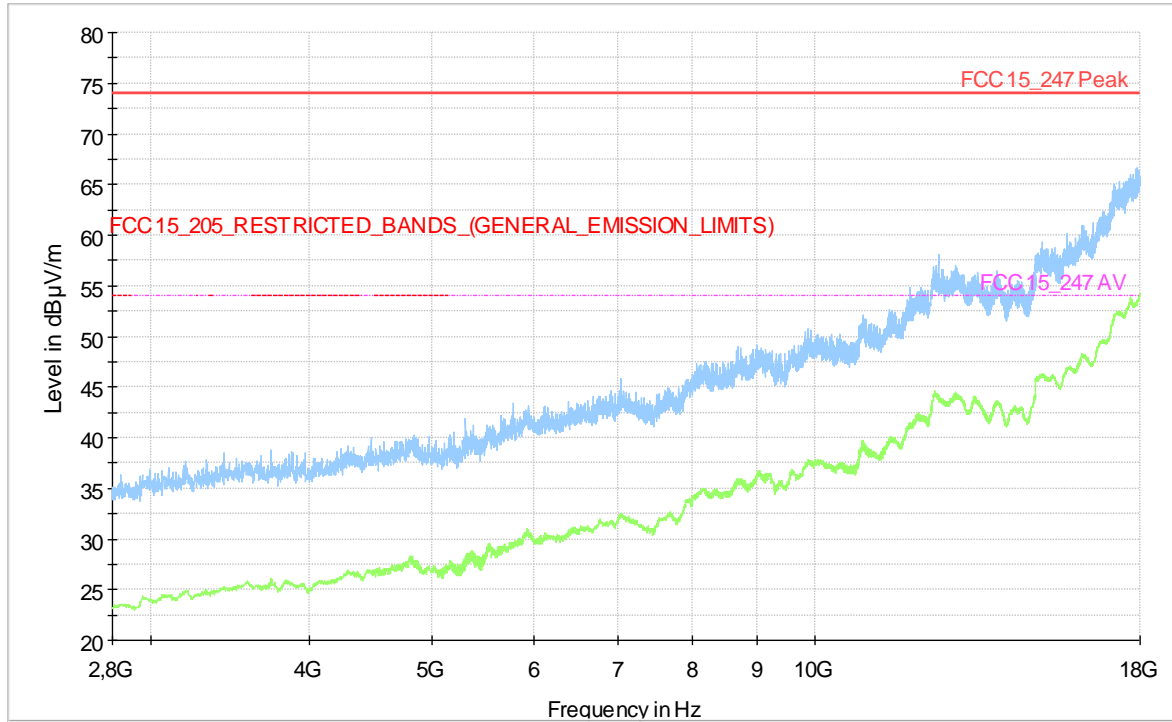

Blue trace Peak detector, Green trace average detector



MODE	B
CHANNEL	1
FREQUENCY RANGE	18-26GHz
POLARIZATION	HORIZONTAL

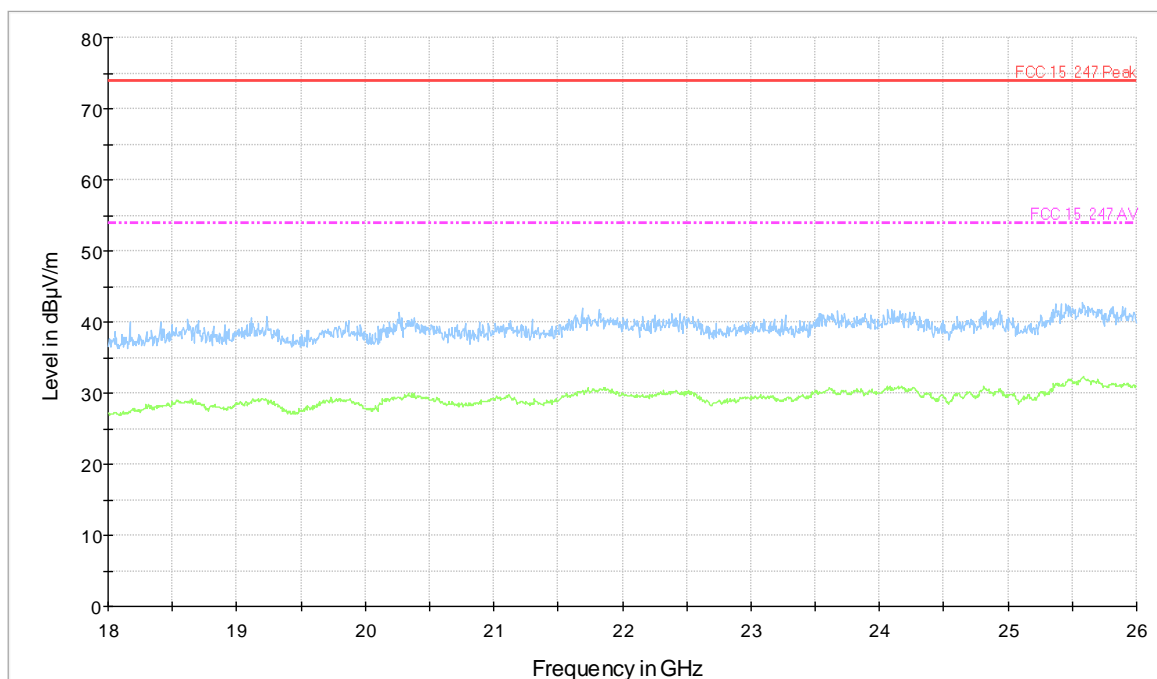



MODE	B
CHANNEL	11
FREQUENCY RANGE	9kHz - 30MHz
POLARIZATION	VERTICAL

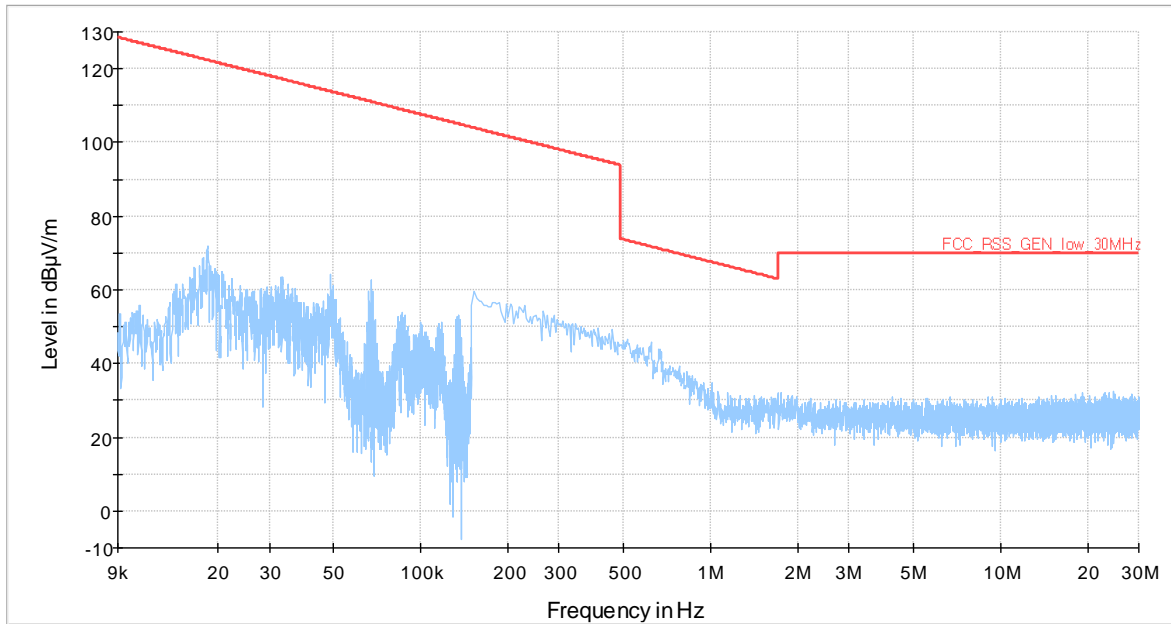



MODE	B
CHANNEL	11
FREQUENCY RANGE	30MHz – 1GHz
POLARIZATION	VERTICAL

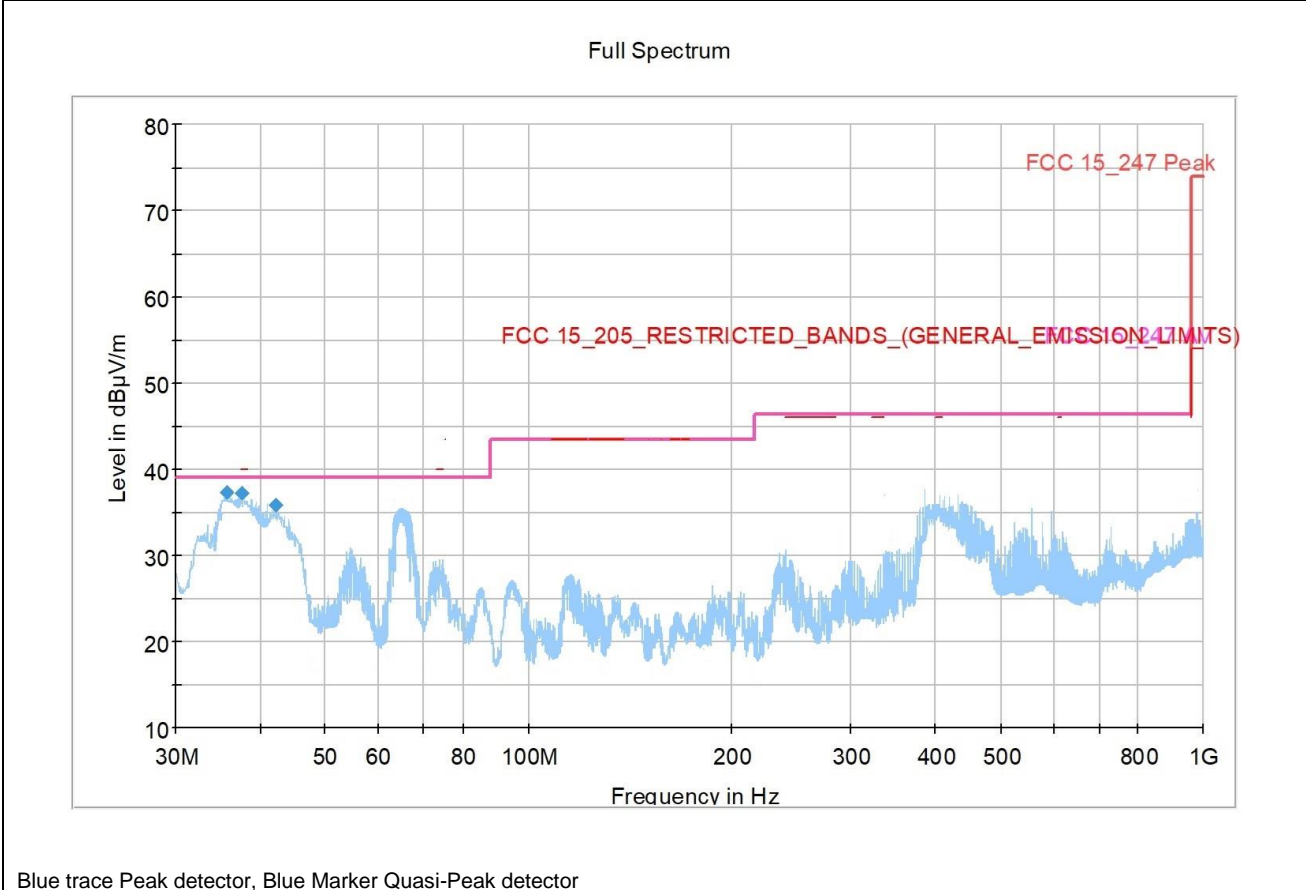

Final Result

Frequency (MHz)	QuasiPeak (dBµV/m)	Limit (dBµV/m)	Margin (dB)	Height (cm)	Pol	Azimuth (deg)
35.917000	38.11	39.00	0.89	102.0	V	-12.0
38.342000	38.05	39.00	0.95	102.0	V	42.0
42.319000	36.53	39.00	2.47	102.0	V	49.0



MODE	B
CHANNEL	11
FREQUENCY RANGE	1-2.8GHz
POLARIZATION	VERTICAL

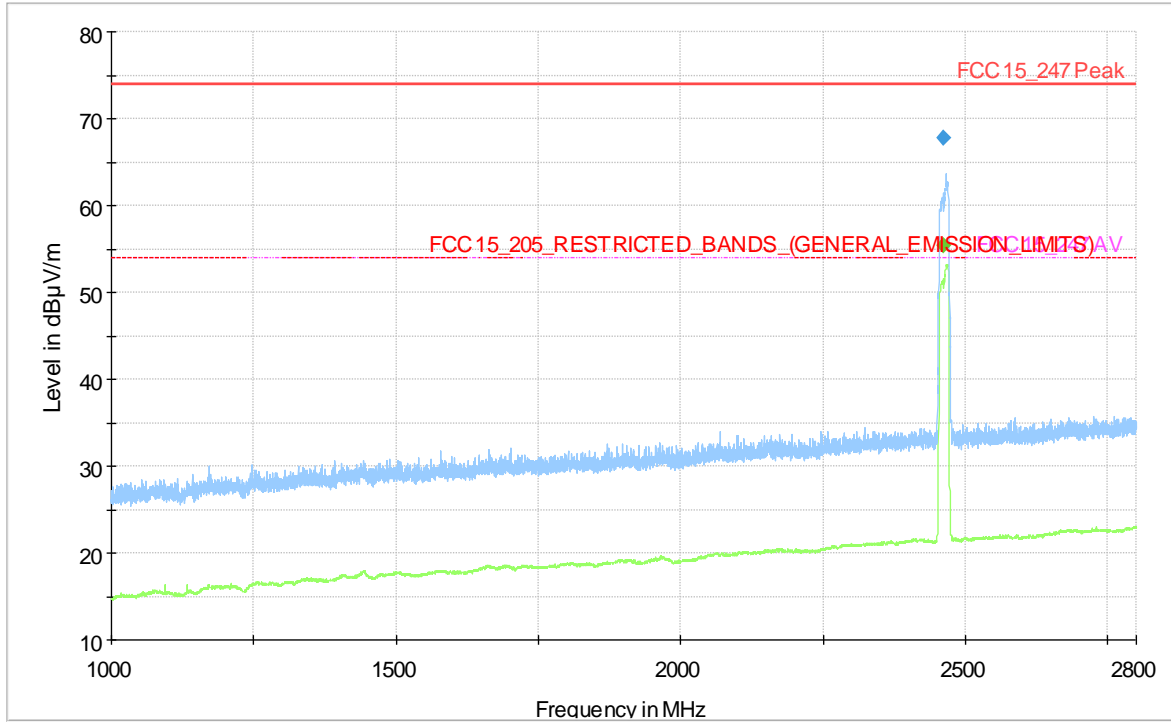

Blue trace Peak detector, Blue Marker Quasi-Peak detector; Green trace average detector, Green Marker average detector

Average Final Result

Frequency (MHz)	Average (dBµV/m)	Limit (dBµV/m)	Margin (dB)	Height (cm)	Pol	Azimuth (deg)
2461.960000	55.43	54.00	-1.43	180.0	V	80.0



MODE	B
CHANNEL	11
FREQUENCY RANGE	2.8-18GHz
POLARIZATION	VERTICAL

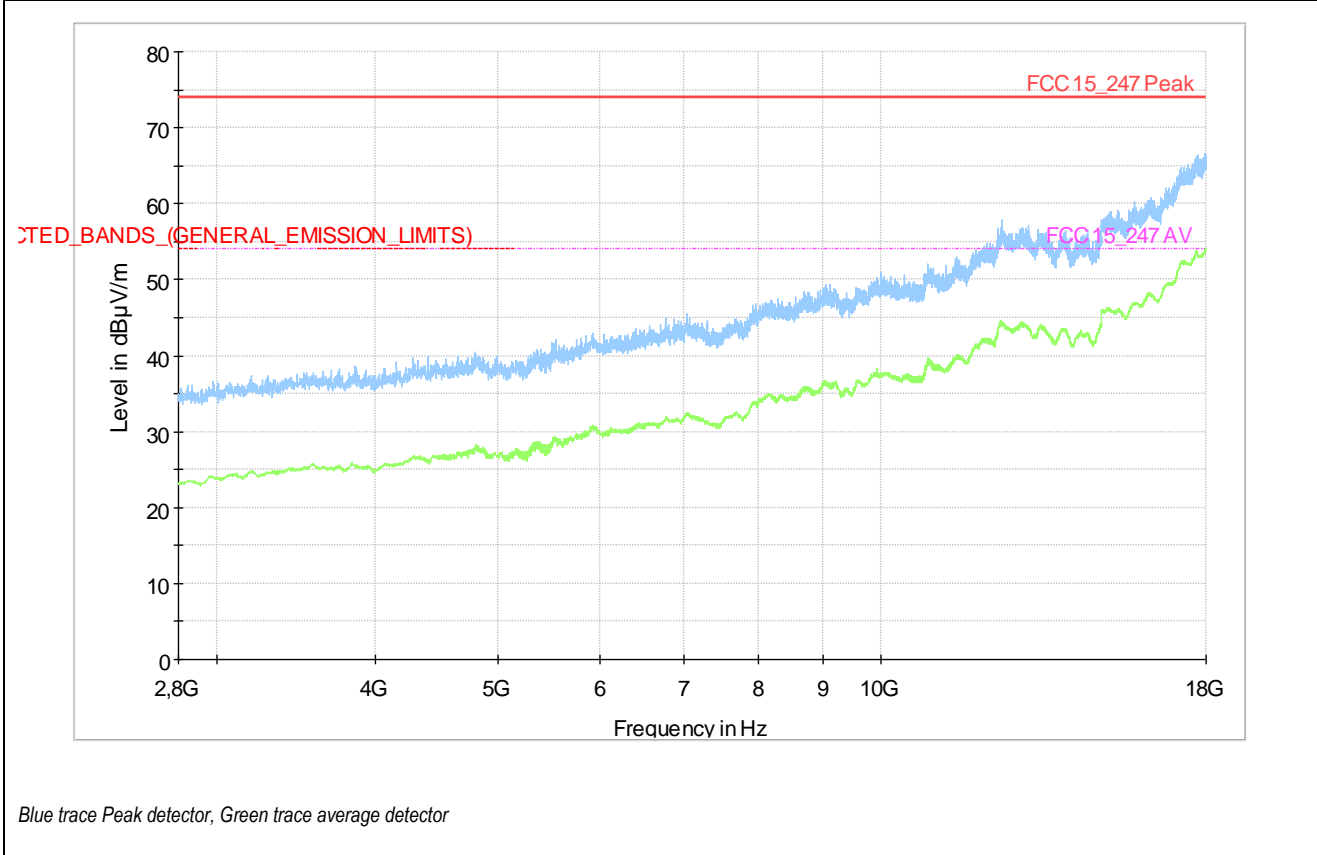



MODE	B
CHANNEL	11
FREQUENCY RANGE	18-26GHz
POLARIZATION	VERTICAL

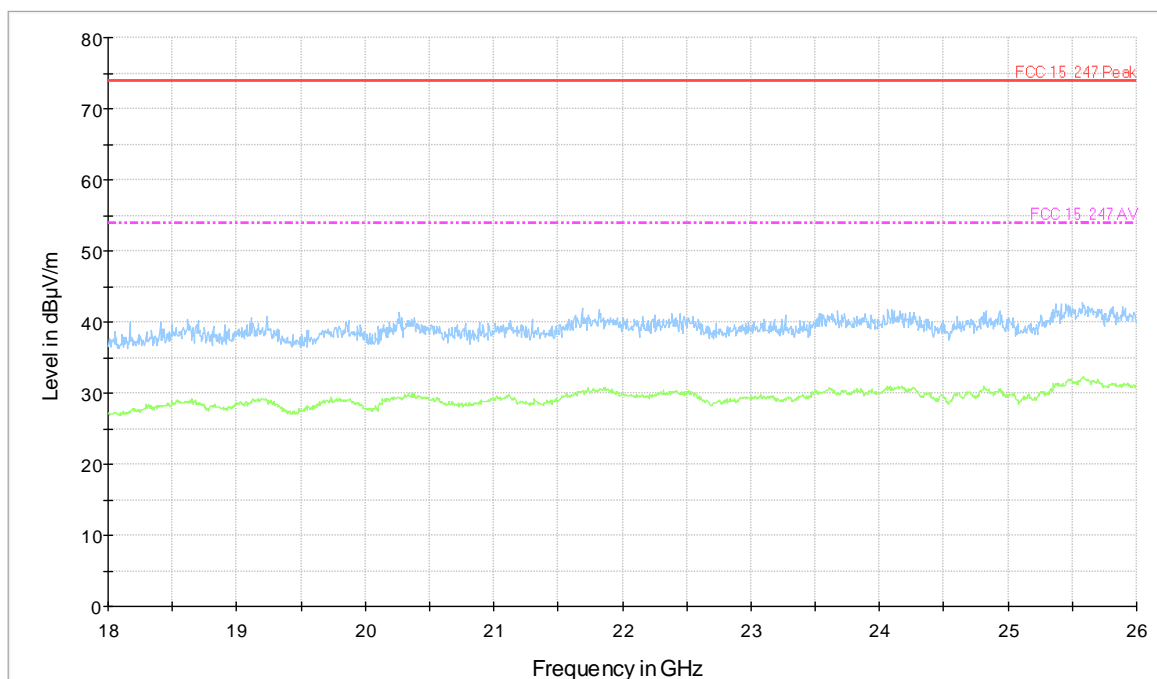



MODE	B
CHANNEL	11
FREQUENCY RANGE	30MHz – 1GHz
POLARIZATION	HORIZONTAL

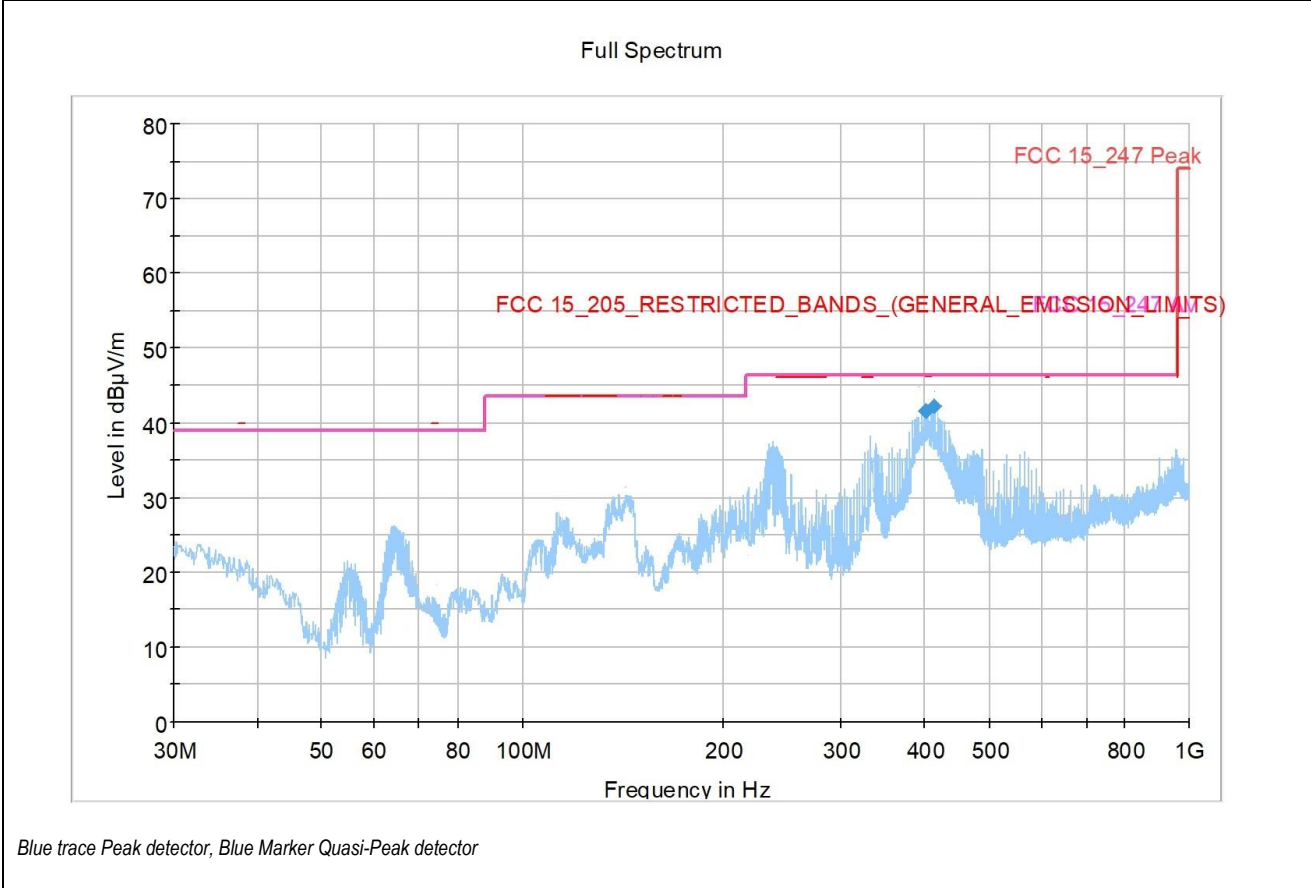

Final Result

Frequency (MHz)	MaxPeak (dBµV/m)	Limit (dBµV/m)	Margin (dB)	Height (cm)	Pol	Azimuth (deg)
403.159000	42.75	46.40	3.65	104.0	H	120.0
406.360000	44.22	46.40	2.18	103.0	H	108.0



MODE	B
CHANNEL	11
FREQUENCY RANGE	1-2.8GHz
POLARIZATION	HORIZONTAL

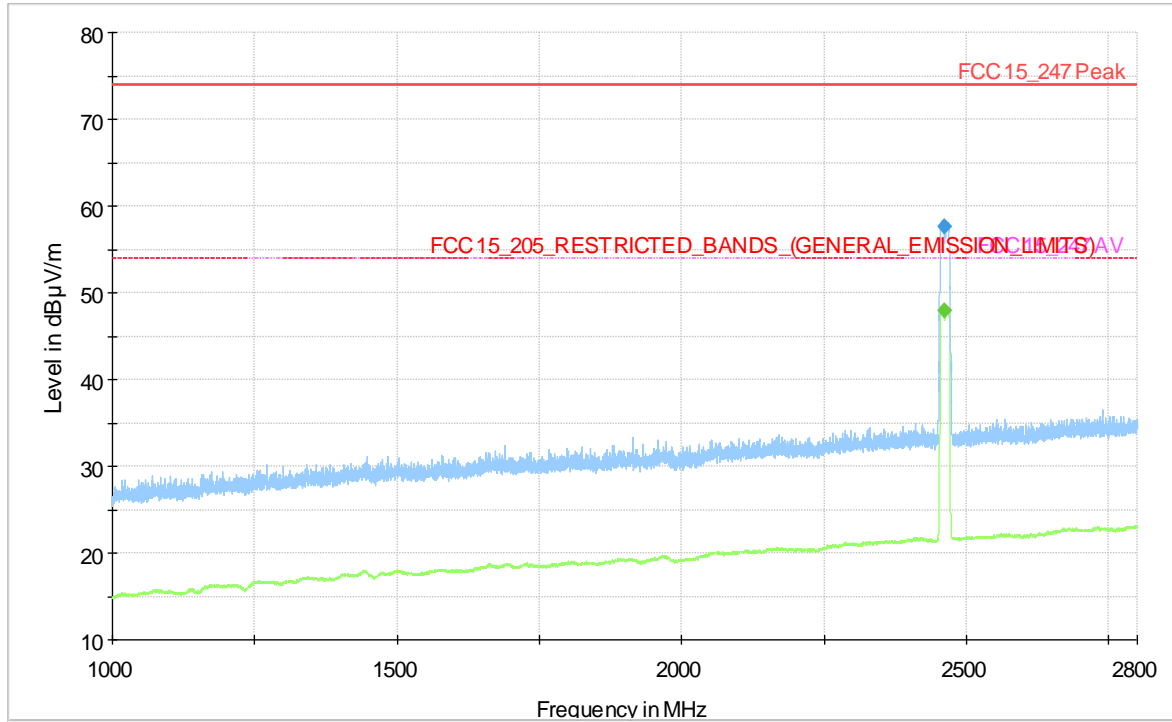

Blue trace Peak detector, Blue Marker Quasi-Peak detector; Green trace average detector, Green Marker average detector

Average Final Result

Frequency (MHz)	Average (dBµV/m)	Limit (dBµV/m)	Margin (dB)	Height (cm)	Pol	Azimuth (deg)
2462.320000	47.97	54.00	6.03	111.0	H	-10.0



MODE	B
CHANNEL	11
FREQUENCY RANGE	2.8-18GHz
POLARIZATION	HORIZONTAL

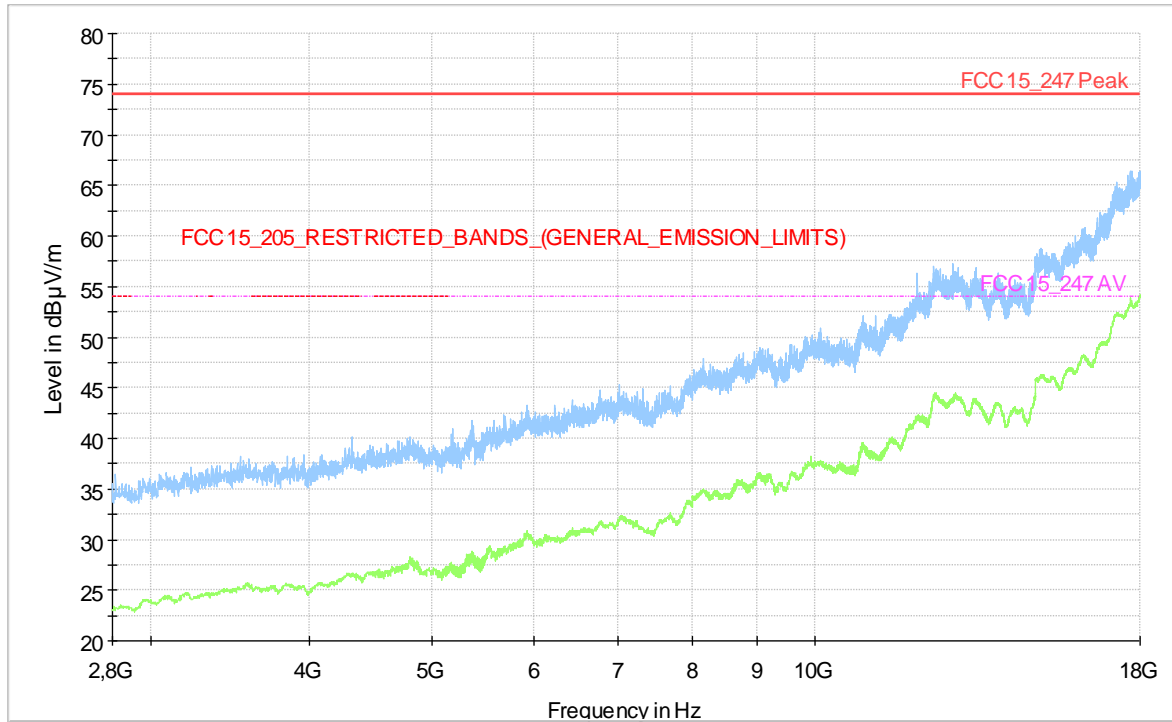

Blue trace Peak detector, Green trace average detector



MODE	B
CHANNEL	11
FREQUENCY RANGE	18-26GHz
POLARIZATION	HORIZONTAL

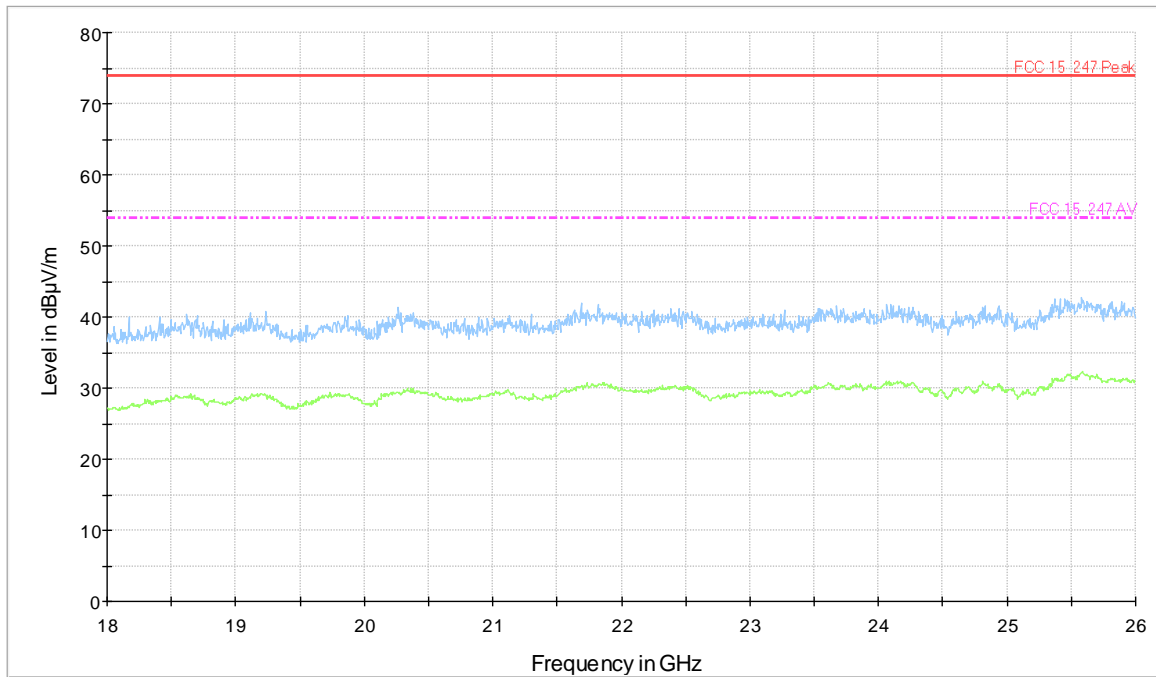



MODE	G
CHANNEL	1
FREQUENCY RANGE	9kHz - 30MHz
POLARIZATION	VERTICAL

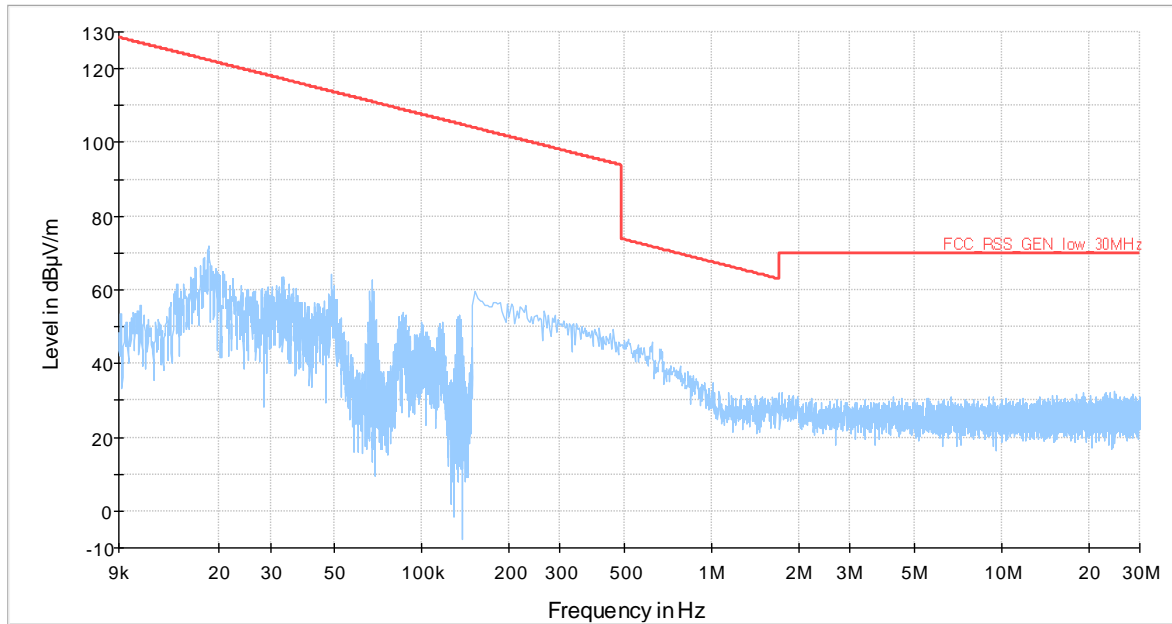



MODE	G
CHANNEL	1
FREQUENCY RANGE	30MHz – 1GHz
POLARIZATION	VERTICAL

Full Spectrum

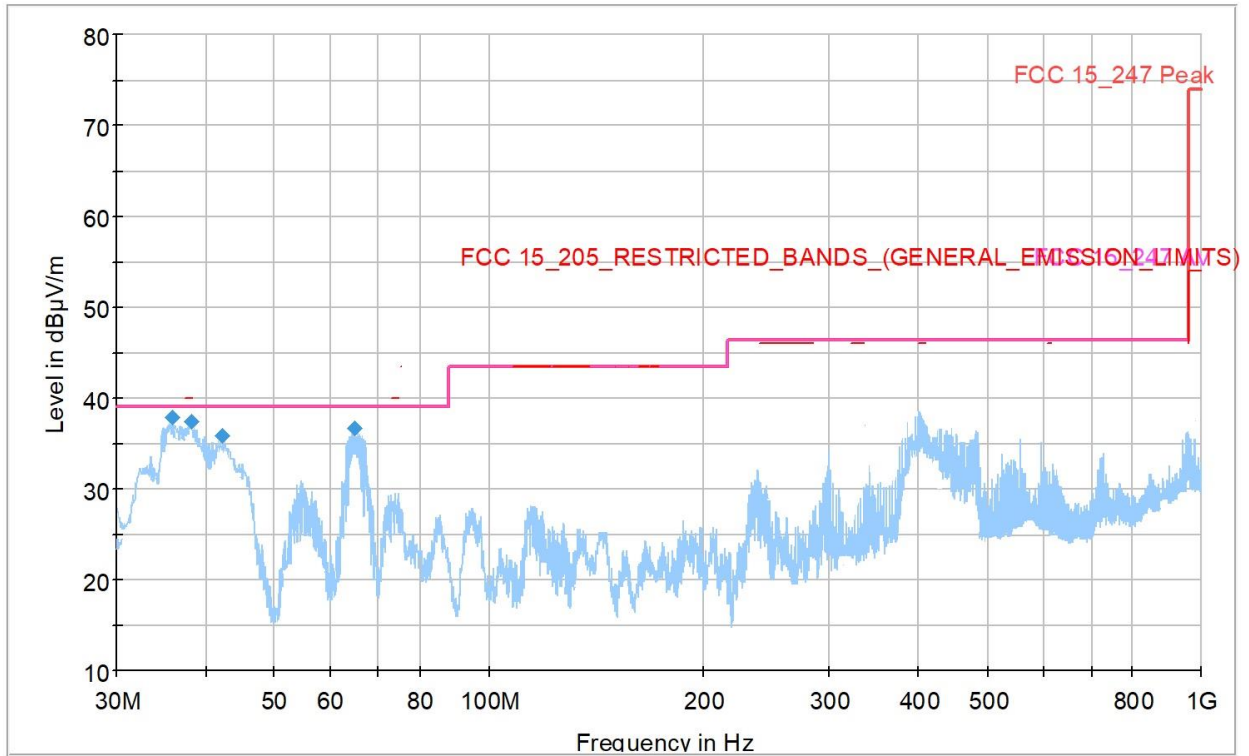

Blue trace Peak detector, Blue Marker Quasi-Peak detector

Final Result

Frequency (MHz)	QuasiPeak (dBµV/m)	Limit (dBµV/m)	Margin (dB)	Height (cm)	Pol	Azimuth (deg)
35.917000	38.05	39.00	0.95	102.0	V	-10.0
38.342000	37.55	39.00	1.45	102.0	V	45.0
42.319000	36.21	39.00	2.79	103.0	V	48.0
64.047000	37.44	39.00	1.56	107.0	V	-5.0



MODE	G
CHANNEL	1
FREQUENCY RANGE	1-2.8GHz
POLARIZATION	VERTICAL

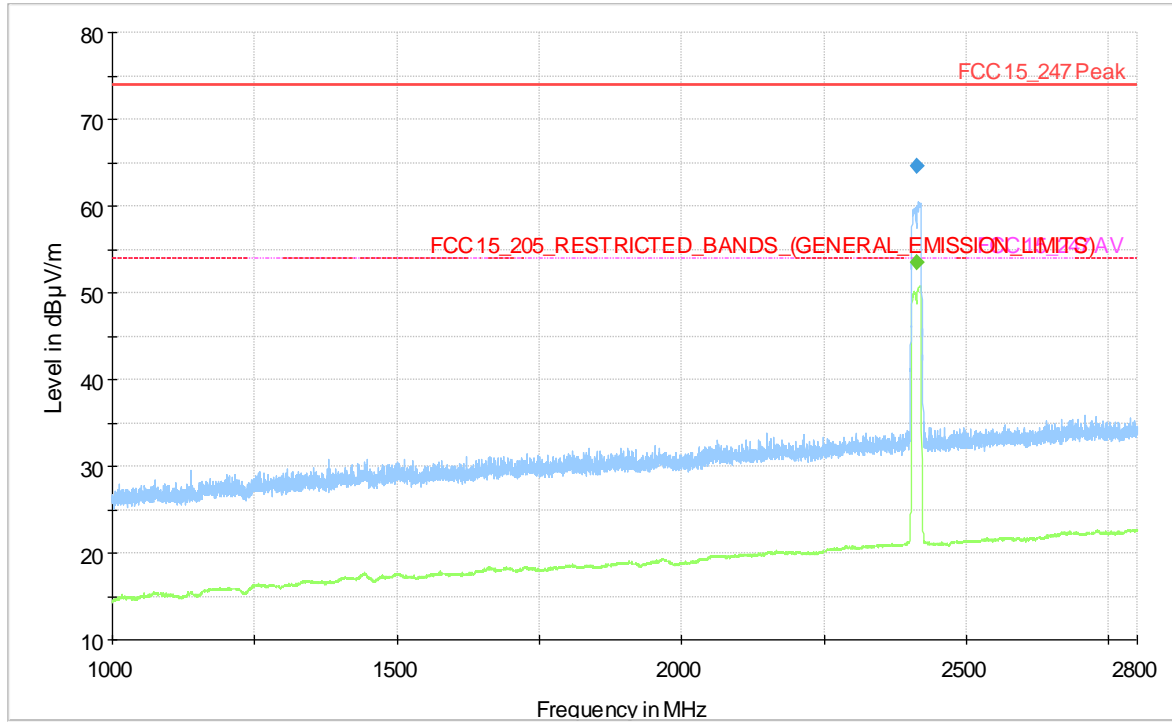

Blue trace Peak detector, Blue Marker Quasi-Peak detector; Green trace average detector, Green Marker average detector

Average Final Result

Frequency (MHz)	Average (dBµV/m)	Limit (dBµV/m)	Margin (dB)	Height (cm)	Pol	Azimuth (deg)
2412.100000	53.44	54.00	0.56	184.0	V	81.0



MODE	G
CHANNEL	1
FREQUENCY RANGE	2.8-18GHz
POLARIZATION	VERTICAL

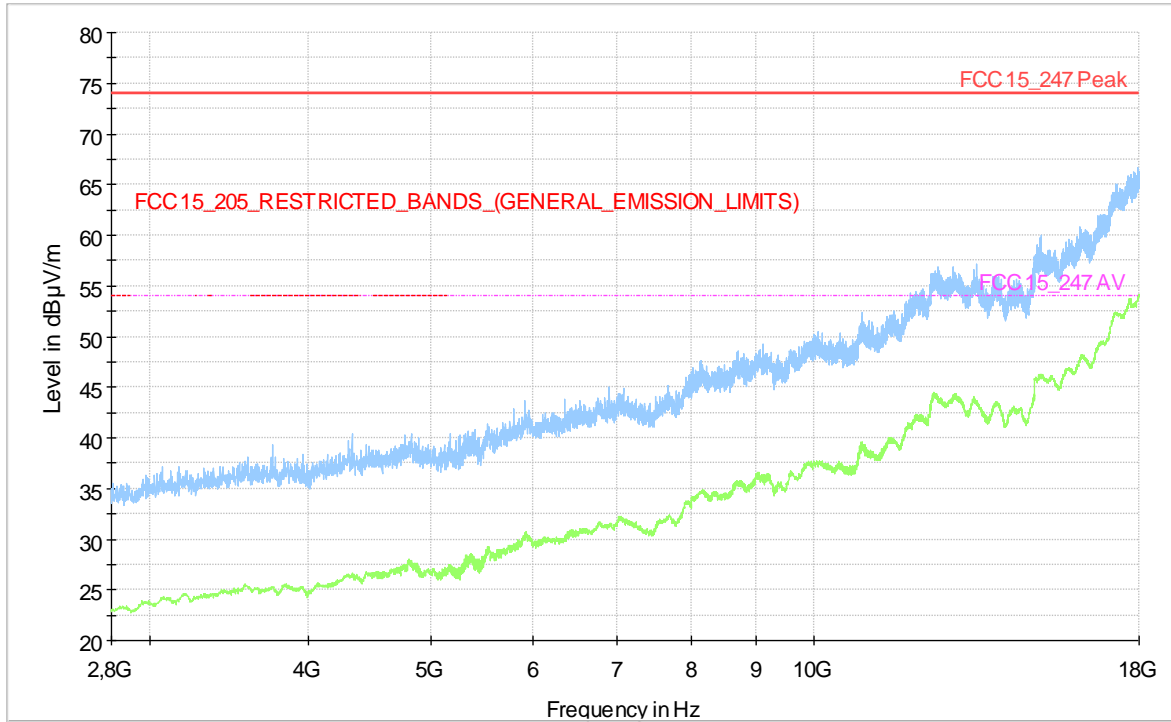

Blue trace Peak detector, Green trace average detector



MODE	G
CHANNEL	1
FREQUENCY RANGE	18-26GHz
POLARIZATION	VERTICAL

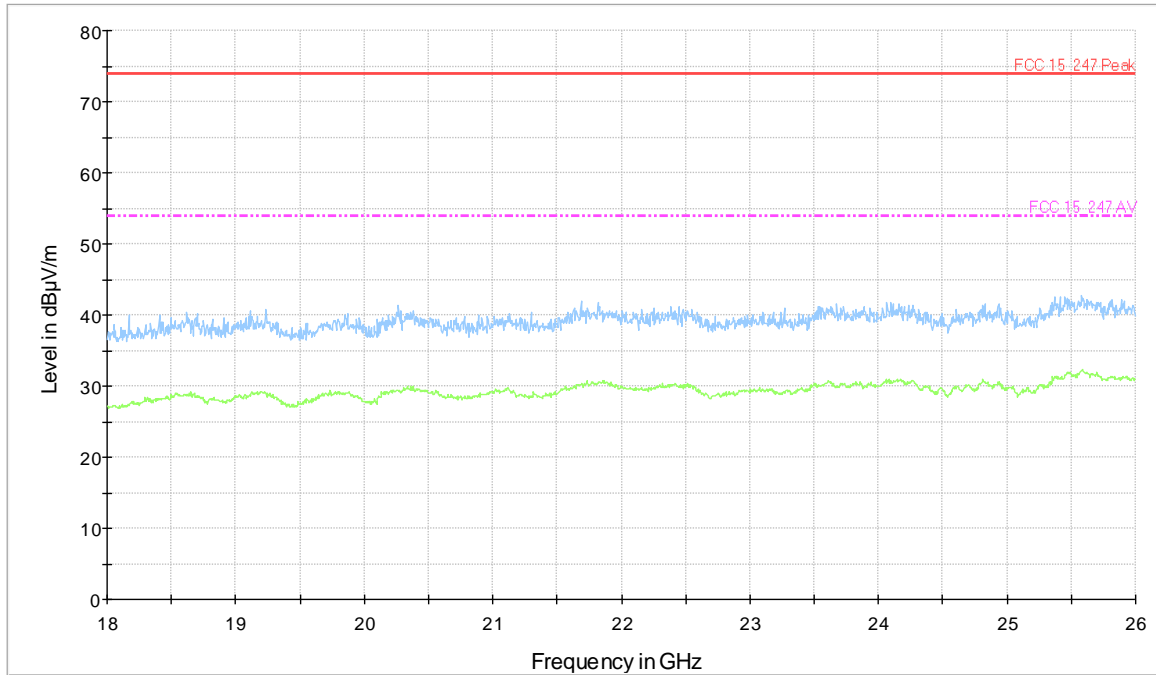



MODE	G
CHANNEL	1
FREQUENCY RANGE	30MHz – 1GHz
POLARIZATION	HORIZONTAL

Full Spectrum

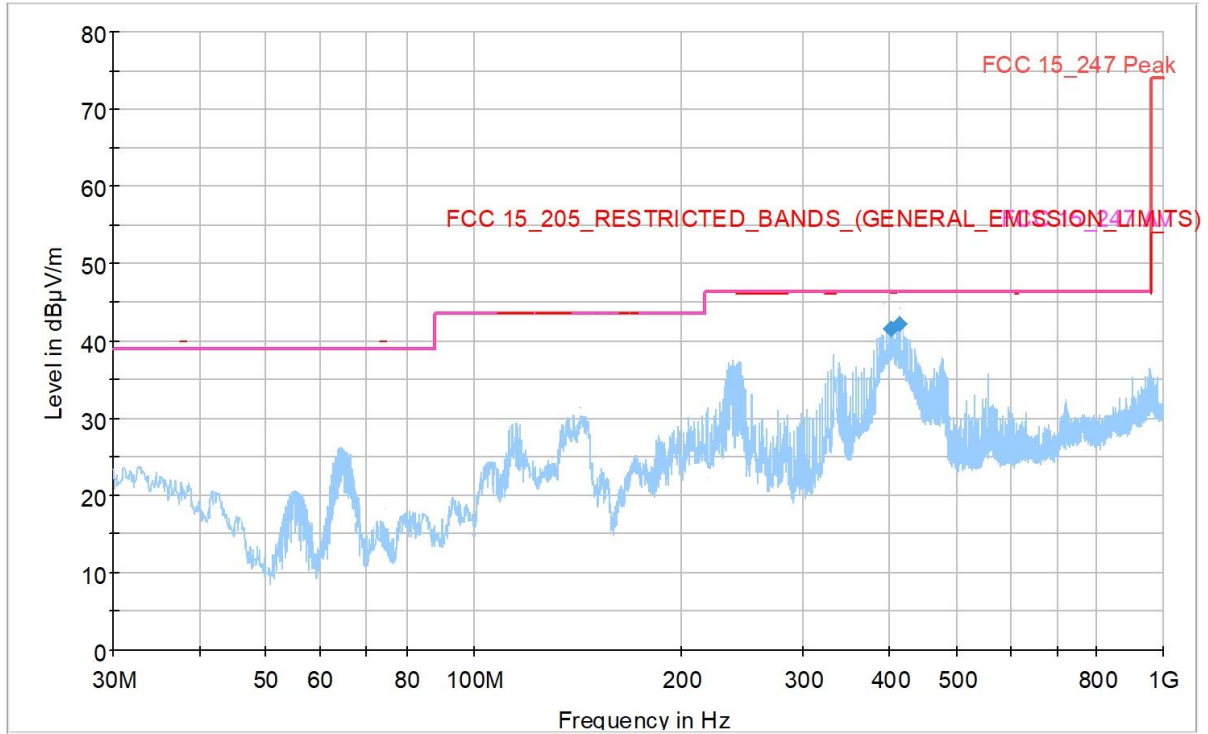

Blue trace Peak detector, Blue Marker Quasi-Peak detector

Final Result

Frequency (MHz)	MaxPeak (dBµV/m)	Limit (dBµV/m)	Margin (dB)	Height (cm)	Pol	Azimuth (deg)
403.159000	41.11	46.40	5.29	105.0	H	120.0
406.360000	42.53	46.40	3.87	104.0	H	103.0



MODE	G
CHANNEL	1
FREQUENCY RANGE	1-2.8GHz
POLARIZATION	HORIZONTAL



Blue trace Peak detector, Blue Marker Quasi-Peak detector; Green trace average detector, Green Marker average detector

Average Final Result

Frequency (MHz)	Average (dBµV/m)	Limit (dBµV/m)	Margin (dB)	Height (cm)	Pol	Azimuth (deg)
2412.100000	48.72	54.00	5.28	100.0	H	37.0



MODE	G
CHANNEL	1
FREQUENCY RANGE	2.8-18GHz
POLARIZATION	HORIZONTAL

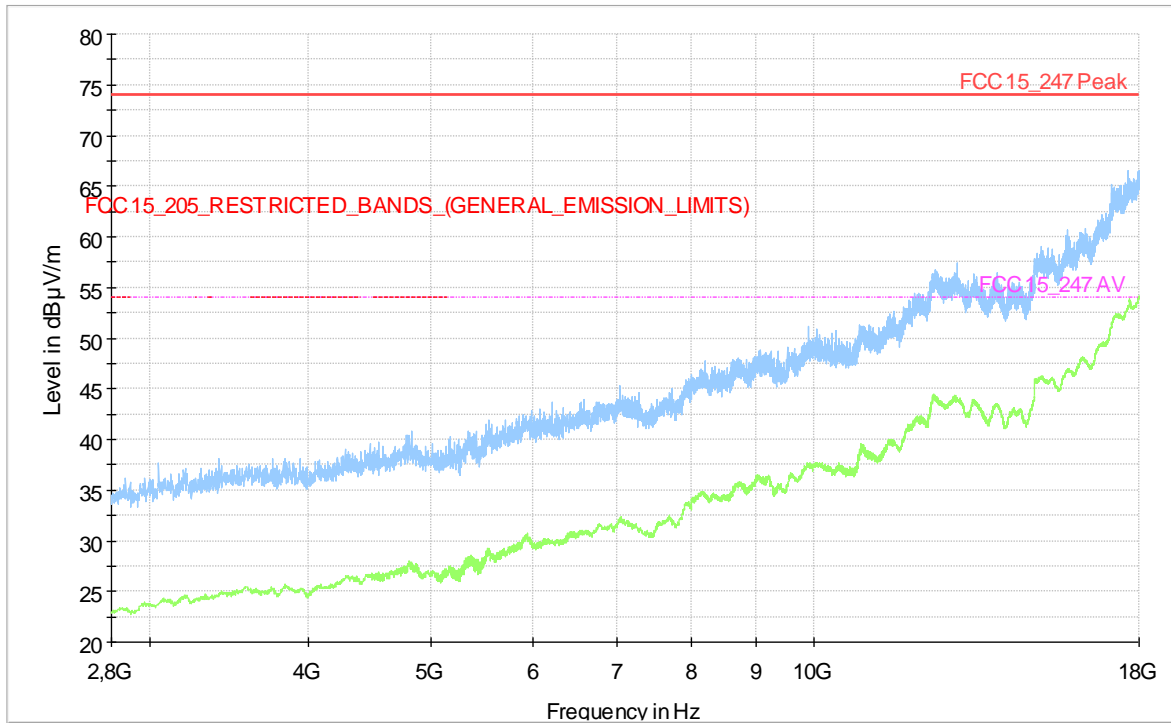

Blue trace Peak detector, Green trace average detector



MODE	G
CHANNEL	1
FREQUENCY RANGE	18-26GHz
POLARIZATION	HORIZONTAL

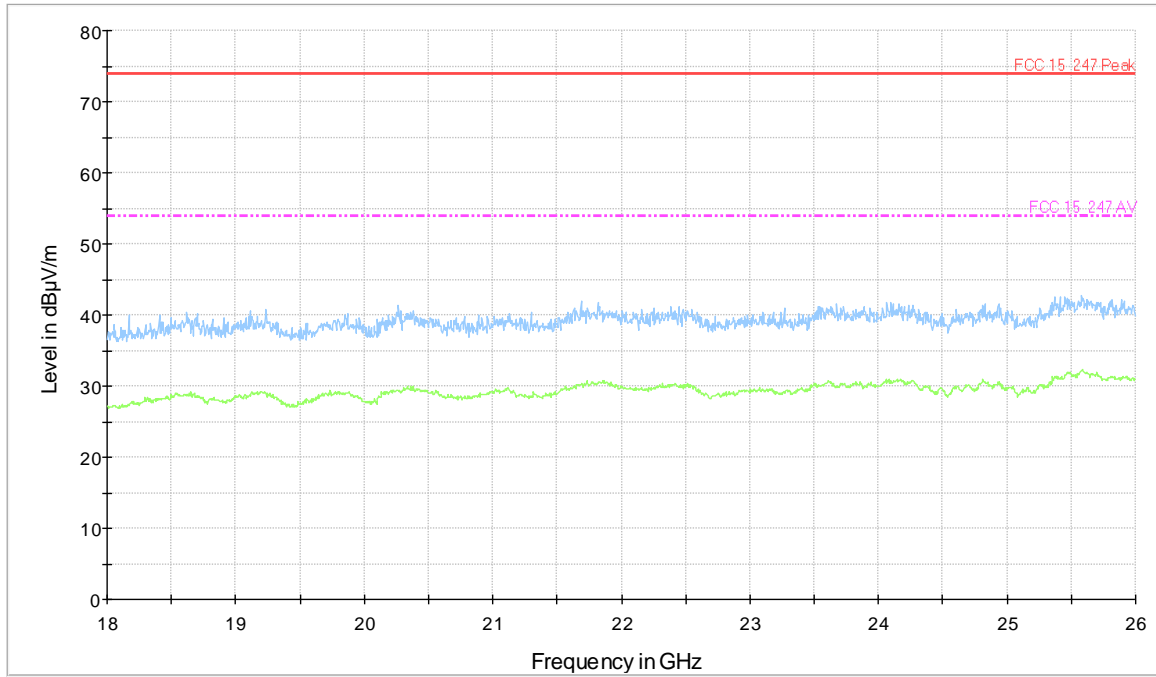



MODE	G
CHANNEL	11
FREQUENCY RANGE	9kHz - 30MHz
POLARIZATION	VERTICAL

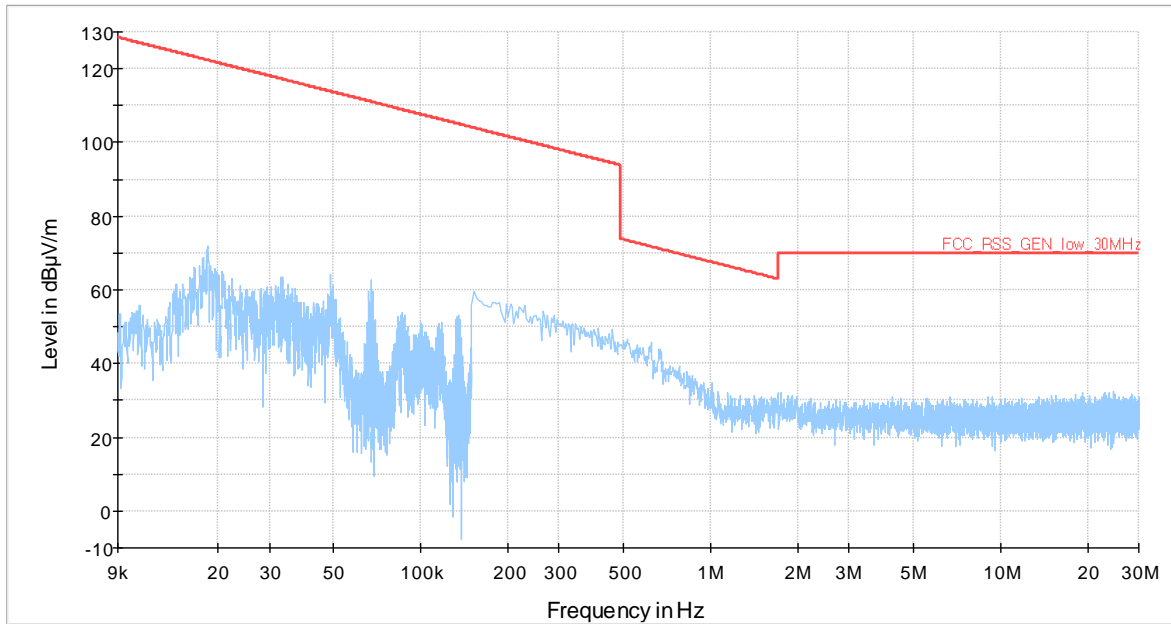



MODE	G
CHANNEL	11
FREQUENCY RANGE	30MHz – 1GHz
POLARIZATION	VERTICAL

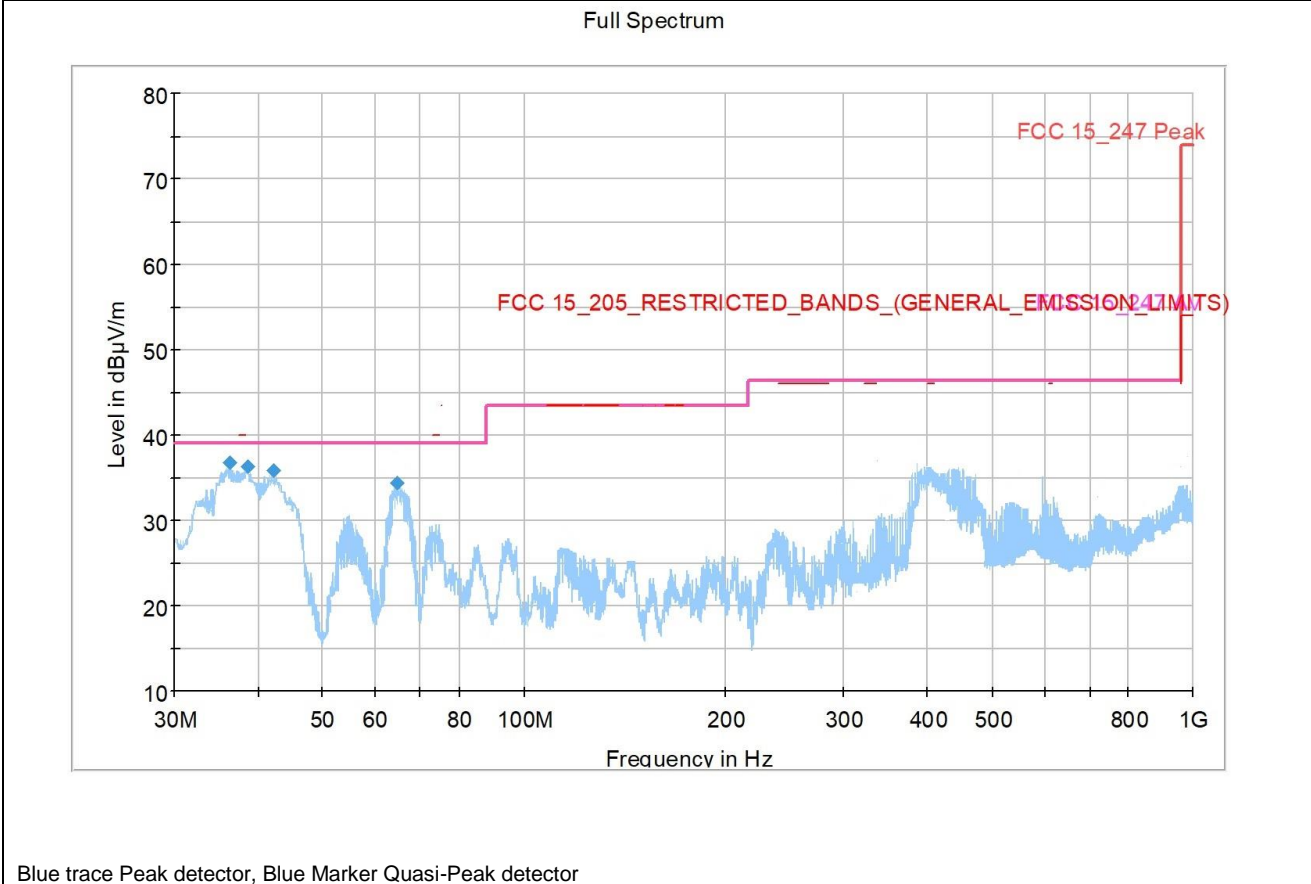

Final Result

Frequency (MHz)	QuasiPeak (dBµV/m)	Limit (dBµV/m)	Margin (dB)	Height (cm)	Pol	Azimuth (deg)
35.917000	37.60	39.00	1.40	104.0	V	-8.0
38.342000	36.68	39.00	2.32	103.0	V	46.0
42.319000	36.12	39.00	2.88	105.0	V	48.0
64.047000	34.36	39.00	4.64	110.0	V	-6.0



MODE	G
CHANNEL	11
FREQUENCY RANGE	1-2.8GHz
POLARIZATION	VERTICAL

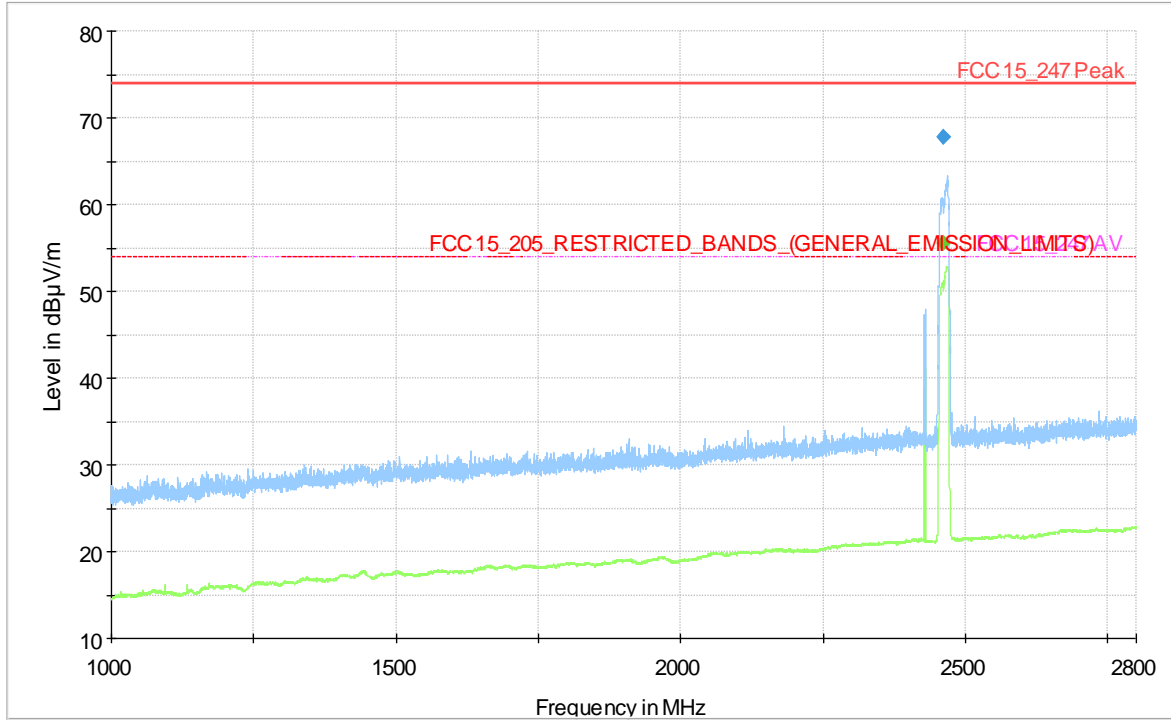

Blue trace Peak detector, Blue Marker Quasi-Peak detector; Green trace average detector, Green Marker average detector

Average Final Result

Frequency (MHz)	Average (dBµV/m)	Limit (dBµV/m)	Margin (dB)	Height (cm)	Pol	Azimuth (deg)
2461.960000	55.63	54.00	-1.63	180.0	V	80.0



MODE	G
CHANNEL	11
FREQUENCY RANGE	2.8-18GHz
POLARIZATION	VERTICAL

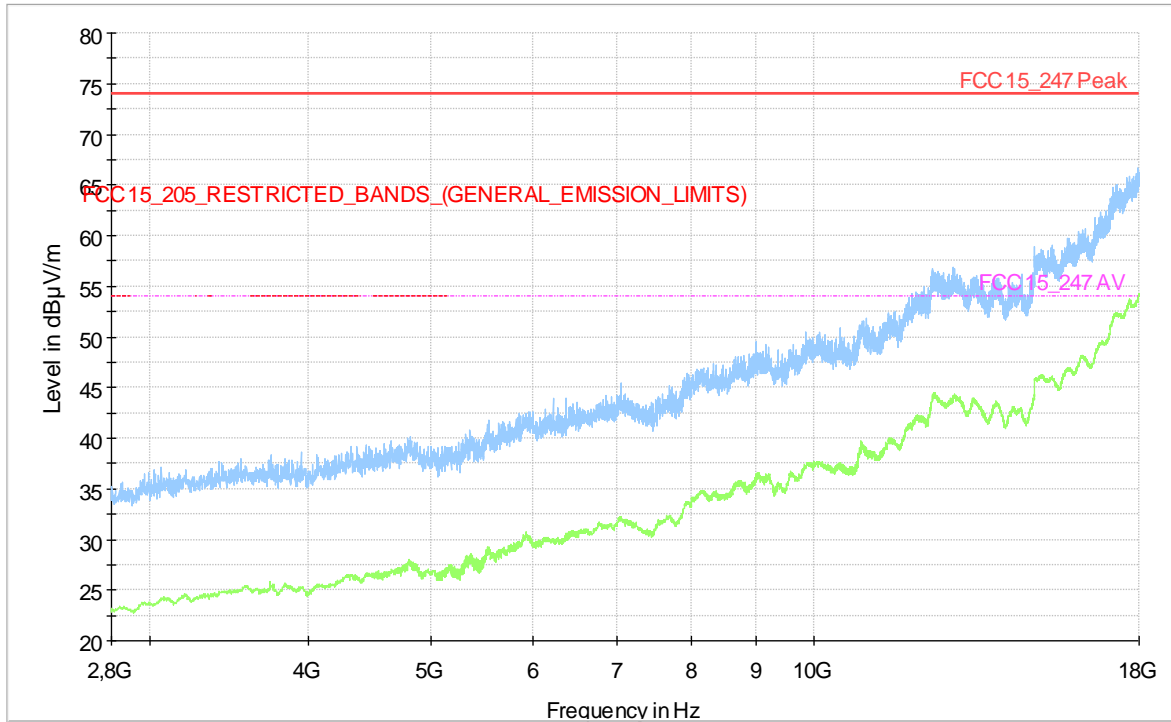

Blue trace Peak detector, Green trace average detector



MODE	G
CHANNEL	11
FREQUENCY RANGE	18-26GHz
POLARIZATION	VERTICAL

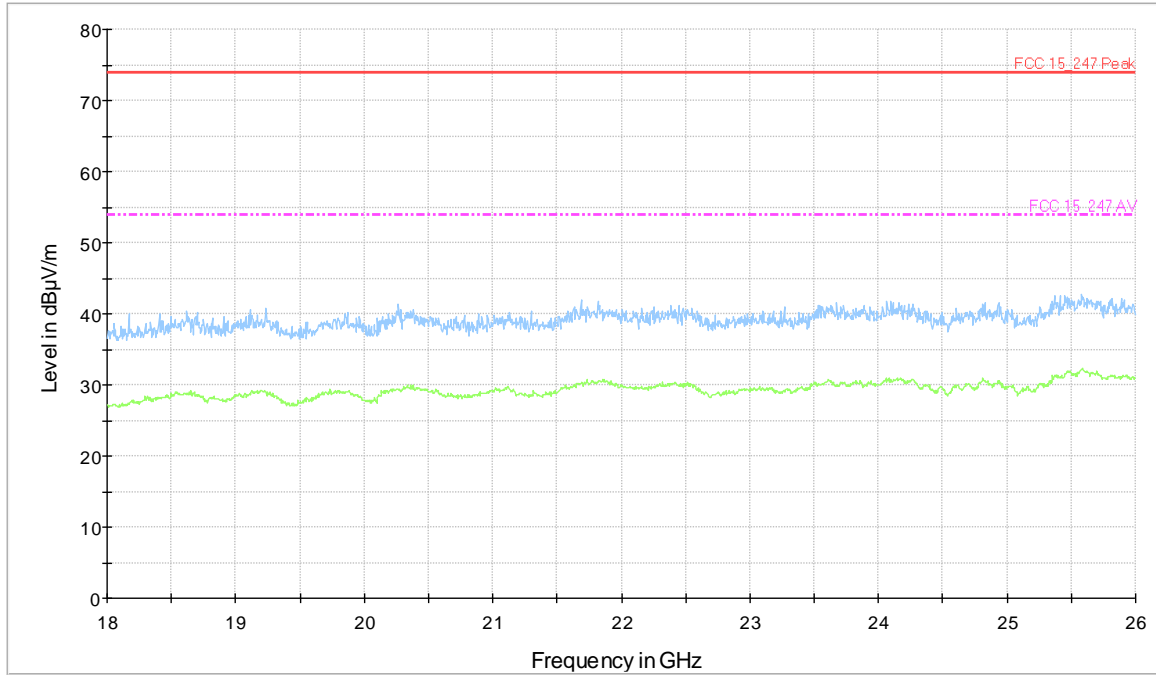



MODE	G
CHANNEL	11
FREQUENCY RANGE	30MHz – 1GHz
POLARIZATION	HORIZONTAL

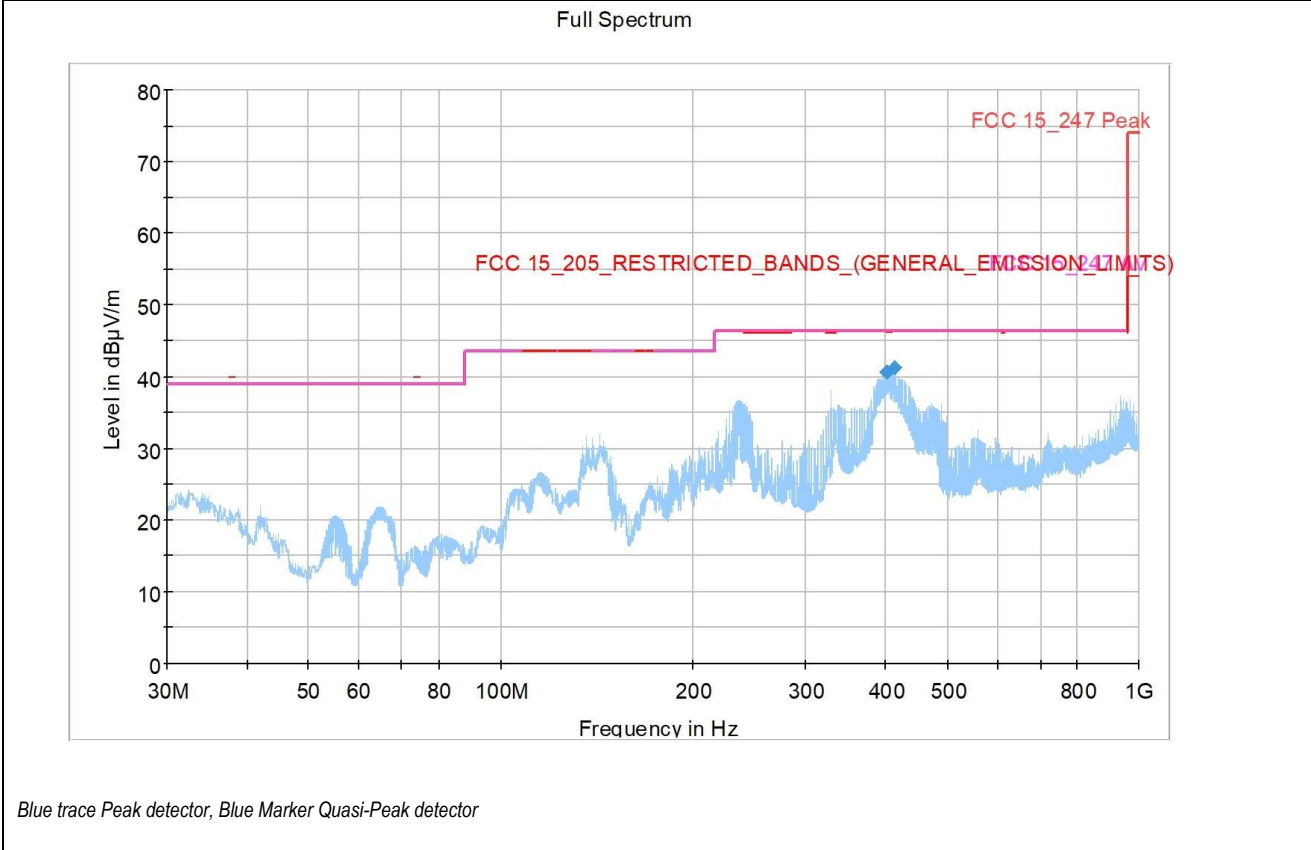

Final Result

Frequency (MHz)	MaxPeak (dBµV/m)	Limit (dBµV/m)	Margin (dB)	Height (cm)	Pol	Azimuth (deg)
403.159000	41.17	46.40	5.23	108.0	H	114.0
406.360000	41.88	46.40	4.52	103.0	H	107.0



MODE	G
CHANNEL	11
FREQUENCY RANGE	1-2.8GHz
POLARIZATION	HORIZONTAL

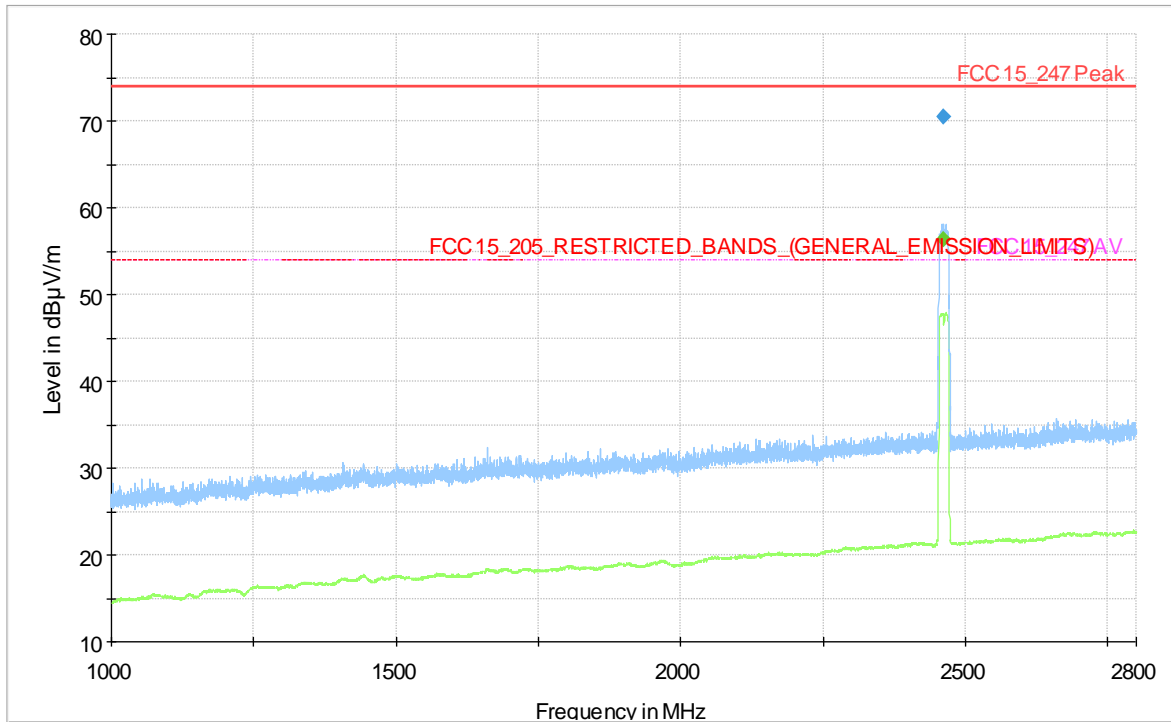

Blue trace Peak detector, Blue Marker Quasi-Peak detector; Green trace average detector, Green Marker average detector

Average Final Result

Frequency (MHz)	Average (dBµV/m)	Limit (dBµV/m)	Margin (dB)	Height (cm)	Pol	Azimuth (deg)
2461.960000	56.39	54.00	-2.39	168.0	H	207.0



MODE	G
CHANNEL	11
FREQUENCY RANGE	2.8-18GHz
POLARIZATION	HORIZONTAL

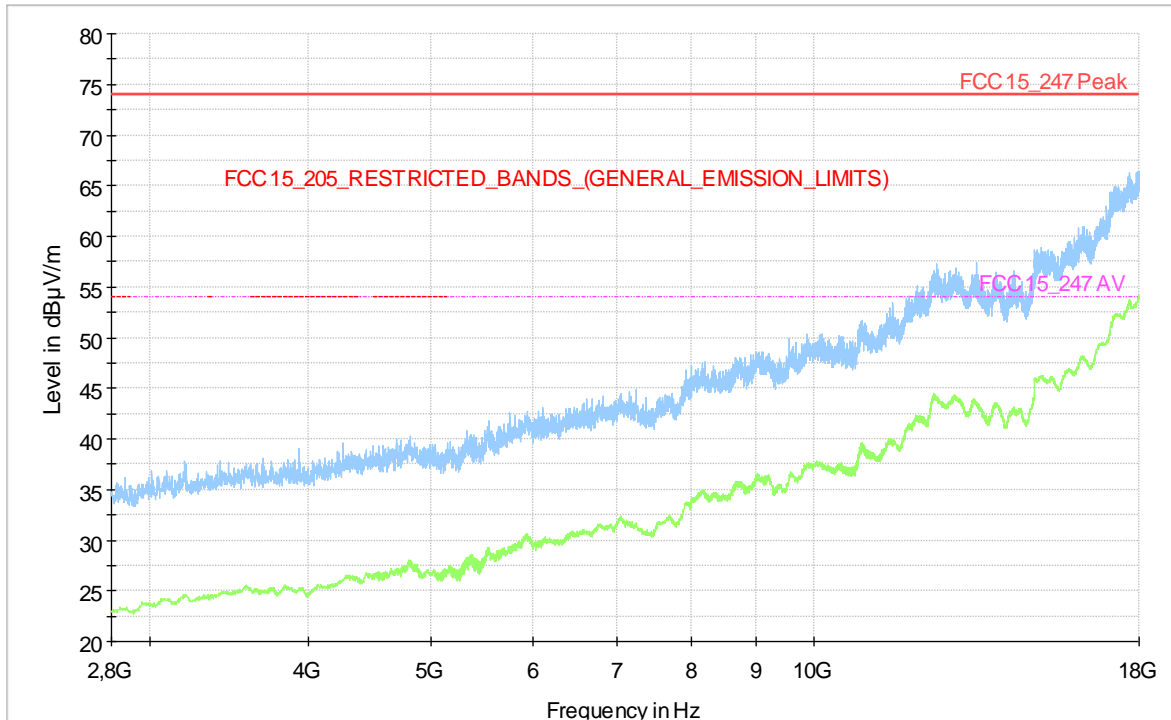

Blue trace Peak detector, Green trace average detector



MODE	G
CHANNEL	11
FREQUENCY RANGE	18-26GHz
POLARIZATION	HORIZONTAL

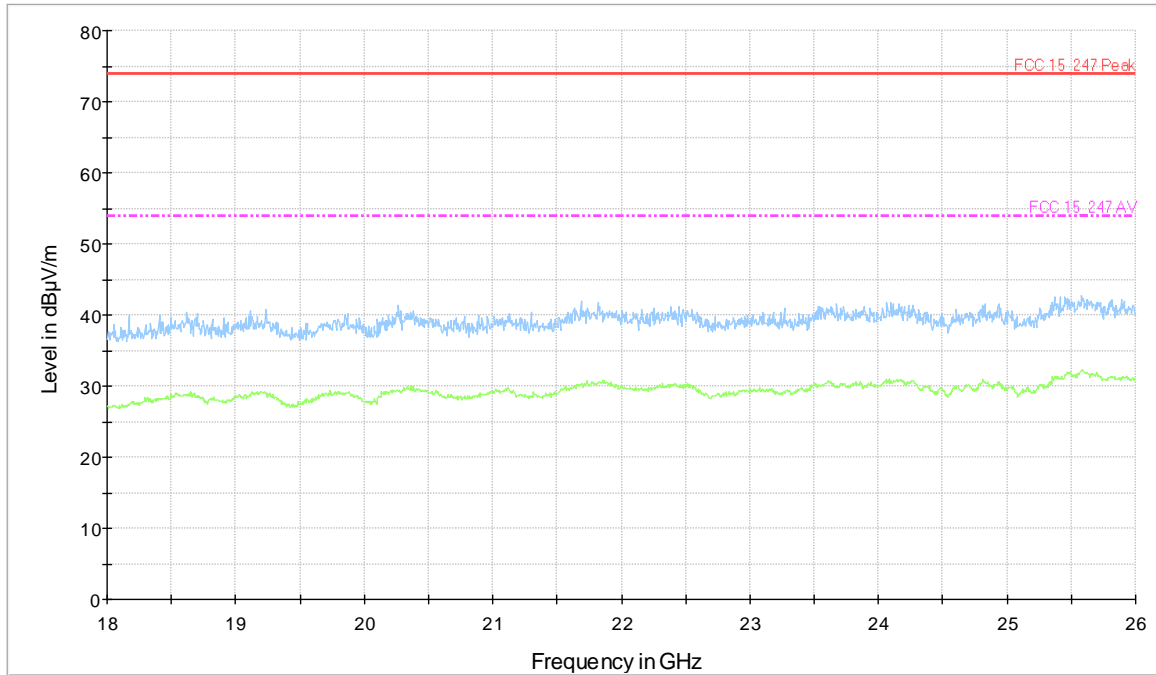



MODE	N
CHANNEL	1
FREQUENCY RANGE	9kHz - 30MHz
POLARIZATION	VERTICAL

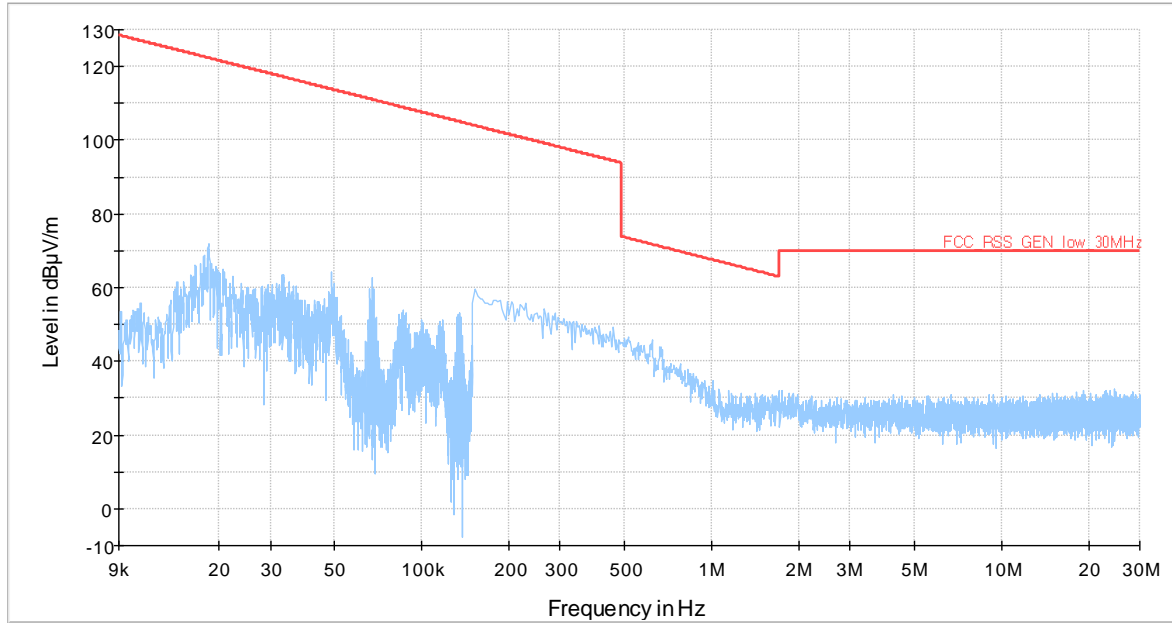



MODE	N
CHANNEL	1
FREQUENCY RANGE	30MHz – 1GHz
POLARIZATION	VERTICAL

Full Spectrum

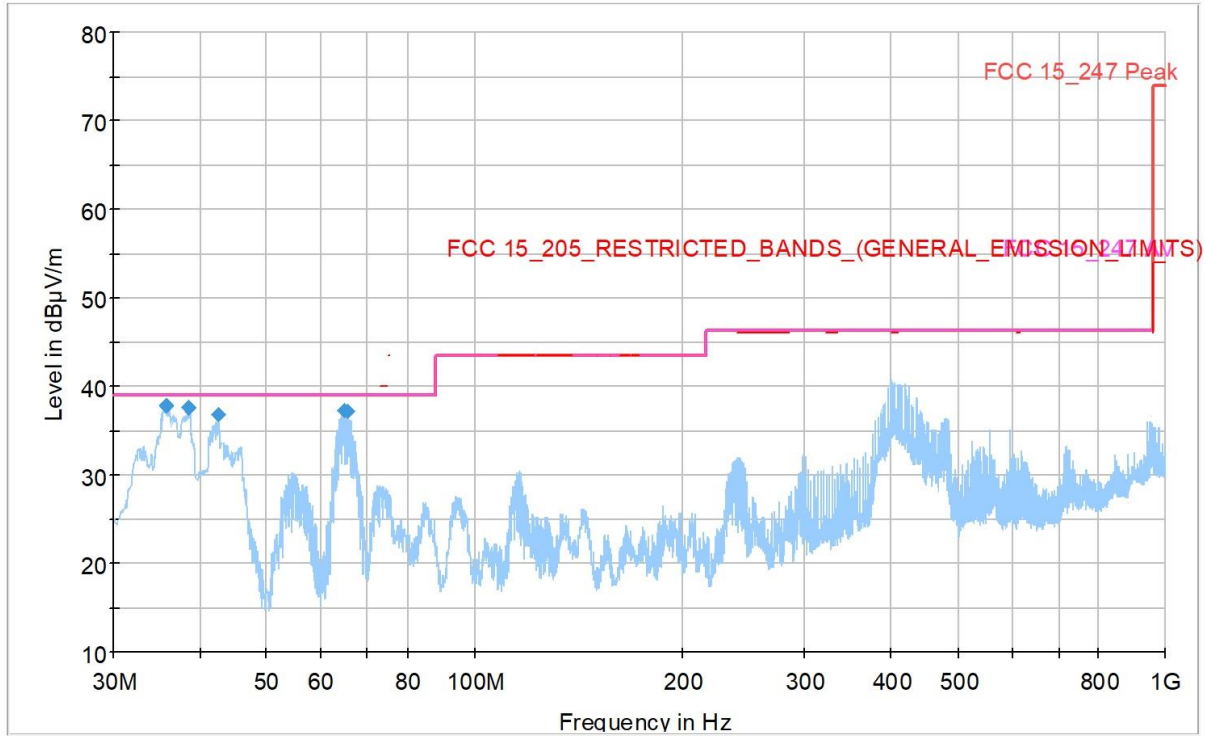

Blue trace Peak detector, Blue Marker Quasi-Peak detector

Final Result

Frequency (MHz)	QuasiPeak (dBµV/m)	Limit (dBµV/m)	Margin (dB)	Height (cm)	Pol	Azimuth (deg)
35.917000	38.60	39.00	0.40	103.0	V	-10.0
38.342000	38.51	39.00	0.49	103.0	V	43.0
42.319000	37.39	39.00	1.61	106.0	V	48.0
64.047000	37.54	39.00	1.46	112.0	V	-5.0
64.726000	37.52	39.00	1.48	124.0	V	133.0



MODE	N
CHANNEL	1
FREQUENCY RANGE	1-2.8GHz
POLARIZATION	VERTICAL

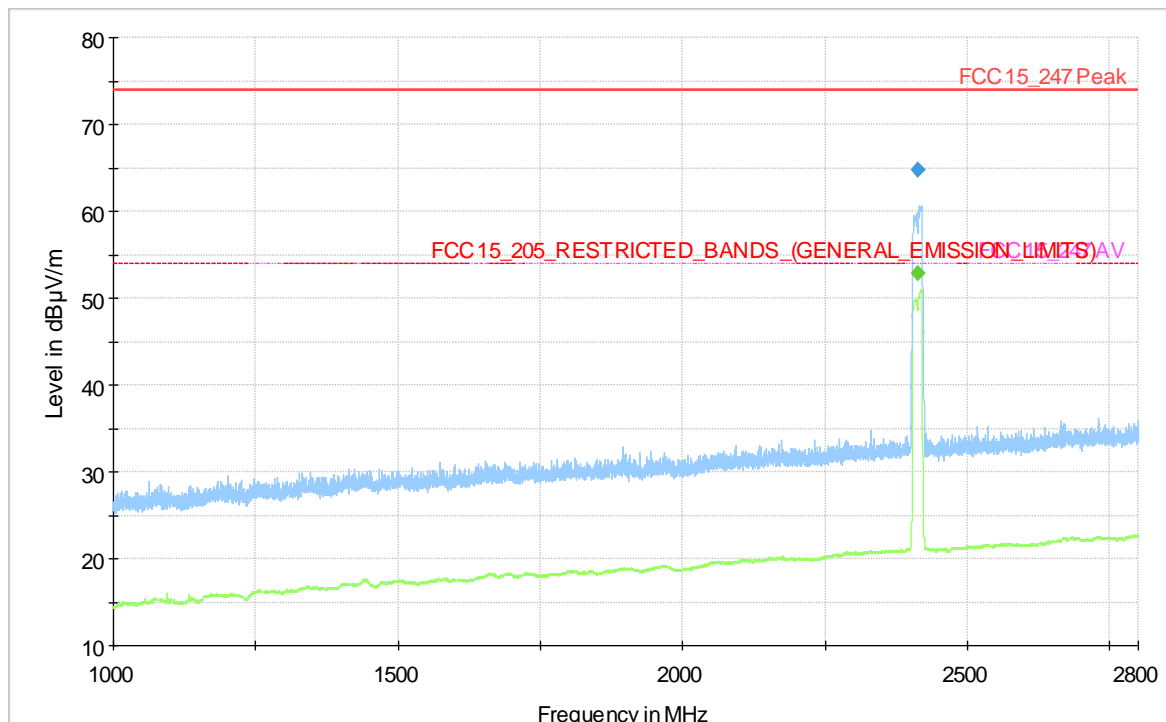

Blue trace Peak detector, Blue Marker Quasi-Peak detector; Green trace average detector, Green Marker average detector

Average Final Result

Frequency (MHz)	Average (dBµV/m)	Limit (dBµV/m)	Margin (dB)	Height (cm)	Pol	Azimuth (deg)
2412.100000	52.90	54.00	1.10	184.0	V	80.0



MODE	N
CHANNEL	1
FREQUENCY RANGE	2.8-18GHz
POLARIZATION	VERTICAL

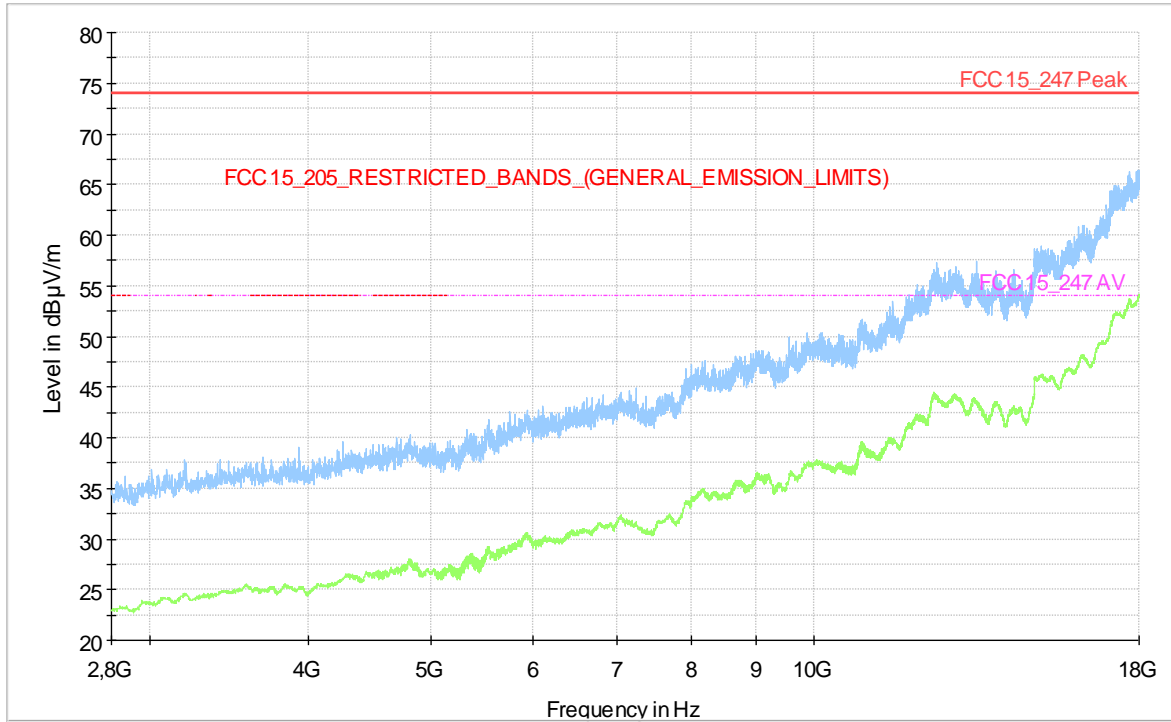

Blue trace Peak detector, Green trace average detector



MODE	N
CHANNEL	1
FREQUENCY RANGE	18-26GHz
POLARIZATION	VERTICAL

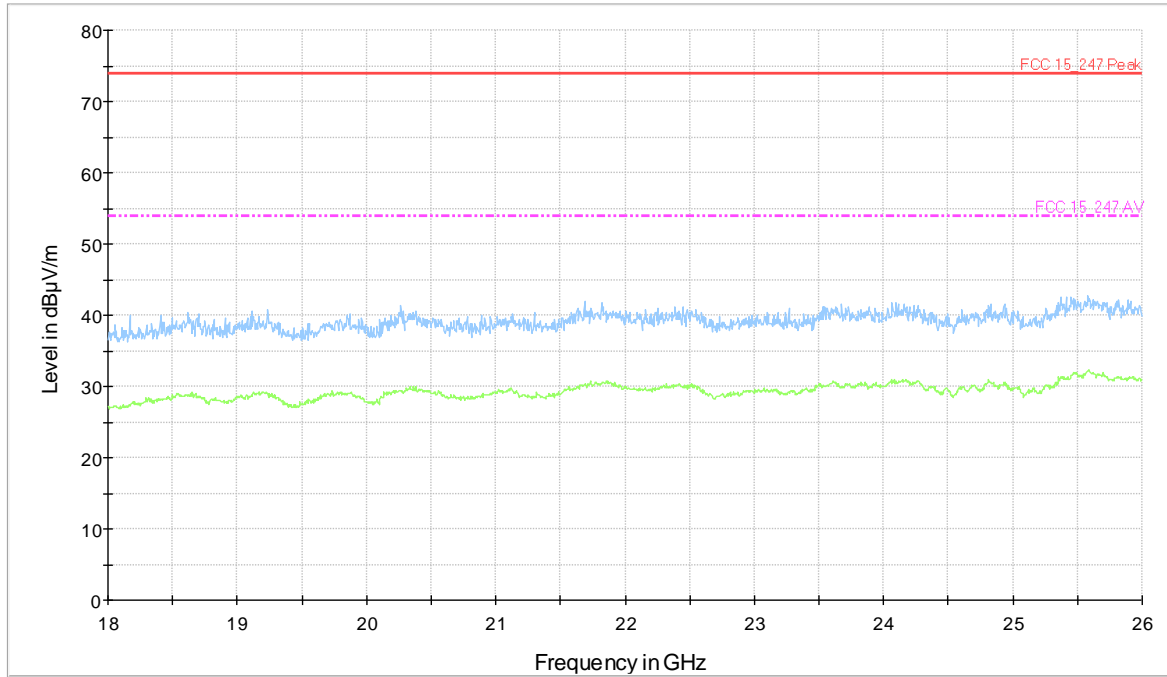



MODE	N
CHANNEL	1
FREQUENCY RANGE	30MHz – 1GHz
POLARIZATION	HORIZONTAL

Full Spectrum

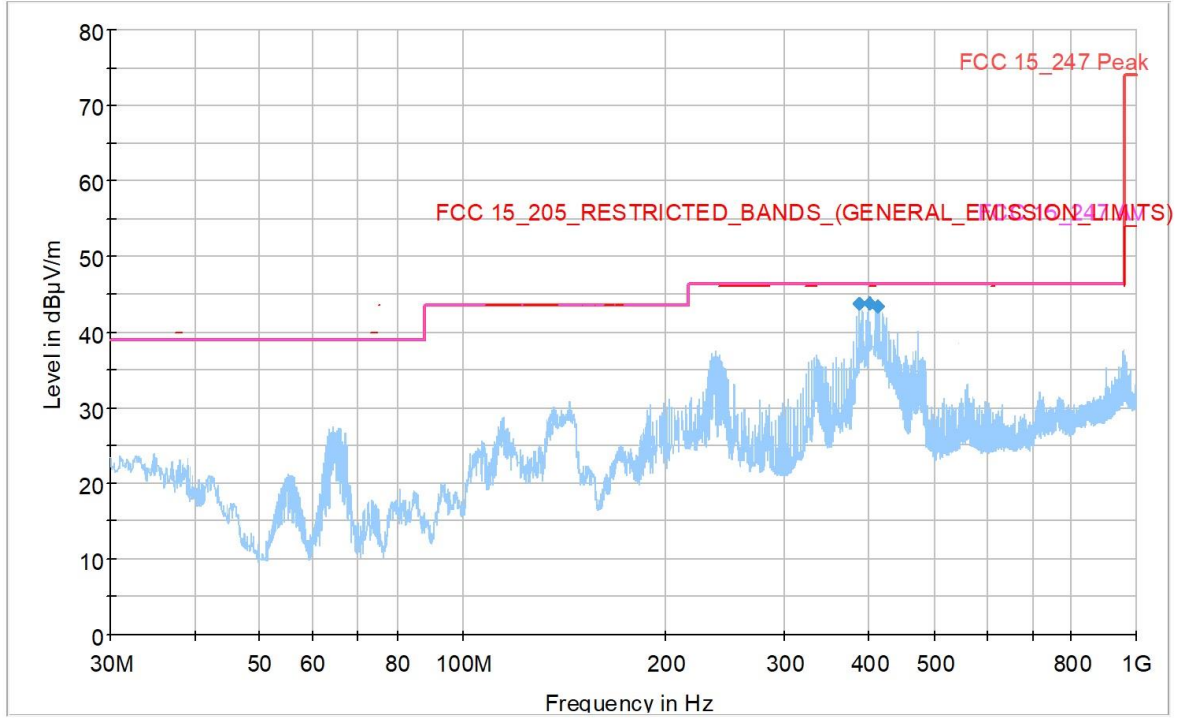

Blue trace Peak detector, Blue Marker Quasi-Peak detector

Final Result

Frequency (MHz)	MaxPeak (dBµV/m)	Limit (dBµV/m)	Margin (dB)	Height (cm)	Pol	Azimuth (deg)
396.234000	44.63	46.40	1.77	97.0	H	104.0
403.159000	44.62	46.40	1.78	105.0	H	120.0
406.360000	44.30	46.40	2.10	105.0	H	107.0



MODE	N
CHANNEL	1
FREQUENCY RANGE	1-2.8GHz
POLARIZATION	HORIZONTAL

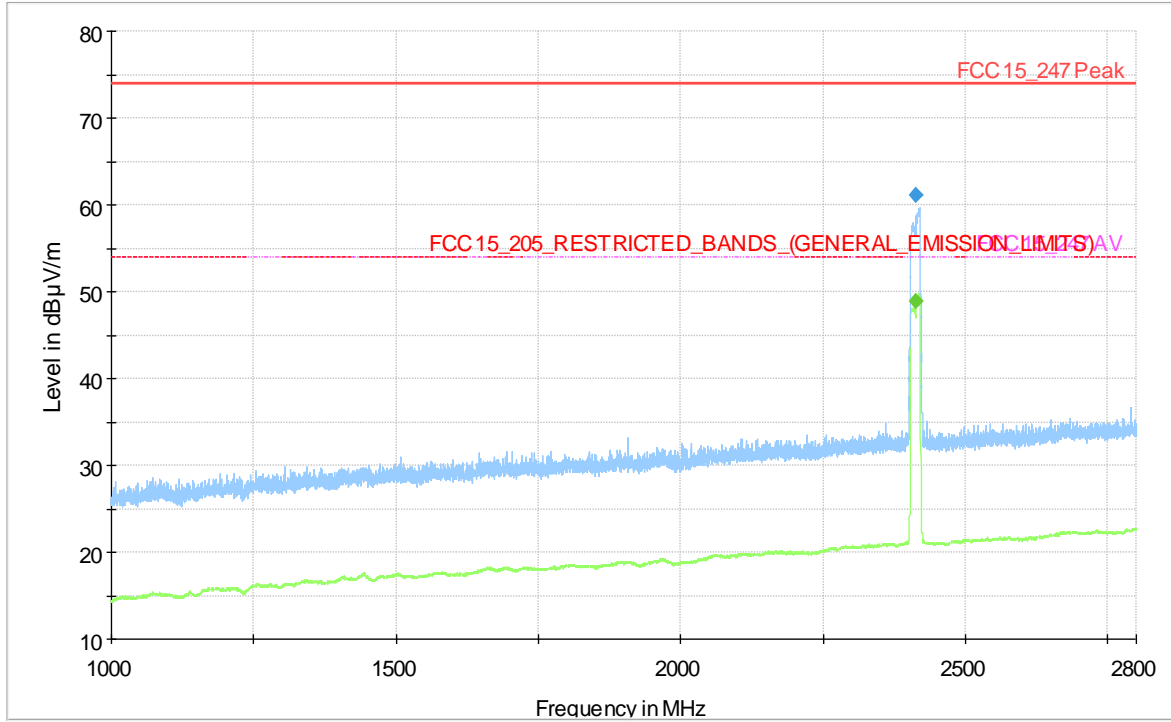

Blue trace Peak detector, Blue Marker Quasi-Peak detector; Green trace average detector, Green Marker average detector

Average Final Result

Frequency (MHz)	Average (dBµV/m)	Limit (dBµV/m)	Margin (dB)	Height (cm)	Pol	Azimuth (deg)
2411.920000	48.90	54.00	5.10	100.0	H	37.0



MODE	N
CHANNEL	1
FREQUENCY RANGE	2.8-18GHz
POLARIZATION	HORIZONTAL

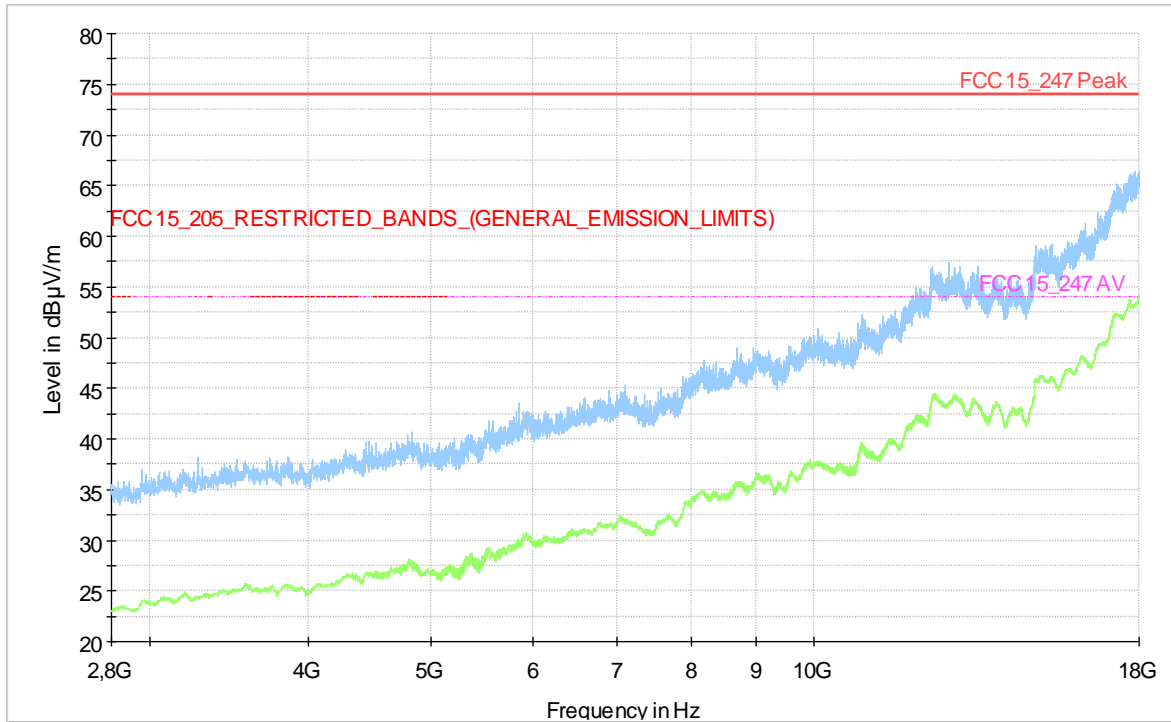

Blue trace Peak detector, Green trace average detector



MODE	N
CHANNEL	1
FREQUENCY RANGE	18-26GHz
POLARIZATION	HORIZONTAL

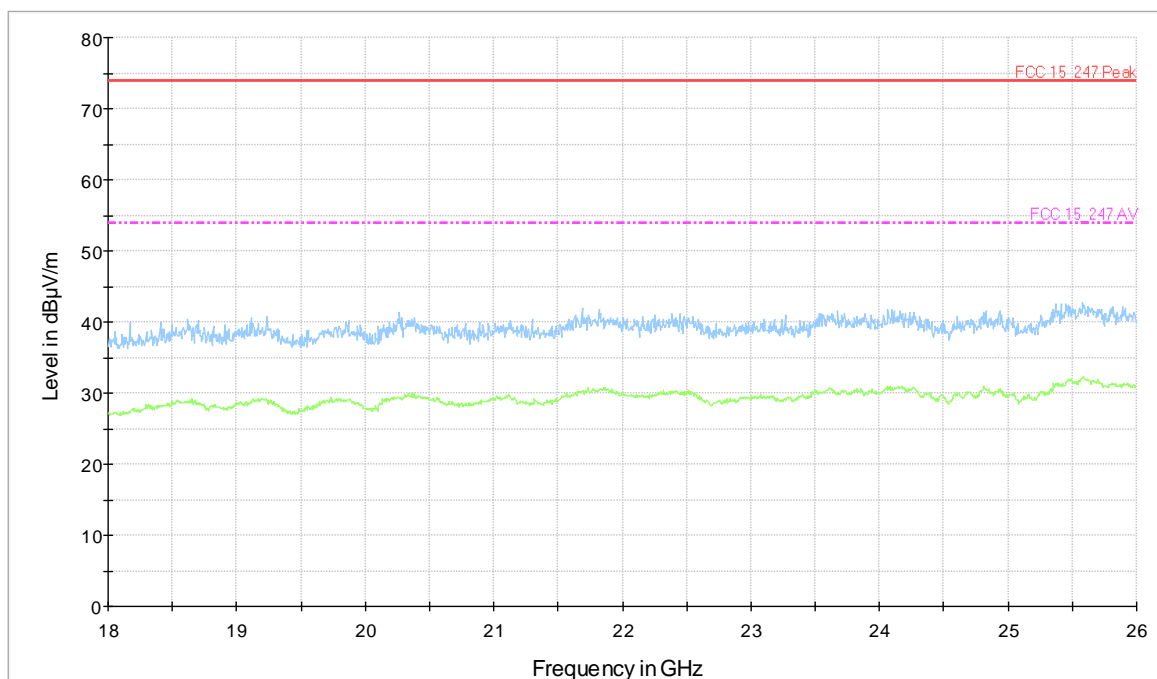



MODE	N
CHANNEL	11
FREQUENCY RANGE	9kHz - 30MHz
POLARIZATION	---

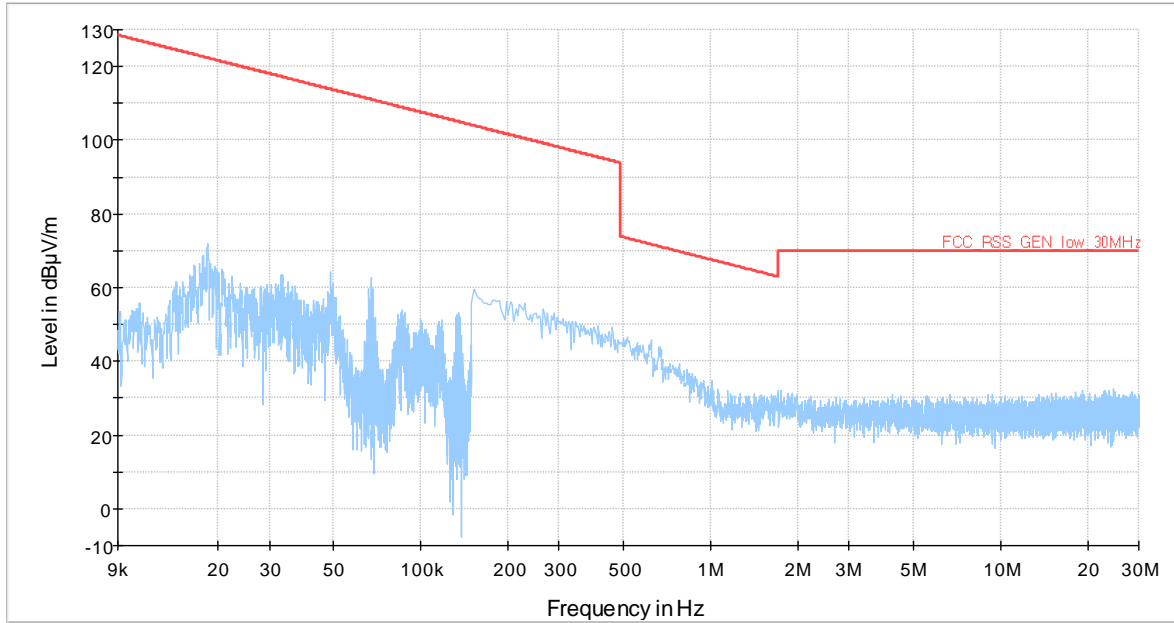



MODE	N
CHANNEL	11
FREQUENCY RANGE	30MHz – 1GHz
POLARIZATION	VERTICAL

Full Spectrum

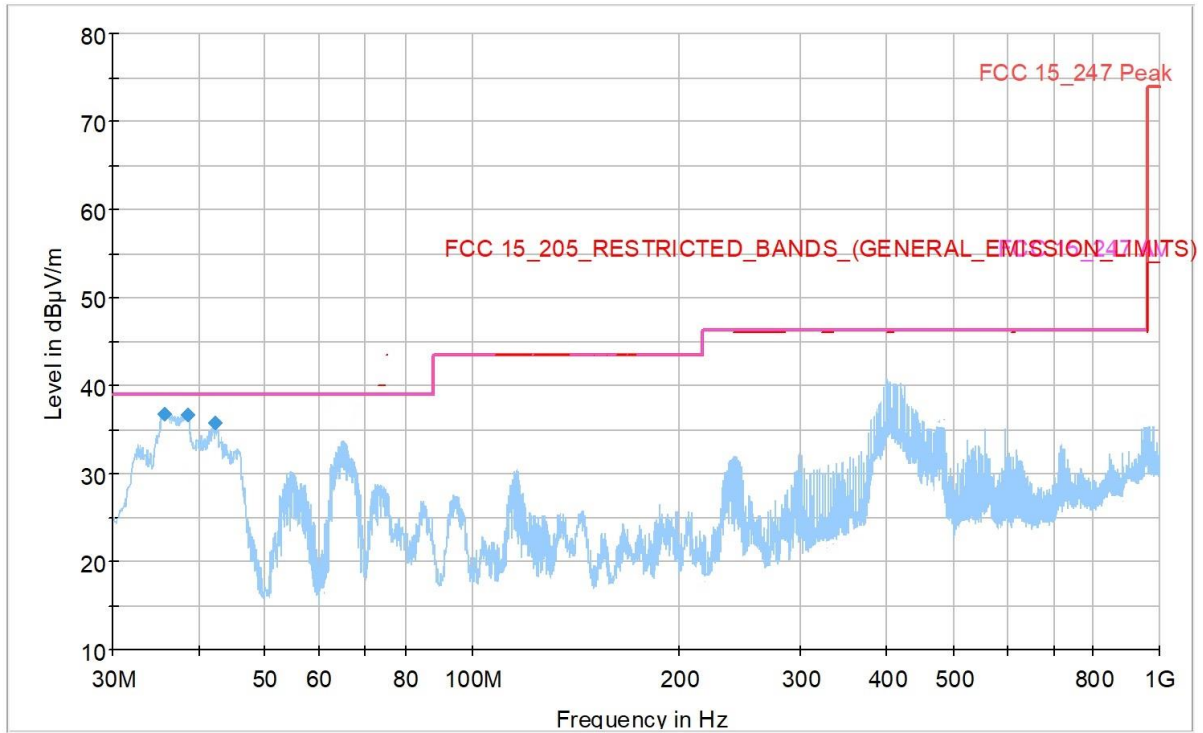

Blue trace Peak detector, Blue Marker Quasi-Peak detector

Final Result

Frequency (MHz)	QuasiPeak (dBµV/m)	Limit (dBµV/m)	Margin (dB)	Height (cm)	Pol	Azimuth (deg)
35.917000	36.70	39.00	2.30	102.0	V	-11.0
38.342000	36.68	39.00	2.32	102.0	V	44.0
42.319000	35.30	39.00	3.70	102.0	V	50.0



MODE	N
CHANNEL	11
FREQUENCY RANGE	1-2.8GHz
POLARIZATION	VERTICAL

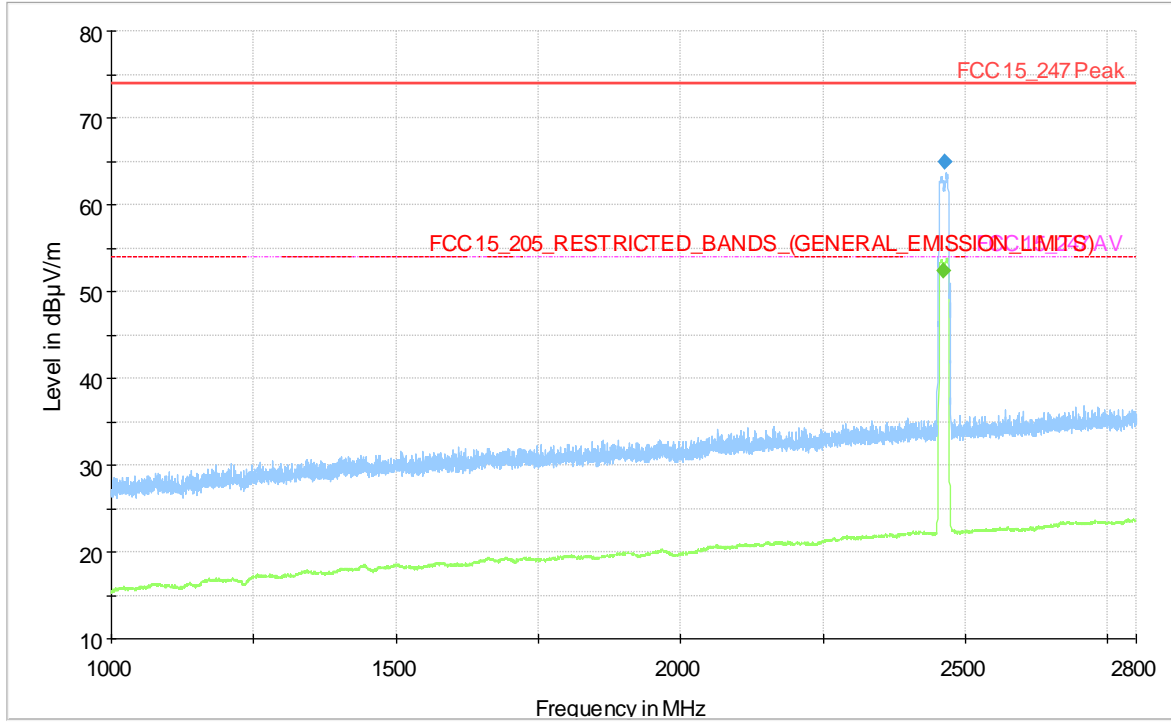

Blue trace Peak detector, Blue Marker Quasi-Peak detector; Green trace average detector, Green Marker average detector

Average Final Result

Frequency (MHz)	Average (dBµV/m)	Limit (dBµV/m)	Margin (dB)	Height (cm)	Pol	Azimuth (deg)
2462.140000	52.33	54.00	1.67	128.0	V	13.0



MODE	N
CHANNEL	11
FREQUENCY RANGE	2.8-18GHz
POLARIZATION	VERTICAL

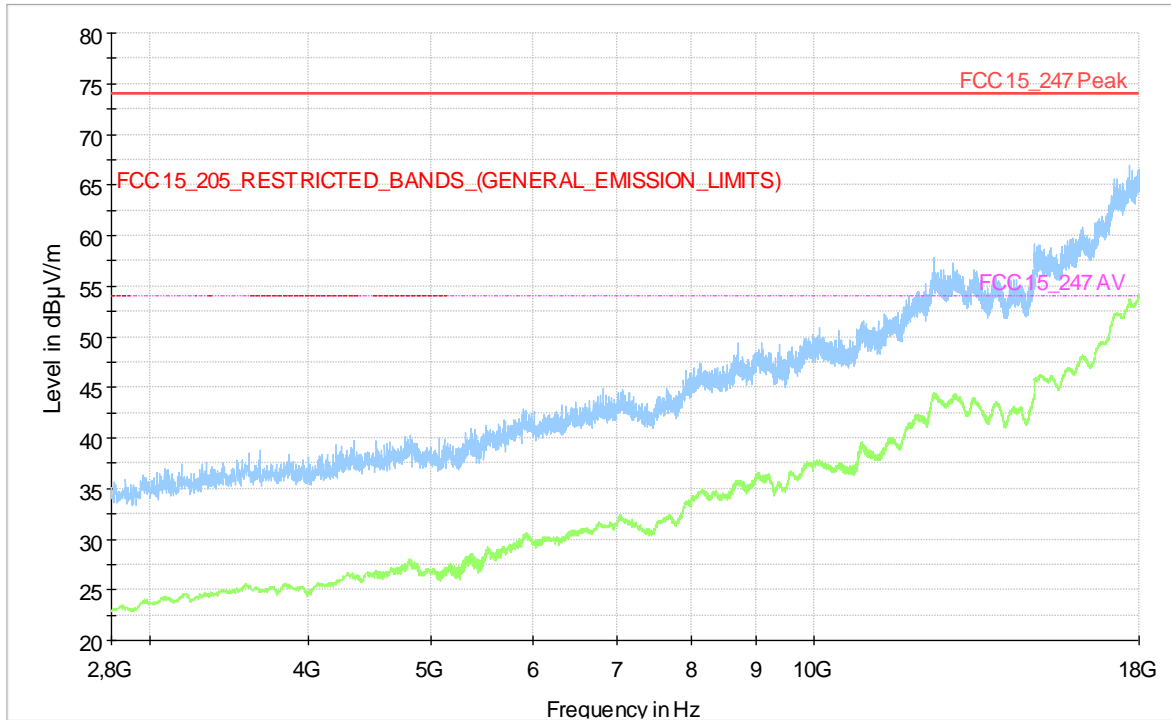

Blue trace Peak detector, Green trace average detector



MODE	N
CHANNEL	11
FREQUENCY RANGE	18-26GHz
POLARIZATION	VERTICAL

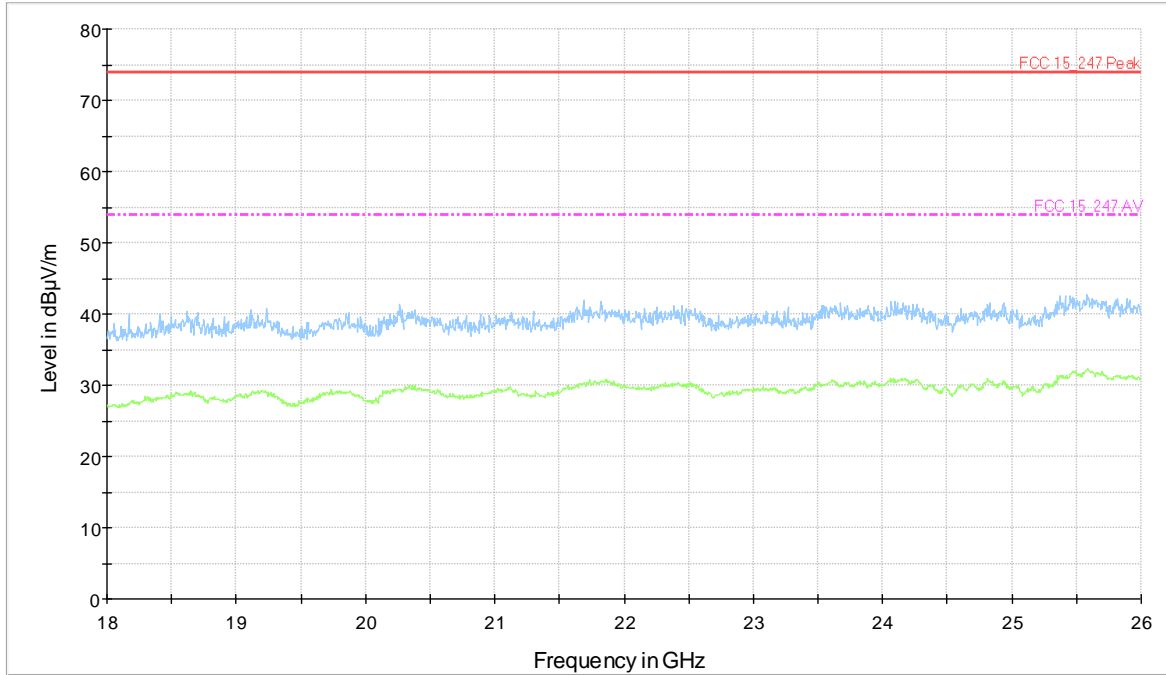



MODE	N
CHANNEL	11
FREQUENCY RANGE	30MHz – 1GHz
POLARIZATION	HORIZONTAL

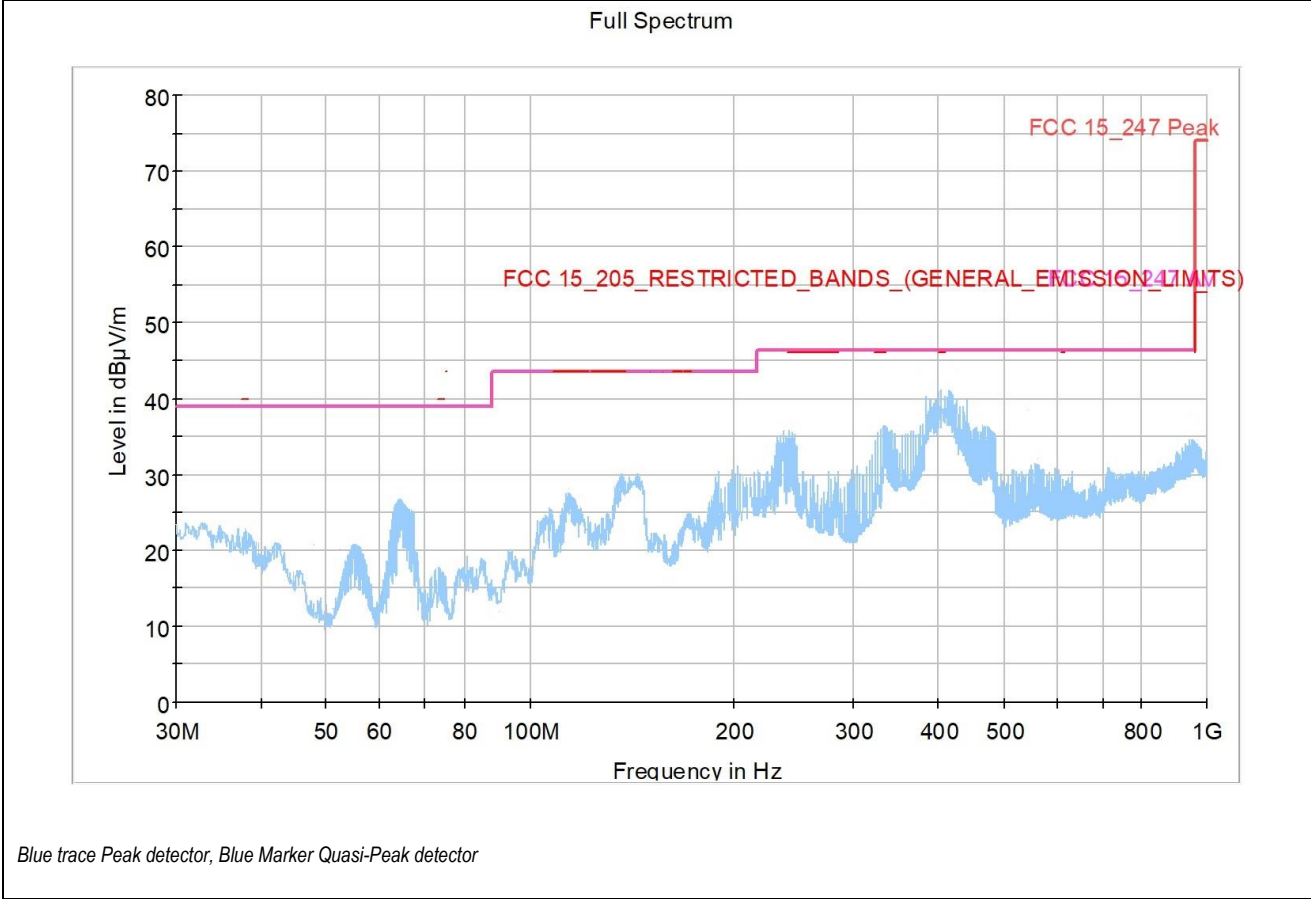

Final Result

Frequency (MHz)	MaxPeak (dBµV/m)	Limit (dBµV/m)	Margin (dB)	Height (cm)	Pol	Azimuth (deg)
---	---	---	---	---	---	---



MODE	N
CHANNEL	11
FREQUENCY RANGE	1-2.8GHz
POLARIZATION	HORIZONTAL

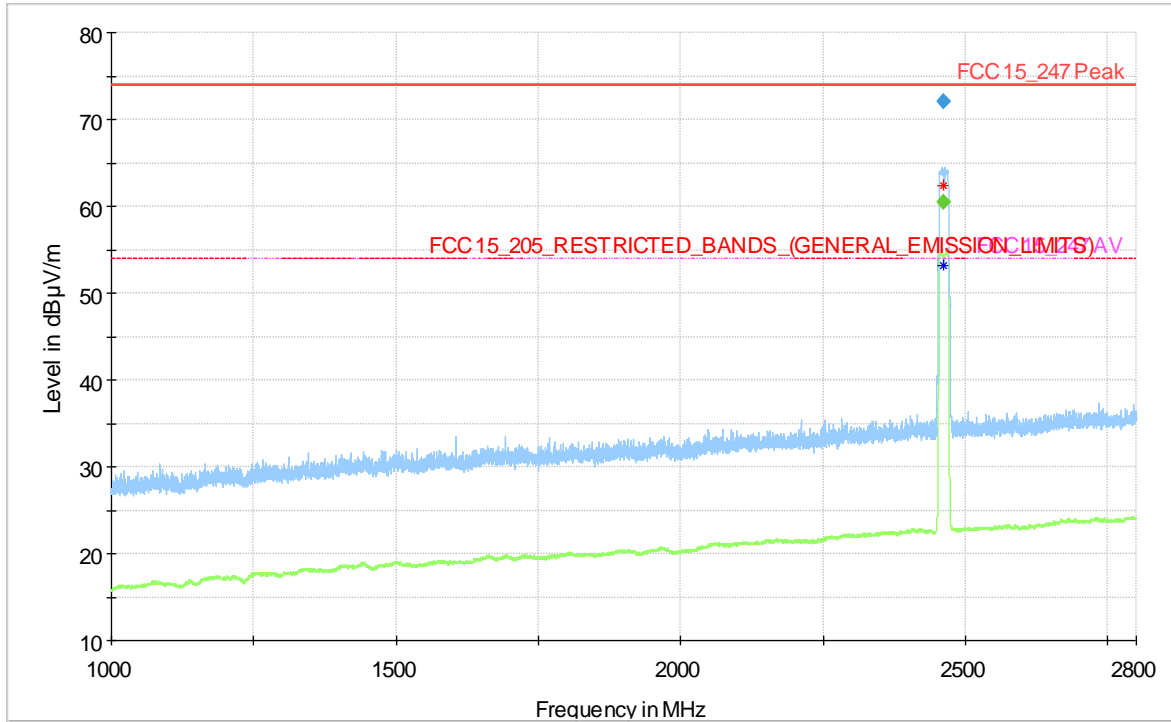

Blue trace Peak detector, Blue Marker Quasi-Peak detector; Green trace average detector, Green Marker average detector

Average Final Result

Frequency (MHz)	Average (dBµV/m)	Limit (dBµV/m)	Margin (dB)	Height (cm)	Pol	Azimuth (deg)
2462.140000	60.47	54.00	-6.47	175.0	H	207.0



MODE	N
CHANNEL	11
FREQUENCY RANGE	2.8-18GHz
POLARIZATION	HORIZONTAL

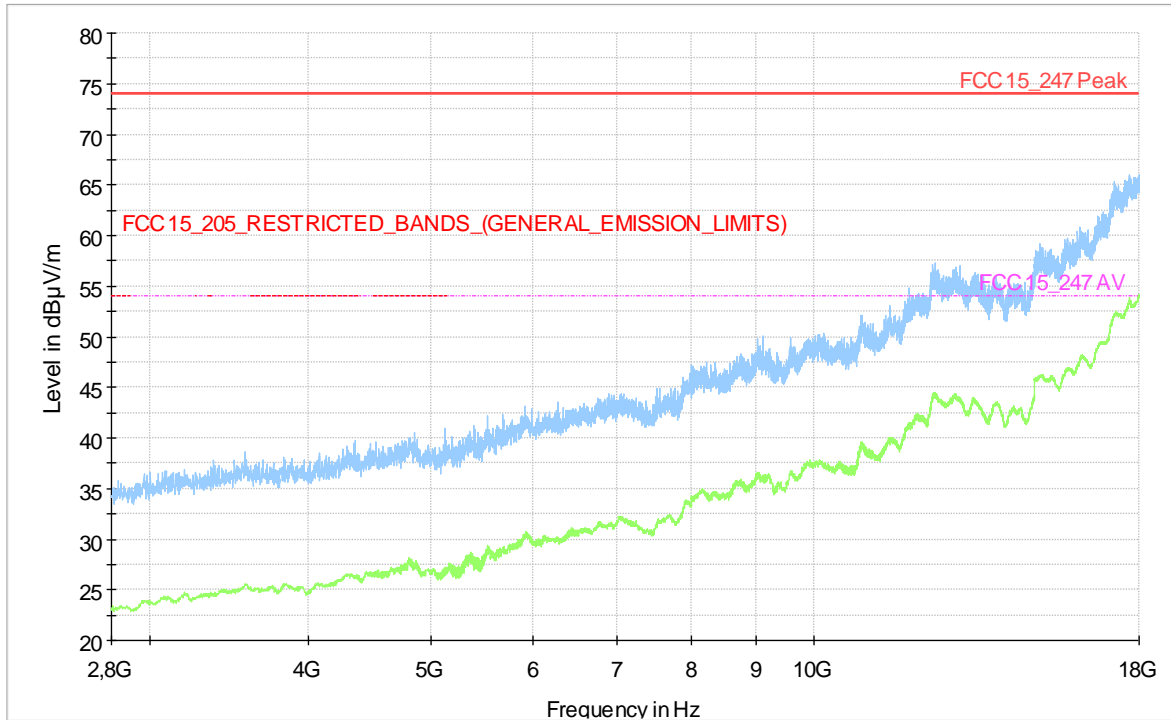

Blue trace Peak detector, Green trace average detector



MODE	N
CHANNEL	11
FREQUENCY RANGE	18-26GHz
POLARIZATION	HORIZONTAL

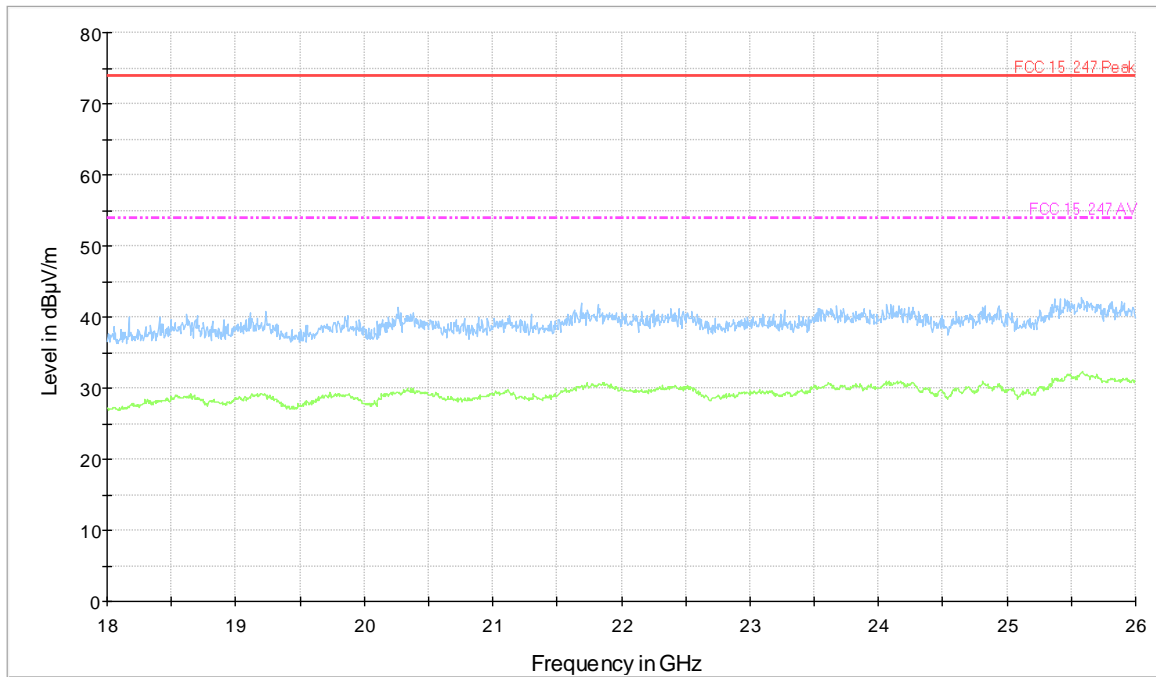

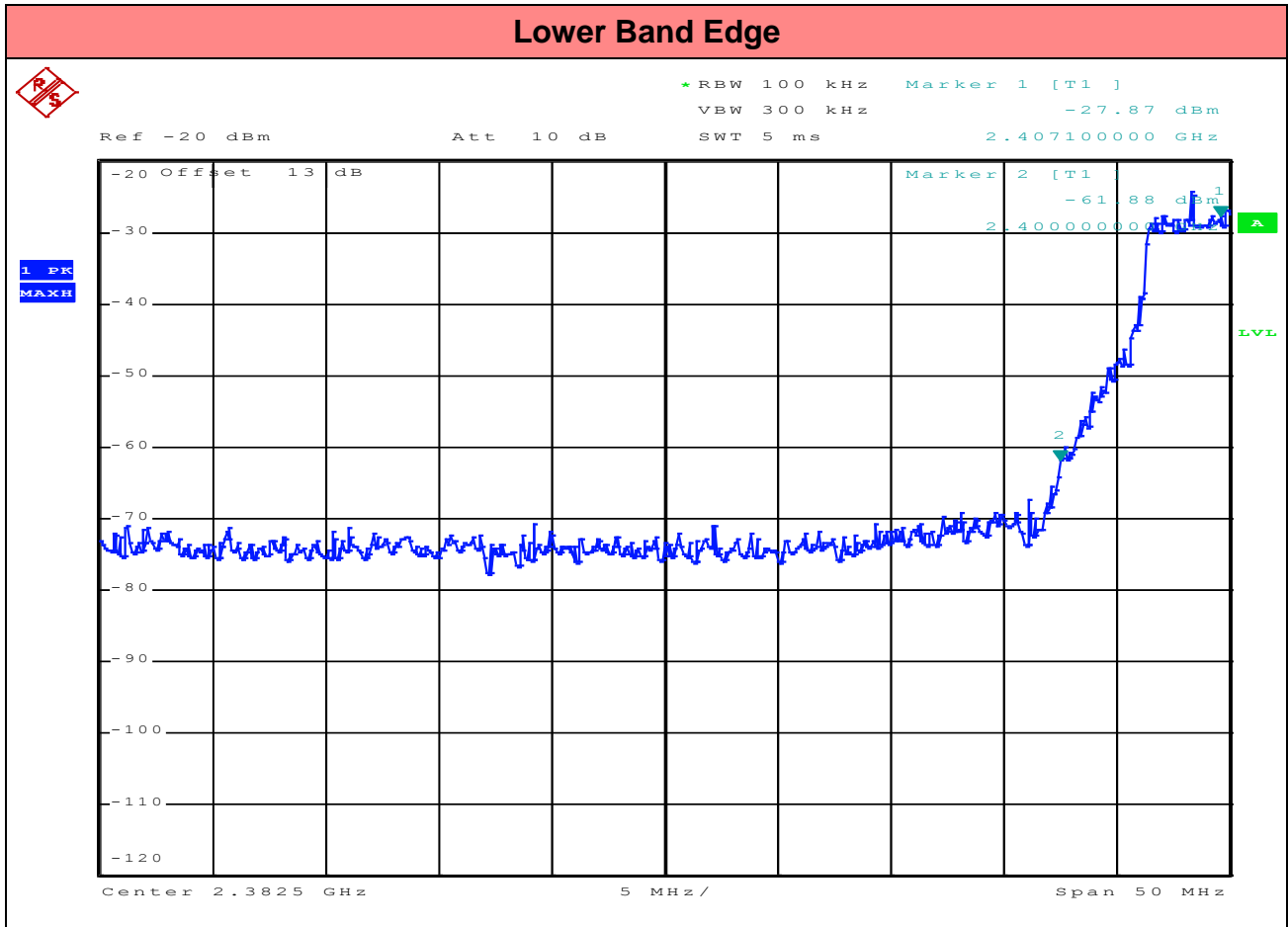
Center 2.3825 GHz5 MHz/Span 50 MHz

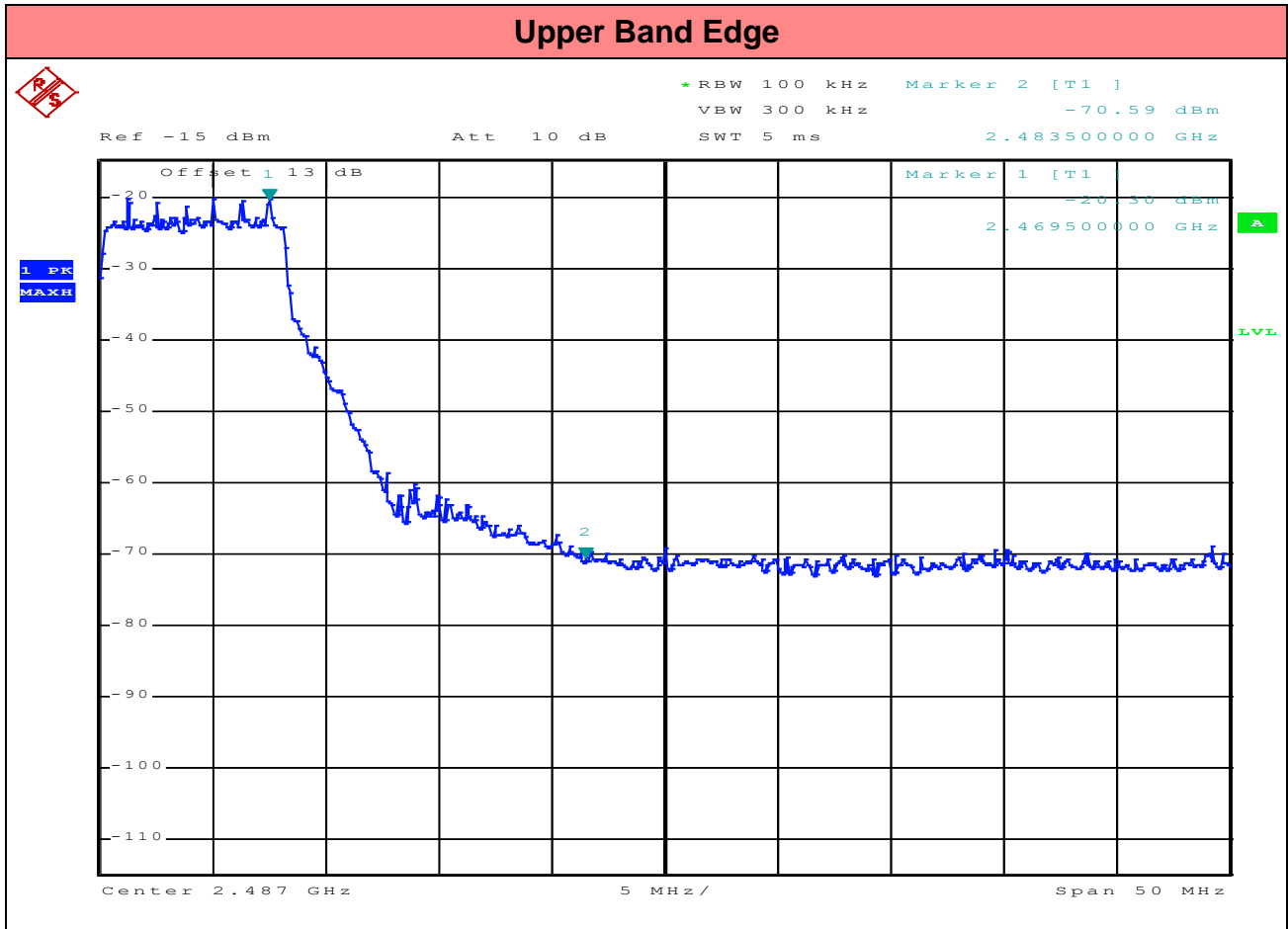

**TEST
6.**

**RADIATED EMISSIONS IN NON RESTRICTED
FREQUENCY BANDS**

**REFERENCE
DOCUMENT**

According to §15,247) d) In any 100 kHz bandwidth outside the frequency band in which the spread spectrum or digitally modulated intentional radiator is operating, the radio frequency power that is produced by the intentional radiator shall be at least 20 Db below that in the 100 kHz bandwidth within the band that contains the highest level of the desired power, based on either an RF conducted or a radiated measurement, provided the transmitter demonstrates compliance with the peak conducted power limits. If the transmitter complies with the conducted power limits based on the use of RMS averaging over a time interval, as permitted under paragraph (b)(3) of this section, the attenuation required under this paragraph shall be 30 Db instead of 20 Db. Attenuation below the general limits specified in §15.209(a) is not required. In addition, radiated emissions which fall in the restricted bands, as defined in §15.205(a), must also comply with the radiated emission limits specified in §15.209(a) (see §15.205(c)).

TEST SETUP	In according to ref std
TEST LOCATION	Semi Anechoic Chamber
TYPE OF MEASUREMENT	RADIATED
	KDB 558074 D01 par. 11.0
TEST EQUIPMENT	EMI receiver Rohde & Schwarz Mod, ESU 40 Loop Antenna R&S HFH2-Z2 Bilog Antenna CBL6111C Horn Antenna EMCO-6961 Horn Antenna with preamplifier: Schwarbeck mod BBHA 9170 Tunable notch filter Wainwright mod, WRCT2200/2500-5/40-10SK High pass filter Wainwright WHNX 2,8/18G-10SS
TEST PERFORMED BY	Giacomo Armellini
TESTING DATE	February 2017
UNCERTAINTY OF MEASURE:	Combined uncertainty = $\pm 1,75$ dB Total uncertainty = (k=2) $\pm 3,5$ dB

TEST CONDITIONS:	MEASURED
Ambient temperature : 23°C \pm 5°C	24°C
Ambient humidity : 25 - 75 %rH	45%
Pressure : 85 - 106 kPa (860 mbar - 1060 mbar)	960mbar

OPERATING CONDITION	#1, DUTY CYCLE 100%
----------------------------	---------------------

TEST RESULT	WITHIN THE LIMITS
--------------------	--------------------------



MEASUREMENT PARAMETER	
Detector:	Peak / Quasi Peak
Resolution bandwidth:	100kHz
Video bandwidth:	300 kHz
Span:	see plots
Trace-Mode:	Max. hold

TEST DESCRIPTION

Measurement is made at a semi-anechoic chamber that incorporates a turntable allowing a EUT rotation of 360°. A continuously - rotating, remotely - controlled turntable is installed at the test site to support the EUT and facilitate determination of the direction of maximum radiation for each EUT emission frequency. The EUT is placed at test table.

For emissions testing at or below 1 GHz, the table height is 80 cm above the reference ground plane. For emission measurements above 1 GHz, the table height is 1.5 m

Measurement is made with the antenna positioned in both the horizontal and vertical planes of polarization. The measurement antenna is varied in height (1m~4m) above the reference ground plane to obtain the maximum signal strength. Distance between EUT and antenna is 3m.

This investigation is performed with the EUT rotated 360°, the antenna height scanned between 1 m and 4 m, and the antenna rotated to repeat the measurements for both the horizontal and vertical antenna polarizations.

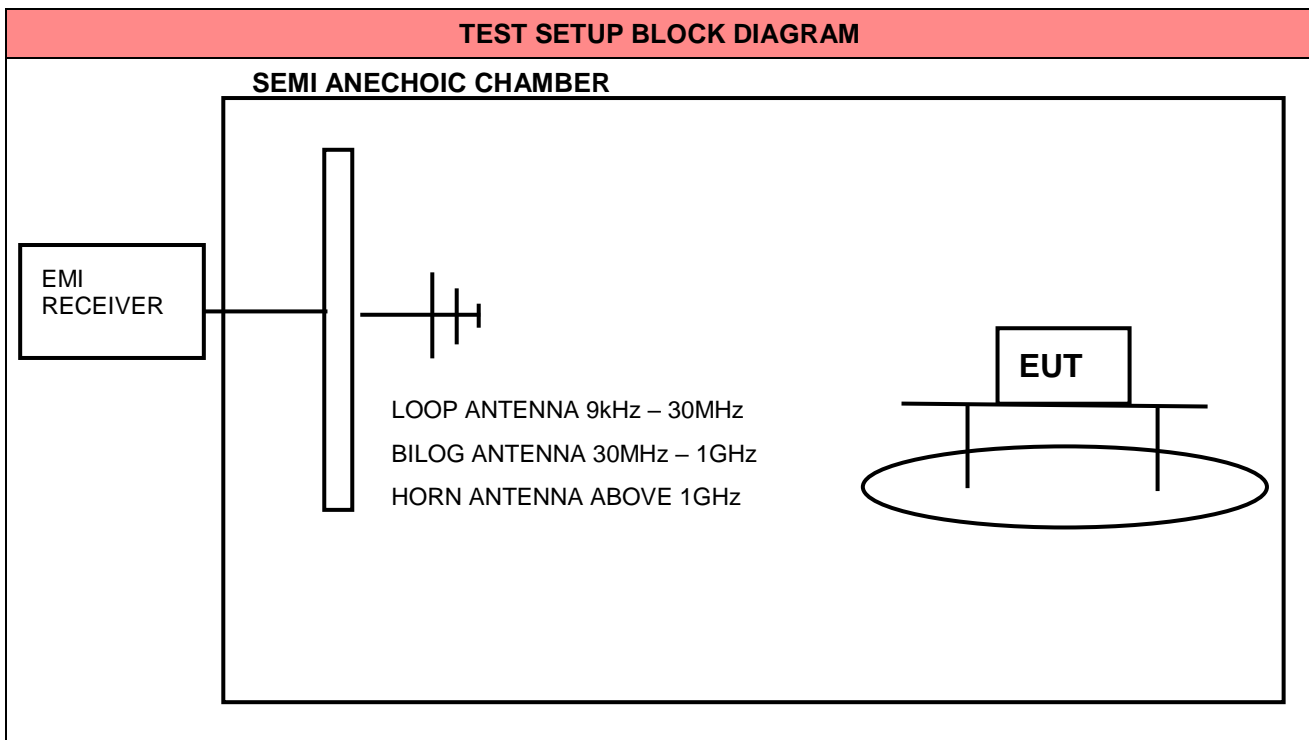



REFERENCE LEVEL MEASUREMENTS

MODE	B	MODE	B
CHANNEL	1	CHANNEL	11
REF LEVEL	80.89 dB μ V/m	REF LEVEL	85.02 dB μ V/m
SPURIOUS LEVEL	60.89 dB μ V/m	SPURIOUS LEVEL	65.02 dB μ V/m

MODE	G	MODE	G
CHANNEL	1	CHANNEL	11
REF LEVEL	79.77 dB μ V/m	REF LEVEL	84.10 dB μ V/m
SPURIOUS LEVEL	59.77 dB μ V/m	SPURIOUS LEVEL	64.10 dB μ V/m

MODE	N	MODE	N
CHANNEL	1	CHANNEL	11
REF LEVEL	80.19 dB μ V/m	REF LEVEL	83.66 dB μ V/m
SPURIOUS LEVEL	60.19 dB μ V/m	SPURIOUS LEVEL	63.66 dB μ V/m



MODE	B
CHANNEL	1
FREQUENCY RANGE	30MHz – 1GHz
POLARIZATION	VERTICAL

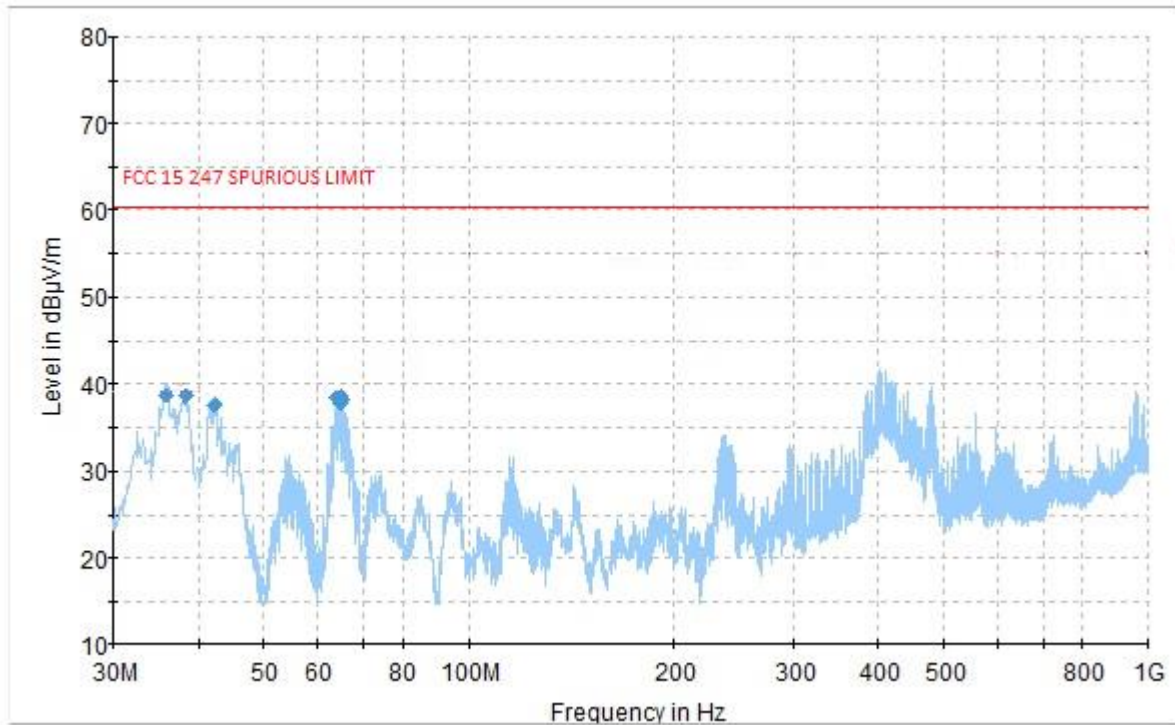

Blue trace Peak detector, Blue Marker Quasi-Peak detector

Final Result

Frequency (MHz)	QuasiPeak (dBµV/m)	Limit (dBµV/m)	Margin (dB)	Height (cm)	Pol	Azimuth (deg)
35.917000	38.72	60.89	22.17	102.0	V	-10.0
38.342000	38.63	60.89	22.26	102.0	V	45.0
42.319000	37.60	60.89	23.29	104.0	V	51.0
64.047000	38.39	60.89	22.5	112.0	V	-4.0
64.726000	37.81	60.89	23.08	123.0	V	135.0
65.114000	38.51	60.89	22.38	132.0	V	135.0
65.502000	38.22	60.89	22.67	140.0	V	159.0



MODE	B
CHANNEL	1
FREQUENCY RANGE	1-2.8GHz
POLARIZATION	VERTICAL

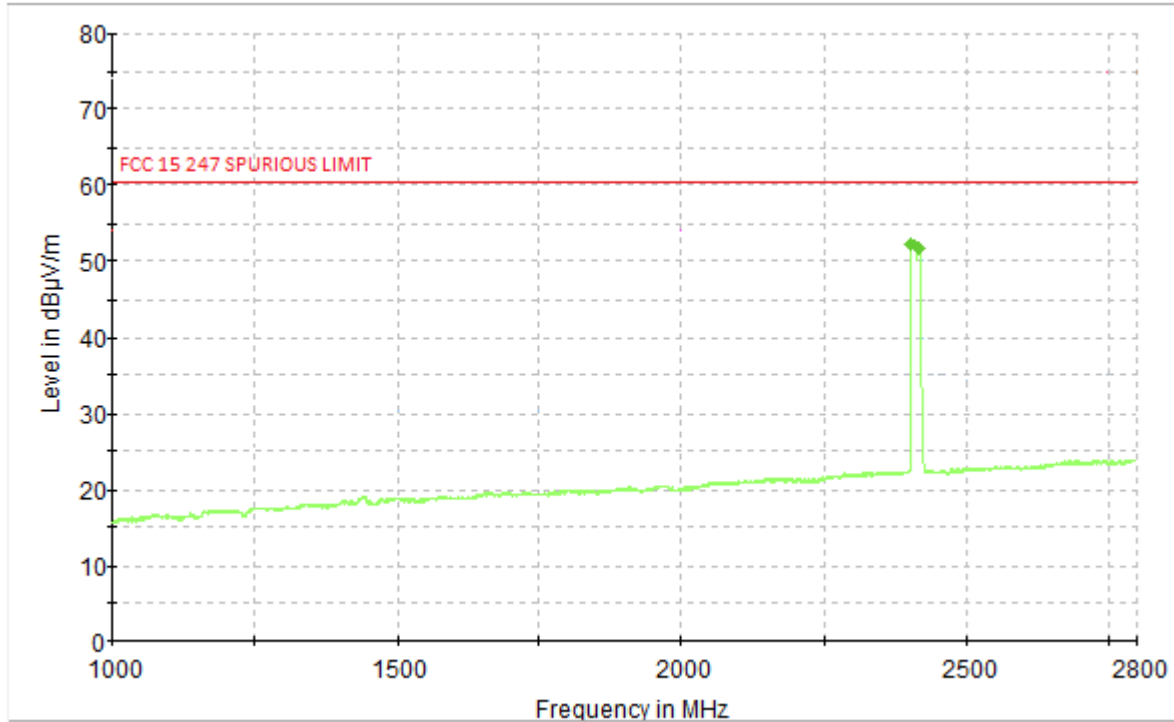

Blue trace Peak detector, Blue Marker Quasi-Peak detector; Green trace average detector, Green Marker average detector

Final_Result

Frequency (MHz)	Average (dBµV/m)	Limit (dBµV/m)	Margin (dB)	Height (cm)	Pol	Azimuth (deg)	Note
2411.920000	52.54	60.89	8.35	186.0	V	92.0	CARRIER
2411.940000	52.22	60.89	8.67	186.0	V	91.0	CARRIER
2411.950000	52.18	60.89	8.71	186.0	V	91.0	CARRIER
2411.960000	52.20	60.89	8.69	185.0	V	91.0	CARRIER
2412.000000	52.05	60.89	8.84	185.0	V	91.0	CARRIER
2412.010000	52.00	60.89	8.89	186.0	V	92.0	CARRIER



MODE	B
CHANNEL	1
FREQUENCY RANGE	2.8-18GHz
POLARIZATION	VERTICAL

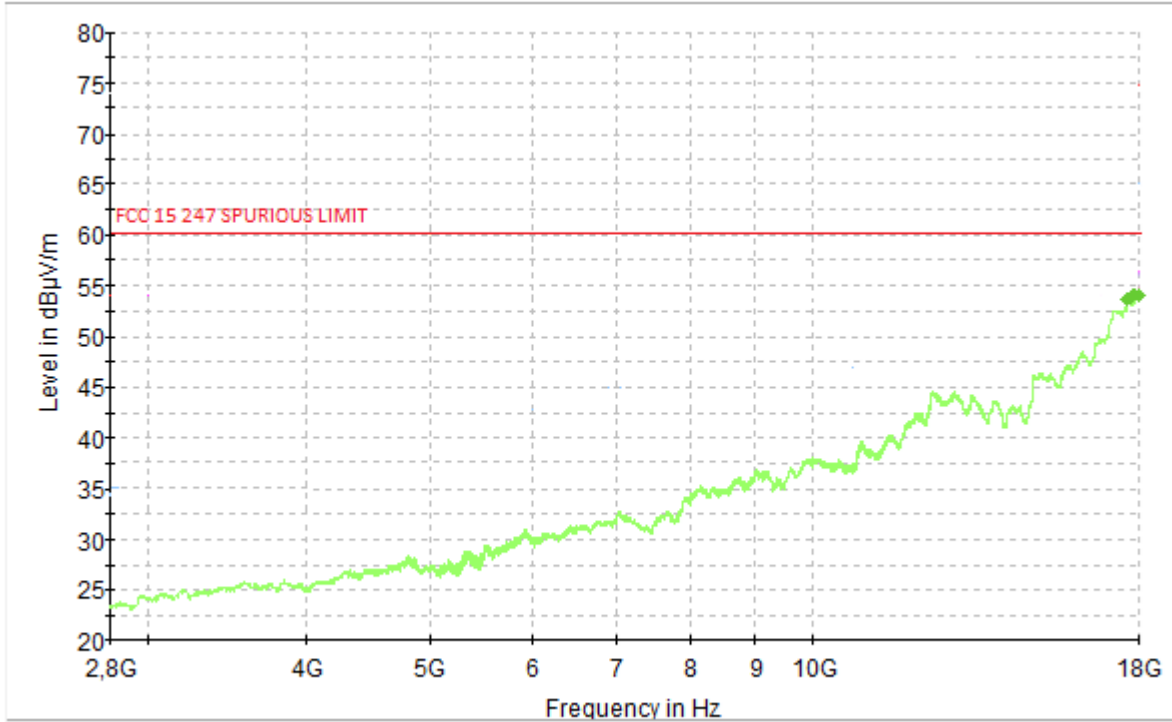

Blue trace Peak detector, Green trace average detector

Final Result

Frequency (MHz)	Average (dBµV/m)	Limit (dBµV/m)	Margin (dB)	Height (cm)	Pol	Azimuth (deg)	Note
17990.920000	53.00	60.89	7.89	187.0	V	90.0	
17991.940000	53.20	60.89	7.69	186.0	V	90.0	
17992.950000	53.40	60.89	7.59	187.0	V	90.0	
17993.960000	53.75	60.89	7.14	187.0	V	91.0	
17995.000000	53.85	60.89	7.04	187.0	V	91.0	
18000.000000	54.00	60.89	6.89	187.0	V	91.0	



MODE	B
CHANNEL	1
FREQUENCY RANGE	18-26GHz
POLARIZATION	VERTICAL

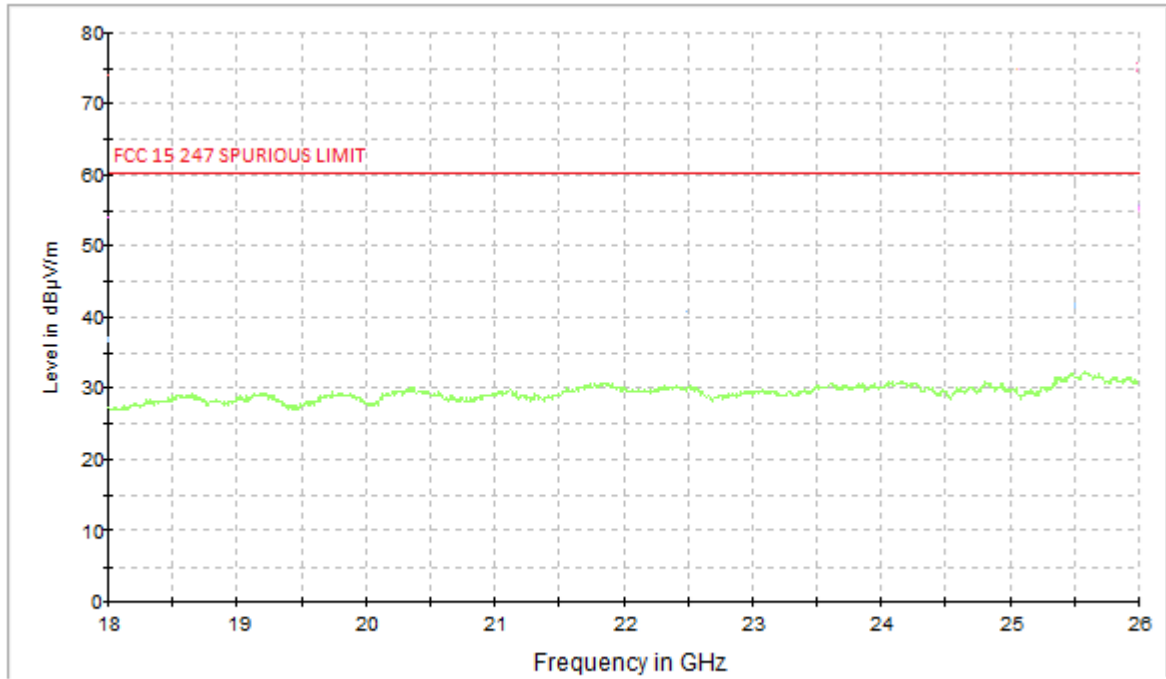



MODE	B
CHANNEL	1
FREQUENCY RANGE	30MHz – 1GHz
POLARIZATION	HORIZONTAL

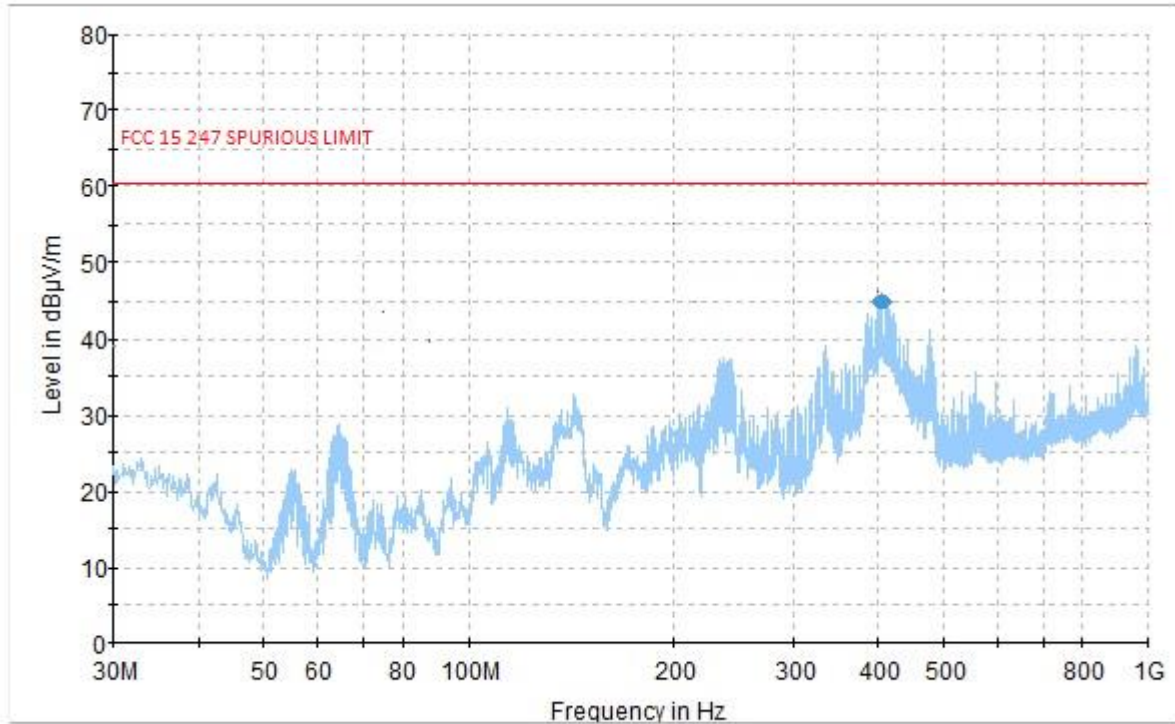

Blue trace Peak detector, Blue Marker Quasi-Peak detector

Final Result

Frequency (MHz)	MaxPeak (dBµV/m)	Limit (dBµV/m)	Margin (dB)	Height (cm)	Pol	Azimuth (deg)
403.159000	44.81	60.89	16.08	106.0	H	118.0
403.225000	44.92	60.89	5.97	106.0	H	120.0
406.360000	45.03	60.89	15.86	100.0	H	105.0
407.150000	44.91	60.89	15.98	100.0	H	105.0
408.450000	44.78	60.89	16.11	100.0	H	105.0
409.561000	44.82	60.89	16.07	100.0	H	105.0



MODE	B
CHANNEL	1
FREQUENCY RANGE	1-2.8GHz
POLARIZATION	HORIZONTAL

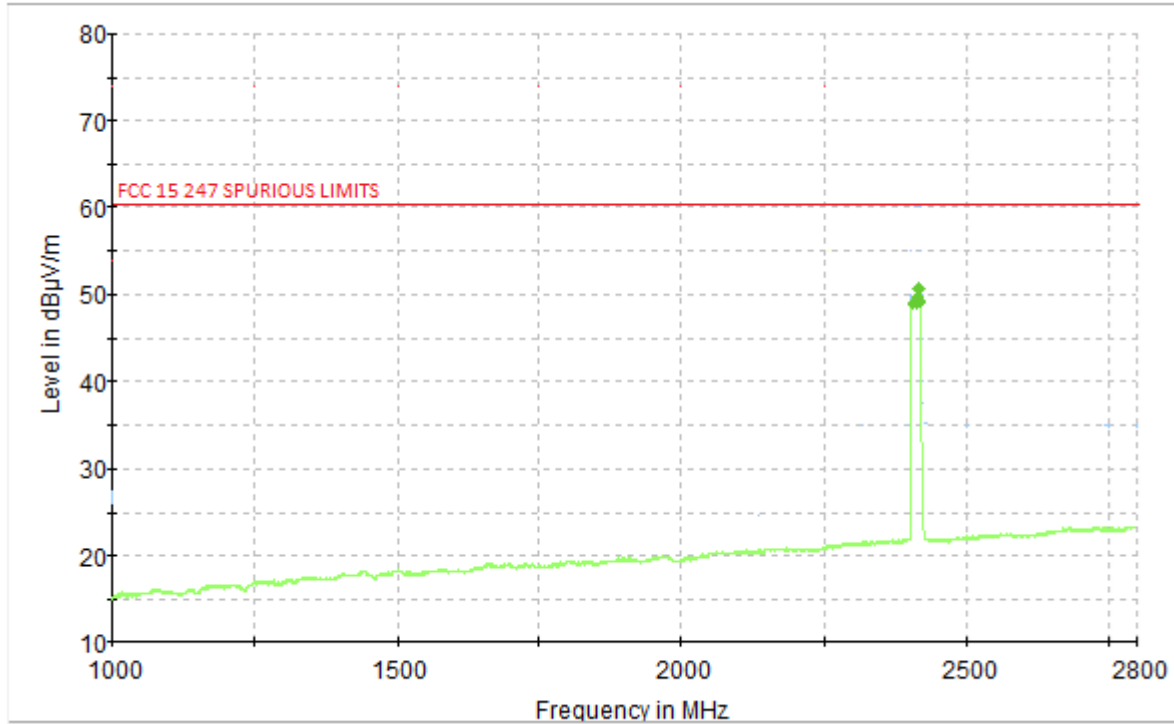

Blue trace Peak detector, Blue Marker Quasi-Peak detector; Green trace average detector, Green Marker average detector

Final_Result

Frequency (MHz)	Average (dBµV/m)	Limit (dBµV/m)	Margin (dB)	Height (cm)	Pol	Azimuth (deg)	Note
2411.920000	48.80	60.89	12.09	185.0	H	104.0	CARRIER
2411.950000	48.90	60.89	11.99	185.0	H	104.0	CARRIER
2411.960000	49.05	60.89	11.84	185.0	H	104.0	CARRIER
2411.980000	49.25	60.89	11.64	185.0	H	105.0	CARRIER
2412.010000	51.00	60.89	9.89	185.0	H	105.0	CARRIER
2412.020000	49.75	60.89	11.24	185.0	H	104.0	CARRIER



MODE	B
CHANNEL	1
FREQUENCY RANGE	2.8-18GHz
POLARIZATION	HORIZONTAL

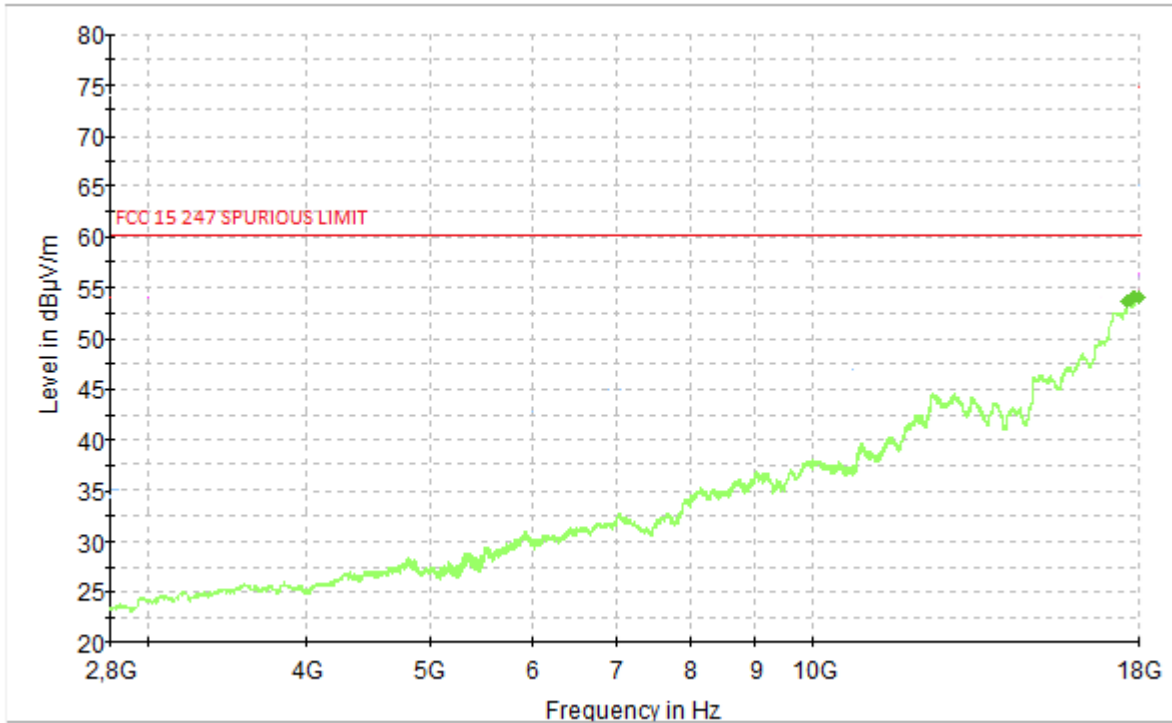

Blue trace Peak detector, Green trace average detector

Final_Result

Frequency (MHz)	Average (dBµV/m)	Limit (dBµV/m)	Margin (dB)	Height (cm)	Pol	Azimuth (deg)	Note
17990.920000	53.20	60.89	7.69	186.0	H	105.0	
17991.940000	53.30	60.89	7.59	186.0	H	105.0	
17992.950000	53.45	60.89	7.44	186.0	H	105.0	
17993.960000	53.65	60.89	7.34	186.0	H	105.0	
17995.000000	53.95	60.89	6.94	185.0	H	105.0	
18000.000000	53.85	60.89	7.04	187.0	H	105.0	



MODE	B
CHANNEL	1
FREQUENCY RANGE	18-26GHz
POLARIZATION	HORIZONTAL

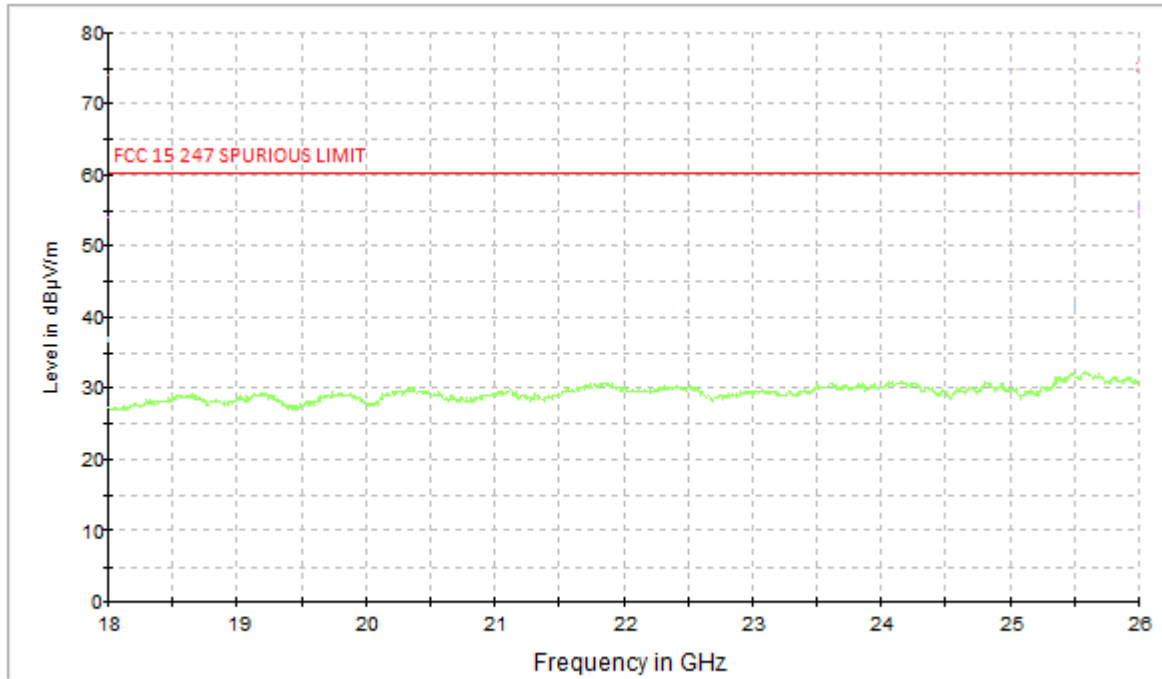



MODE	B
CHANNEL	11
FREQUENCY RANGE	30MHz – 1GHz
POLARIZATION	VERTICAL

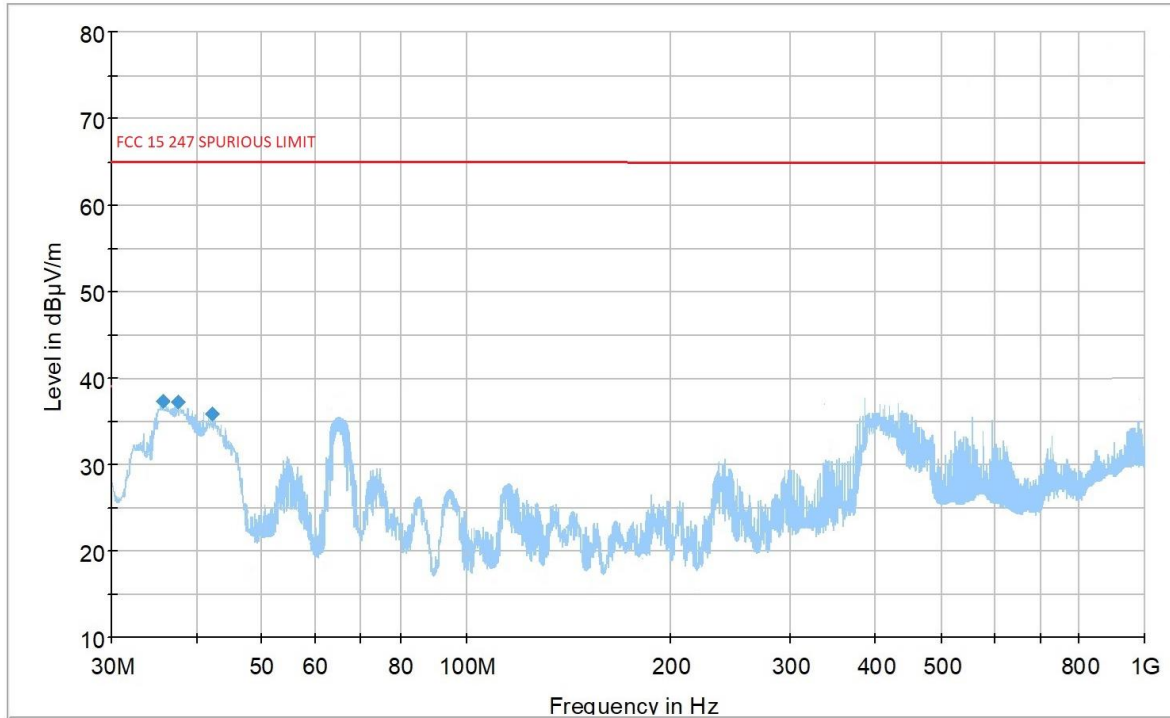

Blue trace Peak detector, Blue Marker Quasi-Peak detector

Final Result

Frequency (MHz)	QuasiPeak (dBµV/m)	Limit (dBµV/m)	Margin (dB)	Height (cm)	Pol	Azimuth (deg)
35.917000	38.11	65.02	26.91	102.0	V	-12.0
38.342000	38.05	65.02	26.97	102.0	V	42.0
42.319000	36.53	65.02	28.49	102.0	V	49.0



MODE	B
CHANNEL	11
FREQUENCY RANGE	1-2.8GHz
POLARIZATION	VERTICAL

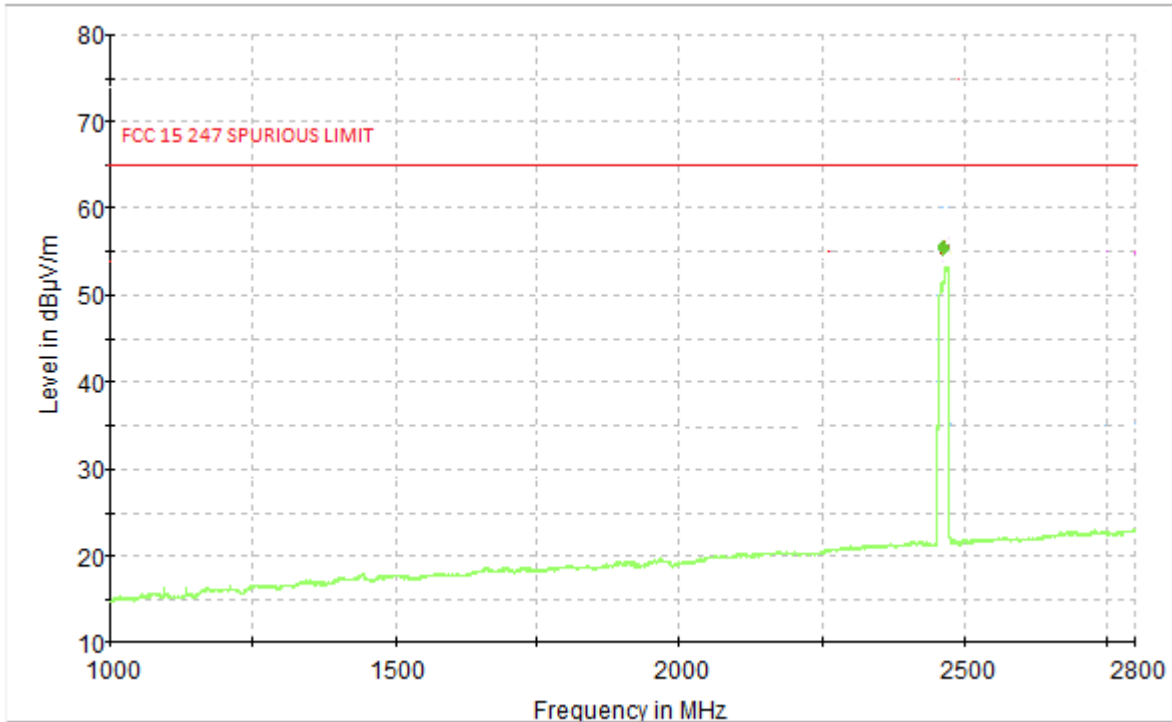

Blue trace Peak detector, Blue Marker Quasi-Peak detector; Green trace average detector, Green Marker average detector

Average Final Result

Frequency (MHz)	Average (dBµV/m)	Limit (dBµV/m)	Margin (dB)	Height (cm)	Pol	Azimuth (deg)
2461.960000	55.43	65.02	9.59	180.0	V	80.0



MODE	B
CHANNEL	11
FREQUENCY RANGE	2.8-18GHz
POLARIZATION	VERTICAL

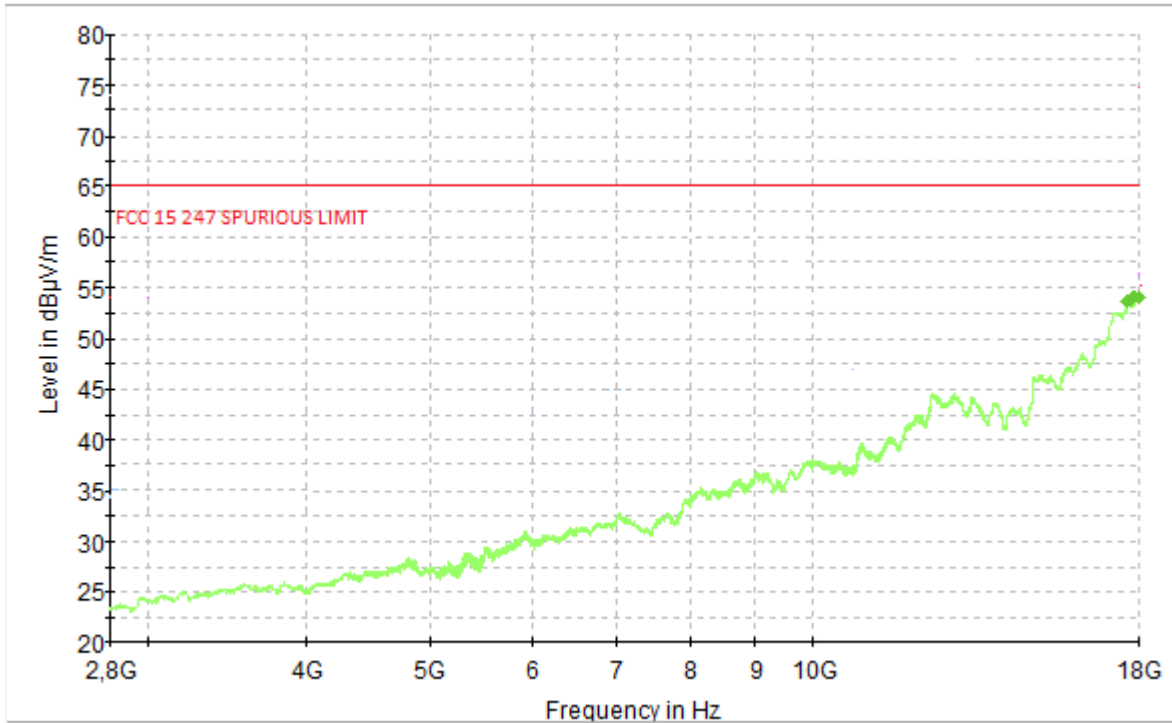

Blue trace Peak detector, Green trace average detector

Final Result

Frequency (MHz)	Average (dBµV/m)	Limit (dBµV/m)	Margin (dB)	Height (cm)	Pol	Azimuth (deg)	Note
17990.920000	53.30	65.02	11.72	183.0	V	80.0	
17991.940000	53.30	65.02	11.72	183.0	V	80.0	
17992.950000	53.35	65.02	11.67	183.0	V	80.0	
17993.960000	53.45	65.02	11.57	183.0	V	82.0	
17995.000000	53.75	65.02	11.27	183.0	V	82.0	
18000.000000	53.75	65.02	11.27	183.0	V	82.0	



MODE	B
CHANNEL	11
FREQUENCY RANGE	18-26GHz
POLARIZATION	VERTICAL

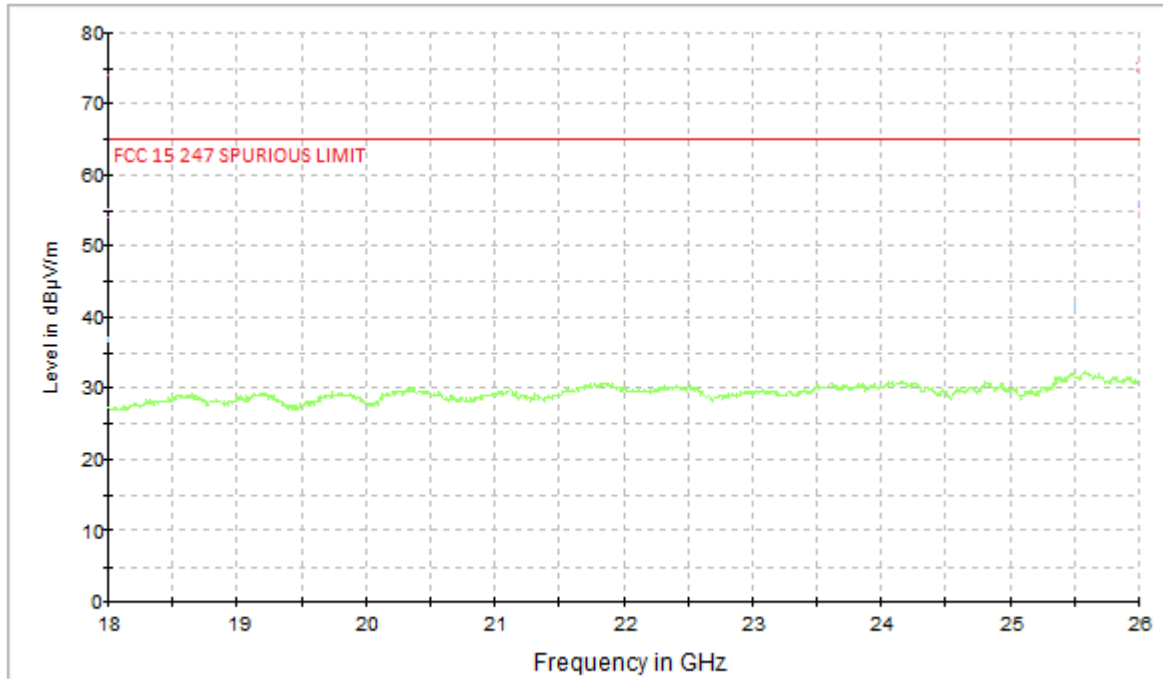



MODE	B
CHANNEL	11
FREQUENCY RANGE	30MHz – 1GHz
POLARIZATION	HORIZONTAL

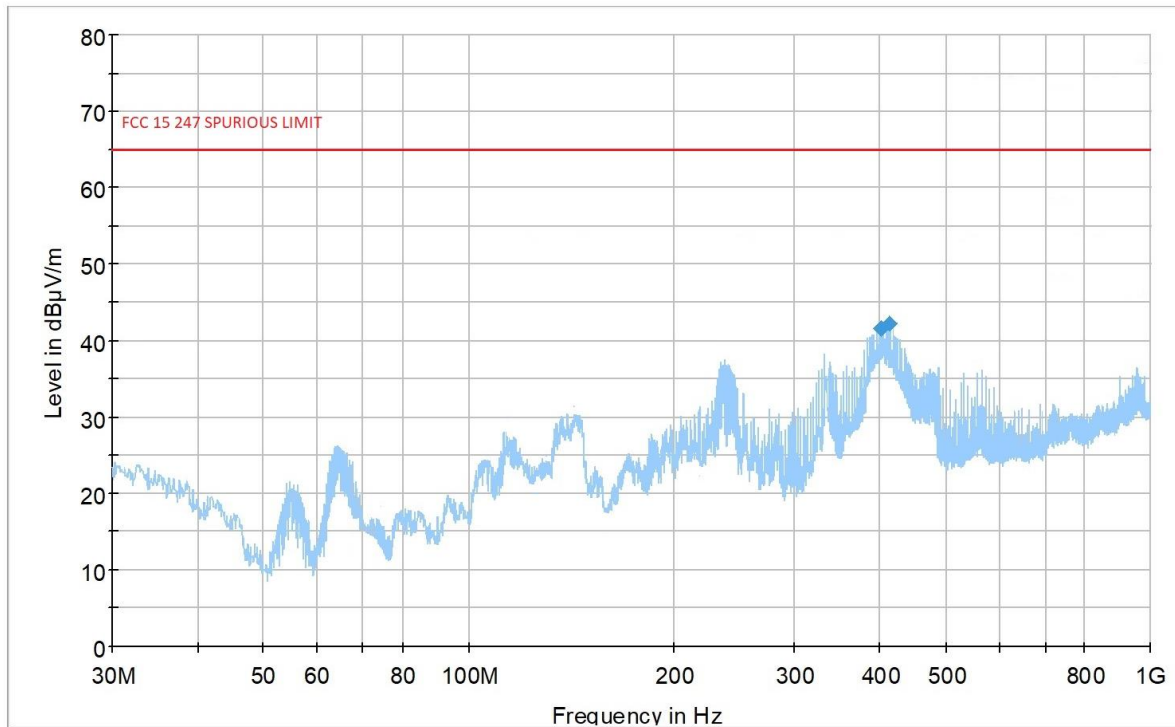

Blue trace Peak detector, Blue Marker Quasi-Peak detector

Final Result

Frequency (MHz)	MaxPeak (dBµV/m)	Limit (dBµV/m)	Margin (dB)	Height (cm)	Pol	Azimuth (deg)
403.159000	42.75	65.02	22.27	104.0	H	120.0
406.360000	44.22	65.02	20.80	103.0	H	108.0



MODE	B
CHANNEL	11
FREQUENCY RANGE	1-2.8GHz
POLARIZATION	HORIZONTAL

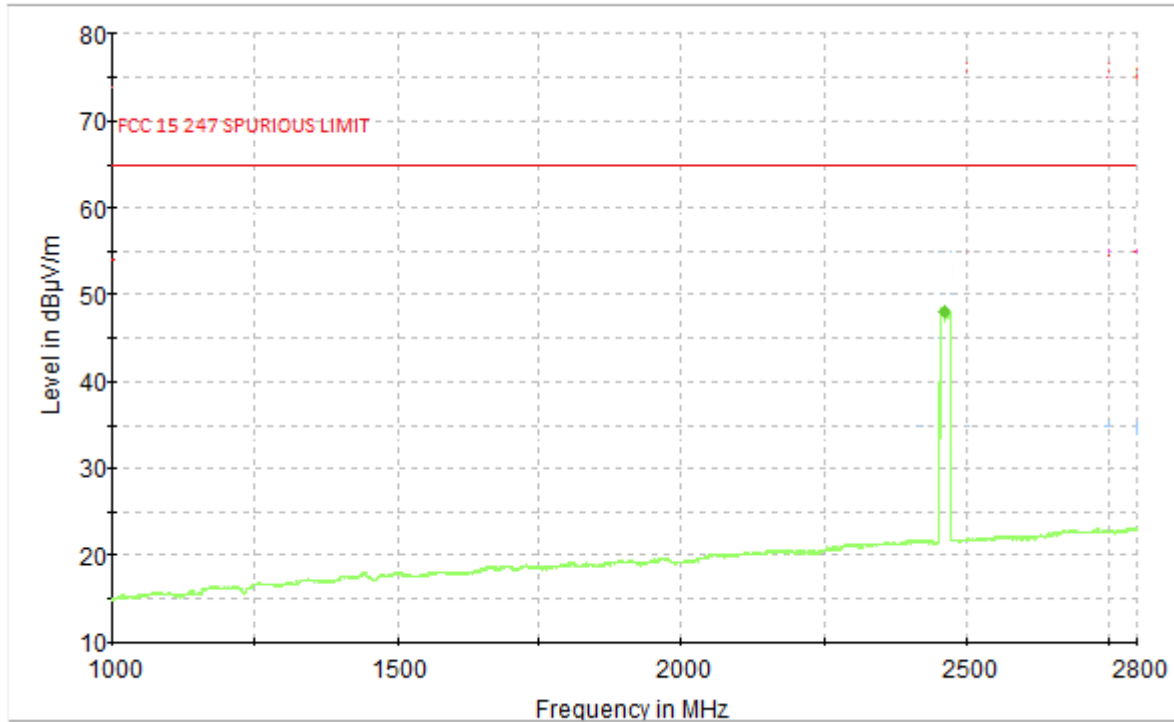

Blue trace Peak detector, Blue Marker Quasi-Peak detector; Green trace average detector, Green Marker average detector

Average Final Result

Frequency (MHz)	Average (dBµV/m)	Limit (dBµV/m)	Margin (dB)	Height (cm)	Pol	Azimuth (deg)
2462.320000	47.97	65.02	17.05	111.0	H	-10.0



MODE	B
CHANNEL	11
FREQUENCY RANGE	2.8-18GHz
POLARIZATION	HORIZONTAL

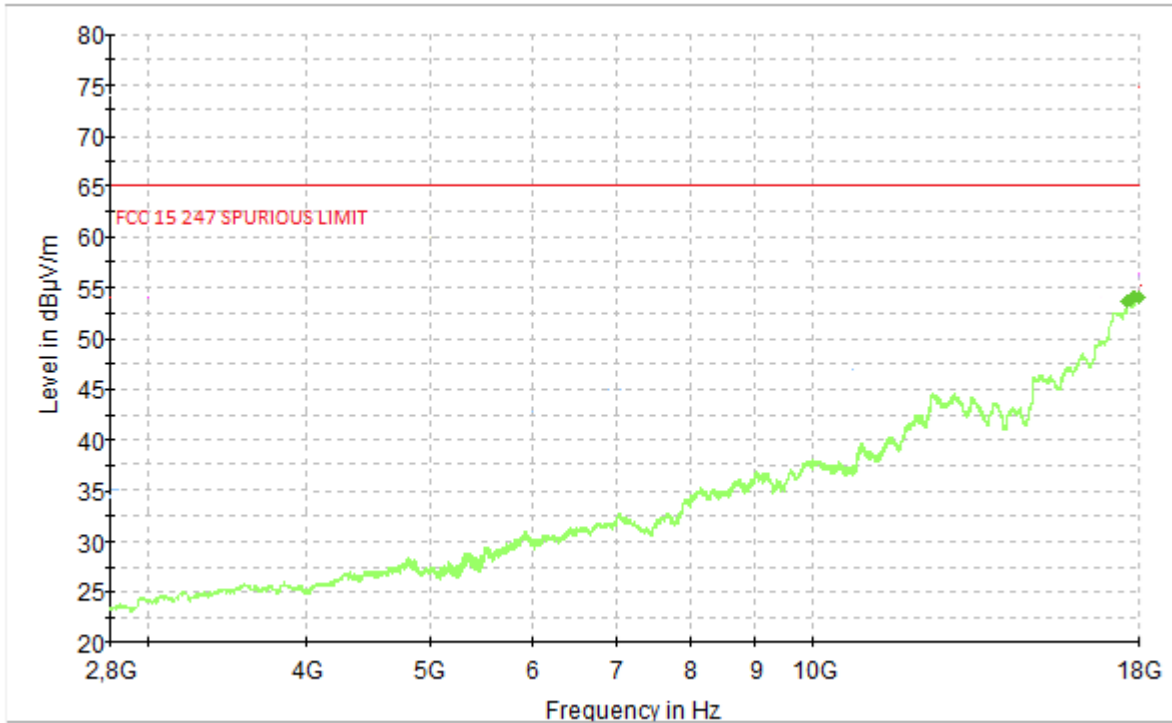

Blue trace Peak detector, Green trace average detector

Final Result

Frequency (MHz)	Average (dBµV/m)	Limit (dBµV/m)	Margin (dB)	Height (cm)	Pol	Azimuth (deg)	Note
17990.920000	53.20	65.02	11.82	186.0	H	105.0	
17991.940000	53.30	65.02	11.72	186.0	H	105.0	
17992.950000	53.45	65.02	11.57	186.0	H	105.0	
17993.960000	53.65	65.02	11.37	186.0	H	105.0	
17995.000000	53.95	65.02	11.07	185.0	H	105.0	
18000.000000	53.85	65.02	11.17	187.0	H	105.0	



MODE	B
CHANNEL	11
FREQUENCY RANGE	18-26GHz
POLARIZATION	HORIZONTAL

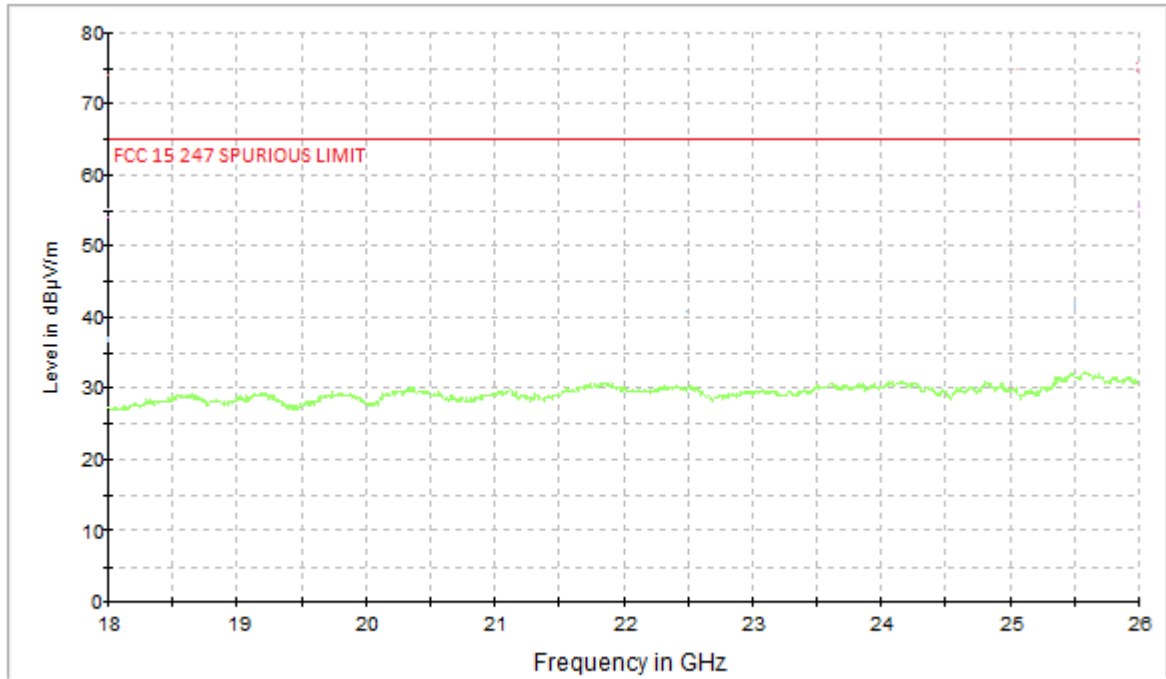



MODE	G
CHANNEL	1
FREQUENCY RANGE	30MHz – 1GHz
POLARIZATION	VERTICAL

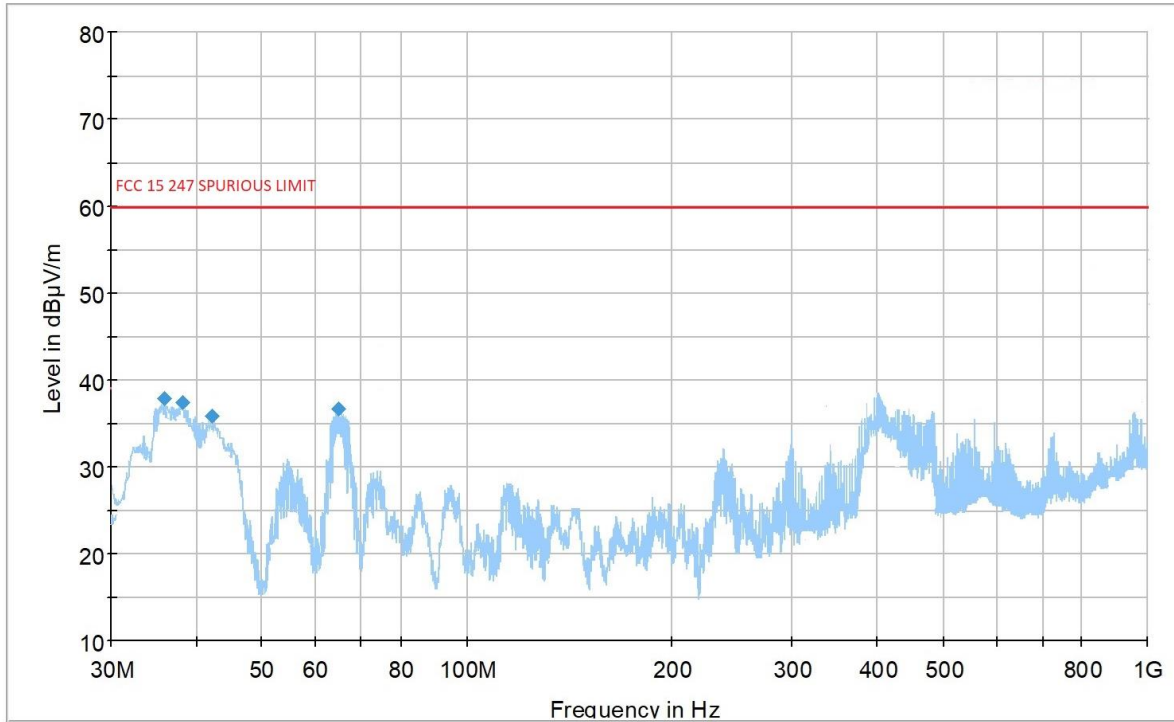

Blue trace Peak detector, Blue Marker Quasi-Peak detector

Final Result

Frequency (MHz)	QuasiPeak (dBµV/m)	Limit (dBµV/m)	Margin (dB)	Height (cm)	Pol	Azimuth (deg)
35.917000	38.05	59.77	21.72	102.0	V	-10.0
38.342000	37.55	59.77	22.22	102.0	V	45.0
42.319000	36.21	59.77	23.56	103.0	V	48.0
64.047000	37.44	59.77	22.33	107.0	V	-5.0



MODE	G
CHANNEL	1
FREQUENCY RANGE	1-2.8GHz
POLARIZATION	VERTICAL

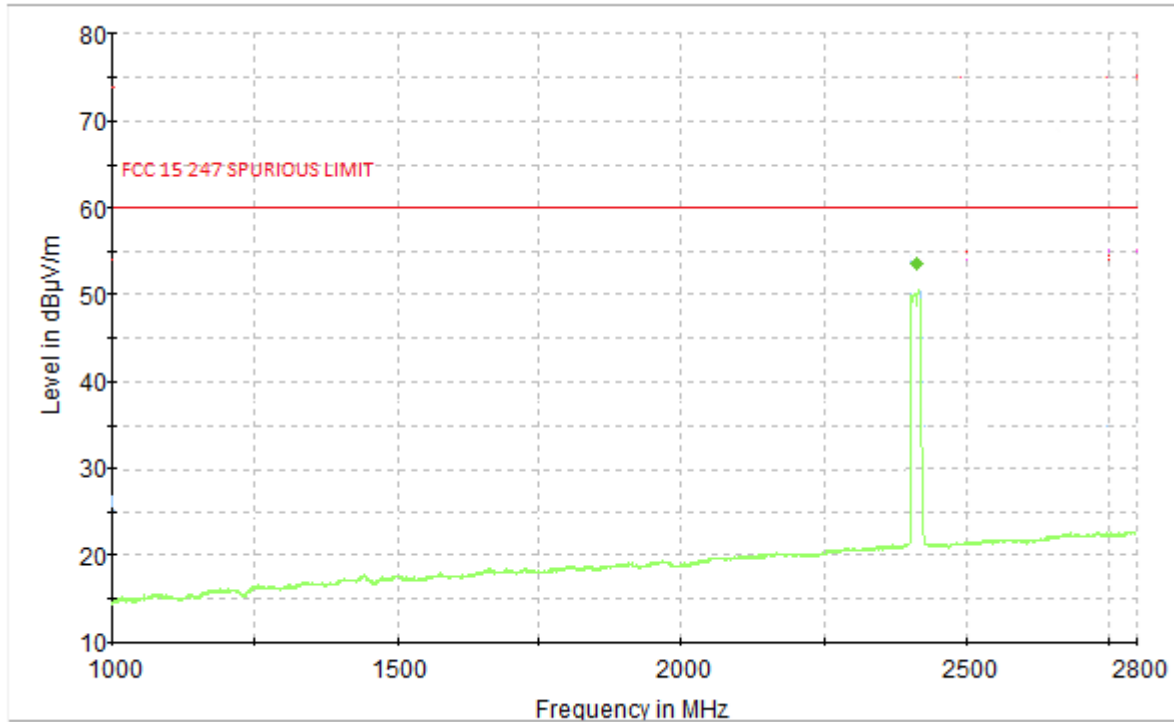

Blue trace Peak detector, Blue Marker Quasi-Peak detector; Green trace average detector, Green Marker average detector

Average Final Result

Frequency (MHz)	Average (dBµV/m)	Limit (dBµV/m)	Margin (dB)	Height (cm)	Pol	Azimuth (deg)
2412.100000	53.44	59.77	6.33	184.0	V	81.0



MODE	G
CHANNEL	1
FREQUENCY RANGE	2.8-18GHz
POLARIZATION	VERTICAL

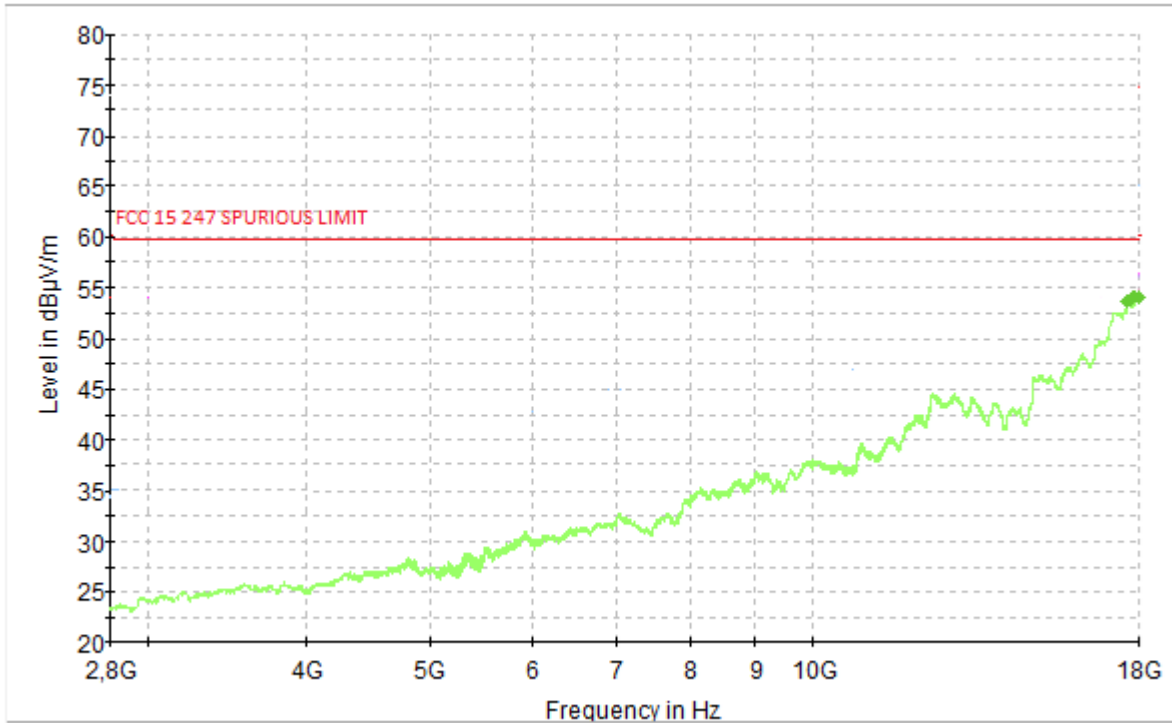

Blue trace Peak detector, Green trace average detector

Final_Result

Frequency (MHz)	Average (dBµV/m)	Limit (dBµV/m)	Margin (dB)	Height (cm)	Pol	Azimuth (deg)	Note
17990.920000	53.00	59.77	6.77	187.0	V	90.0	
17991.940000	53.20	59.77	6.57	186.0	V	90.0	
17992.950000	53.40	59.77	6.37	187.0	V	90.0	
17993.960000	53.75	59.77	6.02	187.0	V	91.0	
17995.000000	53.85	59.77	5.92	187.0	V	91.0	
18000.000000	54.00	59.77	5.77	187.0	V	91.0	



MODE	G
CHANNEL	1
FREQUENCY RANGE	18-26GHz
POLARIZATION	VERTICAL

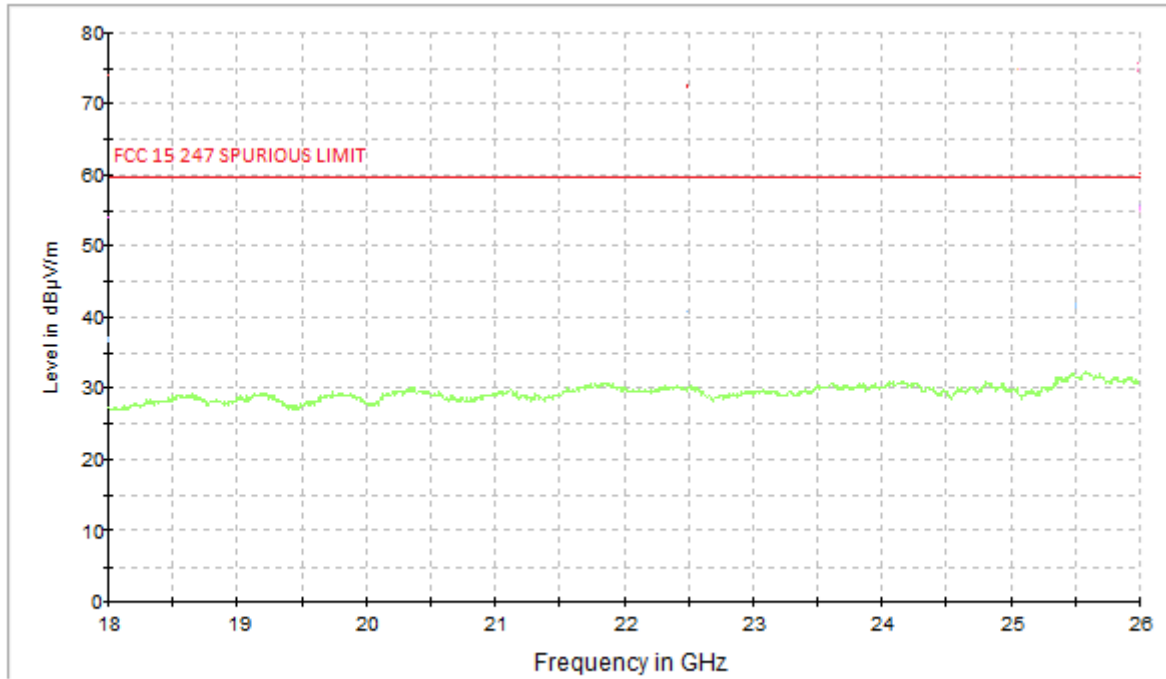



MODE	G
CHANNEL	1
FREQUENCY RANGE	30MHz – 1GHz
POLARIZATION	HORIZONTAL

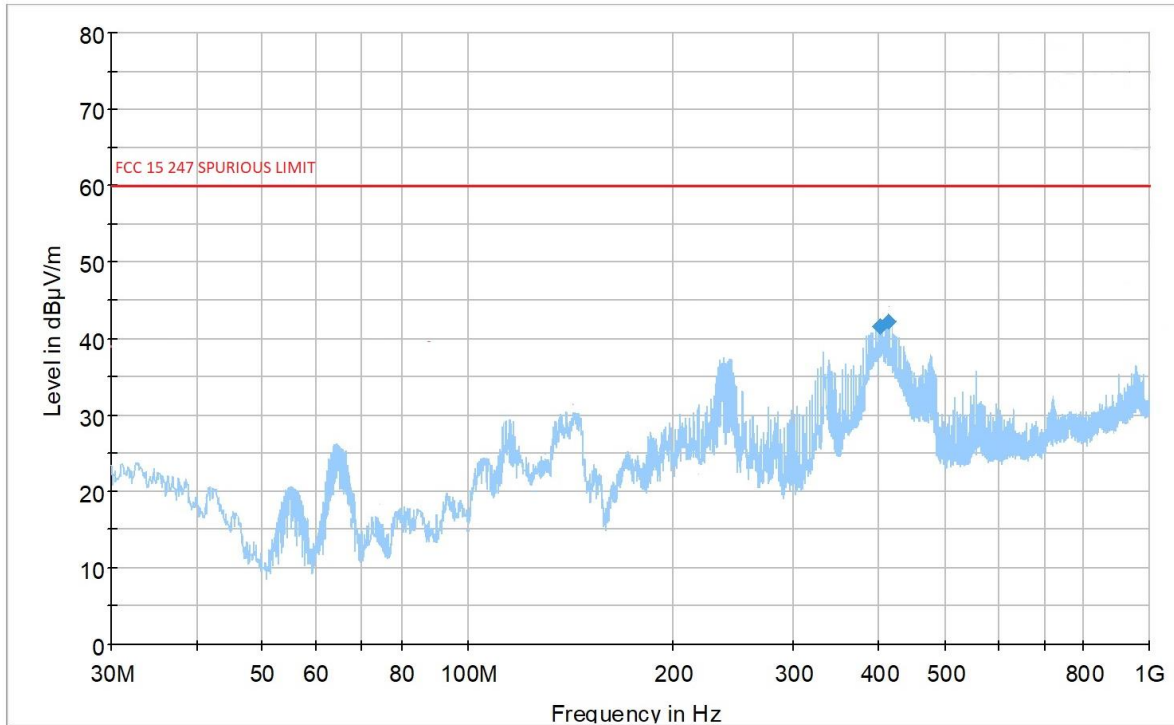

Blue trace Peak detector, Blue Marker Quasi-Peak detector

Final Result

Frequency (MHz)	MaxPeak (dBµV/m)	Limit (dBµV/m)	Margin (dB)	Height (cm)	Pol	Azimuth (deg)
403.159000	41.11	59.77	18.66	105.0	H	120.0
406.360000	42.53	59.77	17.24	104.0	H	103.0



MODE	G
CHANNEL	1
FREQUENCY RANGE	1-2.8GHz
POLARIZATION	HORIZONTAL

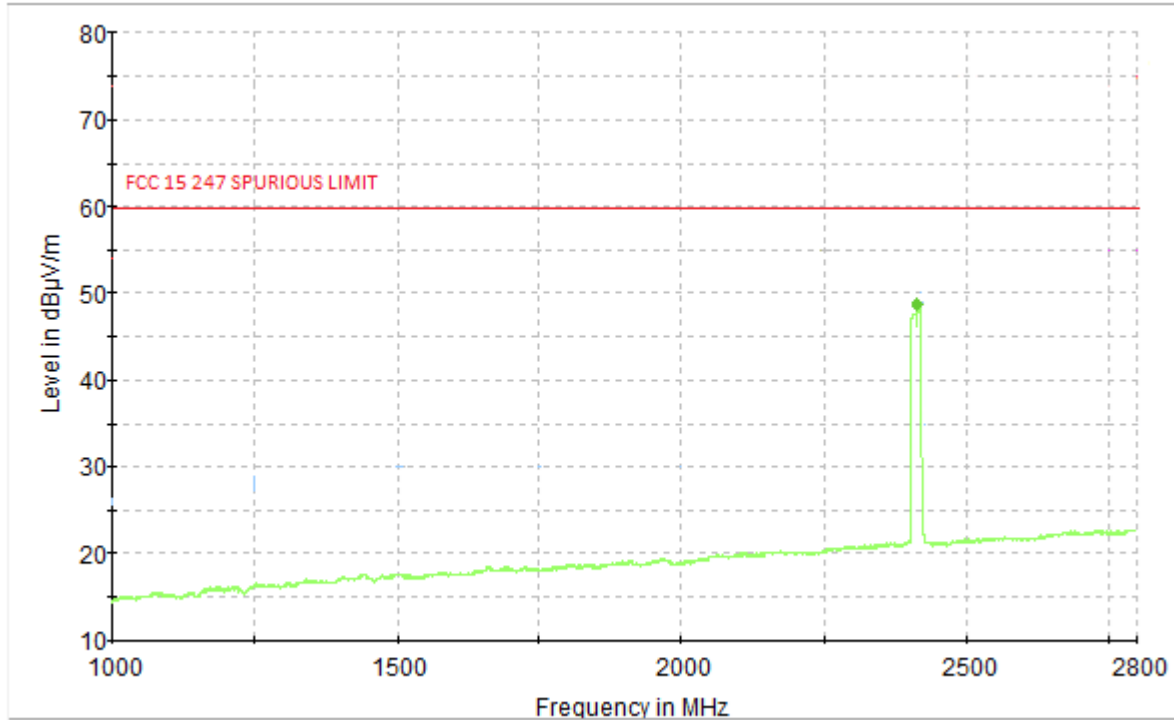

Blue trace Peak detector, Blue Marker Quasi-Peak detector; Green trace average detector, Green Marker average detector

Average Final Result

Frequency (MHz)	Average (dBµV/m)	Limit (dBµV/m)	Margin (dB)	Height (cm)	Pol	Azimuth (deg)
2412.100000	48.72	59.77	11.05	100.0	H	37.0



MODE	G
CHANNEL	1
FREQUENCY RANGE	2.8-18GHz
POLARIZATION	HORIZONTAL

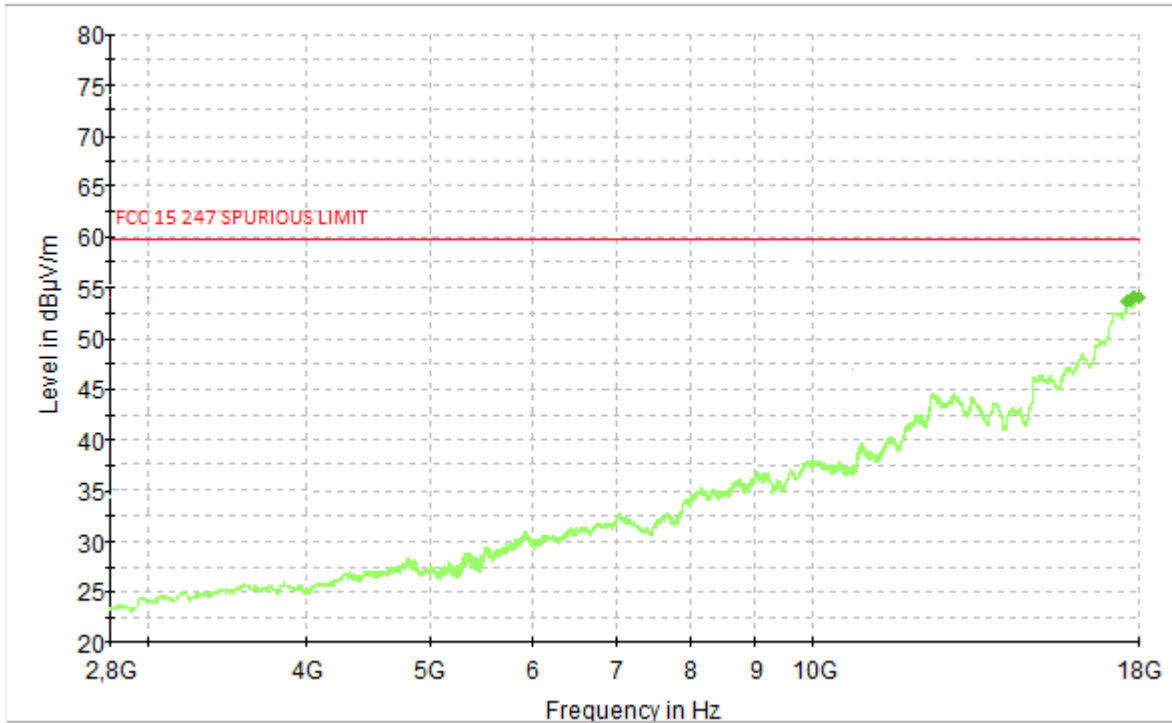

Blue trace Peak detector, Green trace average detector



MODE	G
CHANNEL	1
FREQUENCY RANGE	18-26GHz
POLARIZATION	HORIZONTAL

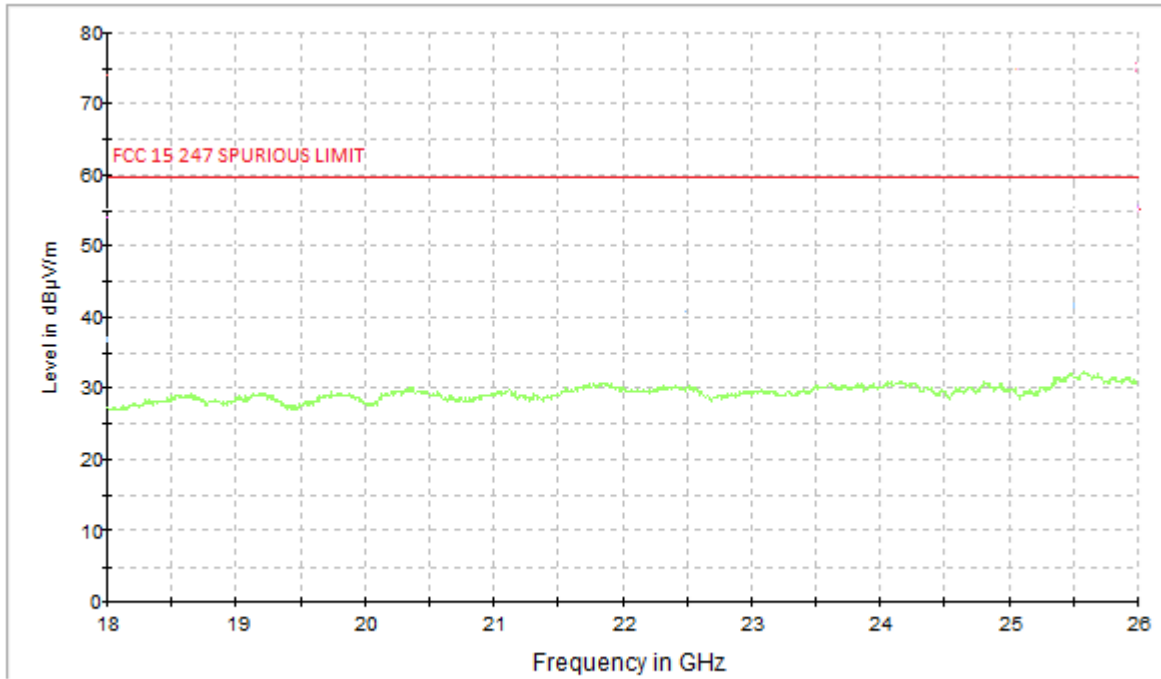



MODE	G
CHANNEL	11
FREQUENCY RANGE	30MHz – 1GHz
POLARIZATION	VERTICAL

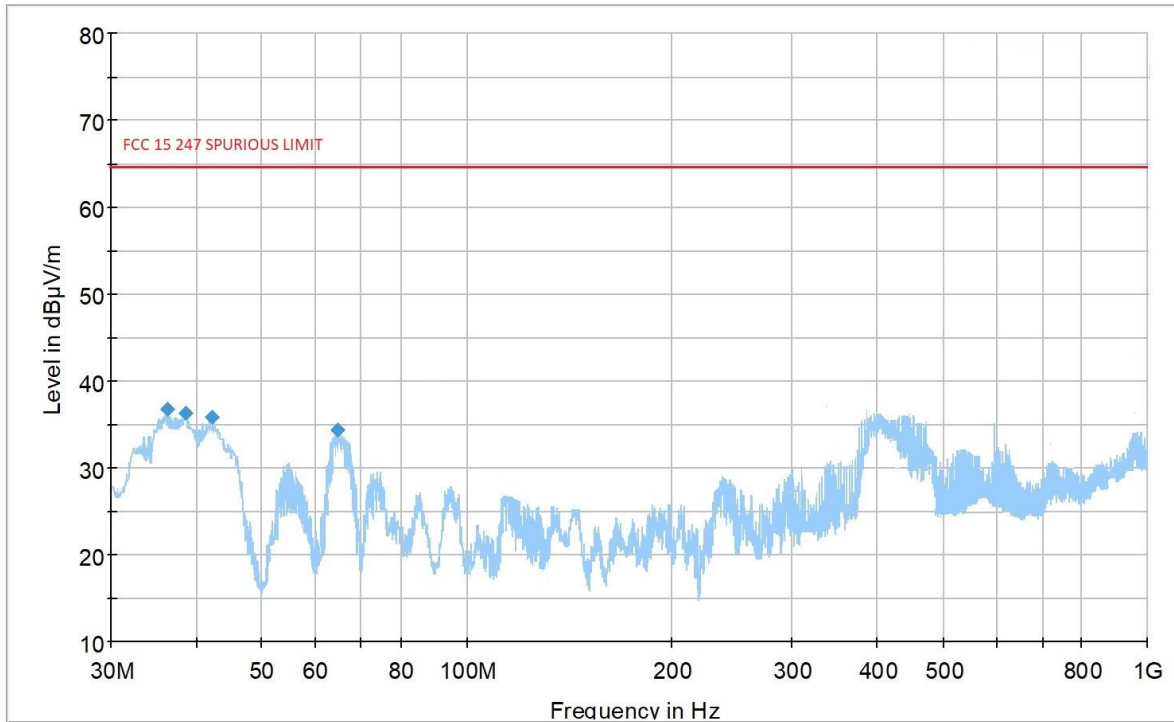

Blue trace Peak detector, Blue Marker Quasi-Peak detector

Final Result

Frequency (MHz)	QuasiPeak (dBµV/m)	Limit (dBµV/m)	Margin (dB)	Height (cm)	Pol	Azimuth (deg)
35.917000	37.60	64.10	26.50	104.0	V	-8.0
38.342000	36.68	64.10	27.42	103.0	V	46.0
42.319000	36.12	64.10	27.98	105.0	V	48.0
64.047000	34.36	64.10	29.74	110.0	V	-6.0



MODE	G
CHANNEL	11
FREQUENCY RANGE	1-2.8GHz
POLARIZATION	VERTICAL

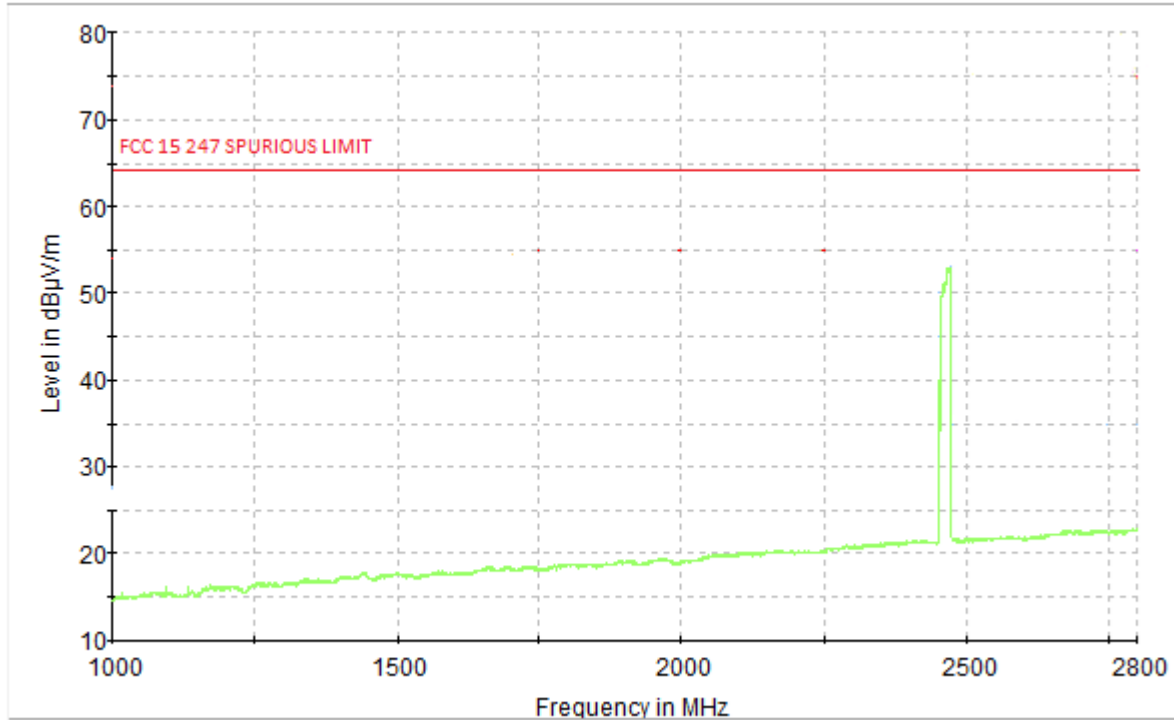

Blue trace Peak detector, Blue Marker Quasi-Peak detector; Green trace average detector, Green Marker average detector



MODE	G
CHANNEL	11
FREQUENCY RANGE	2.8-18GHz
POLARIZATION	VERTICAL

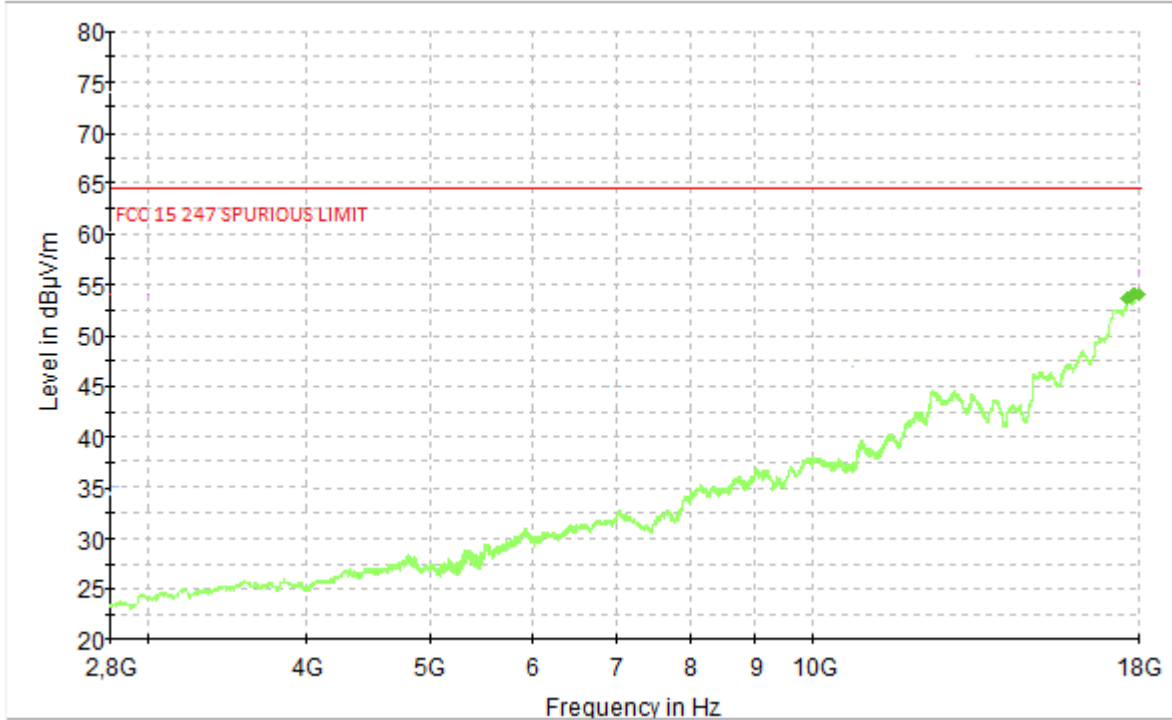

Blue trace Peak detector, Green trace average detector

Final Result

Frequency (MHz)	Average (dBµV/m)	Limit (dBµV/m)	Margin (dB)	Height (cm)	Pol	Azimuth (deg)	Note
17990.920000	53.00	64.10	11.10	187.0	V	90.0	
17991.940000	53.20	64.10	10.90	186.0	V	90.0	
17992.950000	53.40	64.10	10.70	187.0	V	90.0	
17993.960000	53.75	64.10	10.35	187.0	V	91.0	
17995.000000	53.85	64.10	10.25	187.0	V	91.0	
18000.000000	54.00	64.10	10.10	187.0	V	91.0	



MODE	G
CHANNEL	11
FREQUENCY RANGE	18-26GHz
POLARIZATION	VERTICAL

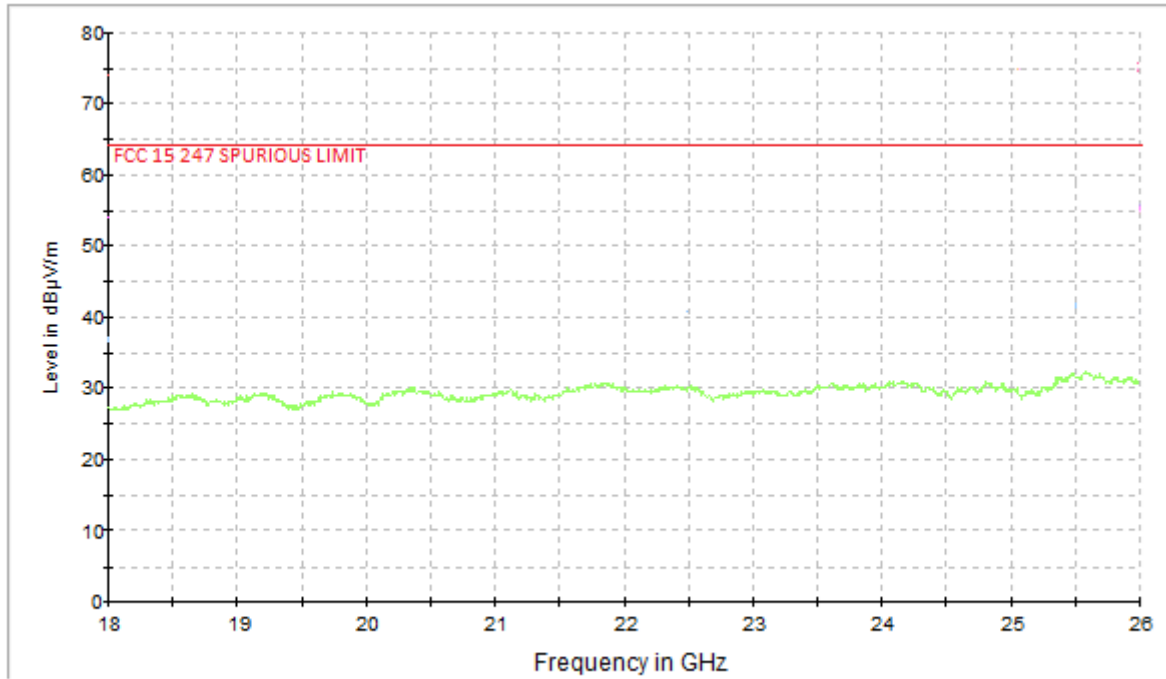



MODE	G
CHANNEL	11
FREQUENCY RANGE	30MHz – 1GHz
POLARIZATION	HORIZONTAL

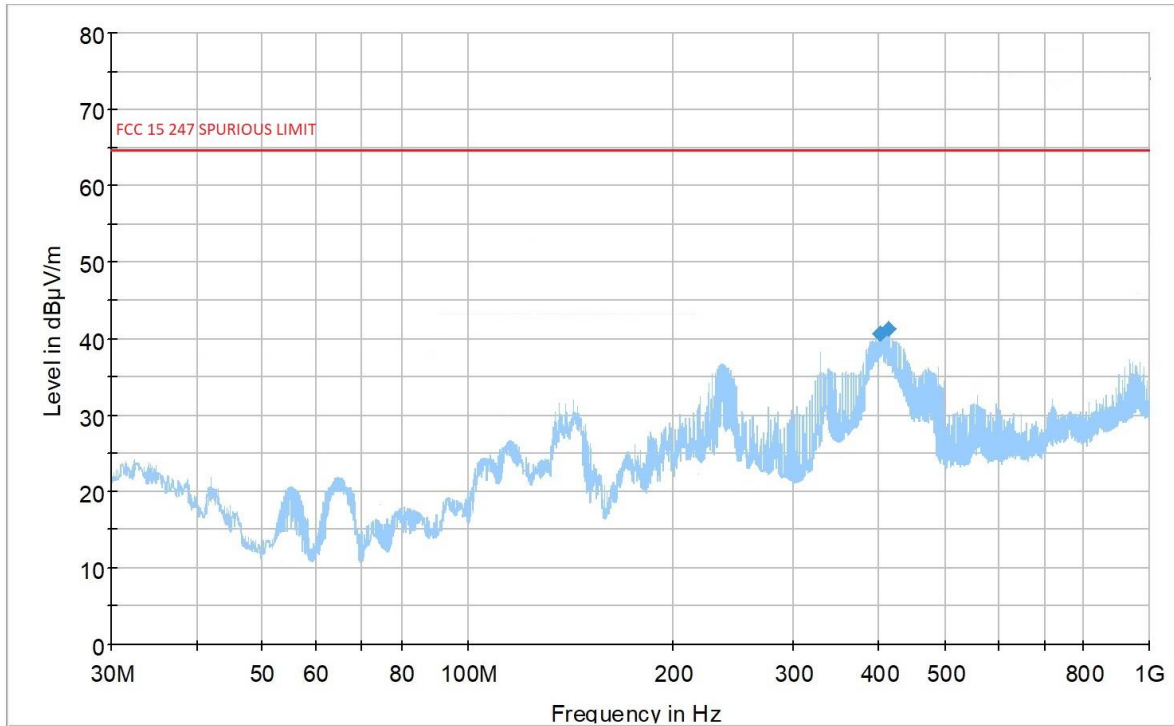

Blue trace Peak detector, Blue Marker Quasi-Peak detector

Final Result

Frequency (MHz)	MaxPeak (dBµV/m)	Limit (dBµV/m)	Margin (dB)	Height (cm)	Pol	Azimuth (deg)
403.159000	41.17	64.10	22.93	108.0	H	114.0
406.360000	41.88	64.10	22.22	103.0	H	107.0



MODE	G
CHANNEL	11
FREQUENCY RANGE	1-2.8GHz
POLARIZATION	HORIZONTAL

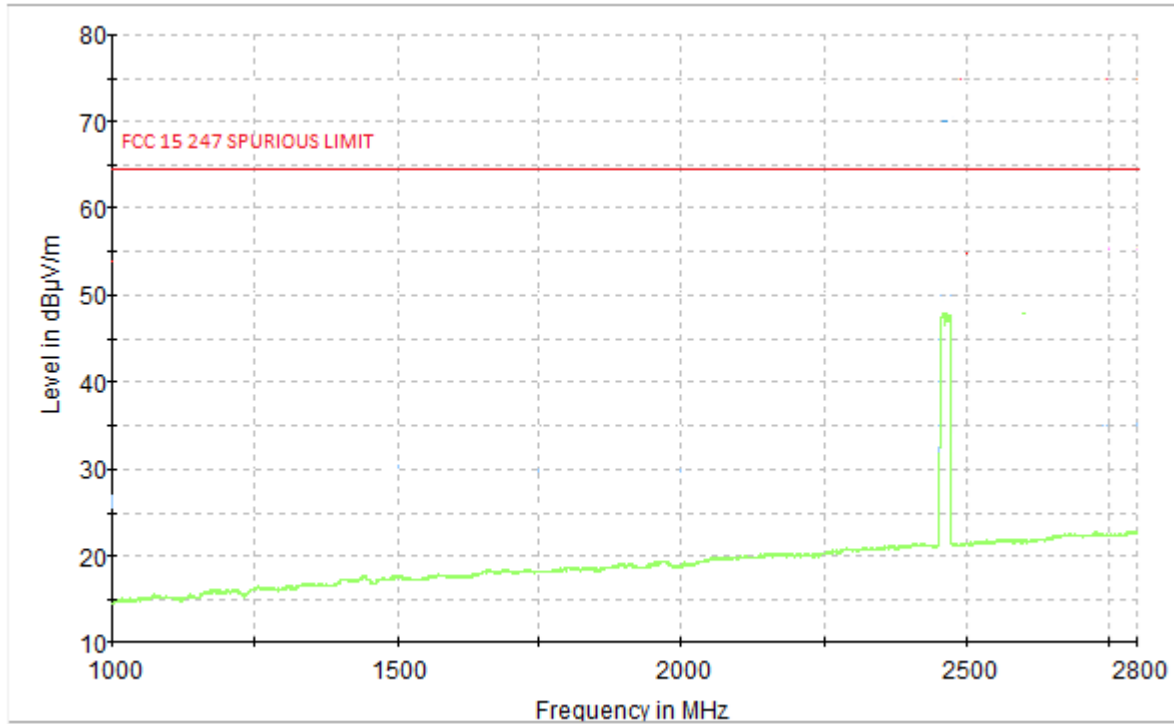

Blue trace Peak detector, Blue Marker Quasi-Peak detector; Green trace average detector, Green Marker average detector



MODE	G
CHANNEL	11
FREQUENCY RANGE	2.8-18GHz
POLARIZATION	HORIZONTAL

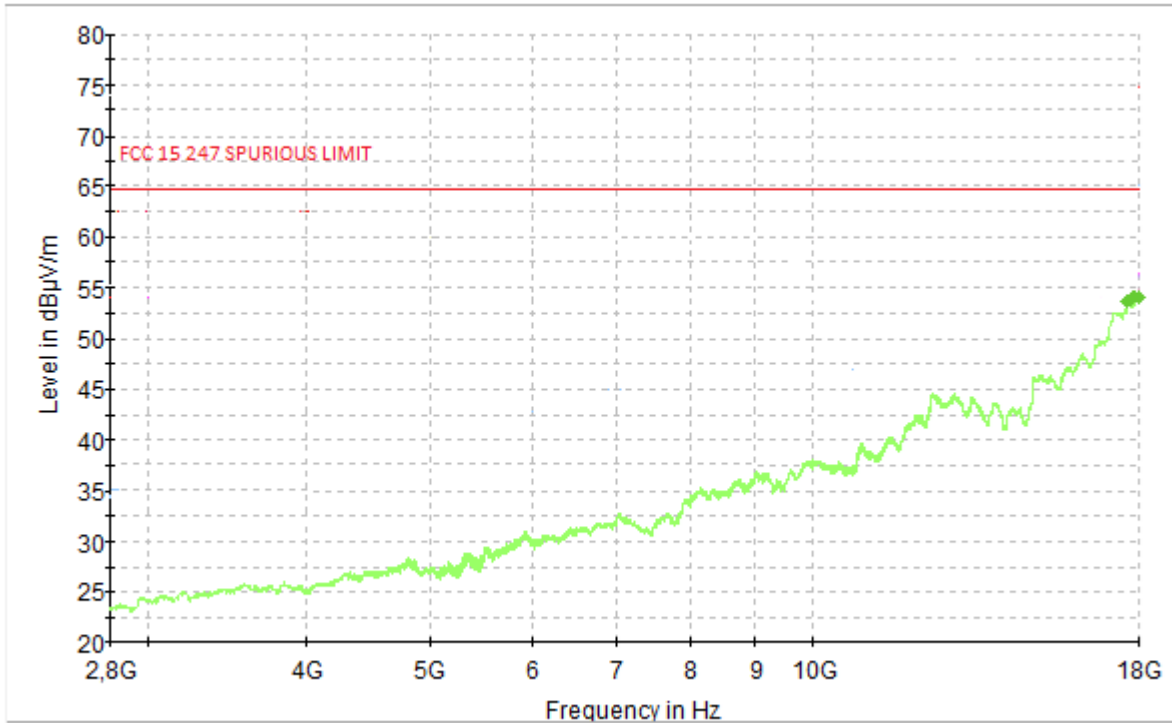

Blue trace Peak detector, Green trace average detector

Final_Result

Frequency (MHz)	Average (dBµV/m)	Limit (dBµV/m)	Margin (dB)	Height (cm)	Pol	Azimuth (deg)	Note
17990.920000	53.20	64.10	10.90	186.0	H	105.0	
17991.940000	53.30	64.10	10.80	186.0	H	105.0	
17992.950000	53.45	64.10	10.65	186.0	H	105.0	
17993.960000	53.65	64.10	10.45	186.0	H	105.0	
17995.000000	53.95	64.10	10.15	185.0	H	105.0	
18000.000000	53.85	64.10	10.25	187.0	H	105.0	



MODE	G
CHANNEL	11
FREQUENCY RANGE	18-26GHz
POLARIZATION	HORIZONTAL

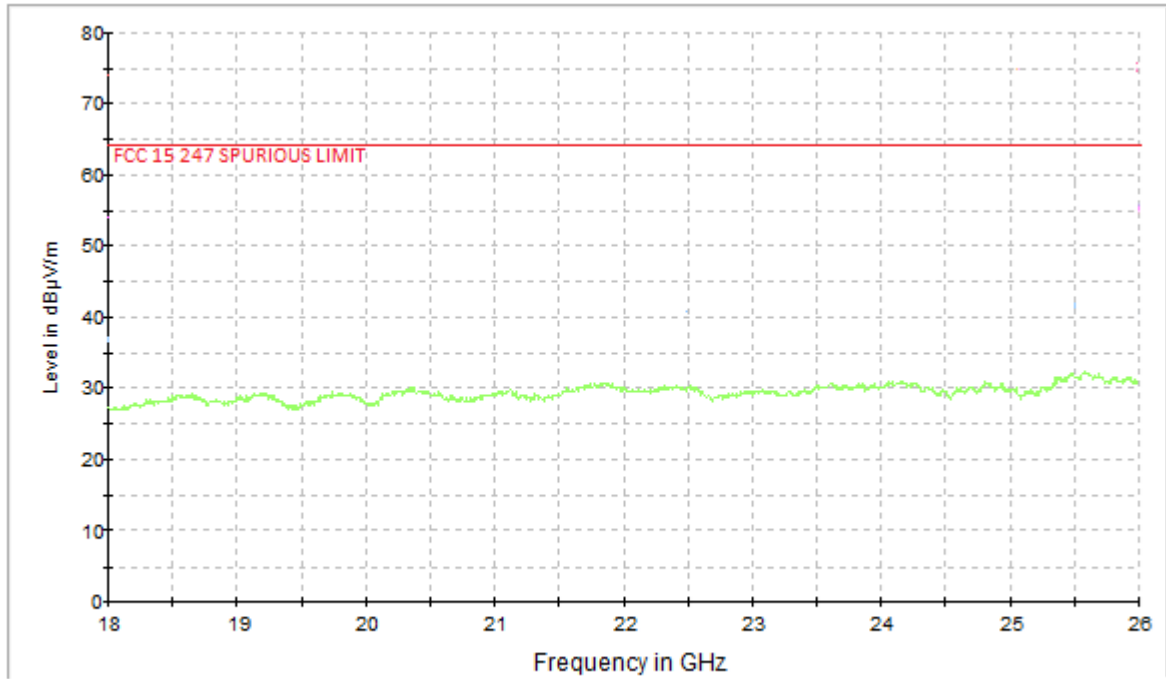



MODE	N
CHANNEL	1
FREQUENCY RANGE	30MHz – 1GHz
POLARIZATION	VERTICAL

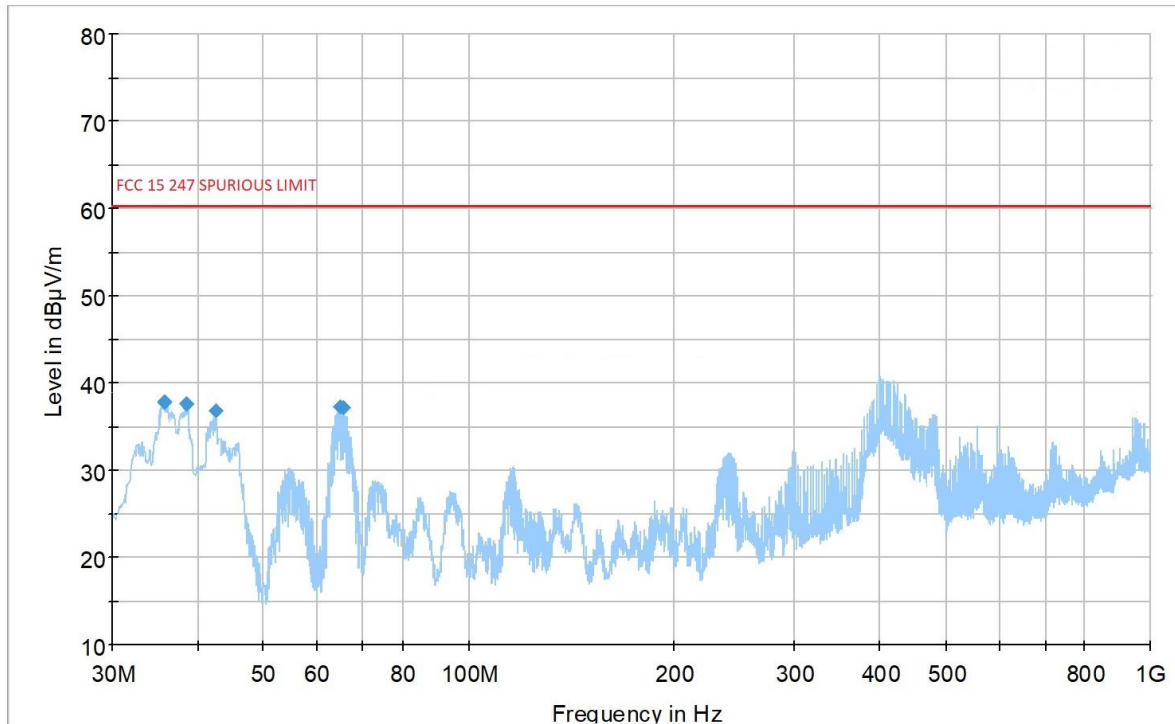

Blue trace Peak detector, Blue Marker Quasi-Peak detector

Final Result

Frequency (MHz)	QuasiPeak (dBµV/m)	Limit (dBµV/m)	Margin (dB)	Height (cm)	Pol	Azimuth (deg)
35.917000	38.60	60.19	21.59	103.0	V	-10.0
38.342000	38.51	60.19	21.68	103.0	V	43.0
42.319000	37.39	60.19	22.8	106.0	V	48.0
64.047000	37.54	60.19	22.65	112.0	V	-5.0
64.726000	37.52	60.19	22.67	124.0	V	133.0



MODE	N
CHANNEL	1
FREQUENCY RANGE	1-2.8GHz
POLARIZATION	VERTICAL

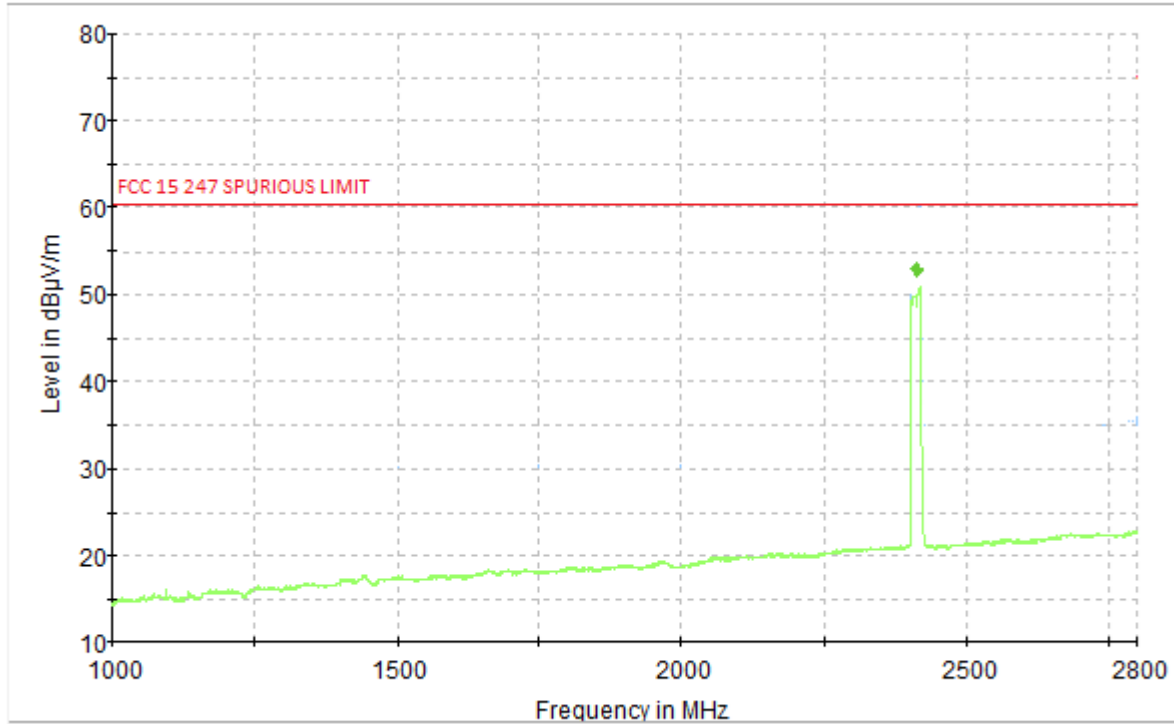

Blue trace Peak detector, Blue Marker Quasi-Peak detector; Green trace average detector, Green Marker average detector

Average Final Result

Frequency (MHz)	Average (dBµV/m)	Limit (dBµV/m)	Margin (dB)	Height (cm)	Pol	Azimuth (deg)
2412.10000	52.90	60.19	7.29	184.0	V	80.0



MODE	N
CHANNEL	1
FREQUENCY RANGE	2.8-18GHz
POLARIZATION	VERTICAL

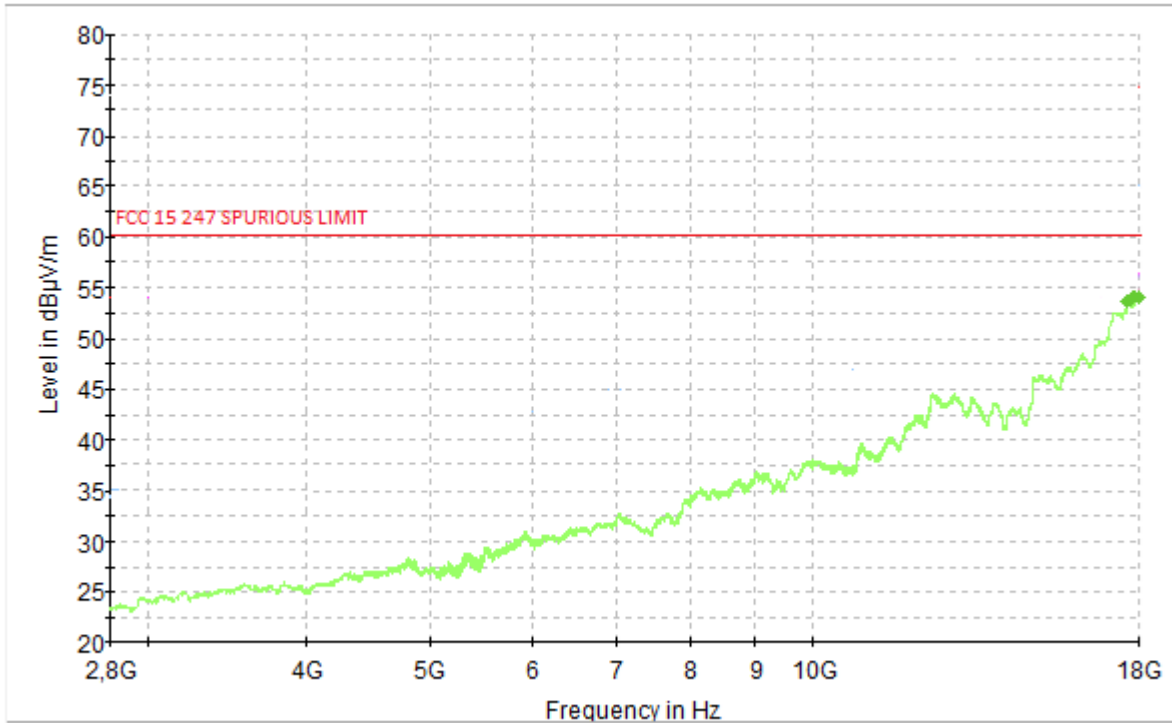

Blue trace Peak detector, Green trace average detector

Final_Result

Frequency (MHz)	Average (dBµV/m)	Limit (dBµV/m)	Margin (dB)	Height (cm)	Pol	Azimuth (deg)	Note
17990.920000	53.00	60.19	7.19	187.0	V	90.0	
17991.940000	53.20	60.19	6.99	186.0	V	90.0	
17992.950000	53.40	60.19	6.79	187.0	V	90.0	
17993.960000	53.75	60.19	6.44	187.0	V	91.0	
17995.000000	53.85	60.19	6.34	187.0	V	91.0	
18000.000000	54.00	60.19	6.19	187.0	V	91.0	



MODE	N
CHANNEL	1
FREQUENCY RANGE	18-26GHz
POLARIZATION	VERTICAL

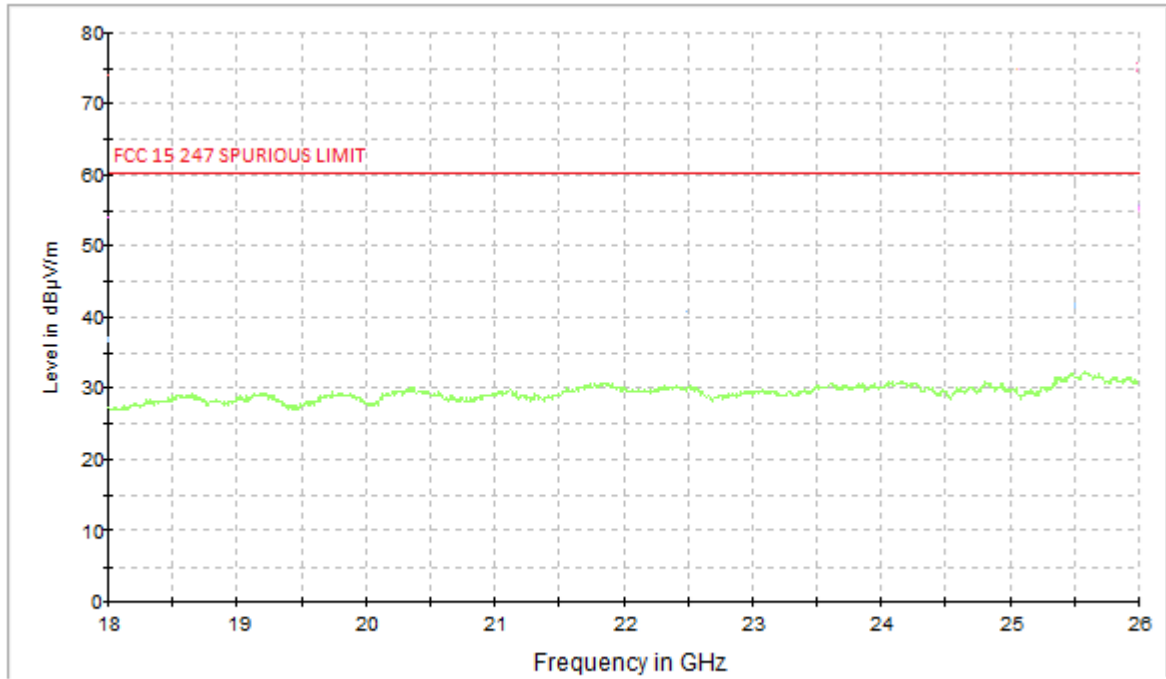



MODE	N
CHANNEL	1
FREQUENCY RANGE	30MHz – 1GHz
POLARIZATION	HORIZONTAL

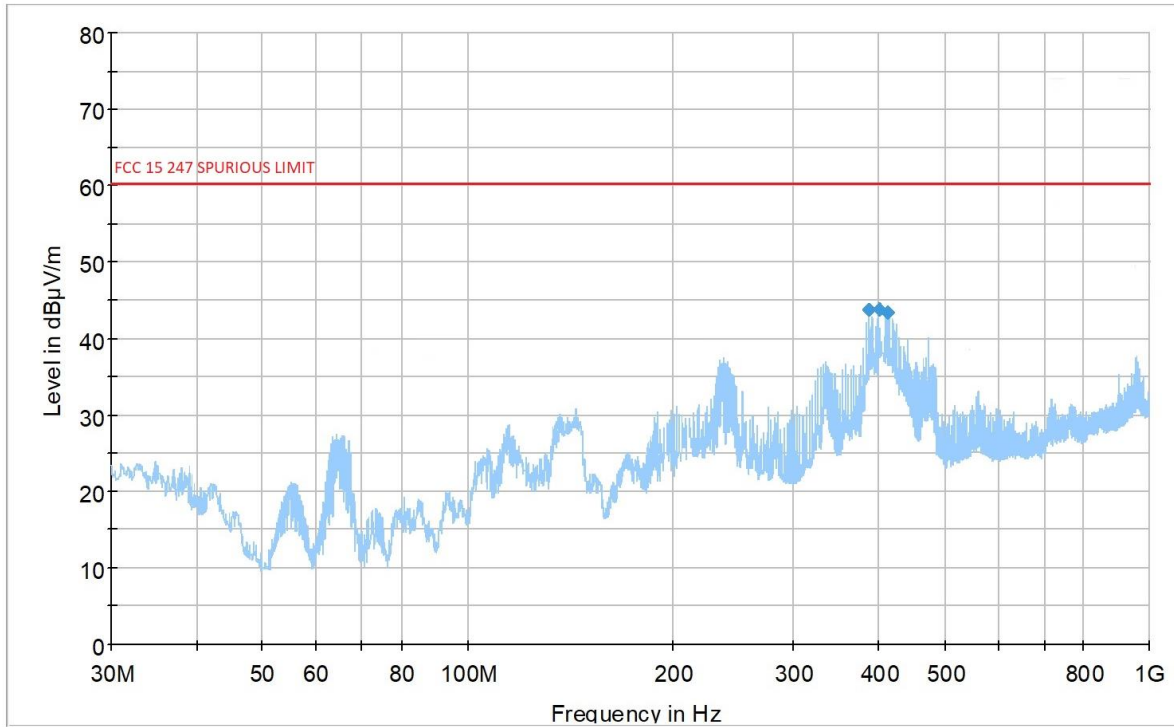

Blue trace Peak detector, Blue Marker Quasi-Peak detector

Final Result

Frequency (MHz)	MaxPeak (dBµV/m)	Limit (dBµV/m)	Margin (dB)	Height (cm)	Pol	Azimuth (deg)
396.234000	44.63	60.19	15.56	97.0	H	104.0
403.159000	44.62	60.19	15.57	105.0	H	120.0
406.360000	44.30	60.19	15.89	105.0	H	107.0



MODE	N
CHANNEL	1
FREQUENCY RANGE	1-2.8GHz
POLARIZATION	HORIZONTAL

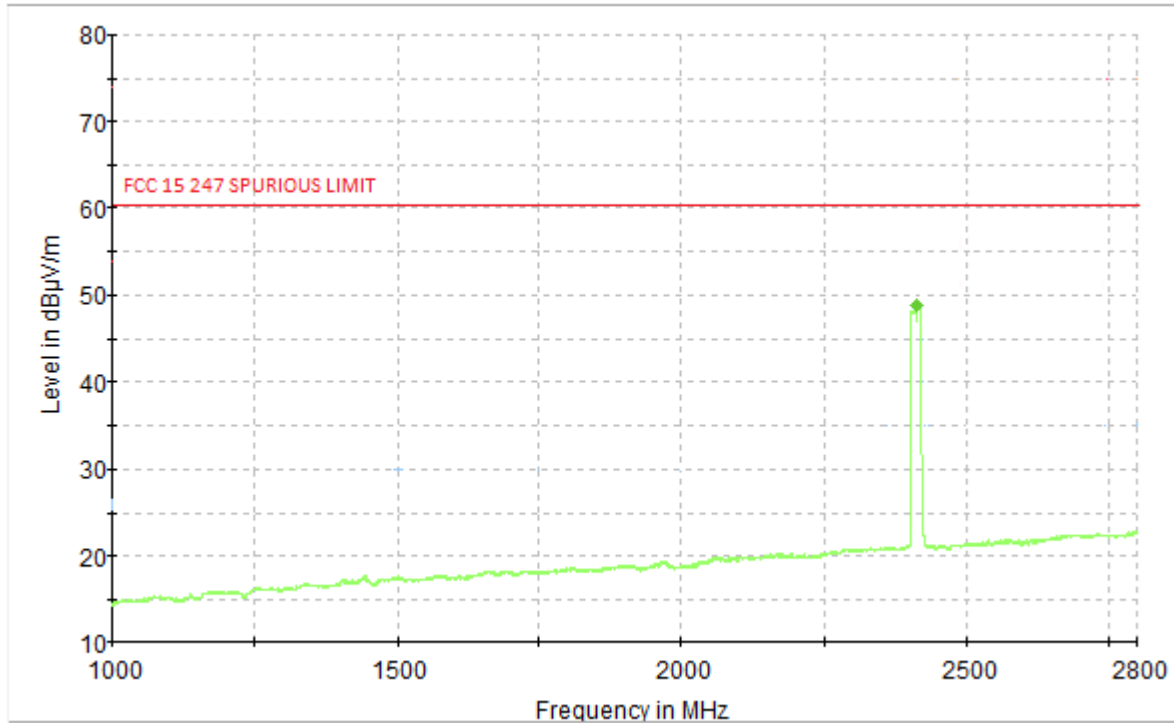

Blue trace Peak detector, Blue Marker Quasi-Peak detector; Green trace average detector, Green Marker average detector

Average Final Result

Frequency (MHz)	Average (dBµV/m)	Limit (dBµV/m)	Margin (dB)	Height (cm)	Pol	Azimuth (deg)
2411.920000	48.90	60.19	11.29	100.0	H	37.0



MODE	N
CHANNEL	1
FREQUENCY RANGE	2.8-18GHz
POLARIZATION	HORIZONTAL

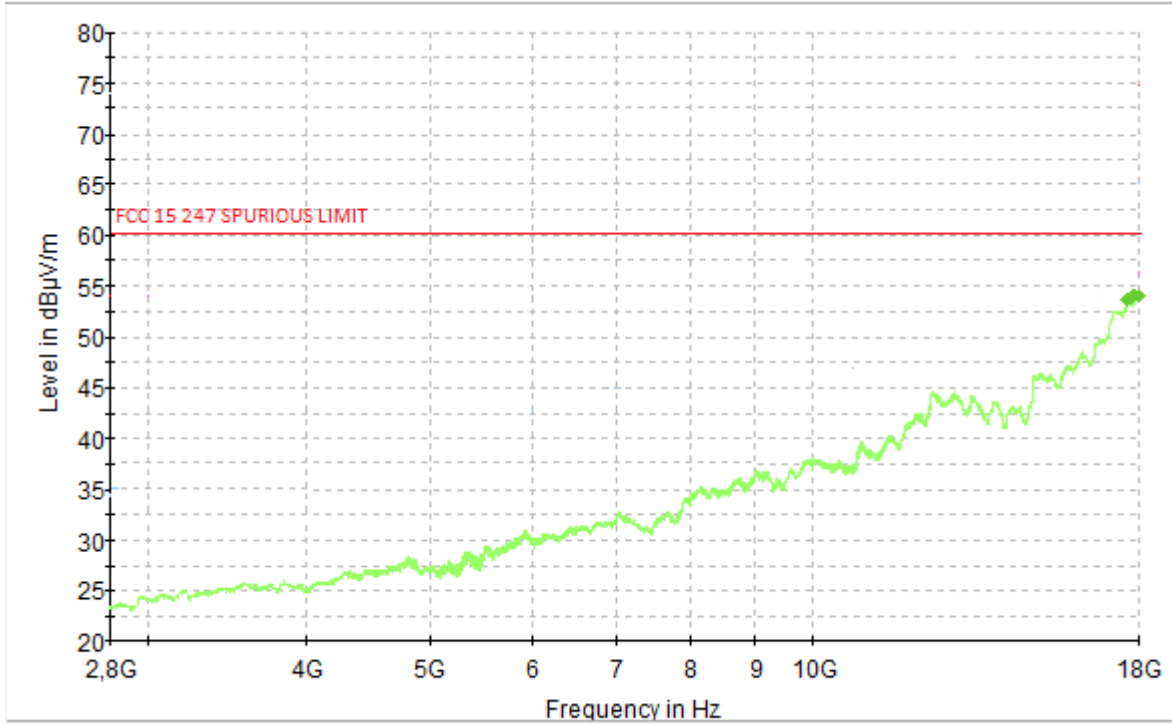

Blue trace Peak detector, Green trace average detector

Final Result

Frequency (MHz)	Average (dBµV/m)	Limit (dBµV/m)	Margin (dB)	Height (cm)	Pol	Azimuth (deg)	Note
17990.920000	53.20	60.19	6.99	186.0	H	105.0	
17991.940000	53.30	60.19	6.89	186.0	H	105.0	
17992.950000	53.45	60.19	6.74	186.0	H	105.0	
17993.960000	53.65	60.19	6.54	186.0	H	105.0	
17995.000000	53.95	60.19	6.24	185.0	H	105.0	
18000.000000	53.85	60.19	6.34	187.0	H	105.0	



MODE	N
CHANNEL	1
FREQUENCY RANGE	18-26GHz
POLARIZATION	HORIZONTAL

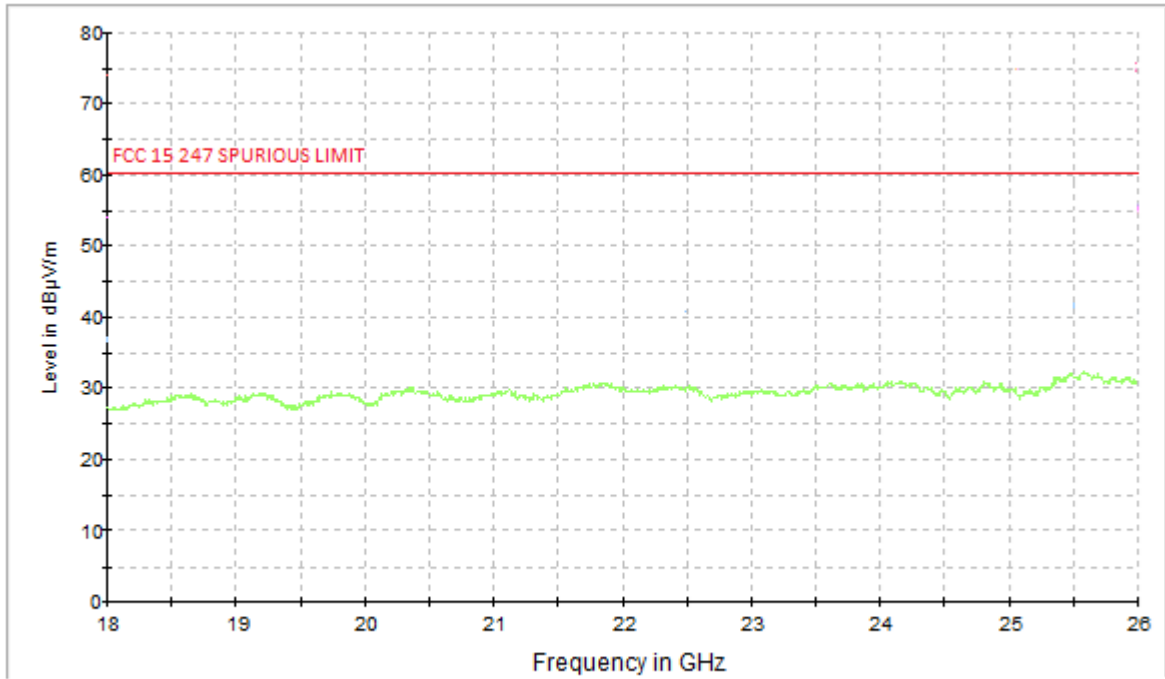



MODE	N
CHANNEL	11
FREQUENCY RANGE	30MHz – 1GHz
POLARIZATION	VERTICAL

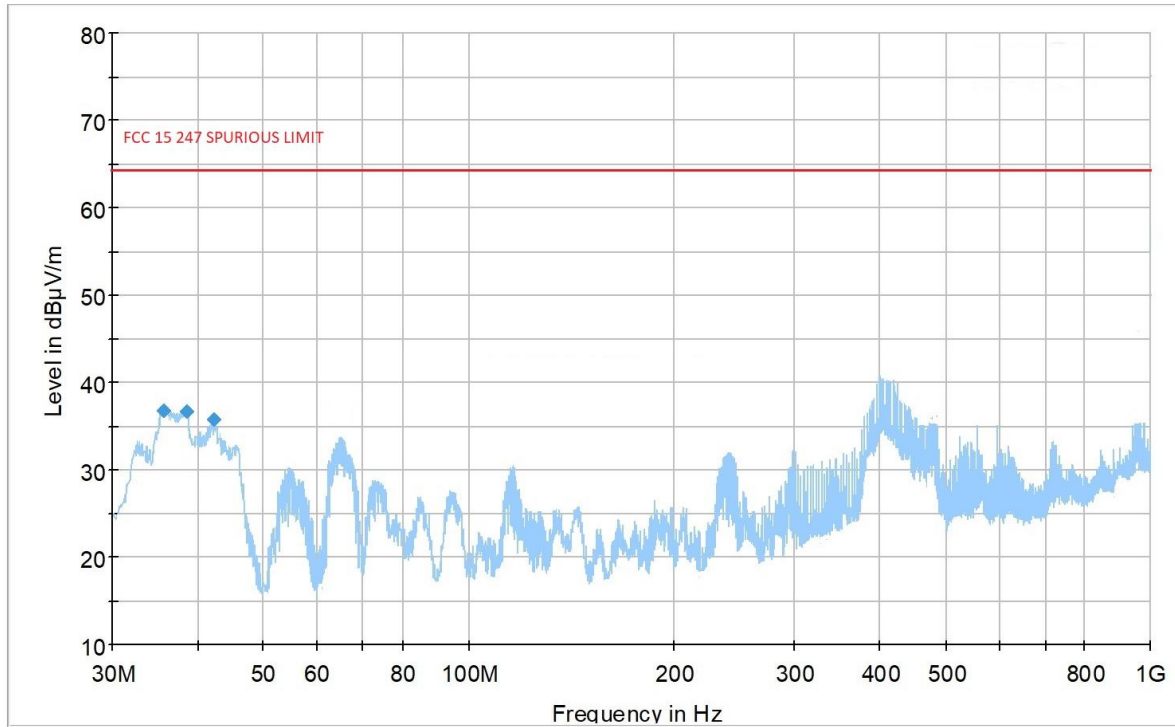

Blue trace Peak detector, Blue Marker Quasi-Peak detector

Final Result

Frequency (MHz)	QuasiPeak (dBµV/m)	Limit (dBµV/m)	Margin (dB)	Height (cm)	Pol	Azimuth (deg)
35.917000	36.70	63.66	26.96	102.0	V	-11.0
38.342000	36.68	63.66	26.98	102.0	V	44.0
42.319000	35.30	63.66	28.36	102.0	V	50.0



MODE	N
CHANNEL	11
FREQUENCY RANGE	1-2.8GHz
POLARIZATION	VERTICAL

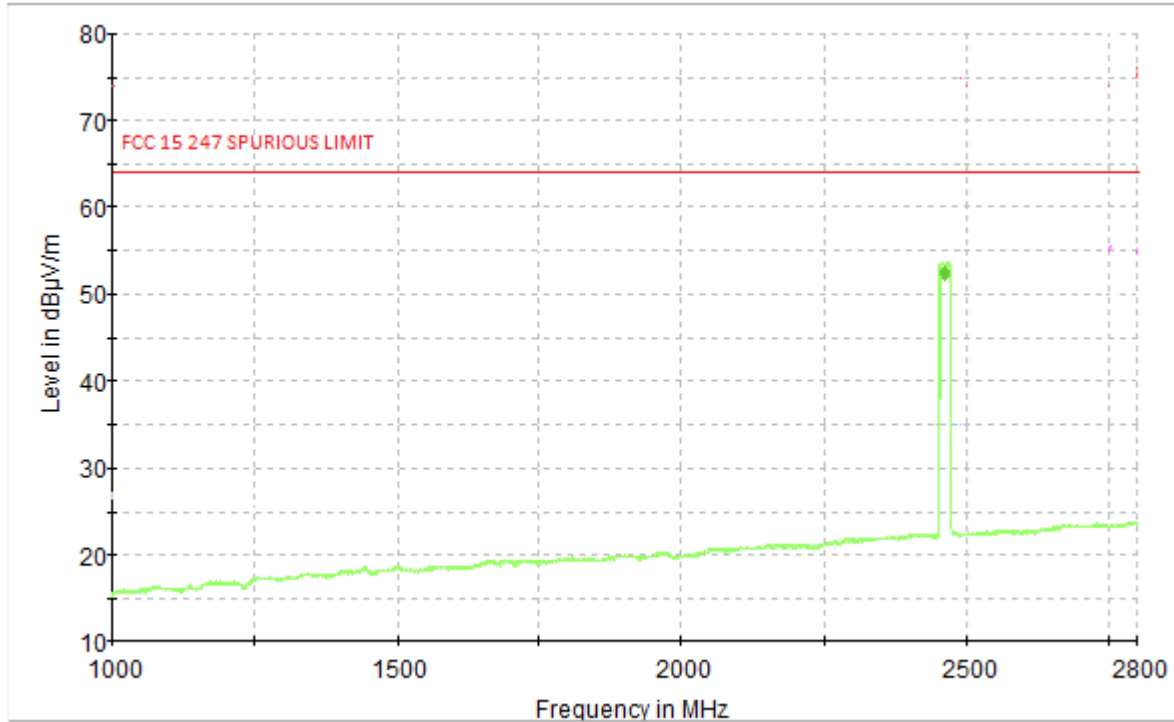

Blue trace Peak detector, Blue Marker Quasi-Peak detector; Green trace average detector, Green Marker average detector

Average Final Result

Frequency (MHz)	Average (dBµV/m)	Limit (dBµV/m)	Margin (dB)	Height (cm)	Pol	Azimuth (deg)
2462.140000	52.33	63.66	11.33	128.0	V	13.0



MODE	N
CHANNEL	11
FREQUENCY RANGE	2.8-18GHz
POLARIZATION	VERTICAL

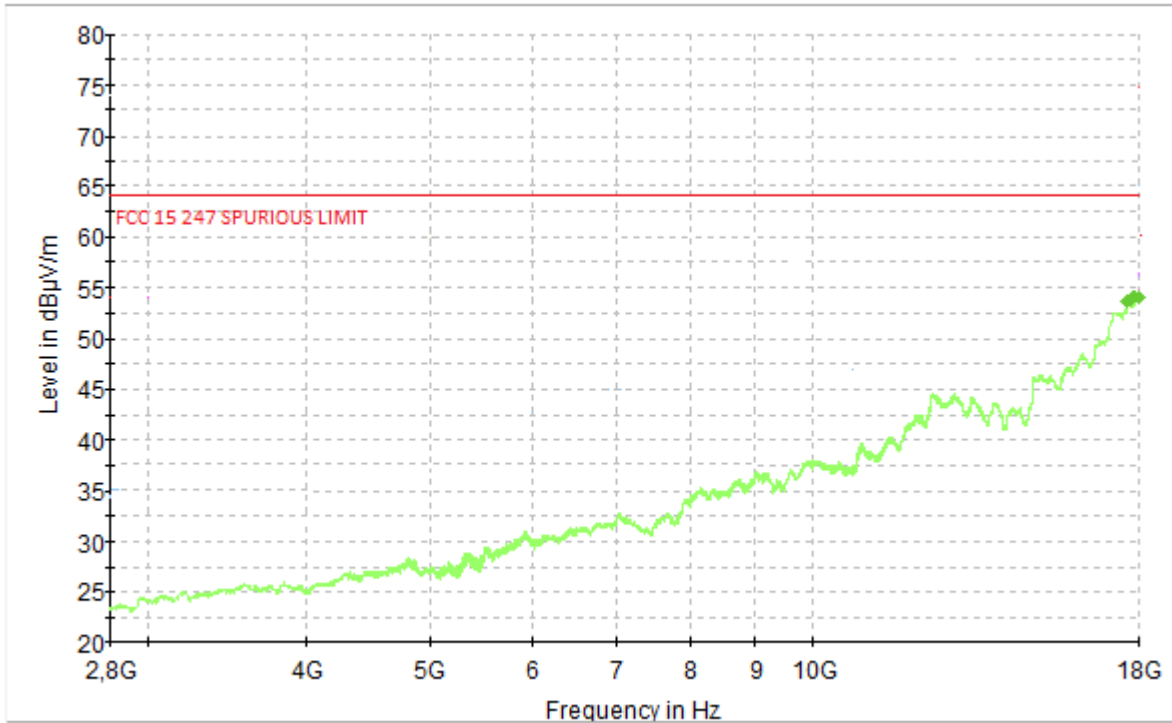

Blue trace Peak detector, Green trace average detector

Final Result

Frequency (MHz)	Average (dBµV/m)	Limit (dBµV/m)	Margin (dB)	Height (cm)	Pol	Azimuth (deg)	Note
17990.920000	53.00	63.66	10.66	187.0	V	90.0	
17991.940000	53.20	63.66	10.46	186.0	V	90.0	
17992.950000	53.40	63.66	10.26	187.0	V	90.0	
17993.960000	53.75	63.66	9.91	187.0	V	91.0	
17995.000000	53.85	63.66	9.81	187.0	V	91.0	
18000.000000	54.00	63.66	9.66	187.0	V	91.0	



MODE	N
CHANNEL	11
FREQUENCY RANGE	18-26GHz
POLARIZATION	VERTICAL

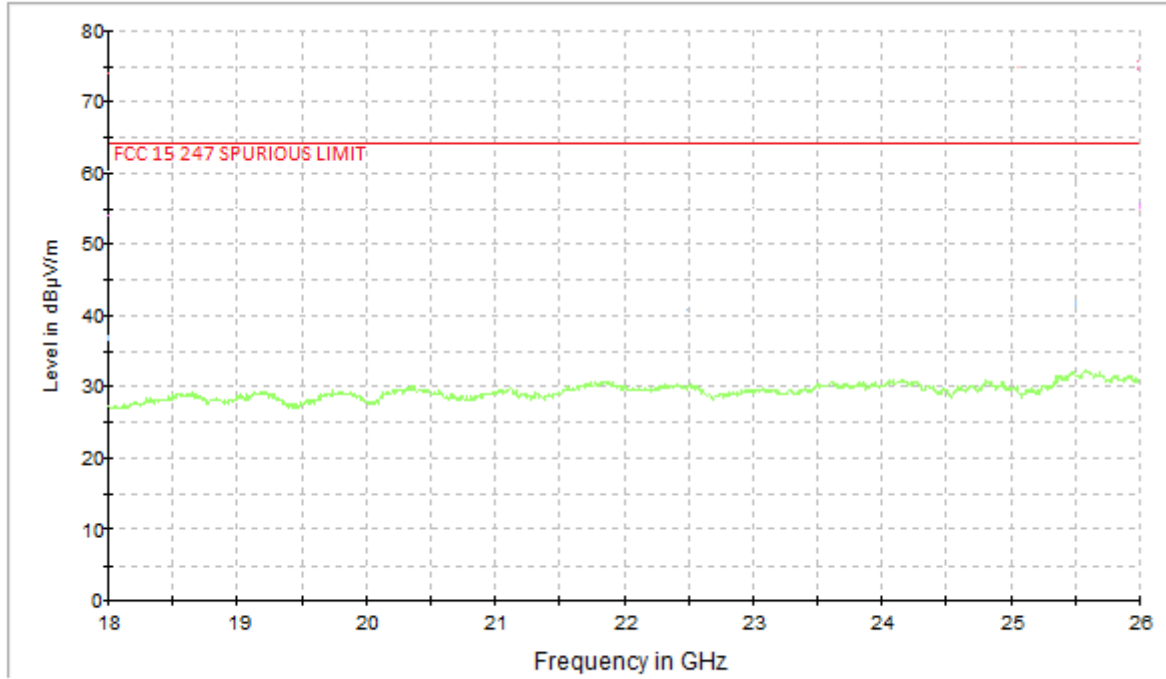



MODE	N
CHANNEL	11
FREQUENCY RANGE	30MHz – 1GHz
POLARIZATION	HORIZONTAL

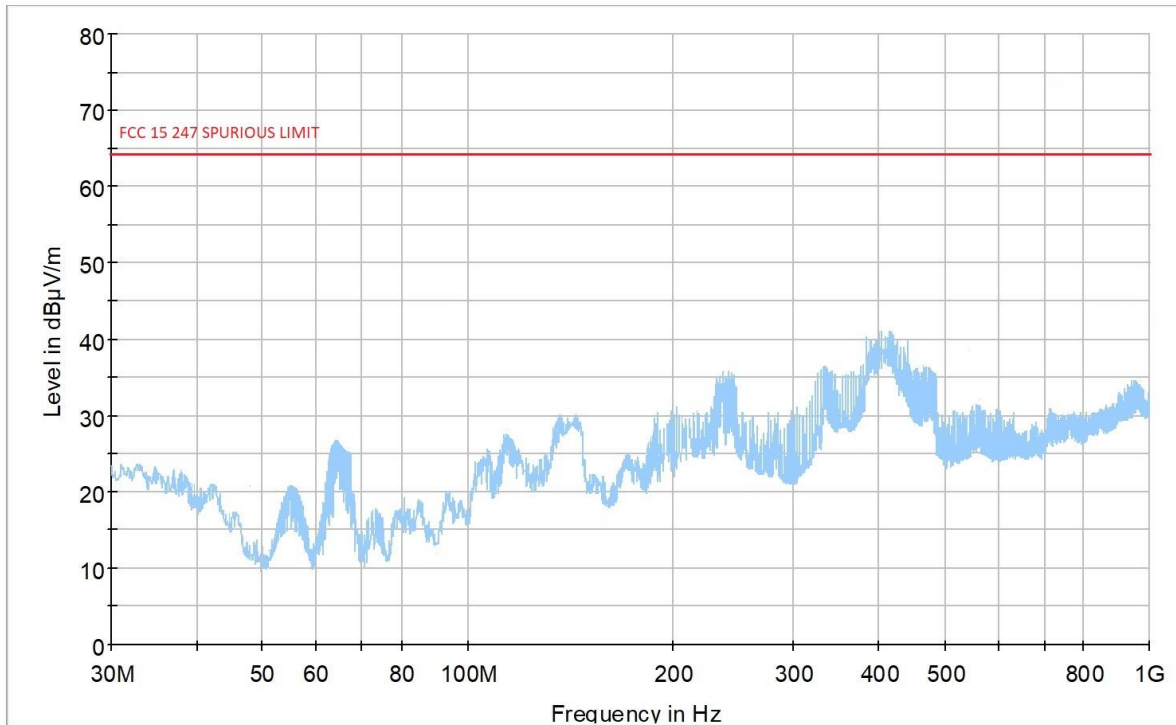

Blue trace Peak detector, Blue Marker Quasi-Peak detector

Final Result

Frequency (MHz)	MaxPeak (dBµV/m)	Limit (dBµV/m)	Margin (dB)	Height (cm)	Pol	Azimuth (deg)
---	---	63.66	---	---	---	---



MODE	N
CHANNEL	11
FREQUENCY RANGE	1-2.8GHz
POLARIZATION	HORIZONTAL

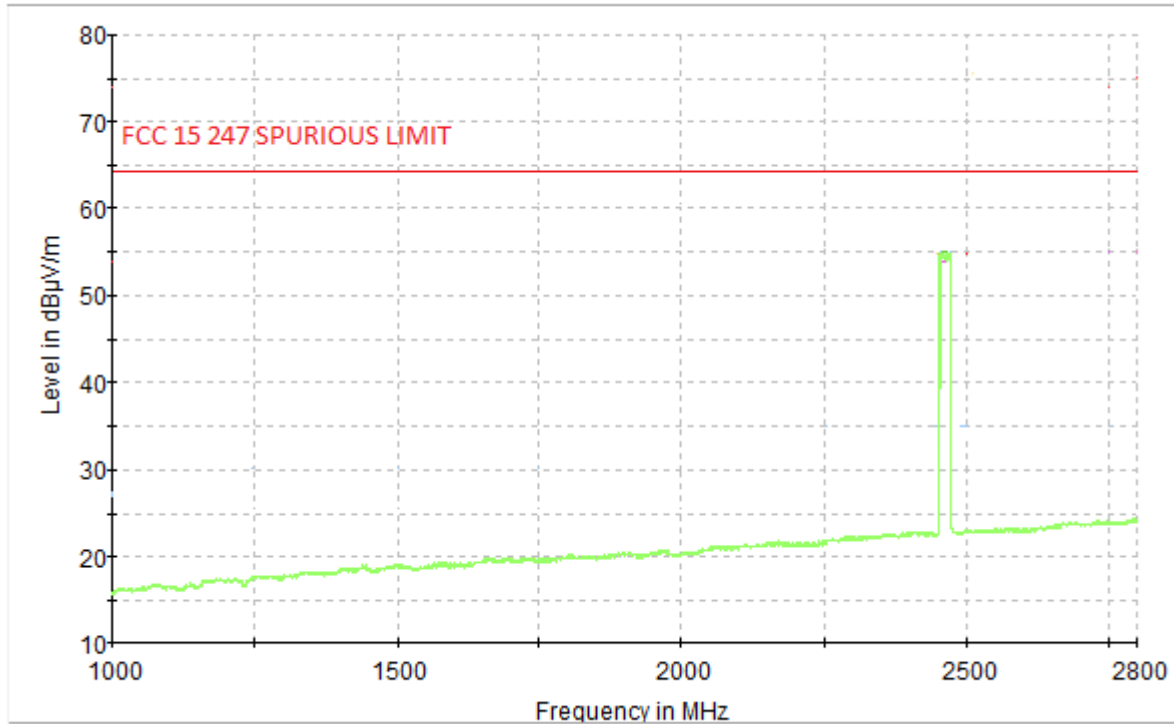

Blue trace Peak detector, Blue Marker Quasi-Peak detector; Green trace average detector, Green Marker average detector

Average Final Result

Frequency (MHz)	Average (dBµV/m)	Limit (dBµV/m)	Margin (dB)	Height (cm)	Pol	Azimuth (deg)
2462.140000	63.66	54.00	9.66	175.0	H	207.0



MODE	N
CHANNEL	11
FREQUENCY RANGE	2.8-18GHz
POLARIZATION	HORIZONTAL

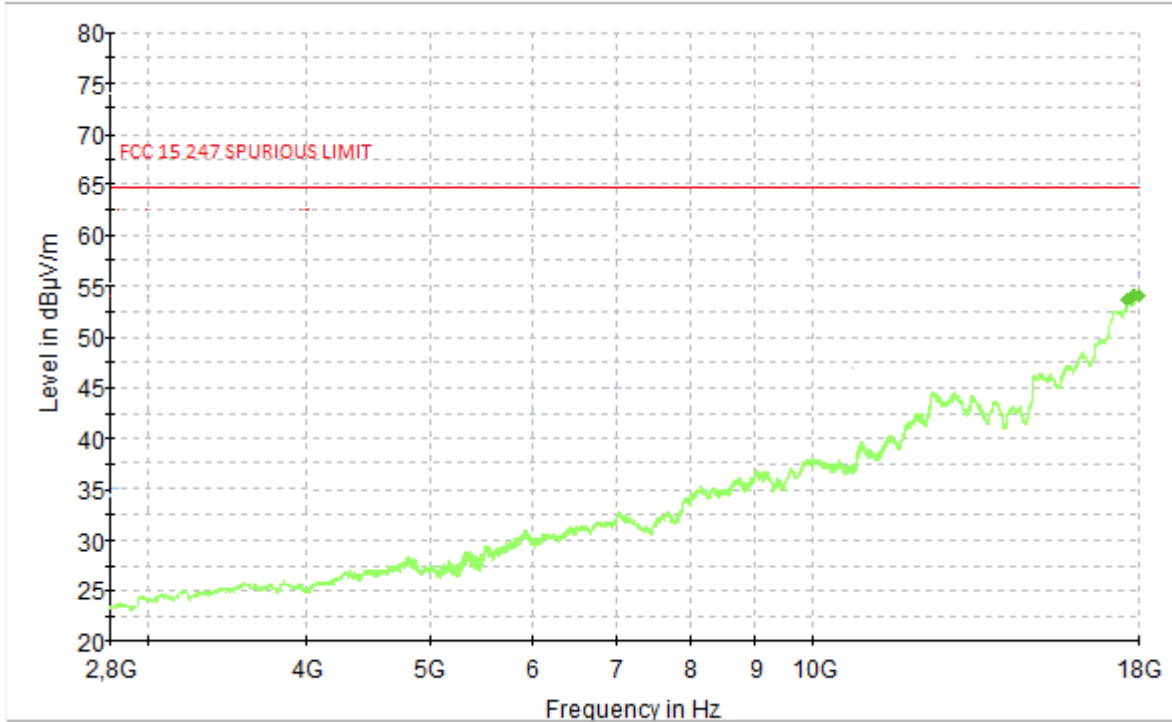

Blue trace Peak detector, Green trace average detector

Final_Result

Frequency (MHz)	Average (dBµV/m)	Limit (dBµV/m)	Margin (dB)	Height (cm)	Pol	Azimuth (deg)	Note
17990.920000	53.20	63.66	10.46	186.0	H	105.0	
17991.940000	53.30	63.66	10.36	186.0	H	105.0	
17992.950000	53.45	63.66	10.21	186.0	H	105.0	
17993.960000	53.65	63.66	10.01	186.0	H	105.0	
17995.000000	53.95	63.66	9.71	185.0	H	105.0	
18000.000000	53.85	63.66	9.81	187.0	H	105.0	



MODE	N
CHANNEL	11
FREQUENCY RANGE	18-26GHz
POLARIZATION	HORIZONTAL

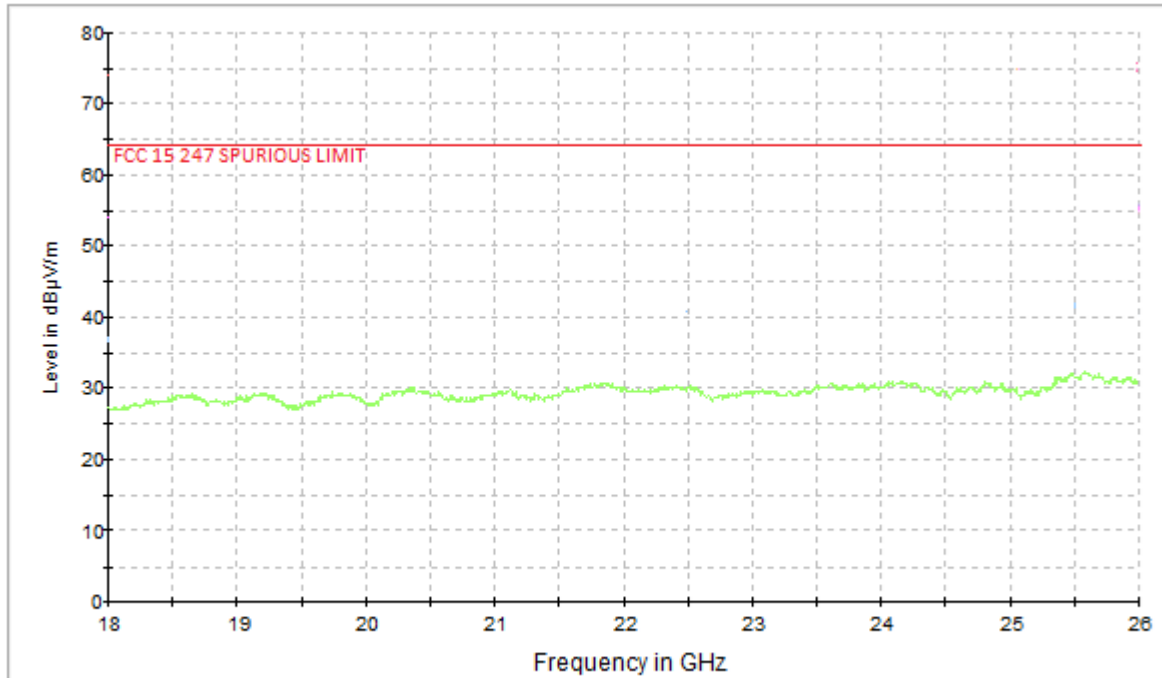

**TEST
7.**

AC CONDUCTED EMISSIONS

**REFERENCE
DOCUMENT**

FCC Cfr 47 part 15 - Subpart B - §15.207

- TEST SETUP: Acc. to reference standard
- TEST LOCATION: Semianechoic chamber
- TEST EQUIPMENT USED FOR TEST: EMI receiver Rohde & Schwarz Mod. ESU 40 (20Hz-40GHz)
Artificial Network Rohde & Schwarz Mod. ESH3-Z5

- TESTED PORT: AC mains of AC/DC host device adapter
- FREQUENCY RANGE: 0.15 - 30 MHz
- EMISSION LIMITS: Section 15.207 of Standard
- MEASUREMENT UNCERTAINTY: Level of confidence = 95%
Degree of freedom = 10
Coverage factor $k_p = 2,28$
Combined uncertainty = 2,36 dB

TEST CONDITIONS:	MEASURED
Ambient temperature : 15 - 35 °C	24 ± 3 °C
Ambient humidity : 25 - 75 %rH	40 ± 5 %rH
Pressure : 85 - 106 kPa (860 mbar - 1060 mbar)	950 ± 50 mbar
Voltage :	115V ~ 60Hz

OPERATING CONDITION	#1, DUTY CYCLE 100%
----------------------------	---------------------

TEST RESULT	WITHIN THE LIMITS
--------------------	--------------------------



L1 LINE

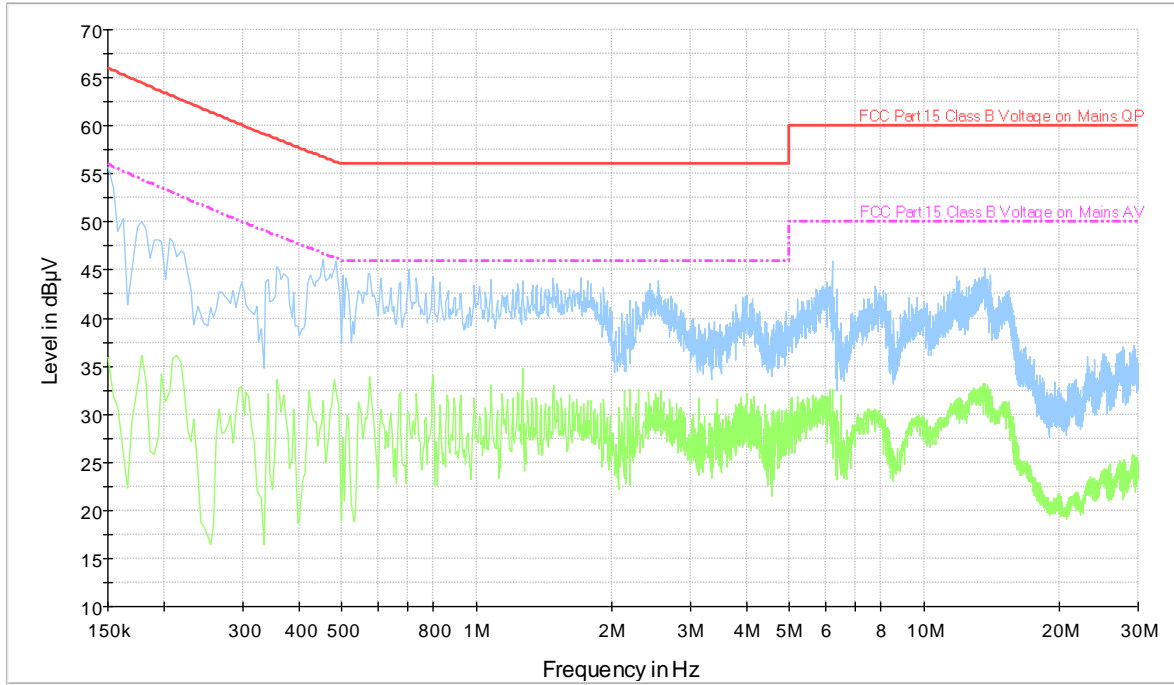



NEUTRAL LINE

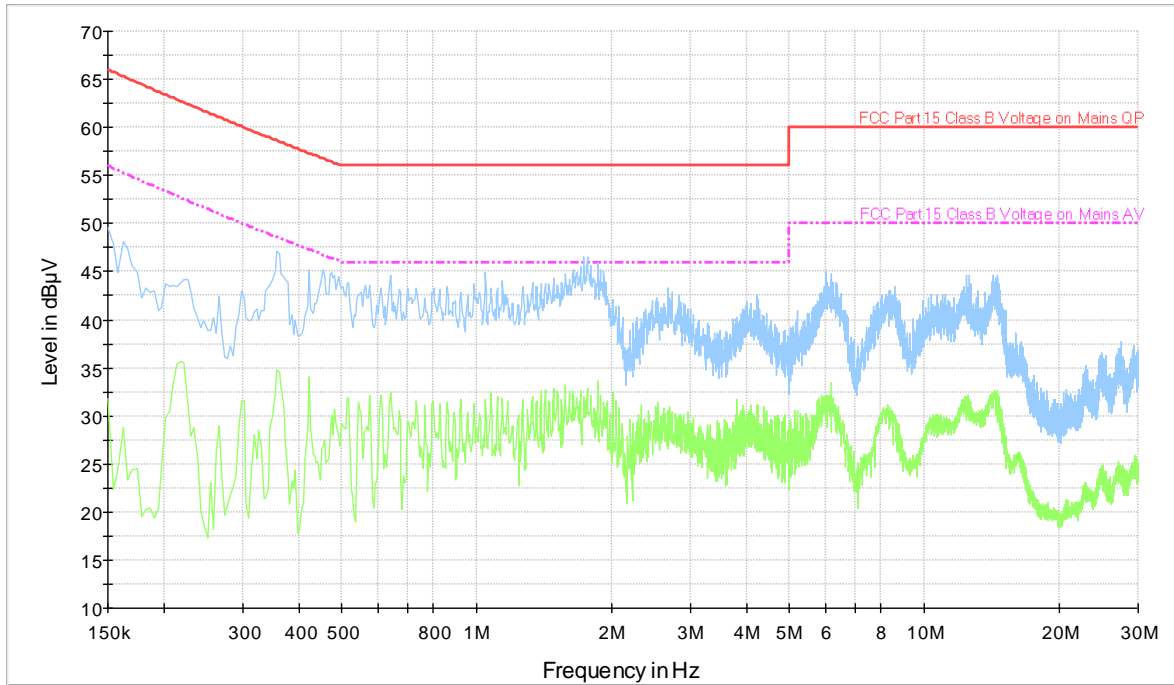

7. LIST OF EQUIPMENT USED

EQUIPMENT	MANUFACTURER	MODEL	SERIAL Nr.	CAL. DUE
EMI TEST RECEIVER	Rohde & Schwarz	ESU40	100111	Mar. 2018
RF SEMI-ANECHOIC CHAMBER (CSSA)	Siemens	B83117-D6019-T232	003-005-134/94C	Jan 2018
BILOG ANTENNA	Chase	CBL6111C	2717	Mar. 2018
HORN ANTENNA 1-18GHz	Electrometrics	EN-6961	100437	Apr. 2017
HORN ANTENNA (Pre-amplified) 18-26GHz	SCHWARZBECK MESS- ELEKTRONIK	BBHA 9170	9170-688	Apr. 2017
SPECTRUM ANALYZER	Rohde & Schwarz	FSP40	100038	Feb. 2018
SYSTEM DC POWER SUPPLY	HP	6623A	3448A04501	Jan. 2018
TUNABLE NOTCH FILTER	Wainwright	WRCT2200/2500-5/40-10SK	5	Nov 2017
HIGH PASS FILTER	Wainwright	WHNX 2,8/18G-10SS	1	Nov 2017
ARTIFICIAL MAINS NETWORK	Rohde & Schwarz	ESH3-Z5	838576/009	Jan. 2018