

FCC Test Report

Report No.: RFB DYS-WTW-P22031091A

FCC ID: 2AKCZ-108

Test Model: APL68-108

Received Date: Mar. 28, 2022

Test Date: Apr. 08 ~ Jul. 26, 2022

Issued Date: Feb. 15, 2023

Applicant: SonicWall Inc.

Address: 1033 McCarthy Blvd., Milpitas, CA 95035, USA

Issued By: Bureau Veritas Consumer Products Services (H.K.) Ltd., Taoyuan Branch
Lin Kou Laboratories

Lab Address: No. 47-2, 14th Ling, Chia Pau Vil., Lin Kou Dist., New Taipei City, Taiwan

Test Location (1): No. 19, Hwa Ya 2nd Rd., Wen Hwa Vil., Kwei Shan Dist., Taoyuan City
33383, TAIWAN

**FCC Registration /
Designation Number:** 788550 / TW0003

Test Location (2): No. 70, Wenming Rd., Guishan Dist., Taoyuan City 333, Taiwan (R.O.C.)

**FCC Registration /
Designation Number:** 281270 / TW0032



This report is governed by, and incorporates by reference, the Conditions of Testing as posted at the date of issuance of this report at <http://www.bureauveritas.com/home/about-us/our-business/cps/about-us/terms-conditions/> and is intended for your exclusive use. Any copying or replication of this report to or for any other person or entity, or use of our name or trademark, is permitted only with our prior written permission. This report sets forth our findings solely with respect to the test samples identified herein. The results set forth in this report are not indicative or representative of the quality or characteristics of the lot from which a test sample was taken or any similar or identical product unless specifically and expressly noted. Our report includes all of the tests requested by you and the results thereof based upon the information that you provided to us. Measurement uncertainty is only provided upon request for accredited tests. Statements of conformity are based on simple acceptance criteria without taking measurement uncertainty into account, unless otherwise requested in writing. You have 60 days from date of issuance of this report to notify us of any material error or omission caused by our negligence or if you require measurement uncertainty; provided, however, that such notice shall be in writing and shall specifically address the issue you wish to raise. A failure to raise such issue within the prescribed time shall constitute your unqualified acceptance of the completeness of this report, the tests conducted and the correctness of the report contents.

Table of Contents

Release Control Record	4
1 Certificate of Conformity	5
2 Summary of Test Results	6
2.1 Measurement Uncertainty.....	6
2.2 Modification Record.....	6
3 General Information	7
3.1 General Description of EUT.....	7
3.2 Description of Test Modes.....	10
3.2.1 Test Mode Applicability and Tested Channel Detail.....	11
3.3 Duty Cycle of Test Signal.....	14
3.4 Description of Support Units.....	15
3.4.1 Configuration of System under Test.....	15
3.5 General Description of Applied Standards and References.....	16
4 Test Types and Results	17
4.1 Radiated Emission and Bandedge Measurement.....	17
4.1.1 Limits of Radiated Emission and Bandedge Measurement.....	17
4.1.2 Test Instruments.....	18
4.1.3 Test Procedures.....	19
4.1.4 Deviation from Test Standard.....	20
4.1.5 Test Setup.....	20
4.1.6 EUT Operating Conditions.....	21
4.1.7 Test Results.....	22
4.2 Conducted Emission Measurement.....	50
4.2.1 Limits of Conducted Emission Measurement.....	50
4.2.2 Test Instruments.....	50
4.2.3 Test Procedures.....	51
4.2.4 Deviation from Test Standard.....	51
4.2.5 Test Setup.....	51
4.2.6 EUT Operating Conditions.....	51
4.2.7 Test Results.....	52
4.3 Transmit Power Measurement.....	56
4.3.1 Limits of Transmit Power Measurement.....	56
4.3.2 Test Setup.....	56
4.3.3 Test Instruments.....	56
4.3.4 Test Procedure.....	57
4.3.5 Deviation from Test Standard.....	57
4.3.6 EUT Operating Conditions.....	57
4.3.7 Test Result.....	57
4.4 Occupied Bandwidth Measurement.....	79
4.4.1 Test Setup.....	79
4.4.2 Test Instruments.....	79
4.4.3 Test Procedure.....	79
4.4.4 Test Result.....	80
4.5 Peak Power Spectral Density Measurement.....	83
4.5.1 Limits of Peak Power Spectral Density Measurement.....	83
4.5.2 Test Setup.....	83
4.5.3 Test Instruments.....	83
4.5.4 Test Procedures.....	84
4.5.5 Deviation from Test Standard.....	84
4.5.6 EUT Operating Conditions.....	84
4.5.7 Test Results.....	85
4.6 Frequency Stability.....	90
4.6.1 Limits of Frequency Stability Measurement.....	90

4.6.2 Test Setup.....	90
4.6.3 Test Instruments	90
4.6.4 Test Procedure	90
4.6.5 Deviation from Test Standard	91
4.6.6 EUT Operating Condition	91
4.6.7 Test Results	91
4.7 6dB Bandwidth Measurement.....	92
4.7.1 Limits of 6dB Bandwidth Measurement.....	92
4.7.2 Test Setup.....	92
4.7.3 Test Instruments	92
4.7.4 Test Procedure	92
4.7.5 Deviation from Test Standard	92
4.7.6 EUT Operating Condition	92
4.7.7 Test Results	93
5 Pictures of Test Arrangements.....	95
Annex A - Band Edge Measurement.....	96
Appendix – Information of the Testing Laboratories	104

Release Control Record

Issue No.	Description	Date Issued
RFBDYS-WTW-P22031091A	Original release	Feb. 15, 2023

1 Certificate of Conformity

Product: Wireless Access Point
Brand: SONICWALL
Test Model: APL68-108
Sample Status: Engineering sample
Applicant: SonicWall Inc.
Test Date: Apr. 08 ~ Jul. 26, 2022
Standards: 47 CFR FCC Part 15, Subpart E (Section 15.407)
ANSI C63.10:2013

The above equipment has been tested by **Bureau Veritas Consumer Products Services (H.K.) Ltd., Taoyuan Branch**, and found compliance with the requirement of the above standards. The test record, data evaluation & Equipment Under Test (EUT) configurations represented herein are true and accurate accounts of the measurements of the sample's RF characteristics under the conditions specified in this report.

Prepared by : Celine Chou , **Date:** Feb. 15, 2023
Celine Chou / Senior Specialist

Approved by : Jeremy Lin , **Date:** Feb. 15, 2023
Jeremy Lin / Project Engineer

2 Summary of Test Results

47 CFR FCC Part 15, Subpart E (Section 15.407)			
FCC Clause	Test Item	Result	Remarks
15.407(b)(9)	AC Power Conducted Emissions	Pass	Meet the requirement of limit. Minimum passing margin is -7.22dB at 0.52567MHz.
15.407(b)(1/2/3/4(i/ii)/9)	Radiated Emissions & Band Edge Measurement	Pass	Meet the requirement of limit. Minimum passing margin is -0.44dB at 15900.00MHz.
15.407(a)(1/2/3)	Max Average Transmit Power	Pass	Meet the requirement of limit.
---	Occupied Bandwidth Measurement	-	Reference only.
15.407(a)(1/2/3)	Peak Power Spectral Density	Pass	Meet the requirement of limit.
15.407(e)	6dB bandwidth	Pass	Meet the requirement of limit. (U-NII-3 Band only)
15.407(g)	Frequency Stability	Pass	Meet the requirement of limit.
15.203	Antenna Requirement	Pass	Antenna connector is I-PEX not a standard connector.

Note:

- For U-NII-2A, U-NII-2C band compliance with rule 15.407(b) of the band-edge items, the test plots were recorded in Annex B. Test Procedures refer to report 4.1.3.
- Determining compliance based on the results of the compliance measurement, not taking into account measurement instrumentation uncertainty.

2.1 Measurement Uncertainty

Where relevant, the following measurement uncertainty levels have been estimated for tests performed on the EUT as specified in CISPR 16-4-2:

Measurement	Frequency	Expanded Uncertainty (k=2) (±)
Conducted Emissions at mains ports	150kHz ~ 30MHz	2.79 dB
Radiated Emissions up to 1 GHz	9kHz ~ 30MHz	3.00 dB
	30MHz ~ 200MHz	2.91 dB
	200MHz ~ 1000MHz	2.93 dB
Radiated Emissions above 1 GHz	1GHz ~ 18GHz	1.76 dB
	18GHz ~ 40GHz	1.77 dB

2.2 Modification Record

There were no modifications required for compliance.

3 General Information

3.1 General Description of EUT

Product	Wireless Access Point
Brand	SONICWALL
Test Model	APL68-108
Sample Status	Engineering sample
Power Supply Rating	12Vdc from adapter 48-56Vdc from POE
Modulation Type	256QAM, 64QAM, 16QAM, QPSK, BPSK for OFDM 1024QAM, 256QAM, 64QAM, 16QAM, QPSK, BPSK for OFDMA
Modulation Technology	OFDM, OFDMA
Transfer Rate	802.11a: 54/48/36/24/18/12/9/6Mbps 802.11n: up to 300Mbps 802.11ac: up to 866.7Mbps 802.11ax: up to 1200Mbps
Operating Frequency	5260 ~ 5320MHz, 5500 ~ 5720MHz
Number of Channel	5G traffic radio (Radio 1): 5260 ~ 5320MHz: 802.11a, 802.11n (HT20), 802.11ac (VHT20), 802.11ax (HE20): 4 802.11n (HT40), 802.11ac (VHT40), 802.11ax (HE40): 2 802.11ac (VHT80), 802.11ax (HE80): 1 5500 ~ 5720MHz: 802.11a, 802.11n (HT20), 802.11ac (VHT20), 802.11ax (HE20): 12 802.11n (HT40), 802.11ac (VHT40), 802.11ax (HE40): 6 802.11ac (VHT80), 802.11ax (HE80): 3
Output Power	5G traffic radio (Radio 1): CDD Mode: 5260 ~ 5320MHz: 160.651mW 5500 ~ 5720MHz: 244.342mW Beamforming Mode: 5260 ~ 5320MHz: 160.651mW 5500 ~ 5720MHz: 158.691mW
Antenna Type	Refer to note
Antenna Connector	Refer to note
Accessory Device	BRACKET T-BAR LFP (Brand: Senao, model: 6301A4133020)
Cable Supplied	NA

Note:

1. This report is prepared for FCC class II permissive change. The difference compared with the original report (BV CPS report no.: RFBDYS-WTW-P22031091-1) is adding 5.26GHz to 5.32GHz and 5.50GHz to 5.72GHz by software.
2. The EUT incorporates a MIMO function. Physically, the EUT provides 2 completed transmitters and 2 receivers.

Radio	Modulation Mode	Beamforming Mode	TX Function
5G traffic radio (Radio 1)	802.11a	Not Support	2TX
	802.11n (HT20)	Support	2TX
	802.11n (HT40)	Support	2TX
	802.11ac (VHT20)	Support	2TX
	802.11ac (VHT40)	Support	2TX
	802.11ac (VHT80)	Support	2TX
	802.11ax (HE20)	Support	2TX
	802.11ax (HE40)	Support	2TX
	802.11ax (HE80)	Support	2TX

* The bandwidth and modulation are similar for HT20/HT40 on 802.11n mode and VHT20/VHT40/VHT80 on 802.11ac mode and HE20/HE40/HE80 on 802.11ax mode. Therefore the investigated worst case is the representative mode in test report. (Final test mode refer section 3.2.1)

* CDD mode is the worst case for final tests after pretesting CDD mode and Beamforming mode except output power test.

3. The EUT consumes power from the following adapter and POE.

Adapter (Optional)	
Brand	Sunny
Model	SYS1546-3612-T3
Input Power	100-240Vac, 50-60Hz, 1.5A Max
Output Power	12Vdc, 3.0A
Power cord	Non-shielded AC (1.77m) Non-shielded DC (1.86m) with one core

POE (Support unit only)	
Brand	EnGenius
Model	EPA5006GAT
Input Power	100-240Vac, 50-60Hz, 0.8A
Output Power	48-56Vdc, 0.6A
Power cord	Non-shielded AC (0.5m)

4. The antenna information is listed as below.

No.	Type	Connector	Gain (dBi)					
			2400MHz	2450MHz	2500MHz	5150MHz	5500MHz	5850MHz
2G1	PIFA	I-PEX	3.05	3.14	3.21	-	-	-
2G2	PIFA	I-PEX	3.52	3.43	3.64	-	-	-
5G1	PIFA	I-PEX	-	-	-	4.52	4.63	5.07
5G2	PIFA	I-PEX	-	-	-	4.13	4.98	4.62
Scan	PIFA	I-PEX	3.83	3.93	3.81	3.81	4.23	4.89
BLE	PIFA	I-PEX	3.09	3.70	3.58	-	-	-

* Detail antenna specification please refer to antenna datasheet and/or antenna measurement report.

5. The simultaneous operation mode was determined by client.

No	Mode
1	2GHz traffic radio (Radio 2) + 5GHz traffic radio (Radio 1) + 5GHz Scanning radio (Radio 3) + BLE
2	5GHz traffic radio (Radio 1) + 2GHz Scanning radio (Radio 3) + BLE

* 5GHz traffic radio (Radio 1) and 5GHz Scanning radio (Radio 3) cannot transmit in the same band at same time.

* 2GHz traffic radio (Radio 2) and 2GHz Scanning radio (Radio 3) cannot transmit at same time.

* Spurious emission of the simultaneous operation has been evaluated and no non-compliance was found.

* 5GHz Scanning radio (Radio 3) in 5260 ~ 5320MHz and 5500 ~ 5720MHz band only support RX function.

3.2 Description of Test Modes

For 5260 ~ 5320MHz:

4 channels are provided for 802.11a, 802.11n (HT20), 802.11ac (VHT20), 802.11ax (HE20):

Channel	Frequency	Channel	Frequency
52	5260 MHz	60	5300 MHz
56	5280 MHz	64	5320 MHz

2 channels are provided for 802.11n (HT40), 802.11ac (VHT40), 802.11ax (HE40):

Channel	Frequency	Channel	Frequency
54	5270 MHz	62	5310 MHz

1 channel is provided for 802.11ac (VHT80), 802.11ax (HE80):

Channel	Frequency
58	5290MHz

For 5500 ~ 5720MHz:

12 channels are provided for 802.11a, 802.11n (HT20), 802.11ac (VHT20), 802.11ax (HE20):

Channel	Frequency	Channel	Frequency
100	5500 MHz	124	5620 MHz
104	5520 MHz	128	5640 MHz
108	5540 MHz	132	5660 MHz
112	5560 MHz	136	5680 MHz
116	5580 MHz	140	5700 MHz
120	5600 MHz	144	5720 MHz

6 channels are provided for 802.11n (HT40), 802.11ac (VHT40), 802.11ax (HE40):

Channel	Frequency	Channel	Frequency
102	5510 MHz	126	5630 MHz
110	5550 MHz	134	5670 MHz
118	5590 MHz	142	5710 MHz

3 channels are provided for 802.11ac (VHT80), 802.11ax (HE80):

Channel	Frequency	Channel	Frequency
106	5530 MHz	122	5610 MHz
138	5690 MHz		

3.2.1 Test Mode Applicability and Tested Channel Detail

EUT Configure Mode	Applicable to				Description
	RE \geq 1G	RE<1G	PLC	APCM	
A	√	√	√	√	Powered by adapter
B	-	√	√	-	Powered by POE

Where RE \geq 1G: Radiated Emission above 1GHz & Bandedge Measurement
 RE<1G: Radiated Emission below 1GHz
 PLC: Power Line Conducted Emission
 APCM: Antenna Port Conducted Measurement

Note:

- The EUT had been pre-tested on the positioned of each 3 axis. The worst case was found when positioned on **Y-plane**.
- Radiated emission test (below 1GHz) and power line conducted emission test items chosen the worst maximum power.

Radiated Emission Test (Above 1GHz):

- Pre-Scan has been conducted to determine the worst-case mode from all possible combinations between available modulations, data rates and antenna ports (if EUT with antenna diversity architecture).
- Following channel(s) was (were) selected for the final test as listed below.

EUT Configure Mode	Mode	Frequency Band (MHz)	Available Channel	Tested Channel	Modulation Technology	Data Rate (Mbps)	Remark
A	802.11a	5260-5320	52 to 64	52, 60, 64	OFDM	6.0	Radio 1
	802.11ax (HE20)		52 to 64	52, 60, 64	OFDMA	MCS0	
	802.11ax (HE40)		54 to 62	54, 62	OFDMA	MCS0	
	802.11ax (HE80)		58	58	OFDMA	MCS0	
A	802.11a	5500-5720	100 to 144	100, 116, 140, 144	OFDM	6.0	
	802.11ax (HE20)		100 to 144	100, 116, 140, 144	OFDMA	MCS0	
	802.11ax (HE40)		102 to 142	102, 110, 134, 142	OFDMA	MCS0	
	802.11ax (HE80)		106 to 138	106, 122, 138	OFDMA	MCS0	

Radiated Emission Test (Below 1GHz):

- Pre-Scan has been conducted to determine the worst-case mode from all possible combinations between available modulations, data rates and antenna ports (if EUT with antenna diversity architecture).
- Following channel(s) was (were) selected for the final test as listed below.

EUT Configure Mode	Mode	Frequency Band (MHz)	Available Channel	Tested Channel	Modulation Technology	Data Rate (Mbps)	Remark
A, B	802.11ax (HE40)	5260-5320	54 to 62	110	OFDMA	MCS0	Radio 1
	802.11ax (HE40)	5500-5720	102 to 142		OFDMA	MCS0	

Power Line Conducted Emission Test:

- Pre-Scan has been conducted to determine the worst-case mode from all possible combinations between available modulations, data rates and antenna ports (if EUT with antenna diversity architecture).
- Following channel(s) was (were) selected for the final test as listed below.

EUT Configure Mode	Mode	Frequency Band (MHz)	Available Channel	Tested Channel	Modulation Technology	Data Rate (Mbps)	Remark
A, B	802.11ax (HE40)	5260-5320	54 to 62	110	OFDMA	MCS0	Radio 1
	802.11ax (HE40)	5500-5720	102 to 142		OFDMA	MCS0	

Bandwidth, Power Spectral Density and Frequency Stability Measurement:

- This item includes all test value of each mode, but only includes spectrum plot of worst value of each mode.
- Pre-Scan has been conducted to determine the worst-case mode from all possible combinations between available modulations, data rates and antenna ports (if EUT with antenna diversity architecture).
- Following channel(s) was (were) selected for the final test as listed below.

EUT Configure Mode	Mode	Frequency Band (MHz)	Available Channel	Tested Channel	Modulation Technology	Data Rate (Mbps)	Remark
A	802.11a	5260-5320	52 to 64	52, 60, 64	OFDM	6.0	Radio 1
	802.11ax (HE20)		52 to 64	52, 60, 64	OFDMA	MCS0	
	802.11ax (HE40)		54 to 62	54, 62	OFDMA	MCS0	
	802.11ax (HE80)		58	58	OFDMA	MCS0	
A	802.11a	5500-5720	100 to 144	100, 116, 140, 144	OFDM	6.0	
	802.11ax (HE20)		100 to 144	100, 116, 140, 144	OFDMA	MCS0	
	802.11ax (HE40)		102 to 142	102, 110, 134, 142	OFDMA	MCS0	
	802.11ax (HE80)		106 to 138	106, 122, 138	OFDMA	MCS0	

Conducted Output Power Measurement:

- This item includes all test value of each mode, but only includes spectrum plot of worst value of each mode.
- Pre-Scan has been conducted to determine the worst-case mode from all possible combinations between available modulations, data rates and antenna ports (if EUT with antenna diversity architecture).
- Following channel(s) was (were) selected for the final test as listed below.

EUT Configure Mode	Mode	Frequency Band (MHz)	Available Channel	Tested Channel	Modulation Technology	Data Rate (Mbps)	Remark
A	802.11a	5260-5320	52 to 64	52, 60, 64	OFDM	6.0	Radio 1
	802.11ac (VHT20)		52 to 64	52, 60, 64	OFDM	MCS0	
	802.11ac (VHT40)		54 to 62	54, 62	OFDM	MCS0	
	802.11ac (VHT80)		58	58	OFDM	MCS0	
	802.11ax (HE20)		52 to 64	52, 60, 64	OFDMA	MCS0	
	802.11ax (HE40)		54 to 62	54, 62	OFDMA	MCS0	
	802.11ax (HE80)		58	58	OFDMA	MCS0	
A	802.11a	5500-5720	100 to 144	100, 116, 140, 144	OFDM	6.0	
	802.11ac (VHT20)		100 to 144	100, 116, 140, 144	OFDM	MCS0	
	802.11ac (VHT40)		102 to 142	102, 110, 134, 142	OFDM	MCS0	
	802.11ac (VHT80)		106 to 138	106, 122, 138	OFDM	MCS0	
	802.11ax (HE20)		100 to 144	100, 116, 140, 144	OFDMA	MCS0	
	802.11ax (HE40)		102 to 142	102, 110, 134, 142	OFDMA	MCS0	
	802.11ax (HE80)		106 to 138	106, 122, 138	OFDMA	MCS0	

Test Condition:

Applicable to	Environmental Conditions	Input Power	Tested by
RE \geq 1G	26 deg. C, 66% RH	120Vac, 60Hz	Randy Wu Adair Peng
RE<1G	26 deg. C, 66% RH 25 deg. C, 77% RH	120Vac, 60Hz 48Vdc	Adair Peng
PLC	23 deg. C, 67% RH 25 deg. C, 75% RH	120Vac, 60Hz 48Vdc	Adair Peng Rex Wang
APCM	22 deg. C, 66% RH	120Vac, 60Hz	Gary Lin Jisyong Wang

3.3 Duty Cycle of Test Signal

5G traffic radio (Radio 1)

Duty cycle of test signal is < 98%, duty factor is required.

802.11a: Duty cycle = $1.421/1.553 = 0.915$, Duty factor = $10 * \log(1/0.915) = 0.39$

802.11ax (HE20): Duty cycle = $5.435/5.680 = 0.957$, Duty factor = $10 * \log(1/0.957) = 0.19$

802.11ax (HE40): Duty cycle = $5.430/5.685 = 0.955$, Duty factor = $10 * \log(1/0.955) = 0.20$

802.11ax (HE80): Duty cycle = $5.400/5.745 = 0.940$, Duty factor = $10 * \log(1/0.940) = 0.27$

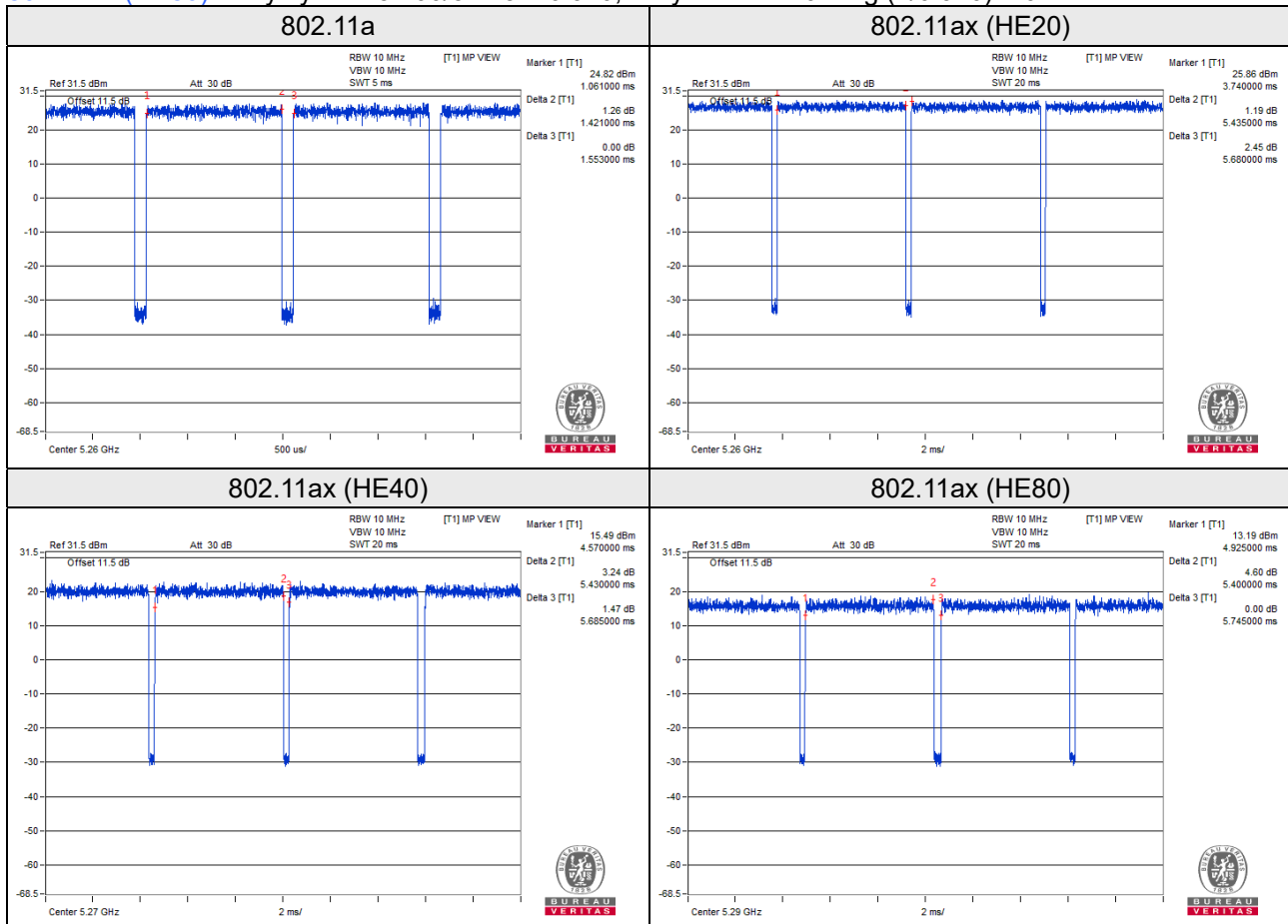

3.4 Description of Support Units

The EUT has been tested as an independent unit together with other necessary accessories or support units. The following support units or accessories were used to form a representative test configuration during the tests.

ID	Product	Brand	Model No.	Serial No.	FCC ID	Remarks
A.	Notebook	DELL	E5410	1HC2XM1	FCC DoC Approved	-
B.	Adapter	Sunny	SYS1546-3612-T3	NA	NA	Provided by client
C.	POE	EnGenius	EPA5006GAT	NA	NA	Provided by client
D.	USB Flash	HP	v250W	5	NA	-

Note:

1. All power cords of the above support units are non-shielded (1.8m).
2. Items A acted as communication partner to transfer data.

ID	Cable Descriptions	Qty.	Length (m)	Shielding (Yes/No)	Cores (Qty.)	Remarks
1.	DC Power Cable	1	1.86	N	1	Provided by client
2.	LAN Cable	1	6.0	N	0	RJ45, Cat5e
3.	LAN Cable	1	1.5	N	0	RJ45, Cat5e
4.	USB Cable	1	1.5	Y	0	-
5.	AC Power Cable	1	1.77	N	0	Provided by client
6.	AC Power Cable	1	0.5	N	0	Provided by client

Note: The core(s) is(are) originally attached to the cable(s).

3.4.1 Configuration of System under Test

Test Mode A

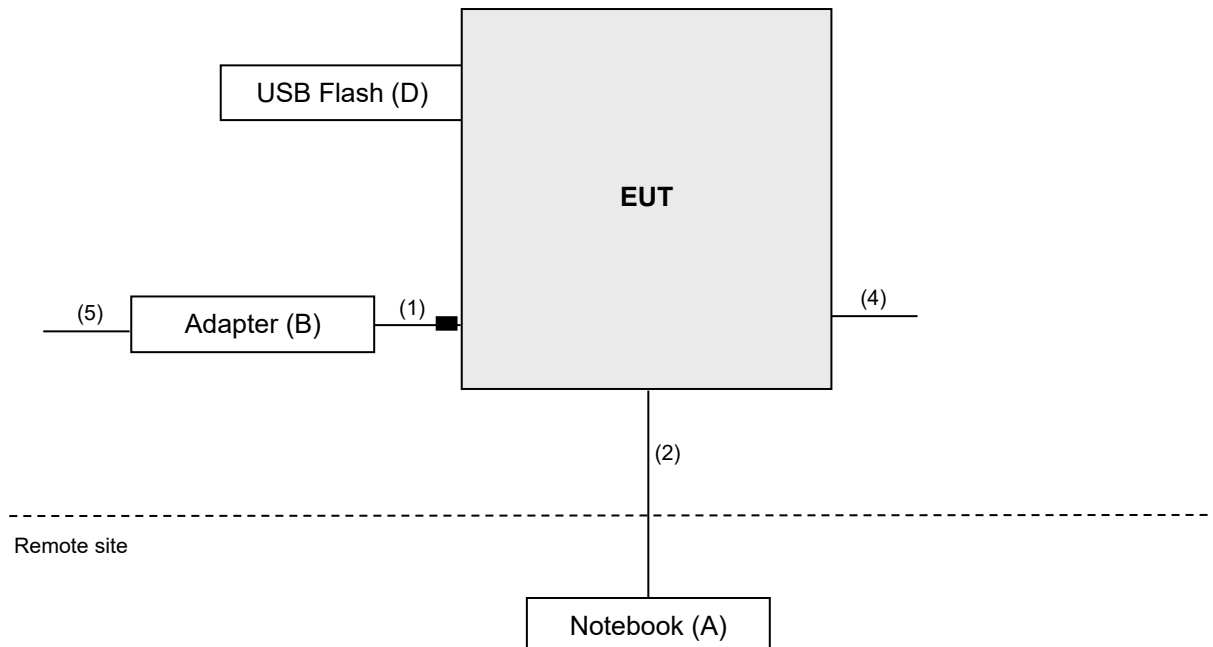

Test Mode B

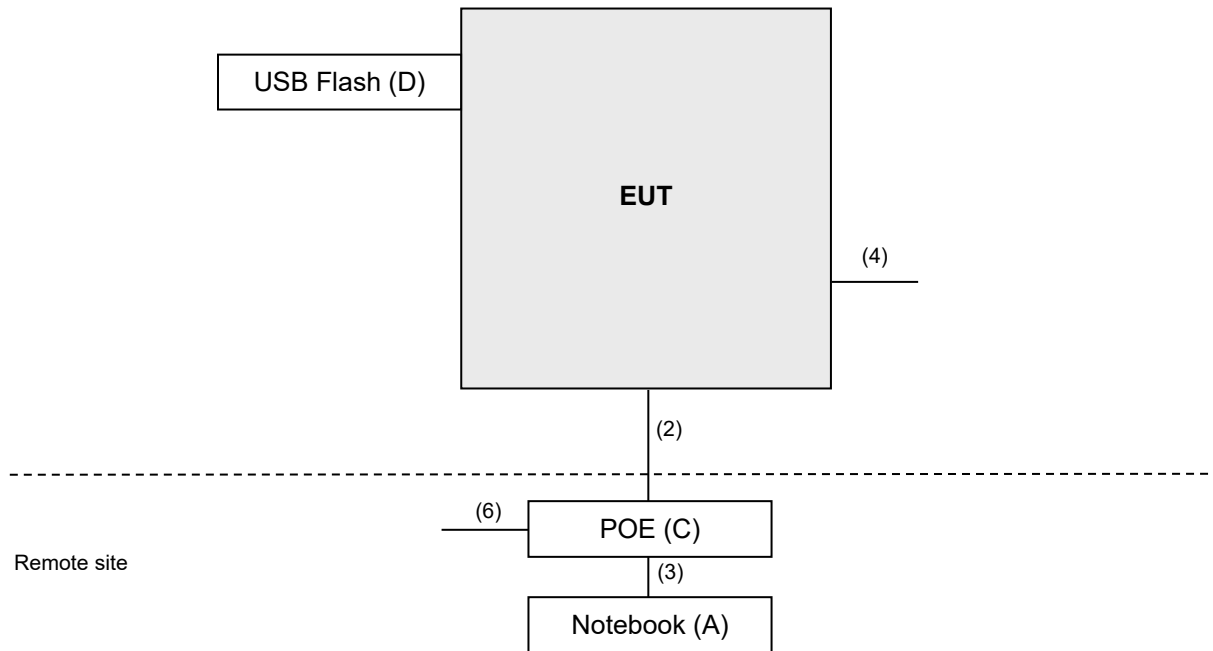

3.5 General Description of Applied Standards and References

The EUT is a RF Product. According to the specifications of the manufacturer, it must comply with the requirements of the following standards and references:

Test standard:

FCC Part 15, Subpart E (15.407)

ANSI C63.10:2013

All test items have been performed and recorded as per the above standards.

References Test Guidance:

KDB 789033 D02 General UNII Test Procedure New Rules v02r01

KDB 662911 D01 Multiple Transmitter Output v02r01

All test items have been performed as a reference to the above KDB test guidance.

4 Test Types and Results

4.1 Radiated Emission and Bandedge Measurement

4.1.1 Limits of Radiated Emission and Bandedge Measurement

Radiated emissions which fall in the restricted bands must comply with the radiated emission limits specified as below table.

Frequencies (MHz)	Field Strength (microvolts/meter)	Measurement Distance (meters)
0.009 ~ 0.490	2400/F(kHz)	300
0.490 ~ 1.705	24000/F(kHz)	30
1.705 ~ 30.0	30	30
30 ~ 88	100	3
88 ~ 216	150	3
216 ~ 960	200	3
Above 960	500	3

Note:

1. The lower limit shall apply at the transition frequencies.
2. Emission level (dBuV/m) = 20 log Emission level (uV/m).
3. For frequencies above 1000MHz, the field strength limits are based on average detector, however, the peak field strength of any emission shall not exceed the maximum permitted average limits, specified above by more than 20dB under any condition of modulation.

Limits of unwanted emission out of the restricted bands

Applicable To		Limit	
789033 D02 General UNII Test Procedure New Rules v02r01		Field Strength at 3m	
		PK: 74 (dBuV/m)	AV: 54 (dBuV/m)
Frequency Band	Applicable To	EIRP Limit	Equivalent Field Strength at 3m
5150~5250 MHz	15.407(b)(1)	PK: -27 (dBm/MHz)	PK: 68.2(dBuV/m)
5250~5350 MHz	15.407(b)(2)		
5470~5725 MHz	15.407(b)(3)		
5725~5850 MHz	15.407(b)(4)(i)	PK: -27 (dBm/MHz) ^{*1} PK: 10 (dBm/MHz) ^{*2} PK: 15.6 (dBm/MHz) ^{*3} PK: 27 (dBm/MHz) ^{*4}	PK: 68.2(dBuV/m) ^{*1} PK: 105.2 (dBuV/m) ^{*2} PK: 110.8(dBuV/m) ^{*3} PK: 122.2 (dBuV/m) ^{*4}
^{*1} beyond 75 MHz or more above of the band edge.		^{*2} below the band edge increasing linearly to 10 dBm/MHz at 25 MHz above.	
^{*3} below the band edge increasing linearly to a level of 15.6 dBm/MHz at 5 MHz above.		^{*4} from 5 MHz above or below the band edge increasing linearly to a level of 27 dBm/MHz at the band edge.	

Note: The following formula is used to convert the equipment isotropic radiated power (eirp) to field strength:

$$E = \frac{1000000 \sqrt{30 P}}{3} \mu\text{V/m, where P is the eirp (Watts).}$$

4.1.2 Test Instruments

Description & Manufacturer	Model No.	Serial No.	Cal. Date	Cal. Due
Test Receiver ROHDE & SCHWARZ	ESR3	102782	Dec. 10, 2021	Dec. 09, 2022
Spectrum Analyzer ROHDE & SCHWARZ	FSW43	101866	Jan. 14, 2022	Jan. 13, 2023
BILOG Antenna SCHWARZBECK	VULB9168	9168-1213	Oct. 27, 2021	Oct. 26, 2022
HORN Antenna RF SPIN	DRH18-E	210103A18E	Nov. 14, 2021	Nov. 13, 2022
HORN Antenna SCHWARZBECK	BBHA 9170	9170-1048	Nov. 14, 2021	Nov. 13, 2022
Loop Antenna EMCI	EM-6879	269	Sep. 16, 2021	Sep. 15, 2022
Preamplifier EMCI (Below 1GHz)	EMC330N	980782	Jan. 17, 2022	Jan. 16, 2023
Preamplifier EMCI (Above 1GHz)	EMC118A45SE	980808	Dec. 30, 2021	Dec. 29, 2022
Preamplifier EMCI (18GHz~40GHz)	EMC184045SE	980788	Jan. 17, 2022	Jan. 16, 2023
RF signal cable EMCI	EMC104-SM-SM-(9 000+2000+1000)	201243+ 201231+ 210102	Jan. 17, 2022	Jan. 16, 2023
RF signal cable EMCI	EMCCFD400-NM-N M-(9000+300+500)	201236+ 201235+ 201233	Jan. 17, 2022	Jan. 16, 2023
RF signal cable EMCI	EMC101G-KM-KM- (5000+3000+2000)	201260+201257+20125 4	Jan. 17, 2022	Jan. 16, 2023
Software BV ADT	ADT_Radiated_ V7.6.15.9.5	NA	NA	NA
Antenna Tower & Turn Max-Full	MFT-151SS-0.5T	NA	NA	NA
Turn Table Max-Full	MF-7802BS	NA	NA	NA
Turn Table Controller Max-Full	MF-7802BS	MF780208674	NA	NA
Turn Table Controller Max-Full	MF-7802BS	MF780208674	NA	NA
Peak Power Analyzer KEYSIGHT	8990B	MY51000485	Jan. 18, 2022	Jan. 17, 2023
Wideband Power Sensor KEYSIGHT	N1923A	MY58020002	Jan. 17, 2022	Jan. 16, 2023

- Note: 1. The calibration interval of the above test instruments is 12 months and the calibrations are traceable to NML/ROC and NIST/USA.
 2. The test was performed in WM Chamber 8.

4.1.3 Test Procedures

For Radiated emission below 30MHz

- a. The EUT was placed on the top of a rotating table 0.8 meters above the ground at a 3 meter chamber room. The table was rotated 360 degrees to determine the position of the highest radiation.
- b. The EUT was set 3 meters away from the interference-receiving antenna, which was mounted on the top of a variable-height antenna tower.
- c. Parallel, perpendicular, and ground-parallel orientations of the antenna are set to make the measurement.
- d. For each suspected emission, the EUT was arranged to its worst case and the rotatable table was turned from 0 degrees to 360 degrees to find the maximum reading.
- e. The test-receiver system was set to Quasi-Peak Detect Function and Specified Bandwidth with Maximum Hold Mode.

Note:

1. The resolution bandwidth and video bandwidth of test receiver/spectrum analyzer is 9kHz at frequency below 30MHz.

For Radiated emission above 30MHz

- a. The EUT was placed on the top of a rotating table 0.8 meters (for 30MHz ~ 1GHz) / 1.5 meters (for above 1GHz) above the ground at 3 meter chamber room for test. The table was rotated 360 degrees to determine the position of the highest radiation.
- b. The EUT was set 3 meters away from the interference-receiving antenna, which was mounted on the top of a variable-height antenna tower.
- c. The height of antenna is varied from one meter to four meters above the ground to determine the maximum value of the field strength. Both horizontal and vertical polarizations of the antenna are set to make the measurement.
- d. For each suspected emission, the EUT was arranged to its worst case and then the antenna was tuned to heights from 1 meter to 4 meters and the rotatable table was turned from 0 degrees to 360 degrees to find the maximum reading.
- e. The test-receiver system was set to quasi-peak detect function and specified bandwidth with maximum hold mode when the test frequency is below 1 GHz.
- f. The test-receiver system was set to peak and average detect function and specified bandwidth with maximum hold mode when the test frequency is above 1 GHz. If the peak reading value also meets average limit, measurement with the average detector is unnecessary.

Note:

1. The resolution bandwidth and video bandwidth of test receiver/spectrum analyzer is 120kHz for Quasi-peak detection (QP) at frequency below 1GHz.
2. The resolution bandwidth of test receiver/spectrum analyzer is 1 MHz and the video bandwidth is 3 MHz for Peak detection (PK) at frequency above 1GHz.
3. The resolution bandwidth of test receiver/spectrum analyzer is 1MHz and the video bandwidth is $\geq 1/T$ (Duty cycle < 98%) or 10Hz (Duty cycle $\geq 98\%$) for Average detection (AV) at frequency above 1GHz.
5G traffic radio (Radio 1)
(802.11a: RBW = 1MHz, VBW = 1kHz; 802.11ax (HE20): RBW = 1MHz, VBW = 1kHz;
802.11ax (HE40): RBW = 1MHz, VBW = 1kHz; 802.11ax (HE80): RBW = 1MHz, VBW = 1kHz)
4. All modes of operation were investigated and the worst-case emissions are reported.

4.1.4 Deviation from Test Standard

No deviation.

4.1.5 Test Setup

For Radiated emission below 30MHz

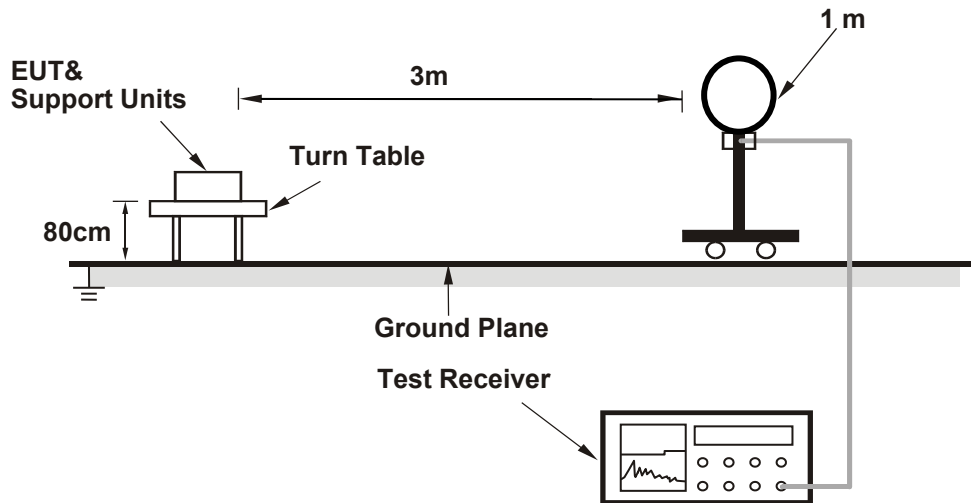

For Radiated emission 30MHz to 1GHz

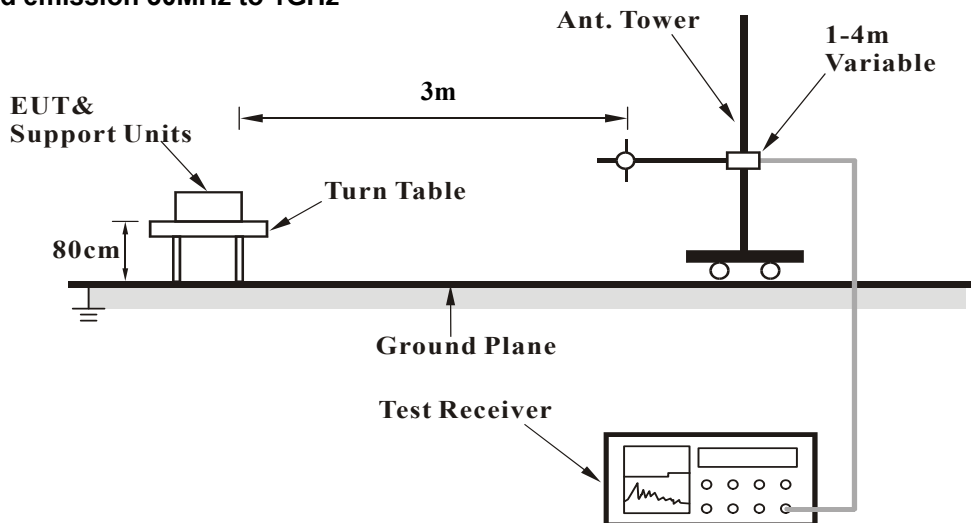

For Radiated emission above 1GHz

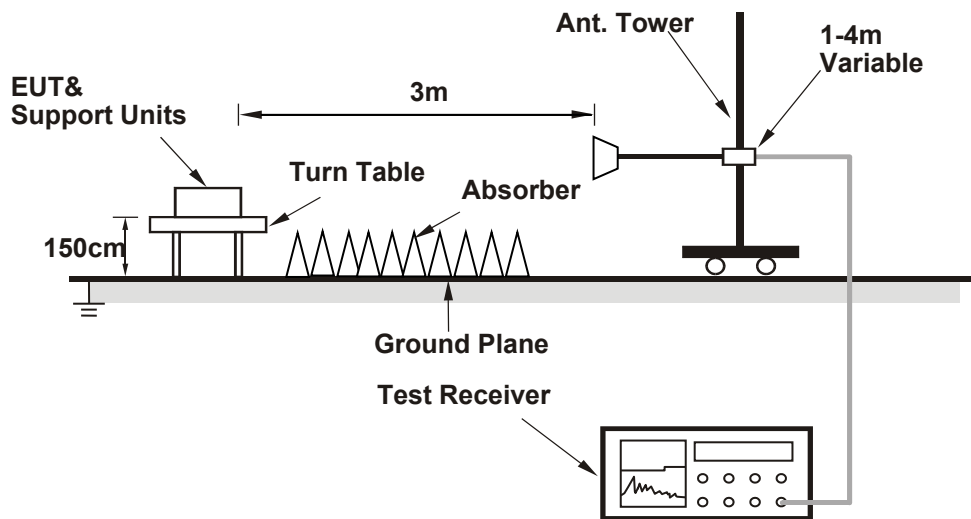

For the actual test configuration, please refer to the attached file (Test Setup Photo).

4.1.6 EUT Operating Conditions

- a. Placed the EUT on the testing table.
- b. Prepared a notebook to act as a communication partner and placed it outside of testing area.
- c. The communication partner connected with EUT via an RJ45 cable and ran a test program (provided by manufacturer) to enable EUT under transmission condition continuously at specific channel frequency.

4.1.7 Test Results

Above 1GHz data:

5G traffic radio (Radio 1)

RF Mode	TX 802.11a	Channel	CH 52 : 5260 MHz
Frequency Range	1GHz ~ 40GHz	Detector Function	Peak (PK) Average (AV)

Antenna Polarity & Test Distance : Horizontal at 3 m								
No	Frequency (MHz)	Emission Level (dBuV/m)	Limit (dBuV/m)	Margin (dB)	Antenna Height (m)	Table Angle (Degree)	Raw Value (dBuV)	Correction Factor (dB/m)
1	5088.00	60.52 PK	74.00	-13.48	1.09 H	60	58.20	2.32
2	5088.00	50.52 AV	54.00	-3.48	1.09 H	60	48.20	2.32
3	5150.00	60.10 PK	74.00	-13.90	1.00 H	65	57.70	2.40
4	5150.00	46.10 AV	54.00	-7.90	1.00 H	65	43.70	2.40
5	*5260.00	119.36 PK			1.03 H	62	79.30	40.06
6	*5260.00	109.26 AV			1.03 H	62	69.20	40.06
7	#10520.00	56.85 PK	68.20	-11.35	2.97 H	312	48.30	8.55
8	15780.00	65.70 PK	74.00	-8.30	3.39 H	300	53.50	12.20
9	15780.00	52.60 AV	54.00	-1.40	3.39 H	300	40.40	12.20
Antenna Polarity & Test Distance : Vertical at 3 m								
No	Frequency (MHz)	Emission Level (dBuV/m)	Limit (dBuV/m)	Margin (dB)	Antenna Height (m)	Table Angle (Degree)	Raw Value (dBuV)	Correction Factor (dB/m)
1	5088.00	57.82 PK	74.00	-16.18	3.31 V	20	55.50	2.32
2	5088.00	44.62 AV	54.00	-9.38	3.31 V	20	42.30	2.32
3	5150.00	57.80 PK	74.00	-16.20	3.38 V	23	55.40	2.40
4	5150.00	45.80 AV	54.00	-8.20	3.38 V	23	43.40	2.40
5	*5260.00	115.86 PK			3.36 V	15	75.80	40.06
6	*5260.00	105.86 AV			3.36 V	15	65.80	40.06
7	#10520.00	57.35 PK	68.20	-10.85	3.46 V	37	48.80	8.55
8	15780.00	66.00 PK	74.00	-8.00	1.60 V	28	53.80	12.20
9	15780.00	53.10 AV	54.00	-0.90	1.60 V	28	40.90	12.20

Remarks:

1. Emission Level(dBuV/m) = Raw Value(dBuV) + Correction Factor(dB/m).
2. Correction Factor(dB/m) = Antenna Factor(dB/m) + Cable Factor(dB) – Pre-Amplifier Factor(dB).
3. Margin value = Emission Level – Limit value.
4. The other emission levels were very low against the limit.
5. " * " : Fundamental frequency.
6. " # " : The radiated frequency is out of the restricted band.

RF Mode	TX 802.11a	Channel	CH 60 : 5300 MHz
Frequency Range	1GHz ~ 40GHz	Detector Function	Peak (PK) Average (AV)

Antenna Polarity & Test Distance : Horizontal at 3 m								
No	Frequency (MHz)	Emission Level (dBuV/m)	Limit (dBuV/m)	Margin (dB)	Antenna Height (m)	Table Angle (Degree)	Raw Value (dBuV)	Correction Factor (dB/m)
1	*5300.00	119.70 PK			1.03 H	63	79.70	40.00
2	*5300.00	109.60 AV			1.03 H	63	69.60	40.00
3	10600.00	57.08 PK	74.00	-16.92	3.07 H	316	48.30	8.78
4	10600.00	44.08 AV	54.00	-9.92	3.07 H	316	35.30	8.78
5	15900.00	67.56 PK	74.00	-6.44	3.36 H	297	55.30	12.26
6	15900.00	52.46 AV	54.00	-1.54	3.36 H	297	40.20	12.26

Antenna Polarity & Test Distance : Vertical at 3 m								
No	Frequency (MHz)	Emission Level (dBuV/m)	Limit (dBuV/m)	Margin (dB)	Antenna Height (m)	Table Angle (Degree)	Raw Value (dBuV)	Correction Factor (dB/m)
1	*5300.00	116.30 PK			3.37 V	21	76.30	40.00
2	*5300.00	106.10 AV			3.37 V	21	66.10	40.00
3	10600.00	57.48 PK	74.00	-16.52	3.31 V	36	48.70	8.78
4	10600.00	44.68 AV	54.00	-9.32	3.31 V	36	35.90	8.78
5	15900.00	68.36 PK	74.00	-5.64	1.67 V	31	56.10	12.26
6	15900.00	53.26 AV	54.00	-0.74	1.67 V	31	41.00	12.26

Remarks:

1. Emission Level(dBuV/m) = Raw Value(dBuV) + Correction Factor(dB/m).
2. Correction Factor(dB/m) = Antenna Factor(dB/m) + Cable Factor(dB) – Pre-Amplifier Factor(dB).
3. Margin value = Emission Level – Limit value.
4. The other emission levels were very low against the limit.
5. " * " : Fundamental frequency.

RF Mode	TX 802.11a	Channel	CH 64 : 5320 MHz
Frequency Range	1GHz ~ 40GHz	Detector Function	Peak (PK) Average (AV)

Antenna Polarity & Test Distance : Horizontal at 3 m								
No	Frequency (MHz)	Emission Level (dBuV/m)	Limit (dBuV/m)	Margin (dB)	Antenna Height (m)	Table Angle (Degree)	Raw Value (dBuV)	Correction Factor (dB/m)
1	*5320.00	118.76 PK			1.08 H	63	78.70	40.06
2	*5320.00	109.26 AV			1.08 H	63	69.20	40.06
3	5350.00	65.65 PK	74.00	-8.35	1.00 H	62	63.60	2.05
4	5350.00	53.05 AV	54.00	-0.95	1.00 H	62	51.00	2.05
5	10640.00	56.81 PK	74.00	-17.19	3.15 H	309	48.20	8.61
6	10640.00	43.51 AV	54.00	-10.49	3.15 H	309	34.90	8.61
7	15960.00	62.58 PK	74.00	-11.42	3.11 H	308	50.50	12.08
8	15960.00	49.78 AV	54.00	-4.22	3.11 H	308	37.70	12.08
Antenna Polarity & Test Distance : Vertical at 3 m								
No	Frequency (MHz)	Emission Level (dBuV/m)	Limit (dBuV/m)	Margin (dB)	Antenna Height (m)	Table Angle (Degree)	Raw Value (dBuV)	Correction Factor (dB/m)
1	*5320.00	115.46 PK			3.55 V	343	75.40	40.06
2	*5320.00	105.56 AV			3.55 V	343	65.50	40.06
3	5350.00	62.45 PK	74.00	-11.55	3.51 V	343	60.40	2.05
4	5350.00	49.35 AV	54.00	-4.65	3.51 V	343	47.30	2.05
5	10640.00	57.11 PK	74.00	-16.89	3.52 V	33	48.50	8.61
6	10640.00	43.71 AV	54.00	-10.29	3.52 V	33	35.10	8.61
7	15960.00	64.08 PK	74.00	-9.92	1.85 V	19	52.00	12.08
8	15960.00	50.88 AV	54.00	-3.12	1.85 V	19	38.80	12.08

Remarks:

1. Emission Level(dBuV/m) = Raw Value(dBuV) + Correction Factor(dB/m).
2. Correction Factor(dB/m) = Antenna Factor(dB/m) + Cable Factor(dB) – Pre-Amplifier Factor(dB).
3. Margin value = Emission Level – Limit value.
4. The other emission levels were very low against the limit.
5. " * " : Fundamental frequency.

RF Mode	TX 802.11a	Channel	CH 100 : 5500 MHz
Frequency Range	1GHz ~ 40GHz	Detector Function	Peak (PK) Average (AV)

Antenna Polarity & Test Distance : Horizontal at 3 m								
No	Frequency (MHz)	Emission Level (dBuV/m)	Limit (dBuV/m)	Margin (dB)	Antenna Height (m)	Table Angle (Degree)	Raw Value (dBuV)	Correction Factor (dB/m)
1	5460.00	63.40 PK	74.00	-10.60	1.05 H	59	61.30	2.10
2	5460.00	47.90 AV	54.00	-6.10	1.05 H	59	45.80	2.10
3	#5470.00	67.43 PK	68.20	-0.77	1.02 H	57	65.30	2.13
4	*5500.00	119.67 PK			1.02 H	61	79.50	40.17
5	*5500.00	109.67 AV			1.02 H	61	69.50	40.17
6	11000.00	57.52 PK	74.00	-16.48	1.02 H	64	48.80	8.72
7	11000.00	44.02 AV	54.00	-9.98	1.02 H	64	35.30	8.72
8	#16500.00	64.80 PK	68.20	-3.40	1.01 H	63	53.60	11.20
Antenna Polarity & Test Distance : Vertical at 3 m								
No	Frequency (MHz)	Emission Level (dBuV/m)	Limit (dBuV/m)	Margin (dB)	Antenna Height (m)	Table Angle (Degree)	Raw Value (dBuV)	Correction Factor (dB/m)
1	5460.00	61.20 PK	74.00	-12.80	2.05 V	13	59.10	2.10
2	5460.00	46.90 AV	54.00	-7.10	2.05 V	13	44.80	2.10
3	#5470.00	66.33 PK	68.20	-1.87	1.99 V	13	64.20	2.13
4	*5500.00	116.47 PK			1.96 V	9	76.30	40.17
5	*5500.00	106.57 AV			1.96 V	9	66.40	40.17
6	11000.00	56.32 PK	74.00	-17.68	1.83 V	9	47.60	8.72
7	11000.00	43.72 AV	54.00	-10.28	1.83 V	9	35.00	8.72
8	#16500.00	64.50 PK	68.20	-3.70	1.84 V	9	53.30	11.20

Remarks:

1. Emission Level(dBuV/m) = Raw Value(dBuV) + Correction Factor(dB/m).
2. Correction Factor(dB/m) = Antenna Factor(dB/m) + Cable Factor(dB) – Pre-Amplifier Factor(dB).
3. Margin value = Emission Level – Limit value.
4. The other emission levels were very low against the limit.
5. " * ": Fundamental frequency.
6. " # ": The radiated frequency is out of the restricted band.

RF Mode	TX 802.11a	Channel	CH 116 : 5580 MHz
Frequency Range	1GHz ~ 40GHz	Detector Function	Peak (PK) Average (AV)

Antenna Polarity & Test Distance : Horizontal at 3 m								
No	Frequency (MHz)	Emission Level (dBuV/m)	Limit (dBuV/m)	Margin (dB)	Antenna Height (m)	Table Angle (Degree)	Raw Value (dBuV)	Correction Factor (dB/m)
1	*5580.00	122.05 PK			1.03 H	59	81.20	40.85
2	*5580.00	112.05 AV			1.03 H	59	71.20	40.85
3	11160.00	57.53 PK	74.00	-16.47	1.01 H	63	48.70	8.83
4	11160.00	44.63 AV	54.00	-9.37	1.01 H	63	35.80	8.83
5	#16740.00	64.42 PK	68.20	-3.78	1.02 H	62	53.50	10.92

Antenna Polarity & Test Distance : Vertical at 3 m								
No	Frequency (MHz)	Emission Level (dBuV/m)	Limit (dBuV/m)	Margin (dB)	Antenna Height (m)	Table Angle (Degree)	Raw Value (dBuV)	Correction Factor (dB/m)
1	*5580.00	118.85 PK			2.00 V	10	78.00	40.85
2	*5580.00	108.95 AV			2.00 V	10	68.10	40.85
3	11160.00	56.23 PK	74.00	-17.77	1.87 V	10	47.40	8.83
4	11160.00	44.33 AV	54.00	-9.67	1.87 V	10	35.50	8.83
5	#16470.00	64.27 PK	68.20	-3.93	1.90 V	11	53.10	11.17

Remarks:

1. Emission Level(dBuV/m) = Raw Value(dBuV) + Correction Factor(dB/m).
2. Correction Factor(dB/m) = Antenna Factor(dB/m) + Cable Factor(dB) – Pre-Amplifier Factor(dB).
3. Margin value = Emission Level – Limit value.
4. The other emission levels were very low against the limit.
5. " * " : Fundamental frequency.
6. " # " : The radiated frequency is out of the restricted band.

RF Mode	TX 802.11a	Channel	CH 140 : 5700 MHz
Frequency Range	1GHz ~ 40GHz	Detector Function	Peak (PK) Average (AV)

Antenna Polarity & Test Distance : Horizontal at 3 m								
No	Frequency (MHz)	Emission Level (dBuV/m)	Limit (dBuV/m)	Margin (dB)	Antenna Height (m)	Table Angle (Degree)	Raw Value (dBuV)	Correction Factor (dB/m)
1	*5700.00	118.01 PK			1.00 H	65	76.60	41.41
2	*5700.00	108.01 AV			1.00 H	65	66.60	41.41
3	#5725.00	67.12 PK	68.20	-1.08	1.05 H	58	63.50	3.62
4	11400.00	58.07 PK	74.00	-15.93	1.05 H	60	48.50	9.57
5	11400.00	45.07 AV	54.00	-8.93	1.05 H	60	35.50	9.57
6	#17100.00	63.18 PK	68.20	-5.02	1.07 H	61	53.00	10.18

Antenna Polarity & Test Distance : Vertical at 3 m								
No	Frequency (MHz)	Emission Level (dBuV/m)	Limit (dBuV/m)	Margin (dB)	Antenna Height (m)	Table Angle (Degree)	Raw Value (dBuV)	Correction Factor (dB/m)
1	*5700.00	114.71 PK			2.07 V	12	73.30	41.41
2	*5700.00	104.81 AV			2.07 V	12	63.40	41.41
3	#5725.00	64.12 PK	68.20	-4.08	1.99 V	10	60.50	3.62
4	11400.00	57.07 PK	74.00	-16.93	1.91 V	8	47.50	9.57
5	11400.00	44.77 AV	54.00	-9.23	1.91 V	8	35.20	9.57
6	#17100.00	62.78 PK	68.20	-5.42	1.88 V	10	52.60	10.18

Remarks:

1. Emission Level(dBuV/m) = Raw Value(dBuV) + Correction Factor(dB/m).
2. Correction Factor(dB/m) = Antenna Factor(dB/m) + Cable Factor(dB) – Pre-Amplifier Factor(dB).
3. Margin value = Emission Level – Limit value.
4. The other emission levels were very low against the limit.
5. " * " : Fundamental frequency.
6. " # " : The radiated frequency is out of the restricted band.

RF Mode	TX 802.11a	Channel	CH 144 : 5720 MHz
Frequency Range	1GHz ~ 40GHz	Detector Function	Peak (PK) Average (AV)

Antenna Polarity & Test Distance : Horizontal at 3 m								
No	Frequency (MHz)	Emission Level (dBuV/m)	Limit (dBuV/m)	Margin (dB)	Antenna Height (m)	Table Angle (Degree)	Raw Value (dBuV)	Correction Factor (dB/m)
1	#5470.00	58.93 PK	68.20	-9.27	1.09 H	62	56.80	2.13
2	*5720.00	119.72 PK			1.04 H	58	78.20	41.52
3	*5720.00	109.72 AV			1.04 H	58	68.20	41.52
4	#5850.00	60.87 PK	68.20	-7.33	1.10 H	60	57.10	3.77
5	11440.00	58.81 PK	74.00	-15.19	1.03 H	60	49.20	9.61
6	11440.00	46.61 AV	54.00	-7.39	1.03 H	60	37.00	9.61
7	#17160.00	64.30 PK	68.20	-3.90	1.01 H	61	54.40	9.90
Antenna Polarity & Test Distance : Vertical at 3 m								
No	Frequency (MHz)	Emission Level (dBuV/m)	Limit (dBuV/m)	Margin (dB)	Antenna Height (m)	Table Angle (Degree)	Raw Value (dBuV)	Correction Factor (dB/m)
1	#5470.00	57.73 PK	68.20	-10.47	2.09 V	13	55.60	2.13
2	*5720.00	116.52 PK			2.02 V	10	75.00	41.52
3	*5720.00	106.62 AV			2.02 V	10	65.10	41.52
4	#5850.00	59.67 PK	68.20	-8.53	2.12 V	9	55.90	3.77
5	11440.00	57.91 PK	74.00	-16.09	1.93 V	12	48.30	9.61
6	11440.00	46.11 AV	54.00	-7.89	1.93 V	12	36.50	9.61
7	#17160.00	63.90 PK	68.20	-4.30	1.89 V	9	54.00	9.90

Remarks:

1. Emission Level(dBuV/m) = Raw Value(dBuV) + Correction Factor(dB/m).
2. Correction Factor(dB/m) = Antenna Factor(dB/m) + Cable Factor(dB) – Pre-Amplifier Factor(dB).
3. Margin value = Emission Level – Limit value.
4. The other emission levels were very low against the limit.
5. " * ": Fundamental frequency.
6. " # ": The radiated frequency is out of the restricted band.

RF Mode	TX 802.11ax (HE20)	Channel	CH 52 : 5260 MHz
Frequency Range	1GHz ~ 40GHz	Detector Function	Peak (PK) Average (AV)

Antenna Polarity & Test Distance : Horizontal at 3 m								
No	Frequency (MHz)	Emission Level (dBuV/m)	Limit (dBuV/m)	Margin (dB)	Antenna Height (m)	Table Angle (Degree)	Raw Value (dBuV)	Correction Factor (dB/m)
1	5088.00	59.82 PK	74.00	-14.18	1.08 H	59	57.50	2.32
2	5088.00	50.02 AV	54.00	-3.98	1.08 H	59	47.70	2.32
3	5150.00	59.70 PK	74.00	-14.30	1.10 H	65	57.30	2.40
4	5150.00	46.30 AV	54.00	-7.70	1.10 H	65	43.90	2.40
5	*5260.00	122.06 PK			1.03 H	61	82.00	40.06
6	*5260.00	109.16 AV			1.03 H	61	69.10	40.06
7	#10520.00	56.85 PK	68.20	-11.35	3.08 H	309	48.30	8.55
8	15780.00	68.70 PK	74.00	-5.30	3.31 H	297	56.50	12.20
9	15780.00	52.70 AV	54.00	-1.30	3.31 H	297	40.50	12.20
Antenna Polarity & Test Distance : Vertical at 3 m								
No	Frequency (MHz)	Emission Level (dBuV/m)	Limit (dBuV/m)	Margin (dB)	Antenna Height (m)	Table Angle (Degree)	Raw Value (dBuV)	Correction Factor (dB/m)
1	5088.00	58.62 PK	74.00	-15.38	3.42 V	20	56.30	2.32
2	5088.00	46.32 AV	54.00	-7.68	3.42 V	20	44.00	2.32
3	5150.00	58.50 PK	74.00	-15.50	3.37 V	19	56.10	2.40
4	5150.00	45.20 AV	54.00	-8.80	3.37 V	19	42.80	2.40
5	*5260.00	118.86 PK			3.36 V	15	78.80	40.06
6	*5260.00	106.06 AV			3.36 V	15	66.00	40.06
7	#10520.00	57.55 PK	68.20	-10.65	3.37 V	35	49.00	8.55
8	15780.00	69.40 PK	74.00	-4.60	2.85 V	13	57.20	12.20
9	15780.00	53.40 AV	54.00	-0.60	2.85 V	13	41.20	12.20

Remarks:

1. Emission Level(dBuV/m) = Raw Value(dBuV) + Correction Factor(dB/m).
2. Correction Factor(dB/m) = Antenna Factor(dB/m) + Cable Factor(dB) – Pre-Amplifier Factor(dB).
3. Margin value = Emission Level – Limit value.
4. The other emission levels were very low against the limit.
5. " * " : Fundamental frequency.
6. " # " : The radiated frequency is out of the restricted band.

RF Mode	TX 802.11ax (HE20)	Channel	CH 60 : 5300 MHz
Frequency Range	1GHz ~ 40GHz	Detector Function	Peak (PK) Average (AV)

Antenna Polarity & Test Distance : Horizontal at 3 m								
No	Frequency (MHz)	Emission Level (dBuV/m)	Limit (dBuV/m)	Margin (dB)	Antenna Height (m)	Table Angle (Degree)	Raw Value (dBuV)	Correction Factor (dB/m)
1	*5300.00	122.00 PK			1.01 H	62	82.00	40.00
2	*5300.00	109.50 AV			1.01 H	62	69.50	40.00
3	10600.00	56.98 PK	74.00	-17.02	3.12 H	308	48.20	8.78
4	10600.00	44.08 AV	54.00	-9.92	3.12 H	308	35.30	8.78
5	15900.00	68.76 PK	74.00	-5.24	3.34 H	306	56.50	12.26
6	15900.00	52.46 AV	54.00	-1.54	3.34 H	306	40.20	12.26
Antenna Polarity & Test Distance : Vertical at 3 m								
No	Frequency (MHz)	Emission Level (dBuV/m)	Limit (dBuV/m)	Margin (dB)	Antenna Height (m)	Table Angle (Degree)	Raw Value (dBuV)	Correction Factor (dB/m)
1	*5300.00	118.70 PK			3.39 V	20	78.70	40.00
2	*5300.00	106.20 AV			3.39 V	20	66.20	40.00
3	10600.00	57.38 PK	74.00	-16.62	3.42 V	37	48.60	8.78
4	10600.00	44.38 AV	54.00	-9.62	3.42 V	37	35.60	8.78
5	15900.00	69.66 PK	74.00	-4.34	1.68 V	30	57.40	12.26
6	15900.00	53.56 AV	54.00	-0.44	1.68 V	30	41.30	12.26

Remarks:

1. Emission Level(dBuV/m) = Raw Value(dBuV) + Correction Factor(dB/m).
2. Correction Factor(dB/m) = Antenna Factor(dB/m) + Cable Factor(dB) – Pre-Amplifier Factor(dB).
3. Margin value = Emission Level – Limit value.
4. The other emission levels were very low against the limit.
5. " * " : Fundamental frequency.

RF Mode	TX 802.11ax (HE20)	Channel	CH 64 : 5320 MHz
Frequency Range	1GHz ~ 40GHz	Detector Function	Peak (PK) Average (AV)

Antenna Polarity & Test Distance : Horizontal at 3 m								
No	Frequency (MHz)	Emission Level (dBuV/m)	Limit (dBuV/m)	Margin (dB)	Antenna Height (m)	Table Angle (Degree)	Raw Value (dBuV)	Correction Factor (dB/m)
1	*5320.00	121.16 PK			1.02 H	62	81.10	40.06
2	*5320.00	108.36 AV			1.02 H	62	68.30	40.06
3	5350.00	68.55 PK	74.00	-5.45	1.01 H	61	66.50	2.05
4	5350.00	53.25 AV	54.00	-0.75	1.01 H	61	51.20	2.05
5	10640.00	57.11 PK	74.00	-16.89	3.19 H	297	48.50	8.61
6	10640.00	43.81 AV	54.00	-10.19	3.19 H	297	35.20	8.61
7	15960.00	66.58 PK	74.00	-7.42	3.29 H	310	54.50	12.08
8	15960.00	50.98 AV	54.00	-3.02	3.29 H	310	38.90	12.08
Antenna Polarity & Test Distance : Vertical at 3 m								
No	Frequency (MHz)	Emission Level (dBuV/m)	Limit (dBuV/m)	Margin (dB)	Antenna Height (m)	Table Angle (Degree)	Raw Value (dBuV)	Correction Factor (dB/m)
1	*5320.00	118.06 PK			3.26 V	22	78.00	40.06
2	*5320.00	105.56 AV			3.26 V	22	65.50	40.06
3	5350.00	65.25 PK	74.00	-8.75	3.30 V	20	63.20	2.05
4	5350.00	51.65 AV	54.00	-2.35	3.30 V	20	49.60	2.05
5	10640.00	57.51 PK	74.00	-16.49	3.39 V	39	48.90	8.61
6	10640.00	44.21 AV	54.00	-9.79	3.39 V	39	35.60	8.61
7	15960.00	67.58 PK	74.00	-6.42	1.30 V	27	55.50	12.08
8	15960.00	51.88 AV	54.00	-2.12	1.30 V	27	39.80	12.08

Remarks:

1. Emission Level(dBuV/m) = Raw Value(dBuV) + Correction Factor(dB/m).
2. Correction Factor(dB/m) = Antenna Factor(dB/m) + Cable Factor(dB) – Pre-Amplifier Factor(dB).
3. Margin value = Emission Level – Limit value.
4. The other emission levels were very low against the limit.
5. " * " : Fundamental frequency.

RF Mode	TX 802.11ax (HE20)	Channel	CH 100 : 5500 MHz
Frequency Range	1GHz ~ 40GHz	Detector Function	Peak (PK) Average (AV)

Antenna Polarity & Test Distance : Horizontal at 3 m								
No	Frequency (MHz)	Emission Level (dBuV/m)	Limit (dBuV/m)	Margin (dB)	Antenna Height (m)	Table Angle (Degree)	Raw Value (dBuV)	Correction Factor (dB/m)
1	5460.00	59.70 PK	74.00	-14.30	1.07 H	61	57.60	2.10
2	5460.00	48.30 AV	54.00	-5.70	1.07 H	61	46.20	2.10
3	#5470.00	67.53 PK	68.20	-0.67	1.00 H	65	65.40	2.13
4	*5500.00	120.87 PK			1.05 H	63	80.70	40.17
5	*5500.00	108.07 AV			1.05 H	63	67.90	40.17
6	11000.00	57.22 PK	74.00	-16.78	1.07 H	58	48.50	8.72
7	11000.00	44.42 AV	54.00	-9.58	1.07 H	58	35.70	8.72
8	#16500.00	64.70 PK	68.20	-3.50	1.11 H	58	53.50	11.20
Antenna Polarity & Test Distance : Vertical at 3 m								
No	Frequency (MHz)	Emission Level (dBuV/m)	Limit (dBuV/m)	Margin (dB)	Antenna Height (m)	Table Angle (Degree)	Raw Value (dBuV)	Correction Factor (dB/m)
1	5460.00	57.30 PK	74.00	-16.70	2.01 V	23	55.20	2.10
2	5460.00	46.20 AV	54.00	-7.80	2.01 V	23	44.10	2.10
3	#5470.00	63.53 PK	68.20	-4.67	2.19 V	19	61.40	2.13
4	*5500.00	117.67 PK			2.12 V	20	77.50	40.17
5	*5500.00	104.77 AV			2.12 V	20	64.60	40.17
6	11000.00	56.82 PK	74.00	-17.18	2.01 V	11	48.10	8.72
7	11000.00	43.92 AV	54.00	-10.08	2.01 V	11	35.20	8.72
8	#16500.00	63.50 PK	68.20	-4.70	1.93 V	15	52.30	11.20

Remarks:

1. Emission Level(dBuV/m) = Raw Value(dBuV) + Correction Factor(dB/m).
2. Correction Factor(dB/m) = Antenna Factor(dB/m) + Cable Factor(dB) – Pre-Amplifier Factor(dB).
3. Margin value = Emission Level – Limit value.
4. The other emission levels were very low against the limit.
5. " * ": Fundamental frequency.
6. " # ": The radiated frequency is out of the restricted band.

RF Mode	TX 802.11ax (HE20)	Channel	CH 116 : 5580 MHz
Frequency Range	1GHz ~ 40GHz	Detector Function	Peak (PK) Average (AV)

Antenna Polarity & Test Distance : Horizontal at 3 m								
No	Frequency (MHz)	Emission Level (dBuV/m)	Limit (dBuV/m)	Margin (dB)	Antenna Height (m)	Table Angle (Degree)	Raw Value (dBuV)	Correction Factor (dB/m)
1	*5580.00	123.45 PK			1.01 H	63	82.60	40.85
2	*5580.00	110.85 AV			1.01 H	63	70.00	40.85
3	11160.00	57.33 PK	74.00	-16.67	1.07 H	60	48.50	8.83
4	11160.00	44.53 AV	54.00	-9.47	1.07 H	60	35.70	8.83
5	#16740.00	64.32 PK	68.20	-3.88	1.02 H	59	53.40	10.92

Antenna Polarity & Test Distance : Vertical at 3 m								
No	Frequency (MHz)	Emission Level (dBuV/m)	Limit (dBuV/m)	Margin (dB)	Antenna Height (m)	Table Angle (Degree)	Raw Value (dBuV)	Correction Factor (dB/m)
1	*5580.00	120.45 PK			2.09 V	16	79.60	40.85
2	*5580.00	107.85 AV			2.09 V	16	67.00	40.85
3	11160.00	56.33 PK	74.00	-17.67	1.97 V	10	47.50	8.83
4	11160.00	44.03 AV	54.00	-9.97	1.97 V	10	35.20	8.83
5	#16740.00	63.72 PK	68.20	-4.48	1.90 V	12	52.80	10.92

Remarks:

1. Emission Level(dBuV/m) = Raw Value(dBuV) + Correction Factor(dB/m).
2. Correction Factor(dB/m) = Antenna Factor(dB/m) + Cable Factor(dB) – Pre-Amplifier Factor(dB).
3. Margin value = Emission Level – Limit value.
4. The other emission levels were very low against the limit.
5. " * " : Fundamental frequency.
6. " # " : The radiated frequency is out of the restricted band.

RF Mode	TX 802.11ax (HE20)	Channel	CH 140 : 5700 MHz
Frequency Range	1GHz ~ 40GHz	Detector Function	Peak (PK) Average (AV)

Antenna Polarity & Test Distance : Horizontal at 3 m								
No	Frequency (MHz)	Emission Level (dBuV/m)	Limit (dBuV/m)	Margin (dB)	Antenna Height (m)	Table Angle (Degree)	Raw Value (dBuV)	Correction Factor (dB/m)
1	*5700.00	119.21 PK			1.03 H	64	77.80	41.41
2	*5700.00	106.21 AV			1.03 H	64	64.80	41.41
3	#5725.00	67.32 PK	68.20	-0.88	1.05 H	63	63.70	3.62
4	11400.00	57.97 PK	74.00	-16.03	1.08 H	59	48.40	9.57
5	11400.00	44.97 AV	54.00	-9.03	1.08 H	59	35.40	9.57
6	#17100.00	63.08 PK	68.20	-5.12	1.10 H	60	52.90	10.18

Antenna Polarity & Test Distance : Vertical at 3 m								
No	Frequency (MHz)	Emission Level (dBuV/m)	Limit (dBuV/m)	Margin (dB)	Antenna Height (m)	Table Angle (Degree)	Raw Value (dBuV)	Correction Factor (dB/m)
1	*5700.00	116.01 PK			2.08 V	14	74.60	41.41
2	*5700.00	103.11 AV			2.08 V	14	61.70	41.41
3	#5725.00	64.92 PK	68.20	-3.28	2.01 V	10	61.30	3.62
4	11400.00	56.77 PK	74.00	-17.23	1.90 V	12	47.20	9.57
5	11400.00	44.57 AV	54.00	-9.43	1.90 V	12	35.00	9.57
6	#17100.00	62.68 PK	68.20	-5.52	1.82 V	8	52.50	10.18

Remarks:

1. Emission Level(dBuV/m) = Raw Value(dBuV) + Correction Factor(dB/m).
2. Correction Factor(dB/m) = Antenna Factor(dB/m) + Cable Factor(dB) – Pre-Amplifier Factor(dB).
3. Margin value = Emission Level – Limit value.
4. The other emission levels were very low against the limit.
5. " * " : Fundamental frequency.
6. " # " : The radiated frequency is out of the restricted band.

RF Mode	TX 802.11ax (HE20)	Channel	CH 144 : 5720 MHz
Frequency Range	1GHz ~ 40GHz	Detector Function	Peak (PK) Average (AV)

Antenna Polarity & Test Distance : Horizontal at 3 m								
No	Frequency (MHz)	Emission Level (dBuV/m)	Limit (dBuV/m)	Margin (dB)	Antenna Height (m)	Table Angle (Degree)	Raw Value (dBuV)	Correction Factor (dB/m)
1	#5470.00	59.13 PK	68.20	-9.07	1.05 H	60	57.00	2.13
2	*5720.00	122.22 PK			1.03 H	62	80.70	41.52
3	*5720.00	109.02 AV			1.03 H	62	67.50	41.52
4	#5850.00	62.37 PK	68.20	-5.83	1.04 H	58	58.60	3.77
5	11440.00	58.61 PK	74.00	-15.39	1.07 H	60	49.00	9.61
6	11440.00	46.51 AV	54.00	-7.49	1.07 H	60	36.90	9.61
7	#17160.00	64.00 PK	68.20	-4.20	1.02 H	63	54.10	9.90
Antenna Polarity & Test Distance : Vertical at 3 m								
No	Frequency (MHz)	Emission Level (dBuV/m)	Limit (dBuV/m)	Margin (dB)	Antenna Height (m)	Table Angle (Degree)	Raw Value (dBuV)	Correction Factor (dB/m)
1	#5470.00	57.93 PK	68.20	-10.27	2.00 V	11	55.80	2.13
2	*5720.00	119.12 PK			2.12 V	13	77.60	41.52
3	*5720.00	105.92 AV			2.12 V	13	64.40	41.52
4	#5850.00	61.27 PK	68.20	-6.93	2.03 V	12	57.50	3.77
5	11440.00	57.31 PK	74.00	-16.69	1.90 V	10	47.70	9.61
6	11440.00	46.11 AV	54.00	-7.89	1.90 V	10	36.50	9.61
7	#17160.00	63.50 PK	68.20	-4.70	1.86 V	12	53.60	9.90

Remarks:

1. Emission Level(dBuV/m) = Raw Value(dBuV) + Correction Factor(dB/m).
2. Correction Factor(dB/m) = Antenna Factor(dB/m) + Cable Factor(dB) – Pre-Amplifier Factor(dB).
3. Margin value = Emission Level – Limit value.
4. The other emission levels were very low against the limit.
5. " * ": Fundamental frequency.
6. " # ": The radiated frequency is out of the restricted band.

RF Mode	TX 802.11ax (HE40)	Channel	CH 54 : 5270 MHz
Frequency Range	1GHz ~ 40GHz	Detector Function	Peak (PK) Average (AV)

Antenna Polarity & Test Distance : Horizontal at 3 m								
No	Frequency (MHz)	Emission Level (dBuV/m)	Limit (dBuV/m)	Margin (dB)	Antenna Height (m)	Table Angle (Degree)	Raw Value (dBuV)	Correction Factor (dB/m)
1	5088.00	60.02 PK	74.00	-13.98	1.04 H	60	57.70	2.32
2	5088.00	50.52 AV	54.00	-3.48	1.04 H	60	48.20	2.32
3	5150.00	59.90 PK	74.00	-14.10	1.01 H	59	57.50	2.40
4	5150.00	46.90 AV	54.00	-7.10	1.01 H	59	44.50	2.40
5	*5270.00	119.84 PK			1.00 H	63	79.80	40.04
6	*5270.00	106.54 AV			1.00 H	63	66.50	40.04
7	#10540.00	57.11 PK	68.20	-11.09	3.01 H	312	48.50	8.61
8	15900.00	65.96 PK	74.00	-8.04	3.39 H	301	53.70	12.26
9	15900.00	52.16 AV	54.00	-1.84	3.39 H	301	39.90	12.26
Antenna Polarity & Test Distance : Vertical at 3 m								
No	Frequency (MHz)	Emission Level (dBuV/m)	Limit (dBuV/m)	Margin (dB)	Antenna Height (m)	Table Angle (Degree)	Raw Value (dBuV)	Correction Factor (dB/m)
1	5088.00	58.72 PK	74.00	-15.28	3.27 V	23	56.40	2.32
2	5088.00	46.12 AV	54.00	-7.88	3.27 V	23	43.80	2.32
3	5150.00	58.80 PK	74.00	-15.20	3.30 V	19	56.40	2.40
4	5150.00	45.60 AV	54.00	-8.40	3.30 V	19	43.20	2.40
5	*5270.00	115.44 PK			3.33 V	21	75.40	40.04
6	*5270.00	102.44 AV			3.33 V	21	62.40	40.04
7	#10540.00	57.61 PK	68.20	-10.59	3.42 V	41	49.00	8.61
8	15810.00	67.11 PK	74.00	-6.89	2.30 V	13	54.80	12.31
9	15810.00	53.11 AV	54.00	-0.89	2.30 V	13	40.80	12.31

Remarks:

1. Emission Level(dBuV/m) = Raw Value(dBuV) + Correction Factor(dB/m).
2. Correction Factor(dB/m) = Antenna Factor(dB/m) + Cable Factor(dB) – Pre-Amplifier Factor(dB).
3. Margin value = Emission Level – Limit value.
4. The other emission levels were very low against the limit.
5. " * " : Fundamental frequency.
6. " # " : The radiated frequency is out of the restricted band.

RF Mode	TX 802.11ax (HE40)	Channel	CH 62 : 5310 MHz
Frequency Range	1GHz ~ 40GHz	Detector Function	Peak (PK) Average (AV)

Antenna Polarity & Test Distance : Horizontal at 3 m								
No	Frequency (MHz)	Emission Level (dBuV/m)	Limit (dBuV/m)	Margin (dB)	Antenna Height (m)	Table Angle (Degree)	Raw Value (dBuV)	Correction Factor (dB/m)
1	*5310.00	118.83 PK			1.00 H	63	78.80	40.03
2	*5310.00	105.83 AV			1.00 H	63	65.80	40.03
3	5350.00	73.35 PK	74.00	-0.65	1.05 H	60	71.30	2.05
4	5350.00	53.35 AV	54.00	-0.65	1.05 H	60	51.30	2.05
5	10620.00	57.20 PK	74.00	-16.80	3.12 H	309	48.50	8.70
6	10620.00	44.00 AV	54.00	-10.00	3.12 H	309	35.30	8.70
7	15930.00	63.47 PK	74.00	-10.53	3.27 H	297	51.30	12.17
8	15930.00	50.27 AV	54.00	-3.73	3.27 H	297	38.10	12.17
Antenna Polarity & Test Distance : Vertical at 3 m								
No	Frequency (MHz)	Emission Level (dBuV/m)	Limit (dBuV/m)	Margin (dB)	Antenna Height (m)	Table Angle (Degree)	Raw Value (dBuV)	Correction Factor (dB/m)
1	*5310.00	115.93 PK			3.48 V	15	75.90	40.03
2	*5310.00	102.73 AV			3.48 V	15	62.70	40.03
3	5350.00	68.05 PK	74.00	-5.95	3.37 V	20	66.00	2.05
4	5350.00	48.65 AV	54.00	-5.35	3.37 V	20	46.60	2.05
5	10620.00	57.80 PK	74.00	-16.20	3.37 V	34	49.10	8.70
6	10620.00	44.30 AV	54.00	-9.70	3.37 V	34	35.60	8.70
7	15930.00	64.27 PK	74.00	-9.73	1.88 V	10	52.10	12.17
8	15930.00	51.17 AV	54.00	-2.83	1.88 V	10	39.00	12.17

Remarks:

1. Emission Level(dBuV/m) = Raw Value(dBuV) + Correction Factor(dB/m).
2. Correction Factor(dB/m) = Antenna Factor(dB/m) + Cable Factor(dB) – Pre-Amplifier Factor(dB).
3. Margin value = Emission Level – Limit value.
4. The other emission levels were very low against the limit.
5. " * " : Fundamental frequency.

RF Mode	TX 802.11ax (HE40)	Channel	CH 102 : 5510 MHz
Frequency Range	1GHz ~ 40GHz	Detector Function	Peak (PK) Average (AV)

Antenna Polarity & Test Distance : Horizontal at 3 m								
No	Frequency (MHz)	Emission Level (dBuV/m)	Limit (dBuV/m)	Margin (dB)	Antenna Height (m)	Table Angle (Degree)	Raw Value (dBuV)	Correction Factor (dB/m)
1	5460.00	62.10 PK	74.00	-11.90	1.05 H	61	60.00	2.10
2	5460.00	48.10 AV	54.00	-5.90	1.05 H	61	46.00	2.10
3	#5470.00	67.13 PK	68.20	-1.07	1.02 H	59	65.00	2.13
4	*5510.00	118.25 PK			1.01 H	61	78.00	40.25
5	*5510.00	105.05 AV			1.01 H	61	64.80	40.25
6	11020.00	56.97 PK	74.00	-17.03	1.07 H	59	48.20	8.77
7	11020.00	43.97 AV	54.00	-10.03	1.07 H	59	35.20	8.77
8	#16530.00	64.89 PK	68.20	-3.31	1.06 H	60	53.70	11.19
Antenna Polarity & Test Distance : Vertical at 3 m								
No	Frequency (MHz)	Emission Level (dBuV/m)	Limit (dBuV/m)	Margin (dB)	Antenna Height (m)	Table Angle (Degree)	Raw Value (dBuV)	Correction Factor (dB/m)
1	5460.00	59.90 PK	74.00	-14.10	2.12 V	12	57.80	2.10
2	5460.00	46.70 AV	54.00	-7.30	2.12 V	12	44.60	2.10
3	#5470.00	62.83 PK	68.20	-5.37	2.02 V	10	60.70	2.13
4	*5510.00	115.15 PK			2.12 V	14	74.90	40.25
5	*5510.00	101.85 AV			2.12 V	14	61.60	40.25
6	11020.00	55.87 PK	74.00	-18.13	1.88 V	12	47.10	8.77
7	11020.00	43.57 AV	54.00	-10.43	1.88 V	12	34.80	8.77
8	#16530.00	64.19 PK	68.20	-4.01	1.91 V	10	53.00	11.19

Remarks:

1. Emission Level(dBuV/m) = Raw Value(dBuV) + Correction Factor(dB/m).
2. Correction Factor(dB/m) = Antenna Factor(dB/m) + Cable Factor(dB) – Pre-Amplifier Factor(dB).
3. Margin value = Emission Level – Limit value.
4. The other emission levels were very low against the limit.
5. " * ": Fundamental frequency.
6. " # ": The radiated frequency is out of the restricted band.

RF Mode	TX 802.11ax (HE40)	Channel	CH 110 : 5550 MHz
Frequency Range	1GHz ~ 40GHz	Detector Function	Peak (PK) Average (AV)

Antenna Polarity & Test Distance : Horizontal at 3 m								
No	Frequency (MHz)	Emission Level (dBuV/m)	Limit (dBuV/m)	Margin (dB)	Antenna Height (m)	Table Angle (Degree)	Raw Value (dBuV)	Correction Factor (dB/m)
1	*5550.00	122.00 PK			1.05 H	62	81.40	40.60
2	*5550.00	108.90 AV			1.05 H	62	68.30	40.60
3	11100.00	57.99 PK	74.00	-16.01	1.11 H	58	49.00	8.99
4	11100.00	44.99 AV	54.00	-9.01	1.11 H	58	36.00	8.99
5	#16650.00	64.90 PK	68.20	-3.30	1.04 H	58	53.80	11.10

Antenna Polarity & Test Distance : Vertical at 3 m								
No	Frequency (MHz)	Emission Level (dBuV/m)	Limit (dBuV/m)	Margin (dB)	Antenna Height (m)	Table Angle (Degree)	Raw Value (dBuV)	Correction Factor (dB/m)
1	*5550.00	118.90 PK			2.09 V	12	78.30	40.60
2	*5550.00	105.80 AV			2.09 V	12	65.20	40.60
3	11100.00	56.99 PK	74.00	-17.01	1.94 V	12	48.00	8.99
4	11100.00	44.59 AV	54.00	-9.41	1.94 V	12	35.60	8.99
5	#16650.00	64.40 PK	68.20	-3.80	1.91 V	10	53.30	11.10

Remarks:

1. Emission Level(dBuV/m) = Raw Value(dBuV) + Correction Factor(dB/m).
2. Correction Factor(dB/m) = Antenna Factor(dB/m) + Cable Factor(dB) – Pre-Amplifier Factor(dB).
3. Margin value = Emission Level – Limit value.
4. The other emission levels were very low against the limit.
5. " * " : Fundamental frequency.
6. " # " : The radiated frequency is out of the restricted band.

RF Mode	TX 802.11ax (HE40)	Channel	CH 134 : 5670 MHz
Frequency Range	1GHz ~ 40GHz	Detector Function	Peak (PK) Average (AV)

Antenna Polarity & Test Distance : Horizontal at 3 m								
No	Frequency (MHz)	Emission Level (dBuV/m)	Limit (dBuV/m)	Margin (dB)	Antenna Height (m)	Table Angle (Degree)	Raw Value (dBuV)	Correction Factor (dB/m)
1	*5670.00	119.35 PK			1.04 H	60	78.00	41.35
2	*5670.00	105.95 AV			1.04 H	60	64.60	41.35
3	#5725.00	67.12 PK	68.20	-1.08	1.00 H	64	63.50	3.62
4	11340.00	59.03 PK	74.00	-14.97	1.11 H	58	49.50	9.53
5	11340.00	45.33 AV	54.00	-8.67	1.11 H	58	35.80	9.53
6	#17010.00	64.13 PK	68.20	-4.07	1.07 H	60	53.70	10.43

Antenna Polarity & Test Distance : Vertical at 3 m								
No	Frequency (MHz)	Emission Level (dBuV/m)	Limit (dBuV/m)	Margin (dB)	Antenna Height (m)	Table Angle (Degree)	Raw Value (dBuV)	Correction Factor (dB/m)
1	*5670.00	116.35 PK			2.12 V	14	75.00	41.35
2	*5670.00	102.85 AV			2.12 V	14	61.50	41.35
3	#5725.00	63.92 PK	68.20	-4.28	2.08 V	12	60.30	3.62
4	11340.00	58.03 PK	74.00	-15.97	1.97 V	7	48.50	9.53
5	11340.00	44.73 AV	54.00	-9.27	1.97 V	7	35.20	9.53
6	#17010.00	63.53 PK	68.20	-4.67	1.91 V	13	53.10	10.43

Remarks:

1. Emission Level(dBuV/m) = Raw Value(dBuV) + Correction Factor(dB/m).
2. Correction Factor(dB/m) = Antenna Factor(dB/m) + Cable Factor(dB) – Pre-Amplifier Factor(dB).
3. Margin value = Emission Level – Limit value.
4. The other emission levels were very low against the limit.
5. " * " : Fundamental frequency.
6. " # " : The radiated frequency is out of the restricted band.

RF Mode	TX 802.11ax (HE40)	Channel	CH 142 : 5710 MHz
Frequency Range	1GHz ~ 40GHz	Detector Function	Peak (PK) Average (AV)

Antenna Polarity & Test Distance : Horizontal at 3 m								
No	Frequency (MHz)	Emission Level (dBuV/m)	Limit (dBuV/m)	Margin (dB)	Antenna Height (m)	Table Angle (Degree)	Raw Value (dBuV)	Correction Factor (dB/m)
1	#5470.00	60.03 PK	68.20	-8.17	1.02 H	61	57.90	2.13
2	*5710.00	120.47 PK			1.00 H	65	79.00	41.47
3	*5710.00	107.67 AV			1.00 H	65	66.20	41.47
4	#5850.00	64.97 PK	68.20	-3.23	1.06 H	66	61.20	3.77
5	11420.00	59.29 PK	74.00	-14.71	1.05 H	58	49.70	9.59
6	11420.00	45.59 AV	54.00	-8.41	1.05 H	58	36.00	9.59
7	#17130.00	64.04 PK	68.20	-4.16	1.10 H	61	54.00	10.04
Antenna Polarity & Test Distance : Vertical at 3 m								
No	Frequency (MHz)	Emission Level (dBuV/m)	Limit (dBuV/m)	Margin (dB)	Antenna Height (m)	Table Angle (Degree)	Raw Value (dBuV)	Correction Factor (dB/m)
1	#5470.00	59.23 PK	68.20	-8.97	1.99 V	14	57.10	2.13
2	*5710.00	117.37 PK			2.08 V	13	75.90	41.47
3	*5710.00	104.57 AV			2.08 V	13	63.10	41.47
4	#5850.00	65.97 PK	68.20	-2.23	2.09 V	16	62.20	3.77
5	11420.00	58.09 PK	74.00	-15.91	1.91 V	7	48.50	9.59
6	11420.00	45.09 AV	54.00	-8.91	1.91 V	7	35.50	9.59
7	#17130.00	63.44 PK	68.20	-4.76	1.88 V	11	53.40	10.04

Remarks:

1. Emission Level(dBuV/m) = Raw Value(dBuV) + Correction Factor(dB/m).
2. Correction Factor(dB/m) = Antenna Factor(dB/m) + Cable Factor(dB) – Pre-Amplifier Factor(dB).
3. Margin value = Emission Level – Limit value.
4. The other emission levels were very low against the limit.
5. " * " : Fundamental frequency.
6. " # " : The radiated frequency is out of the restricted band.

RF Mode	TX 802.11ax (HE80)	Channel	CH 58 : 5290 MHz
Frequency Range	1GHz ~ 40GHz	Detector Function	Peak (PK) Average (AV)

Antenna Polarity & Test Distance : Horizontal at 3 m								
No	Frequency (MHz)	Emission Level (dBuV/m)	Limit (dBuV/m)	Margin (dB)	Antenna Height (m)	Table Angle (Degree)	Raw Value (dBuV)	Correction Factor (dB/m)
1	*5290.00	114.82 PK			1.07 H	58	74.80	40.02
2	*5290.00	101.62 AV			1.07 H	58	61.60	40.02
3	5350.00	69.25 PK	74.00	-4.75	1.01 H	63	67.20	2.05
4	5350.00	53.05 AV	54.00	-0.95	1.01 H	63	51.00	2.05
5	#10580.00	57.13 PK	68.20	-11.07	3.07 H	315	48.40	8.73
6	15870.00	64.28 PK	74.00	-9.72	3.22 H	301	52.00	12.28
7	15870.00	51.08 AV	54.00	-2.92	3.22 H	301	38.80	12.28
Antenna Polarity & Test Distance : Vertical at 3 m								
No	Frequency (MHz)	Emission Level (dBuV/m)	Limit (dBuV/m)	Margin (dB)	Antenna Height (m)	Table Angle (Degree)	Raw Value (dBuV)	Correction Factor (dB/m)
1	*5290.00	111.62 PK			3.33 V	11	71.60	40.02
2	*5290.00	98.62 AV			3.33 V	11	58.60	40.02
3	5350.00	64.45 PK	74.00	-9.55	3.25 V	20	62.40	2.05
4	5350.00	47.65 AV	54.00	-6.35	3.25 V	20	45.60	2.05
5	#10580.00	57.43 PK	68.20	-10.77	3.29 V	36	48.70	8.73
6	15870.00	63.98 PK	74.00	-10.02	2.14 V	20	51.70	12.28
7	15870.00	51.28 AV	54.00	-2.72	2.14 V	20	39.00	12.28

Remarks:

1. Emission Level(dBuV/m) = Raw Value(dBuV) + Correction Factor(dB/m).
2. Correction Factor(dB/m) = Antenna Factor(dB/m) + Cable Factor(dB) – Pre-Amplifier Factor(dB).
3. Margin value = Emission Level – Limit value.
4. The other emission levels were very low against the limit.
5. " * " : Fundamental frequency.
6. " # " : The radiated frequency is out of the restricted band.

RF Mode	TX 802.11ax (HE80)	Channel	CH 106 : 5530 MHz
Frequency Range	1GHz ~ 40GHz	Detector Function	Peak (PK) Average (AV)

Antenna Polarity & Test Distance : Horizontal at 3 m								
No	Frequency (MHz)	Emission Level (dBuV/m)	Limit (dBuV/m)	Margin (dB)	Antenna Height (m)	Table Angle (Degree)	Raw Value (dBuV)	Correction Factor (dB/m)
1	5460.00	65.40 PK	74.00	-8.60	1.01 H	63	63.30	2.10
2	5460.00	50.10 AV	54.00	-3.90	1.01 H	63	48.00	2.10
3	#5470.00	67.43 PK	68.20	-0.77	1.04 H	62	65.30	2.13
4	*5530.00	115.12 PK			1.02 H	63	74.70	40.42
5	*5530.00	102.32 AV			1.02 H	63	61.90	40.42
6	11060.00	57.78 PK	74.00	-16.22	1.08 H	58	48.90	8.88
7	11060.00	44.58 AV	54.00	-9.42	1.08 H	58	35.70	8.88
8	#16590.00	64.69 PK	68.20	-3.51	1.07 H	60	53.50	11.19
Antenna Polarity & Test Distance : Vertical at 3 m								
No	Frequency (MHz)	Emission Level (dBuV/m)	Limit (dBuV/m)	Margin (dB)	Antenna Height (m)	Table Angle (Degree)	Raw Value (dBuV)	Correction Factor (dB/m)
1	5460.00	62.40 PK	74.00	-11.60	1.99 V	15	60.30	2.10
2	5460.00	48.20 AV	54.00	-5.80	1.99 V	15	46.10	2.10
3	#5470.00	64.03 PK	68.20	-4.17	2.01 V	13	61.90	2.13
4	*5530.00	111.92 PK			2.06 V	13	71.50	40.42
5	*5530.00	99.22 AV			2.06 V	13	58.80	40.42
6	11060.00	56.68 PK	74.00	-17.32	1.97 V	8	47.80	8.88
7	11060.00	44.08 AV	54.00	-9.92	1.97 V	8	35.20	8.88
8	#16590.00	64.09 PK	68.20	-4.11	1.88 V	10	52.90	11.19

Remarks:

1. Emission Level(dBuV/m) = Raw Value(dBuV) + Correction Factor(dB/m).
2. Correction Factor(dB/m) = Antenna Factor(dB/m) + Cable Factor(dB) – Pre-Amplifier Factor(dB).
3. Margin value = Emission Level – Limit value.
4. The other emission levels were very low against the limit.
5. " * ": Fundamental frequency.
6. " # ": The radiated frequency is out of the restricted band.

RF Mode	TX 802.11ax (HE80)	Channel	CH 122 : 5610 MHz
Frequency Range	1GHz ~ 40GHz	Detector Function	Peak (PK) Average (AV)

Antenna Polarity & Test Distance : Horizontal at 3 m								
No	Frequency (MHz)	Emission Level (dBuV/m)	Limit (dBuV/m)	Margin (dB)	Antenna Height (m)	Table Angle (Degree)	Raw Value (dBuV)	Correction Factor (dB/m)
1	*5610.00	115.98 PK			1.01 H	63	74.90	41.08
2	*5610.00	102.78 AV			1.01 H	63	61.70	41.08
3	#5725.00	67.02 PK	68.20	-1.18	1.00 H	62	63.40	3.62
4	11220.00	58.26 PK	74.00	-15.74	1.07 H	61	49.40	8.86
5	11220.00	44.86 AV	54.00	-9.14	1.07 H	61	36.00	8.86
6	#16830.00	64.24 PK	68.20	-3.96	1.07 H	57	53.50	10.74

Antenna Polarity & Test Distance : Vertical at 3 m								
No	Frequency (MHz)	Emission Level (dBuV/m)	Limit (dBuV/m)	Margin (dB)	Antenna Height (m)	Table Angle (Degree)	Raw Value (dBuV)	Correction Factor (dB/m)
1	*5610.00	112.78 PK			2.11 V	17	71.70	41.08
2	*5610.00	99.68 AV			2.11 V	17	58.60	41.08
3	#5725.00	64.62 PK	68.20	-3.58	2.05 V	14	61.00	3.62
4	11220.00	56.96 PK	74.00	-17.04	1.91 V	13	48.10	8.86
5	11220.00	44.26 AV	54.00	-9.74	1.91 V	13	35.40	8.86
6	#16830.00	63.74 PK	68.20	-4.46	1.85 V	12	53.00	10.74

Remarks:

1. Emission Level(dBuV/m) = Raw Value(dBuV) + Correction Factor(dB/m).
2. Correction Factor(dB/m) = Antenna Factor(dB/m) + Cable Factor(dB) – Pre-Amplifier Factor(dB).
3. Margin value = Emission Level – Limit value.
4. The other emission levels were very low against the limit.
5. " * " : Fundamental frequency.
6. " # " : The radiated frequency is out of the restricted band.

RF Mode	TX 802.11ax (HE80)	Channel	CH 138 : 5690 MHz
Frequency Range	1GHz ~ 40GHz	Detector Function	Peak (PK) Average (AV)

Antenna Polarity & Test Distance : Horizontal at 3 m								
No	Frequency (MHz)	Emission Level (dBuV/m)	Limit (dBuV/m)	Margin (dB)	Antenna Height (m)	Table Angle (Degree)	Raw Value (dBuV)	Correction Factor (dB/m)
1	#5470.00	64.00 PK	68.20	-4.20	1.05 H	66	61.87	2.13
2	*5690.00	116.28 PK			1.01 H	65	74.90	41.38
3	*5690.00	102.68 AV			1.01 H	65	61.30	41.38
4	#5850.00	67.47 PK	68.20	-0.73	1.08 H	48	63.70	3.77
5	11380.00	58.35 PK	74.00	-15.65	1.10 H	60	48.80	9.55
6	11380.00	45.35 AV	54.00	-8.65	1.10 H	60	35.80	9.55
7	#17070.00	64.16 PK	68.20	-4.04	1.07 H	54	53.90	10.26
Antenna Polarity & Test Distance : Vertical at 3 m								
No	Frequency (MHz)	Emission Level (dBuV/m)	Limit (dBuV/m)	Margin (dB)	Antenna Height (m)	Table Angle (Degree)	Raw Value (dBuV)	Correction Factor (dB/m)
1	#5470.00	60.73 PK	68.20	-7.47	2.09 V	16	58.60	2.13
2	*5690.00	112.98 PK			2.12 V	19	71.60	41.38
3	*5690.00	99.48 AV			2.12 V	19	58.10	41.38
4	#5850.00	66.27 PK	68.20	-1.93	2.01 V	14	62.50	3.77
5	11380.00	57.15 PK	74.00	-16.85	1.87 V	14	47.60	9.55
6	11380.00	44.85 AV	54.00	-9.15	1.87 V	14	35.30	9.55
7	#17070.00	63.56 PK	68.20	-4.64	1.90 V	12	53.30	10.26

Remarks:

1. Emission Level(dBuV/m) = Raw Value(dBuV) + Correction Factor(dB/m).
2. Correction Factor(dB/m) = Antenna Factor(dB/m) + Cable Factor(dB) – Pre-Amplifier Factor(dB).
3. Margin value = Emission Level – Limit value.
4. The other emission levels were very low against the limit.
5. " * ": Fundamental frequency.
6. " # ": The radiated frequency is out of the restricted band.

Below 1GHz Worst-Case Data:

5G traffic radio (Radio 1)

RF Mode	TX 802.11ax (HE40)	Channel	CH 110 : 5550 MHz
Frequency Range	30MHz ~ 1GHz	Detector Function	Quasi-Peak (QP)
Test Mode	A		

Antenna Polarity & Test Distance : Horizontal at 3 m								
No	Frequency (MHz)	Emission Level (dBuV/m)	Limit (dBuV/m)	Margin (dB)	Antenna Height (m)	Table Angle (Degree)	Raw Value (dBuV)	Correction Factor (dB/m)
1	37.03	27.6 QP	40.0	-12.4	1.99 H	154	41.5	-13.9
2	146.68	37.7 QP	43.5	-5.8	1.00 H	271	50.8	-13.1
3	329.43	28.3 QP	46.0	-17.7	1.00 H	231	39.9	-11.6
4	499.86	35.1 QP	46.0	-10.9	1.00 H	32	42.9	-7.8
5	839.74	29.4 QP	46.0	-16.6	1.00 H	135	31.2	-1.8
6	985.94	32.9 QP	54.0	-21.1	1.49 H	162	33.2	-0.3

Remarks:

1. Emission Level(dBuV/m) = Raw Value(dBuV) + Correction Factor(dB/m).
2. Correction Factor(dB/m) = Antenna Factor(dB/m) + Cable Factor(dB) – Pre-Amplifier Factor(dB).
3. The other emission levels were very low against the limit of frequency range 30MHz ~ 1000MHz.
4. Margin value = Emission Level – Limit value.
5. The emission levels were very low against the limit of frequency range 9kHz ~ 30MHz: the amplitude of spurious emissions attenuated more than 20 dB below the permissible value to be report.

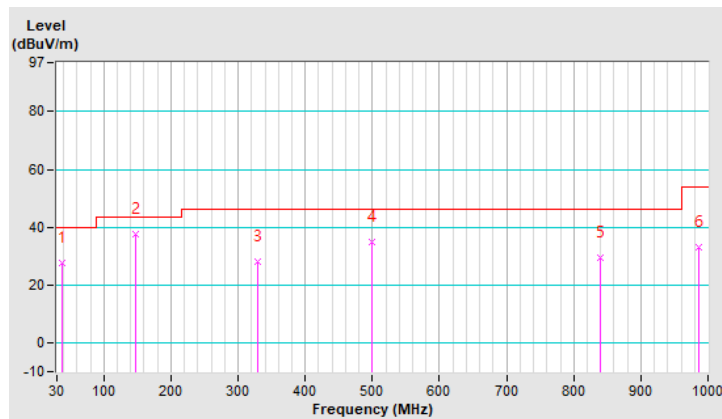

RF Mode	TX 802.11ax (HE40)	Channel	CH 110 : 5550 MHz
Frequency Range	30MHz ~ 1GHz	Detector Function	Quasi-Peak (QP)
Test Mode	A		

Antenna Polarity & Test Distance : Vertical at 3 m								
No	Frequency (MHz)	Emission Level (dBuV/m)	Limit (dBuV/m)	Margin (dB)	Antenna Height (m)	Table Angle (Degree)	Raw Value (dBuV)	Correction Factor (dB/m)
1	30.00	34.9 QP	40.0	-5.1	1.00 V	291	49.4	-14.5
2	100.29	33.8 QP	43.5	-9.7	1.49 V	144	51.3	-17.5
3	177.61	33.2 QP	43.5	-10.3	1.00 V	113	47.5	-14.3
4	479.86	35.6 QP	46.0	-10.4	1.00 V	125	43.7	-8.1
5	732.90	33.2 QP	46.0	-12.8	1.49 V	3	36.7	-3.5
6	998.59	33.7 QP	54.0	-20.3	1.00 V	346	34.0	-0.3

Remarks:

1. Emission Level(dBuV/m) = Raw Value(dBuV) + Correction Factor(dB/m).
2. Correction Factor(dB/m) = Antenna Factor(dB/m) + Cable Factor(dB) – Pre-Amplifier Factor(dB).
3. The other emission levels were very low against the limit of frequency range 30MHz ~ 1000MHz.
4. Margin value = Emission Level – Limit value.
5. The emission levels were very low against the limit of frequency range 9kHz ~ 30MHz: the amplitude of spurious emissions attenuated more than 20 dB below the permissible value to be report.

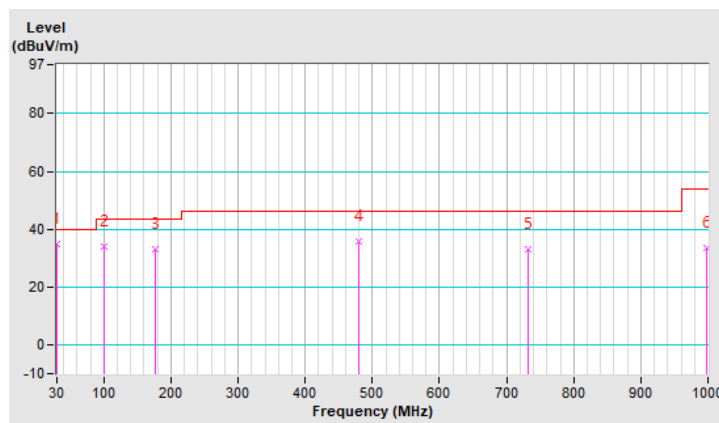

RF Mode	TX 802.11ax (HE40)	Channel	CH 110 : 5550 MHz
Frequency Range	30MHz ~ 1GHz	Detector Function	Quasi-Peak (QP)
Test Mode	B		

Antenna Polarity & Test Distance : Horizontal at 3 m								
No	Frequency (MHz)	Emission Level (dBuV/m)	Limit (dBuV/m)	Margin (dB)	Antenna Height (m)	Table Angle (Degree)	Raw Value (dBuV)	Correction Factor (dB/m)
1	48.28	28.3 QP	40.0	-11.7	1.99 H	2	41.3	-13.0
2	242.74	18.6 QP	46.0	-27.4	1.49 H	133	33.2	-14.6
3	599.54	36.4 QP	46.0	-9.6	1.00 H	255	41.7	-5.3
4	677.88	35.1 QP	46.0	-10.9	1.99 H	151	39.6	-4.5
5	955.01	35.2 QP	46.0	-10.8	1.99 H	19	35.7	-0.5
6	998.59	29.0 QP	54.0	-25.0	1.49 H	344	29.3	-0.3

Remarks:

1. Emission Level(dBuV/m) = Raw Value(dBuV) + Correction Factor(dB/m).
2. Correction Factor(dB/m) = Antenna Factor(dB/m) + Cable Factor(dB) – Pre-Amplifier Factor(dB).
3. The other emission levels were very low against the limit of frequency range 30MHz ~ 1000MHz.
4. Margin value = Emission Level – Limit value.
5. The emission levels were very low against the limit of frequency range 9kHz ~ 30MHz: the amplitude of spurious emissions attenuated more than 20 dB below the permissible value to be report.

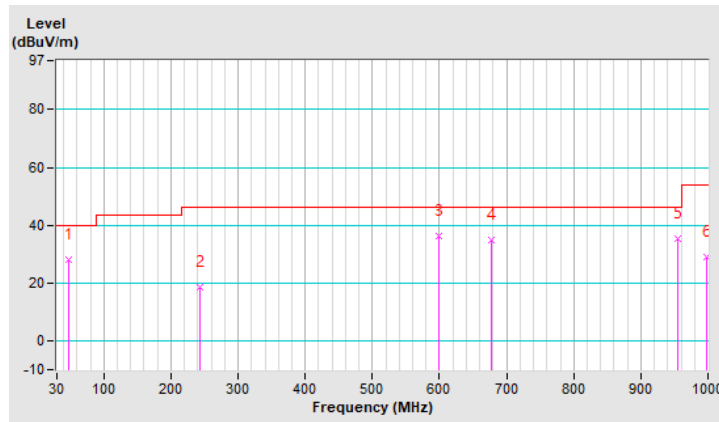

RF Mode	TX 802.11ax (HE40)	Channel	CH 110 : 5550 MHz
Frequency Range	30MHz ~ 1GHz	Detector Function	Quasi-Peak (QP)
Test Mode	B		

Antenna Polarity & Test Distance : Vertical at 3 m								
No	Frequency (MHz)	Emission Level (dBuV/m)	Limit (dBuV/m)	Margin (dB)	Antenna Height (m)	Table Angle (Degree)	Raw Value (dBuV)	Correction Factor (dB/m)
1	38.43	30.1 QP	40.0	-9.9	1.01 V	262	43.8	-13.7
2	108.28	32.8 QP	43.5	-10.7	1.51 V	20	49.2	-16.4
3	506.55	36.1 QP	46.0	-9.9	1.01 V	88	43.8	-7.7
4	742.74	34.5 QP	46.0	-11.5	1.01 V	98	37.6	-3.1
5	894.57	34.9 QP	46.0	-11.1	1.01 V	249	36.1	-1.2
6	994.38	29.7 QP	54.0	-24.3	1.01 V	323	29.9	-0.2

Remarks:

1. Emission Level(dBuV/m) = Raw Value(dBuV) + Correction Factor(dB/m).
2. Correction Factor(dB/m) = Antenna Factor(dB/m) + Cable Factor(dB) – Pre-Amplifier Factor(dB).
3. The other emission levels were very low against the limit of frequency range 30MHz ~ 1000MHz.
4. Margin value = Emission Level – Limit value.
5. The emission levels were very low against the limit of frequency range 9kHz ~ 30MHz: the amplitude of spurious emissions attenuated more than 20 dB below the permissible value to be report.

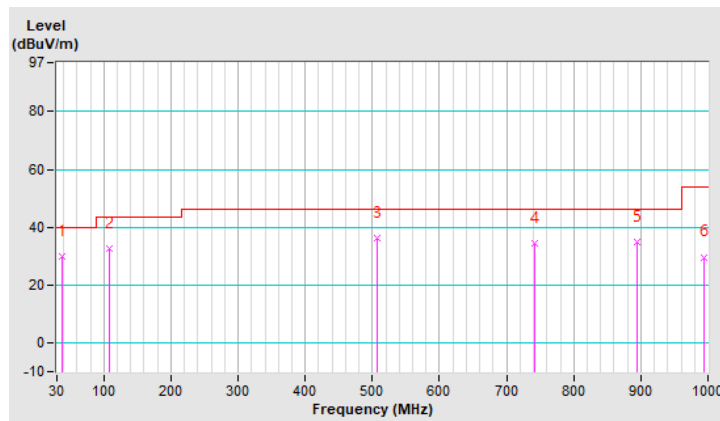

4.2 Conducted Emission Measurement

4.2.1 Limits of Conducted Emission Measurement

Frequency (MHz)	Conducted Limit (dBuV)	
	Quasi-peak	Average
0.15 - 0.5	66 - 56	56 - 46
0.50 - 5.0	56	46
5.0 - 30.0	60	50

Note: 1. The lower limit shall apply at the transition frequencies.

2. The limit decreases in line with the logarithm of the frequency in the range of 0.15 to 0.50MHz.

4.2.2 Test Instruments

Description & Manufacturer	Model No.	Serial No.	Cal. Date	Cal. Due
Test Receiver ROHDE & SCHWARZ	ESCI	100613	Dec. 03, 2021	Dec. 02, 2022
RF signal cable Woken	5D-FB	Cable-cond1-01	Jan. 15, 2022	Jan. 14, 2023
LISN ROHDE & SCHWARZ (EUT)	ENV216	101826	Mar. 14, 2022	Mar. 13, 2023
LISN ROHDE & SCHWARZ (Peripheral)	ESH3-Z5	100311	Sep. 07, 2021	Sep. 06, 2022
Software ADT	BV ADT_Cond_ V7.3.7.4	NA	NA	NA

Note: 1. The calibration interval of the above test instruments is 12 months and the calibrations are traceable to NML/ROC and NIST/USA.

2. The test was performed in HwaYa Shielded Room 1 (Conduction 1).

3. The VCCI Site Registration No. is C-12040.

4.2.3 Test Procedures

- The EUT was placed 0.4 meters from the conducting wall of the shielded room with EUT being connected to the power mains through a line impedance stabilization network (LISN). Other support units were connected to the power mains through another LISN. The two LISNs provide 50 ohm/ 50uH of coupling impedance for the measuring instrument.
- Both lines of the power mains connected to the EUT were checked for maximum conducted interference.
- The frequency range from 150kHz to 30MHz was searched. Emission levels under (Limit - 20dB) was not recorded.

Note: The resolution bandwidth and video bandwidth of test receiver is 9kHz for quasi-peak detection (QP) and average detection (AV) at frequency 0.15MHz-30MHz.

4.2.4 Deviation from Test Standard

No deviation.

4.2.5 Test Setup

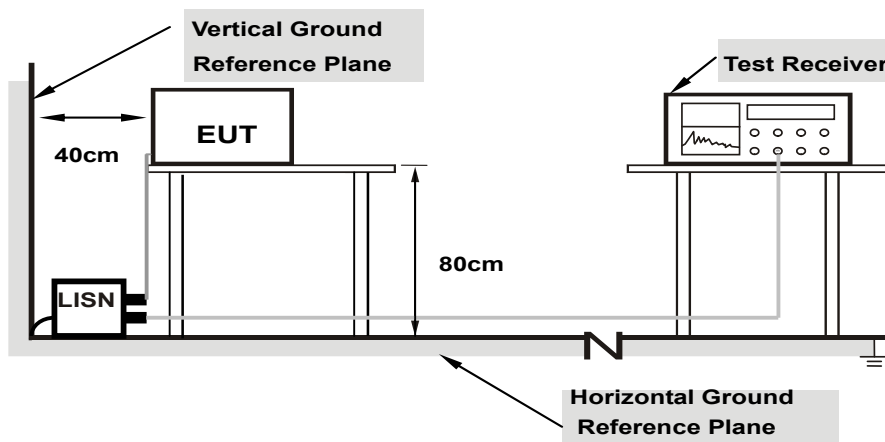

Note: 1.Support units were connected to second LISN.

For the actual test configuration, please refer to the attached file (Test Setup Photo).

4.2.6 EUT Operating Conditions

Same as 4.1.6.

4.2.7 Test Results

Worst-case data:

5G traffic radio (Radio 1)

802.11ax (HE40)

Phase	Line (L)	Detector Function	Quasi-Peak (QP) / Average (AV)
Test Mode	A		

No	Freq. [MHz]	Corr. Factor (dB)	Reading Value		Emission Level		Limit		Margin	
			[dB (uV)]		[dB (uV)]		[dB (uV)]		(dB)	
			Q.P.	AV.	Q.P.	AV.	Q.P.	AV.	Q.P.	AV.
1	0.16600	9.63	36.40	17.96	46.03	27.59	65.16	55.16	-19.13	-27.57
2	0.18600	9.63	32.15	13.72	41.78	23.35	64.21	54.21	-22.43	-30.86
3	0.25000	9.65	23.42	9.65	33.07	19.30	61.76	51.76	-28.69	-32.46
4	0.48600	9.69	7.56	0.76	17.25	10.45	56.24	46.24	-38.99	-35.79
5	19.77000	9.87	12.77	6.25	22.64	16.12	60.00	50.00	-37.36	-33.88
6	29.51400	9.89	12.18	5.52	22.07	15.41	60.00	50.00	-37.93	-34.59

Remarks:

1. Q.P. and AV. are abbreviations of quasi-peak and average individually.
2. The emission levels of other frequencies were very low against the limit.
3. Margin value = Emission level - Limit value
4. Correction factor = Insertion loss + Cable loss
5. Emission Level = Correction Factor + Reading Value.

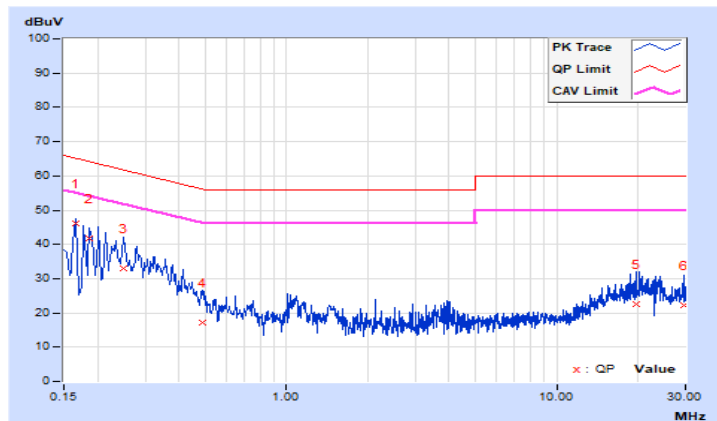

Phase	Neutral (N)	Detector Function	Quasi-Peak (QP) / Average (AV)
Test Mode	A		

No	Freq. [MHz]	Corr. Factor (dB)	Reading Value [dB (uV)]		Emission Level [dB (uV)]		Limit [dB (uV)]		Margin (dB)	
			Q.P.	AV.	Q.P.	AV.	Q.P.	AV.	Q.P.	AV.
			1	0.15000	9.62	38.92	22.87	48.54	32.49	66.00
2	0.16190	9.62	35.95	16.94	45.57	26.56	65.37	55.37	-19.80	-28.81
3	0.19800	9.64	29.89	14.21	39.53	23.85	63.69	53.69	-24.16	-29.84
4	0.41400	9.69	23.71	15.59	33.40	25.28	57.57	47.57	-24.17	-22.29
5	3.82192	9.75	11.59	1.37	21.34	11.12	56.00	46.00	-34.66	-34.88
6	21.63800	9.89	14.75	7.55	24.64	17.44	60.00	50.00	-35.36	-32.56

Remarks:

1. Q.P. and AV. are abbreviations of quasi-peak and average individually.
2. The emission levels of other frequencies were very low against the limit.
3. Margin value = Emission level - Limit value
4. Correction factor = Insertion loss + Cable loss
5. Emission Level = Correction Factor + Reading Value.

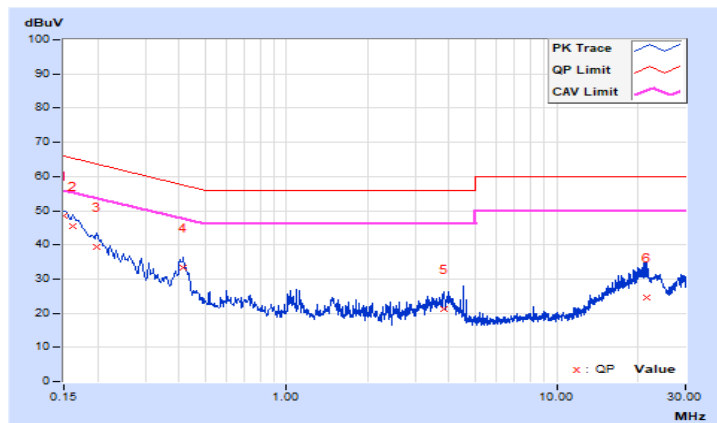

Phase	Line (L)	Detector Function	Quasi-Peak (QP) / Average (AV)
Test Mode	B		

No	Freq. [MHz]	Corr. Factor (dB)	Reading Value [dB (uV)]		Emission Level [dB (uV)]		Limit [dB (uV)]		Margin (dB)	
			Q.P.	AV.	Q.P.	AV.	Q.P.	AV.	Q.P.	AV.
			1	0.15000	9.62	34.44	14.46	44.06	24.08	66.00
2	0.21800	9.64	25.83	11.59	35.47	21.23	62.89	52.89	-27.42	-31.66
3	0.53400	9.69	35.55	24.93	45.24	34.62	56.00	46.00	-10.76	-11.38
4	0.59400	9.69	25.38	14.53	35.07	24.22	56.00	46.00	-20.93	-21.78
5	11.26600	9.82	28.18	17.84	38.00	27.66	60.00	50.00	-22.00	-22.34
6	14.39400	9.84	22.92	13.08	32.76	22.92	60.00	50.00	-27.24	-27.08

Remarks:

1. Q.P. and AV. are abbreviations of quasi-peak and average individually.
2. The emission levels of other frequencies were very low against the limit.
3. Margin value = Emission level - Limit value
4. Correction factor = Insertion loss + Cable loss
5. Emission Level = Correction Factor + Reading Value.

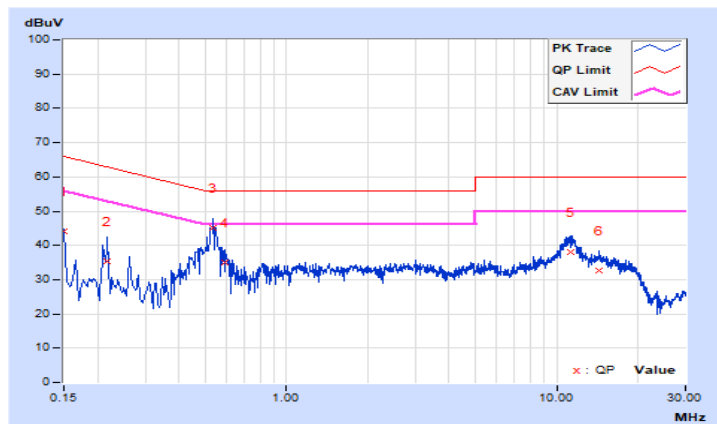

Phase	Neutral (N)	Detector Function	Quasi-Peak (QP) / Average (AV)
Test Mode	B		

No	Freq. [MHz]	Corr. Factor (dB)	Reading Value [dB (uV)]		Emission Level [dB (uV)]		Limit [dB (uV)]		Margin (dB)	
			Q.P.	AV.	Q.P.	AV.	Q.P.	AV.	Q.P.	AV.
			1	0.15000	9.62	32.50	14.93	42.12	24.55	66.00
2	0.17000	9.63	30.43	13.00	40.06	22.63	64.96	54.96	-24.90	-32.33
3	0.19000	9.64	30.50	12.62	40.14	22.26	64.04	54.04	-23.90	-31.78
4	0.54200	9.69	34.75	23.96	44.44	33.65	56.00	46.00	-11.56	-12.35
5	11.36200	9.82	27.06	16.85	36.88	26.67	60.00	50.00	-23.12	-23.33
6	17.99000	9.88	20.69	10.63	30.57	20.51	60.00	50.00	-29.43	-29.49

Remarks:

1. Q.P. and AV. are abbreviations of quasi-peak and average individually.
2. The emission levels of other frequencies were very low against the limit.
3. Margin value = Emission level - Limit value
4. Correction factor = Insertion loss + Cable loss
5. Emission Level = Correction Factor + Reading Value.

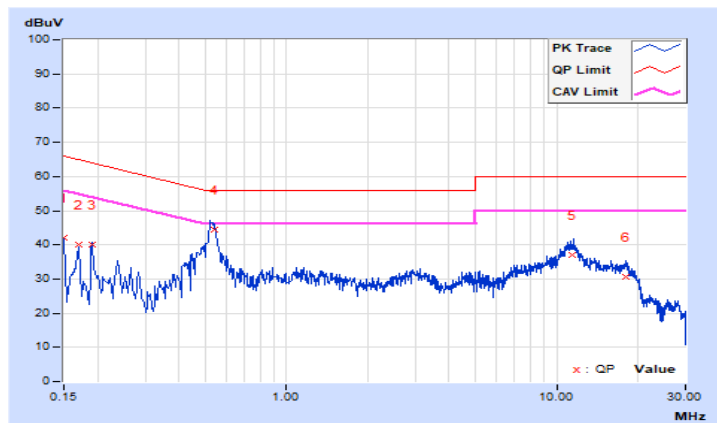

4.3 Transmit Power Measurement

4.3.1 Limits of Transmit Power Measurement

Operation Band	EUT Category	Limit
U-NII-1	Outdoor Access Point	1 Watt (30 dBm) (Max. e.i.r.p \leq 125mW(21 dBm) at any elevation angle above 30 degrees as measured from the horizon)
	Fixed point-to-point Access Point	1 Watt (30 dBm)
	Indoor Access Point	1 Watt (30 dBm)
	Mobile and Portable client device	250mW (24 dBm)
U-NII-2A	√	250mW (24 dBm) or 11 dBm+10 log B*
U-NII-2C	√	250mW (24 dBm) or 11 dBm+10 log B*
U-NII-3	√	1 Watt (30 dBm)

*B is the 26 dB emission bandwidth in megahertz

Per KDB 662911 Method of conducted output power measurement on IEEE 802.11 devices,

Array Gain = 0 dB (i.e., no array gain) for $N_{ANT} \leq 4$;

Array Gain = 0 dB (i.e., no array gain) for channel widths ≥ 40 MHz for any N_{ANT} ;

Array Gain = $5 \log(N_{ANT}/N_{SS})$ dB or 3 dB, whichever is less for 20-MHz channel widths with $N_{ANT} \geq 5$.

For power measurements on all other devices: Array Gain = $10 \log(N_{ANT}/N_{SS})$ dB.

4.3.2 Test Setup

For Power Output

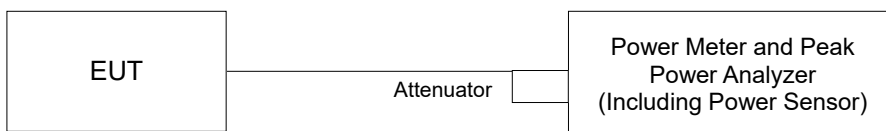

For 26dB Bandwidth and power output of transmission above 5.725 GHz where the EBW crosses 5.725 GHz

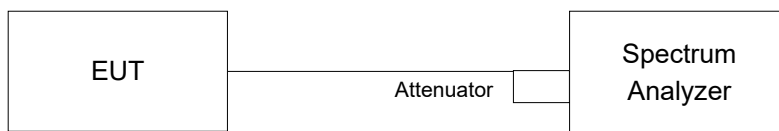

4.3.3 Test Instruments

Refer to section 4.1.2 to get information of above instrument.

4.3.4 Test Procedure

For Average Power Measurement

Method PM is used to perform output power measurement, trigger and gating function of wide band power meter is enabled to measure max output power of TX on burst and set the detector to average. Duty factor is not added to measured value.

For transmission above 5.725 GHz where the EBW crosses 5.725 GHz

For channel aggregation (channel 138, 142, 144) measurement refer to KDB 789033 D02 General UNII Test Procedures New Rules v02r01 Section II E 2 e) method SA-2A.

For 26dB Bandwidth

- a. Set RBW = approximately 1% of the emission bandwidth.
- b. Set the VBW $\geq 3 \times$ RBW.
- c. Detector = Peak.
- d. Trace mode = max hold.
- e. Measure the maximum width of the emission that is 26 dB down from the peak of the emission. Compare this with the RBW setting of the analyzer. Readjust RBW and repeat measurement as needed until the RBW/EBW ratio is approximately 1%.

4.3.5 Deviation from Test Standard

No deviation.

4.3.6 EUT Operating Conditions

The software provided by client to enable the EUT under transmission condition continuously at lowest, middle and highest channel frequencies individually.

4.3.7 Test Result

For straddle channels, measured in accordance with FCC KDB 789033 UNII Test Procedure Method SA-2A and tested with a spectrum analyzer, if the duty cycle is less than 98%, the duty cycle factor is included in the total power. The duty cycle factor can be found in chapter 3.3 of the report.

5G traffic radio (Radio 1)

Power Output:

CDD Mode

802.11a

Chan.	Freq. (MHz)	Average Power (dBm)		Total Power (mW)	Total Power (dBm)	Power Limit (dBm)	Pass / Fail
		Chain 0	Chain 1				
52	5260	18.85	18.27	143.879	21.58	24.00	Pass
60	5300	18.75	18.82	151.197	21.80	24.00	Pass
64	5320	18.84	18.36	145.108	21.62	24.00	Pass
100	5500	19.17	18.19	148.521	21.72	24.00	Pass
116	5580	18.47	18.56	142.087	21.53	24.00	Pass
140	5700	18.77	18.53	146.621	21.66	23.97	Pass
144	5720 (For U-NII-2C)	17.54	17.44	122.705	20.89	22.79	Pass
144	5720 (For U-NII-3)	11.22	11.36	29.437	14.69	30.00	Pass

Note:

For U-NII-2A, U-NII-2C Band:

Chain 0

1. $11\text{dBm} + 10\log(20.91) = 24.20 > 24\text{dBm}$
2. $11\text{dBm} + 10\log(21.04) = 24.23 > 24\text{dBm}$
3. $11\text{dBm} + 10\log(21.49) = 24.32 > 24\text{dBm}$
4. $11\text{dBm} + 10\log(20.87) = 24.19 > 24\text{dBm}$
5. $11\text{dBm} + 10\log(20.58) = 24.13 > 24\text{dBm}$
6. $11\text{dBm} + 10\log(20.71) = 24.16 > 24\text{dBm}$
7. $11\text{dBm} + 10\log(5725.00 - 5709.56) = 22.88 < 24\text{dBm}$

Chain 1

1. $11\text{dBm} + 10\log(20.80) = 24.18 > 24\text{dBm}$
2. $11\text{dBm} + 10\log(20.90) = 24.20 > 24\text{dBm}$
3. $11\text{dBm} + 10\log(21.01) = 24.22 > 24\text{dBm}$
4. $11\text{dBm} + 10\log(20.90) = 24.20 > 24\text{dBm}$
5. $11\text{dBm} + 10\log(20.93) = 24.20 > 24\text{dBm}$
6. $11\text{dBm} + 10\log(19.86) = 23.97 < 24\text{dBm}$
7. $11\text{dBm} + 10\log(5725.00 - 5709.87) = 22.79 < 24\text{dBm}$

802.11ac (VHT20)

Chan.	Freq. (MHz)	Average Power (dBm)		Total Power (mW)	Total Power (dBm)	Power Limit (dBm)	Pass / Fail
		Chain 0	Chain 1				
52	5260	19.14	18.55	153.649	21.87	24.00	Pass
60	5300	18.77	19.11	156.806	21.95	24.00	Pass
64	5320	18.12	17.54	121.618	20.85	24.00	Pass
100	5500	18.41	17.44	124.805	20.96	24.00	Pass
116	5580	19.03	18.93	158.146	21.99	24.00	Pass
140	5700	17.25	16.94	102.520	20.11	24.00	Pass
144	5720 (For U-NII-2C)	17.99	17.51	124.583	20.95	23.05	Pass
144	5720 (For U-NII-3)	12.68	12.67	38.663	15.87	30.00	Pass

Note:

For U-NII-2A, U-NII-2C Band:

Chain 0

1. $11\text{dBm} + 10\log(22.52) = 24.52 > 24\text{dBm}$
2. $11\text{dBm} + 10\log(21.87) = 24.39 > 24\text{dBm}$
3. $11\text{dBm} + 10\log(21.98) = 24.42 > 24\text{dBm}$
4. $11\text{dBm} + 10\log(21.89) = 24.40 > 24\text{dBm}$
5. $11\text{dBm} + 10\log(21.89) = 24.40 > 24\text{dBm}$
6. $11\text{dBm} + 10\log(21.92) = 24.40 > 24\text{dBm}$
7. $11\text{dBm} + 10\log(5725.00 - 5708.87) = 23.07 < 24\text{dBm}$

Chain 1

1. $11\text{dBm} + 10\log(21.95) = 24.41 > 24\text{dBm}$
2. $11\text{dBm} + 10\log(23.08) = 24.63 > 24\text{dBm}$
3. $11\text{dBm} + 10\log(22.13) = 24.44 > 24\text{dBm}$
4. $11\text{dBm} + 10\log(21.83) = 24.39 > 24\text{dBm}$
5. $11\text{dBm} + 10\log(22.14) = 24.45 > 24\text{dBm}$
6. $11\text{dBm} + 10\log(21.89) = 24.40 > 24\text{dBm}$
7. $11\text{dBm} + 10\log(5725.00 - 5708.95) = 23.05 < 24\text{dBm}$

802.11ac (VHT40)

Chan.	Freq. (MHz)	Average Power (dBm)		Total Power (mW)	Total Power (dBm)	Power Limit (dBm)	Pass / Fail
		Chain 0	Chain 1				
54	5270	18.82	18.51	147.166	21.68	24.00	Pass
62	5310	18.11	18.13	129.727	21.13	24.00	Pass
102	5510	18.18	17.33	119.841	20.79	24.00	Pass
110	5550	21.02	20.45	237.391	23.75	24.00	Pass
134	5670	19.12	18.34	149.892	21.76	24.00	Pass
142	5710 (For U-NII-2C)	20.10	19.85	208.670	23.19	24.00	Pass
142	5710 (For U-NII-3)	10.18	10.32	22.225	13.47	30.00	Pass

Note:

For U-NII-2A, U-NII-2C Band:

Chain 0

1. $11\text{dBm} + 10\log(42.40) = 27.27 > 24\text{dBm}$
2. $11\text{dBm} + 10\log(42.45) = 27.27 > 24\text{dBm}$
3. $11\text{dBm} + 10\log(42.77) = 27.31 > 24\text{dBm}$
4. $11\text{dBm} + 10\log(59.42) = 28.73 > 24\text{dBm}$
5. $11\text{dBm} + 10\log(42.39) = 27.27 > 24\text{dBm}$
6. $11\text{dBm} + 10\log(5725.00 - 5687.40) = 26.75 > 24\text{dBm}$

Chain 1

1. $11\text{dBm} + 10\log(42.39) = 27.27 > 24\text{dBm}$
2. $11\text{dBm} + 10\log(42.67) = 27.30 > 24\text{dBm}$
3. $11\text{dBm} + 10\log(42.25) = 27.25 > 24\text{dBm}$
4. $11\text{dBm} + 10\log(43.34) = 27.36 > 24\text{dBm}$
5. $11\text{dBm} + 10\log(42.90) = 27.32 > 24\text{dBm}$
6. $11\text{dBm} + 10\log(5725.00 - 5685.96) = 26.91 > 24\text{dBm}$

802.11ac (VHT80)

Chan.	Freq. (MHz)	Average Power (dBm)		Total Power (mW)	Total Power (dBm)	Power Limit (dBm)	Pass / Fail
		Chain 0	Chain 1				
58	5290	17.21	17.39	107.429	20.31	24.00	Pass
106	5530	17.33	16.92	103.279	20.14	24.00	Pass
122	5610	18.12	18.31	132.628	21.23	24.00	Pass
138	5690 (For U-NII-2C)	18.67	18.22	146.833	21.67	24.00	Pass
138	5690 (For U-NII-3)	4.80	4.00	5.802	7.64	30.00	Pass

Note:

For U-NII-2A, U-NII-2C Band:

Chain 0

1. $11\text{dBm} + 10\log(83.13) = 30.19 > 24\text{dBm}$
2. $11\text{dBm} + 10\log(83.91) = 30.23 > 24\text{dBm}$
3. $11\text{dBm} + 10\log(83.21) = 30.20 > 24\text{dBm}$
4. $11\text{dBm} + 10\log(5725.00 - 5648.38) = 29.84 > 24\text{dBm}$

Chain 1

1. $11\text{dBm} + 10\log(83.70) = 30.22 > 24\text{dBm}$
2. $11\text{dBm} + 10\log(83.61) = 30.22 > 24\text{dBm}$
3. $11\text{dBm} + 10\log(83.66) = 30.22 > 24\text{dBm}$
4. $11\text{dBm} + 10\log(5725.00 - 5648.33) = 29.85 > 24\text{dBm}$

802.11ax (HE20)

Chan.	Freq. (MHz)	Average Power (dBm)		Total Power (mW)	Total Power (dBm)	Power Limit (dBm)	Pass / Fail
		Chain 0	Chain 1				
52	5260	19.26	18.68	158.124	21.99	24.00	Pass
60	5300	18.87	19.22	160.651	22.06	24.00	Pass
64	5320	18.22	17.66	124.719	20.96	24.00	Pass
100	5500	18.52	17.55	128.007	21.07	24.00	Pass
116	5580	19.04	18.95	158.691	22.01	24.00	Pass
140	5700	17.36	17.03	104.916	20.21	24.00	Pass
144	5720 (For U-NII-2C)	18.02	17.54	125.557	20.99	23.05	Pass
144	5720 (For U-NII-3)	12.72	12.71	39.055	15.92	30.00	Pass

Note:

For U-NII-2A, U-NII-2C Band:

Chain 0

1. $11\text{dBm} + 10\log(22.52) = 24.52 > 24\text{dBm}$
2. $11\text{dBm} + 10\log(21.87) = 24.39 > 24\text{dBm}$
3. $11\text{dBm} + 10\log(21.98) = 24.42 > 24\text{dBm}$
4. $11\text{dBm} + 10\log(21.89) = 24.40 > 24\text{dBm}$
5. $11\text{dBm} + 10\log(21.89) = 24.40 > 24\text{dBm}$
6. $11\text{dBm} + 10\log(21.92) = 24.40 > 24\text{dBm}$
7. $11\text{dBm} + 10\log(5725.00 - 5708.87) = 23.07 < 24\text{dBm}$

Chain 1

1. $11\text{dBm} + 10\log(21.95) = 24.41 > 24\text{dBm}$
2. $11\text{dBm} + 10\log(23.08) = 24.63 > 24\text{dBm}$
3. $11\text{dBm} + 10\log(22.13) = 24.44 > 24\text{dBm}$
4. $11\text{dBm} + 10\log(21.83) = 24.39 > 24\text{dBm}$
5. $11\text{dBm} + 10\log(22.14) = 24.45 > 24\text{dBm}$
6. $11\text{dBm} + 10\log(21.89) = 24.40 > 24\text{dBm}$
7. $11\text{dBm} + 10\log(5725.00 - 5708.95) = 23.05 < 24\text{dBm}$

802.11ax (HE40)

Chan.	Freq. (MHz)	Average Power (dBm)		Total Power (mW)	Total Power (dBm)	Power Limit (dBm)	Pass / Fail
		Chain 0	Chain 1				
54	5270	18.93	18.62	150.941	21.79	24.00	Pass
62	5310	18.24	18.25	133.515	21.26	24.00	Pass
102	5510	18.31	17.45	123.355	20.91	24.00	Pass
110	5550	21.15	20.57	244.342	23.88	24.00	Pass
134	5670	19.25	18.48	154.609	21.89	24.00	Pass
142	5710 (For U-NII-2C)	20.14	19.91	211.073	23.24	24.00	Pass
142	5710 (For U-NII-3)	10.23	10.40	22.561	13.53	30.00	Pass

Note:

For U-NII-2A, U-NII-2C Band:

Chain 0

1. $11\text{dBm} + 10\log(42.40) = 27.27 > 24\text{dBm}$
2. $11\text{dBm} + 10\log(42.45) = 27.27 > 24\text{dBm}$
3. $11\text{dBm} + 10\log(42.77) = 27.31 > 24\text{dBm}$
4. $11\text{dBm} + 10\log(59.42) = 28.73 > 24\text{dBm}$
5. $11\text{dBm} + 10\log(42.39) = 27.27 > 24\text{dBm}$
6. $11\text{dBm} + 10\log(5725.00 - 5687.40) = 26.75 > 24\text{dBm}$

Chain 1

1. $11\text{dBm} + 10\log(42.39) = 27.27 > 24\text{dBm}$
2. $11\text{dBm} + 10\log(42.67) = 27.30 > 24\text{dBm}$
3. $11\text{dBm} + 10\log(42.25) = 27.25 > 24\text{dBm}$
4. $11\text{dBm} + 10\log(43.34) = 27.36 > 24\text{dBm}$
5. $11\text{dBm} + 10\log(42.90) = 27.32 > 24\text{dBm}$
6. $11\text{dBm} + 10\log(5725.00 - 5685.96) = 26.91 > 24\text{dBm}$

802.11ax (HE80)

Chan.	Freq. (MHz)	Average Power (dBm)		Total Power (mW)	Total Power (dBm)	Power Limit (dBm)	Pass / Fail
		Chain 0	Chain 1				
58	5290	17.32	17.52	110.445	20.43	24.00	Pass
106	5530	17.45	17.02	105.940	20.25	24.00	Pass
122	5610	18.25	18.42	136.337	21.35	24.00	Pass
138	5690 (For U-NII-2C)	18.71	18.25	150.153	21.77	24.00	Pass
138	5690 (For U-NII-3)	4.83	4.02	5.920	7.72	30.00	Pass

Note:

For U-NII-2A, U-NII-2C Band:

Chain 0

1. $11\text{dBm} + 10\log(83.13) = 30.19 > 24\text{dBm}$
2. $11\text{dBm} + 10\log(83.91) = 30.23 > 24\text{dBm}$
3. $11\text{dBm} + 10\log(83.21) = 30.20 > 24\text{dBm}$
4. $11\text{dBm} + 10\log(5725.00 - 5648.38) = 29.84 > 24\text{dBm}$

Chain 1

1. $11\text{dBm} + 10\log(83.70) = 30.22 > 24\text{dBm}$
2. $11\text{dBm} + 10\log(83.61) = 30.22 > 24\text{dBm}$
3. $11\text{dBm} + 10\log(83.66) = 30.22 > 24\text{dBm}$
4. $11\text{dBm} + 10\log(5725.00 - 5648.33) = 29.85 > 24\text{dBm}$

Beamforming Mode

802.11ac (VHT20)

Chan.	Freq. (MHz)	Average Power (dBm)		Total Power (mW)	Total Power (dBm)	Power Limit (dBm)	Pass / Fail
		Chain 0	Chain 1				
52	5260	19.14	18.55	153.649	21.87	22.66	Pass
60	5300	18.77	19.11	156.806	21.95	22.66	Pass
64	5320	18.12	17.54	121.618	20.85	22.66	Pass
100	5500	18.41	17.44	124.805	20.96	22.18	Pass
116	5580	19.03	18.93	158.146	21.99	22.18	Pass
140	5700	17.25	16.94	102.520	20.11	22.18	Pass
144	5720 (For U-NII-2C)	17.99	17.51	124.583	20.95	21.23	Pass
144	5720 (For U-NII-3)	12.68	12.67	38.663	15.87	28.14	Pass

Note:

- 5260-5320MHz: Directional gain = $10 \log[(10^{G1/20} + 10^{G2/20} + \dots + 10^{GN/20})^2/2] = 7.34\text{dBi} > 6\text{dBi}$, so the power limit shall be reduced to $24 - (7.34 - 6) = 22.66\text{dBm}$.
- 5500-5700MHz: Directional gain = $10 \log[(10^{G1/20} + 10^{G2/20} + \dots + 10^{GN/20})^2/2] = 7.82\text{dBi} > 6\text{dBi}$, so the power limit shall be reduced to $24 - (7.82 - 6) = 22.18\text{dBm}$.
- 5720MHz: Directional gain = $10 \log[(10^{G1/20} + 10^{G2/20} + \dots + 10^{GN/20})^2/2] = 7.82\text{dBi} > 6\text{dBi}$, so the power limit shall be reduced to $23.05 - (7.82 - 6) = 21.23\text{dBm}$.
- 5745-5825MHz: Directional gain = $10 \log[(10^{G1/20} + 10^{G2/20} + \dots + 10^{GN/20})^2/2] = 7.86\text{dBi} > 6\text{dBi}$, so the power limit shall be reduced to $30 - (7.86 - 6) = 28.14\text{dBm}$.

For U-NII-2A, U-NII-2C Band:

Chain 0

- $11\text{dBm} + 10\log(22.52) = 24.52 > 24\text{dBm}$
- $11\text{dBm} + 10\log(21.87) = 24.39 > 24\text{dBm}$
- $11\text{dBm} + 10\log(21.98) = 24.42 > 24\text{dBm}$
- $11\text{dBm} + 10\log(21.89) = 24.40 > 24\text{dBm}$
- $11\text{dBm} + 10\log(21.89) = 24.40 > 24\text{dBm}$
- $11\text{dBm} + 10\log(21.92) = 24.40 > 24\text{dBm}$
- $11\text{dBm} + 10\log(5725.00 - 5708.87) = 23.07 < 24\text{dBm}$

Chain 1

- $11\text{dBm} + 10\log(21.95) = 24.41 > 24\text{dBm}$
- $11\text{dBm} + 10\log(23.08) = 24.63 > 24\text{dBm}$
- $11\text{dBm} + 10\log(22.13) = 24.44 > 24\text{dBm}$
- $11\text{dBm} + 10\log(21.83) = 24.39 > 24\text{dBm}$
- $11\text{dBm} + 10\log(22.14) = 24.45 > 24\text{dBm}$
- $11\text{dBm} + 10\log(21.89) = 24.40 > 24\text{dBm}$
- $11\text{dBm} + 10\log(5725.00 - 5708.95) = 23.05 < 24\text{dBm}$

802.11ac (VHT40)

Chan.	Freq. (MHz)	Average Power (dBm)		Total Power (mW)	Total Power (dBm)	Power Limit (dBm)	Pass / Fail
		Chain 0	Chain 1				
54	5270	18.82	18.51	147.166	21.68	22.66	Pass
62	5310	18.11	18.13	129.727	21.13	22.66	Pass
102	5510	18.18	17.33	119.841	20.79	22.18	Pass
110	5550	19.02	18.45	149.784	21.75	22.18	Pass
134	5670	19.12	18.34	149.892	21.76	22.18	Pass
142	5710 (For U-NII-2C)	18.60	18.35	147.727	21.69	22.18	Pass
142	5710 (For U-NII-3)	8.68	8.82	15.734	11.97	28.14	Pass

Note:

- 5260-5320MHz: Directional gain = $10 \log[(10^{G^1/20} + 10^{G^2/20} + \dots + 10^{G^N/20})^2/2] = 7.34\text{dBi} > 6\text{dBi}$, so the power limit shall be reduced to $24 - (7.34 - 6) = 22.66\text{dBm}$.
- 5500-5720MHz: Directional gain = $10 \log[(10^{G^1/20} + 10^{G^2/20} + \dots + 10^{G^N/20})^2/2] = 7.82\text{dBi} > 6\text{dBi}$, so the power limit shall be reduced to $24 - (7.82 - 6) = 22.18\text{dBm}$.
- 5745-5825MHz: Directional gain = $10 \log[(10^{G^1/20} + 10^{G^2/20} + \dots + 10^{G^N/20})^2/2] = 7.86\text{dBi} > 6\text{dBi}$, so the power limit shall be reduced to $30 - (7.86 - 6) = 28.14\text{dBm}$.

For U-NII-2A, U-NII-2C Band:

Chain 0

- $11\text{dBm} + 10\log(42.40) = 27.27 > 24\text{dBm}$
- $11\text{dBm} + 10\log(42.45) = 27.27 > 24\text{dBm}$
- $11\text{dBm} + 10\log(42.77) = 27.31 > 24\text{dBm}$
- $11\text{dBm} + 10\log(59.42) = 28.73 > 24\text{dBm}$
- $11\text{dBm} + 10\log(42.39) = 27.27 > 24\text{dBm}$
- $11\text{dBm} + 10\log(5725.00 - 5687.40) = 26.75 > 24\text{dBm}$

Chain 1

- $11\text{dBm} + 10\log(42.39) = 27.27 > 24\text{dBm}$
- $11\text{dBm} + 10\log(42.67) = 27.30 > 24\text{dBm}$
- $11\text{dBm} + 10\log(42.25) = 27.25 > 24\text{dBm}$
- $11\text{dBm} + 10\log(43.34) = 27.36 > 24\text{dBm}$
- $11\text{dBm} + 10\log(42.90) = 27.32 > 24\text{dBm}$
- $11\text{dBm} + 10\log(5725.00 - 5685.96) = 26.91 > 24\text{dBm}$

802.11ac (VHT80)

Chan.	Freq. (MHz)	Average Power (dBm)		Total Power (mW)	Total Power (dBm)	Power Limit (dBm)	Pass / Fail
		Chain 0	Chain 1				
58	5290	17.21	17.39	107.429	20.31	22.66	Pass
106	5530	17.33	16.92	103.279	20.14	22.18	Pass
122	5610	18.12	18.31	132.628	21.23	22.18	Pass
138	5690 (For U-NII-2C)	18.67	18.22	146.833	21.67	22.18	Pass
138	5690 (For U-NII-3)	4.80	4.00	5.802	7.64	28.14	Pass

Note:

- 5260-5320MHz: Directional gain = $10 \log[(10^{G^1/20} + 10^{G^2/20} + \dots + 10^{G^N/20})^2/2] = 7.34\text{dBi} > 6\text{dBi}$, so the power limit shall be reduced to $24 - (7.34 - 6) = 22.66\text{dBm}$.
- 5500-5720MHz: Directional gain = $10 \log[(10^{G^1/20} + 10^{G^2/20} + \dots + 10^{G^N/20})^2/2] = 7.82\text{dBi} > 6\text{dBi}$, so the power limit shall be reduced to $24 - (7.82 - 6) = 22.18\text{dBm}$.
- 5745-5825MHz: Directional gain = $10 \log[(10^{G^1/20} + 10^{G^2/20} + \dots + 10^{G^N/20})^2/2] = 7.86\text{dBi} > 6\text{dBi}$, so the power limit shall be reduced to $30 - (7.86 - 6) = 28.14\text{dBm}$.

For U-NII-2A, U-NII-2C Band:

Chain 0

- $11\text{dBm} + 10\log(83.13) = 30.19 > 24\text{dBm}$
- $11\text{dBm} + 10\log(83.91) = 30.23 > 24\text{dBm}$
- $11\text{dBm} + 10\log(83.21) = 30.20 > 24\text{dBm}$
- $11\text{dBm} + 10\log(5725.00 - 5648.38) = 29.84 > 24\text{dBm}$

Chain 1

- $11\text{dBm} + 10\log(83.70) = 30.22 > 24\text{dBm}$
- $11\text{dBm} + 10\log(83.61) = 30.22 > 24\text{dBm}$
- $11\text{dBm} + 10\log(83.66) = 30.22 > 24\text{dBm}$
- $11\text{dBm} + 10\log(5725.00 - 5648.33) = 29.85 > 24\text{dBm}$

802.11ax (HE20)

Chan.	Freq. (MHz)	Average Power (dBm)		Total Power (mW)	Total Power (dBm)	Power Limit (dBm)	Pass / Fail
		Chain 0	Chain 1				
52	5260	19.26	18.68	158.124	21.99	22.66	Pass
60	5300	18.87	19.22	160.651	22.06	22.66	Pass
64	5320	18.22	17.66	124.719	20.96	22.66	Pass
100	5500	18.52	17.55	128.007	21.07	22.18	Pass
116	5580	19.04	18.95	158.691	22.01	22.18	Pass
140	5700	17.36	17.03	104.916	20.21	22.18	Pass
144	5720 (For U-NII-2C)	18.02	17.54	125.447	20.98	21.23	Pass
144	5720 (For U-NII-3)	12.72	12.71	39.021	15.91	28.14	Pass

Note:

- 5260-5320MHz: Directional gain = $10 \log[(10^{G^1/20} + 10^{G^2/20} + \dots + 10^{G^N/20})^2/2] = 7.34\text{dBi} > 6\text{dBi}$, so the power limit shall be reduced to $24 - (7.34 - 6) = 22.66\text{dBm}$.
- 5500-5700MHz: Directional gain = $10 \log[(10^{G^1/20} + 10^{G^2/20} + \dots + 10^{G^N/20})^2/2] = 7.82\text{dBi} > 6\text{dBi}$, so the power limit shall be reduced to $24 - (7.82 - 6) = 22.18\text{dBm}$.
- 5720MHz: Directional gain = $10 \log[(10^{G^1/20} + 10^{G^2/20} + \dots + 10^{G^N/20})^2/2] = 7.82\text{dBi} > 6\text{dBi}$, so the power limit shall be reduced to $23.05 - (7.82 - 6) = 21.23\text{dBm}$.
- 5745-5825MHz: Directional gain = $10 \log[(10^{G^1/20} + 10^{G^2/20} + \dots + 10^{G^N/20})^2/2] = 7.86\text{dBi} > 6\text{dBi}$, so the power limit shall be reduced to $30 - (7.86 - 6) = 28.14\text{dBm}$.

For U-NII-2A, U-NII-2C Band:

Chain 0

- $11\text{dBm} + 10\log(22.52) = 24.52 > 24\text{dBm}$
- $11\text{dBm} + 10\log(21.87) = 24.39 > 24\text{dBm}$
- $11\text{dBm} + 10\log(21.98) = 24.42 > 24\text{dBm}$
- $11\text{dBm} + 10\log(21.89) = 24.40 > 24\text{dBm}$
- $11\text{dBm} + 10\log(21.89) = 24.40 > 24\text{dBm}$
- $11\text{dBm} + 10\log(21.92) = 24.40 > 24\text{dBm}$
- $11\text{dBm} + 10\log(5725.00 - 5708.87) = 23.07 < 24\text{dBm}$

Chain 1

- $11\text{dBm} + 10\log(21.95) = 24.41 > 24\text{dBm}$
- $11\text{dBm} + 10\log(23.08) = 24.63 > 24\text{dBm}$
- $11\text{dBm} + 10\log(22.13) = 24.44 > 24\text{dBm}$
- $11\text{dBm} + 10\log(21.83) = 24.39 > 24\text{dBm}$
- $11\text{dBm} + 10\log(22.14) = 24.45 > 24\text{dBm}$
- $11\text{dBm} + 10\log(21.89) = 24.40 > 24\text{dBm}$
- $11\text{dBm} + 10\log(5725.00 - 5708.95) = 23.05 < 24\text{dBm}$

802.11ax (HE40)

Chan.	Freq. (MHz)	Average Power (dBm)		Total Power (mW)	Total Power (dBm)	Power Limit (dBm)	Pass / Fail
		Chain 0	Chain 1				
54	5270	18.93	18.62	150.941	21.79	22.66	Pass
62	5310	18.24	18.25	133.515	21.26	22.66	Pass
102	5510	18.31	17.45	123.355	20.91	22.18	Pass
110	5550	19.15	18.57	154.169	21.88	22.18	Pass
134	5670	19.25	18.48	154.609	21.89	22.18	Pass
142	5710 (For U-NII-2C)	18.64	18.41	149.428	21.74	22.18	Pass
142	5710 (For U-NII-3)	8.73	8.90	15.972	12.03	28.14	Pass

Note:

- 5260-5320MHz: Directional gain = $10 \log[(10^{G^1/20} + 10^{G^2/20} + \dots + 10^{G^N/20})^2/2] = 7.34\text{dBi} > 6\text{dBi}$, so the power limit shall be reduced to $24 - (7.34 - 6) = 22.66\text{dBm}$.
- 5500-5720MHz: Directional gain = $10 \log[(10^{G^1/20} + 10^{G^2/20} + \dots + 10^{G^N/20})^2/2] = 7.82\text{dBi} > 6\text{dBi}$, so the power limit shall be reduced to $24 - (7.82 - 6) = 22.18\text{dBm}$.
- 5745-5825MHz: Directional gain = $10 \log[(10^{G^1/20} + 10^{G^2/20} + \dots + 10^{G^N/20})^2/2] = 7.86\text{dBi} > 6\text{dBi}$, so the power limit shall be reduced to $30 - (7.86 - 6) = 28.14\text{dBm}$.

For U-NII-2A, U-NII-2C Band:

Chain 0

- $11\text{dBm} + 10\log(42.40) = 27.27 > 24\text{dBm}$
- $11\text{dBm} + 10\log(42.45) = 27.27 > 24\text{dBm}$
- $11\text{dBm} + 10\log(42.77) = 27.31 > 24\text{dBm}$
- $11\text{dBm} + 10\log(59.42) = 28.73 > 24\text{dBm}$
- $11\text{dBm} + 10\log(42.39) = 27.27 > 24\text{dBm}$
- $11\text{dBm} + 10\log(5725.00 - 5687.40) = 26.75 > 24\text{dBm}$

Chain 1

- $11\text{dBm} + 10\log(42.39) = 27.27 > 24\text{dBm}$
- $11\text{dBm} + 10\log(42.67) = 27.30 > 24\text{dBm}$
- $11\text{dBm} + 10\log(42.25) = 27.25 > 24\text{dBm}$
- $11\text{dBm} + 10\log(43.34) = 27.36 > 24\text{dBm}$
- $11\text{dBm} + 10\log(42.90) = 27.32 > 24\text{dBm}$
- $11\text{dBm} + 10\log(5725.00 - 5685.96) = 26.91 > 24\text{dBm}$

802.11ax (HE80)

Chan.	Freq. (MHz)	Average Power (dBm)		Total Power (mW)	Total Power (dBm)	Power Limit (dBm)	Pass / Fail
		Chain 0	Chain 1				
58	5290	17.32	17.52	110.445	20.43	22.66	Pass
106	5530	17.45	17.02	105.940	20.25	22.18	Pass
122	5610	18.25	18.42	136.337	21.35	22.18	Pass
138	5690 (For U-NII-2C)	18.71	18.25	148.031	21.70	22.18	Pass
138	5690 (For U-NII-3)	4.83	4.02	5.836	7.66	28.14	Pass

Note:

- 5260-5320MHz: Directional gain = $10 \log[(10^{G1/20} + 10^{G2/20} + \dots + 10^{GN/20})^2/2] = 7.34\text{dBi} > 6\text{dBi}$, so the power limit shall be reduced to $24 - (7.34 - 6) = 22.66\text{dBm}$.
- 5500-5720MHz: Directional gain = $10 \log[(10^{G1/20} + 10^{G2/20} + \dots + 10^{GN/20})^2/2] = 7.82\text{dBi} > 6\text{dBi}$, so the power limit shall be reduced to $24 - (7.82 - 6) = 22.18\text{dBm}$.
- 5745-5825MHz: Directional gain = $10 \log[(10^{G1/20} + 10^{G2/20} + \dots + 10^{GN/20})^2/2] = 7.86\text{dBi} > 6\text{dBi}$, so the power limit shall be reduced to $30 - (7.86 - 6) = 28.14\text{dBm}$.

For U-NII-2A, U-NII-2C Band:

Chain 0

- $11\text{dBm} + 10\log(83.13) = 30.19 > 24\text{dBm}$
- $11\text{dBm} + 10\log(83.91) = 30.23 > 24\text{dBm}$
- $11\text{dBm} + 10\log(83.21) = 30.20 > 24\text{dBm}$
- $11\text{dBm} + 10\log(5725.00 - 5648.38) = 29.84 > 24\text{dBm}$

Chain 1

- $11\text{dBm} + 10\log(83.70) = 30.22 > 24\text{dBm}$
- $11\text{dBm} + 10\log(83.61) = 30.22 > 24\text{dBm}$
- $11\text{dBm} + 10\log(83.66) = 30.22 > 24\text{dBm}$
- $11\text{dBm} + 10\log(5725.00 - 5648.33) = 29.85 > 24\text{dBm}$

Straddle channel power plots:

802.11a

Chain 0

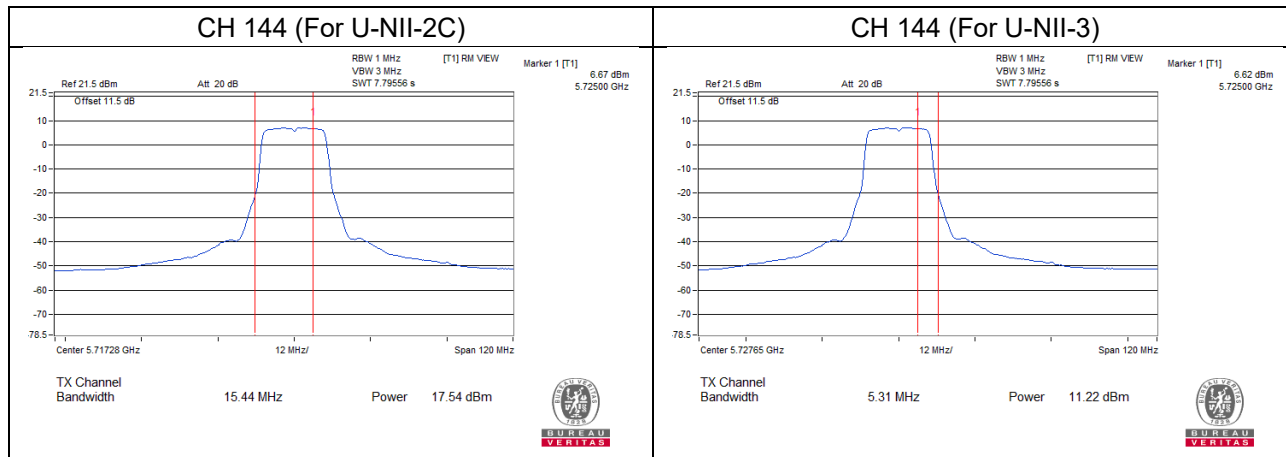

Chain 1

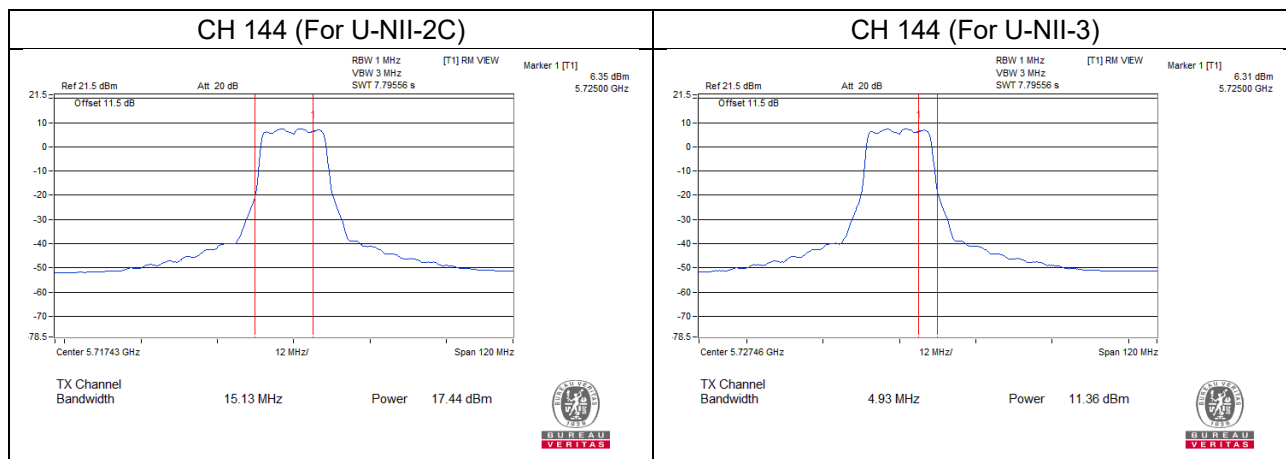

802.11ax (HE20)

Chain 0

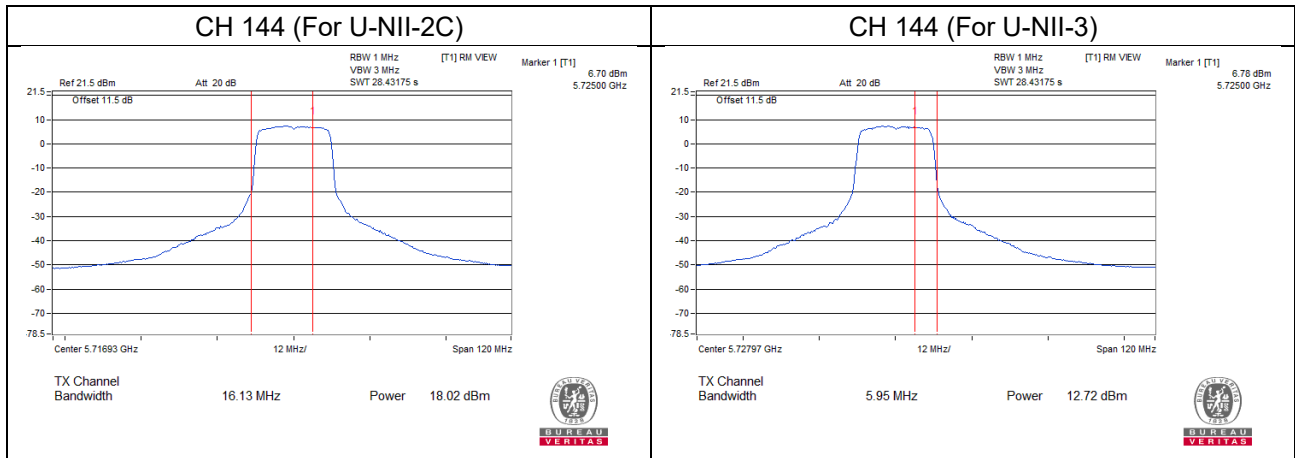

Chain 1

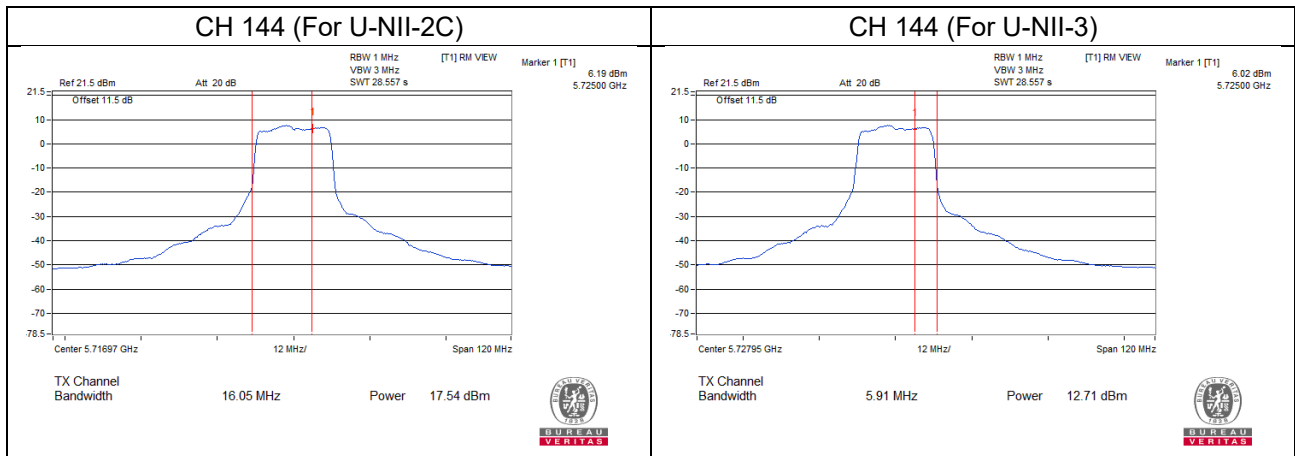

802.11ax (HE40)

Chain 0

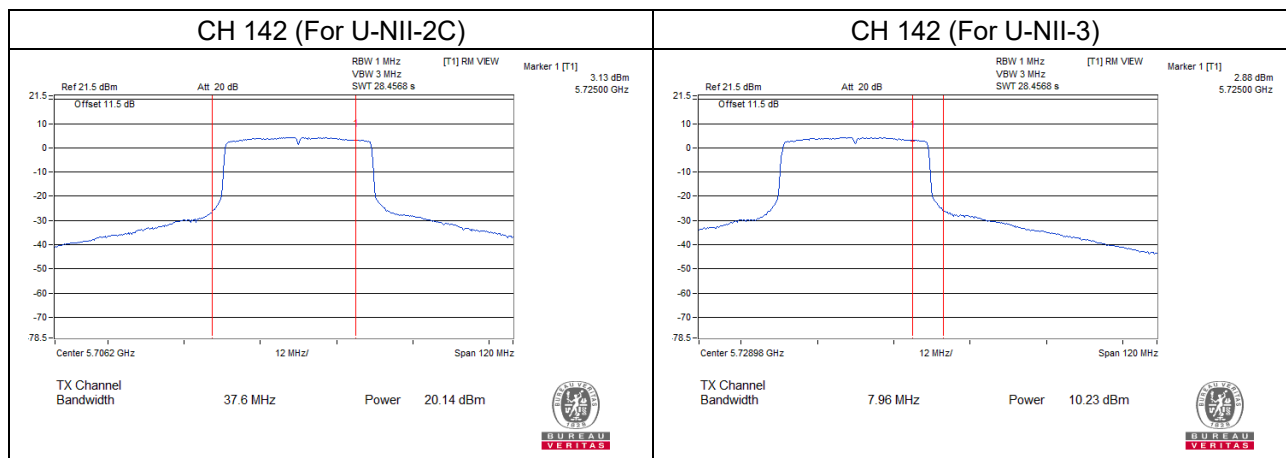

Chain 1

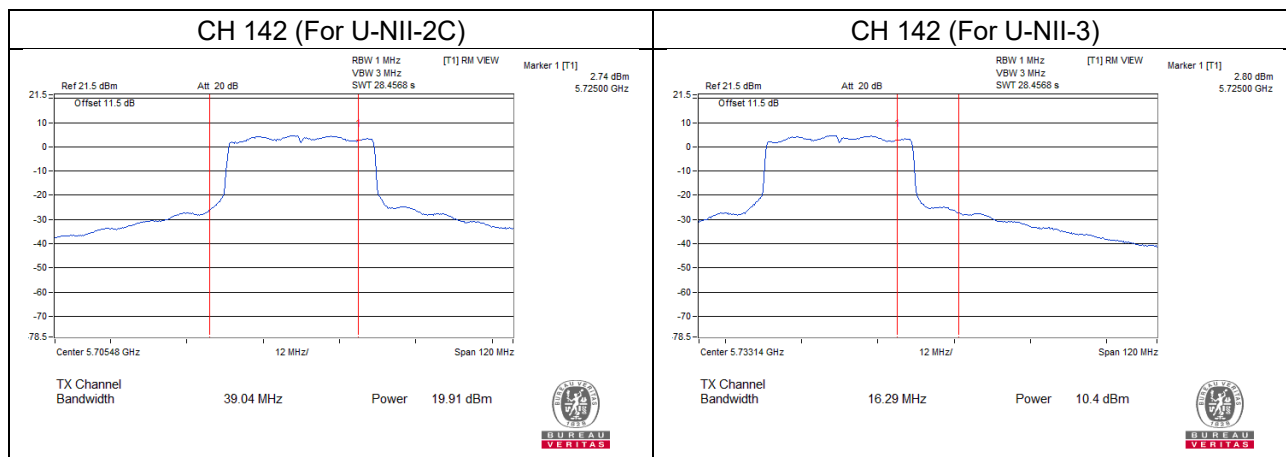

802.11ax (HE80)

Chain 0

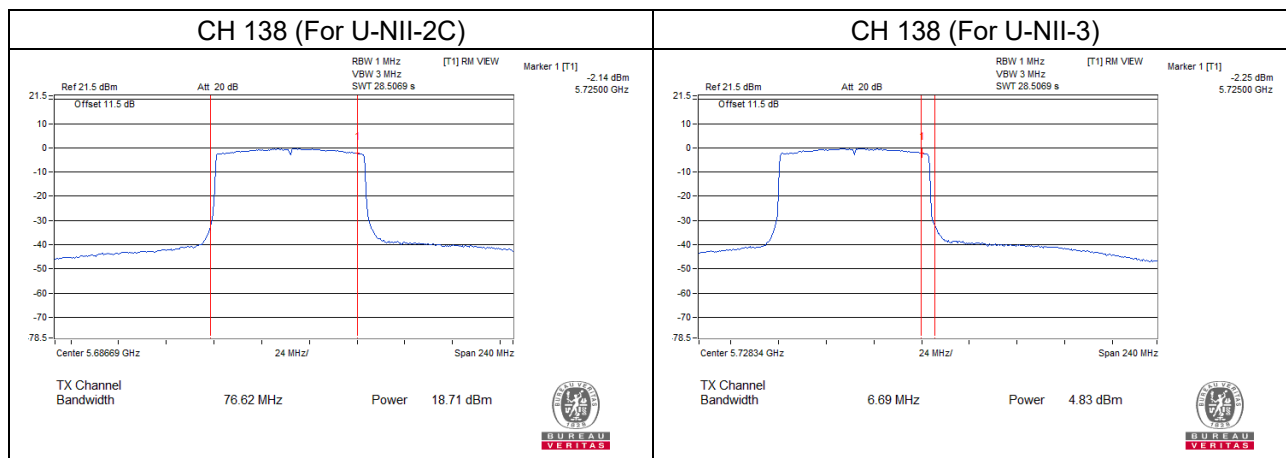

Chain 1

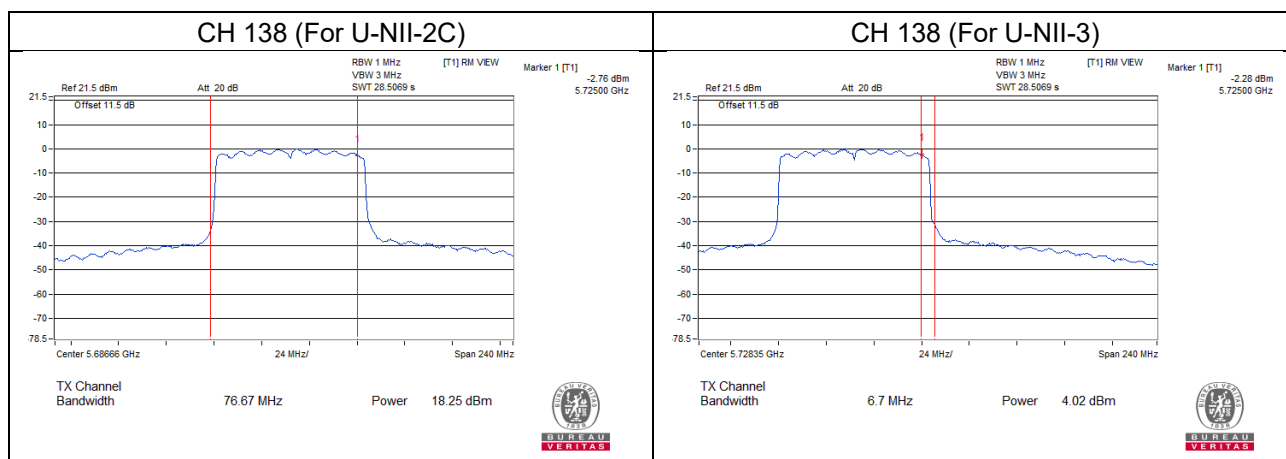

26dB Bandwidth:

802.11a

Chan.	Freq. (MHz)	26dBc Bandwidth (MHz)	
		Chain 0	Chain 1
52	5260	20.91	20.80
60	5300	21.04	20.90
64	5320	21.49	21.01
100	5500	20.87	20.90
116	5580	20.58	20.93
140	5700	20.71	19.86
144	5720 (For U-NII-2C)	15.44	15.13

For CH144 (U-NII-2C Band): The 26dBc bandwidth below 5725MHz = 5725MHz - Marker 1

802.11ax (HE20)

Chan.	Freq. (MHz)	26dBc Bandwidth (MHz)	
		Chain 0	Chain 1
52	5260	22.52	21.95
60	5300	21.87	23.08
64	5320	21.98	22.13
100	5500	21.89	21.83
116	5580	21.89	22.14
140	5700	21.92	21.89
144	5720 (For U-NII-2C)	16.13	16.05

For CH144 (U-NII-2C Band): The 26dBc bandwidth below 5725MHz = 5725MHz - Marker 1

802.11ax (HE40)

Chan.	Freq. (MHz)	26dBc Bandwidth (MHz)	
		Chain 0	Chain 1
54	5270	42.40	42.39
62	5310	42.45	42.67
102	5510	42.77	42.25
110	5550	59.42	43.34
134	5670	42.39	42.90
142	5710 (For U-NII-2C)	37.60	39.04

For CH142 (U-NII-2C Band): The 26dBc bandwidth below 5725MHz = 5725MHz - Marker 1

802.11ax (HE80)

Chan.	Freq. (MHz)	26dBc Bandwidth (MHz)	
		Chain 0	Chain 1
58	5290	83.13	83.70
106	5530	83.91	83.61
122	5610	83.21	83.66
138	5690 (For U-NII-2C)	76.62	76.67

For CH138 (U-NII-2C Band): The 26dBc bandwidth below 5725MHz = 5725MHz - Marker 1

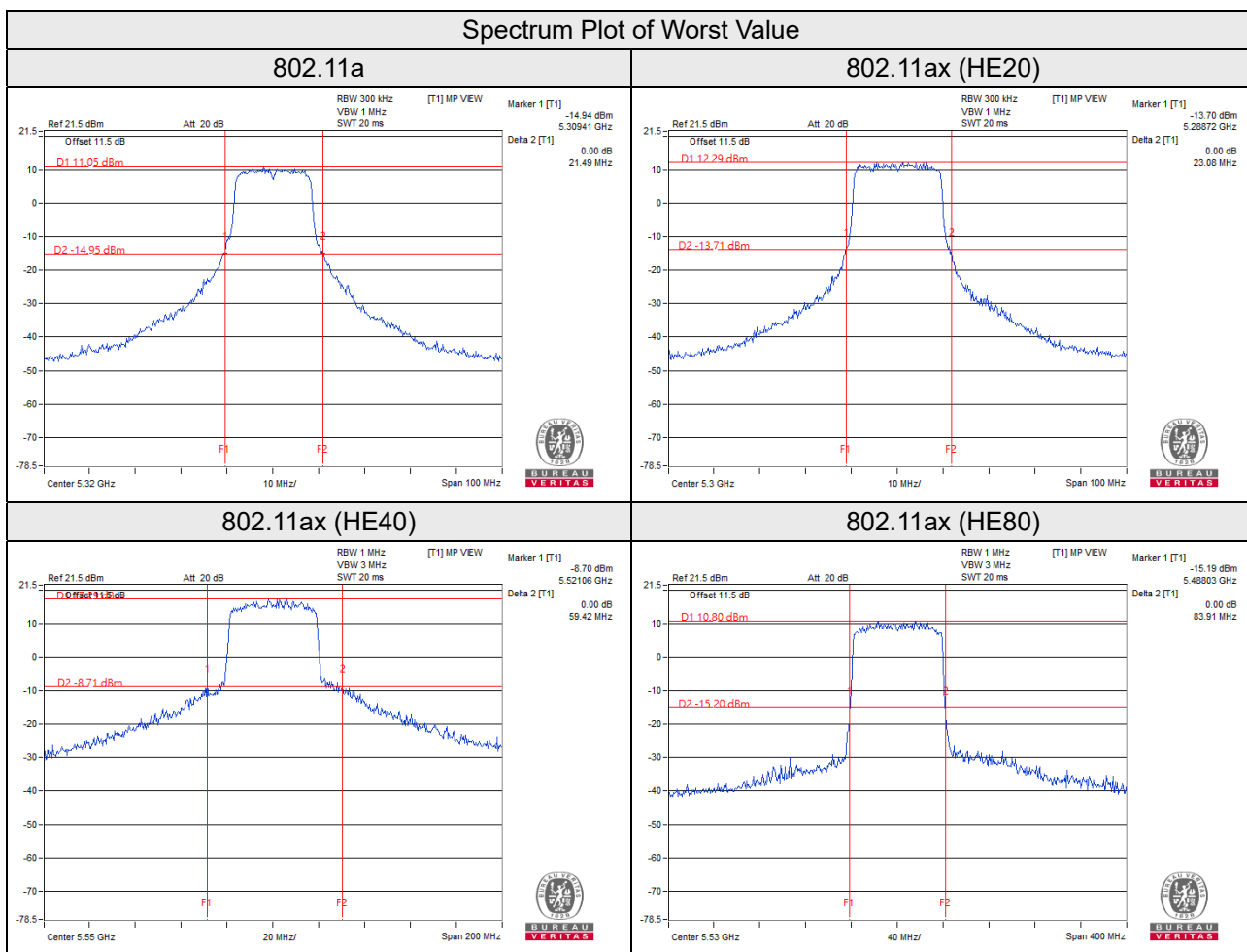

EUT Average Power

CDD Mode

802.11a

Frequency Band (MHz)	Max. Power	
	Output Power (dBm)	Output Power (mW)
5250~5350	21.80	151.197
5470~5725	21.72	148.521

802.11ax (HE20)

Frequency Band (MHz)	Max. Power	
	Output Power (dBm)	Output Power (mW)
5250~5350	22.06	160.651
5470~5725	22.01	158.691

802.11ax (HE40)

Frequency Band (MHz)	Max. Power	
	Output Power (dBm)	Output Power (mW)
5250~5350	21.79	150.941
5470~5725	23.88	244.342

802.11ax (HE80)

Frequency Band (MHz)	Max. Power	
	Output Power (dBm)	Output Power (mW)
5250~5350	20.43	110.445
5470~5725	21.77	150.153

Beamforming Mode

802.11ax (HE20)

Frequency Band (MHz)	Max. Power	
	Output Power (dBm)	Output Power (mW)
5250~5350	22.06	160.651
5470~5725	22.01	158.691

802.11ax (HE40)

Frequency Band (MHz)	Max. Power	
	Output Power (dBm)	Output Power (mW)
5250~5350	21.79	150.941
5470~5725	21.89	154.609

802.11ax (HE80)

Frequency Band (MHz)	Max. Power	
	Output Power (dBm)	Output Power (mW)
5250~5350	20.43	110.445
5470~5725	21.70	148.031

4.4 Occupied Bandwidth Measurement

4.4.1 Test Setup

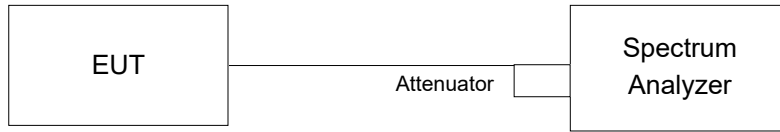

4.4.2 Test Instruments

Refer to section 4.1.2 to get information of above instrument.

4.4.3 Test Procedure

The transmitter output was connected to the spectrum analyzer through an attenuator. The bandwidth of the fundamental frequency was measured by spectrum analyzer with resolution bandwidth in the range of 1% to 5% of the anticipated emission bandwidth, and a video bandwidth at least 3x the resolution bandwidth and set the detector to sampling. The width of a frequency band such that, below the lower and above the upper frequency limits, the mean powers emitted are each equal to a specified percentage 0.5 % of the total mean power of a given emission.

4.4.4 Test Result

5G traffic radio (Radio 1)

802.11a

Chan.	Freq. (MHz)	Occupied Bandwidth (MHz)	
		Chain 0	Chain 1
52	5260	16.56	16.56
60	5300	16.44	16.44
64	5320	16.44	16.44
100	5500	16.56	16.32
116	5580	16.56	16.44
140	5700	16.44	16.44
144	5720 (For U-NII-2C)	13.28	13.28
144	5720 (For U-NII-3)	3.16	3.16

For CH144 (U-NII-2C Band): The Occupied bandwidth below 5725MHz = 5725MHz - Temp 1

For CH144 (U-NII-3 Band): The Occupied bandwidth above 5725MHz = Temp 2 - 5725MHz

802.11ax (HE20)

Chan.	Freq. (MHz)	Occupied Bandwidth (MHz)	
		Chain 0	Chain 1
52	5260	18.96	18.96
60	5300	18.96	18.96
64	5320	18.96	18.96
100	5500	18.96	18.96
116	5580	19.26	19.26
140	5700	18.96	18.84
144	5720 (For U-NII-2C)	14.48	14.48
144	5720 (For U-NII-3)	4.48	4.48

For CH144 (U-NII-2C Band): The Occupied bandwidth below 5725MHz = 5725MHz - Temp 1

For CH144 (U-NII-3 Band): The Occupied bandwidth above 5725MHz = Temp 2 - 5725MHz

802.11ax (HE40)

Chan.	Freq. (MHz)	Occupied Bandwidth (MHz)	
		Chain 0	Chain 1
54	5270	38.04	37.92
62	5310	37.92	38.16
102	5510	37.92	38.04
110	5550	39.30	38.40
134	5670	37.92	37.92
142	5710 (For U-NII-2C)	34.20	34.20
142	5710 (For U-NII-3)	4.20	4.20

For CH142 (U-NII-2C Band): The Occupied bandwidth below 5725MHz = 5725MHz - Temp 1

For CH142 (U-NII-3 Band): The Occupied bandwidth above 5725MHz = Temp 2 - 5725MHz

802.11ax (HE80)

Chan.	Freq. (MHz)	Occupied Bandwidth (MHz)	
		Chain 0	Chain 1
58	5290	77.52	77.76
106	5530	78.26	78.26
122	5610	77.52	77.52
138	5690 (For U-NII-2C)	73.88	73.88
138	5690 (For U-NII-3)	3.40	3.40

For CH138 (U-NII-2C Band): The Occupied bandwidth below 5725MHz = 5725MHz - Temp 1

For CH138 (U-NII-3 Band): The Occupied bandwidth above 5725MHz = Temp 2 - 5725MHz

Spectrum Plot of Worst Value

802.11a

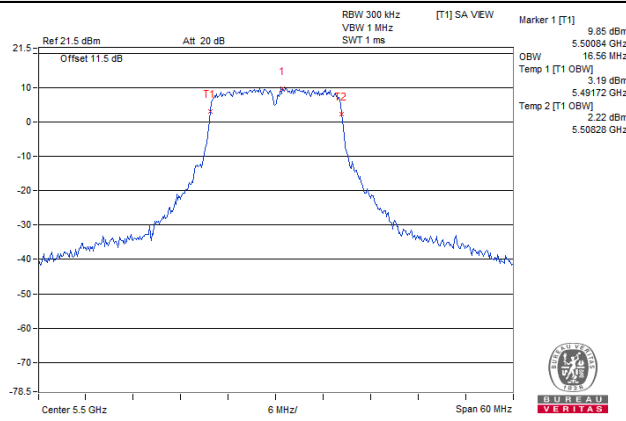

802.11ax (HE20)

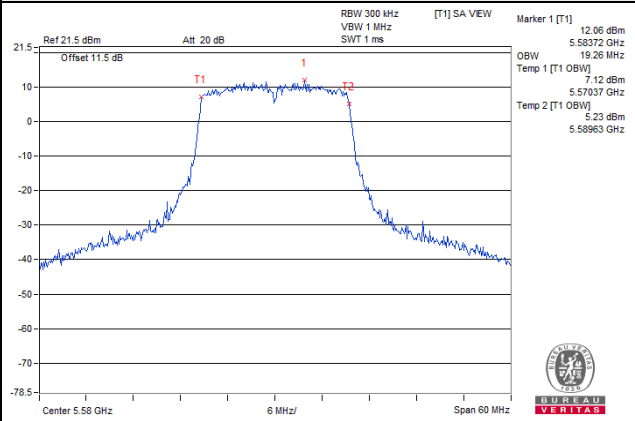

802.11ax (HE40)

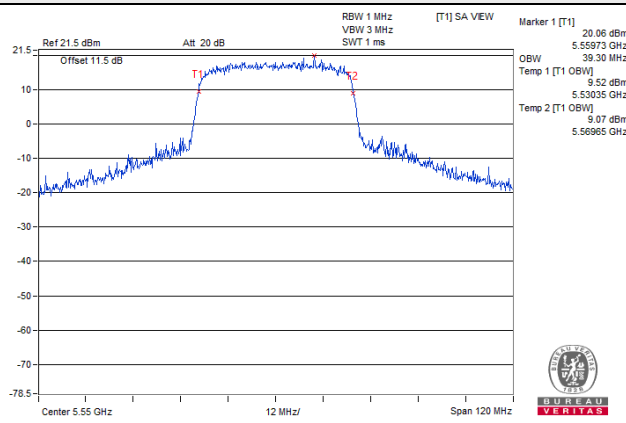

802.11ax (HE80)

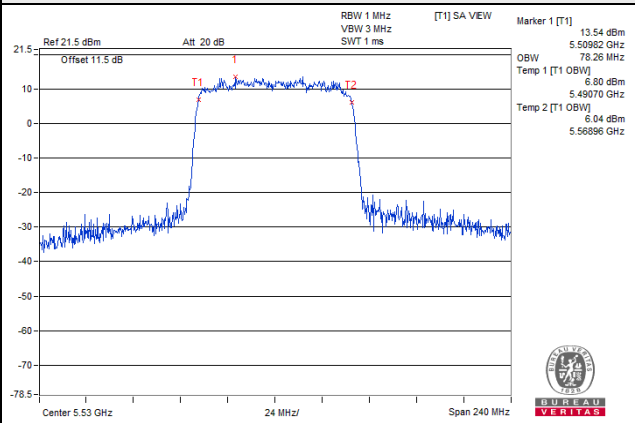

4.5 Peak Power Spectral Density Measurement

4.5.1 Limits of Peak Power Spectral Density Measurement

Operation Band	EUT Category		Limit
U-NII-1		Outdoor Access Point	17dBm/ MHz
		Fixed point-to-point Access Point	
		Indoor Access Point	
		Mobile and Portable client device	11dBm/ MHz
U-NII-2A	√		11dBm/ MHz
U-NII-2C	√		11dBm/ MHz
U-NII-3	√		30dBm/ 500kHz

4.5.2 Test Setup

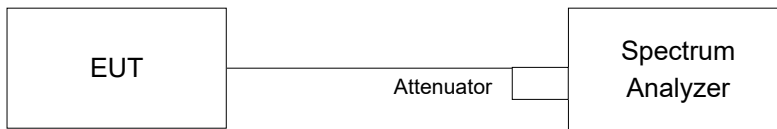

4.5.3 Test Instruments

Refer to section 4.1.2 to get information of above instrument.

4.5.4 Test Procedures

For U-NII-2A and U-NII-2C band:

Duty cycle of test signal is < 98%

Using method SA-2

- a. Set span to encompass the entire emission bandwidth (EBW) of the signal.
- b. Set RBW = 1MHz, Set VBW \geq 3 MHz, Detector = RMS
- c. Set Channel power measure = 1MHz
- d. Sweep time = auto, trigger set to "free run".
- e. Trace average at least 100 traces in power averaging mode.
- f. Record the max value and add $10 \log (1/\text{duty cycle})$

For U-NII-3 band:

Duty cycle of test signal is < 98%

- a. Set span to encompass the entire emission bandwidth (EBW) of the signal.
- b. Set RBW = 300 kHz, Set VBW \geq 1 MHz, Detector = RMS
- c. Use the peak marker function to determine the maximum power level in any 300 kHz band segment within the fundamental EBW.
- d. Scale the observed power level to an equivalent value in 500 kHz by adjusting (increasing) the measured power by a bandwidth correction factor (BWCF) where $BWCF = 10\log(500 \text{ kHz} / 300 \text{ kHz})$
- e. Sweep time = auto, trigger set to "free run".
- f. Trace average at least 100 traces in power averaging mode.
- g. Record the max value and add $10 \log (1/\text{duty cycle})$

4.5.5 Deviation from Test Standard

No deviation.

4.5.6 EUT Operating Conditions

Same as 4.3.6.

4.5.7 Test Results

5G traffic radio (Radio 1)

For U-NII-2A and U-NII-2C band:

802.11a

Chan.	Freq. (MHz)	PSD w/o Duty Factor (dBm/MHz)		Duty Factor (dB)	Total PSD with Duty Factor (dBm/MHz)	Max. Limit (dBm/MHz)	Pass / Fail
		Chain 0	Chain 1				
52	5260	5.47	4.98	0.39	8.63	9.66	Pass
60	5300	5.29	5.61	0.39	8.85	9.66	Pass
64	5320	6.00	5.70	0.39	9.25	9.66	Pass
100	5500	5.75	4.88	0.39	8.74	9.18	Pass
116	5580	5.62	5.79	0.39	9.11	9.18	Pass
140	5700	5.41	5.32	0.39	8.77	9.18	Pass
144	5720 (For U-NII-2C)	5.59	5.35	0.39	8.87	9.18	Pass

Note:

- Method E) 2) a) of power density measurement of KDB 662911 is using for calculating total power density. Total power density is summing entire spectra across corresponding frequency bins on the various outputs by computer.
- 5260-5320MHz: Directional gain = $10 \log[(10^{G^1/20} + 10^{G^2/20} + \dots + 10^{G^N/20})^2/2]$ = 7.34dBi > 6dBi, so the power density limit shall be reduced to 11 - (7.34 - 6) = 9.66dBm.
- 5500-5720MHz: Directional gain = $10 \log[(10^{G^1/20} + 10^{G^2/20} + \dots + 10^{G^N/20})^2/2]$ = 7.82dBi > 6dBi, so the power density limit shall be reduced to 11 - (7.82 - 6) = 9.18dBm.
- Refer to section 3.3 for duty cycle spectrum plot.

802.11ax (HE20)

Chan.	Freq. (MHz)	PSD w/o Duty Factor (dBm/MHz)		Duty Factor (dB)	Total PSD with Duty Factor (dBm/MHz)	Max. Limit (dBm/MHz)	Pass / Fail
		Chain 0	Chain 1				
52	5260	5.75	5.04	0.19	8.61	9.66	Pass
60	5300	5.12	5.58	0.19	8.56	9.66	Pass
64	5320	4.66	4.08	0.19	7.58	9.66	Pass
100	5500	4.88	3.85	0.19	7.60	9.18	Pass
116	5580	5.88	5.78	0.19	9.03	9.18	Pass
140	5700	3.74	3.61	0.19	6.88	9.18	Pass
144	5720 (For U-NII-2C)	5.69	5.71	0.19	8.90	9.18	Pass

Note:

- Method E) 2) a) of power density measurement of KDB 662911 is using for calculating total power density. Total power density is summing entire spectra across corresponding frequency bins on the various outputs by computer.
- 5260-5320MHz: Directional gain = $10 \log[(10^{G^1/20} + 10^{G^2/20} + \dots + 10^{G^N/20})^2/2]$ = 7.34dBi > 6dBi, so the power density limit shall be reduced to 11 - (7.34 - 6) = 9.66dBm.
- 5500-5720MHz: Directional gain = $10 \log[(10^{G^1/20} + 10^{G^2/20} + \dots + 10^{G^N/20})^2/2]$ = 7.82dBi > 6dBi, so the power density limit shall be reduced to 11 - (7.82 - 6) = 9.18dBm.
- Refer to section 3.3 for duty cycle spectrum plot.

802.11ax (HE40)

Chan.	Freq. (MHz)	PSD w/o Duty Factor (dBm/MHz)		Duty Factor (dB)	Total PSD with Duty Factor (dBm/MHz)	Max. Limit (dBm/MHz)	Pass / Fail
		Chain 0	Chain 1				
54	5270	2.43	2.04	0.20	5.45	9.66	Pass
62	5310	1.56	1.59	0.20	4.79	9.66	Pass
102	5510	1.77	0.76	0.20	4.50	9.18	Pass
110	5550	4.49	3.98	0.20	7.45	9.18	Pass
134	5670	2.69	2.15	0.20	5.64	9.18	Pass
142	5710 (For U-NII-2C)	4.13	3.80	0.20	7.18	9.18	Pass

Note:

- Method E) 2) a) of power density measurement of KDB 662911 is using for calculating total power density. Total power density is summing entire spectra across corresponding frequency bins on the various outputs by computer.
- 5260-5320MHz: Directional gain = $10 \log[(10^{G1/20} + 10^{G2/20} + \dots + 10^{GN/20})^2/2] = 7.34\text{dBi} > 6\text{dBi}$, so the power density limit shall be reduced to $11 - (7.34 - 6) = 9.66\text{dBm}$.
- 5500-5720MHz: Directional gain = $10 \log[(10^{G1/20} + 10^{G2/20} + \dots + 10^{GN/20})^2/2] = 7.82\text{dBi} > 6\text{dBi}$, so the power density limit shall be reduced to $11 - (7.82 - 6) = 9.18\text{dBm}$.
- Refer to section 3.3 for duty cycle spectrum plot.

802.11ax (HE80)

Chan.	Freq. (MHz)	PSD w/o Duty Factor (dBm/MHz)		Duty Factor (dB)	Total PSD with Duty Factor (dBm/MHz)	Max. Limit (dBm/MHz)	Pass / Fail
		Chain 0	Chain 1				
58	5290	-2.40	-2.08	0.27	1.04	9.66	Pass
106	5530	-2.23	-2.65	0.27	0.85	9.18	Pass
122	5610	-1.35	-1.15	0.27	2.03	9.18	Pass
138	5690 (For U-NII-2C)	-0.63	-0.73	0.27	2.60	9.18	Pass

Note:

- Method E) 2) a) of power density measurement of KDB 662911 is using for calculating total power density. Total power density is summing entire spectra across corresponding frequency bins on the various outputs by computer.
- 5260-5320MHz: Directional gain = $10 \log[(10^{G1/20} + 10^{G2/20} + \dots + 10^{GN/20})^2/2] = 7.34\text{dBi} > 6\text{dBi}$, so the power density limit shall be reduced to $11 - (7.34 - 6) = 9.66\text{dBm}$.
- 5500-5720MHz: Directional gain = $10 \log[(10^{G1/20} + 10^{G2/20} + \dots + 10^{GN/20})^2/2] = 7.82\text{dBi} > 6\text{dBi}$, so the power density limit shall be reduced to $11 - (7.82 - 6) = 9.18\text{dBm}$.
- Refer to section 3.3 for duty cycle spectrum plot.

Spectrum Plot of Worst Value

802.11a / Chain 0 / CH 64

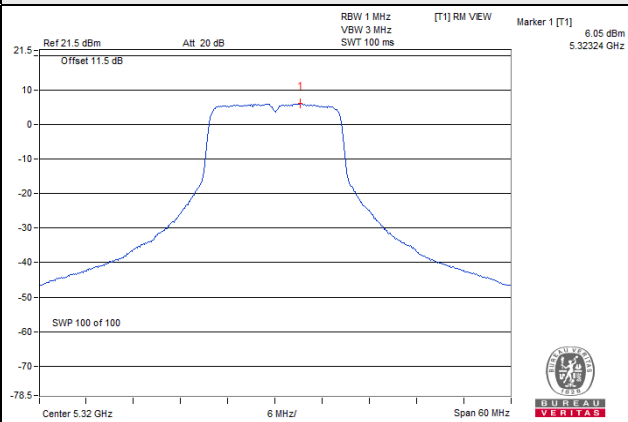

802.11ax (HE20) / Chain 0 / CH 116

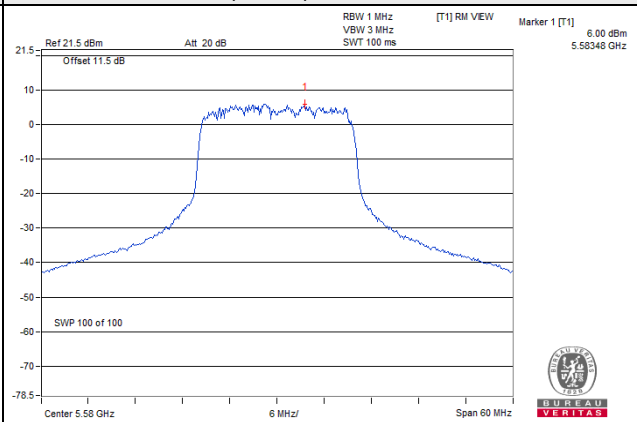

802.11ax (HE40) / Chain 0 / CH 110

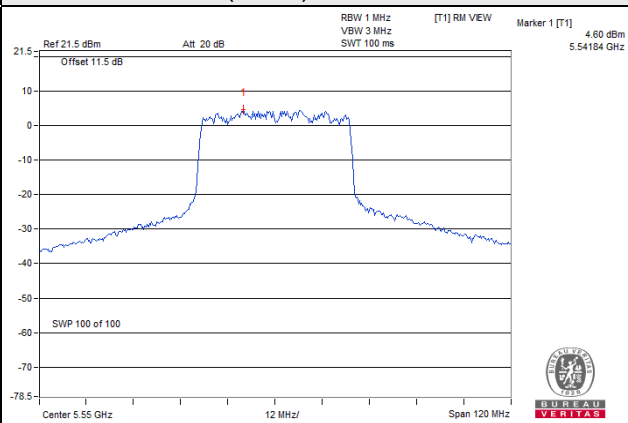

802.11ax (HE80) / Chain 0 / CH 138

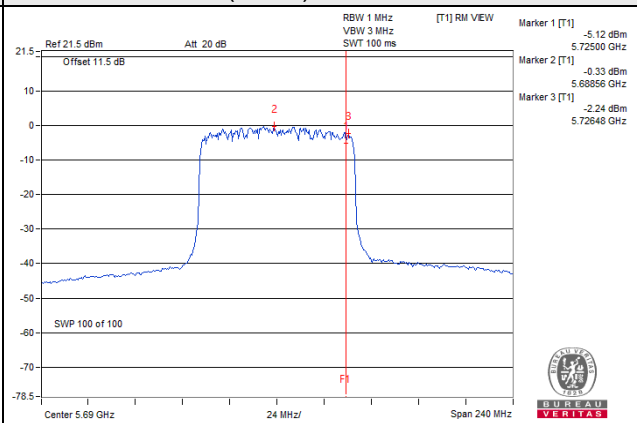

For U-NII-3 band:

802.11a

TX chain	Chan.	Freq. (MHz)	PSD W/O Duty Factor		10 log (N=2) dB	Duty Factor (dB)	Total PSD With Duty Factor (dBm/500kHz)	Limit (dBm/500kHz)	Pass / Fail
			(dBm/300kHz)	(dBm/500kHz)					
0	144	5720 (For U-NII-3)	-3.41	-1.19	3.01	0.39	2.21	28.14	Pass
1	144	5720 (For U-NII-3)	-3.69	-1.47	3.01	0.39	1.93	28.14	Pass

Note:

- Method E) 2) c) of power density measurement of KDB 662911 is using for calculating total power density, Measure value and add 10 log (N_{ANT}) dB.
- Directional gain = $10 \log[(10^{G1/20} + 10^{G2/20} + \dots + 10^{GN/20})^2/2] = 7.86\text{dBi} > 6\text{dBi}$, so the power density limit shall be reduced to $30 - (7.86 - 6) = 28.14\text{dBm}$.
- Refer to section 3.3 for duty cycle spectrum plot.

802.11ax (HE20)

TX chain	Chan.	Freq. (MHz)	PSD W/O Duty Factor		10 log (N=2) dB	Duty Factor (dB)	Total PSD With Duty Factor (dBm/500kHz)	Limit (dBm/500kHz)	Pass / Fail
			(dBm/300kHz)	(dBm/500kHz)					
0	144	5720 (For U-NII-3)	-3.80	-1.58	3.01	0.19	1.62	28.14	Pass
1	144	5720 (For U-NII-3)	-4.27	-2.05	3.01	0.19	1.15	28.14	Pass

Note:

- Method E) 2) c) of power density measurement of KDB 662911 is using for calculating total power density, Measure value and add 10 log (N_{ANT}) dB.
- Directional gain = $10 \log[(10^{G1/20} + 10^{G2/20} + \dots + 10^{GN/20})^2/2] = 7.86\text{dBi} > 6\text{dBi}$, so the power density limit shall be reduced to $30 - (7.86 - 6) = 28.14\text{dBm}$.
- Refer to section 3.3 for duty cycle spectrum plot.

802.11ax (HE40)

TX chain	Chan.	Freq. (MHz)	PSD W/O Duty Factor		10 log (N=2) dB	Duty Factor (dB)	Total PSD With Duty Factor (dBm/500kHz)	Limit (dBm/500kHz)	Pass / Fail
			(dBm/300kHz)	(dBm/500kHz)					
0	142	5710 (For U-NII-3)	-6.70	-4.48	3.01	0.20	-1.27	28.14	Pass
1	142	5710 (For U-NII-3)	-6.18	-3.96	3.01	0.20	-0.75	28.14	Pass

Note:

- Method E) 2) c) of power density measurement of KDB 662911 is using for calculating total power density, Measure value and add 10 log (N_{ANT}) dB.
- Directional gain = $10 \log[(10^{G1/20} + 10^{G2/20} + \dots + 10^{GN/20})^2/2] = 7.86\text{dBi} > 6\text{dBi}$, so the power density limit shall be reduced to $30 - (7.86 - 6) = 28.14\text{dBm}$.
- Refer to section 3.3 for duty cycle spectrum plot.

802.11ax (HE80)

TX chain	Chan.	Freq. (MHz)	PSD W/O Duty Factor		10 log (N=2) dB	Duty Factor (dB)	Total PSD With Duty Factor (dBm/500kHz)	Limit (dBm/500kHz)	Pass / Fail
			(dBm/300kHz)	(dBm/500kHz)					
0	138	5690 (For U-NII-3)	-12.01	-9.79	3.01	0.27	-6.51	28.14	Pass
1	138	5690 (For U-NII-3)	-12.34	-10.12	3.01	0.27	-6.84	28.14	Pass

Note:

- Method E) 2) c) of power density measurement of KDB 662911 is using for calculating total power density, Measure value and add 10 log (N_{ANT}) dB.
- Directional gain = $10 \log[(10^{G1/20} + 10^{G2/20} + \dots + 10^{GN/20})^2/2] = 7.86\text{dBi} > 6\text{dBi}$, so the power density limit shall be reduced to $30 - (7.86 - 6) = 28.14\text{dBm}$.
- Refer to section 3.3 for duty cycle spectrum plot.

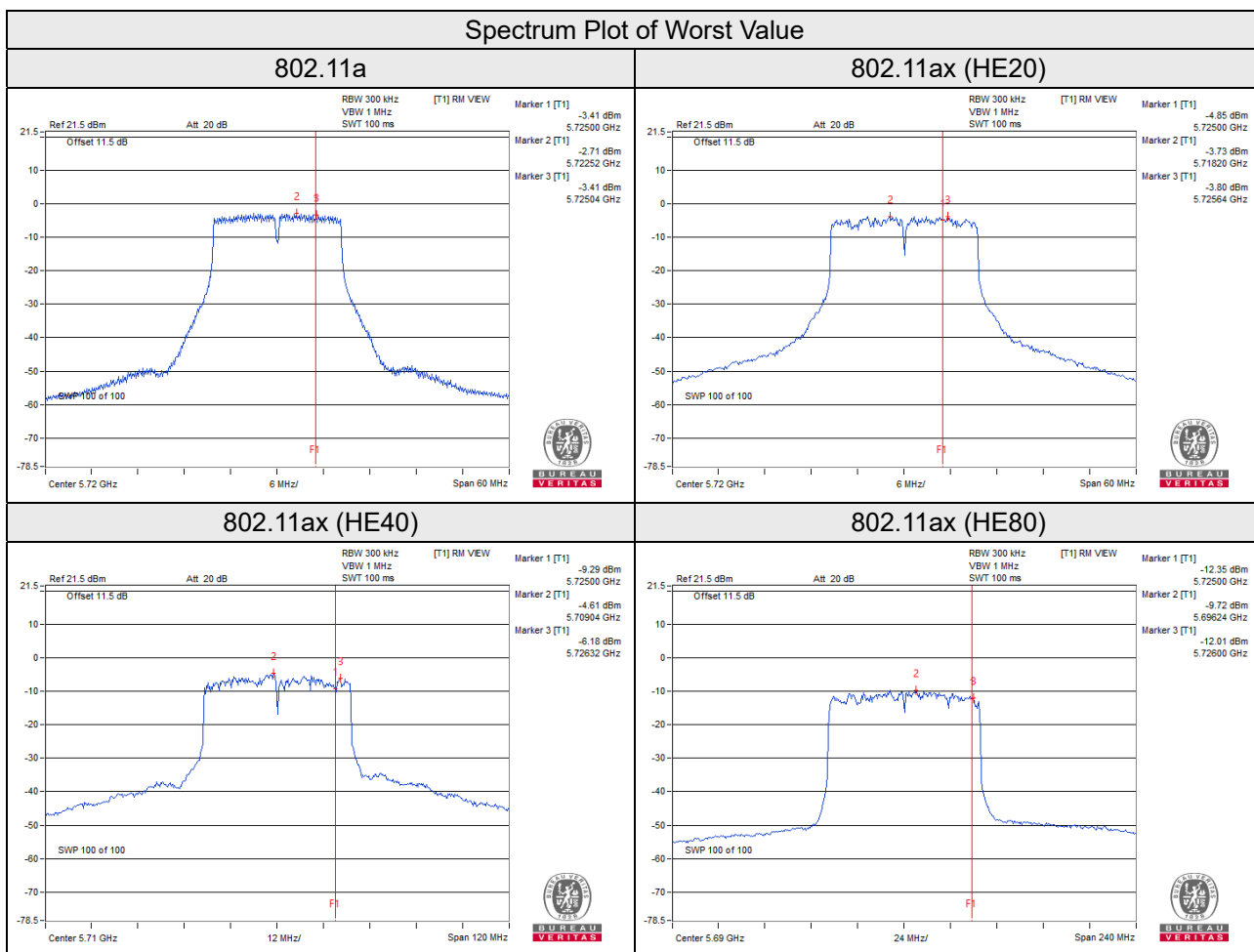

4.6 Frequency Stability

4.6.1 Limits of Frequency Stability Measurement

The frequency of the carrier signal shall be maintained within band of operation

4.6.2 Test Setup

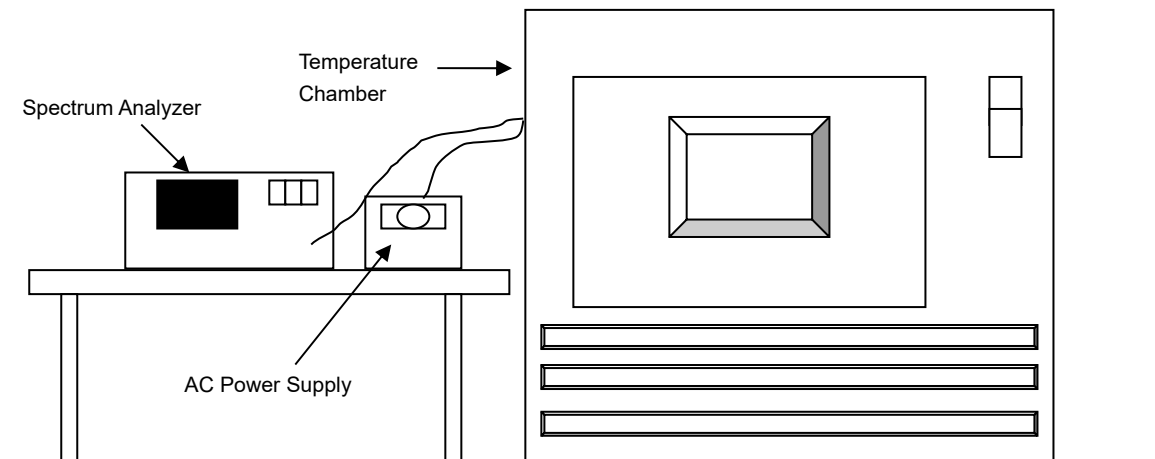

4.6.3 Test Instruments

Description & Manufacturer	Model No.	Serial No.	Cal. Date	Cal. Due
Spectrum Analyzer ROHDE & SCHWARZ	FSP40	100040	Sep. 15, 2021	Sep. 14, 2022
Standard Temperature And Humidity Chamber TERCHY	HRM-120RF	931022	Jan. 03, 2022	Jan. 02, 2023
Digital Multimeter Fluke	87-III	70360755	Jul. 08, 2021 Jul. 07, 2022	Jul. 07, 2022 Jul. 06, 2023
AC Power Supply Extech	CFW-105	E000603	NA	NA

Note: 1. The calibration interval of the above test instruments is 12 months and the calibrations are traceable to NML/ROC and NIST/USA.

4.6.4 Test Procedure

- The EUT was placed inside the environmental test chamber and powered by nominal AC voltage.
- Turn the EUT on and couple its output to a spectrum analyzer.
- Turn the EUT off and set the chamber to the highest temperature specified.
- Allow sufficient time (approximately 30 min) for the temperature of the chamber to stabilize, turn the EUT on and measure the operating frequency after 2, 5, and 10 minutes.
- Repeat step d with every 10 degrees reduction until the lowest temperature achieved.
- The test chamber was allowed to stabilize at +20 degree C for a minimum of 30 minutes. The supply voltage was then adjusted on the EUT from 85% to 115% and the frequency record.

4.6.5 Deviation from Test Standard

No deviation.

4.6.6 EUT Operating Condition

Set the EUT transmit at un-modulation mode to test frequency stability.

4.6.7 Test Results

5G traffic radio (Radio 1)

Frequency Stability Versus Temp.									
Operating Frequency: 5260MHz									
Temp. (°C)	Power Supply (Vac)	0 Minute		2 Minute		5 Minute		10 Minute	
		Measured Frequency (MHz)	Result	Measured Frequency (MHz)	Result	Measured Frequency (MHz)	Result	Measured Frequency (MHz)	Result
40	120	5260.0055	Pass	5260.0037	Pass	5260.0046	Pass	5260.0083	Pass
30	120	5259.9831	Pass	5259.982	Pass	5259.982	Pass	5259.9813	Pass
20	120	5259.9967	Pass	5260.0006	Pass	5260	Pass	5260.0012	Pass
10	120	5260.0239	Pass	5260.0249	Pass	5260.022	Pass	5260.0223	Pass
0	120	5260.0144	Pass	5260.0142	Pass	5260.0132	Pass	5260.0138	Pass

Frequency Stability Versus Voltage									
Operating Frequency: 5260MHz									
Temp. (°C)	Power Supply (Vac)	0 Minute		2 Minute		5 Minute		10 Minute	
		Measured Frequency (MHz)	Result	Measured Frequency (MHz)	Result	Measured Frequency (MHz)	Result	Measured Frequency (MHz)	Result
20	138	5259.9906	Pass	5259.9884	Pass	5259.9884	Pass	5259.9868	Pass
	120	5259.9967	Pass	5260.0006	Pass	5260	Pass	5260.0012	Pass
	102	5259.9894	Pass	5259.9874	Pass	5259.9856	Pass	5259.9892	Pass

4.7 6dB Bandwidth Measurement

4.7.1 Limits of 6dB Bandwidth Measurement

The minimum of 6dB Bandwidth Measurement is 0.5MHz.

4.7.2 Test Setup

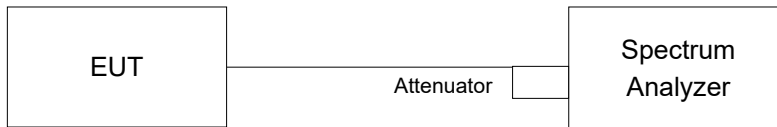

4.7.3 Test Instruments

Refer to section 4.1.2 to get information of above instrument.

4.7.4 Test Procedure

- Set resolution bandwidth (RBW) = 100kHz
- Set the video bandwidth (VBW) $\geq 3 \times$ RBW, Detector = Peak.
- Trace mode = max hold.
- Sweep = auto couple.
- Measure the maximum width of the emission that is constrained by the frequencies associated with the two amplitude points (upper and lower) that are attenuated by 6 dB relative to the maximum level measured in the fundamental emission

4.7.5 Deviation from Test Standard

No deviation.

4.7.6 EUT Operating Condition

The software provided by client to enable the EUT under transmission condition continuously at lowest, middle and highest channel frequencies individually.

4.7.7 Test Results

5G traffic radio (Radio 1)

802.11a

Channel	Frequency (MHz)	6dB Bandwidth (MHz)		Minimum Limit (MHz)	Pass / Fail
		Chain 0	Chain 1		
144	5720 (For U-NII-3)	2.90	2.76	0.50	Pass

For CH144 (U-NII-3 Band): The 6dB bandwidth above 5725MHz = Marker 1 + Delta 2 - 5725MHz

802.11ax (HE20)

Channel	Frequency (MHz)	6dB Bandwidth (MHz)		Minimum Limit (MHz)	Pass / Fail
		Chain 0	Chain 1		
144	5720 (For U-NII-3)	4.11	4.16	0.50	Pass

For CH144 (U-NII-3 Band): The 6dB bandwidth above 5725MHz = Marker 1 + Delta 2 - 5725MHz

802.11ax (HE40)

Channel	Frequency (MHz)	6dB Bandwidth (MHz)		Minimum Limit (MHz)	Pass / Fail
		Chain 0	Chain 1		
142	5710 (For U-NII-3)	4.02	4.01	0.50	Pass

For CH142 (U-NII-3 Band): The 6dB bandwidth above 5725MHz = Marker 1 + Delta 2 - 5725MHz

802.11ax (HE80)

Channel	Frequency (MHz)	6dB Bandwidth (MHz)		Minimum Limit (MHz)	Pass / Fail
		Chain 0	Chain 1		
138	5690 (For U-NII-3)	3.28	2.74	0.50	Pass

For CH138 (U-NII-3 Band): The 6dB bandwidth above 5725MHz = Marker 1 + Delta 2 - 5725MHz

Spectrum Plot of Worst Value

802.11a

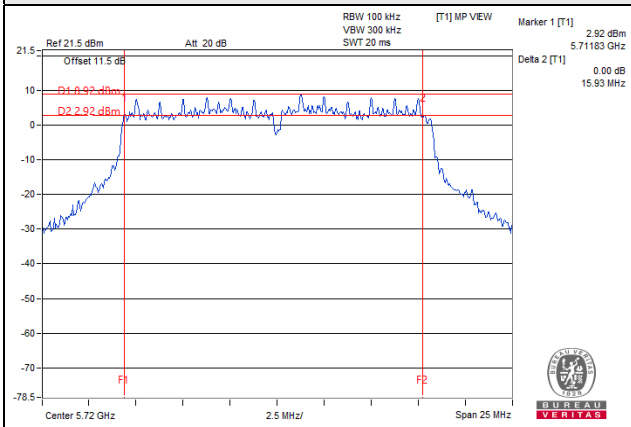

802.11ax (HE20)

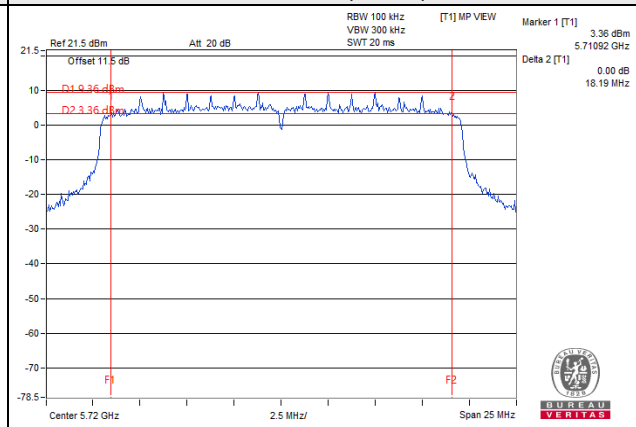

802.11ax (HE40)

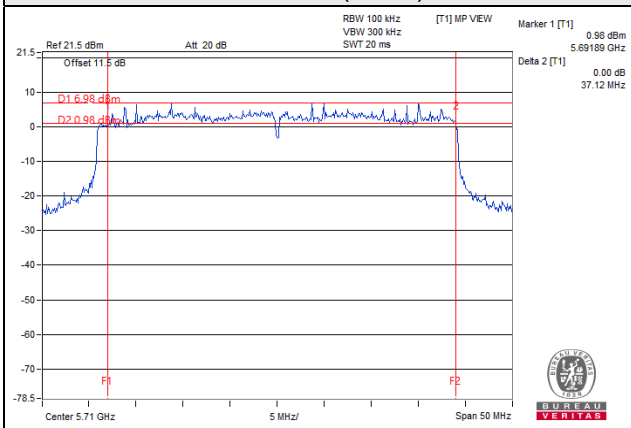

802.11ax (HE80)

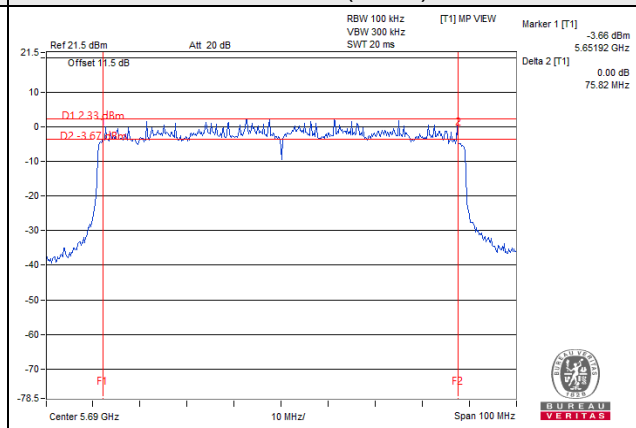

5 Pictures of Test Arrangements

Please refer to the attached file (Test Setup Photo).

Annex A - Band Edge Measurement

5G traffic radio (Radio 1)

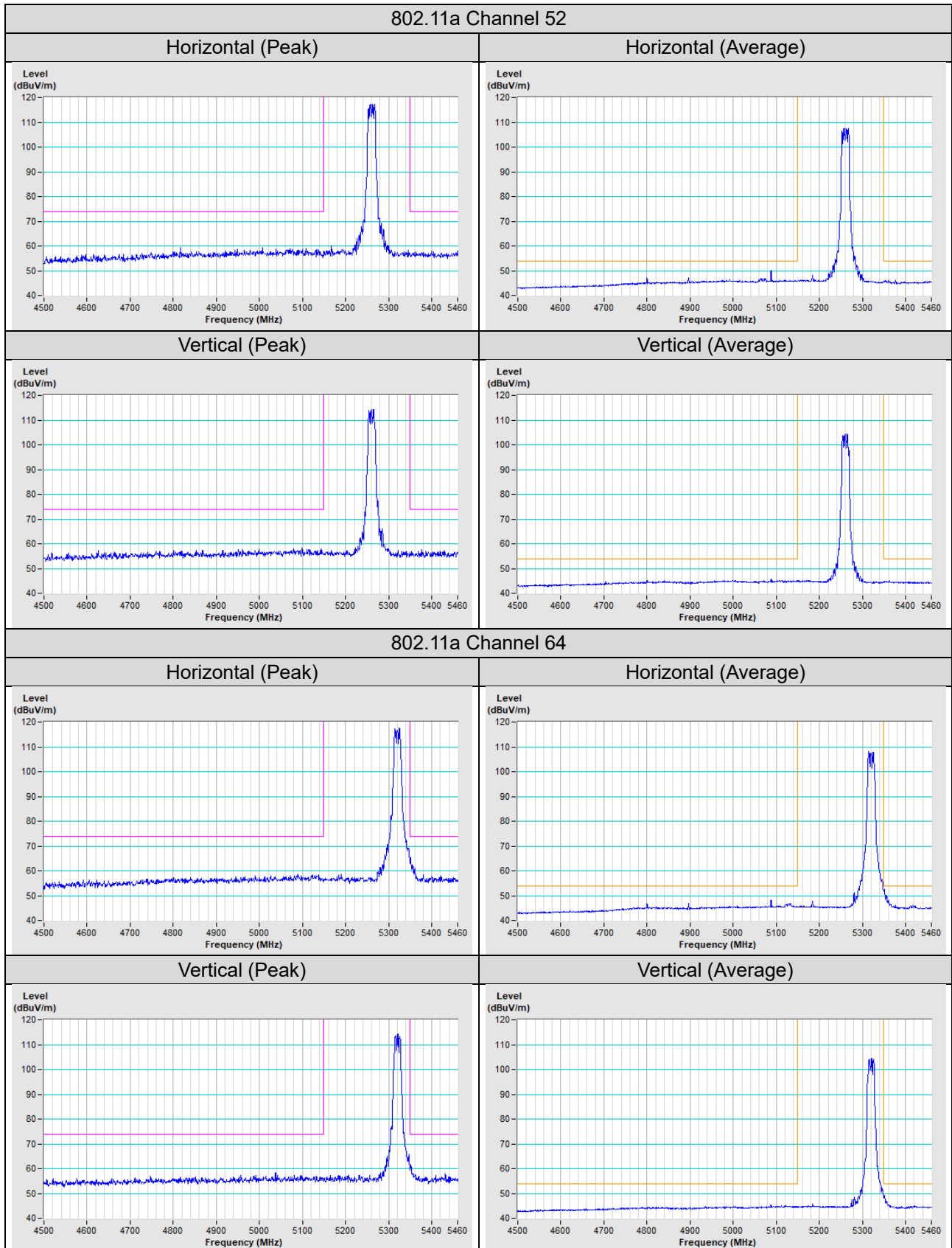

802.11a Channel 100

Horizontal (Peak)

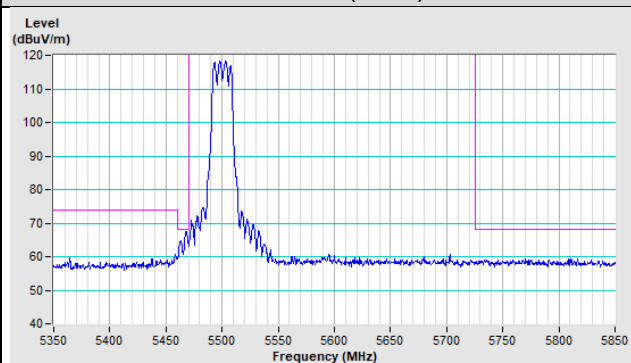

Horizontal (Average)

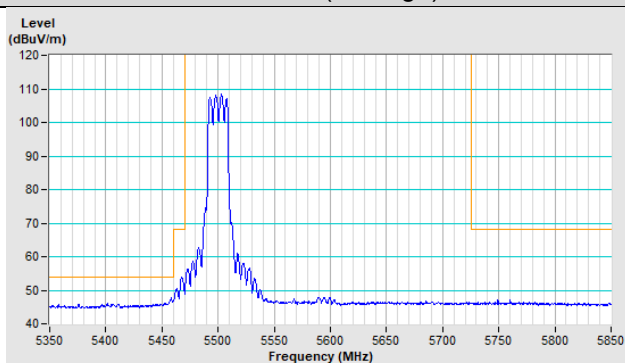

Vertical (Peak)

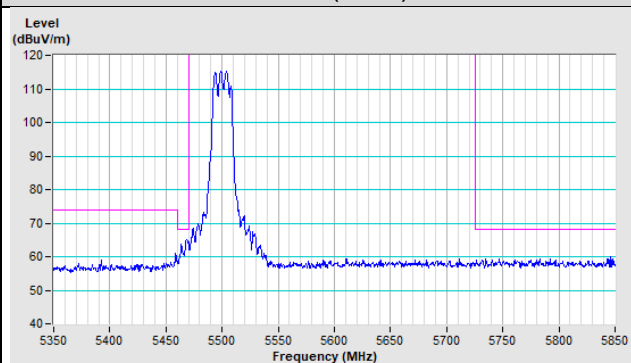

Vertical (Average)

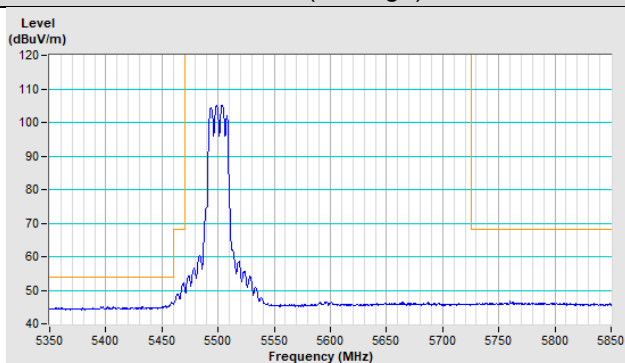

802.11a Channel 140

Horizontal (Peak)

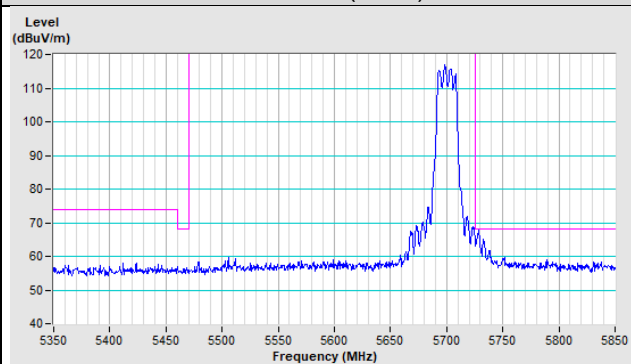

Vertical (Peak)

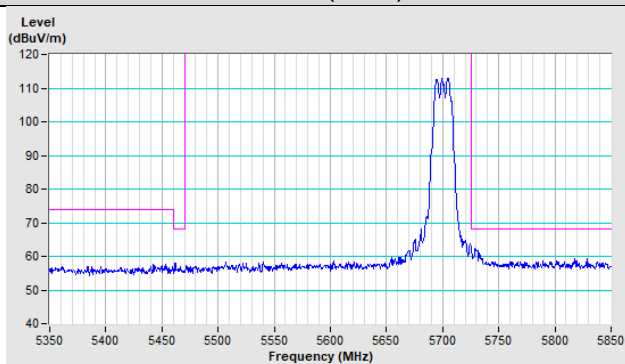

802.11a Channel 144

Horizontal (Peak)

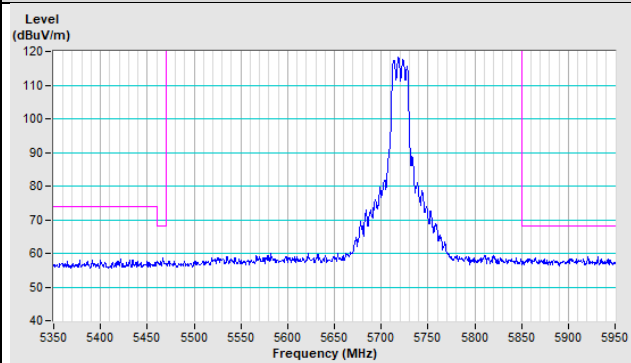

Vertical (Peak)

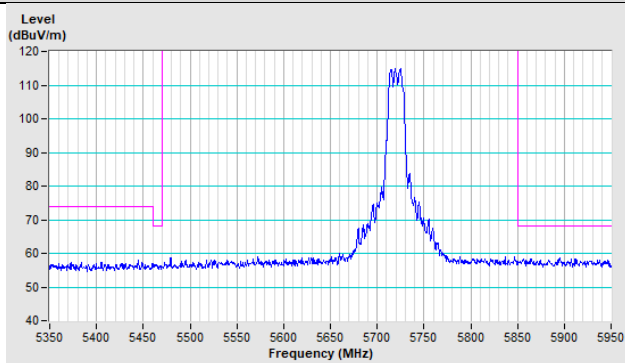

802.11ax (HE20) Channel 52

Horizontal (Peak)

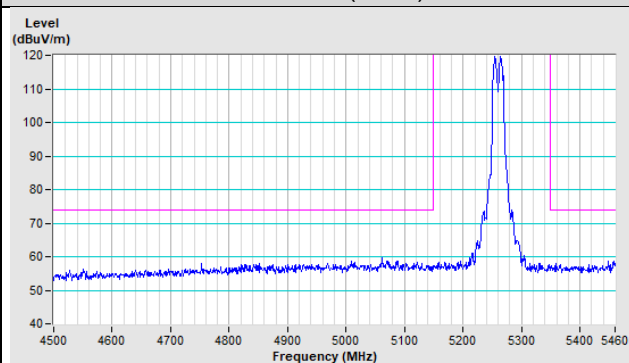

Horizontal (Average)

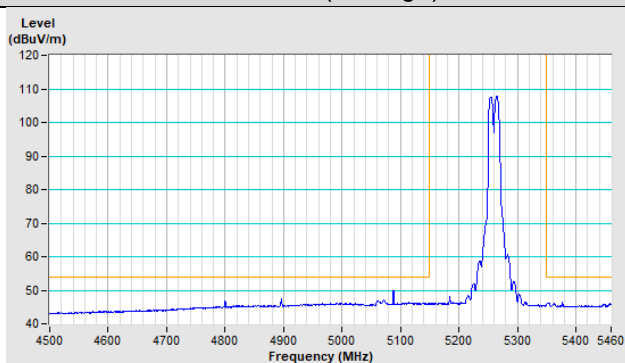

Vertical (Peak)

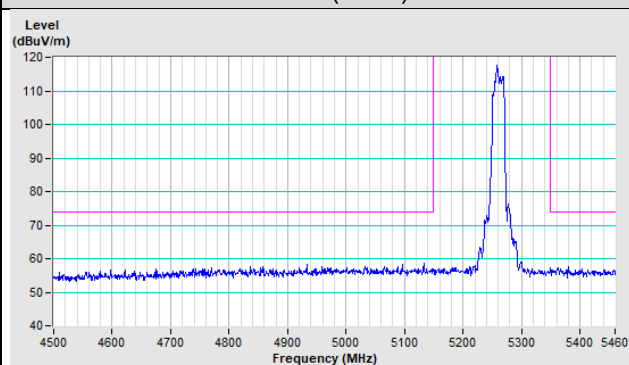

Vertical (Average)

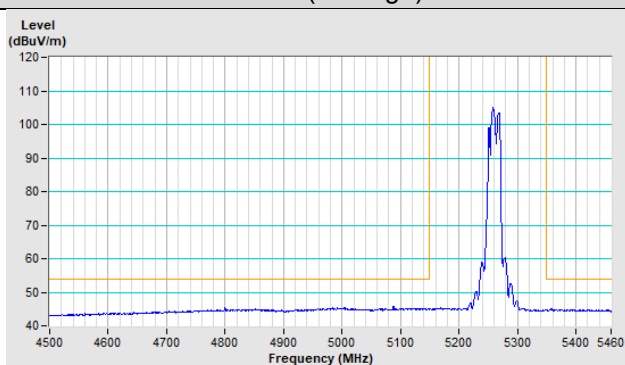

802.11ax (HE20) Channel 64

Horizontal (Peak)

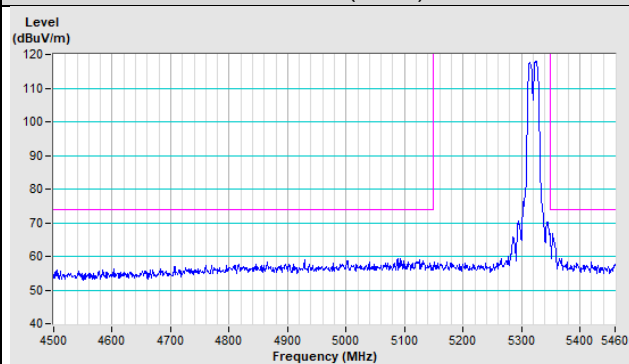

Horizontal (Average)

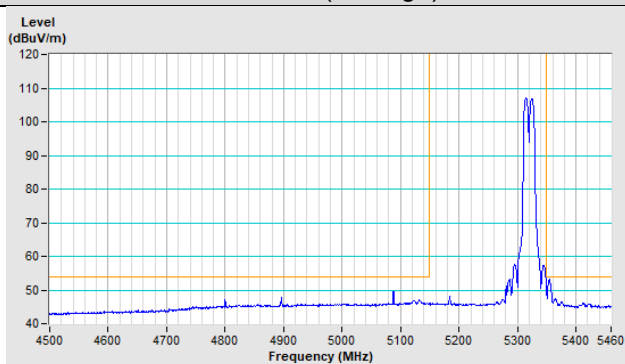

Vertical (Peak)

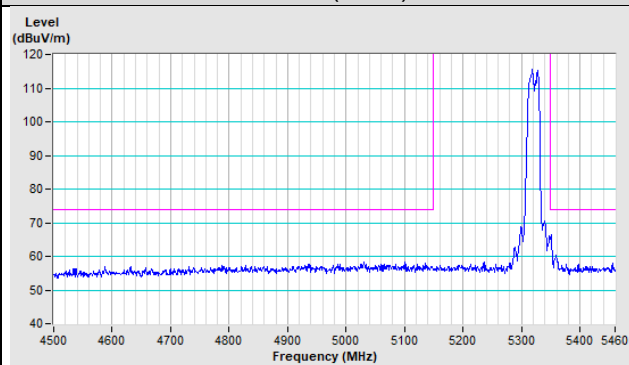

Vertical (Average)

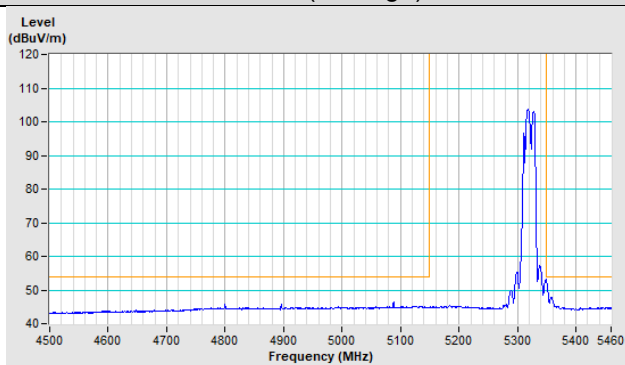

802.11ax (HE20) Channel 100

Horizontal (Peak)

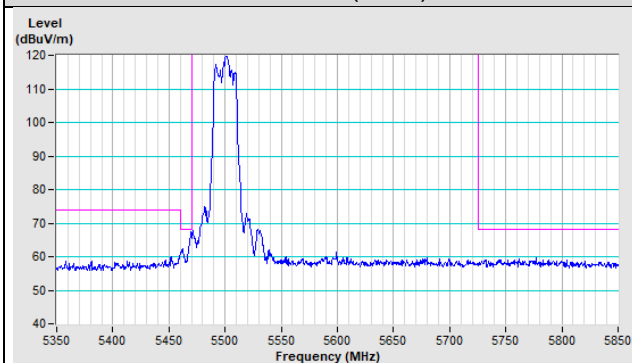

Horizontal (Average)

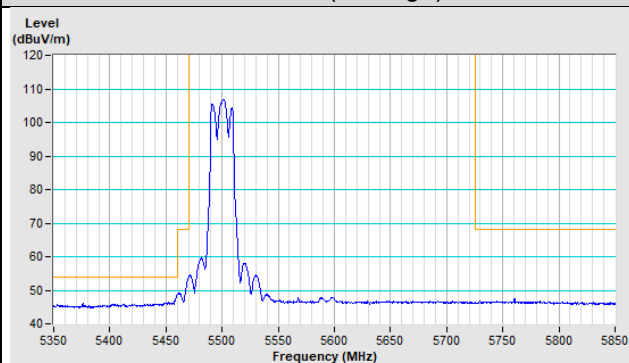

Vertical (Peak)

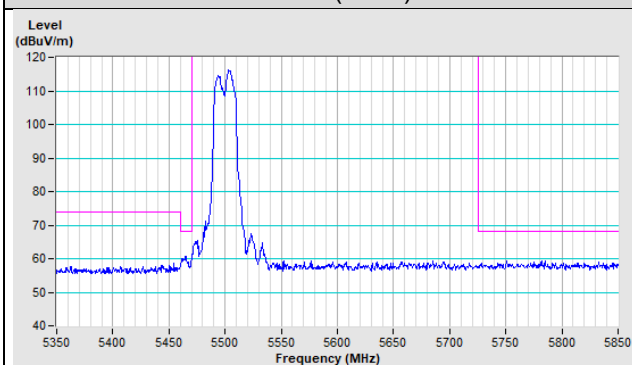

Vertical (Average)

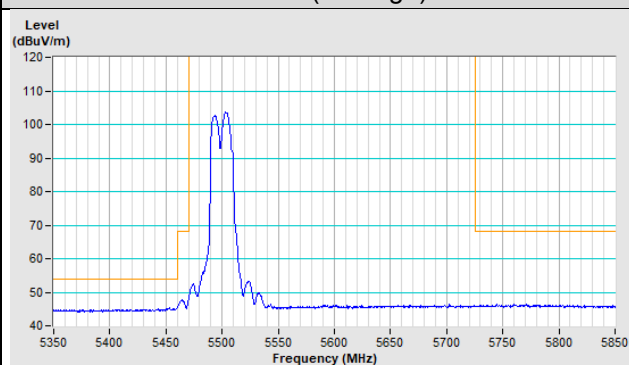

802.11ax (HE20) Channel 140

Horizontal (Peak)

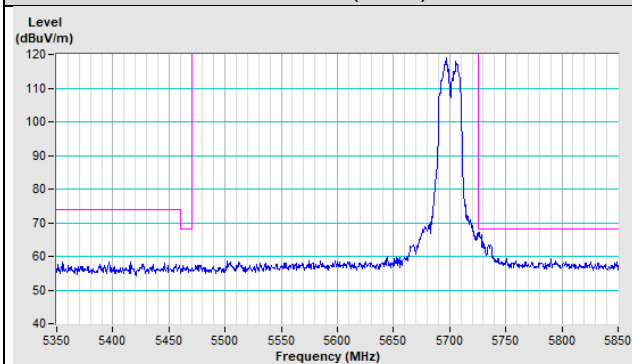

Vertical (Peak)

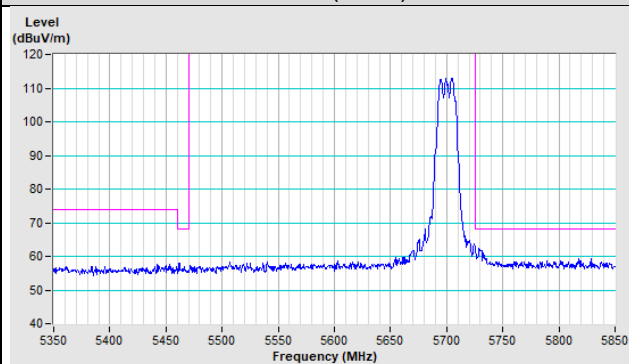

802.11ax (HE20) Channel 144

Horizontal (Peak)

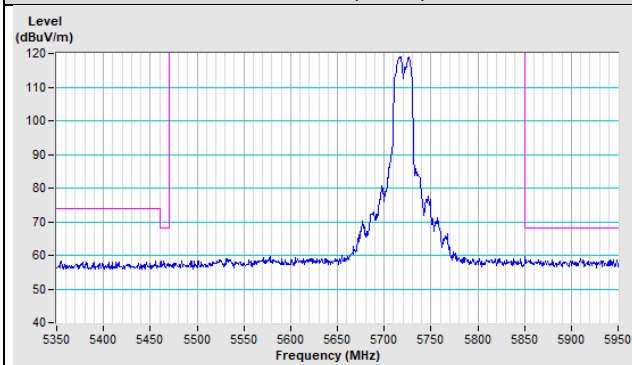

Vertical (Peak)

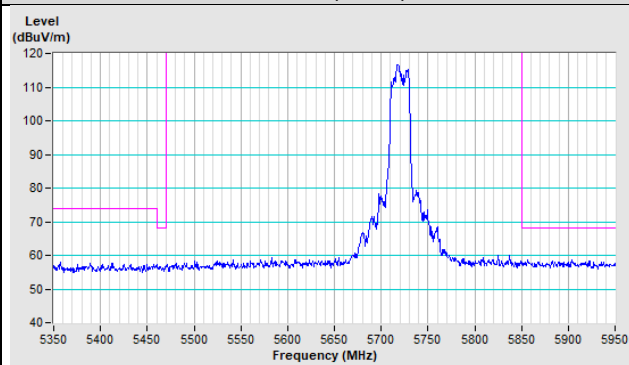

802.11ax (HE40) Channel 54

Horizontal (Peak)

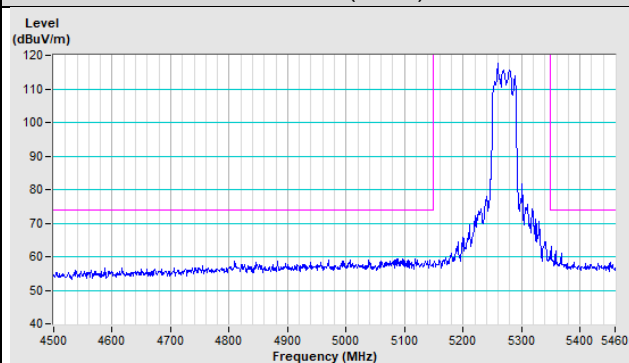

Horizontal (Average)

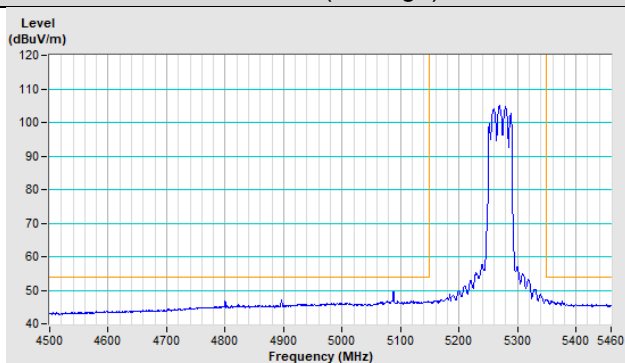

Vertical (Peak)

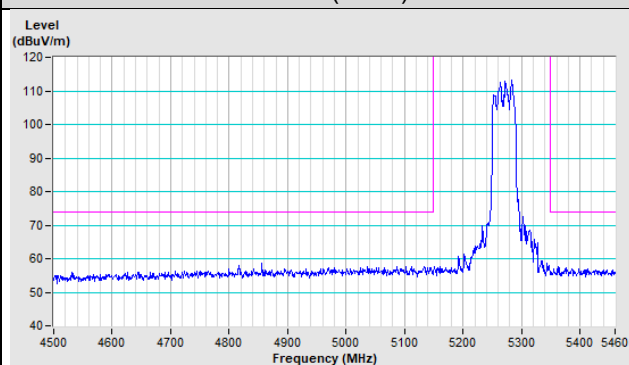

Vertical (Average)

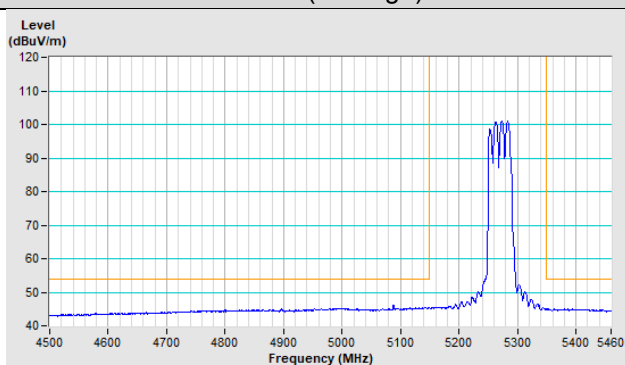

802.11ax (HE40) Channel 62

Horizontal (Peak)

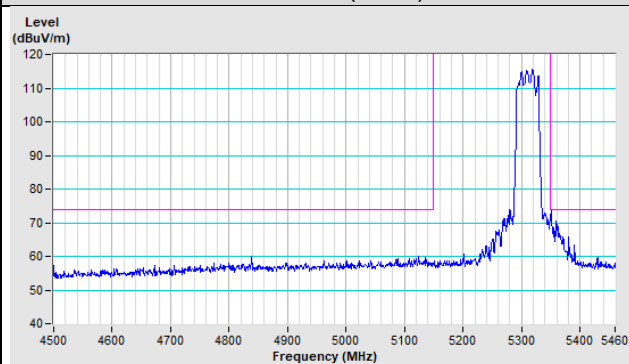

Horizontal (Average)

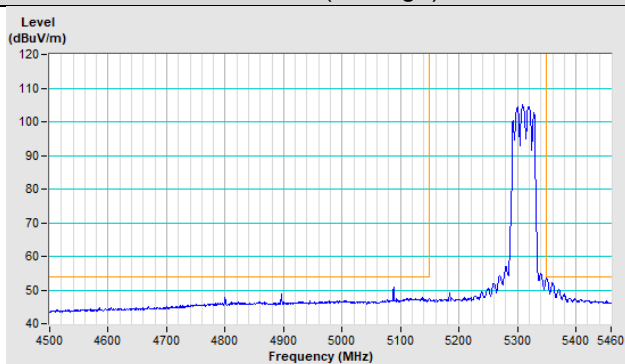

Vertical (Peak)

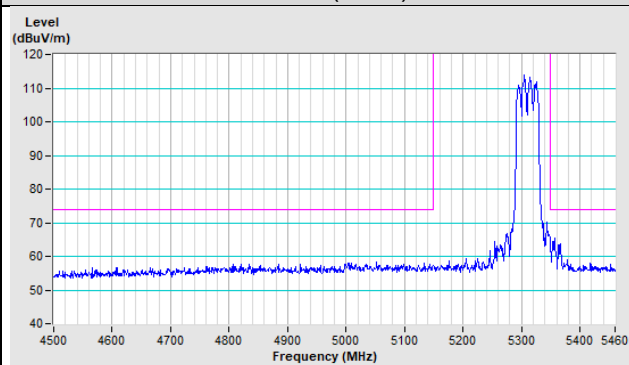

Vertical (Average)

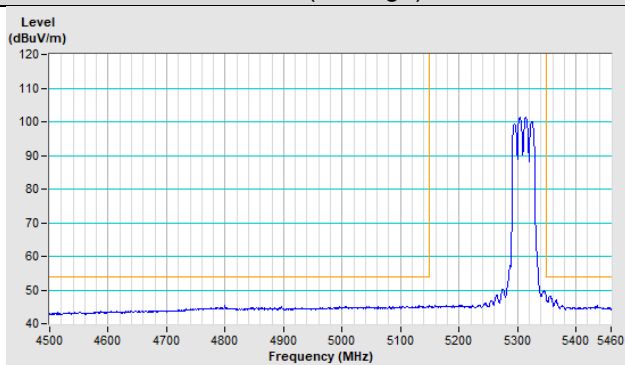

802.11ax (HE40) Channel 102

Horizontal (Peak)

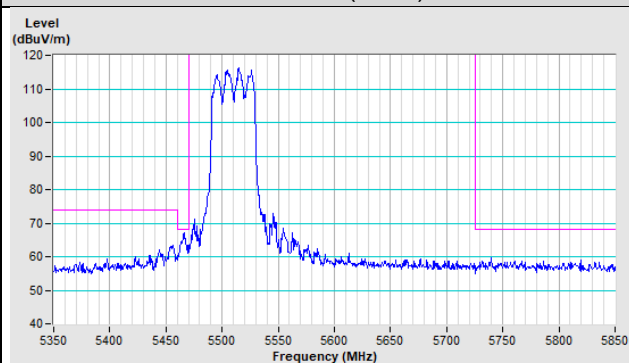

Horizontal (Average)

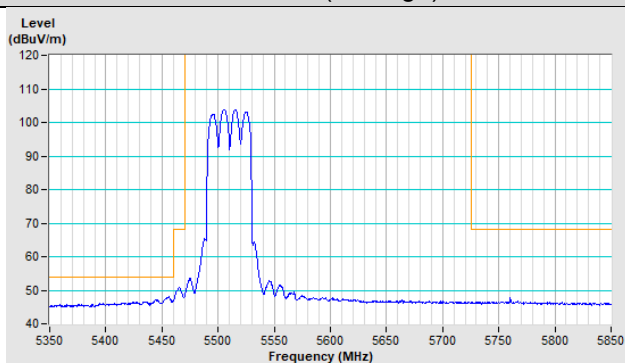

Vertical (Peak)

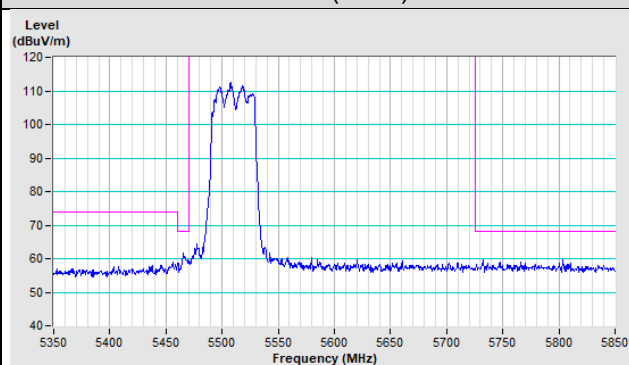

Vertical (Average)

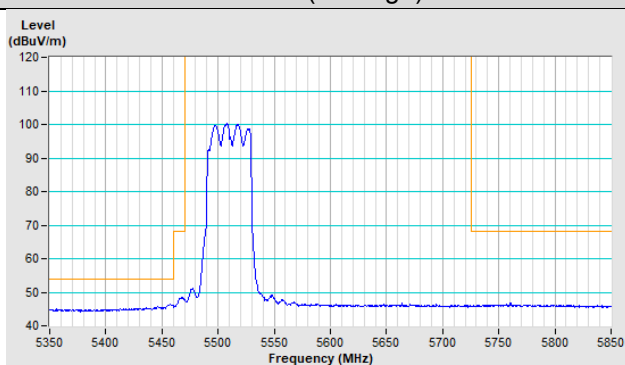

802.11ax (HE40) Channel 134

Horizontal (Peak)

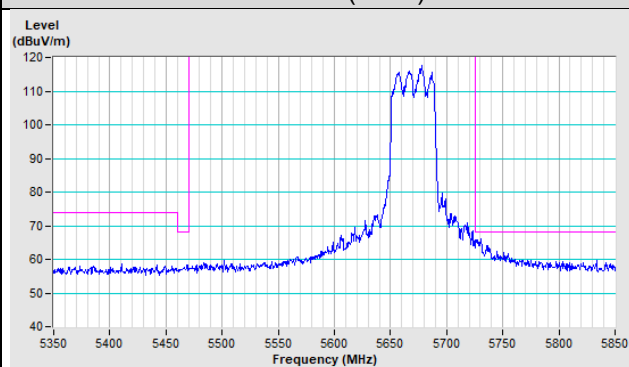

Vertical (Peak)

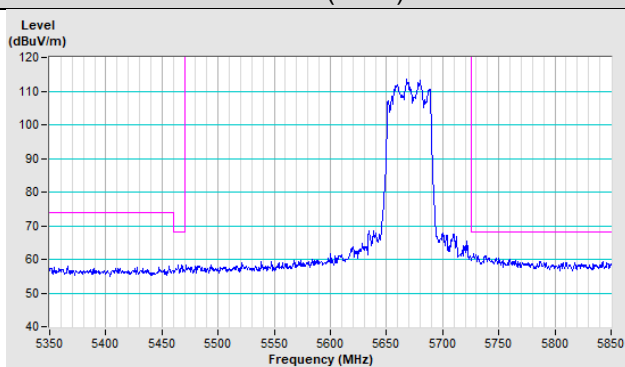

802.11ax (HE40) Channel 142

Horizontal (Peak)

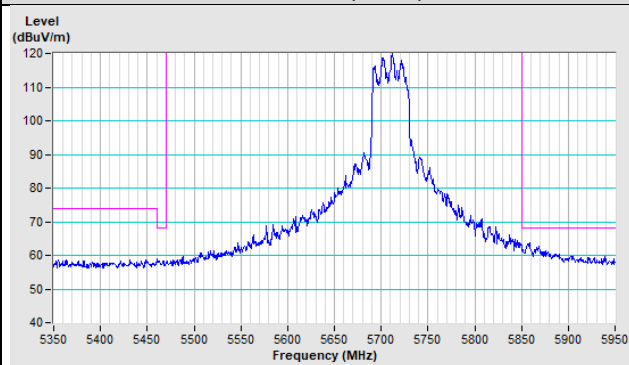

Vertical (Peak)

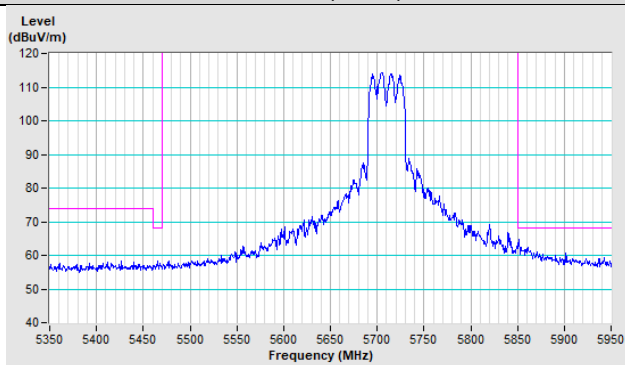

802.11ax (HE80) Channel 58

Horizontal (Peak)

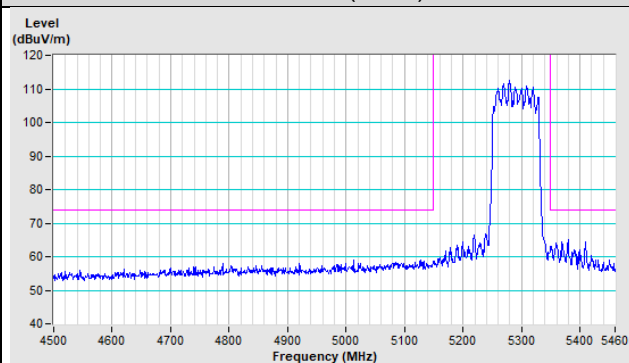

Horizontal (Average)

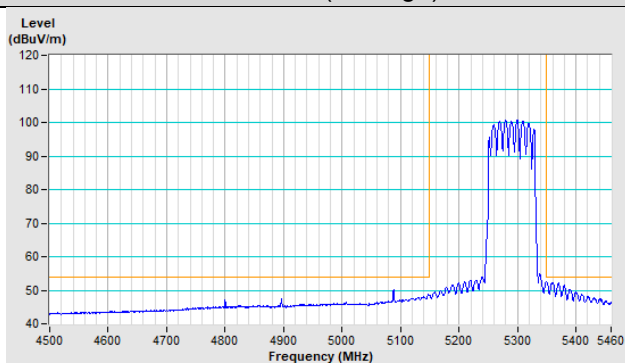

Vertical (Peak)

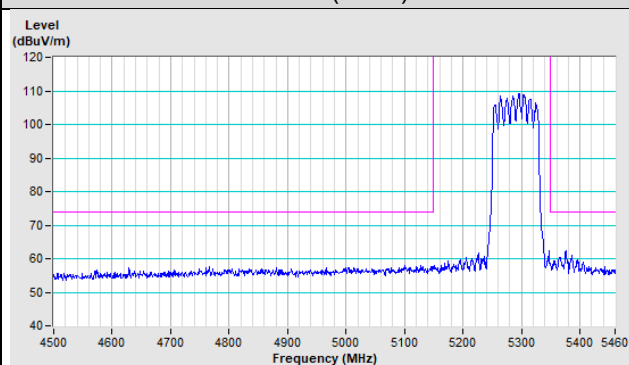

Vertical (Average)

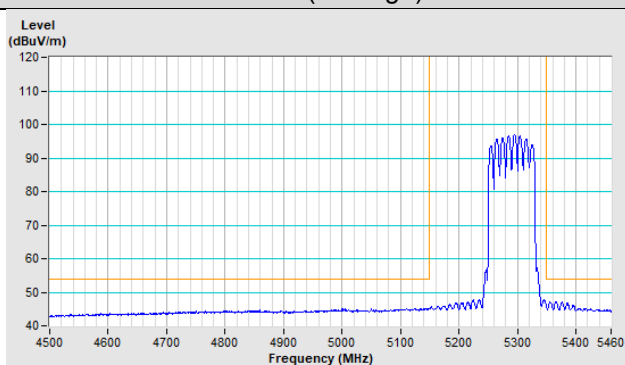

802.11ax (HE80) Channel 106

Horizontal (Peak)

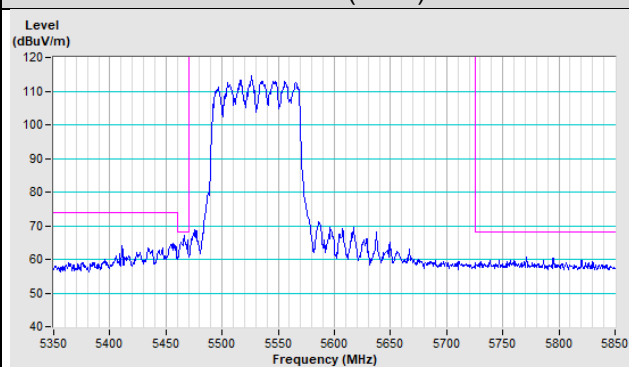

Horizontal (Average)

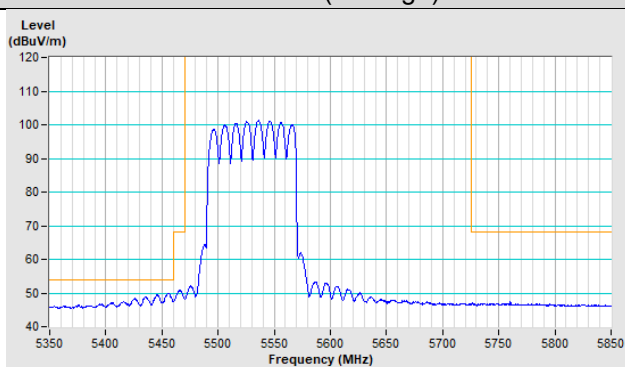

Vertical (Peak)

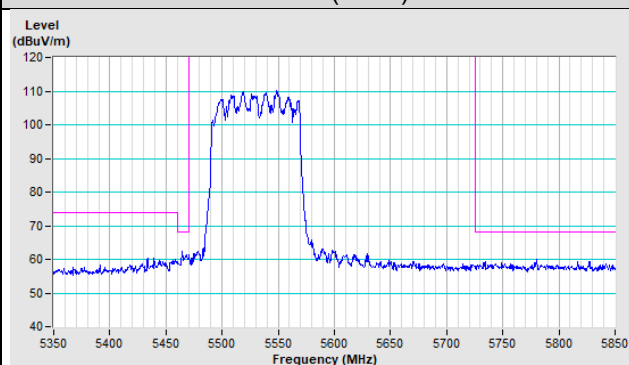

Vertical (Average)

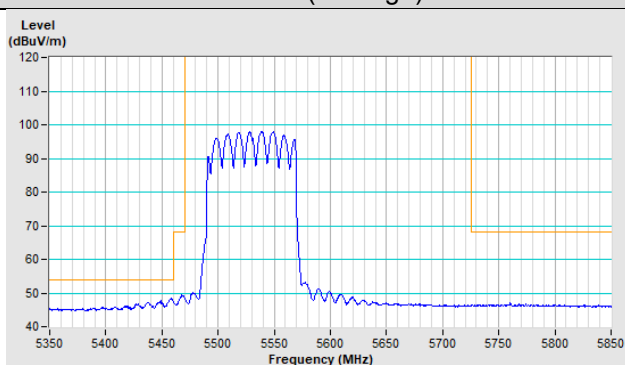

802.11ax (HE80) Channel 122

Horizontal (Peak)

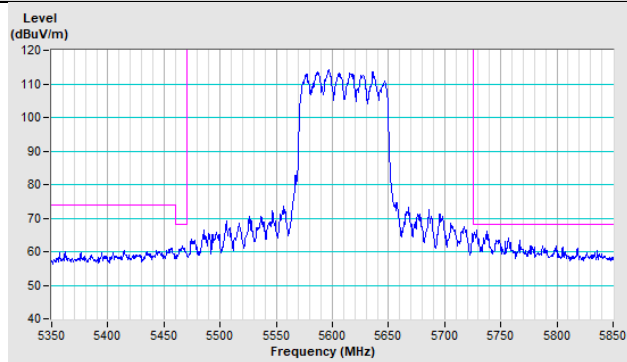

Vertical (Peak)

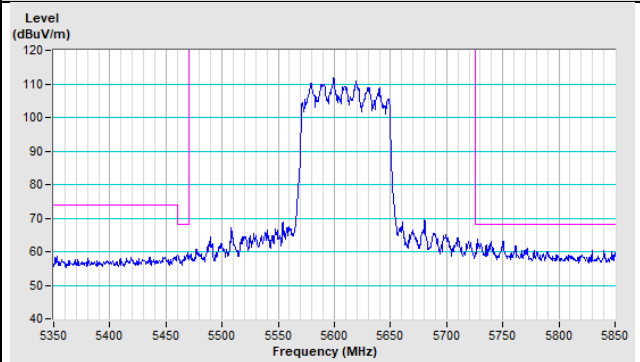

802.11ax (HE80) Channel 138

Horizontal (Peak)

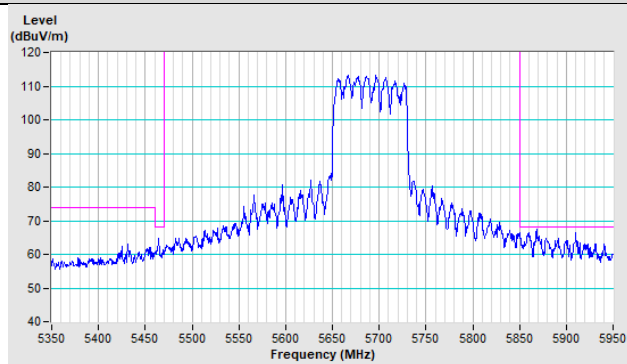

Vertical (Peak)

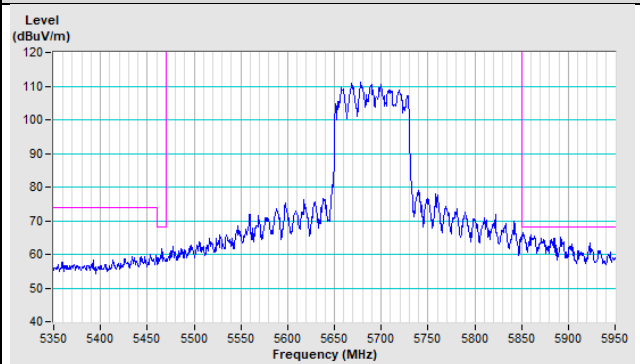

Appendix – Information of the Testing Laboratories

We, Bureau Veritas Consumer Products Services (H.K.) Ltd., Taoyuan Branch, were founded in 1988 to provide our best service in EMC, Radio, Telecom and Safety consultation. Our laboratories are FCC recognized accredited test firms and accredited and approved according to ISO/IEC 17025.

If you have any comments, please feel free to contact us at the following:

Lin Kou EMC/RF Lab

Tel: 886-2-26052180

Fax: 886-2-26051924

Hsin Chu EMC/RF/Telecom Lab

Tel: 886-3-6668565

Fax: 886-3-6668323

Hwa Ya EMC/RF/Safety Lab

Tel: 886-3-3183232

Fax: 886-3-3270892

Email: service.adt@tw.bureauveritas.com

Web Site: www.bureauveritas-adt.com

The address and road map of all our labs can be found in our web site also.

--- END ---