

FCC Test Report

Report No.: RF191209C26B R1

FCC ID: 2AKCZ-0F8

Test Model: APL62-0F8

Received Date: Dec. 09, 2019

Test Date: Jan. 07 ~ Apr. 20, 2020
Feb. 10, 2023

Issued Date: May 18, 2023

Applicant: SonicWall Inc.

Address: 1033 McCarthy Blvd., Milpitas, CA 95035, USA

Issued By: Bureau Veritas Consumer Products Services (H.K.) Ltd., Taoyuan Branch
Lin Kou Laboratories

Lab Address: No. 47-2, 14th Ling, Chia Pau Vil., Lin Kou Dist., New Taipei City, Taiwan

Test Location: No. 19, Hwa Ya 2nd Rd., Wen Hwa Vil., Kwei Shan Dist., Taoyuan City
33383, Taiwan

**FCC Registration /
Designation Number:** 788550 / TW0003



This report is governed by, and incorporates by reference, the Conditions of Testing as posted at the date of issuance of this report at <http://www.bureauveritas.com/home/about-us/our-business/cps/about-us/terms-conditions/> and is intended for your exclusive use. Any copying or replication of this report to or for any other person or entity, or use of our name or trademark, is permitted only with our prior written permission. This report sets forth our findings solely with respect to the test samples identified herein. The results set forth in this report are not indicative or representative of the quality or characteristics of the lot from which a test sample was taken or any similar or identical product unless specifically and expressly noted. Our report includes all of the tests requested by you and the results thereof based upon the information that you provided to us. Measurement uncertainty is only provided upon request for accredited tests. Statements of conformity are based on simple acceptance criteria without taking measurement uncertainty into account, unless otherwise requested in writing. You have 60 days from date of issuance of this report to notify us of any material error or omission caused by our negligence or if you require measurement uncertainty; provided, however, that such notice shall be in writing and shall specifically address the issue you wish to raise. A failure to raise such issue within the prescribed time shall constitute your unqualified acceptance of the completeness of this report, the tests conducted and the correctness of the report contents.

Table of Contents

Release Control Record	4
1 Certificate of Conformity	5
2 Summary of Test Results	6
2.1 Measurement Uncertainty.....	6
2.2 Modification Record.....	6
3 General Information	7
3.1 General Description of EUT.....	7
3.2 Description of Test Modes.....	10
3.2.1 Test Mode Applicability and Tested Channel Detail.....	11
3.3 Duty Cycle of Test Signal.....	13
3.4 Description of Support Units.....	14
3.4.1 Configuration of System under Test.....	14
3.5 General Description of Applied Standards and References.....	15
4 Test Types and Results	16
4.1 Radiated Emission and Bandedge Measurement.....	16
4.1.1 Limits of Radiated Emission and Bandedge Measurement.....	16
4.1.2 Test Instruments.....	17
4.1.3 Test Procedures.....	19
4.1.4 Deviation from Test Standard.....	20
4.1.5 Test Set Up.....	20
4.1.6 EUT Operating Conditions.....	21
4.1.7 Test Results.....	22
4.2 Conducted Emission Measurement.....	44
4.2.1 Limits of Conducted Emission Measurement.....	44
4.2.2 Test Instruments.....	44
4.2.3 Test Procedures.....	45
4.2.4 Deviation from Test Standard.....	45
4.2.5 Test Setup.....	45
4.2.6 EUT Operating Conditions.....	45
4.2.7 Test Results.....	46
4.3 Transmit Power Measurement.....	48
4.3.1 Limits of Transmit Power Measurement.....	48
4.3.2 Test Setup.....	48
4.3.3 Test Instruments.....	49
4.3.4 Test Procedure.....	49
4.3.5 Deviation from Test Standard.....	49
4.3.6 EUT Operating Conditions.....	49
4.3.7 Test Result.....	50
4.4 Occupied Bandwidth Measurement.....	60
4.4.1 Test Setup.....	60
4.4.2 Test Instruments.....	60
4.4.3 Test Procedure.....	60
4.4.4 Test Result.....	61
4.5 Peak Power Spectral Density Measurement.....	63
4.5.1 Limits of Peak Power Spectral Density Measurement.....	63
4.5.2 Test Setup.....	63
4.5.3 Test Instruments.....	63
4.5.4 Test Procedures.....	64
4.5.5 Deviation from Test Standard.....	64
4.5.6 EUT Operating Conditions.....	64
4.5.7 Test Results.....	65
4.6 Frequency Stability.....	68
4.6.1 Limits of Frequency Stability Measurement.....	68

4.6.2 Test Setup.....	68
4.6.3 Test Instruments	68
4.6.4 Test Procedure	68
4.6.5 Deviation from Test Standard	69
4.6.6 EUT Operating Condition	69
4.6.7 Test Results	69
5 Pictures of Test Arrangements.....	70
Annex A- Band Edge Measurement.....	71
Appendix – Information of the Testing Laboratories	75

Release Control Record

Issue No.	Description	Date Issued
RF191209C26B	Original release.	Mar. 17, 2023
RF191209C26B R1	Update reference report no. RF191209C26-1 to RF191209C26-1 R1 on page 7.	May 18, 2023

1 Certificate of Conformity

Product: Wireless Network Security Appliance

Brand: SONICWALL

Test Model: APL62-0F8

Sample Status: Engineering sample

Applicant: SonicWall Inc.

Test Date: Jan. 07 ~ Apr. 20, 2020
Feb. 10, 2023

Standards: 47 CFR FCC Part 15, Subpart E (Section 15.407)
ANSI C63.10-2013

The above equipment has been tested by **Bureau Veritas Consumer Products Services (H.K.) Ltd., Taoyuan Branch**, and found compliance with the requirement of the above standards. The test record, data evaluation & Equipment Under Test (EUT) configurations represented herein are true and accurate accounts of the measurements of the sample's RF characteristics under the conditions specified in this report.

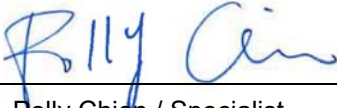
Prepared by :  , **Date:** May 18, 2023
Polly Chien / Specialist

Approved by :  , **Date:** May 18, 2023
Jeremy Lin / Project Engineer

2 Summary of Test Results

47 CFR FCC Part 15, Subpart E (Section 15.407)			
FCC Clause	Test Item	Result	Remarks
15.407(b)(8)	AC Power Conducted Emissions	Pass	Meet the requirement of limit. Minimum passing margin is -9.89dB at 12.96600MHz.
15.407(b)(1/2/3/4(i/ii)/8)	Radiated Emissions & Band Edge Measurement	Pass	Meet the requirement of limit. Minimum passing margin is -1.0dB at 5725.00MHz.
15.407(a)(1/2/3)	Max Average Transmit Power	Pass	Meet the requirement of limit.
---	Occupied Bandwidth Measurement	Pass	Meet the requirement of limit.
15.407(a)(1/2/3)	Peak Power Spectral Density	Pass	Meet the requirement of limit. (U-NII-3 Band only)
15.407(e)	6dB bandwidth	Pass	Meet the requirement of limit.
15.407(g)	Frequency Stability	Pass	Meet the requirement of limit.
15.203	Antenna Requirement	Pass	Antenna connector is RP-SMA not a standard connector.

Note:

- Determining compliance based on the results of the compliance measurement, not taking into account measurement instrumentation uncertainty.
- For U-NII-2A, U-NII-2C band compliance with rule 15.407(b) of the band-edge items, the test plots were recorded in Annex A. Test Procedures refer to report 4.1.3.

2.1 Measurement Uncertainty

Where relevant, the following measurement uncertainty levels have been estimated for tests performed on the EUT as specified in CISPR 16-4-2:

Measurement	Frequency	Expanded Uncertainty (k=2) (±)
Conducted Emissions at mains ports	150kHz ~ 30MHz	2.79 dB
Radiated Emissions up to 1 GHz	9kHz ~ 30MHz	3.04 dB
	30MHz ~ 200MHz	3.86 dB
	200MHz ~ 1000MHz	3.87 dB
Radiated Emissions above 1 GHz	1GHz ~ 18GHz	2.29 dB
	18GHz ~ 40GHz	2.29 dB

2.2 Modification Record

There were no modifications required for compliance.

3 General Information

3.1 General Description of EUT

Product	Wireless Network Security Appliance
Brand	SONICWALL
Test Model	APL62-0F8
Sample Status	Engineering sample
Power Supply Rating	12Vdc from Adapter
Modulation Type	256QAM, 64QAM, 16QAM, QPSK, BPSK
Modulation Technology	OFDM
Transfer Rate	802.11a: 54/48/36/24/18/12/9/6Mbps 802.11n: up to 300Mbps 802.11ac: up to 867Mbps
Operating Frequency	5260~5320MHz, 5500~5700MHz
Number of Channel	5260~5320MHz: 802.11a, 802.11n (HT20), 802.11ac (VHT20): 4 802.11n (HT40), 802.11ac (VHT40): 2 802.11ac (VHT80): 1 5500~5700MHz: 802.11a, 802.11n (HT20), 802.11ac (VHT20): 11 802.11n (HT40), 802.11ac (VHT40): 5 802.11ac (VHT80): 2
Output Power	CDD Mode: 5260~5320MHz: 203.495mW 5500~5700MHz: 191.313mW Beamforming Mode: 5260~5320MHz: 127.510mW 5500~5700MHz: 120.305mW
Antenna Type	Refer to note
Antenna Connector	Refer to note
Accessory Device	Adapter
Cable Supplied	0.91m AC power non-shielded cable without core 1.15m non-shielded console cable without core 0.95m shielded USB cable without core 0.95m non-shielded RJ45 cable without core

Note:

1. This report is prepared for FCC class II permissive change. This report is a supplementary report to the original BV CPS report no.: RF191209C26-1 R1. Difference compared with the original report is adding 5260~5320MHz and 5500~5700MHz band. Therefore, the EUT was re-tested and presented in the test report.

2. The EUT incorporates a MIMO function. Physically, the EUT provides 2 completed transmitters and 2 receivers.

Modulation Mode	TX Function	Beamforming Mode
802.11a	2TX	Not Support
802.11n (HT20)	2TX	Support
802.11n (HT40)	2TX	Support
802.11ac (VHT20)	2TX	Support
802.11ac (VHT40)	2TX	Support
802.11ac (VHT80)	2TX	Support

* The modulation and bandwidth are similar for 802.11n mode for 20MHz/40MHz and 802.11ac mode for 20MHz/40MHz, therefore investigated worst case to representative mode in test report. (Final test mode refer section 3.2.1)

* For 802.11n and 802.11ac, CDD mode and Beamforming mode are presented in power output test item. For other test items, CDD mode is the worst case for final tests after pretesting.

3. The EUT consumes power from the following adapters.

Adapter 1	
Brand	Sunny COMPUTER TECHNOLOGY CO., LTD.
Model	SYS1548-6012-T3
Input Power	100-240Vac, 50-60Hz, 1.5A MAX
Output Power	12Vdc, 5.0A, 60W MAX
Power Line	1.85m DC power cable with 1 core attached on adapter

Adapter 2	
Brand	BILLION
Model	BA070-120500MAX
Input Power	100-240Vac, 50/60Hz, 1.5A
Output Power	12Vdc, 5.0A
Power Line	1.47m power cable with 1 core attached on adapter

* After the pretesting, the adapter 1 was chosen for final tests.

4. The EUT uses following antennas.

Ant. Type	Dipole					
Ant. Connector	RP-SMA					
Frequency (MHz)	2400	2450	2500	5150	5550	5850
Peak Gain (dBi)	3.19	3.10	3.05	5.85	5.73	5.03

*The max. gain was chosen for final tests.

*Detail antenna specification please refer to antenna datasheet and/an antenna gain measurement report.

5. The power settings are list as below.

CDD Mode	802.11a	802.11n (HT20)		802.11n (HT40)		802.11ac (VHT80)
CH 52	42	44	CH 54	44	CH 58	34
CH 60	42	45	CH 62	37	CH 106	32
CH 64	42	42	CH 102	36	CH 122	34
CH 100	42	41	CH 110	44		
CH 116	42	44	CH 134	35		
CH 140	34	35				

Beamforming Mode	802.11n (HT20)		802.11n (HT40)		802.11ac (VHT80)
CH 52	44	CH 54	44	CH 58	34
CH 60	45	CH 62	37	CH 106	32
CH 64	42	CH 102	36	CH 122	34
CH 100	41	CH 110	44		
CH 116	44	CH 134	35		
CH 140	35				

6. WLAN 2.4GHz & WLAN 5GHz technology cannot transmit at same time.

7. Spurious emission of the simultaneous operation (2.4GHz and 5GHz) has been evaluated and no non-compliance was found.

3.2 Description of Test Modes

5260~5320MHz:

4 channels are provided for 802.11a, 802.11n (HT20), 802.11ac (VHT20):

Channel	Frequency	Channel	Frequency
52	5260 MHz	60	5300 MHz
56	5280 MHz	64	5320 MHz

2 channels are provided for 802.11n (HT40), 802.11ac (VHT40):

Channel	Frequency	Channel	Frequency
54	5270 MHz	62	5310 MHz

1 channel is provided for 802.11ac (VHT80):

Channel	Frequency
58	5290MHz

5500~5700MHz:

11 channels are provided for 802.11a, 802.11n (HT20), 802.11ac (VHT20):

Channel	Frequency	Channel	Frequency
100	5500 MHz	124	5620 MHz
104	5520 MHz	128	5640 MHz
108	5540 MHz	132	5660 MHz
112	5560 MHz	136	5680 MHz
116	5580 MHz	140	5700 MHz
120	5600 MHz		

5 channels are provided for 802.11n (HT40), 802.11ac (VHT40):

Channel	Frequency	Channel	Frequency
102	5510 MHz	126	5630 MHz
110	5550 MHz	134	5670 MHz
118	5590 MHz		

2 channels are provided for 802.11ac (VHT80):

Channel	Frequency	Channel	Frequency
106	5530 MHz	122	5610 MHz

3.2.1 Test Mode Applicability and Tested Channel Detail

EUT Configure Mode	Applicable to				Description
	RE \geq 1G	RE<1G	PLC	APCM	Power
-	√	√	√	√	-

Where RE \geq 1G: Radiated Emission above 1GHz & Bandedge Measurement
 RE<1G: Radiated Emission below 1GHz
 PLC: Power Line Conducted Emission
 APCM: Antenna Port Conducted Measurement

Note:

1. The EUT had been pre-tested on the positioned of each 3 axis. The worst case was found when positioned on **Z-plane**.
2. Radiated emission test (below 1GHz) and power line conducted emission test items chosen the worst maximum power.

Radiated Emission Test (Above 1GHz):

- Pre-Scan has been conducted to determine the worst-case mode from all possible combinations between available modulations, data rates and antenna ports (if EUT with antenna diversity architecture).
- Following channel(s) was (were) selected for the final test as listed below.

EUT Configure Mode	Mode	Frequency Band (MHz)	Available Channel	Tested Channel	Modulation Technology	Data Rate (Mbps)
-	802.11a	5260-5320	52 to 64	52, 60, 64	OFDM	6.0
	802.11n (HT20)		52 to 64	52, 60, 64	OFDM	6.5
	802.11n (HT40)		54 to 62	54, 62	OFDM	13.5
	802.11ac (VHT80)		58	58	OFDM	58.5
-	802.11a	5500-5700	100 to 140	100, 116, 140	OFDM	6.0
	802.11n (HT20)		100 to 140	100, 116, 140	OFDM	6.5
	802.11n (HT40)		102 to 134	102, 110, 134	OFDM	13.5
	802.11ac (VHT80)		106, 122	106, 122	OFDM	58.5

Radiated Emission Test (Below 1GHz):

- Pre-Scan has been conducted to determine the worst-case mode from all possible combinations between available modulations, data rates and antenna ports (if EUT with antenna diversity architecture).
- Following channel(s) was (were) selected for the final test as listed below.

EUT Configure Mode	Mode	Frequency Band (MHz)	Available Channel	Tested Channel	Modulation Technology	Data Rate (Mbps)
-	802.11n (HT40)	54 to 62	54	54	OFDM	6.0

Power Line Conducted Emission Test:

- Pre-Scan has been conducted to determine the worst-case mode from all possible combinations between available modulations, data rates and antenna ports (if EUT with antenna diversity architecture).
- Following channel(s) was (were) selected for the final test as listed below.

EUT Configure Mode	Mode	Frequency Band (MHz)	Available Channel	Tested Channel	Modulation Technology	Data Rate (Mbps)
-	802.11n (HT40)	54 to 62	54	54	OFDM	6.0

Antenna Port Conducted Measurement:

- This item includes all test value of each mode, but only includes spectrum plot of worst value of each mode.
- Pre-Scan has been conducted to determine the worst-case mode from all possible combinations between available modulations, data rates and antenna ports (if EUT with antenna diversity architecture).
- Following channel(s) was (were) selected for the final test as listed below.

EUT Configure Mode	Mode	Frequency Band (MHz)	Available Channel	Tested Channel	Modulation Technology	Data Rate (Mbps)
-	802.11a	5260-5320	52 to 64	52, 60, 64	OFDM	6.0
	802.11n (HT20)		52 to 64	52, 60, 64	OFDM	6.5
	802.11n (HT40)		54 to 62	54, 62	OFDM	13.5
	802.11ac (VHT80)		58	58	OFDM	58.5
-	802.11a	5500-5700	100 to 140	100, 116, 140	OFDM	6.0
	802.11n (HT20)		100 to 140	100, 116, 140	OFDM	6.5
	802.11n (HT40)		102 to 134	102, 110, 134	OFDM	13.5
	802.11ac (VHT80)		106, 122	106, 122	OFDM	58.5

Test Condition:

Applicable to	Environmental Conditions	Input Power	Tested by
RE _≥ 1G	22 deg. C, 68% RH	120Vac, 60Hz	Greg Lin, Han Wu
RE _{<} 1G	22 deg. C, 68% RH	120Vac, 60Hz	Greg Lin
PLC	25 deg. C, 75% RH	120Vac, 60Hz	Jones Chang
APCM	25 deg. C, 60% RH	120Vac, 60Hz	Jisyong Wang

3.3 Duty Cycle of Test Signal

Duty cycle of test signal is < 98%, duty factor is required.

802.11a: Duty cycle = $2.057/2.134 = 0.964$, Duty factor = $10 * \log(1/0.964) = 0.16$

802.11n (HT20): Duty cycle = $4.988/5.463 = 0.911$, Duty factor = $10 * \log(1/0.911) = 0.40$

802.11n (HT40): Duty cycle = $2.425/2.525 = 0.960$, Duty factor = $10 * \log(1/0.960) = 0.18$

802.11ac (VHT80): Duty cycle = $3.345/3.835 = 0.872$, Duty factor = $10 * \log(1/0.872) = 0.59$

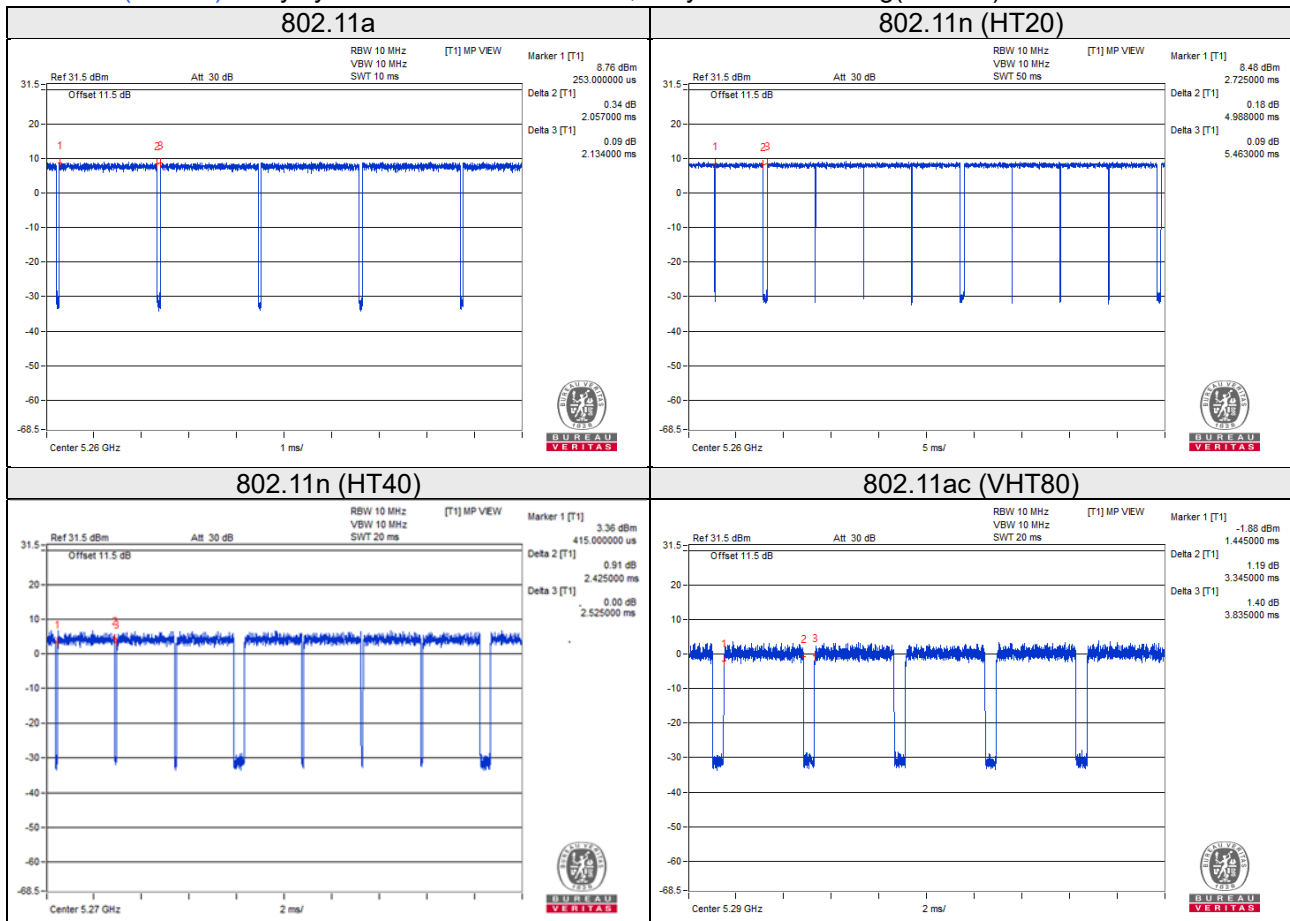

3.4 Description of Support Units

The EUT has been tested as an independent unit together with other necessary accessories or support units. The following support units or accessories were used to form a representative test configuration during the tests.

ID	Product	Brand	Model No.	Serial No.	FCC ID	Remarks
A.	Notebook	DELL	E5410	1HC2XM1	FCC DoC Approved	-
B.	Flash	HP	v250W	09	NA	-
	Flash	HP	v250W	03	NA	-
C.	Load	NA	NA	NA	NA	-

Note:

1. All power cords of the above support units are non-shielded (1.8m).
2. Item A acted as a communication partner to transfer data.

ID	Descriptions	Qty.	Length (m)	Shielding (Yes/No)	Cores (Qty.)	Remarks
1.	Console cable	1	1.15	N	0	Accessory of EUT
2.	USB cable	1	0.95	Y	0	Accessory of EUT
3.	LAN cable	1	0.95	N	0	Accessory of EUT RJ45, Cat5e
4.	Power cord	2	0.91	N	0	Accessory of EUT
5.	LAN cable	1	7	N	0	RJ45, Cat5e
6.	LAN cable	7	1.5	N	0	RJ45, Cat5e
7.	Fiber cable	1	3	N	0	Provided by client

3.4.1 Configuration of System under Test

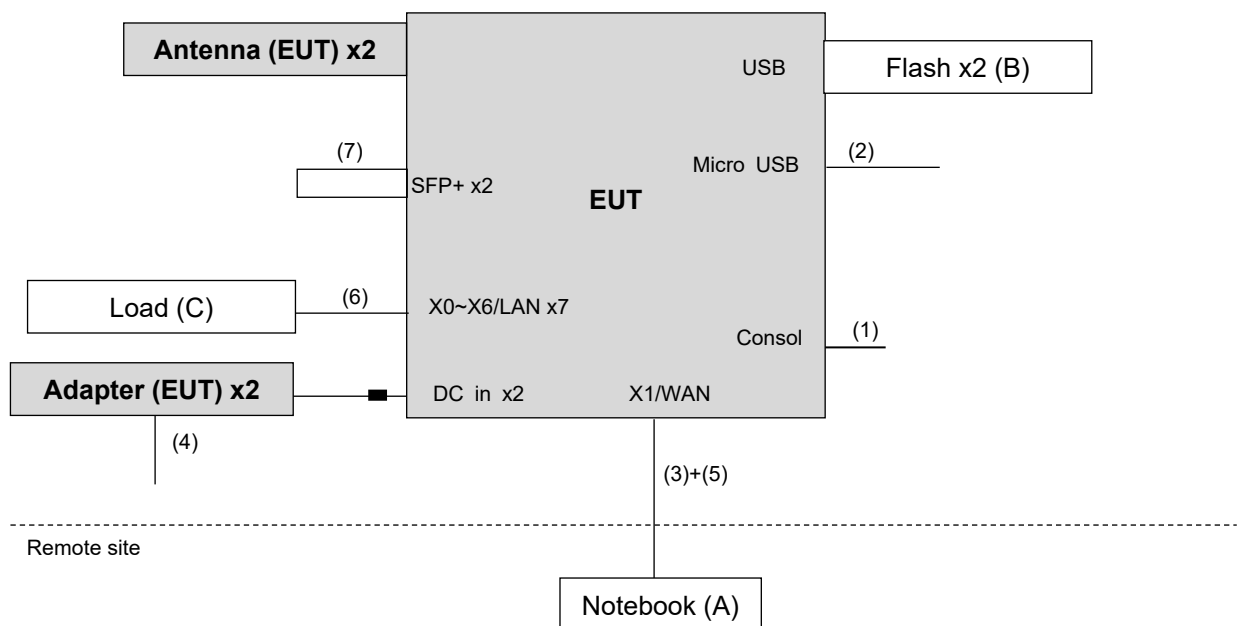

3.5 General Description of Applied Standards and References

The EUT is a RF Product. According to the specifications of the manufacturer, it must comply with the requirements of the following standards and references:

FCC Part 15, Subpart E (15.407)

ANSI C63.10-2013

All test items have been performed and recorded as per the above standards.

References Test Guidance:

KDB 789033 D02 General UNII Test Procedure New Rules v02r01

KDB 662911 D01 Multiple Transmitter Output v02r01

All test items have been performed as a reference to the above KDB test guidance

4 Test Types and Results

4.1 Radiated Emission and Bandedge Measurement

4.1.1 Limits of Radiated Emission and Bandedge Measurement

Radiated emissions which fall in the restricted bands must comply with the radiated emission limits specified as below table.

Frequencies (MHz)	Field Strength (microvolts/meter)	Measurement Distance (meters)
0.009 ~ 0.490	2400/F(kHz)	300
0.490 ~ 1.705	24000/F(kHz)	30
1.705 ~ 30.0	30	30
30 ~ 88	100	3
88 ~ 216	150	3
216 ~ 960	200	3
Above 960	500	3

NOTE:

- The lower limit shall apply at the transition frequencies.
- Emission level (dBuV/m) = 20 log Emission level (uV/m).
- For frequencies above 1000MHz, the field strength limits are based on average detector, however, the peak field strength of any emission shall not exceed the maximum permitted average limits, specified above by more than 20dB under any condition of modulation.

Limits of unwanted emission out of the restricted bands

Applicable To		Limit	
789033 D02 General UNII Test Procedure New Rules v02r01		Field Strength at 3m	
		PK: 74 (dBµV/m)	AV: 54 (dBµV/m)
Frequency Band	Applicable To	EIRP Limit	Equivalent Field Strength at 3m
5150~5250 MHz	15.407(b)(1)	PK: -27 (dBm/MHz)	PK: 68.2(dBµV/m)
5250~5350 MHz	15.407(b)(2)		
5470~5725 MHz	15.407(b)(3)		
5725~5850 MHz	<input type="checkbox"/> 15.407(b)(4)(i)	PK: -27 (dBm/MHz) ^{*1} PK: 10 (dBm/MHz) ^{*2} PK: 15.6 (dBm/MHz) ^{*3} PK: 27 (dBm/MHz) ^{*4}	PK: 68.2(dBµV/m) ^{*1} PK: 105.2 (dBµV/m) ^{*2} PK: 110.8(dBµV/m) ^{*3} PK: 122.2 (dBµV/m) ^{*4}
	<input type="checkbox"/> 15.407(b)(4)(ii)	Emission limits in section 15.247(d)	
^{*1} beyond 75 MHz or more above of the band edge. ^{*3} below the band edge increasing linearly to a level of 15.6 dBm/MHz at 5 MHz above.		^{*2} below the band edge increasing linearly to 10 dBm/MHz at 25 MHz above. ^{*4} from 5 MHz above or below the band edge increasing linearly to a level of 27 dBm/MHz at the band edge.	

Note: The following formula is used to convert the equipment isotropic radiated power (eirp) to field strength:

$$E = \frac{1000000 \sqrt{30P}}{3} \mu\text{V/m, where P is the eirp (Watts).}$$

4.1.2 Test Instruments

Description & Manufacturer	Model No.	Serial No.	Date Of Calibration	Due Date Of Calibration
Test Receiver ROHDE & SCHWARZ	ESIB7	100187	May 30, 2019	May 29, 2020
BILOG Antenna SCHWARZBECK	VULB9168	9168-171	Nov. 11, 2019	Nov. 10, 2020
HORN Antenna SCHWARZBECK	9120D	209	Nov. 24, 2019	Nov. 23, 2020
HORN Antenna SCHWARZBECK	BBHA 9170	BBHA9170241	Nov. 24, 2019	Nov. 23, 2020
Loop Antenna TESEQ	HLA 6121	45745	Jul. 01, 2019	Jun. 30, 2020
Preamplifier Agilent (Below 1GHz)	8447D	2944A10738	Aug. 20, 2019	Aug. 19, 2020
Preamplifier Agilent (Above 1GHz)	8449B	3008A02465	Mar. 27, 2019	Mar. 26, 2020
RF Coaxial Cable WOKEN With 5dB PAD	8D-FB	Cable-CH3-01	Aug. 20, 2019	Aug. 19, 2020
RF signal cable HUBER+SUHNER	SUCOFLEX 104	Cable-CH3-03 (223653/4)	Aug. 20, 2019	Aug. 19, 2020
RF signal cable HUBER+SUHNER& EMCI	SUCOFLEX 104&EMC104-SM- SM-8000	Cable-CH3-03 (309224+170907)	Aug. 20, 2019	Aug. 19, 2020
Software BV ADT	ADT_Radiated_ V7.6.15.9.5	NA	NA	NA
Antenna Tower inn-co GmbH	MA 4000	013303	NA	NA
Antenna Tower Controller BV ADT	AT100	AT93021702	NA	NA
Turn Table BV ADT	TT100	TT93021702	NA	NA
Turn Table Controller BV ADT	SC100	SC93021702	NA	NA
Boresight Antenna Fixture	FBA-01	FBA-SIP01	NA	NA
USB Wideband Power Sensor KEYSIGHT	U2021XA	MY55050005/MY55 190004/MY5519000 7/MY55210005	Jul. 15, 2019	Jul. 14, 2020
Pre-amplifier (18GHz-40GHz) EMC	EMC184045B	980175	Sep. 05, 2019	Sep. 04, 2020

- Note: 1. The calibration interval of the above test instruments is 12 months and the calibrations are traceable to NML/ROC and NIST/USA.
 2. The test was performed in HwaYa Chamber 3.
 3. Tested data: Jan. 07 ~ Apr. 20, 2020

Description & Manufacturer	Model No.	Serial No.	Date Of Calibration	Due Date Of Calibration
BILOG Antenna SCHWARZBECK	VULB9168	9168-171	Oct. 26, 2022	Oct. 25, 2023
HORN Antenna SCHWARZBECK	9120D	209	Nov. 13, 2022	Nov. 12, 2023
HORN Antenna SCHWARZBECK	BBHA 9170	BBHA9170241	Oct. 20, 2022	Oct. 19, 2023
Loop Antenna TESEQ	HLA 6121	45745	Jul. 27, 2022	Jun. 26, 2023
Preamplifier Agilent (Below 1GHz)	8447D	2944A10738	Jul. 09, 2022	Jun. 08, 2023
Preamplifier Agilent (Above 1GHz)	8449B	3008A02465	Mar. 19, 2022	Mar. 18, 2023
RF Coaxial Cable WOKEN With 5dB PAD	8D-FB	Cable-CH3-01	May 14, 2022	May 13, 2023
RF signal cable HUBER+SUHNER	SUCOFLEX 104	Cable-CH3-03 (223653/4)	May 14, 2022	May 13, 2023
RF signal cable HUBER+SUHNER& EMCI	SUCOFLEX 104&EMC104-SM- SM-8000	Cable-CH3-03 (309224+170907)	May 14, 2022	May 13, 2023
Software BV ADT	ADT_Radiated_ V7.6.15.9.5	NA	NA	NA
Antenna Tower inn-co GmbH	MA 4000	013303	NA	NA
Antenna Tower Controller BV ADT	AT100	AT93021702	NA	NA
Turn Table BV ADT	TT100	TT93021702	NA	NA
Turn Table Controller BV ADT	SC100	SC93021702	NA	NA
Boresight Antenna Fixture	FBA-01	FBA-SIP01	NA	NA
Pre-amplifier (18GHz-40GHz) EMC	EMC184045B	980175	Sep. 03, 2022	Sep. 02, 2023
Peak Power Analyzer KEYSIGHT	8990B	MY51000485	Jan. 19, 2023	Jan. 18, 2024
Wideband Power Sensor KEYSIGHT	N1923A	MY58190002	May 06, 2022	May 05, 2023

- Note: 1. The calibration interval of the above test instruments is 12 months and the calibrations are traceable to NML/ROC and NIST/USA.
 2. The test was performed in HwaYa Chamber 3.
 3. Tested data: Feb. 10, 2023

4.1.3 Test Procedures

For Radiated emission below 30MHz

- a. The EUT was placed on the top of a rotating table 0.8 meters above the ground at a 3 meter chamber room. The table was rotated 360 degrees to determine the position of the highest radiation.
- b. The EUT was set 3 meters away from the interference-receiving antenna, which was mounted on the top of a variable-height antenna tower.
- c. Parallel, perpendicular, and ground-parallel orientations of the antenna are set to make the measurement.
- d. For each suspected emission, the EUT was arranged to its worst case and the rotatable table was turned from 0 degrees to 360 degrees to find the maximum reading.
- e. The test-receiver system was set to Quasi-Peak Detect Function and Specified Bandwidth with Maximum Hold Mode.

NOTE:

1. The resolution bandwidth and video bandwidth of test receiver/spectrum analyzer is 9kHz at frequency below 30MHz.

For Radiated emission above 30MHz

- a. The EUT was placed on the top of a rotating table 0.8 meters (for 30MHz ~ 1GHz) / 1.5 meters (for above 1GHz) above the ground at 3 meter chamber room for test. The table was rotated 360 degrees to determine the position of the highest radiation.
- b. The EUT was set 3 meters away from the interference-receiving antenna, which was mounted on the top of a variable-height antenna tower.
- c. The height of antenna is varied from one meter to four meters above the ground to determine the maximum value of the field strength. Both horizontal and vertical polarizations of the antenna are set to make the measurement.
- d. For each suspected emission, the EUT was arranged to its worst case and then the antenna was tuned to heights from 1 meter to 4 meters and the rotatable table was turned from 0 degrees to 360 degrees to find the maximum reading.
- e. The test-receiver system was set to quasi-peak detect function and specified bandwidth with maximum hold mode when the test frequency is below 1 GHz.
- f. The test-receiver system was set to peak and average detect function and specified bandwidth with maximum hold mode when the test frequency is above 1 GHz. If the peak reading value also meets average limit, measurement with the average detector is unnecessary.

Note:

1. The resolution bandwidth and video bandwidth of test receiver/spectrum analyzer is 120kHz for Quasi-peak detection (QP) at frequency below 1GHz.
2. The resolution bandwidth of test receiver/spectrum analyzer is 1 MHz and the video bandwidth is 3 MHz for Peak detection (PK) at frequency above 1GHz.
3. The resolution bandwidth of test receiver/spectrum analyzer is 1 MHz and the video bandwidth is $\geq 1/T$ (Duty cycle < 98%) or 10Hz RBW (Duty cycle $\geq 98\%$) for Average detection (AV) at frequency above 1GHz.

(802.11a: RBW = 1MHz, VBW = 1kHz; 802.11n (HT20): RBW = 1MHz, VBW = 1kHz; 802.11n (HT40): RBW = 1MHz, VBW = 1kHz; 802.11ac (VHT80): RBW = 1MHz, VBW = 1kHz)

4. All modes of operation were investigated and the worst-case emissions are reported.

4.1.4 Deviation from Test Standard

No deviation.

4.1.5 Test Set Up

For Radiated emission below 30MHz

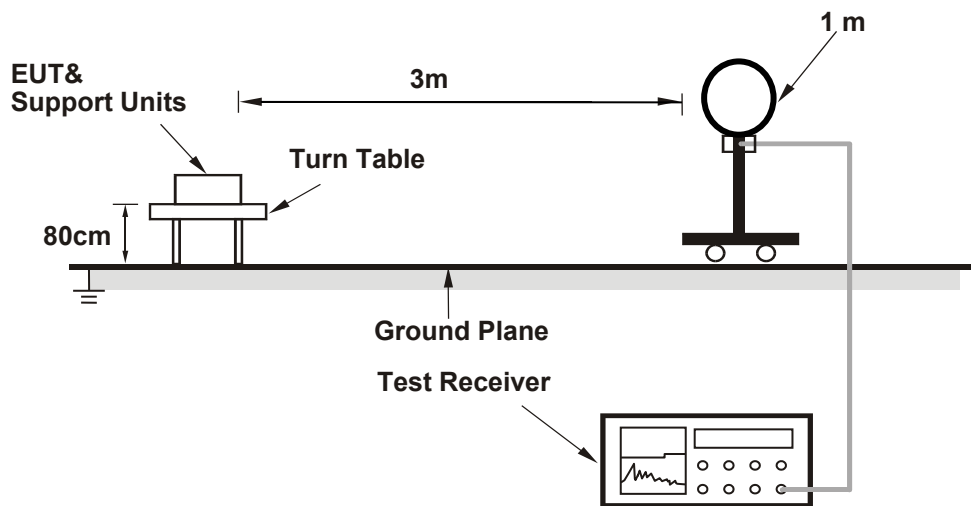

For Radiated emission 30MHz to 1GHz

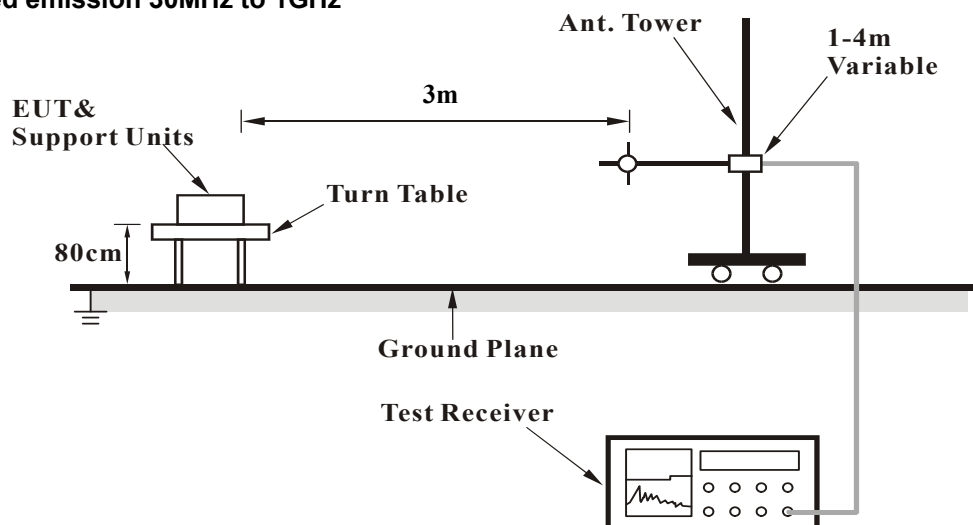

For Radiated emission above 1GHz

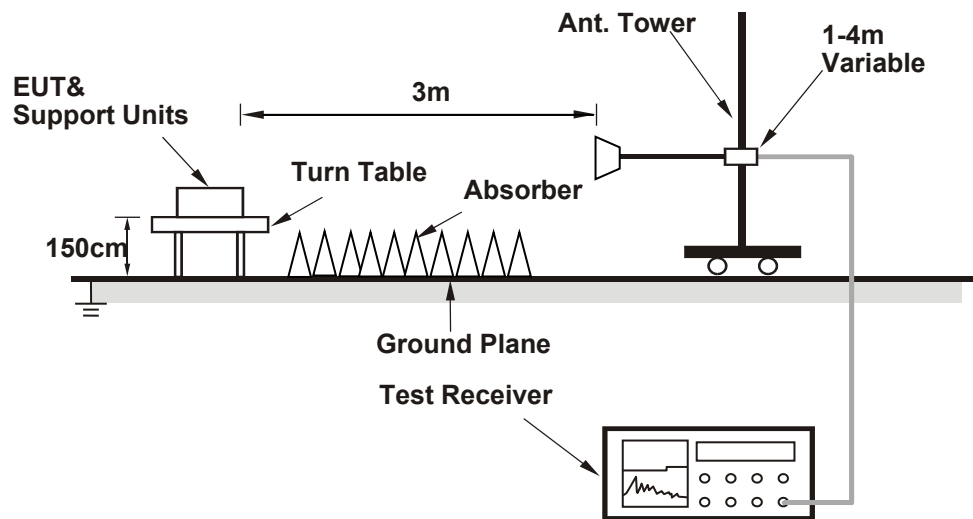

For the actual test configuration, please refer to the attached file (Test Setup Photo).

4.1.6 EUT Operating Conditions

- Placed the EUT on the testing table.
- Prepared a notebook to act as a communication partner and placed it outside of testing area.
- The communication partner connected with EUT via a RJ45 cable and ran a test program (CMD) to enable EUT under transmission condition continuously at specific channel frequency.
- The communication partner sent data to EUT by command "PING".

4.1.7 Test Results

Above 1GHz data:

802.11a

CHANNEL	TX Channel 52	DETECTOR	Peak (PK)
FREQUENCY RANGE	1GHz ~ 40GHz	FUNCTION	Average (AV)

ANTENNA POLARITY & TEST DISTANCE: HORIZONTAL AT 3 M								
NO.	FREQ. (MHz)	EMISSION LEVEL (dBuV/m)	LIMIT (dBuV/m)	MARGIN (dB)	ANTENNA HEIGHT (m)	TABLE ANGLE (Degree)	RAW VALUE (dBuV)	CORRECTION FACTOR (dB/m)
1	5150.00	54.7 PK	74.0	-19.3	3.72 H	347	50.8	3.9
2	5150.00	44.6 AV	54.0	-9.4	3.72 H	347	40.7	3.9
3	*5260.00	118.7 PK			3.80 H	350	80.6	38.1
4	*5260.00	107.9 AV			3.80 H	350	69.8	38.1
5	#10520.00	57.8 PK	68.2	-10.4	1.56 H	103	41.2	16.6
ANTENNA POLARITY & TEST DISTANCE: VERTICAL AT 3 M								
NO.	FREQ. (MHz)	EMISSION LEVEL (dBuV/m)	LIMIT (dBuV/m)	MARGIN (dB)	ANTENNA HEIGHT (m)	TABLE ANGLE (Degree)	RAW VALUE (dBuV)	CORRECTION FACTOR (dB/m)
1	5150.00	54.1 PK	74.0	-19.9	2.92 V	271	50.2	3.9
2	5150.00	43.5 AV	54.0	-10.5	2.92 V	271	39.6	3.9
3	*5260.00	109.8 PK			3.04 V	279	71.7	38.1
4	*5260.00	99.0 AV			3.04 V	279	60.9	38.1
5	#10520.00	57.9 PK	68.2	-10.3	2.97 V	301	41.3	16.6

Remarks:

1. Emission Level(dBuV/m) = Raw Value(dBuV) + Correction Factor(dB/m)
2. Correction Factor(dB/m) = Antenna Factor(dB/m) + Cable Factor(dB) – Pre-Amplifier Factor(dB)
3. The other emission levels were very low against the limit.
4. Margin value = Emission Level – Limit value
5. " * ": Fundamental frequency.
6. " # ": The radiated frequency is out of the restricted band.

CHANNEL	TX Channel 60	DETECTOR FUNCTION	Peak (PK)
FREQUENCY RANGE	1GHz ~ 40GHz		Average (AV)

ANTENNA POLARITY & TEST DISTANCE: HORIZONTAL AT 3 M								
NO.	FREQ. (MHz)	EMISSION LEVEL (dBuV/m)	LIMIT (dBuV/m)	MARGIN (dB)	ANTENNA HEIGHT (m)	TABLE ANGLE (Degree)	RAW VALUE (dBuV)	CORRECTION FACTOR (dB/m)
1	*5300.00	117.9 PK			3.60 H	359	79.8	38.1
2	*5300.00	107.3 AV			3.60 H	359	69.2	38.1
3	10600.00	58.2 PK	74.0	-15.8	1.53 H	102	41.4	16.8
4	10600.00	43.8 AV	54.0	-10.2	1.53 H	102	27.0	16.8
ANTENNA POLARITY & TEST DISTANCE: VERTICAL AT 3 M								
NO.	FREQ. (MHz)	EMISSION LEVEL (dBuV/m)	LIMIT (dBuV/m)	MARGIN (dB)	ANTENNA HEIGHT (m)	TABLE ANGLE (Degree)	RAW VALUE (dBuV)	CORRECTION FACTOR (dB/m)
1	*5300.00	109.3 PK			3.06 V	271	71.2	38.1
2	*5300.00	98.6 AV			3.06 V	271	60.5	38.1
3	10600.00	58.0 PK	74.0	-16.0	2.76 V	294	41.2	16.8
4	10600.00	43.6 AV	54.0	-10.4	2.76 V	294	26.8	16.8

Remarks:

1. Emission Level(dBuV/m) = Raw Value(dBuV) + Correction Factor(dB/m)
2. Correction Factor(dB/m) = Antenna Factor(dB/m) + Cable Factor(dB) – Pre-Amplifier Factor(dB)
3. The other emission levels were very low against the limit.
4. Margin value = Emission Level – Limit value
5. " * ": Fundamental frequency.
6. " # ": The radiated frequency is out of the restricted band.

CHANNEL	TX Channel 64	DETECTOR FUNCTION	Peak (PK)
FREQUENCY RANGE	1GHz ~ 40GHz		Average (AV)

ANTENNA POLARITY & TEST DISTANCE: HORIZONTAL AT 3 M

NO.	FREQ. (MHz)	EMISSION LEVEL (dBuV/m)	LIMIT (dBuV/m)	MARGIN (dB)	ANTENNA HEIGHT (m)	TABLE ANGLE (Degree)	RAW VALUE (dBuV)	CORRECTION FACTOR (dB/m)
1	*5320.00	113.9 PK			3.54 H	356	75.8	38.1
2	*5320.00	103.7 AV			3.54 H	356	65.6	38.1
3	5350.00	66.5 PK	74.0	-7.5	3.03 H	358	62.7	3.8
4	5350.00	52.5 AV	54.0	-1.5	3.03 H	358	48.7	3.8
5	10640.00	57.8 PK	74.0	-16.2	1.55 H	124	40.8	17.0
6	10640.00	43.7 AV	54.0	-10.3	1.55 H	124	26.7	17.0

ANTENNA POLARITY & TEST DISTANCE: VERTICAL AT 3 M

NO.	FREQ. (MHz)	EMISSION LEVEL (dBuV/m)	LIMIT (dBuV/m)	MARGIN (dB)	ANTENNA HEIGHT (m)	TABLE ANGLE (Degree)	RAW VALUE (dBuV)	CORRECTION FACTOR (dB/m)
1	*5320.00	105.2 PK			2.97 V	261	67.1	38.1
2	*5320.00	94.9 AV			2.97 V	261	56.8	38.1
3	5350.00	57.0 PK	74.0	-17.0	2.91 V	254	53.2	3.8
4	5350.00	44.6 AV	54.0	-9.4	2.91 V	254	40.8	3.8
5	10640.00	57.7 PK	74.0	-16.3	2.82 V	303	40.7	17.0
6	10640.00	43.5 AV	54.0	-10.5	2.82 V	303	26.5	17.0

Remarks:

1. Emission Level(dBuV/m) = Raw Value(dBuV) + Correction Factor(dB/m)
2. Correction Factor(dB/m) = Antenna Factor(dB/m) + Cable Factor(dB) – Pre-Amplifier Factor(dB)
3. The other emission levels were very low against the limit.
4. Margin value = Emission Level – Limit value
5. " * ": Fundamental frequency.
6. " # ": The radiated frequency is out of the restricted band.

CHANNEL	TX Channel 100	DETECTOR FUNCTION	Peak (PK)
FREQUENCY RANGE	1GHz ~ 40GHz		Average (AV)

ANTENNA POLARITY & TEST DISTANCE: HORIZONTAL AT 3 M								
NO.	FREQ. (MHz)	EMISSION LEVEL (dBuV/m)	LIMIT (dBuV/m)	MARGIN (dB)	ANTENNA HEIGHT (m)	TABLE ANGLE (Degree)	RAW VALUE (dBuV)	CORRECTION FACTOR (dB/m)
1	5460.00	60.2 PK	74.0	-13.8	3.76 H	3	56.0	4.2
2	5460.00	46.1 AV	54.0	-7.9	3.76 H	3	41.9	4.2
3	#5470.00	67.2 PK	68.2	-1.0	3.77 H	1	62.9	4.3
4	*5500.00	118.3 PK			3.76 H	358	79.6	38.7
5	*5500.00	107.5 AV			3.76 H	358	68.8	38.7
6	11000.00	59.5 PK	74.0	-14.5	1.62 H	120	41.1	18.4
7	11000.00	45.2 AV	54.0	-8.8	1.62 H	120	26.8	18.4

ANTENNA POLARITY & TEST DISTANCE: VERTICAL AT 3 M								
NO.	FREQ. (MHz)	EMISSION LEVEL (dBuV/m)	LIMIT (dBuV/m)	MARGIN (dB)	ANTENNA HEIGHT (m)	TABLE ANGLE (Degree)	RAW VALUE (dBuV)	CORRECTION FACTOR (dB/m)
1	5460.00	51.2 PK	74.0	-22.8	2.98 V	274	47.0	4.2
2	5460.00	39.9 AV	54.0	-14.1	2.98 V	274	35.7	4.2
3	#5470.00	55.6 PK	68.2	-12.6	2.94 V	274	51.3	4.3
4	*5500.00	109.3 PK			2.93 V	274	70.6	38.7
5	*5500.00	98.5 AV			2.93 V	274	59.8	38.7
6	11000.00	59.4 PK	74.0	-14.6	2.87 V	298	41.0	18.4
7	11000.00	45.5 AV	54.0	-8.5	2.87 V	298	27.1	18.4

Remarks:

1. Emission Level(dBuV/m) = Raw Value(dBuV) + Correction Factor(dB/m)
2. Correction Factor(dB/m) = Antenna Factor(dB/m) + Cable Factor(dB) – Pre-Amplifier Factor(dB)
3. The other emission levels were very low against the limit.
4. Margin value = Emission Level – Limit value
5. " * ": Fundamental frequency.
6. " # ": The radiated frequency is out of the restricted band.

CHANNEL	TX Channel 116	DETECTOR FUNCTION	Peak (PK)
FREQUENCY RANGE	1GHz ~ 40GHz		Average (AV)

ANTENNA POLARITY & TEST DISTANCE: HORIZONTAL AT 3 M

NO.	FREQ. (MHz)	EMISSION LEVEL (dBuV/m)	LIMIT (dBuV/m)	MARGIN (dB)	ANTENNA HEIGHT (m)	TABLE ANGLE (Degree)	RAW VALUE (dBuV)	CORRECTION FACTOR (dB/m)
1	*5580.00	118.1 PK			3.84 H	357	79.5	38.6
2	*5580.00	107.1 AV			3.84 H	357	68.5	38.6
3	11160.00	58.0 PK	74.0	-16.0	1.65 H	123	40.8	17.2
4	11160.00	44.5 AV	54.0	-9.5	1.65 H	123	27.3	17.2

ANTENNA POLARITY & TEST DISTANCE: VERTICAL AT 3 M

NO.	FREQ. (MHz)	EMISSION LEVEL (dBuV/m)	LIMIT (dBuV/m)	MARGIN (dB)	ANTENNA HEIGHT (m)	TABLE ANGLE (Degree)	RAW VALUE (dBuV)	CORRECTION FACTOR (dB/m)
1	*5580.00	108.7 PK			3.00 V	269	70.1	38.6
2	*5580.00	97.9 AV			3.00 V	269	59.3	38.6
3	11160.00	57.7 PK	74.0	-16.3	2.90 V	307	40.5	17.2
4	11160.00	44.1 AV	54.0	-9.9	2.90 V	307	26.9	17.2

Remarks:

1. Emission Level(dBuV/m) = Raw Value(dBuV) + Correction Factor(dB/m)
2. Correction Factor(dB/m) = Antenna Factor(dB/m) + Cable Factor(dB) – Pre-Amplifier Factor(dB)
3. The other emission levels were very low against the limit.
4. Margin value = Emission Level – Limit value
5. " * ": Fundamental frequency.
6. " # ": The radiated frequency is out of the restricted band.

CHANNEL	TX Channel 140	DETECTOR FUNCTION	Peak (PK)
FREQUENCY RANGE	1GHz ~ 40GHz		Average (AV)

ANTENNA POLARITY & TEST DISTANCE: HORIZONTAL AT 3 M								
NO.	FREQ. (MHz)	EMISSION LEVEL (dBuV/m)	LIMIT (dBuV/m)	MARGIN (dB)	ANTENNA HEIGHT (m)	TABLE ANGLE (Degree)	RAW VALUE (dBuV)	CORRECTION FACTOR (dB/m)
1	*5700.00	111.5 PK			3.81 H	356	72.7	38.8
2	*5700.00	101.1 AV			3.81 H	356	62.3	38.8
3	#5725.00	67.0 PK	68.2	-1.2	3.78 H	2	62.6	4.4
4	11400.00	58.9 PK	74.0	-15.1	1.57 H	117	41.4	17.5
5	11400.00	44.5 AV	54.0	-9.5	1.57 H	117	27.0	17.5
ANTENNA POLARITY & TEST DISTANCE: VERTICAL AT 3 M								
NO.	FREQ. (MHz)	EMISSION LEVEL (dBuV/m)	LIMIT (dBuV/m)	MARGIN (dB)	ANTENNA HEIGHT (m)	TABLE ANGLE (Degree)	RAW VALUE (dBuV)	CORRECTION FACTOR (dB/m)
1	*5700.00	102.1 PK			2.95 V	274	63.3	38.8
2	*5700.00	91.9 AV			2.95 V	274	53.1	38.8
3	#5725.00	57.9 PK	68.2	-10.3	3.04 V	272	53.5	4.4
4	11400.00	58.7 PK	74.0	-15.3	2.89 V	298	41.2	17.5
5	11400.00	44.7 AV	54.0	-9.3	2.89 V	298	27.2	17.5

Remarks:

1. Emission Level(dBuV/m) = Raw Value(dBuV) + Correction Factor(dB/m)
2. Correction Factor(dB/m) = Antenna Factor(dB/m) + Cable Factor(dB) – Pre-Amplifier Factor(dB)
3. The other emission levels were very low against the limit.
4. Margin value = Emission Level – Limit value
5. " * ": Fundamental frequency.
6. " # ": The radiated frequency is out of the restricted band.

802.11n (HT20)

CHANNEL	TX Channel 52	DETECTOR FUNCTION	Peak (PK)
FREQUENCY RANGE	1GHz ~ 40GHz		Average (AV)

ANTENNA POLARITY & TEST DISTANCE: HORIZONTAL AT 3 M

NO.	FREQ. (MHz)	EMISSION LEVEL (dBuV/m)	LIMIT (dBuV/m)	MARGIN (dB)	ANTENNA HEIGHT (m)	TABLE ANGLE (Degree)	RAW VALUE (dBuV)	CORRECTION FACTOR (dB/m)
1	5150.00	54.7 PK	74.0	-19.3	3.62 H	351	50.8	3.9
2	5150.00	44.4 AV	54.0	-9.6	3.62 H	351	40.5	3.9
3	*5260.00	118.5 PK			3.70 H	358	80.4	38.1
4	*5260.00	108.3 AV			3.70 H	358	70.2	38.1
5	#10520.00	58.0 PK	68.2	-10.2	1.54 H	116	41.4	16.6

ANTENNA POLARITY & TEST DISTANCE: VERTICAL AT 3 M

NO.	FREQ. (MHz)	EMISSION LEVEL (dBuV/m)	LIMIT (dBuV/m)	MARGIN (dB)	ANTENNA HEIGHT (m)	TABLE ANGLE (Degree)	RAW VALUE (dBuV)	CORRECTION FACTOR (dB/m)
1	5150.00	54.1 PK	74.0	-19.9	2.80 V	253	50.2	3.9
2	5150.00	43.4 AV	54.0	-10.6	2.80 V	253	39.5	3.9
3	*5260.00	109.9 PK			2.86 V	265	71.8	38.1
4	*5260.00	99.7 AV			2.86 V	265	61.6	38.1
5	#10520.00	57.5 PK	68.2	-10.7	2.87 V	318	40.9	16.6

Remarks:

1. Emission Level(dBuV/m) = Raw Value(dBuV) + Correction Factor(dB/m)
2. Correction Factor(dB/m) = Antenna Factor(dB/m) + Cable Factor(dB) – Pre-Amplifier Factor(dB)
3. The other emission levels were very low against the limit.
4. Margin value = Emission Level – Limit value
5. " * ": Fundamental frequency.
6. " # ": The radiated frequency is out of the restricted band.

CHANNEL	TX Channel 60	DETECTOR	Peak (PK)
FREQUENCY RANGE	1GHz ~ 40GHz	FUNCTION	Average (AV)

ANTENNA POLARITY & TEST DISTANCE: HORIZONTAL AT 3 M

NO.	FREQ. (MHz)	EMISSION LEVEL (dBuV/m)	LIMIT (dBuV/m)	MARGIN (dB)	ANTENNA HEIGHT (m)	TABLE ANGLE (Degree)	RAW VALUE (dBuV)	CORRECTION FACTOR (dB/m)
1	*5300.00	117.6 PK			3.57 H	354	79.5	38.1
2	*5300.00	107.4 AV			3.57 H	354	69.3	38.1
3	10600.00	58.0 PK	74.0	-16.0	1.59 H	118	41.2	16.8
4	10600.00	43.8 AV	54.0	-10.2	1.59 H	118	27.0	16.8

ANTENNA POLARITY & TEST DISTANCE: VERTICAL AT 3 M

NO.	FREQ. (MHz)	EMISSION LEVEL (dBuV/m)	LIMIT (dBuV/m)	MARGIN (dB)	ANTENNA HEIGHT (m)	TABLE ANGLE (Degree)	RAW VALUE (dBuV)	CORRECTION FACTOR (dB/m)
1	*5300.00	108.9 PK			2.96 V	267	70.8	38.1
2	*5300.00	98.7 AV			2.96 V	267	60.6	38.1
3	10600.00	57.8 PK	74.0	-16.2	2.84 V	302	41.0	16.8
4	10600.00	43.5 AV	54.0	-10.5	2.84 V	302	26.7	16.8

Remarks:

1. Emission Level(dBuV/m) = Raw Value(dBuV) + Correction Factor(dB/m)
2. Correction Factor(dB/m) = Antenna Factor(dB/m) + Cable Factor(dB) – Pre-Amplifier Factor(dB)
3. The other emission levels were very low against the limit.
4. Margin value = Emission Level – Limit value
5. " * ": Fundamental frequency.
6. " # ": The radiated frequency is out of the restricted band.

CHANNEL	TX Channel 64	DETECTOR FUNCTION	Peak (PK)
FREQUENCY RANGE	1GHz ~ 40GHz		Average (AV)

ANTENNA POLARITY & TEST DISTANCE: HORIZONTAL AT 3 M								
NO.	FREQ. (MHz)	EMISSION LEVEL (dBuV/m)	LIMIT (dBuV/m)	MARGIN (dB)	ANTENNA HEIGHT (m)	TABLE ANGLE (Degree)	RAW VALUE (dBuV)	CORRECTION FACTOR (dB/m)
1	*5320.00	113.2 PK			3.86 H	358	75.1	38.1
2	*5320.00	102.8 AV			3.86 H	358	64.7	38.1
3	5350.00	65.2 PK	74.0	-8.8	3.81 H	356	61.4	3.8
4	5350.00	52.3 AV	54.0	-1.7	3.81 H	356	48.5	3.8
5	10640.00	57.7 PK	74.0	-16.3	1.63 H	128	40.7	17.0
6	10640.00	43.6 AV	54.0	-10.4	1.63 H	128	26.6	17.0

ANTENNA POLARITY & TEST DISTANCE: VERTICAL AT 3 M								
NO.	FREQ. (MHz)	EMISSION LEVEL (dBuV/m)	LIMIT (dBuV/m)	MARGIN (dB)	ANTENNA HEIGHT (m)	TABLE ANGLE (Degree)	RAW VALUE (dBuV)	CORRECTION FACTOR (dB/m)
1	*5320.00	104.4 PK			2.93 V	274	66.3	38.1
2	*5320.00	94.0 AV			2.93 V	274	55.9	38.1
3	5350.00	56.4 PK	74.0	-17.6	2.85 V	267	52.6	3.8
4	5350.00	44.6 AV	54.0	-9.4	2.85 V	267	40.8	3.8
5	10640.00	57.6 PK	74.0	-16.4	2.81 V	306	40.6	17.0
6	10640.00	43.4 AV	54.0	-10.6	2.81 V	306	26.4	17.0

Remarks:

1. Emission Level(dBuV/m) = Raw Value(dBuV) + Correction Factor(dB/m)
2. Correction Factor(dB/m) = Antenna Factor(dB/m) + Cable Factor(dB) – Pre-Amplifier Factor(dB)
3. The other emission levels were very low against the limit.
4. Margin value = Emission Level – Limit value
5. " * ": Fundamental frequency.
6. " # ": The radiated frequency is out of the restricted band.

CHANNEL	TX Channel 100	DETECTOR FUNCTION	Peak (PK)
FREQUENCY RANGE	1GHz ~ 40GHz		Average (AV)

ANTENNA POLARITY & TEST DISTANCE: HORIZONTAL AT 3 M								
NO.	FREQ. (MHz)	EMISSION LEVEL (dBuV/m)	LIMIT (dBuV/m)	MARGIN (dB)	ANTENNA HEIGHT (m)	TABLE ANGLE (Degree)	RAW VALUE (dBuV)	CORRECTION FACTOR (dB/m)
1	5460.00	54.0 PK	74.0	-20.0	3.72 H	6	49.8	4.2
2	5460.00	41.4 AV	54.0	-12.6	3.72 H	6	37.2	4.2
3	#5470.00	66.7 PK	68.2	-1.5	3.77 H	4	62.4	4.3
4	*5500.00	114.0 PK			3.78 H	356	75.3	38.7
5	*5500.00	103.3 AV			3.78 H	356	64.6	38.7
6	11000.00	59.5 PK	74.0	-14.5	1.56 H	120	41.1	18.4
7	11000.00	45.7 AV	54.0	-8.3	1.56 H	120	27.3	18.4

ANTENNA POLARITY & TEST DISTANCE: VERTICAL AT 3 M								
NO.	FREQ. (MHz)	EMISSION LEVEL (dBuV/m)	LIMIT (dBuV/m)	MARGIN (dB)	ANTENNA HEIGHT (m)	TABLE ANGLE (Degree)	RAW VALUE (dBuV)	CORRECTION FACTOR (dB/m)
1	5460.00	51.2 PK	74.0	-22.8	2.95 V	171	47.0	4.2
2	5460.00	40.5 AV	54.0	-13.5	2.95 V	171	36.3	4.2
3	#5470.00	58.3 PK	68.2	-9.9	3.00 V	270	54.0	4.3
4	*5500.00	104.8 PK			3.03 V	267	66.1	38.7
5	*5500.00	94.2 AV			3.03 V	267	55.5	38.7
6	11000.00	59.3 PK	74.0	-14.7	2.84 V	299	40.9	18.4
7	11000.00	45.7 AV	54.0	-8.3	2.84 V	299	27.3	18.4

Remarks:

1. Emission Level(dBuV/m) = Raw Value(dBuV) + Correction Factor(dB/m)
2. Correction Factor(dB/m) = Antenna Factor(dB/m) + Cable Factor(dB) – Pre-Amplifier Factor(dB)
3. The other emission levels were very low against the limit.
4. Margin value = Emission Level – Limit value
5. " * ": Fundamental frequency.
6. " # ": The radiated frequency is out of the restricted band.

CHANNEL	TX Channel 116	DETECTOR	Peak (PK)
FREQUENCY RANGE	1GHz ~ 40GHz	FUNCTION	Average (AV)

ANTENNA POLARITY & TEST DISTANCE: HORIZONTAL AT 3 M

NO.	FREQ. (MHz)	EMISSION LEVEL (dBuV/m)	LIMIT (dBuV/m)	MARGIN (dB)	ANTENNA HEIGHT (m)	TABLE ANGLE (Degree)	RAW VALUE (dBuV)	CORRECTION FACTOR (dB/m)
1	*5580.00	117.1 PK			3.65 H	2	78.5	38.6
2	*5580.00	106.9 AV			3.65 H	2	68.3	38.6
3	11160.00	58.6 PK	74.0	-15.4	1.60 H	122	41.4	17.2
4	11160.00	44.3 AV	54.0	-9.7	1.60 H	122	27.1	17.2

ANTENNA POLARITY & TEST DISTANCE: VERTICAL AT 3 M

NO.	FREQ. (MHz)	EMISSION LEVEL (dBuV/m)	LIMIT (dBuV/m)	MARGIN (dB)	ANTENNA HEIGHT (m)	TABLE ANGLE (Degree)	RAW VALUE (dBuV)	CORRECTION FACTOR (dB/m)
1	*5580.00	107.9 PK			3.07 V	273	69.3	38.6
2	*5580.00	97.8 AV			3.07 V	273	59.2	38.6
3	11160.00	58.6 PK	74.0	-15.4	2.86 V	307	41.4	17.2
4	11160.00	44.3 AV	54.0	-9.7	2.86 V	307	27.1	17.2

Remarks:

1. Emission Level(dBuV/m) = Raw Value(dBuV) + Correction Factor(dB/m)
2. Correction Factor(dB/m) = Antenna Factor(dB/m) + Cable Factor(dB) – Pre-Amplifier Factor(dB)
3. The other emission levels were very low against the limit.
4. Margin value = Emission Level – Limit value
5. " * ": Fundamental frequency.
6. " # ": The radiated frequency is out of the restricted band.

CHANNEL	TX Channel 140	DETECTOR FUNCTION	Peak (PK)
FREQUENCY RANGE	1GHz ~ 40GHz		Average (AV)

ANTENNA POLARITY & TEST DISTANCE: HORIZONTAL AT 3 M								
NO.	FREQ. (MHz)	EMISSION LEVEL (dBuV/m)	LIMIT (dBuV/m)	MARGIN (dB)	ANTENNA HEIGHT (m)	TABLE ANGLE (Degree)	RAW VALUE (dBuV)	CORRECTION FACTOR (dB/m)
1	*5700.00	111.9 PK			3.83 H	356	73.1	38.8
2	*5700.00	101.2 AV			3.83 H	356	62.4	38.8
3	#5725.00	66.7 PK	68.2	-1.5	3.80 H	2	62.3	4.4
4	11400.00	58.9 PK	74.0	-15.1	1.54 H	120	41.4	17.5
5	11400.00	44.5 AV	54.0	-9.5	1.54 H	120	27.0	17.5

ANTENNA POLARITY & TEST DISTANCE: VERTICAL AT 3 M								
NO.	FREQ. (MHz)	EMISSION LEVEL (dBuV/m)	LIMIT (dBuV/m)	MARGIN (dB)	ANTENNA HEIGHT (m)	TABLE ANGLE (Degree)	RAW VALUE (dBuV)	CORRECTION FACTOR (dB/m)
1	*5700.00	102.5 PK			3.04 V	273	63.7	38.8
2	*5700.00	92.0 AV			3.04 V	273	53.2	38.8
3	#5725.00	59.3 PK	68.2	-8.9	3.04 V	275	54.9	4.4
4	11400.00	58.4 PK	74.0	-15.6	2.83 V	295	40.9	17.5
5	11400.00	44.5 AV	54.0	-9.5	2.83 V	295	27.0	17.5

Remarks:

1. Emission Level(dBuV/m) = Raw Value(dBuV) + Correction Factor(dB/m)
2. Correction Factor(dB/m) = Antenna Factor(dB/m) + Cable Factor(dB) – Pre-Amplifier Factor(dB)
3. The other emission levels were very low against the limit.
4. Margin value = Emission Level – Limit value
5. " * ": Fundamental frequency.
6. " # ": The radiated frequency is out of the restricted band.

802.11n (HT40)

CHANNEL	TX Channel 54	DETECTOR FUNCTION	Peak (PK)
FREQUENCY RANGE	1GHz ~ 40GHz		Average (AV)

ANTENNA POLARITY & TEST DISTANCE: HORIZONTAL AT 3 M

NO.	FREQ. (MHz)	EMISSION LEVEL (dBuV/m)	LIMIT (dBuV/m)	MARGIN (dB)	ANTENNA HEIGHT (m)	TABLE ANGLE (Degree)	RAW VALUE (dBuV)	CORRECTION FACTOR (dB/m)
1	5150.00	55.7 PK	74.0	-18.3	3.67 H	352	51.8	3.9
2	5150.00	45.2 AV	54.0	-8.8	3.67 H	352	41.3	3.9
3	*5270.00	114.2 PK			3.62 H	355	76.1	38.1
4	*5270.00	104.0 AV			3.62 H	355	65.9	38.1
5	5350.00	65.2 PK	74.0	-8.8	3.75 H	359	61.4	3.8
6	5350.00	52.2 AV	54.0	-1.8	3.75 H	359	48.4	3.8
7	#10540.00	57.4 PK	68.2	-10.8	1.59 H	106	40.7	16.7

ANTENNA POLARITY & TEST DISTANCE: VERTICAL AT 3 M

NO.	FREQ. (MHz)	EMISSION LEVEL (dBuV/m)	LIMIT (dBuV/m)	MARGIN (dB)	ANTENNA HEIGHT (m)	TABLE ANGLE (Degree)	RAW VALUE (dBuV)	CORRECTION FACTOR (dB/m)
1	5150.00	54.3 PK	74.0	-19.7	3.12 V	282	50.4	3.9
2	5150.00	43.8 AV	54.0	-10.2	3.12 V	282	39.9	3.9
3	*5270.00	105.5 PK			3.05 V	278	67.4	38.1
4	*5270.00	95.3 AV			3.05 V	278	57.2	38.1
5	5350.00	55.7 PK	74.0	-18.3	2.95 V	270	51.9	3.8
6	5350.00	44.4 AV	54.0	-9.6	2.95 V	270	40.6	3.8
7	#10540.00	57.3 PK	68.2	-10.9	2.92 V	316	40.6	16.7

Remarks:

1. Emission Level(dBuV/m) = Raw Value(dBuV) + Correction Factor(dB/m)
2. Correction Factor(dB/m) = Antenna Factor(dB/m) + Cable Factor(dB) – Pre-Amplifier Factor(dB)
3. The other emission levels were very low against the limit.
4. Margin value = Emission Level – Limit value
5. " * ": Fundamental frequency.
6. " # ": The radiated frequency is out of the restricted band.

CHANNEL	TX Channel 62	DETECTOR FUNCTION	Peak (PK)
FREQUENCY RANGE	1GHz ~ 40GHz		Average (AV)

ANTENNA POLARITY & TEST DISTANCE: HORIZONTAL AT 3 M								
NO.	FREQ. (MHz)	EMISSION LEVEL (dBuV/m)	LIMIT (dBuV/m)	MARGIN (dB)	ANTENNA HEIGHT (m)	TABLE ANGLE (Degree)	RAW VALUE (dBuV)	CORRECTION FACTOR (dB/m)
1	*5310.00	109.2 PK			3.60 H	357	71.1	38.1
2	*5310.00	98.8 AV			3.60 H	357	60.7	38.1
3	5350.00	65.7 PK	74.0	-8.3	3.16 H	351	61.9	3.8
4	5350.00	52.1 AV	54.0	-1.9	3.16 H	351	48.3	3.8
5	10620.00	57.5 PK	74.0	-16.5	1.46 H	101	40.6	16.9
6	10620.00	43.4 AV	54.0	-10.6	1.46 H	101	26.5	16.9

ANTENNA POLARITY & TEST DISTANCE: VERTICAL AT 3 M								
NO.	FREQ. (MHz)	EMISSION LEVEL (dBuV/m)	LIMIT (dBuV/m)	MARGIN (dB)	ANTENNA HEIGHT (m)	TABLE ANGLE (Degree)	RAW VALUE (dBuV)	CORRECTION FACTOR (dB/m)
1	*5310.00	100.5 PK			2.97 V	271	62.4	38.1
2	*5310.00	90.0 AV			2.97 V	271	51.9	38.1
3	5350.00	55.6 PK	74.0	-18.4	2.89 V	264	51.8	3.8
4	5350.00	44.3 AV	54.0	-9.7	2.89 V	264	40.5	3.8
5	10620.00	57.4 PK	74.0	-16.6	2.83 V	314	40.5	16.9
6	10620.00	43.2 AV	54.0	-10.8	2.83 V	314	26.3	16.9

Remarks:

1. Emission Level(dBuV/m) = Raw Value(dBuV) + Correction Factor(dB/m)
2. Correction Factor(dB/m) = Antenna Factor(dB/m) + Cable Factor(dB) – Pre-Amplifier Factor(dB)
3. The other emission levels were very low against the limit.
4. Margin value = Emission Level – Limit value
5. " * ": Fundamental frequency.
6. " # ": The radiated frequency is out of the restricted band.

CHANNEL	TX Channel 102	DETECTOR FUNCTION	Peak (PK)
FREQUENCY RANGE	1GHz ~ 40GHz		Average (AV)

ANTENNA POLARITY & TEST DISTANCE: HORIZONTAL AT 3 M								
NO.	FREQ. (MHz)	EMISSION LEVEL (dBuV/m)	LIMIT (dBuV/m)	MARGIN (dB)	ANTENNA HEIGHT (m)	TABLE ANGLE (Degree)	RAW VALUE (dBuV)	CORRECTION FACTOR (dB/m)
1	5460.00	62.6 PK	74.0	-11.4	3.96 H	352	58.4	4.2
2	5460.00	45.3 AV	54.0	-8.7	3.96 H	352	41.1	4.2
3	#5470.00	67.0 PK	68.2	-1.2	4.00 H	358	62.7	4.3
4	*5510.00	109.2 PK			3.78 H	357	70.6	38.6
5	*5510.00	99.1 AV			3.78 H	357	60.5	38.6
6	11020.00	59.6 PK	74.0	-14.4	1.60 H	116	41.5	18.1
7	11020.00	45.2 AV	54.0	-8.8	1.60 H	116	27.1	18.1

ANTENNA POLARITY & TEST DISTANCE: VERTICAL AT 3 M								
NO.	FREQ. (MHz)	EMISSION LEVEL (dBuV/m)	LIMIT (dBuV/m)	MARGIN (dB)	ANTENNA HEIGHT (m)	TABLE ANGLE (Degree)	RAW VALUE (dBuV)	CORRECTION FACTOR (dB/m)
1	5460.00	51.5 PK	74.0	-22.5	3.07 V	270	47.3	4.2
2	5460.00	40.1 AV	54.0	-13.9	3.07 V	270	35.9	4.2
3	#5470.00	54.6 PK	68.2	-13.6	3.07 V	360	50.3	4.3
4	*5510.00	100.0 PK			3.03 V	275	61.4	38.6
5	*5510.00	90.0 AV			3.03 V	275	51.4	38.6
6	11020.00	58.9 PK	74.0	-15.1	2.08 V	295	40.8	18.1
7	11020.00	45.2 AV	54.0	-8.8	2.08 V	295	27.1	18.1

Remarks:

1. Emission Level(dBuV/m) = Raw Value(dBuV) + Correction Factor(dB/m)
2. Correction Factor(dB/m) = Antenna Factor(dB/m) + Cable Factor(dB) – Pre-Amplifier Factor(dB)
3. The other emission levels were very low against the limit.
4. Margin value = Emission Level – Limit value
5. " * ": Fundamental frequency.
6. " # ": The radiated frequency is out of the restricted band.

CHANNEL	TX Channel 110	DETECTOR FUNCTION	Peak (PK)
FREQUENCY RANGE	1GHz ~ 40GHz		Average (AV)

ANTENNA POLARITY & TEST DISTANCE: HORIZONTAL AT 3 M								
NO.	FREQ. (MHz)	EMISSION LEVEL (dBuV/m)	LIMIT (dBuV/m)	MARGIN (dB)	ANTENNA HEIGHT (m)	TABLE ANGLE (Degree)	RAW VALUE (dBuV)	CORRECTION FACTOR (dB/m)
1	5460.00	63.5 PK	74.0	-10.5	4.00 H	2	59.3	4.2
2	5460.00	47.2 AV	54.0	-6.8	4.00 H	2	43.0	4.2
3	#5470.00	66.7 PK	68.2	-1.5	4.00 H	1	62.4	4.3
4	*5550.00	113.6 PK			3.87 H	359	75.0	38.6
5	*5550.00	103.0 AV			3.87 H	359	64.4	38.6
6	11100.00	57.8 PK	74.0	-16.2	1.65 H	123	40.5	17.3
7	11100.00	44.4 AV	54.0	-9.6	1.65 H	123	27.1	17.3

ANTENNA POLARITY & TEST DISTANCE: VERTICAL AT 3 M								
NO.	FREQ. (MHz)	EMISSION LEVEL (dBuV/m)	LIMIT (dBuV/m)	MARGIN (dB)	ANTENNA HEIGHT (m)	TABLE ANGLE (Degree)	RAW VALUE (dBuV)	CORRECTION FACTOR (dB/m)
1	5460.00	52.0 PK	74.0	-22.0	3.05 V	271	47.8	4.2
2	5460.00	40.2 AV	54.0	-13.8	3.05 V	271	36.0	4.2
3	#5470.00	59.1 PK	68.2	-9.1	3.08 V	272	54.8	4.3
4	*5550.00	104.2 PK			3.02 V	272	65.6	38.6
5	*5550.00	93.8 AV			3.02 V	272	55.2	38.6
6	11100.00	58.1 PK	74.0	-15.9	2.79 V	304	40.8	17.3
7	11100.00	44.2 AV	54.0	-9.8	2.79 V	304	26.9	17.3

Remarks:

1. Emission Level(dBuV/m) = Raw Value(dBuV) + Correction Factor(dB/m)
2. Correction Factor(dB/m) = Antenna Factor(dB/m) + Cable Factor(dB) – Pre-Amplifier Factor(dB)
3. The other emission levels were very low against the limit.
4. Margin value = Emission Level – Limit value
5. " * ": Fundamental frequency.
6. " # ": The radiated frequency is out of the restricted band.

CHANNEL	TX Channel 134	DETECTOR FUNCTION	Peak (PK)
FREQUENCY RANGE	1GHz ~ 40GHz		Average (AV)

ANTENNA POLARITY & TEST DISTANCE: HORIZONTAL AT 3 M								
NO.	FREQ. (MHz)	EMISSION LEVEL (dBuV/m)	LIMIT (dBuV/m)	MARGIN (dB)	ANTENNA HEIGHT (m)	TABLE ANGLE (Degree)	RAW VALUE (dBuV)	CORRECTION FACTOR (dB/m)
1	*5670.00	108.9 PK			3.82 H	351	70.2	38.7
2	*5670.00	98.6 AV			3.82 H	351	59.9	38.7
3	#5725.00	67.0 PK	68.2	-1.2	4.00 H	1	62.6	4.4
4	11340.00	58.6 PK	74.0	-15.4	1.60 H	126	40.9	17.7
5	11340.00	44.8 AV	54.0	-9.2	1.60 H	126	27.1	17.7
ANTENNA POLARITY & TEST DISTANCE: VERTICAL AT 3 M								
NO.	FREQ. (MHz)	EMISSION LEVEL (dBuV/m)	LIMIT (dBuV/m)	MARGIN (dB)	ANTENNA HEIGHT (m)	TABLE ANGLE (Degree)	RAW VALUE (dBuV)	CORRECTION FACTOR (dB/m)
1	*5670.00	99.5 PK			3.03 V	269	60.8	38.7
2	*5670.00	89.4 AV			3.03 V	269	50.7	38.7
3	#5725.00	59.3 PK	68.2	-8.9	2.89 V	269	54.9	4.4
4	11340.00	58.2 PK	74.0	-15.8	2.89 V	297	40.5	17.7
5	11340.00	44.7 AV	54.0	-9.3	2.89 V	297	27.0	17.7

Remarks:

1. Emission Level(dBuV/m) = Raw Value(dBuV) + Correction Factor(dB/m)
2. Correction Factor(dB/m) = Antenna Factor(dB/m) + Cable Factor(dB) – Pre-Amplifier Factor(dB)
3. The other emission levels were very low against the limit.
4. Margin value = Emission Level – Limit value
5. " * ": Fundamental frequency.
6. " # ": The radiated frequency is out of the restricted band.

802.11ac (VHT80)

CHANNEL	TX Channel 58	DETECTOR FUNCTION	Peak (PK)
FREQUENCY RANGE	1GHz ~ 40GHz		Average (AV)

ANTENNA POLARITY & TEST DISTANCE: HORIZONTAL AT 3 M

NO.	FREQ. (MHz)	EMISSION LEVEL (dBuV/m)	LIMIT (dBuV/m)	MARGIN (dB)	ANTENNA HEIGHT (m)	TABLE ANGLE (Degree)	RAW VALUE (dBuV)	CORRECTION FACTOR (dB/m)
1	*5290.00	105.5 PK			3.50 H	3	67.4	38.1
2	*5290.00	95.4 AV			3.50 H	3	57.3	38.1
3	5350.00	66.1 PK	74.0	-7.9	3.49 H	351	62.3	3.8
4	5350.00	52.2 AV	54.0	-1.8	3.49 H	351	48.4	3.8
5	#10580.00	57.4 PK	68.2	-10.8	1.58 H	112	40.6	16.8

ANTENNA POLARITY & TEST DISTANCE: VERTICAL AT 3 M

NO.	FREQ. (MHz)	EMISSION LEVEL (dBuV/m)	LIMIT (dBuV/m)	MARGIN (dB)	ANTENNA HEIGHT (m)	TABLE ANGLE (Degree)	RAW VALUE (dBuV)	CORRECTION FACTOR (dB/m)
1	*5290.00	97.0 PK			3.06 V	277	58.9	38.1
2	*5290.00	86.7 AV			3.06 V	277	48.6	38.1
3	5350.00	55.5 PK	74.0	-18.5	2.93 V	268	51.7	3.8
4	5350.00	44.6 AV	54.0	-9.4	2.93 V	268	40.8	3.8
5	#10580.00	57.3 PK	68.2	-10.9	2.86 V	310	40.5	16.8

Remarks:

1. Emission Level(dBuV/m) = Raw Value(dBuV) + Correction Factor(dB/m)
2. Correction Factor(dB/m) = Antenna Factor(dB/m) + Cable Factor(dB) – Pre-Amplifier Factor(dB)
3. The other emission levels were very low against the limit.
4. Margin value = Emission Level – Limit value
5. " * ": Fundamental frequency.
6. " # ": The radiated frequency is out of the restricted band.

CHANNEL	TX Channel 106	DETECTOR FUNCTION	Peak (PK)
FREQUENCY RANGE	1GHz ~ 40GHz		Average (AV)

ANTENNA POLARITY & TEST DISTANCE: HORIZONTAL AT 3 M

NO.	FREQ. (MHz)	EMISSION LEVEL (dBuV/m)	LIMIT (dBuV/m)	MARGIN (dB)	ANTENNA HEIGHT (m)	TABLE ANGLE (Degree)	RAW VALUE (dBuV)	CORRECTION FACTOR (dB/m)
1	5460.00	64.9 PK	74.0	-9.1	3.82 H	2	60.7	4.2
2	5460.00	52.3 AV	54.0	-1.7	3.82 H	2	48.1	4.2
3	#5470.00	66.7 PK	68.2	-1.5	3.81 H	1	62.4	4.3
4	*5530.00	104.3 PK			3.95 H	1	65.7	38.6
5	*5530.00	94.4 AV			3.95 H	1	55.8	38.6
6	#5725.00	55.9 PK	68.2	-12.3	3.91 H	4	51.5	4.4
7	11060.00	58.6 PK	74.0	-15.4	1.49 H	131	40.8	17.8
8	11060.00	45.1 AV	54.0	-8.9	1.49 H	131	27.3	17.8

ANTENNA POLARITY & TEST DISTANCE: VERTICAL AT 3 M

NO.	FREQ. (MHz)	EMISSION LEVEL (dBuV/m)	LIMIT (dBuV/m)	MARGIN (dB)	ANTENNA HEIGHT (m)	TABLE ANGLE (Degree)	RAW VALUE (dBuV)	CORRECTION FACTOR (dB/m)
1	5460.00	57.7 PK	74.0	-16.3	2.88 V	273	53.5	4.2
2	5460.00	40.4 AV	54.0	-13.6	2.88 V	273	36.2	4.2
3	#5470.00	58.3 PK	68.2	-9.9	2.89 V	267	54.0	4.3
4	*5530.00	95.7 PK			2.90 V	271	57.1	38.6
5	*5530.00	85.6 AV			2.90 V	271	47.0	38.6
6	#5725.00	52.6 PK	68.2	-15.6	2.93 V	272	48.2	4.4
7	11060.00	58.6 PK	74.0	-15.4	1.49 V	131	40.8	17.8
8	11060.00	45.1 AV	54.0	-8.9	1.49 V	131	27.3	17.8

Remarks:

1. Emission Level(dBuV/m) = Raw Value(dBuV) + Correction Factor(dB/m)
2. Correction Factor(dB/m) = Antenna Factor(dB/m) + Cable Factor(dB) – Pre-Amplifier Factor(dB)
3. The other emission levels were very low against the limit.
4. Margin value = Emission Level – Limit value
5. " * ": Fundamental frequency.
6. " # ": The radiated frequency is out of the restricted band.

CHANNEL	TX Channel 122	DETECTOR FUNCTION	Peak (PK)
FREQUENCY RANGE	1GHz ~ 40GHz		Average (AV)

ANTENNA POLARITY & TEST DISTANCE: HORIZONTAL AT 3 M								
NO.	FREQ. (MHz)	EMISSION LEVEL (dBuV/m)	LIMIT (dBuV/m)	MARGIN (dB)	ANTENNA HEIGHT (m)	TABLE ANGLE (Degree)	RAW VALUE (dBuV)	CORRECTION FACTOR (dB/m)
1	5460.00	56.7 PK	74.0	-17.3	3.95 H	359	52.5	4.2
2	5460.00	41.2 AV	54.0	-12.8	3.95 H	359	37.0	4.2
3	#5470.00	57.2 PK	68.2	-11.0	3.93 H	358	52.9	4.3
4	*5610.00	106.3 PK			3.92 H	3	67.6	38.7
5	*5610.00	96.7 AV			3.92 H	3	58.0	38.7
6	#5725.00	67.2 PK	68.2	-1.0	4.00 H	358	62.8	4.4
7	11220.00	58.4 PK	74.0	-15.6	1.48 H	127	41.3	17.1
8	11220.00	44.2 AV	54.0	-9.8	1.48 H	127	27.1	17.1
ANTENNA POLARITY & TEST DISTANCE: VERTICAL AT 3 M								
NO.	FREQ. (MHz)	EMISSION LEVEL (dBuV/m)	LIMIT (dBuV/m)	MARGIN (dB)	ANTENNA HEIGHT (m)	TABLE ANGLE (Degree)	RAW VALUE (dBuV)	CORRECTION FACTOR (dB/m)
1	5460.00	55.9 PK	74.0	-18.1	3.08 V	274	51.7	4.2
2	5460.00	40.1 AV	54.0	-13.9	3.08 V	274	35.9	4.2
3	#5470.00	57.7 PK	68.2	-10.5	2.95 V	270	53.4	4.3
4	*5610.00	97.5 PK			2.93 V	269	58.8	38.7
5	*5610.00	87.8 AV			2.93 V	269	49.1	38.7
6	#5725.00	59.5 PK	68.2	-8.7	2.94 V	273	55.1	4.4
7	11220.00	58.5 PK	74.0	-15.5	2.74 V	309	41.4	17.1
8	11220.00	44.0 AV	54.0	-10.0	2.74 V	309	26.9	17.1

Remarks:

1. Emission Level(dBuV/m) = Raw Value(dBuV) + Correction Factor(dB/m)
2. Correction Factor(dB/m) = Antenna Factor(dB/m) + Cable Factor(dB) – Pre-Amplifier Factor(dB)
3. The other emission levels were very low against the limit.
4. Margin value = Emission Level – Limit value
5. " * ": Fundamental frequency.
6. " # ": The radiated frequency is out of the restricted band.

Below 1GHz Worst-Case Data: 802.11n (HT40)

CHANNEL	TX Channel 54	DETECTOR FUNCTION	Quasi-Peak (QP)
FREQUENCY RANGE	9kHz ~ 1GHz		

ANTENNA POLARITY & TEST DISTANCE: HORIZONTAL AT 3 M								
NO.	FREQ. (MHz)	EMISSION LEVEL (dBuV/m)	LIMIT (dBuV/m)	MARGIN (dB)	ANTENNA HEIGHT (m)	TABLE ANGLE (Degree)	RAW VALUE (dBuV)	CORRECTION FACTOR (dB/m)
1	80.61	24.7 QP	40.0	-15.3	1.50 H	111	38.0	-13.3
2	132.62	27.2 QP	43.5	-16.3	2.00 H	123	36.9	-9.7
3	267.58	32.0 QP	46.0	-14.0	1.00 H	123	40.6	-8.6
4	375.67	43.0 QP	46.0	-3.0	2.00 H	222	48.1	-5.1
5	628.87	30.8 QP	46.0	-15.2	1.50 H	6	29.3	1.5
6	730.09	36.5 QP	46.0	-9.5	1.00 H	243	34.0	2.5

Remarks:

1. Emission Level(dBuV/m) = Raw Value(dBuV) + Correction Factor(dB/m)
2. Correction Factor(dB/m) = Antenna Factor(dB/m) + Cable Factor(dB) – Pre-Amplifier Factor(dB)
3. The other emission levels were very low against the limit.
4. Margin value = Emission Level – Limit value
5. The emission levels were very low against the limit of frequency range 9kHz~30MHz: the amplitude of spurious emissions attenuated more than 20dB below the permissible value to be report.

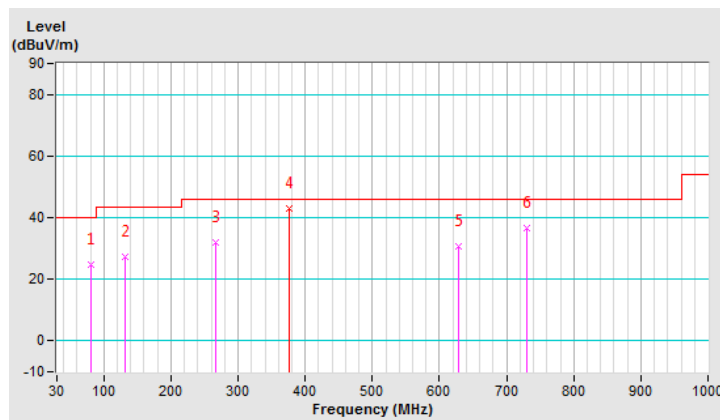

CHANNEL	TX Channel 54	DETECTOR FUNCTION	Quasi-Peak (QP)
FREQUENCY RANGE	9kHz ~ 1GHz		

ANTENNA POLARITY & TEST DISTANCE: VERTICAL AT 3 M

NO.	FREQ. (MHz)	EMISSION LEVEL (dBuV/m)	LIMIT (dBuV/m)	MARGIN (dB)	ANTENNA HEIGHT (m)	TABLE ANGLE (Degree)	RAW VALUE (dBuV)	CORRECTION FACTOR (dB/m)
1	29.52	12.7 QP	40.0	-27.3	1.00 V	63	23.1	-10.4
2	63.74	35.4 QP	40.0	-4.6	1.99 V	237	44.9	-9.5
3	100.29	37.2 QP	43.5	-6.3	1.50 V	147	50.3	-13.1
4	202.91	32.8 QP	43.5	-10.7	1.00 V	36	44.5	-11.7
5	377.23	41.3 QP	46.0	-4.7	1.99 V	204	46.4	-5.1
6	600.75	29.5 QP	46.0	-16.5	1.50 V	260	28.4	1.1

Remarks:

1. Emission Level(dBuV/m) = Raw Value(dBuV) + Correction Factor(dB/m)
2. Correction Factor(dB/m) = Antenna Factor(dB/m) + Cable Factor(dB) – Pre-Amplifier Factor(dB)
3. The other emission levels were very low against the limit.
4. Margin value = Emission Level – Limit value
5. The emission levels were very low against the limit of frequency range 9kHz~30MHz: the amplitude of spurious emissions attenuated more than 20dB below the permissible value to be report.

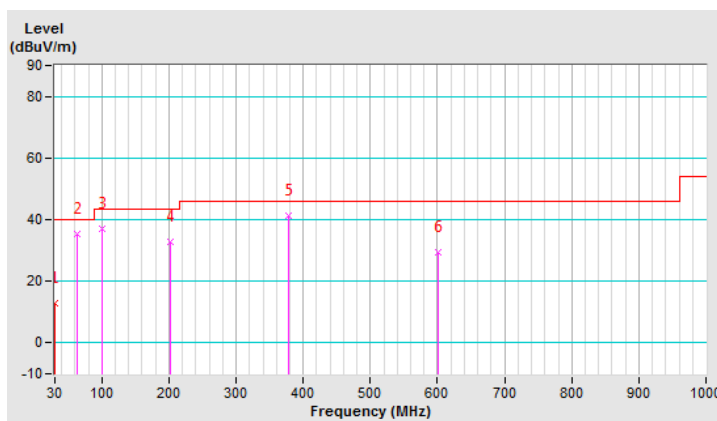

4.2 Conducted Emission Measurement

4.2.1 Limits of Conducted Emission Measurement

Frequency (MHz)	Conducted Limit (dBuV)	
	Quasi-peak	Average
0.15 - 0.5	66 - 56	56 - 46
0.50 - 5.0	56	46
5.0 - 30.0	60	50

Note: 1. The lower limit shall apply at the transition frequencies.

2. The limit decreases in line with the logarithm of the frequency in the range of 0.15 to 0.50MHz.

4.2.2 Test Instruments

Description & Manufacturer	Model No.	Serial No.	Cal. Date	Cal. Due
Test Receiver ROHDE & SCHWARZ	ESCI	100613	Dec. 11, 2019	Dec. 10, 2020
RF signal cable Woken	5D-FB	Cable-cond1-01	Sep. 05, 2019	Sep. 04, 2020
LISN ROHDE & SCHWARZ (EUT)	ENV216	101826	Feb. 21, 2019	Feb. 20, 2020
LISN ROHDE & SCHWARZ (Peripheral)	ESH3-Z5	100311	Aug. 22, 2019	Aug. 21, 2020
Software ADT	BV ADT_Cond_ V7.3.7.4	NA	NA	NA

Note: 1. The calibration interval of the above test instruments is 12 months and the calibrations are traceable to NML/ROC and NIST/USA.

2. The test was performed in HwaYa Shielded Room 1.

3. The VCCI Site Registration No. is C-12040.

4. Tested date: Feb. 12, 2020

4.2.3 Test Procedures

- The EUT was placed 0.4 meters from the conducting wall of the shielded room with EUT being connected to the power mains through a line impedance stabilization network (LISN). Other support units were connected to the power mains through another LISN. The two LISNs provide 50 ohm/ 50uH of coupling impedance for the measuring instrument.
- Both lines of the power mains connected to the EUT were checked for maximum conducted interference.
- The frequency range from 150kHz to 30MHz was searched. Emission levels under (Limit - 20dB) was not recorded.

NOTE: The resolution bandwidth and video bandwidth of test receiver is 9kHz for quasi-peak detection (QP) and average detection (AV) at frequency 0.15MHz-30MHz.

4.2.4 Deviation from Test Standard

No deviation.

4.2.5 Test Setup

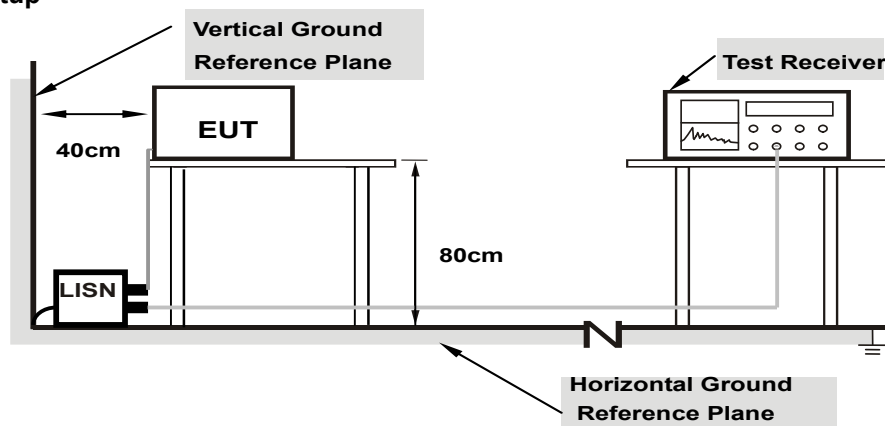

Note: 1.Support units were connected to second LISN.

For the actual test configuration, please refer to the attached file (Test Setup Photo).

4.2.6 EUT Operating Conditions

Same as 4.1.6.

4.2.7 Test Results

Worst-case data:
802.11n (HT40)

Phase	Line (L)	Detector Function	Quasi-Peak (QP) / Average (AV)
-------	----------	-------------------	--------------------------------

No	Freq. [MHz]	Corr. Factor (dB)	Reading Value [dB (uV)]		Emission Level [dB (uV)]		Limit [dB (uV)]		Margin (dB)	
			Q.P.	AV.	Q.P.	AV.	Q.P.	AV.	Q.P.	AV.
			1	0.15000	10.15	31.51	22.37	41.66	32.52	66.00
2	0.18180	10.16	26.91	16.87	37.07	27.03	64.40	54.40	-27.33	-27.37
3	0.47000	10.18	19.46	9.70	29.64	19.88	56.51	46.51	-26.87	-26.63
4	5.23400	10.49	20.66	15.84	31.15	26.33	60.00	50.00	-28.85	-23.67
5	12.96600	10.59	29.60	29.52	40.19	40.11	60.00	50.00	-19.81	-9.89
6	14.87000	10.62	17.71	12.36	28.33	22.98	60.00	50.00	-31.67	-27.02

REMARKS:

1. Q.P. and AV. are abbreviations of quasi-peak and average individually.
2. The emission levels of other frequencies were very low against the limit.
3. Margin value = Emission level - Limit value
4. Correction factor = Insertion loss + Cable loss
5. Emission Level = Correction Factor + Reading Value.

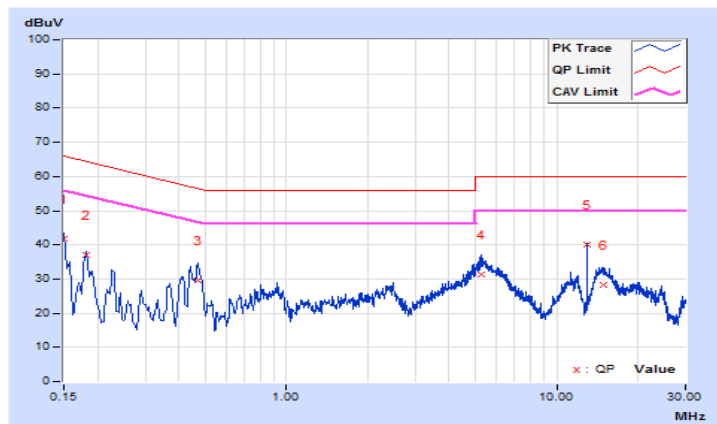

Phase	Neutral (N)	Detector Function	Quasi-Peak (QP) / Average (AV)
-------	-------------	-------------------	--------------------------------

No	Freq. [MHz]	Corr. Factor (dB)	Reading Value [dB (uV)]		Emission Level [dB (uV)]		Limit [dB (uV)]		Margin (dB)	
			Q.P.	AV.	Q.P.	AV.	Q.P.	AV.	Q.P.	AV.
			1	0.15770	10.13	20.87	9.52	31.00	19.65	65.58
2	0.22565	10.14	21.16	12.62	31.30	22.76	62.61	52.61	-31.31	-29.85
3	0.44600	10.18	21.45	16.98	31.63	27.16	56.95	46.95	-25.32	-19.79
4	5.43000	10.48	21.94	16.98	32.42	27.46	60.00	50.00	-27.58	-22.54
5	12.96200	10.62	30.02	28.92	40.64	39.54	60.00	50.00	-19.36	-10.46
6	14.58200	10.67	19.10	15.63	29.77	26.30	60.00	50.00	-30.23	-23.70

REMARKS:

1. Q.P. and AV. are abbreviations of quasi-peak and average individually.
2. The emission levels of other frequencies were very low against the limit.
3. Margin value = Emission level - Limit value
4. Correction factor = Insertion loss + Cable loss
5. Emission Level = Correction Factor + Reading Value.

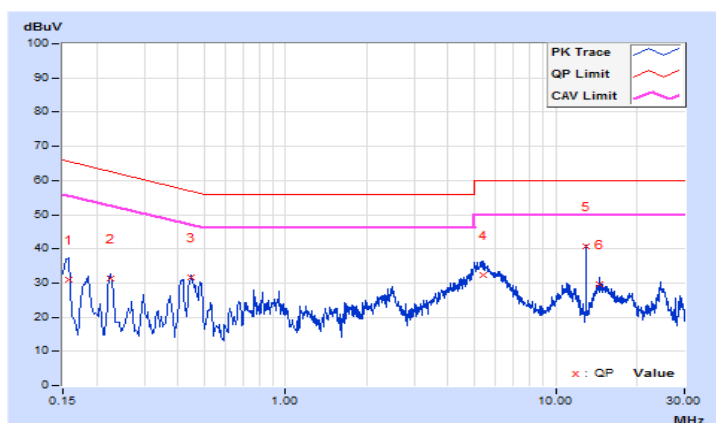

4.3 Transmit Power Measurement

4.3.1 Limits of Transmit Power Measurement

Operation Band	EUT Category		LIMIT
U-NII-1	-	Outdoor Access Point	1 Watt (30 dBm) (Max. e.i.r.p \leq 125mW(21 dBm) at any elevation angle above 30 degrees as measured from the horizon)
	-	Fixed point-to-point Access Point	1 Watt (30 dBm)
	-	Indoor Access Point	1 Watt (30 dBm)
	-	Mobile and Portable client device	250mW (24 dBm)
U-NII-2A	√		250mW (24 dBm) or 11 dBm+10 log B*
U-NII-2C	√		250mW (24 dBm) or 11 dBm+10 log B*
U-NII-3	-		1 Watt (30 dBm)

*B is the 26 dB emission bandwidth in megahertz

Per KDB 662911 Method of conducted output power measurement on IEEE 802.11 devices,

Array Gain = 0 dB (i.e., no array gain) for $N_{ANT} \leq 4$;

Array Gain = 0 dB (i.e., no array gain) for channel widths ≥ 40 MHz for any N_{ANT} ;

Array Gain = $5 \log(N_{ANT}/N_{SS})$ dB or 3 dB, whichever is less for 20-MHz channel widths with $N_{ANT} \geq 5$.

For power measurements on all other devices: Array Gain = $10 \log(N_{ANT}/N_{SS})$ dB.

4.3.2 Test Setup

For Power Output

802.11a, 802.11n (HT20), 802.11n (HT40)

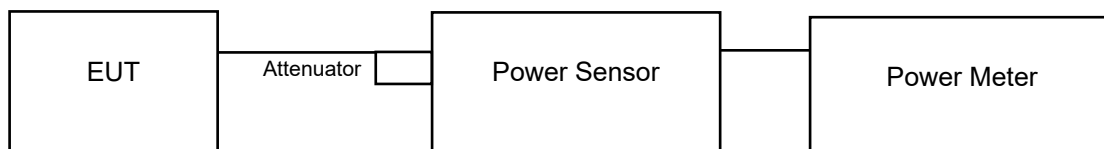

802.11ac (VHT80)

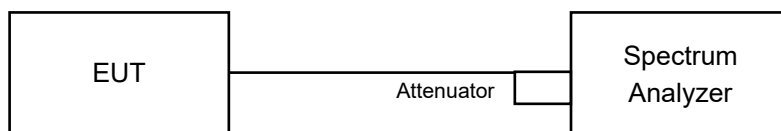

For 26dB Bandwidth

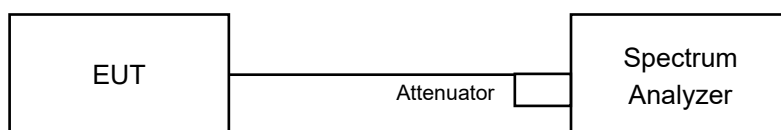

4.3.3 Test Instruments

Refer to section 4.1.2 to get information of above instrument.

4.3.4 Test Procedure

For Average Power Measurement

For 802.11a, 802.11n (HT20), 802.11n (HT40)

Method PM is used to perform output power measurement, trigger and gating function of wide band power meter is enabled to measure max output power of TX on burst. Duty factor is not added to measured value.

For 802.11ac (VHT80)

- a. Set span to encompass the entire 26 dB EBW (or, alternatively, the entire 99% occupied bandwidth) of the signal.
- b. Set sweep trigger to "free run".
- c. Set RBW = 1 MHz
- d. Set VBW \geq 3 MHz
- e. Number of points in sweep \geq 2 Span / RBW
- f. Sweep time \leq (number of points in sweep) * T
- g. Using emission bandwidth to determine the frequency span for integration the channel bandwidth.
- h. Detector = RMS
- i. Trace mode = max hold
- j. Allow max hold to run for at least 60 seconds, or longer as needed to allow the trace to stabilize.
- k. Compute power by integrating the spectrum across the EBW (or, alternatively, the entire 99% occupied bandwidth) of the signal using the instrument's band power measurement function with band limits set equal to the EBW (or occupied bandwidth) band edges. If the instrument does not have a band power function, sum the spectrum levels (in power units) at 1 MHz intervals extending across the EBW (or, alternatively, the entire 99% occupied bandwidth) of the spectrum.

For 26dB Bandwidth

- a. Set RBW = approximately 1% of the emission bandwidth.
- b. Set the VBW > RBW.
- c. Detector = Peak.
- d. Trace mode = max hold.
- e. Measure the maximum width of the emission that is 26 dB down from the peak of the emission. Compare this with the RBW setting of the analyzer. Readjust RBW and repeat measurement as needed until the RBW/EBW ratio is approximately 1%.

4.3.5 Deviation from Test Standard

No deviation.

4.3.6 EUT Operating Conditions

The software provided by client to enable the EUT under transmission condition continuously at lowest, middle and highest channel frequencies individually.

4.3.7 Test Result

Power Output:

CDD Mode

For U-NII-2A, U-NII-2C Band

802.11a

Chan.	Freq. (MHz)	Maximum Conducted Power (dBm)		Total Power (mW)	Total Power (dBm)	Power Limit (dBm)	Pass / Fail
		Chain 0	Chain 1				
52	5260	17.52	17.38	111.195	20.46	24.00	Pass
60	5300	17.24	16.92	102.17	20.09	24.00	Pass
64	5320	17.92	17.65	120.154	20.80	23.88	Pass
100	5500	17.95	17.58	119.653	20.78	23.87	Pass
116	5580	17.92	17.38	116.646	20.67	24.00	Pass
140	5700	15.61	16.92	85.595	19.32	24.00	Pass

Note:

For U-NII-2A, U-NII-2C Band:

Chain 0

1. $11\text{dBm} + 10\log(20.39) = 24.09 > 24\text{dBm}$
2. $11\text{dBm} + 10\log(20.72) = 24.16 > 24\text{dBm}$
3. $11\text{dBm} + 10\log(19.42) = 23.88 < 24\text{dBm}$
4. $11\text{dBm} + 10\log(19.37) = 23.87 < 24\text{dBm}$
5. $11\text{dBm} + 10\log(24.45) = 24.88 > 24\text{dBm}$
6. $11\text{dBm} + 10\log(20.21) = 24.05 > 24\text{dBm}$

Chain 1

1. $11\text{dBm} + 10\log(22.13) = 24.44 > 24\text{dBm}$
2. $11\text{dBm} + 10\log(22.23) = 24.46 > 24\text{dBm}$
3. $11\text{dBm} + 10\log(22.17) = 24.45 > 24\text{dBm}$
4. $11\text{dBm} + 10\log(29.19) = 25.65 > 24\text{dBm}$
5. $11\text{dBm} + 10\log(28.03) = 25.47 > 24\text{dBm}$
6. $11\text{dBm} + 10\log(24.47) = 24.88 > 24\text{dBm}$

802.11n (HT20)

Chan.	Freq. (MHz)	Maximum Conducted Power (dBm)		Total Power (mW)	Total Power (dBm)	Power Limit (dBm)	Pass / Fail
		Chain 0	Chain 1				
52	5260	17.33	17.77	113.917	20.57	24.00	Pass
60	5300	18.33	18.47	138.384	21.41	24.00	Pass
64	5320	17.55	17.68	115.499	20.63	24.00	Pass
100	5500	16.92	17.85	110.158	20.42	24.00	Pass
116	5580	18.71	17.61	131.979	21.21	24.00	Pass
140	5700	15.56	15.92	75.059	18.75	24.00	Pass

Note:

For U-NII-2A, U-NII-2C Band:

Chain 0

1. $11\text{dBm} + 10\log(27.98) = 25.46 > 24\text{dBm}$
2. $11\text{dBm} + 10\log(29.72) = 25.73 > 24\text{dBm}$
3. $11\text{dBm} + 10\log(21.83) = 24.39 > 24\text{dBm}$
4. $11\text{dBm} + 10\log(20.63) = 24.14 > 24\text{dBm}$
5. $11\text{dBm} + 10\log(23.69) = 24.74 > 24\text{dBm}$
6. $11\text{dBm} + 10\log(20.41) = 24.09 > 24\text{dBm}$

Chain 1

1. $11\text{dBm} + 10\log(26.22) = 25.18 > 24\text{dBm}$
2. $11\text{dBm} + 10\log(35.93) = 26.55 > 24\text{dBm}$
3. $11\text{dBm} + 10\log(21.98) = 24.42 > 24\text{dBm}$
4. $11\text{dBm} + 10\log(21.58) = 24.34 > 24\text{dBm}$
5. $11\text{dBm} + 10\log(36.67) = 26.64 > 24\text{dBm}$
6. $11\text{dBm} + 10\log(25.63) = 25.08 > 24\text{dBm}$

802.11n (HT40)

Chan.	Freq. (MHz)	Maximum Conducted Power (dBm)		Total Power (mW)	Total Power (dBm)	Power Limit (dBm)	Pass / Fail
		Chain 0	Chain 1				
54	5270	20.12	20.03	203.495	23.09	24.00	Pass
62	5310	16.62	16.69	92.586	19.67	24.00	Pass
102	5510	15.14	16.43	76.613	18.84	24.00	Pass
110	5550	19.47	20.12	191.313	22.82	24.00	Pass
134	5670	16.56	17.25	98.378	19.93	24.00	Pass

Note:

For U-NII-2A, U-NII-2C Band:

Chain 0

- $11\text{dBm} + 10\log(78.37) = 29.94 > 24\text{dBm}$
- $11\text{dBm} + 10\log(40.72) = 27.09 > 24\text{dBm}$
- $11\text{dBm} + 10\log(40.62) = 27.08 > 24\text{dBm}$
- $11\text{dBm} + 10\log(73.02) = 29.63 > 24\text{dBm}$
- $11\text{dBm} + 10\log(40.97) = 27.12 > 24\text{dBm}$

Chain 1

- $11\text{dBm} + 10\log(91.98) = 30.63 > 24\text{dBm}$
- $11\text{dBm} + 10\log(41.13) = 27.14 > 24\text{dBm}$
- $11\text{dBm} + 10\log(40.88) = 27.11 > 24\text{dBm}$
- $11\text{dBm} + 10\log(86.92) = 30.39 > 24\text{dBm}$
- $11\text{dBm} + 10\log(39.91) = 27.01 > 24\text{dBm}$

802.11ac (VHT80)

Chan.	Freq. (MHz)	Maximum Conducted Power (dBm)		Total Power (mW)	Total Power (dBm)	Power Limit (dBm)	Pass / Fail
		Chain 0	Chain 1				
58	5290	14.82	14.52	58.653	17.68	24.00	Pass
106	5530	14.03	14.82	55.632	17.45	24.00	Pass
122	5610	15.35	16.01	74.179	18.70	24.00	Pass

Note:

For U-NII-2A, U-NII-2C Band:

Chain 0

- $11\text{dBm} + 10\log(80.57) = 30.06 > 24\text{dBm}$
- $11\text{dBm} + 10\log(80.59) = 30.06 > 24\text{dBm}$
- $11\text{dBm} + 10\log(124.19) = 31.94 > 24\text{dBm}$

Chain 1

- $11\text{dBm} + 10\log(80.78) = 30.07 > 24\text{dBm}$
- $11\text{dBm} + 10\log(80.62) = 30.06 > 24\text{dBm}$
- $11\text{dBm} + 10\log(166.40) = 33.21 > 24\text{dBm}$

Beamforming Mode

For U-NII-2A, U-NII-2C Band

802.11n (HT20)

Chan.	Freq. (MHz)	Maximum Conducted Power (dBm)		Total Power (mW)	Total Power (dBm)	Power Limit (dBm)	Pass / Fail
		Chain 0	Chain 1				
52	5260	17.33	17.77	113.917	20.57	21.14	Pass
60	5300	17.81	17.95	122.768	20.89	21.14	Pass
64	5320	17.55	17.68	115.499	20.63	21.14	Pass
100	5500	16.92	17.85	110.158	20.42	21.14	Pass
116	5580	18.13	17.02	115.363	20.62	21.14	Pass
140	5700	15.56	15.92	75.059	18.75	21.14	Pass

Note: Beamforming Gain = $5.85 + 10\log(2) = 8.86\text{dBi} > 6\text{dBi}$, so the limit shall be reduced to $24 - (8.86 - 6) = 21.14\text{dBm}$.

For U-NII-2A, U-NII-2C Band:

Chain 0

1. $11\text{dBm} + 10\log(27.98) = 25.46 > 24\text{dBm}$
2. $11\text{dBm} + 10\log(29.72) = 25.73 > 24\text{dBm}$
3. $11\text{dBm} + 10\log(21.83) = 24.39 > 24\text{dBm}$
4. $11\text{dBm} + 10\log(20.63) = 24.14 > 24\text{dBm}$
5. $11\text{dBm} + 10\log(23.69) = 24.74 > 24\text{dBm}$
6. $11\text{dBm} + 10\log(20.41) = 24.09 > 24\text{dBm}$

#NUM!

Chain 1

1. $11\text{dBm} + 10\log(26.22) = 25.18 > 24\text{dBm}$
2. $11\text{dBm} + 10\log(35.93) = 26.55 > 24\text{dBm}$
3. $11\text{dBm} + 10\log(21.98) = 24.42 > 24\text{dBm}$
4. $11\text{dBm} + 10\log(21.58) = 24.34 > 24\text{dBm}$
5. $11\text{dBm} + 10\log(36.67) = 26.64 > 24\text{dBm}$
6. $11\text{dBm} + 10\log(25.63) = 25.08 > 24\text{dBm}$

802.11n (HT40)

Chan.	Freq. (MHz)	Maximum Conducted Power (dBm)		Total Power (mW)	Total Power (dBm)	Power Limit (dBm)	Pass / Fail
		Chain 0	Chain 1				
54	5270	18.08	18.01	127.510	21.06	21.14	Pass
62	5310	16.62	16.69	92.586	19.67	21.14	Pass
102	5510	15.14	16.43	76.613	18.84	21.14	Pass
110	5550	17.45	18.11	120.305	20.80	21.14	Pass
134	5670	16.56	17.25	98.378	19.93	21.14	Pass

Note: Beamforming Gain = $5.85 + 10\log(2) = 8.86\text{dBi} > 6\text{dBi}$, so the limit shall be reduced to $24 - (8.86 - 6) = 21.14\text{dBm}$.

For U-NII-2A, U-NII-2C Band:

Chain 0

1. $11\text{dBm} + 10\log(78.89) = 29.97 > 24\text{dBm}$
2. $11\text{dBm} + 10\log(40.65) = 27.09 > 24\text{dBm}$
3. $11\text{dBm} + 10\log(40.63) = 27.08 > 24\text{dBm}$
4. $11\text{dBm} + 10\log(74.58) = 29.72 > 24\text{dBm}$
5. $11\text{dBm} + 10\log(40.79) = 27.10 > 24\text{dBm}$

Chain 1

1. $11\text{dBm} + 10\log(79.06) = 29.97 > 24\text{dBm}$
2. $11\text{dBm} + 10\log(40.96) = 27.12 > 24\text{dBm}$
3. $11\text{dBm} + 10\log(40.98) = 27.12 > 24\text{dBm}$
4. $11\text{dBm} + 10\log(74.12) = 29.69 > 24\text{dBm}$
5. $11\text{dBm} + 10\log(41.25) = 27.15 > 24\text{dBm}$

802.11ac (VHT80)

Chan.	Freq. (MHz)	Maximum Conducted Power (dBm)		Total Power (mW)	Total Power (dBm)	Power Limit (dBm)	Pass / Fail
		Chain 0	Chain 1				
58	5290	14.82	14.52	58.653	17.68	21.14	Pass
106	5530	14.03	14.82	55.632	17.45	21.14	Pass
122	5610	15.35	16.01	74.179	18.70	21.14	Pass

Note: Beamforming Gain = $5.85 + 10\log(2) = 8.86\text{dBi} > 6\text{dBi}$, so the limit shall be reduced to $24 - (8.86 - 6) = 21.14\text{dBm}$.

For U-NII-2A, U-NII-2C Band:

Chain 0

1. $11\text{dBm} + 10\log(83.84) = 30.23 > 24\text{dBm}$
2. $11\text{dBm} + 10\log(83.67) = 30.22 > 24\text{dBm}$
3. $11\text{dBm} + 10\log(83.60) = 30.22 > 24\text{dBm}$

Chain 1

1. $11\text{dBm} + 10\log(83.68) = 30.22 > 24\text{dBm}$
2. $11\text{dBm} + 10\log(83.64) = 30.22 > 24\text{dBm}$
3. $11\text{dBm} + 10\log(83.84) = 30.23 > 24\text{dBm}$

26dB Bandwidth:

802.11a

Chan.	Freq. (MHz)	26dBc Bandwidth (MHz)	
		Chain 0	Chain 1
52	5260	20.39	22.13
60	5300	20.72	22.23
64	5320	19.42	22.17
100	5500	19.37	29.19
116	5580	24.45	28.03
140	5700	20.21	24.47

802.11n (HT20)

Chan.	Freq. (MHz)	26dBc Bandwidth (MHz)	
		Chain 0	Chain 1
52	5260	27.98	26.22
60	5300	29.72	35.93
64	5320	21.83	21.98
100	5500	20.63	21.58
116	5580	23.69	36.67
140	5700	20.41	25.63

802.11n (HT40)

Chan.	Freq. (MHz)	26dBc Bandwidth (MHz)	
		Chain 0	Chain 1
54	5270	78.37	91.98
62	5310	40.72	41.13
102	5510	40.62	40.88
110	5550	73.02	86.92
134	5670	40.97	39.91

802.11ac (VHT80)

Chan.	Freq. (MHz)	26dBc Bandwidth (MHz)	
		Chain 0	Chain 1
58	5290	80.57	80.78
106	5530	80.59	80.62
122	5610	124.19	166.40

Spectrum Plot of Worst Value

802.11a

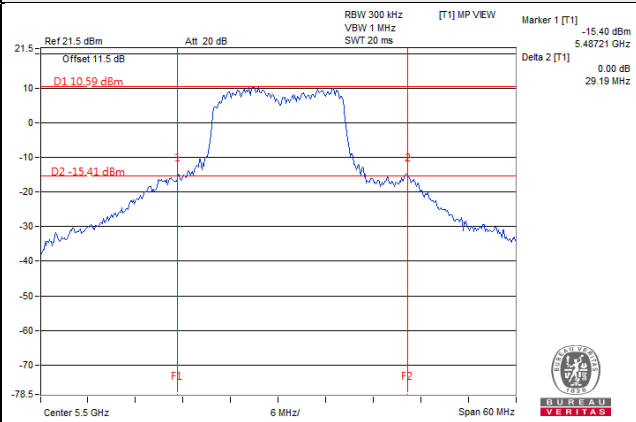

802.11n (HT20)

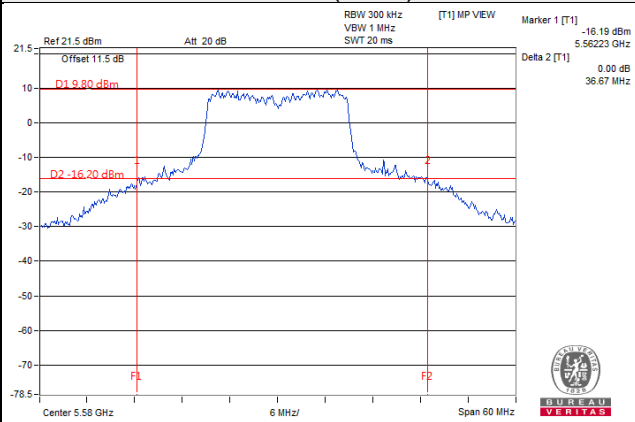

802.11n (HT40)

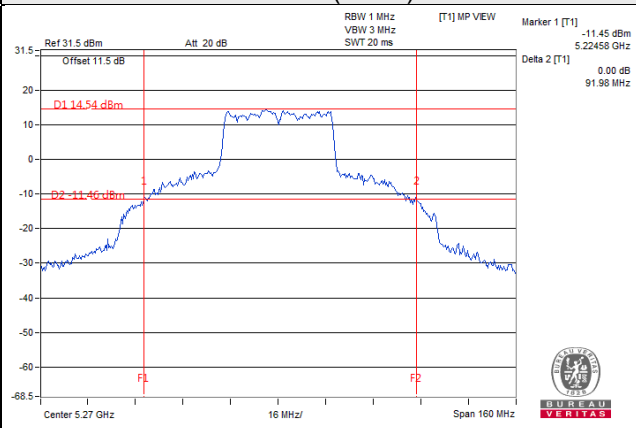

802.11ac (VHT80)

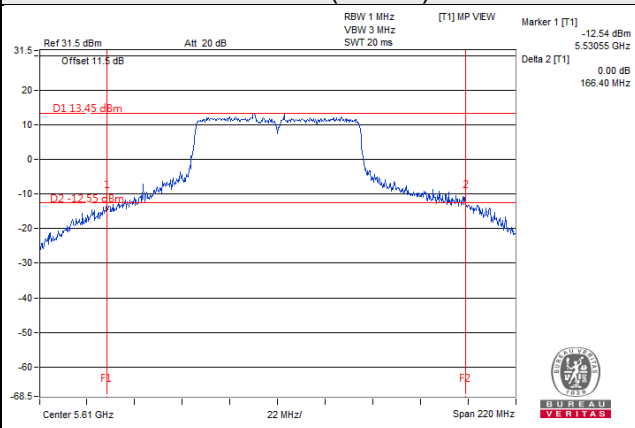

EUT Maximum Conducted Power

CDD Mode

802.11a

Frequency Band (MHz)	Max. Power	
	Output Power (mW)	Output Power (dBm)
5250~5350	120.154	20.80
5470~5725	119.653	20.78

Note: Manufacturer provides Transmit Power Control description to meet this requirement.

802.11n (HT20)

Frequency Band (MHz)	Max. Power	
	Output Power (mW)	Output Power (dBm)
5250~5350	138.384	21.41
5470~5725	131.979	21.21

Note: Manufacturer provides Transmit Power Control description to meet this requirement.

802.11n (HT40)

Frequency Band (MHz)	Max. Power	
	Output Power (mW)	Output Power (dBm)
5250~5350	203.495	23.09
5470~5725	191.313	22.82

Note: Manufacturer provides Transmit Power Control description to meet this requirement.

802.11ac (VHT80)

Frequency Band (MHz)	Max. Power	
	Output Power (mW)	Output Power (dBm)
5250~5350	58.653	17.68
5470~5725	74.179	18.70

Note: Manufacturer provides Transmit Power Control description to meet this requirement.

Beamforming Mode

802.11n (HT20)

Frequency Band (MHz)	Max. Power	
	Output Power (mW)	Output Power (dBm)
5250~5350	122.768	20.89
5470~5725	115.363	20.62

Note: Manufacturer provides Transmit Power Control description to meet this requirement.

802.11n (HT40)

Frequency Band (MHz)	Max. Power	
	Output Power (mW)	Output Power (dBm)
5250~5350	127.510	21.06
5470~5725	120.305	20.80

Note: Manufacturer provides Transmit Power Control description to meet this requirement.

802.11ac (VHT80)

Frequency Band (MHz)	Max. Power	
	Output Power (mW)	Output Power (dBm)
5250~5350	58.653	17.68
5470~5725	74.179	18.70

Note: Manufacturer provides Transmit Power Control description to meet this requirement.

4.4 Occupied Bandwidth Measurement

4.4.1 Test Setup

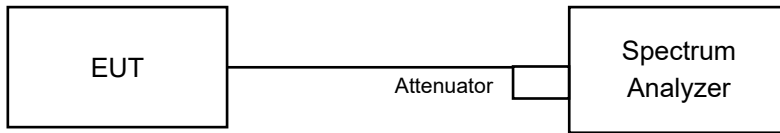

4.4.2 Test Instruments

Refer to section 4.1.2 to get information of above instrument.

4.4.3 Test Procedure

The transmitter output was connected to the spectrum analyzer through an attenuator. The bandwidth of the fundamental frequency was measured by spectrum analyzer with resolution bandwidth in the range of 1% to 5% of the anticipated emission bandwidth, and a video bandwidth at least 3x the resolution bandwidth and set the detector to sampling. The width of a frequency band such that, below the lower and above the upper frequency limits, the mean powers emitted are each equal to a specified percentage 0.5 % of the total mean power of a given emission.

4.4.4 Test Result

802.11a

Chan.	Freq. (MHz)	Occupied Bandwidth (MHz)	
		Chain 0	Chain 1
52	5260	16.52	16.70
60	5300	16.56	16.68
64	5320	16.44	16.56
100	5500	16.44	16.68
116	5580	16.80	16.80
140	5700	16.56	16.43

802.11n (HT20)

Chan.	Freq. (MHz)	Occupied Bandwidth (MHz)	
		Chain 0	Chain 1
52	5260	18.00	18.09
60	5300	18.24	18.72
64	5320	17.76	17.76
100	5500	17.76	17.76
116	5580	17.88	18.48
140	5700	17.64	18.87

802.11n (HT40)

Chan.	Freq. (MHz)	Occupied Bandwidth (MHz)	
		Chain 0	Chain 1
54	5270	36.72	39.48
62	5310	36.12	36.48
102	5510	36.00	36.36
110	5550	36.48	41.16
134	5670	36.36	35.76

802.11ac (VHT80)

Chan.	Freq. (MHz)	Occupied Bandwidth (MHz)	
		Chain 0	Chain 1
58	5290	75.36	75.84
106	5530	75.60	75.36
122	5610	75.60	75.36

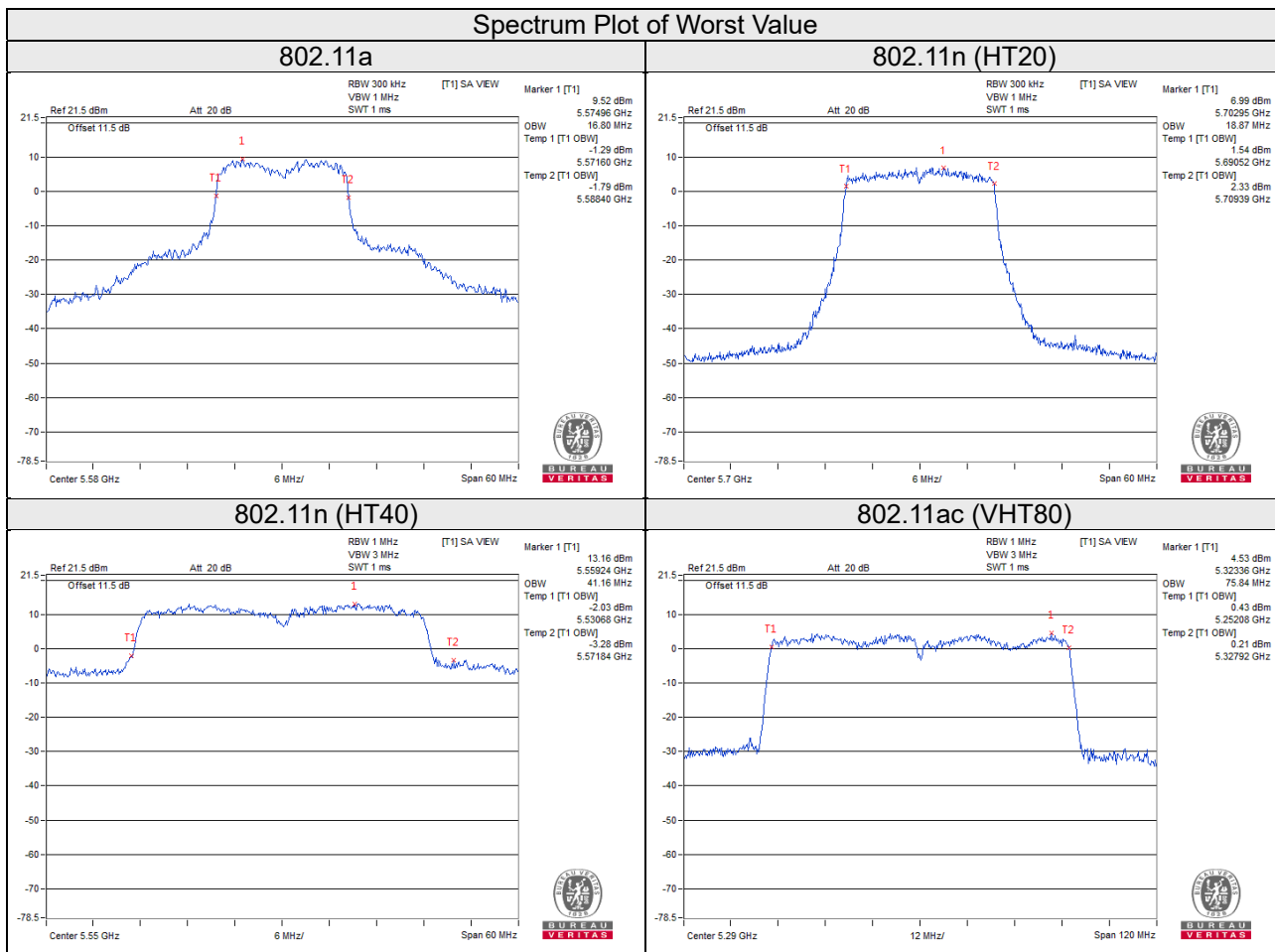

4.5 Peak Power Spectral Density Measurement

4.5.1 Limits of Peak Power Spectral Density Measurement

Operation Band	EUT Category		LIMIT
U-NII-1	-	Outdoor Access Point	17dBm/ MHz
	-	Fixed point-to-point Access Point	
	-	Indoor Access Point	
	-	Mobile and Portable client device	11dBm/ MHz
U-NII-2A	√		11dBm/ MHz
U-NII-2C	√		11dBm/ MHz
U-NII-3	-		30dBm/ 500kHz

4.5.2 Test Setup

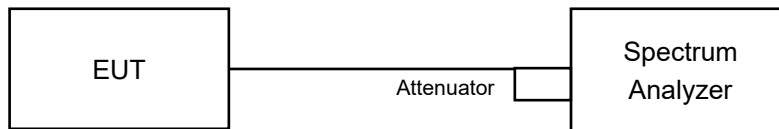

4.5.3 Test Instruments

Refer to section 4.1.2 to get information of above instrument.

4.5.4 Test Procedures

For U-NII-2A, U-NII-2C band:

Duty cycle of test signal is < 98%

Using method SA-2

- 1) Set span to encompass the entire emission bandwidth (EBW) of the signal.
- 2) Set RBW = 1MHz, Set VBW \geq 3 MHz, Detector = RMS.
- 3) Set Channel power measure = 1MHz.
- 4) Sweep time = auto, trigger set to "free run".
- 5) Trace average at least 100 traces in power averaging mode.
- 6) Record the max value and add $10 \log (1/\text{duty cycle})$.

For U-NII-3 band:

Duty cycle <98%

- 1) Set span to encompass the entire emission bandwidth (EBW) of the signal.
- 2) Set RBW = 300 kHz, Set VBW \geq 1 MHz, Detector = RMS
- 3) Use the peak marker function to determine the maximum power level in any 300 kHz band segment within the fundamental EBW.
- 4) Scale the observed power level to an equivalent value in 500 kHz by adjusting (reducing) the measured power by a bandwidth correction factor (BWCF) where $BWCF = 10\log(500 \text{ kHz}/300\text{kHz})$
- 5) Sweep time = auto, trigger set to "free run".
- 6) Trace average at least 100 traces in power averaging mode.
- 7) Record the max value and add $10 \log (1/\text{duty cycle})$

4.5.5 Deviation from Test Standard

No deviation.

4.5.6 EUT Operating Conditions

Same as 4.3.6.

4.5.7 Test Results

For U-NII-2A, U-NII-2C band

802.11a

Chan.	Frequency (MHz)	PSD w/o Duty Factor (dBm/MHz)		Duty Factor (dB)	Total PSD With Duty Factor (dBm/MHz)	Maximum Limit (dBm/MHz)	Pass / Fail
		Chain 0	Chain 1				
52	5260	3.90	5.21	0.16	7.77	8.14	Pass
60	5300	3.35	5.46	0.16	7.70	8.14	Pass
64	5320	3.50	3.73	0.16	6.79	8.14	Pass
100	5500	4.24	5.43	0.16	8.05	8.14	Pass
116	5580	4.03	5.30	0.16	7.88	8.14	Pass
140	5700	0.63	-0.67	0.16	3.20	8.14	Pass

Note:

- Method E) 2) a) of power density measurement of KDB 662911 is using for calculating total power density. Total power density is summing entire spectra across corresponding frequency bins on the various outputs by computer.
- For U-NII-2A, U-NII-2C:** Directional gain = $5.85\text{dBi} + 10\log(2) = 8.86\text{dBi} > 6\text{dBi}$, so the limit shall be reduced to $11 - (8.86 - 6) = 8.14\text{dBm}$.
- Refer to section 3.3 for duty cycle spectrum plot.

802.11n (HT20)

Chan.	Frequency (MHz)	PSD w/o Duty Factor (dBm/MHz)		Duty Factor (dB)	Total PSD With Duty Factor (dBm/MHz)	Maximum Limit (dBm/MHz)	Pass / Fail
		Chain 0	Chain 1				
52	5260	2.44	4.27	0.40	6.86	8.14	Pass
60	5300	3.92	4.87	0.40	7.83	8.14	Pass
64	5320	2.58	3.50	0.40	6.47	8.14	Pass
100	5500	2.15	4.07	0.40	6.63	8.14	Pass
116	5580	4.63	4.56	0.40	8.01	8.14	Pass
140	5700	-0.97	0.50	0.40	3.24	8.14	Pass

Note:

- Method E) 2) a) of power density measurement of KDB 662911 is using for calculating total power density. Total power density is summing entire spectra across corresponding frequency bins on the various outputs by computer.
- For U-NII-2A, U-NII-2C:** Directional gain = $5.85\text{dBi} + 10\log(2) = 8.86\text{dBi} > 6\text{dBi}$, so the limit shall be reduced to $11 - (8.86 - 6) = 8.14\text{dBm}$.
- Refer to section 3.3 for duty cycle spectrum plot.

802.11n (HT40)

Chan.	Frequency (MHz)	PSD w/o Duty Factor (dBm/MHz) PSD (dBm/MHz)		Duty Factor (dB)	Total PSD With Duty Factor (dBm/MHz)	Maximum Limit (dBm/MHz)	Pass / Fail
		Chain 0	Chain 1				
54	5270	1.86	2.15	0.18	5.20	8.14	Pass
62	5310	-1.88	-1.84	0.18	1.33	8.14	Pass
102	5510	-2.51	-3.19	0.18	0.35	8.14	Pass
110	5550	1.44	1.26	0.18	4.54	8.14	Pass
134	5670	-2.18	-2.86	0.18	0.68	8.14	Pass

Note:

- Method E) 2) a) of power density measurement of KDB 662911 is using for calculating total power density. Total power density is summing entire spectra across corresponding frequency bins on the various outputs by computer.
- For U-NII-2A, U-NII-2C:** Directional gain = $5.85\text{dBi} + 10\log(2) = 8.86\text{dBi} > 6\text{dBi}$, so the limit shall be reduced to $11 - (8.86 - 6) = 8.14\text{dBm}$.
- Refer to section 3.3 for duty cycle spectrum plot.

802.11ac (VHT80)

Chan.	Frequency (MHz)	PSD w/o Duty Factor (dBm/MHz)		Duty Factor (dB)	Total PSD With Duty Factor (dBm/MHz)	Maximum Limit (dBm/MHz)	Pass / Fail
		Chain 0	Chain 1				
58	5290	-7.09	-9.54	0.59	-4.54	8.14	Pass
106	5530	-10.91	-8.82	0.59	-6.14	8.14	Pass
122	5610	-8.76	-8.66	0.59	-5.11	8.14	Pass

Note:

- Method E) 2) a) of power density measurement of KDB 662911 is using for calculating total power density. Total power density is summing entire spectra across corresponding frequency bins on the various outputs by computer.
- For U-NII-2A, U-NII-2C:** Directional gain = $5.85\text{dBi} + 10\log(2) = 8.86\text{dBi} > 6\text{dBi}$, so the limit shall be reduced to $11 - (8.86 - 6) = 8.14\text{dBm}$.
- Refer to section 3.3 for duty cycle spectrum plot.

Spectrum Plot of Worst Value

802.11a / Chain 1 / Ch 60

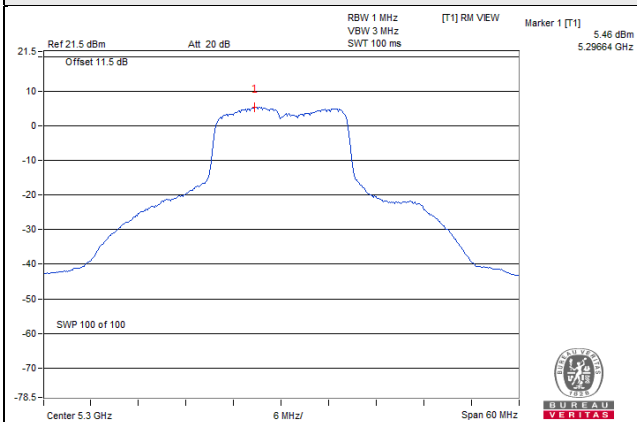

802.11n (HT20) / Chain 1 / Ch 60

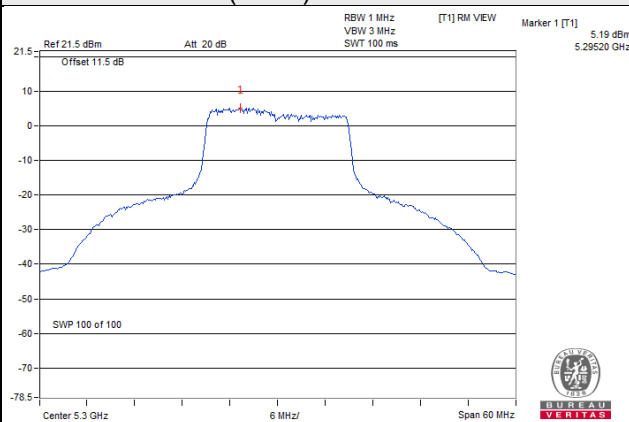

802.11n (HT40) / Chain 1 / Ch 54

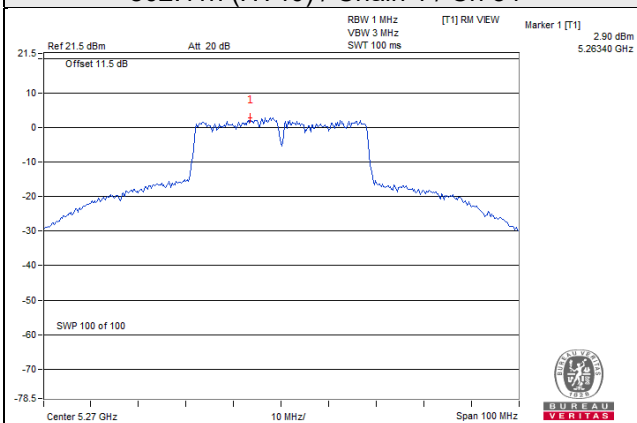

802.11ac (VHT80) / Chain 1 / Ch 58

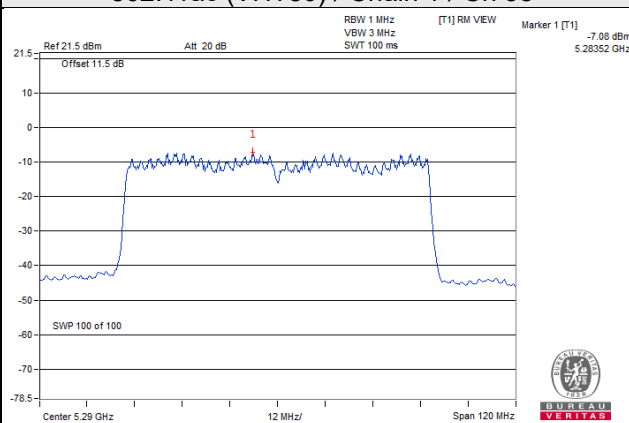

4.6 Frequency Stability

4.6.1 Limits of Frequency Stability Measurement

The frequency of the carrier signal shall be maintained within band of operation

4.6.2 Test Setup

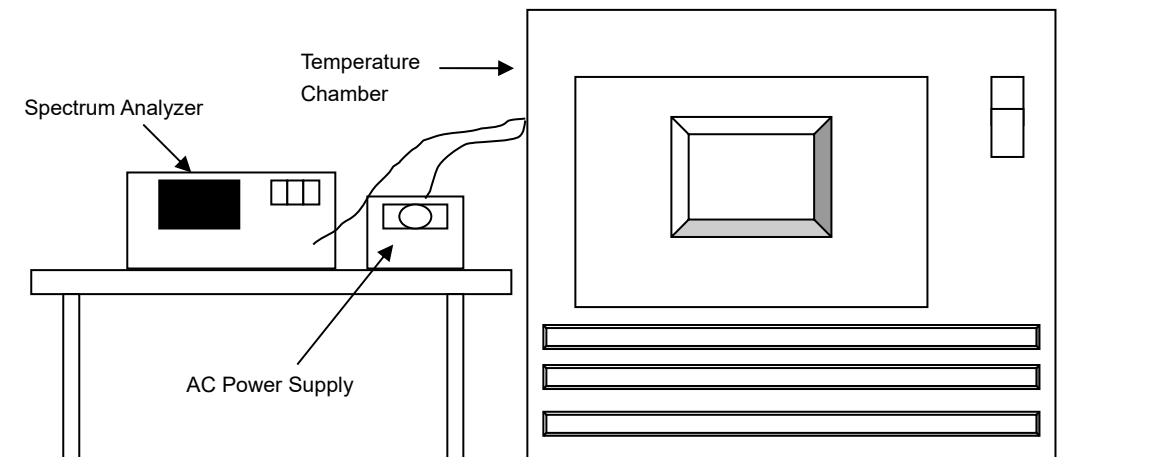

4.6.3 Test Instruments

Description & Manufacturer	Model No.	Serial No.	Cal. Date	Cal. Due
Spectrum Analyzer ROHDE & SCHWARZ	FSP40	100039	Jun. 12, 2019	Jun. 11, 2020
WIT Standard Temperature And Humidity Chamber	TH-4S-C	W981030	Jun. 03, 2019	Jun. 02, 2020
Digital Multimeter Fluke	87-III	70360742	Jun. 27, 2019	Jun. 26, 2020
AC Power Supply Exttech	CFW-105	E000603	NA	NA

4.6.4 Test Procedure

- The EUT was placed inside the environmental test chamber and powered by nominal AC voltage.
- Turn the EUT on and couple its output to a spectrum analyzer.
- Turn the EUT off and set the chamber to the highest temperature specified.
- Allow sufficient time (approximately 30 min) for the temperature of the chamber to stabilize, turn the EUT on and measure the operating frequency after 2, 5, and 10 minutes.
- Repeat step (d) with the temperature chamber set to the next desired temperature until measurements down to the lowest specified temperature have been completed.
- The test chamber was allowed to stabilize at +20 degree C for a minimum of 30 minutes. The supply voltage was then adjusted on the EUT from 85% to 115% and the frequency record.

4.6.5 Deviation from Test Standard

No deviation.

4.6.6 EUT Operating Condition

Set the EUT transmit at un-modulation mode to test frequency stability.

4.6.7 Test Results

Frequency Stability Versus Temp.									
Operating Frequency: 5260MHz									
Temp. (°C)	Power Supply (Vac)	0 Minute		2 Minute		5 Minute		10 Minute	
		Measured Frequency (MHz)	Result	Measured Frequency (MHz)	Result	Measured Frequency (MHz)	Result	Measured Frequency (MHz)	Result
40	120	5260.0012	Pass	5260.0054	Pass	5260.0048	Pass	5260.0003	Pass
30	120	5259.9788	Pass	5259.9778	Pass	5259.9754	Pass	5259.9775	Pass
20	120	5259.9994	Pass	5259.9975	Pass	5259.9991	Pass	5260.0025	Pass
10	120	5260.0155	Pass	5260.016	Pass	5260.0127	Pass	5260.0149	Pass
0	120	5259.9961	Pass	5259.9956	Pass	5259.9962	Pass	5259.9955	Pass

Frequency Stability Versus Voltage									
Operating Frequency: 5260MHz									
Temp. (°C)	Power Supply (Vac)	0 Minute		2 Minute		5 Minute		10 Minute	
		Measured Frequency (MHz)	Result	Measured Frequency (MHz)	Result	Measured Frequency (MHz)	Result	Measured Frequency (MHz)	Result
20	138	5259.9988	Pass	5259.9975	Pass	5259.9997	Pass	5260.0026	Pass
	120	5259.9994	Pass	5259.9975	Pass	5259.9991	Pass	5260.0025	Pass
	102	5260.0000	Pass	5259.9980	Pass	5259.9990	Pass	5260.0029	Pass

5 Pictures of Test Arrangements

Please refer to the attached file (Test Setup Photo).

Annex A- Band Edge Measurement

802.11a

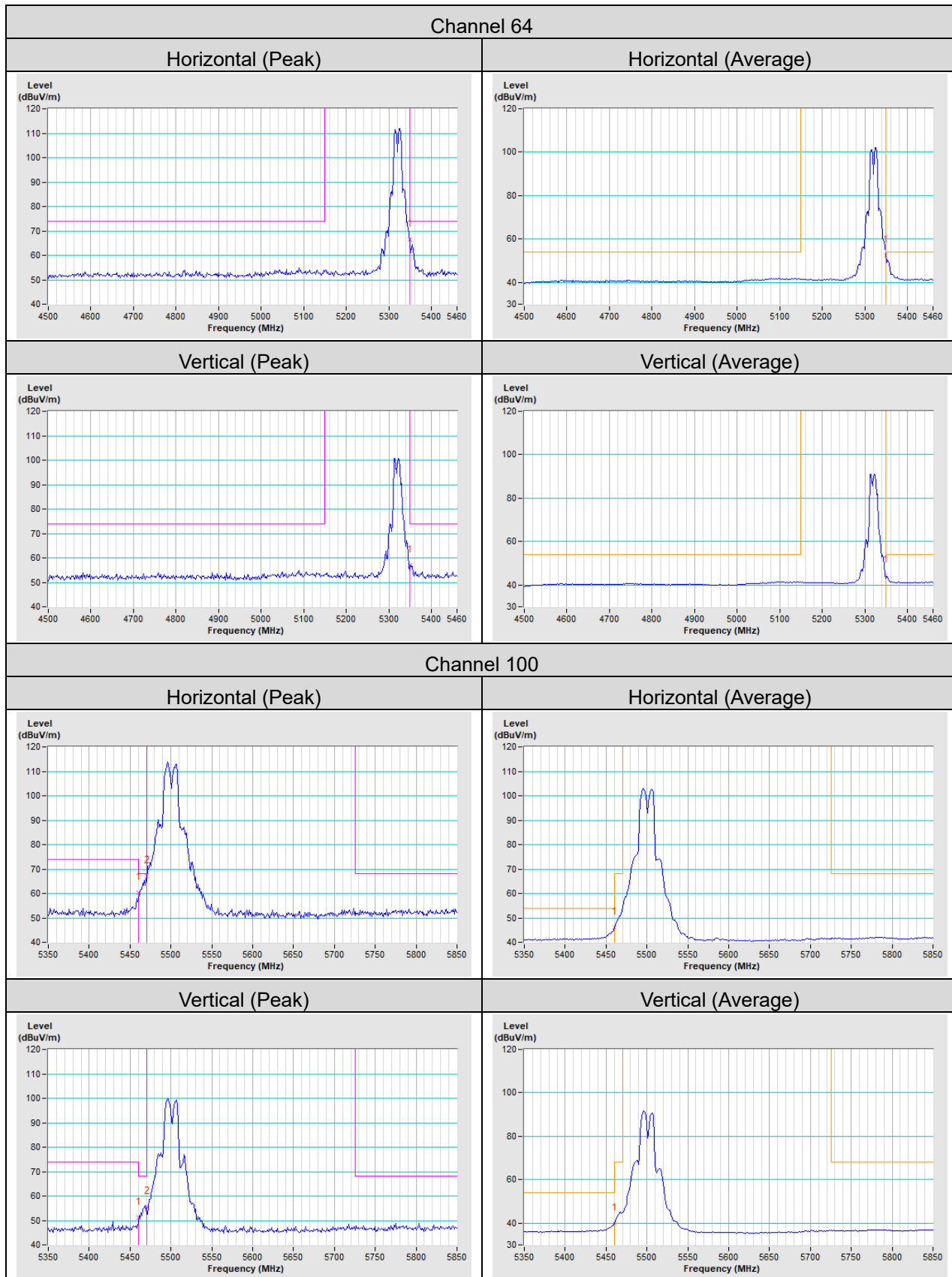

802.11n (HT20)

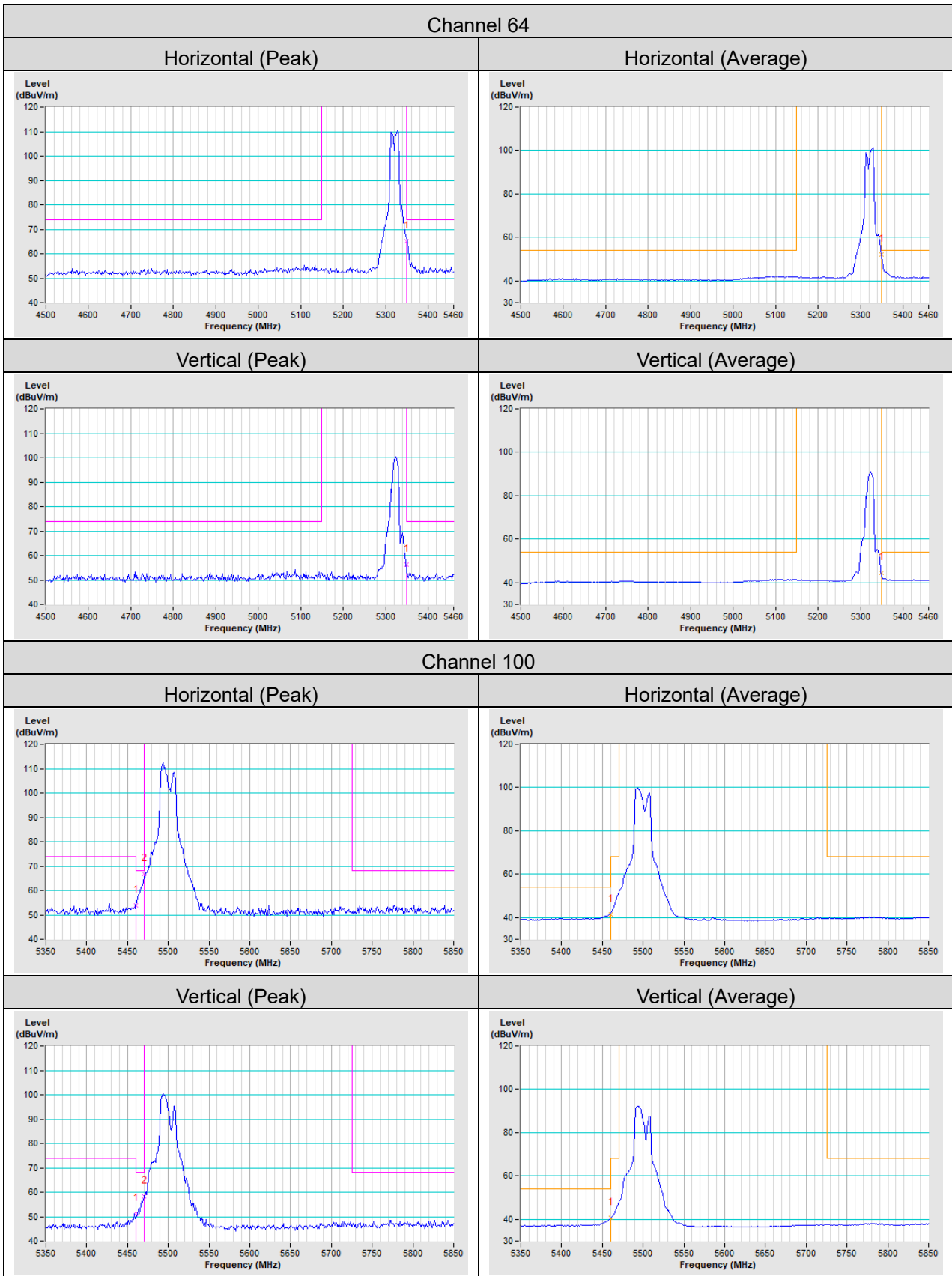

802.11n (HT40)

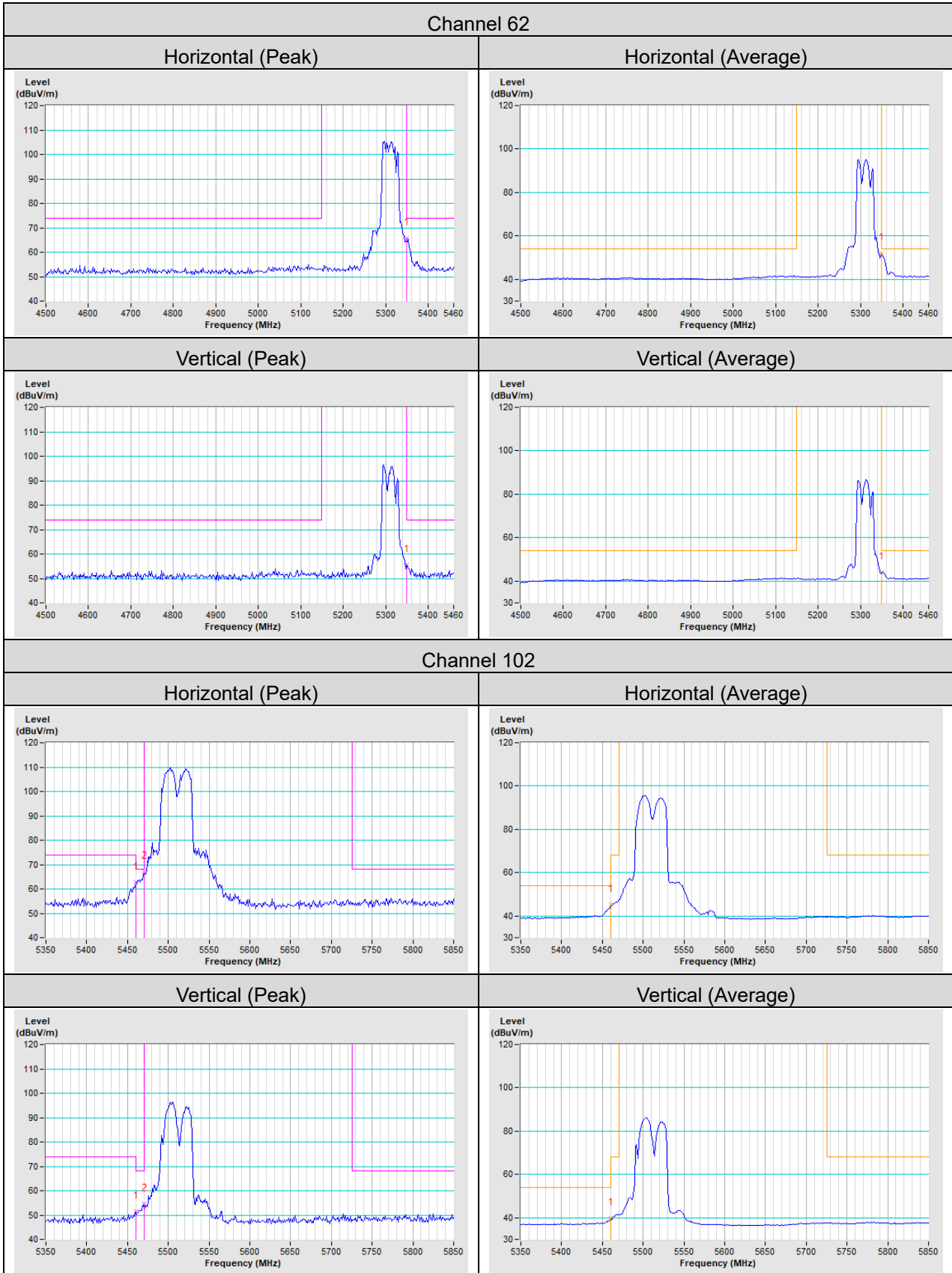

802.11ac (VHT80)

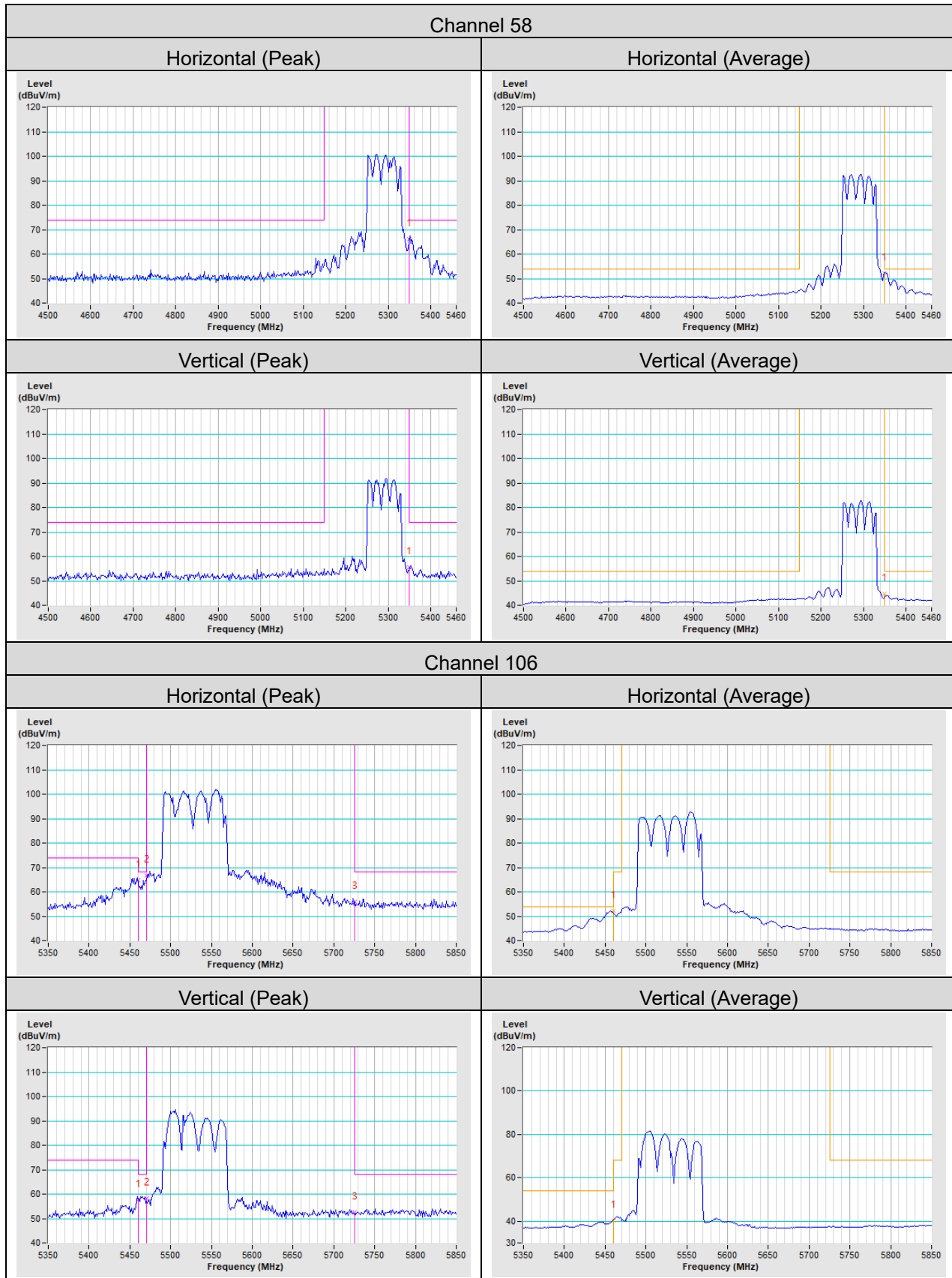

Appendix – Information of the Testing Laboratories

We, Bureau Veritas Consumer Products Services (H.K.) Ltd., Taoyuan Branch, were founded in 1988 to provide our best service in EMC, Radio, Telecom and Safety consultation. Our laboratories are FCC recognized accredited test firms and accredited and approved according to ISO/IEC 17025.

If you have any comments, please feel free to contact us at the following:

Lin Kou EMC/RF Lab

Tel: 886-2-26052180

Fax: 886-2-26051924

Hsin Chu EMC/RF/Telecom Lab

Tel: 886-3-6668565

Fax: 886-3-6668323

Hwa Ya EMC/RF/Safety Lab

Tel: 886-3-3183232

Fax: 886-3-3270892

Email: service.adt@tw.bureauveritas.com

Web Site: <http://ee.bureauveritas.com.tw>

The address and road map of all our labs can be found in our web site also.

--- END ---