

FCC Test Report

Report No.: RF191209C26 R1

FCC ID: 2AKCZ-0F8

Test Model: APL62-0F8

Received Date: Dec. 09, 2019

Test Date: Dec. 26, 2019 ~ Feb. 12, 2020
Dec. 27, 2021

Issued Date: Feb. 16, 2023

Applicant: SonicWall Inc.

Address: 1033 McCarthy Blvd., Milpitas, CA 95035, USA

Issued By: Bureau Veritas Consumer Products Services (H.K.) Ltd., Taoyuan Branch
Lin Kou Laboratories

Lab Address: No. 47-2, 14th Ling, Chia Pau Vil., Lin Kou Dist., New Taipei City, Taiwan

Test Location: No. 19, Hwa Ya 2nd Rd., Wen Hwa Vil., Kwei Shan Dist., Taoyuan City
33383, Taiwan

**FCC Registration /
Designation Number:** 788550 / TW0003



This report is governed by, and incorporates by reference, the Conditions of Testing as posted at the date of issuance of this report at <http://www.bureauveritas.com/home/about-us/our-business/cps/about-us/terms-conditions/> and is intended for your exclusive use. Any copying or replication of this report to or for any other person or entity, or use of our name or trademark, is permitted only with our prior written permission. This report sets forth our findings solely with respect to the test samples identified herein. The results set forth in this report are not indicative or representative of the quality or characteristics of the lot from which a test sample was taken or any similar or identical product unless specifically and expressly noted. Our report includes all of the tests requested by you and the results thereof based upon the information that you provided to us. Measurement uncertainty is only provided upon request for accredited tests. Statements of conformity are based on simple acceptance criteria without taking measurement uncertainty into account, unless otherwise requested in writing. You have 60 days from date of issuance of this report to notify us of any material error or omission caused by our negligence or if you require measurement uncertainty; provided, however, that such notice shall be in writing and shall specifically address the issue you wish to raise. A failure to raise such issue within the prescribed time shall constitute your unqualified acceptance of the completeness of this report, the tests conducted and the correctness of the report contents.

Table of Contents

Release Control Record	4
1 Certificate of Conformity	5
2 Summary of Test Results	6
2.1 Measurement Uncertainty.....	6
2.2 Modification Record.....	6
3 General Information	7
3.1 General Description of EUT.....	7
3.2 Description of Test Modes.....	9
3.2.1 Test Mode Applicability and Tested Channel Detail.....	10
3.3 Duty Cycle of Test Signal.....	12
3.4 Description of Support Units.....	13
3.4.1 Configuration of System under Test.....	13
3.5 General Description of Applied Standards and References.....	14
4 Test Types and Results	15
4.1 Radiated Emission and Bandedge Measurement.....	15
4.1.1 Limits of Radiated Emission and Bandedge Measurement.....	15
4.1.2 Test Instruments.....	16
4.1.3 Test Procedures.....	18
4.1.4 Deviation from Test Standard.....	19
4.1.5 Test Set Up.....	19
4.1.6 EUT Operating Conditions.....	20
4.1.7 Test Results.....	21
4.2 Conducted Emission Measurement.....	35
4.2.1 Limits of Conducted Emission Measurement.....	35
4.2.2 Test Instruments.....	35
4.2.3 Test Procedures.....	36
4.2.4 Deviation from Test Standard.....	36
4.2.5 Test Setup.....	36
4.2.6 EUT Operating Conditions.....	36
4.2.7 Test Results.....	37
4.3 6dB Bandwidth Measurement.....	39
4.3.1 Limits of 6dB Bandwidth Measurement.....	39
4.3.2 Test Setup.....	39
4.3.3 Test Instruments.....	39
4.3.4 Test Procedure.....	39
4.3.5 Deviation from Test Standard.....	39
4.3.6 EUT Operating Conditions.....	39
4.3.7 Test Result.....	40
4.4 Conducted Output Power Measurement.....	42
4.4.1 Limits of Conducted Output Power Measurement.....	42
4.4.2 Test Setup.....	42
4.4.3 Test Instruments.....	42
4.4.4 Test Procedures.....	42
4.4.5 Deviation from Test Standard.....	42
4.4.6 EUT Operating Conditions.....	42
4.4.7 Test Results.....	43
4.5 Power Spectral Density Measurement.....	45
4.5.1 Limits of Power Spectral Density Measurement.....	45
4.5.2 Test Setup.....	45
4.5.3 Test Instruments.....	45
4.5.4 Test Procedure.....	45
4.5.5 Deviation from Test Standard.....	46
4.5.6 EUT Operating Condition.....	46

4.5.7 Test Results	47
4.6 Conducted Out of Band Emission Measurement.....	50
4.6.1 Limits of Conducted Out of Band Emission Measurement	50
4.6.2 Test Setup.....	50
4.6.3 Test Instruments	50
4.6.4 Test Procedure	50
4.6.5 Deviation from Test Standard	50
4.6.6 EUT Operating Condition	51
4.6.7 Test Results	51
5 Pictures of Test Arrangements.....	60
Appendix – Information of the Testing Laboratories	61

Release Control Record

Issue No.	Description	Date Issued
RF191209C26	Original release	Feb. 17, 2020
RF191209C26 R1	Update Beamforming mode power	Feb. 16, 2023

1 Certificate of Conformity

Product: Wireless Network Security Appliance

Brand: SONICWALL

Test Model: APL62-0F8

Sample Status: Engineering sample

Applicant: SonicWall Inc.

Test Date: Dec. 26, 2019 ~ Feb. 12, 2020
Dec. 27, 2021

Standards: 47 CFR FCC Part 15, Subpart C (Section 15.247)
ANSI C63.10:2013

The above equipment has been tested by **Bureau Veritas Consumer Products Services (H.K.) Ltd., Taoyuan Branch**, and found compliance with the requirement of the above standards. The test record, data evaluation & Equipment Under Test (EUT) configurations represented herein are true and accurate accounts of the measurements of the sample's RF characteristics under the conditions specified in this report.

Prepared by : *Polly Chien* , **Date:** Feb. 16, 2023
Polly Chien / Specialist

Approved by : *Jeremy Lin* , **Date:** Feb. 16, 2023
Jeremy Lin / Project Engineer

2 Summary of Test Results

47 CFR FCC Part 15, Subpart C (Section 15.247)			
FCC Clause	Test Item	Result	Remarks
15.207	AC Power Conducted Emission	Pass	Meet the requirement of limit. Minimum passing margin is -11.18dB at 12.97800MHz
15.205 / 15.209 / 15.247(d)	Radiated Emissions and Band Edge Measurement	Pass	Meet the requirement of limit. Minimum passing margin is -1.2dB at 2390.00MHz & 2483.50MHz.
15.247(d)	Antenna Port Emission	Pass	Meet the requirement of limit.
15.247(a)(2)	6dB bandwidth	Pass	Meet the requirement of limit.
15.247(b)	Conducted power	Pass	Meet the requirement of limit.
15.247(e)	Power Spectral Density	Pass	Meet the requirement of limit.
15.203	Antenna Requirement	Pass	Antenna connector is RP-SMA not a standard connector.

Note: Determining compliance based on the results of the compliance measurement, not taking into account measurement instrumentation uncertainty.

2.1 Measurement Uncertainty

Where relevant, the following measurement uncertainty levels have been estimated for tests performed on the EUT as specified in CISPR 16-4-2:

Measurement	Frequency	Expanded Uncertainty (k=2) (\pm)
Conducted Emissions at mains ports	150kHz ~ 30MHz	2.79 dB
Radiated Emissions up to 1 GHz	9kHz ~ 30MHz	3.04 dB
	30MHz ~ 200MHz	3.86 dB
	200MHz ~ 1000MHz	3.87 dB
Radiated Emissions above 1 GHz	1GHz ~ 18GHz	2.29 dB
	18GHz ~ 40GHz	2.29 dB

2.2 Modification Record

There were no modifications required for compliance.

3 General Information

3.1 General Description of EUT

Product	Wireless Network Security Appliance
Brand	SONICWALL
Test Model	APL62-0F8
Sample Status	Engineering sample
Power Supply Rating	12Vdc from Adapter
Modulation Type	CCK, DQPSK, DBPSK for DSSS 64QAM, 16QAM, QPSK, BPSK for OFDM
Modulation Technology	DSSS, OFDM
Transfer Rate	802.11b: 11.0/ 5.5/ 2.0/ 1.0Mbps 802.11g: 54.0/ 48.0/ 36.0/ 24.0/ 18.0/ 12.0/ 9.0/ 6.0Mbps 802.11n: up to 300Mbps
Operating Frequency	2412 ~ 2462MHz
Number of Channel	11 for 802.11b, 802.11g, 802.11n (HT20) 7 for 802.11n (HT40)
Output Power	CDD Mode: 458.673mW Beamforming Mode: 184.818mW
Antenna Type	Refer to note
Antenna Connector	Refer to note
Accessory Device	Adapter
Data Cable Supplied	0.91m AC power non-shielded cable without core 1.15m non-shielded console cable without core 0.95m shielded USB cable without core 0.95m non-shielded RJ45 cable without core

Note:

- The EUT incorporates a MIMO function. Physically, the EUT provides 2 completed transmitters and 2 receivers.

Modulation Mode	TX Function	Beamforming
802.11b	2TX	Not Support
802.11g	2TX	Not Support
802.11n (HT20)	2TX	Support
802.11n (HT40)	2TX	Support

- The EUT uses following antennas.

Ant. Type	Dipole					
Ant. Connector	RP-SMA					
Frequency (MHz)	2400	2450	2500	5150	5550	5850
Peak Gain (dBi)	3.19	3.10	3.05	5.85	5.73	5.03

* The max. gain was chosen for final tests.

3. The EUT consumes power from the following adapters.

Adapter 1	
Brand	Sunny COMPUTER TECHNOLOGY CO., LTD.
Model	SYS1548-6012-T3
Input Power	100-240Vac, 50-60Hz, 1.5A MAX
Output Power	12Vdc, 5.0A, 60W MAX
Power Line	1.85m DC power cable with 1 core attached on adapter

Adapter 2	
Brand	BILLION
Model	BA070-120500MAX
Input Power	100-240Vac, 50/60Hz, 1.5A
Output Power	12Vdc, 5.0A
Power Line	1.47m power cable with 1 core attached on adapter

* After the pretesting, the adapter 1 was chosen for final test.

4. The power setting are list as below:

CDD Mode					
	802.11b	802.11g	802.11n (HT20)		802.11n (HT40)
CH01	45	39	38	CH03	33
CH06	44	44	44	CH06	33
CH11	42	37	37	CH09	33
Beamforming Mode					
	802.11n (HT20)				802.11n (HT40)
CH01	34			CH03	30
CH06	42			CH06	33
CH11	35			CH09	32

5. WLAN 2.4GHz & WLAN 5GHz technology cannot transmit at same time.

6. Spurious emission of the simultaneous operation (2.4GHz and 5GHz) has been evaluated and no non-compliance was found.

3.2 Description of Test Modes

11 channels are provided for 802.11b, 802.11g and 802.11n (HT20):

Channel	Frequency	Channel	Frequency
1	2412MHz	7	2442MHz
2	2417MHz	8	2447MHz
3	2422MHz	9	2452MHz
4	2427MHz	10	2457MHz
5	2432MHz	11	2462MHz
6	2437MHz		

7 channels are provided for 802.11n (HT40):

Channel	Frequency	Channel	Frequency
3	2422MHz	7	2442MHz
4	2427MHz	8	2447MHz
5	2432MHz	9	2452MHz
6	2437MHz		

3.2.1 Test Mode Applicability and Tested Channel Detail

EUT CONFIGURE MODE	APPLICABLE TO				DESCRIPTION
	RE \geq 1G	RE<1G	PLC	APCM	Power
-	√	√	√	√	-

Where **RE \geq 1G**: Radiated Emission above 1GHz & Bandedge Measurement
RE<1G: Radiated Emission below 1GHz
PLC: Power Line Conducted Emission
APCM: Antenna Port Conducted Measurement

Note:

1. The EUT had been pre-tested on the positioned of each 3 axis. The worst case was found when positioned on **Z-plane**.
2. Radiated emission test (below 1GHz) and power line conducted emission test items chosen the worst maximum power.

Radiated Emission Test (Above 1GHz):

- Pre-Scan has been conducted to determine the worst-case mode from all possible combinations between available modulations, data rates and antenna ports (if EUT with antenna diversity architecture).
- Following channel(s) was (were) selected for the final test as listed below.

EUT CONFIGURE MODE	MODE	AVAILABLE CHANNEL	TESTED CHANNEL	MODULATION TECHNOLOGY	MODULATION TYPE	DATA RATE (Mbps)
-	802.11b	1 to 11	1, 6, 11	DSSS	DBPSK	1.0
-	802.11g	1 to 11	1, 6, 11	OFDM	BPSK	6.0
-	802.11n (HT20)	1 to 11	1, 6, 11	OFDM	BPSK	6.5
-	802.11n (HT40)	3 to 9	3, 6, 9	OFDM	BPSK	13.5

Radiated Emission Test (Below 1GHz):

- Pre-Scan has been conducted to determine the worst-case mode from all possible combinations between available modulations, data rates and antenna ports (if EUT with antenna diversity architecture).
- Following channel(s) was (were) selected for the final test as listed below.

EUT CONFIGURE MODE	MODE	AVAILABLE CHANNEL	TESTED CHANNEL	MODULATION TECHNOLOGY	MODULATION TYPE	DATA RATE (Mbps)
-	802.11b	1 to 11	1	DSSS	DBPSK	1.0

Power Line Conducted Emission Test:

- Pre-Scan has been conducted to determine the worst-case mode from all possible combinations between available modulations, data rates and antenna ports (if EUT with antenna diversity architecture).
- Following channel(s) was (were) selected for the final test as listed below.

EUT CONFIGURE MODE	MODE	AVAILABLE CHANNEL	TESTED CHANNEL	MODULATION TECHNOLOGY	MODULATION TYPE	DATA RATE (Mbps)
-	802.11b	1 to 11	1	DSSS	DBPSK	1.0

Antenna Port Conducted Measurement:

- This item includes all test value of each mode, but only includes spectrum plot of worst value of each mode.
- Pre-Scan has been conducted to determine the worst-case mode from all possible combinations between available modulations, data rates and antenna ports (if EUT with antenna diversity architecture).
- Following channel(s) was (were) selected for the final test as listed below.

EUT CONFIGURE MODE	MODE	AVAILABLE CHANNEL	TESTED CHANNEL	MODULATION TECHNOLOGY	MODULATION TYPE	DATA RATE (Mbps)
-	802.11b	1 to 11	1, 6, 11	DSSS	DBPSK	1.0
-	802.11g	1 to 11	1, 6, 11	OFDM	BPSK	6.0
-	802.11n (HT20)	1 to 11	1, 6, 11	OFDM	BPSK	6.5
-	802.11n (HT40)	3 to 9	3, 6, 9	OFDM	BPSK	13.5

Test Condition:

APPLICABLE TO	ENVIRONMENTAL CONDITIONS	INPUT POWER	TESTED BY
RE \geq 1G	23 deg. C, 68% RH	120Vac, 60Hz	Titan Hsu
RE<1G	22 deg. C, 68% RH	120Vac, 60Hz	Greg Lin
PLC	25 deg. C, 75% RH	120Vac, 60Hz	Jones Chang
APCM	25 deg. C, 60% RH	120Vac, 60Hz	Jisyong Wang

3.3 Duty Cycle of Test Signal

Duty cycle of test signal is > 98%, duty factor is not required.

Duty cycle of test signal is < 98%, duty factor shall be considered.

802.11b: Duty cycle = $6.265/6.370 = 0.984$

802.11g: Duty cycle = $2.040/2.138 = 0.954$, Duty factor = $10 * \log(1/0.954) = 0.20$

802.11n (HT20): Duty cycle = $4.990/5.457 = 0.914$, Duty factor = $10 * \log(1/0.914) = 0.39$

802.11n (HT40): Duty cycle = $2.423/2.878 = 0.842$, Duty factor = $10 * \log(1/0.842) = 0.75$

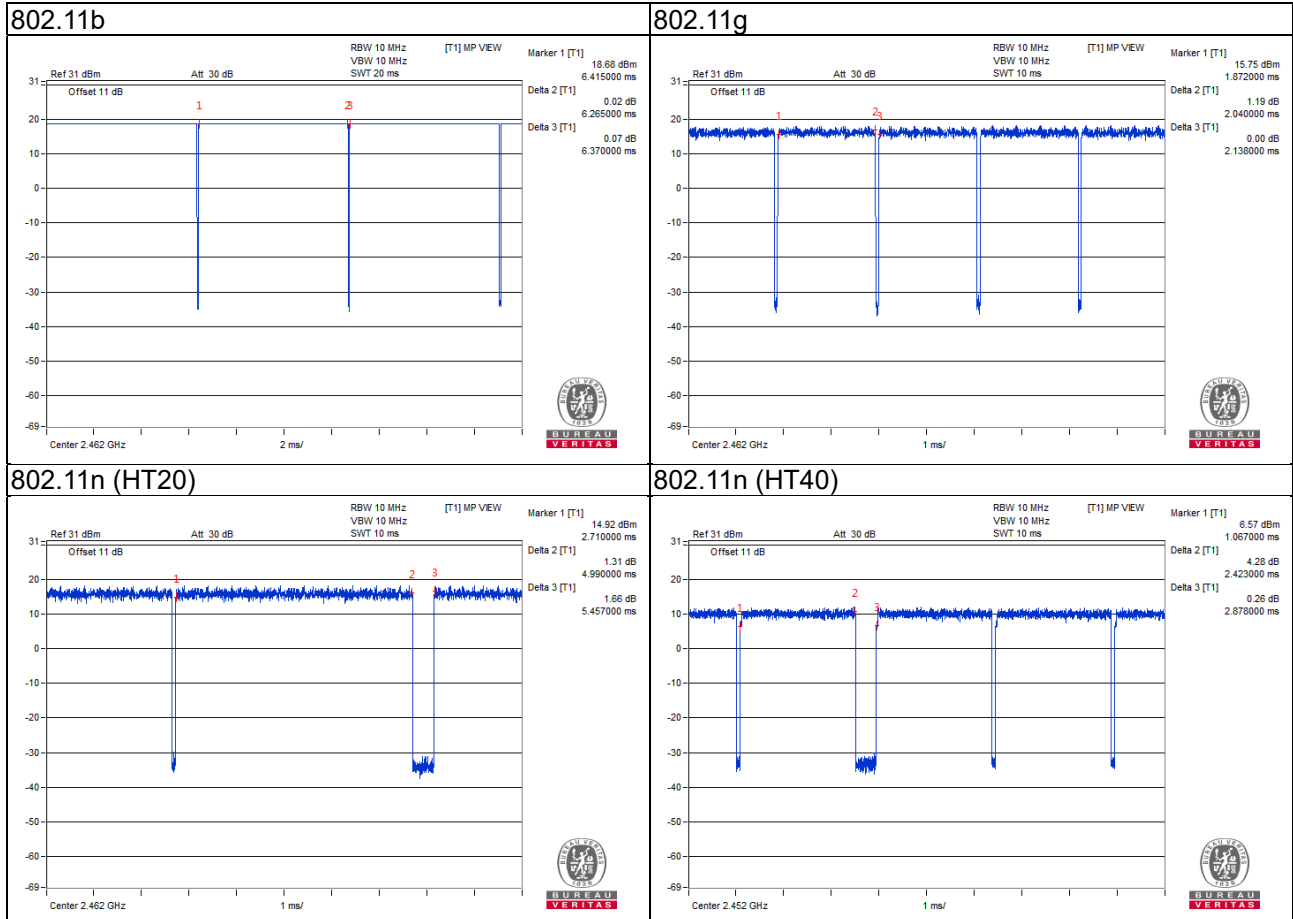

3.4 Description of Support Units

The EUT has been tested as an independent unit together with other necessary accessories or support units. The following support units or accessories were used to form a representative test configuration during the tests.

ID	Product	Brand	Model No.	Serial No.	FCC ID	Remarks
A.	Notebook	DELL	E5410	1HC2XM1	FCC DoC Approved	-
B.	Flash	HP	v250W	09	NA	-
	Flash	HP	v250W	03	NA	-
C.	Load	NA	NA	NA	NA	-

Note:

1. All power cords of the above support units are non-shielded (1.8m).
2. Item A acted as a communication partner to transfer data.

ID	Descriptions	Qty.	Length (m)	Shielding (Yes/No)	Cores (Qty.)	Remarks
1.	Console cable	1	1.15	N	0	Accessory of EUT
2.	USB cable	1	0.95	Y	0	Accessory of EUT
3.	LAN cable	1	0.95	N	0	Accessory of EUT RJ45, Cat5e
4.	Power cord	2	0.91	N	0	Accessory of EUT
5.	LAN cable	1	7	N	0	RJ45, Cat5e
6.	LAN cable	7	1.5	N	0	RJ45, Cat5e
7.	Fiber cable	1	3	N	0	Provided by client

3.4.1 Configuration of System under Test

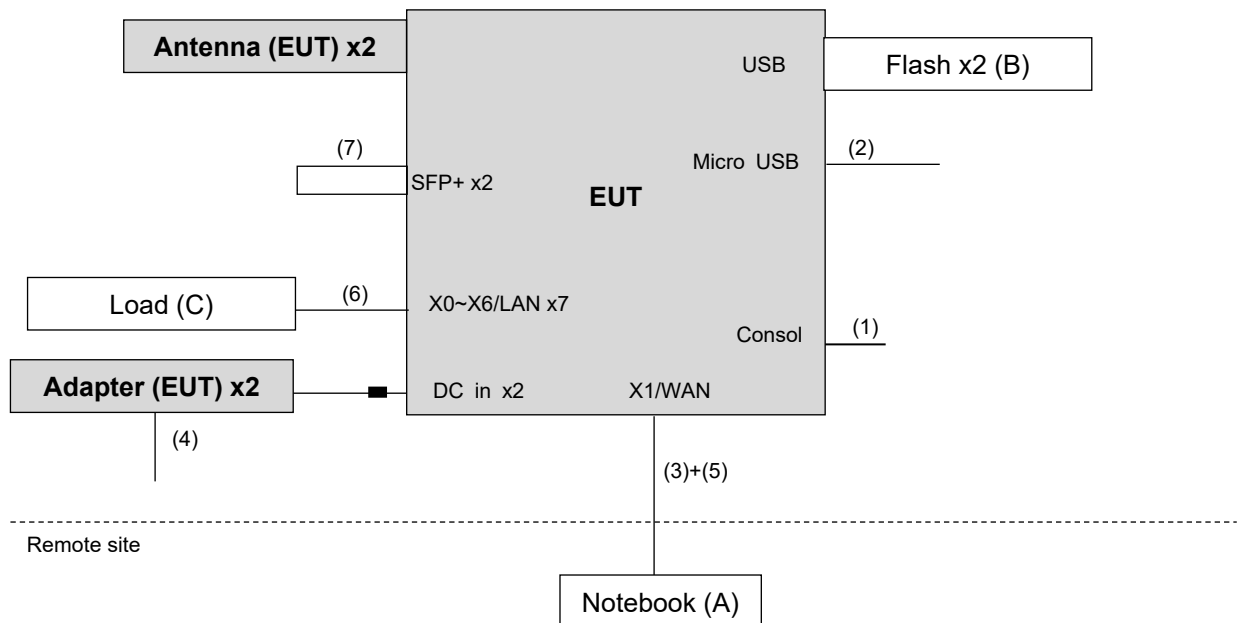

3.5 General Description of Applied Standards and References

The EUT is a RF Product. According to the specifications of the manufacturer, it must comply with the requirements of the following standards and references:

Test standard:

FCC Part 15, Subpart C (15.247)

ANSI C63.10-2013

All test items have been performed and recorded as per the above standards.

References Test Guidance:

KDB 558074 D01 15.247 Meas Guidance v05r02

KDB 662911 D01 Multiple Transmitter Output v02r01

All test items have been performed as a reference to the above KDB test guidance.

4 Test Types and Results

4.1 Radiated Emission and Bandedge Measurement

4.1.1 Limits of Radiated Emission and Bandedge Measurement

Radiated emissions which fall in the restricted bands must comply with the radiated emission limits specified as below table. Other emissions shall be at least 30dB below the highest level of the desired power:

Frequencies (MHz)	Field Strength (microvolts/meter)	Measurement Distance (meters)
0.009 ~ 0.490	2400/F(kHz)	300
0.490 ~ 1.705	24000/F(kHz)	30
1.705 ~ 30.0	30	30
30 ~ 88	100	3
88 ~ 216	150	3
216 ~ 960	200	3
Above 960	500	3

Note:

1. The lower limit shall apply at the transition frequencies.
2. Emission level (dBuV/m) = 20 log Emission level (uV/m).
3. For frequencies above 1000MHz, the field strength limits are based on average detector, however, the peak field strength of any emission shall not exceed the maximum permitted average limits, specified above by more than 30dB under any condition of modulation.

4.1.2 Test Instruments

Description & Manufacturer	Model No.	Serial No.	Date Of Calibration	Due Date Of Calibration
Test Receiver ROHDE & SCHWARZ	ESIB7	100187	May 30, 2019	May 29, 2020
BILOG Antenna SCHWARZBECK	VULB9168	9168-171	Nov. 11, 2019	Nov. 10, 2020
HORN Antenna SCHWARZBECK	9120D	209	Nov. 24, 2019	Nov. 23, 2020
HORN Antenna SCHWARZBECK	BBHA 9170	BBHA9170241	Nov. 24, 2019	Nov. 23, 2020
Loop Antenna TESEQ	HLA 6121	45745	Jul. 01, 2019	Jun. 30, 2020
Preamplifier Agilent (Below 1GHz)	8447D	2944A10738	Aug. 20, 2019	Aug. 19, 2020
Preamplifier Agilent (Above 1GHz)	8449B	3008A02465	Mar. 27, 2019	Mar. 26, 2020
RF Coaxial Cable WOKEN With 5dB PAD	8D-FB	Cable-CH3-01	Aug. 20, 2019	Aug. 19, 2020
RF signal cable HUBER+SUHNER	SUCOFLEX 104	Cable-CH3-03 (223653/4)	Aug. 20, 2019	Aug. 19, 2020
RF signal cable HUBER+SUHNER& EMCI	SUCOFLEX 104&EMC104-SM- SM-8000	Cable-CH3-03 (309224+170907)	Aug. 20, 2019	Aug. 19, 2020
Software BV ADT	ADT_Radiated_ V7.6.15.9.5	NA	NA	NA
Antenna Tower inn-co GmbH	MA 4000	013303	NA	NA
Antenna Tower Controller BV ADT	AT100	AT93021702	NA	NA
Turn Table BV ADT	TT100	TT93021702	NA	NA
Turn Table Controller BV ADT	SC100	SC93021702	NA	NA
Boresight Antenna Fixture	FBA-01	FBA-SIP01	NA	NA
USB Wideband Power Sensor KEYSIGHT	U2021XA	MY55050005/MY55 190004/MY5519000 7/MY55210005	Jul. 15, 2019	Jul. 14, 2020

- Note: 1. The calibration interval of the above test instruments is 12 months and the calibrations are traceable to NML/ROC and NIST/USA.
 2. The test was performed in HwaYa Chamber 3.
 3. Tested date: Dec. 26, 2019 ~ Feb. 12, 2020

Description & Manufacturer	Model No.	Serial No.	Date Of Calibration	Due Date Of Calibration
Test Receiver ROHDE & SCHWARZ	ESR3	102579	Jul. 05, 2021	Jul. 04, 2022
Spectrum Analyzer ROHDE & SCHWARZ	FSU43	101261	Apr. 12, 2021	Apr. 11, 2022
BILOG Antenna SCHWARZBECK	VULB9168	9168-171	Oct. 29, 2021	Oct. 28, 2022
HORN Antenna SCHWARZBECK	BBHA 9170	BBHA9170241	Oct. 26, 2021	Oct. 25, 2022
Loop Antenna TESEQ	HLA 6121	45745	Jul. 21, 2021	Jul. 20, 2022
Preamplifier Agilent (Below 1GHz)	8447D	2944A10738	Jul. 24, 2021	Jul. 23, 2022
Preamplifier Agilent (Above 1GHz)	8449B	3008A02465	Mar. 22, 2021	Mar. 21, 2022
RF Coaxial Cable WOKEN With 5dB PAD	8D-FB	Cable-CH3-01	Jul. 23, 2021	Jul. 22, 2022
RF signal cable HUBER+SUHNER	SUCOFLEX 104	Cable-CH3-03 (223653/4)	Jul. 23, 2021	Jul. 22, 2022
RF signal cable HUBER+SUHNER& EMCI	SUCOFLEX 104&EMC104-SM- SM-8000	Cable-CH3-03 (309224+170907)	Jul. 23, 2021	Jul. 22, 2022
Software BV ADT	ADT_Radiated_ V7.6.15.9.5	NA	NA	NA
Antenna Tower inn-co GmbH	MA 4000	013303	NA	NA
Antenna Tower Controller BV ADT	AT100	AT93021702	NA	NA
Turn Table BV ADT	TT100	TT93021702	NA	NA
Turn Table Controller BV ADT	SC100	SC93021702	NA	NA
Boresight Antenna Fixture	FBA-01	FBA-SIP01	NA	NA
USB Wideband Power Sensor KEYSIGHT	U2021XA	MY55050005/MY55 190004/MY5519000 7/MY55210005	Jul. 12, 2021	Jul. 11, 2022

- Note: 1. The calibration interval of the above test instruments is 12 months and the calibrations are traceable to NML/ROC and NIST/USA.
 2. The test was performed in HwaYa Chamber 3.
 3. Tested date: Dec. 27, 2021

4.1.3 Test Procedures

For Radiated emission below 30MHz

- a. The EUT was placed on the top of a rotating table 0.8 meters above the ground at a 3 meter chamber room. The table was rotated 360 degrees to determine the position of the highest radiation.
- b. The EUT was set 3 meters away from the interference-receiving antenna, which was mounted on the top of a variable-height antenna tower.
- c. Parallel, perpendicular, and ground-parallel orientations of the antenna are set to make the measurement.
- d. For each suspected emission, the EUT was arranged to its worst case and the rotatable table was turned from 0 degrees to 360 degrees to find the maximum reading.
- e. The test-receiver system was set to Quasi-Peak Detect Function and Specified Bandwidth with Maximum Hold Mode.

NOTE:

1. The resolution bandwidth and video bandwidth of test receiver/spectrum analyzer is 9kHz at frequency below 30MHz.

For Radiated emission above 30MHz

- a. The EUT was placed on the top of a rotating table 0.8 meters (for 30MHz ~ 1GHz) / 1.5 meters (for above 1GHz) above the ground at 3 meter chamber room for test. The table was rotated 360 degrees to determine the position of the highest radiation.
- b. The EUT was set 3 meters away from the interference-receiving antenna, which was mounted on the top of a variable-height antenna tower.
- c. The height of antenna is varied from one meter to four meters above the ground to determine the maximum value of the field strength. Both horizontal and vertical polarizations of the antenna are set to make the measurement.
- d. For each suspected emission, the EUT was arranged to its worst case and then the antenna was tuned to heights from 1 meter to 4 meters and the rotatable table was turned from 0 degrees to 360 degrees to find the maximum reading.
- e. The test-receiver system was set to quasi-peak detect function and specified bandwidth with maximum hold mode when the test frequency is below 1 GHz.
- f. The test-receiver system was set to peak and average detects function and specified bandwidth with maximum hold mode when the test frequency is above 1 GHz. If the peak reading value also meets average limit, measurement with the average detector is unnecessary.

Note:

1. The resolution bandwidth and video bandwidth of test receiver/spectrum analyzer is 120kHz for Quasi-peak detection (QP) at frequency below 1GHz.
2. The resolution bandwidth of test receiver/spectrum analyzer is 1 MHz and the video bandwidth is 3 MHz for Peak detection (PK) at frequency above 1GHz.
3. The resolution bandwidth of test receiver/spectrum analyzer is 1MHz and the video bandwidth is $\geq 1/T$ (Duty cycle < 98%) or 10Hz (Duty cycle $\geq 98\%$) for Average detection (AV) at frequency above 1GHz.
(802.11b: RBW = 1MHz, VBW = 10Hz; 802.11g: RBW = 1MHz, VBW = 1kHz;
802.11n (HT20): RBW = 1MHz, VBW = 1kHz; 802.11n (HT40): RBW = 1MHz, VBW = 1kHz)
4. All modes of operation were investigated and the worst-case emissions are reported.

4.1.4 Deviation from Test Standard

No deviation.

4.1.5 Test Set Up

For Radiated emission below 30MHz

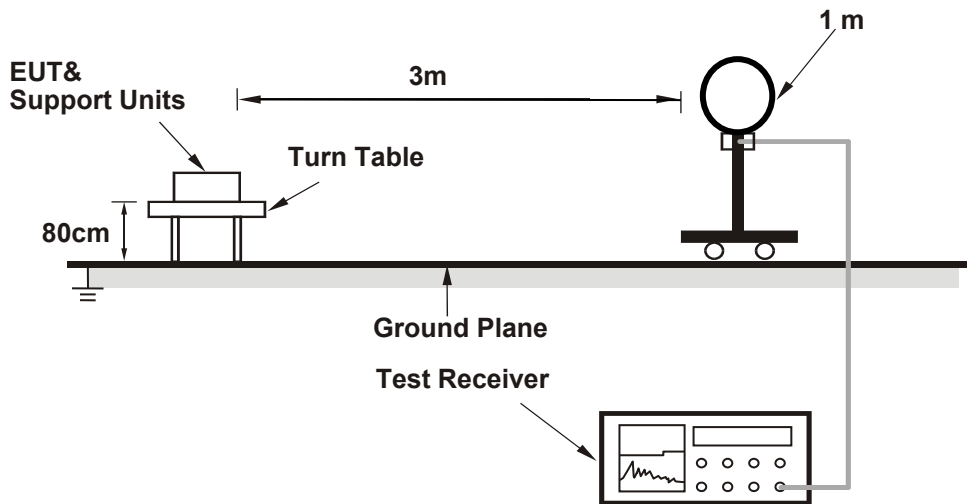

For Radiated emission 30MHz to 1GHz

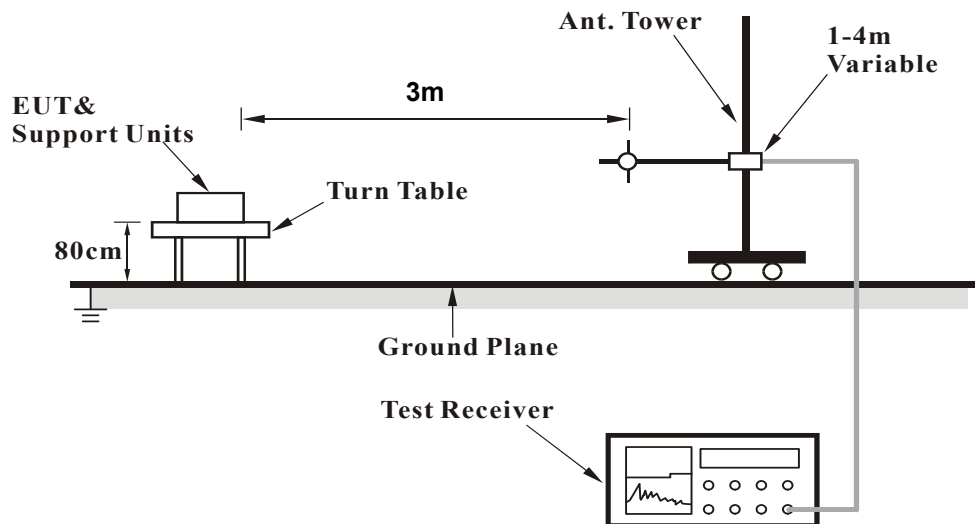

For Radiated emission above 1GHz

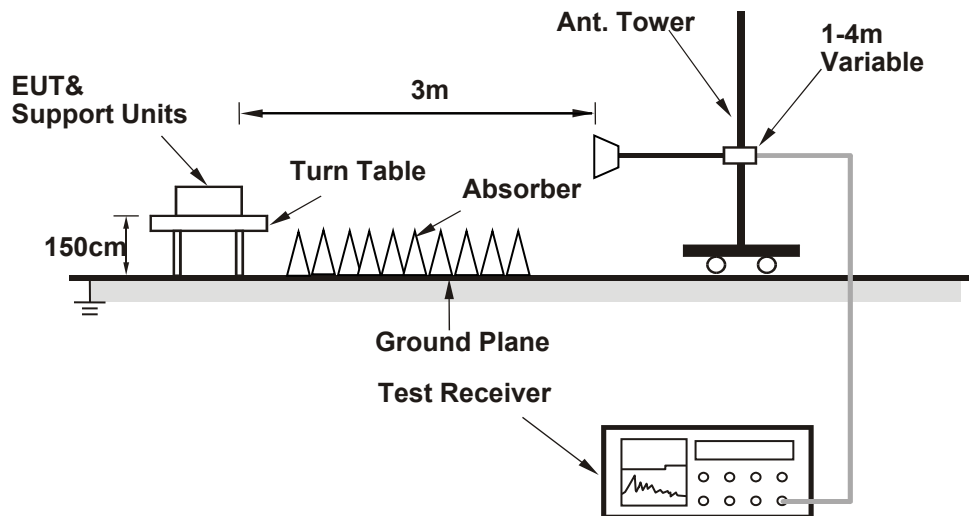

For the actual test configuration, please refer to the attached file (Test Setup Photo).

4.1.6 EUT Operating Conditions

- a. Placed the EUT on the testing table.
- b. Prepared a notebook to act as a communication partner and placed it outside of testing area.
- c. The communication partner connected with EUT via a RJ45 cable and ran a test program (CMD) to enable EUT under transmission condition continuously at specific channel frequency.
- d. The communication partner sent data to EUT by command "PING".

4.1.7 Test Results

Above 1GHz worst-Case data:

802.11b

CHANNEL	TX Channel 1	DETECTOR FUNCTION	Peak (PK)
FREQUENCY RANGE	1GHz ~ 25GHz		Average (AV)

ANTENNA POLARITY & TEST DISTANCE: HORIZONTAL AT 3 M								
NO.	FREQ. (MHz)	EMISSION LEVEL (dBuV/m)	LIMIT (dBuV/m)	MARGIN (dB)	ANTENNA HEIGHT (m)	TABLE ANGLE (Degree)	RAW VALUE (dBuV)	CORRECTION FACTOR (dB/m)
1	2390.00	60.0 PK	74.0	-14.0	1.60 H	327	27.7	32.3
2	2390.00	52.8 AV	54.0	-1.2	1.60 H	327	20.5	32.3
3	*2412.00	115.5 PK			1.57 H	334	83.2	32.3
4	*2412.00	111.2 AV			1.57 H	334	78.9	32.3
5	4824.00	45.9 PK	74.0	-28.1	1.80 H	165	42.5	3.4
6	4824.00	35.5 AV	54.0	-18.5	1.80 H	165	32.1	3.4
ANTENNA POLARITY & TEST DISTANCE: VERTICAL AT 3 M								
NO.	FREQ. (MHz)	EMISSION LEVEL (dBuV/m)	LIMIT (dBuV/m)	MARGIN (dB)	ANTENNA HEIGHT (m)	TABLE ANGLE (Degree)	RAW VALUE (dBuV)	CORRECTION FACTOR (dB/m)
1	2390.00	57.0 PK	74.0	-17.0	3.51 V	289	24.7	32.3
2	2390.00	46.8 AV	54.0	-7.2	3.51 V	289	14.5	32.3
3	*2412.00	108.1 PK			3.40 V	289	75.8	32.3
4	*2412.00	103.6 AV			3.40 V	289	71.3	32.3
5	4824.00	44.7 PK	74.0	-29.3	3.02 V	206	41.3	3.4
6	4824.00	31.7 AV	54.0	-22.3	3.02 V	206	28.3	3.4

REMARKS:

1. Emission Level(dBuV/m) = Raw Value(dBuV) + Correction Factor(dB/m)
2. Correction Factor(dB/m) = Antenna Factor(dB/m) + Cable Factor(dB)
3. The other emission levels were very low against the limit.
4. Margin value = Emission Level – Limit value
5. " * " : Fundamental frequency.

CHANNEL	TX Channel 6	DETECTOR FUNCTION	Peak (PK)
FREQUENCY RANGE	1GHz ~ 25GHz		Average (AV)

ANTENNA POLARITY & TEST DISTANCE: HORIZONTAL AT 3 M

NO.	FREQ. (MHz)	EMISSION LEVEL (dBuV/m)	LIMIT (dBuV/m)	MARGIN (dB)	ANTENNA HEIGHT (m)	TABLE ANGLE (Degree)	RAW VALUE (dBuV)	CORRECTION FACTOR (dB/m)
1	*2437.00	112.8 PK			1.57 H	329	80.5	32.3
2	*2437.00	108.3 AV			1.57 H	329	76.0	32.3
3	4874.00	53.5 PK	74.0	-20.5	1.74 H	166	49.8	3.7
4	4874.00	47.5 AV	54.0	-6.5	1.74 H	166	43.8	3.7

ANTENNA POLARITY & TEST DISTANCE: VERTICAL AT 3 M

NO.	FREQ. (MHz)	EMISSION LEVEL (dBuV/m)	LIMIT (dBuV/m)	MARGIN (dB)	ANTENNA HEIGHT (m)	TABLE ANGLE (Degree)	RAW VALUE (dBuV)	CORRECTION FACTOR (dB/m)
1	*2437.00	103.6 PK			3.30 V	234	71.3	32.3
2	*2437.00	99.1 AV			3.30 V	234	66.8	32.3
3	4874.00	47.4 PK	74.0	-26.6	2.13 V	241	43.7	3.7
4	4874.00	38.0 AV	54.0	-16.0	2.13 V	241	34.3	3.7

REMARKS:

1. Emission Level(dBuV/m) = Raw Value(dBuV) + Correction Factor(dB/m)
2. Correction Factor(dB/m) = Antenna Factor(dB/m) + Cable Factor(dB)
3. The other emission levels were very low against the limit.
4. Margin value = Emission Level – Limit value
5. " * ": Fundamental frequency.

CHANNEL	TX Channel 11	DETECTOR FUNCTION	Peak (PK)
FREQUENCY RANGE	1GHz ~ 25GHz		Average (AV)

ANTENNA POLARITY & TEST DISTANCE: HORIZONTAL AT 3 M

NO.	FREQ. (MHz)	EMISSION LEVEL (dBuV/m)	LIMIT (dBuV/m)	MARGIN (dB)	ANTENNA HEIGHT (m)	TABLE ANGLE (Degree)	RAW VALUE (dBuV)	CORRECTION FACTOR (dB/m)
1	*2462.00	112.3 PK			1.70 H	332	79.9	32.4
2	*2462.00	107.8 AV			1.70 H	332	75.4	32.4
3	2483.50	60.6 PK	74.0	-13.4	1.28 H	336	28.2	32.4
4	2483.50	52.5 AV	54.0	-1.5	1.28 H	336	20.1	32.4
5	4924.00	49.6 PK	74.0	-24.4	1.69 H	169	45.8	3.8
6	4924.00	41.3 AV	54.0	-12.7	1.69 H	169	37.5	3.8

ANTENNA POLARITY & TEST DISTANCE: VERTICAL AT 3 M

NO.	FREQ. (MHz)	EMISSION LEVEL (dBuV/m)	LIMIT (dBuV/m)	MARGIN (dB)	ANTENNA HEIGHT (m)	TABLE ANGLE (Degree)	RAW VALUE (dBuV)	CORRECTION FACTOR (dB/m)
1	*2462.00	104.7 PK			3.26 V	235	72.3	32.4
2	*2462.00	100.5 AV			3.26 V	235	68.1	32.4
3	2483.50	57.7 PK	74.0	-16.3	3.23 V	243	25.3	32.4
4	2483.50	46.0 AV	54.0	-8.0	3.23 V	243	13.6	32.4
5	4924.00	46.3 PK	74.0	-27.7	2.21 V	239	42.5	3.8
6	4924.00	34.7 AV	54.0	-19.3	2.21 V	239	30.9	3.8

REMARKS:

1. Emission Level(dBuV/m) = Raw Value(dBuV) + Correction Factor(dB/m)
2. Correction Factor(dB/m) = Antenna Factor(dB/m) + Cable Factor(dB)
3. The other emission levels were very low against the limit.
4. Margin value = Emission Level – Limit value
5. " * " : Fundamental frequency.

802.11g

CHANNEL	TX Channel 1	DETECTOR FUNCTION	Peak (PK)
FREQUENCY RANGE	1GHz ~ 25GHz		Average (AV)

ANTENNA POLARITY & TEST DISTANCE: HORIZONTAL AT 3 M								
NO.	FREQ. (MHz)	EMISSION LEVEL (dBuV/m)	LIMIT (dBuV/m)	MARGIN (dB)	ANTENNA HEIGHT (m)	TABLE ANGLE (Degree)	RAW VALUE (dBuV)	CORRECTION FACTOR (dB/m)
1	2390.00	64.4 PK	74.0	-9.6	1.37 H	332	32.1	32.3
2	2390.00	52.5 AV	54.0	-1.5	1.37 H	332	20.2	32.3
3	*2412.00	113.0 PK			1.80 H	331	80.7	32.3
4	*2412.00	103.1 AV			1.80 H	331	70.8	32.3
5	4824.00	44.9 PK	74.0	-29.1	1.81 H	165	41.5	3.4
6	4824.00	32.4 AV	54.0	-21.6	1.81 H	165	29.0	3.4
ANTENNA POLARITY & TEST DISTANCE: VERTICAL AT 3 M								
NO.	FREQ. (MHz)	EMISSION LEVEL (dBuV/m)	LIMIT (dBuV/m)	MARGIN (dB)	ANTENNA HEIGHT (m)	TABLE ANGLE (Degree)	RAW VALUE (dBuV)	CORRECTION FACTOR (dB/m)
1	2390.00	59.6 PK	74.0	-14.4	3.42 V	238	27.3	32.3
2	2390.00	48.4 AV	54.0	-5.6	3.42 V	238	16.1	32.3
3	*2412.00	106.4 PK			3.45 V	236	74.1	32.3
4	*2412.00	96.2 AV			3.45 V	236	63.9	32.3
5	4824.00	45.5 PK	74.0	-28.5	2.92 V	251	42.1	3.4
6	4824.00	31.6 AV	54.0	-22.4	2.92 V	251	28.2	3.4

REMARKS:

1. Emission Level(dBuV/m) = Raw Value(dBuV) + Correction Factor(dB/m)
2. Correction Factor(dB/m) = Antenna Factor(dB/m) + Cable Factor(dB)
3. The other emission levels were very low against the limit.
4. Margin value = Emission Level – Limit value
5. " * ": Fundamental frequency.

CHANNEL	TX Channel 6	DETECTOR FUNCTION	Peak (PK)
FREQUENCY RANGE	1GHz ~ 25GHz		Average (AV)

ANTENNA POLARITY & TEST DISTANCE: HORIZONTAL AT 3 M

NO.	FREQ. (MHz)	EMISSION LEVEL (dBuV/m)	LIMIT (dBuV/m)	MARGIN (dB)	ANTENNA HEIGHT (m)	TABLE ANGLE (Degree)	RAW VALUE (dBuV)	CORRECTION FACTOR (dB/m)
1	*2437.00	112.5 PK			1.59 H	328	80.2	32.3
2	*2437.00	102.5 AV			1.59 H	328	70.2	32.3
3	2483.50	65.8 PK	74.0	-8.2	1.52 H	327	33.4	32.4
4	2483.50	52.6 AV	54.0	-1.4	1.52 H	327	20.2	32.4
5	4874.00	49.6 PK	74.0	-24.4	1.60 H	167	45.9	3.7
6	4874.00	36.2 AV	54.0	-17.8	1.60 H	167	32.5	3.7

ANTENNA POLARITY & TEST DISTANCE: VERTICAL AT 3 M

NO.	FREQ. (MHz)	EMISSION LEVEL (dBuV/m)	LIMIT (dBuV/m)	MARGIN (dB)	ANTENNA HEIGHT (m)	TABLE ANGLE (Degree)	RAW VALUE (dBuV)	CORRECTION FACTOR (dB/m)
1	*2437.00	104.4 PK			3.64 V	278	72.1	32.3
2	*2437.00	94.5 AV			3.64 V	278	62.2	32.3
3	2483.50	60.0 PK	74.0	-14.0	3.60 V	280	27.6	32.4
4	2483.50	47.4 AV	54.0	-6.6	3.60 V	280	15.0	32.4
5	4874.00	46.0 PK	74.0	-28.0	2.86 V	253	42.3	3.7
6	4874.00	33.0 AV	54.0	-21.0	2.86 V	253	29.3	3.7

REMARKS:

1. Emission Level(dBuV/m) = Raw Value(dBuV) + Correction Factor(dB/m)
2. Correction Factor(dB/m) = Antenna Factor(dB/m) + Cable Factor(dB)
3. The other emission levels were very low against the limit.
4. Margin value = Emission Level – Limit value
5. " * " : Fundamental frequency.

CHANNEL	TX Channel 11	DETECTOR FUNCTION	Peak (PK)
FREQUENCY RANGE	1GHz ~ 25GHz		Average (AV)

ANTENNA POLARITY & TEST DISTANCE: HORIZONTAL AT 3 M

NO.	FREQ. (MHz)	EMISSION LEVEL (dBuV/m)	LIMIT (dBuV/m)	MARGIN (dB)	ANTENNA HEIGHT (m)	TABLE ANGLE (Degree)	RAW VALUE (dBuV)	CORRECTION FACTOR (dB/m)
1	*2462.00	111.0 PK			1.73 H	328	78.6	32.4
2	*2462.00	101.1 AV			1.73 H	328	68.7	32.4
3	2483.50	65.6 PK	74.0	-8.4	1.77 H	327	33.2	32.4
4	2483.50	52.7 AV	54.0	-1.3	1.77 H	327	20.3	32.4
5	4924.00	47.2 PK	74.0	-26.8	1.75 H	167	43.4	3.8
6	4924.00	33.6 AV	54.0	-20.4	1.75 H	167	29.8	3.8

ANTENNA POLARITY & TEST DISTANCE: VERTICAL AT 3 M

NO.	FREQ. (MHz)	EMISSION LEVEL (dBuV/m)	LIMIT (dBuV/m)	MARGIN (dB)	ANTENNA HEIGHT (m)	TABLE ANGLE (Degree)	RAW VALUE (dBuV)	CORRECTION FACTOR (dB/m)
1	*2462.00	104.3 PK			3.69 V	265	71.9	32.4
2	*2462.00	94.3 AV			3.69 V	265	61.9	32.4
3	2483.50	59.7 PK	74.0	-14.3	3.65 V	266	27.3	32.4
4	2483.50	47.7 AV	54.0	-6.3	3.65 V	266	15.3	32.4
5	4924.00	46.0 PK	74.0	-28.0	2.76 V	239	42.2	3.8
6	4924.00	33.0 AV	54.0	-21.0	2.76 V	239	29.2	3.8

REMARKS:

1. Emission Level(dBuV/m) = Raw Value(dBuV) + Correction Factor(dB/m)
2. Correction Factor(dB/m) = Antenna Factor(dB/m) + Cable Factor(dB)
3. The other emission levels were very low against the limit.
4. Margin value = Emission Level – Limit value
5. " * " : Fundamental frequency.

802.11n (HT20)

CHANNEL	TX Channel 1	DETECTOR FUNCTION	Peak (PK)
FREQUENCY RANGE	1GHz ~ 25GHz		Average (AV)

ANTENNA POLARITY & TEST DISTANCE: HORIZONTAL AT 3 M								
NO.	FREQ. (MHz)	EMISSION LEVEL (dBuV/m)	LIMIT (dBuV/m)	MARGIN (dB)	ANTENNA HEIGHT (m)	TABLE ANGLE (Degree)	RAW VALUE (dBuV)	CORRECTION FACTOR (dB/m)
1	2390.00	64.5 PK	74.0	-9.5	1.60 H	332	32.2	32.3
2	2390.00	52.5 AV	54.0	-1.5	1.60 H	332	20.2	32.3
3	*2412.00	113.2 PK			1.58 H	334	80.9	32.3
4	*2412.00	101.9 AV			1.58 H	334	69.6	32.3
5	4824.00	45.5 PK	74.0	-28.5	1.82 H	166	42.1	3.4
6	4824.00	31.9 AV	54.0	-22.1	1.82 H	166	28.5	3.4
ANTENNA POLARITY & TEST DISTANCE: VERTICAL AT 3 M								
NO.	FREQ. (MHz)	EMISSION LEVEL (dBuV/m)	LIMIT (dBuV/m)	MARGIN (dB)	ANTENNA HEIGHT (m)	TABLE ANGLE (Degree)	RAW VALUE (dBuV)	CORRECTION FACTOR (dB/m)
1	2390.00	58.6 PK	74.0	-15.4	3.85 V	262	26.3	32.3
2	2390.00	46.8 AV	54.0	-7.2	3.85 V	262	14.5	32.3
3	*2412.00	106.1 PK			3.87 V	259	73.8	32.3
4	*2412.00	95.2 AV			3.87 V	259	62.9	32.3
5	4824.00	45.2 PK	74.0	-28.8	2.66 V	253	41.8	3.4
6	4824.00	31.8 AV	54.0	-22.2	2.66 V	253	28.4	3.4

REMARKS:

1. Emission Level(dBuV/m) = Raw Value(dBuV) + Correction Factor(dB/m)
2. Correction Factor(dB/m) = Antenna Factor(dB/m) + Cable Factor(dB)
3. The other emission levels were very low against the limit.
4. Margin value = Emission Level – Limit value
5. " * " : Fundamental frequency.

CHANNEL	TX Channel 6	DETECTOR FUNCTION	Peak (PK)
FREQUENCY RANGE	1GHz ~ 25GHz		Average (AV)

ANTENNA POLARITY & TEST DISTANCE: HORIZONTAL AT 3 M

NO.	FREQ. (MHz)	EMISSION LEVEL (dBuV/m)	LIMIT (dBuV/m)	MARGIN (dB)	ANTENNA HEIGHT (m)	TABLE ANGLE (Degree)	RAW VALUE (dBuV)	CORRECTION FACTOR (dB/m)
1	*2437.00	112.7 PK			1.57 H	328	80.4	32.3
2	*2437.00	101.7 AV			1.57 H	328	69.4	32.3
3	2483.50	65.2 PK	74.0	-8.8	1.97 H	332	32.8	32.4
4	2483.50	52.6 AV	54.0	-1.4	1.97 H	332	20.2	32.4
5	4874.00	50.0 PK	74.0	-24.0	1.69 H	165	46.3	3.7
6	4874.00	35.4 AV	54.0	-18.6	1.69 H	165	31.7	3.7

ANTENNA POLARITY & TEST DISTANCE: VERTICAL AT 3 M

NO.	FREQ. (MHz)	EMISSION LEVEL (dBuV/m)	LIMIT (dBuV/m)	MARGIN (dB)	ANTENNA HEIGHT (m)	TABLE ANGLE (Degree)	RAW VALUE (dBuV)	CORRECTION FACTOR (dB/m)
1	*2437.00	105.9 PK			3.31 V	234	73.6	32.3
2	*2437.00	95.2 AV			3.31 V	234	62.9	32.3
3	2483.50	59.2 PK	74.0	-14.8	3.33 V	236	26.8	32.4
4	2483.50	46.7 AV	54.0	-7.3	3.33 V	236	14.3	32.4
5	4874.00	49.3 PK	74.0	-24.7	2.69 V	236	45.6	3.7
6	4874.00	35.7 AV	54.0	-18.3	2.69 V	236	32.0	3.7

REMARKS:

1. Emission Level(dBuV/m) = Raw Value(dBuV) + Correction Factor(dB/m)
2. Correction Factor(dB/m) = Antenna Factor(dB/m) + Cable Factor(dB)
3. The other emission levels were very low against the limit.
4. Margin value = Emission Level – Limit value
5. " * " : Fundamental frequency.

CHANNEL	TX Channel 11	DETECTOR FUNCTION	Peak (PK)
FREQUENCY RANGE	1GHz ~ 25GHz		Average (AV)

ANTENNA POLARITY & TEST DISTANCE: HORIZONTAL AT 3 M

NO.	FREQ. (MHz)	EMISSION LEVEL (dBuV/m)	LIMIT (dBuV/m)	MARGIN (dB)	ANTENNA HEIGHT (m)	TABLE ANGLE (Degree)	RAW VALUE (dBuV)	CORRECTION FACTOR (dB/m)
1	*2462.00	111.7 PK			1.71 H	327	79.3	32.4
2	*2462.00	100.7 AV			1.71 H	327	68.3	32.4
3	2483.50	67.0 PK	74.0	-7.0	1.56 H	333	34.6	32.4
4	2483.50	52.8 AV	54.0	-1.2	1.56 H	333	20.4	32.4
5	4924.00	46.8 PK	74.0	-27.2	1.67 H	167	43.0	3.8
6	4924.00	33.5 AV	54.0	-20.5	1.67 H	167	29.7	3.8

ANTENNA POLARITY & TEST DISTANCE: VERTICAL AT 3 M

NO.	FREQ. (MHz)	EMISSION LEVEL (dBuV/m)	LIMIT (dBuV/m)	MARGIN (dB)	ANTENNA HEIGHT (m)	TABLE ANGLE (Degree)	RAW VALUE (dBuV)	CORRECTION FACTOR (dB/m)
1	*2462.00	105.4 PK			3.72 V	263	73.0	32.4
2	*2462.00	93.8 AV			3.72 V	263	61.4	32.4
3	2483.50	61.0 PK	74.0	-13.0	3.69 V	266	28.6	32.4
4	2483.50	47.7 AV	54.0	-6.3	3.69 V	266	15.3	32.4
5	4924.00	46.2 PK	74.0	-27.8	2.69 V	229	42.4	3.8
6	4924.00	32.8 AV	54.0	-21.2	2.69 V	229	29.0	3.8

REMARKS:

1. Emission Level(dBuV/m) = Raw Value(dBuV) + Correction Factor(dB/m)
2. Correction Factor(dB/m) = Antenna Factor(dB/m) + Cable Factor(dB)
3. The other emission levels were very low against the limit.
4. Margin value = Emission Level – Limit value
5. " * " : Fundamental frequency.

802.11n (HT40)

CHANNEL	TX Channel 3	DETECTOR FUNCTION	Peak (PK)
FREQUENCY RANGE	1GHz ~ 25GHz		Average (AV)

ANTENNA POLARITY & TEST DISTANCE: HORIZONTAL AT 3 M

NO.	FREQ. (MHz)	EMISSION LEVEL (dBuV/m)	LIMIT (dBuV/m)	MARGIN (dB)	ANTENNA HEIGHT (m)	TABLE ANGLE (Degree)	RAW VALUE (dBuV)	CORRECTION FACTOR (dB/m)
1	2390.00	64.3 PK	74.0	-9.7	2.13 H	327	32.0	32.3
2	2390.00	52.5 AV	54.0	-1.5	2.13 H	327	20.2	32.3
3	*2422.00	108.8 PK			1.11 H	329	76.5	32.3
4	*2422.00	98.6 AV			1.11 H	329	66.3	32.3
5	4844.00	46.0 PK	74.0	-28.0	1.56 H	180	42.5	3.5
6	4844.00	33.0 AV	54.0	-21.0	1.56 H	180	29.5	3.5

ANTENNA POLARITY & TEST DISTANCE: VERTICAL AT 3 M

NO.	FREQ. (MHz)	EMISSION LEVEL (dBuV/m)	LIMIT (dBuV/m)	MARGIN (dB)	ANTENNA HEIGHT (m)	TABLE ANGLE (Degree)	RAW VALUE (dBuV)	CORRECTION FACTOR (dB/m)
1	2390.00	57.8 PK	74.0	-16.2	3.72 V	253	25.5	32.3
2	2390.00	45.6 AV	54.0	-8.4	3.72 V	253	13.3	32.3
3	*2422.00	99.5 PK			3.76 V	249	67.2	32.3
4	*2422.00	89.8 AV			3.76 V	249	57.5	32.3
5	4844.00	45.0 PK	74.0	-29.0	2.55 V	234	41.5	3.5
6	4844.00	31.9 AV	54.0	-22.1	2.55 V	234	28.4	3.5

REMARKS:

1. Emission Level(dBuV/m) = Raw Value(dBuV) + Correction Factor(dB/m)
2. Correction Factor(dB/m) = Antenna Factor(dB/m) + Cable Factor(dB)
3. The other emission levels were very low against the limit.
4. Margin value = Emission Level – Limit value
5. " * " : Fundamental frequency.

CHANNEL	TX Channel 6	DETECTOR FUNCTION	Peak (PK)
FREQUENCY RANGE	1GHz ~ 25GHz		Average (AV)

ANTENNA POLARITY & TEST DISTANCE: HORIZONTAL AT 3 M

NO.	FREQ. (MHz)	EMISSION LEVEL (dBuV/m)	LIMIT (dBuV/m)	MARGIN (dB)	ANTENNA HEIGHT (m)	TABLE ANGLE (Degree)	RAW VALUE (dBuV)	CORRECTION FACTOR (dB/m)
1	2390.00	58.4 PK	74.0	-15.6	2.59 H	321	26.1	32.3
2	2390.00	47.4 AV	54.0	-6.6	2.59 H	321	15.1	32.3
3	*2437.00	105.3 PK			1.75 H	331	73.0	32.3
4	*2437.00	95.6 AV			1.75 H	331	63.3	32.3
5	2483.50	63.6 PK	74.0	-10.4	2.25 H	333	31.2	32.4
6	2483.50	52.5 AV	54.0	-1.5	2.25 H	333	20.1	32.4
7	4874.00	45.7 PK	74.0	-28.3	1.62 H	186	42.0	3.7
8	4874.00	32.9 AV	54.0	-21.1	1.62 H	186	29.2	3.7

ANTENNA POLARITY & TEST DISTANCE: VERTICAL AT 3 M

NO.	FREQ. (MHz)	EMISSION LEVEL (dBuV/m)	LIMIT (dBuV/m)	MARGIN (dB)	ANTENNA HEIGHT (m)	TABLE ANGLE (Degree)	RAW VALUE (dBuV)	CORRECTION FACTOR (dB/m)
1	2390.00	56.1 PK	74.0	-17.9	3.32 V	236	23.8	32.3
2	2390.00	44.5 AV	54.0	-9.5	3.32 V	236	12.2	32.3
3	*2437.00	98.5 PK			3.31 V	235	66.2	32.3
4	*2437.00	88.2 AV			3.31 V	235	55.9	32.3
5	2483.50	57.2 PK	74.0	-16.8	3.33 V	239	24.8	32.4
6	2483.50	45.9 AV	54.0	-8.1	3.33 V	239	13.5	32.4
7	4874.00	45.4 PK	74.0	-28.6	2.54 V	263	41.7	3.7
8	4874.00	32.3 AV	54.0	-21.7	2.54 V	263	28.6	3.7

REMARKS:

1. Emission Level(dBuV/m) = Raw Value(dBuV) + Correction Factor(dB/m)
2. Correction Factor(dB/m) = Antenna Factor(dB/m) + Cable Factor(dB)
3. The other emission levels were very low against the limit.
4. Margin value = Emission Level – Limit value
5. " * ": Fundamental frequency.

CHANNEL	TX Channel 9	DETECTOR FUNCTION	Peak (PK)
FREQUENCY RANGE	1GHz ~ 25GHz		Average (AV)

ANTENNA POLARITY & TEST DISTANCE: HORIZONTAL AT 3 M

NO.	FREQ. (MHz)	EMISSION LEVEL (dBuV/m)	LIMIT (dBuV/m)	MARGIN (dB)	ANTENNA HEIGHT (m)	TABLE ANGLE (Degree)	RAW VALUE (dBuV)	CORRECTION FACTOR (dB/m)
1	*2452.00	107.2 PK			1.37 H	329	74.8	32.4
2	*2452.00	97.0 AV			1.37 H	329	64.6	32.4
3	2483.50	65.1 PK	74.0	-8.9	1.03 H	325	32.7	32.4
4	2483.50	52.4 AV	54.0	-1.6	1.03 H	325	20.0	32.4
5	4904.00	45.8 PK	74.0	-28.2	1.63 H	178	42.1	3.7
6	4904.00	33.1 AV	54.0	-20.9	1.63 H	178	29.4	3.7

ANTENNA POLARITY & TEST DISTANCE: VERTICAL AT 3 M

NO.	FREQ. (MHz)	EMISSION LEVEL (dBuV/m)	LIMIT (dBuV/m)	MARGIN (dB)	ANTENNA HEIGHT (m)	TABLE ANGLE (Degree)	RAW VALUE (dBuV)	CORRECTION FACTOR (dB/m)
1	*2452.00	100.1 PK			3.23 V	235	67.7	32.4
2	*2452.00	90.4 AV			3.23 V	235	58.0	32.4
3	2483.50	60.0 PK	74.0	-14.0	3.25 V	237	27.6	32.4
4	2483.50	47.6 AV	54.0	-6.4	3.25 V	237	15.2	32.4
5	4904.00	45.7 PK	74.0	-28.3	2.69 V	234	42.0	3.7
6	4904.00	32.3 AV	54.0	-21.7	2.69 V	234	28.6	3.7

REMARKS:

1. Emission Level(dBuV/m) = Raw Value(dBuV) + Correction Factor(dB/m)
2. Correction Factor(dB/m) = Antenna Factor(dB/m) + Cable Factor(dB)
3. The other emission levels were very low against the limit.
4. Margin value = Emission Level – Limit value
5. " * " : Fundamental frequency.

Below 1GHz worst-case data:

802.11b

CHANNEL	TX Channel 1	DETECTOR FUNCTION	Quasi-Peak (QP)
FREQUENCY RANGE	9kHz ~ 1GHz		

ANTENNA POLARITY & TEST DISTANCE: HORIZONTAL AT 3 M								
NO.	FREQ. (MHz)	EMISSION LEVEL (dBuV/m)	LIMIT (dBuV/m)	MARGIN (dB)	ANTENNA HEIGHT (m)	TABLE ANGLE (Degree)	RAW VALUE (dBuV)	CORRECTION FACTOR (dB/m)
1	69.77	30.9 QP	40.0	-9.1	1.00 H	325	42.4	-11.5
2	89.17	31.9 QP	43.5	-11.6	1.25 H	5	46.8	-14.9
3	161.92	34.3 QP	43.5	-9.2	1.50 H	153	43.4	-9.1
4	340.40	31.3 QP	46.0	-14.7	1.50 H	70	38.5	-7.2
5	372.41	36.1 QP	46.0	-9.9	1.25 H	213	42.3	-6.2
6	909.79	34.7 QP	46.0	-11.3	1.50 H	31	30.9	3.8

Remarks:

1. Emission Level(dBuV/m) = Raw Value(dBuV) + Correction Factor(dB/m)
2. Correction Factor(dB/m) = Antenna Factor(dB/m) + Cable Factor(dB)
3. The other emission levels were very low against the limit.
4. Margin value = Emission Level – Limit value
5. The emission levels were very low against the limit of frequency range 9kHz~30MHz: the amplitude of spurious emissions attenuated more than 20dB below the permissible value to be report.

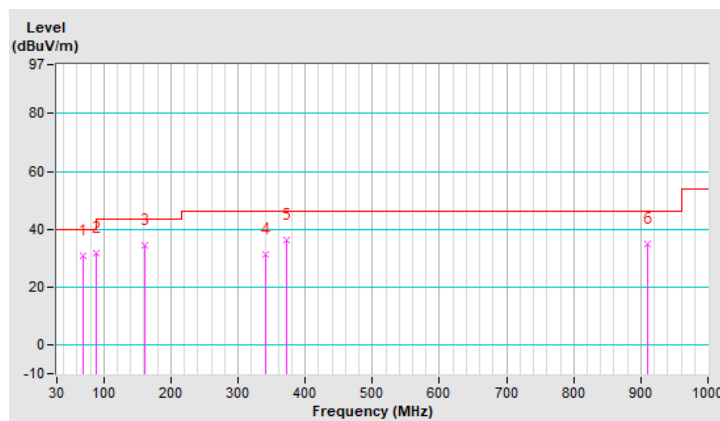

CHANNEL	TX Channel 1	DETECTOR FUNCTION	Quasi-Peak (QP)
FREQUENCY RANGE	9kHz ~ 1GHz		

ANTENNA POLARITY & TEST DISTANCE: VERTICAL AT 3 M								
NO.	FREQ. (MHz)	EMISSION LEVEL (dBuV/m)	LIMIT (dBuV/m)	MARGIN (dB)	ANTENNA HEIGHT (m)	TABLE ANGLE (Degree)	RAW VALUE (dBuV)	CORRECTION FACTOR (dB/m)
1	31.94	36.5 QP	40.0	-3.5	1.25 V	66	47.9	-11.4
2	66.86	32.7 QP	40.0	-7.3	1.00 V	53	43.6	-10.9
3	101.78	30.5 QP	43.5	-13.0	1.50 V	161	44.1	-13.6
4	167.74	29.6 QP	43.5	-13.9	1.25 V	59	38.9	-9.3
5	369.50	30.9 QP	46.0	-15.1	1.00 V	316	37.3	-6.4
6	909.79	34.8 QP	46.0	-11.2	1.00 V	148	31.0	3.8

Remarks:

1. Emission Level(dBuV/m) = Raw Value(dBuV) + Correction Factor(dB/m)
2. Correction Factor(dB/m) = Antenna Factor(dB/m) + Cable Factor(dB)
3. The other emission levels were very low against the limit.
4. Margin value = Emission Level – Limit value
5. The emission levels were very low against the limit of frequency range 9kHz~30MHz: the amplitude of spurious emissions attenuated more than 20dB below the permissible value to be report.

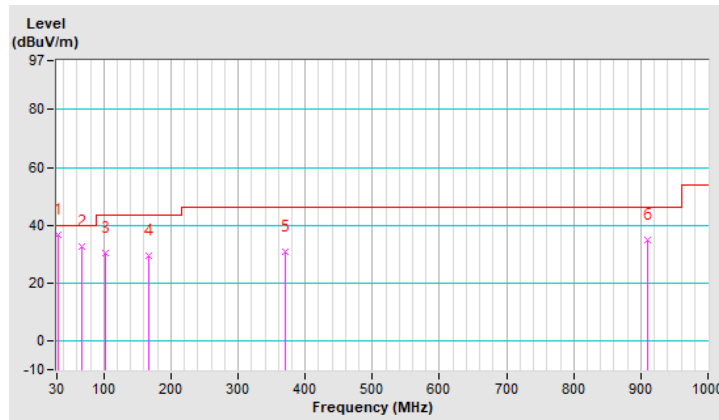

4.2 Conducted Emission Measurement

4.2.1 Limits of Conducted Emission Measurement

Frequency (MHz)	Conducted Limit (dBuV)	
	Quasi-peak	Average
0.15 - 0.5	66 - 56	56 - 46
0.50 - 5.0	56	46
5.0 - 30.0	60	50

- Note:** 1. The lower limit shall apply at the transition frequencies.
 2. The limit decreases in line with the logarithm of the frequency in the range of 0.15 to 0.50MHz.

4.2.2 Test Instruments

Description & Manufacturer	Model No.	Serial No.	Date Of Calibration	Due Date Of Calibration
Test Receiver ROHDE & SCHWARZ	ESCI	100613	Dec. 11, 2019	Dec. 10, 2020
RF signal cable Woken	5D-FB	Cable-cond1-01	Sep. 05, 2019	Sep. 04, 2020
LISN ROHDE & SCHWARZ (EUT)	ENV216	101826	Feb. 21, 2019	Feb. 20, 2020
LISN ROHDE & SCHWARZ (Peripheral)	ESH3-Z5	100311	Aug. 22, 2019	Aug. 21, 2020
Software ADT	BV ADT_Cond_ V7.3.7.4	NA	NA	NA

- Note:** 1. The calibration interval of the above test instruments is 12 months and the calibrations are traceable to NML/ROC and NIST/USA.
 2. The test was performed in HwaYa Shielded Room 1.
 3. The VCCI Site Registration No. is C-12040.

4.2.3 Test Procedures

- The EUT was placed 0.4 meters from the conducting wall of the shielded room with EUT being connected to the power mains through a line impedance stabilization network (LISN). Other support units were connected to the power mains through another LISN. The two LISNs provide 50 ohm/ 50uH of coupling impedance for the measuring instrument.
- Both lines of the power mains connected to the EUT were checked for maximum conducted interference.
- The frequency range from 150kHz to 30MHz was searched. Emission levels under (Limit - 20dB) was not recorded.

Note: The resolution bandwidth and video bandwidth of test receiver is 9kHz for quasi-peak detection (QP) and average detection (AV) at frequency 0.15MHz-30MHz.

4.2.4 Deviation from Test Standard

No deviation.

4.2.5 Test Setup

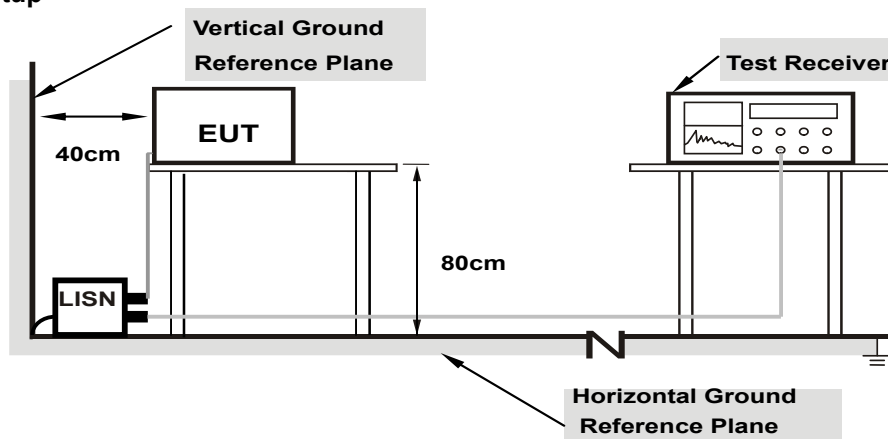

Note: 1.Support units were connected to second LISN.

For the actual test configuration, please refer to the attached file (Test Setup Photo).

4.2.6 EUT Operating Conditions

Same as 4.1.6.

4.2.7 Test Results

Worst-case data: 802.11b

Phase	Line (L)	Detector Function	Quasi-Peak (QP) / Average (AV)
-------	----------	-------------------	--------------------------------

No	Freq. [MHz]	Corr. Factor (dB)	Reading Value [dB (uV)]		Emission Level [dB (uV)]		Limit [dB (uV)]		Margin (dB)	
			Q.P.	AV.	Q.P.	AV.	Q.P.	AV.	Q.P.	AV.
			1	0.15687	10.15	23.70	12.11	33.85	22.26	65.63
2	0.44999	10.18	19.04	15.91	29.22	26.09	56.88	46.88	-27.66	-20.79
3	0.81800	10.24	12.46	7.29	22.70	17.53	56.00	46.00	-33.30	-28.47
4	5.16200	10.49	22.11	15.92	32.60	26.41	60.00	50.00	-27.40	-23.59
5	12.98200	10.59	28.67	27.18	39.26	37.77	60.00	50.00	-20.74	-12.23
6	14.70200	10.62	17.53	12.49	28.15	23.11	60.00	50.00	-31.85	-26.89

Remarks:

1. Q.P. and AV. are abbreviations of quasi-peak and average individually.
2. The emission levels of other frequencies were very low against the limit.
3. Margin value = Emission level - Limit value
4. Correction factor = Insertion loss + Cable loss
5. Emission Level = Correction Factor + Reading Value.

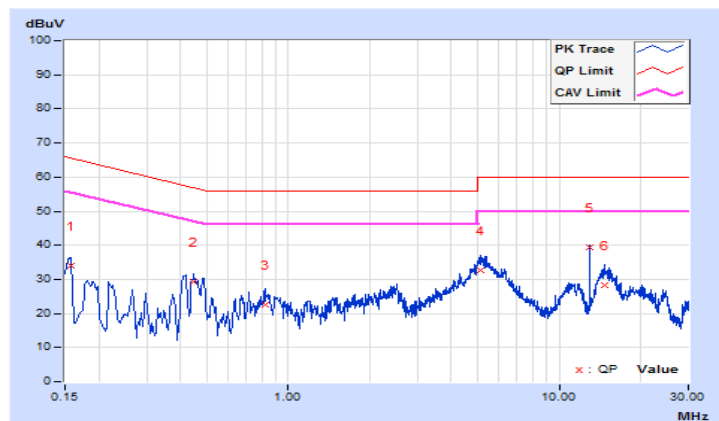

Phase	Neutral (N)	Detector Function	Quasi-Peak (QP) / Average (AV)
-------	-------------	-------------------	--------------------------------

No	Freq. [MHz]	Corr. Factor (dB)	Reading Value [dB (uV)]		Emission Level [dB (uV)]		Limit [dB (uV)]		Margin (dB)	
			Q.P.	AV.	Q.P.	AV.	Q.P.	AV.	Q.P.	AV.
			1	0.15400	10.13	29.31	19.19	39.44	29.32	65.78
2	0.18600	10.13	26.93	16.90	37.06	27.03	64.21	54.21	-27.15	-27.18
3	0.44600	10.18	21.31	16.51	31.49	26.69	56.95	46.95	-25.46	-20.26
4	5.17400	10.47	20.46	15.76	30.93	26.23	60.00	50.00	-29.07	-23.77
5	12.97800	10.62	28.65	28.20	39.27	38.82	60.00	50.00	-20.73	-11.18
6	14.59800	10.67	19.44	15.97	30.11	26.64	60.00	50.00	-29.89	-23.36

Remarks:

1. Q.P. and AV. are abbreviations of quasi-peak and average individually.
2. The emission levels of other frequencies were very low against the limit.
3. Margin value = Emission level - Limit value
4. Correction factor = Insertion loss + Cable loss
5. Emission Level = Correction Factor + Reading Value.

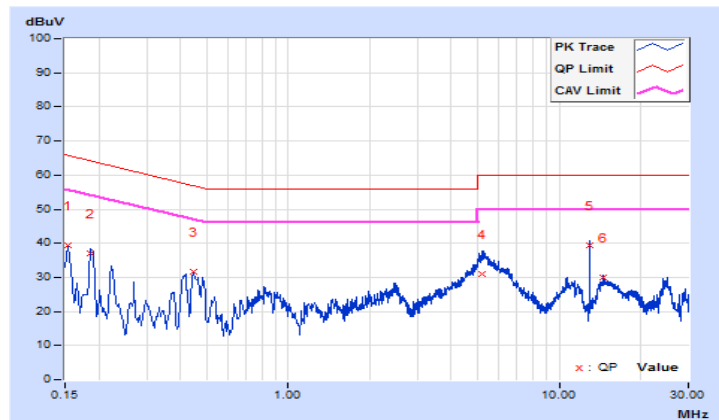

4.3 6dB Bandwidth Measurement

4.3.1 Limits of 6dB Bandwidth Measurement

The minimum of 6dB Bandwidth Measurement is 0.5 MHz.

4.3.2 Test Setup

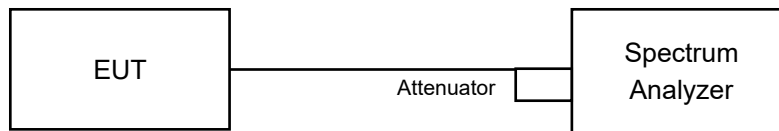

4.3.3 Test Instruments

Refer to section 4.1.2 to get information of above instrument.

4.3.4 Test Procedure

- a. Set resolution bandwidth (RBW) = 100kHz
- b. Set the video bandwidth (VBW) $\geq 3 \times$ RBW, Detector = average.
- c. Trace mode = max hold.
- d. Sweep = auto couple.
- e. Measure the maximum width of the emission that is constrained by the frequencies associated with the two amplitude points (upper and lower) that are attenuated by 6 dB relative to the maximum level measured in the fundamental emission

4.3.5 Deviation from Test Standard

No deviation.

4.3.6 EUT Operating Conditions

The software provided by client to enable the EUT under transmission condition continuously at lowest, middle and highest channel frequencies individually.

4.3.7 Test Result

802.11b

Channel	Frequency (MHz)	6dB Bandwidth (MHz)		Minimum Limit (MHz)	Pass / Fail
		Chain 0	Chain 1		
1	2412	7.67	8.10	0.5	Pass
6	2437	10.12	9.13	0.5	Pass
11	2462	8.12	7.08	0.5	Pass

802.11g

Channel	Frequency (MHz)	6dB Bandwidth (MHz)		Minimum Limit (MHz)	Pass / Fail
		Chain 0	Chain 1		
1	2412	15.51	15.75	0.5	Pass
6	2437	15.77	16.42	0.5	Pass
11	2462	15.74	15.79	0.5	Pass

802.11n (HT20)

Channel	Frequency (MHz)	6dB Bandwidth (MHz)		Minimum Limit (MHz)	Pass / Fail
		Chain 0	Chain 1		
1	2412	15.94	15.80	0.5	Pass
6	2437	16.41	17.08	0.5	Pass
11	2462	16.38	15.78	0.5	Pass

802.11n (HT40)

Channel	Frequency (MHz)	6dB Bandwidth (MHz)		Minimum Limit (MHz)	Pass / Fail
		Chain 0	Chain 1		
3	2422	35.18	35.26	0.5	Pass
6	2437	35.77	36.45	0.5	Pass
9	2452	35.85	30.78	0.5	Pass

Spectrum Plot of Worst Value

802.11b

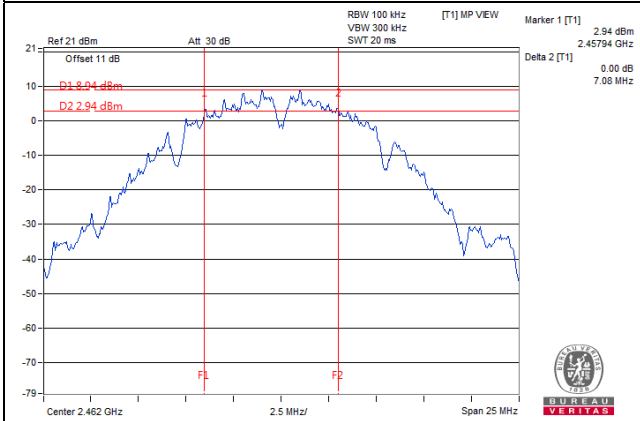

802.11g

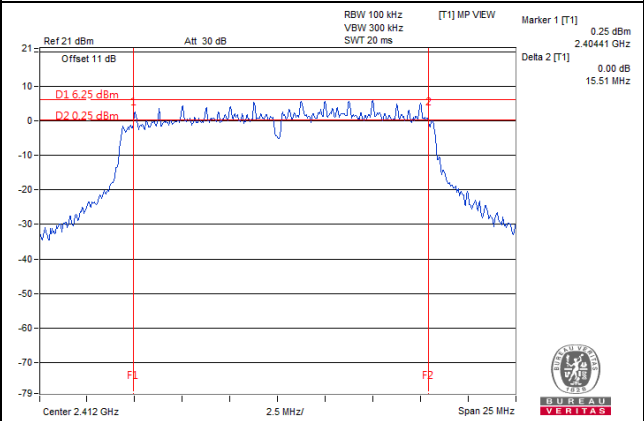

802.11n (HT20)

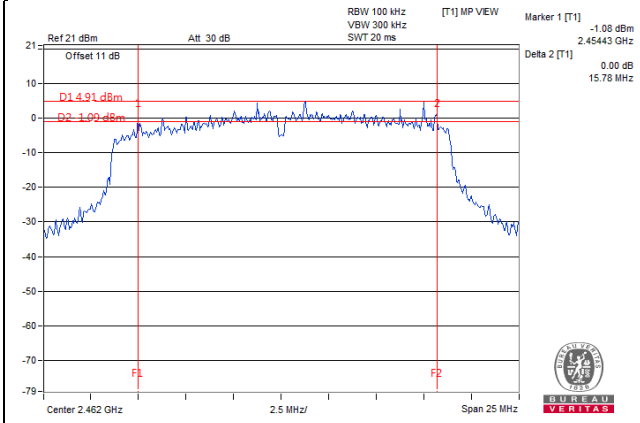

802.11n (HT40)

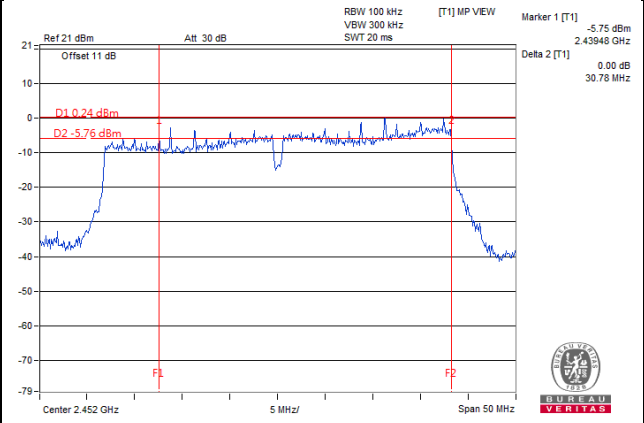

4.4 Conducted Output Power Measurement

4.4.1 Limits of Conducted Output Power Measurement

For systems using digital modulation in the 2400–2483.5 MHz bands: 1 Watt (30dBm)

Per KDB 662911 D01 Multiple Transmitter Output Method of conducted output power measurement on IEEE 802.11 devices,

Array Gain = 0 dB (i.e., no array gain) for $N_{ANT} \leq 4$;

Array Gain = 0 dB (i.e., no array gain) for channel widths ≥ 40 MHz for any N_{ANT} ;

Array Gain = $5 \log(N_{ANT}/N_{SS})$ dB or 3 dB, whichever is less for 20-MHz channel widths with $N_{ANT} \geq 5$.

For power measurements on all other devices: Array Gain = $10 \log(N_{ANT}/N_{SS})$ dB.

4.4.2 Test Setup

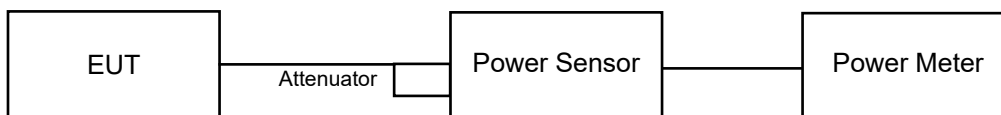

4.4.3 Test Instruments

Refer to section 4.1.2 to get information of above instrument.

4.4.4 Test Procedures

An average power sensor was used on the output port of the EUT. A power meter was used to read the response of the average power sensor. Record the power level.

4.4.5 Deviation from Test Standard

No deviation.

4.4.6 EUT Operating Conditions

Same as Item 4.3.6.

4.4.7 Test Results

CDD Mode

802.11b

Chan.	Freq. (MHz)	Average Power (dBm)		Total Power (mW)	Total Power (dBm)	Limit (dBm)	Pass / Fail
		Chain 0	Chain 1				
1	2412	23.02	24.12	458.673	26.62	30	Pass
6	2437	19.53	19.52	179.279	22.54	30	Pass
11	2462	19.65	19.52	181.793	22.60	30	Pass

802.11g

Chan.	Freq. (MHz)	Average Power (dBm)		Total Power (mW)	Total Power (dBm)	Limit (dBm)	Pass / Fail
		Chain 0	Chain 1				
1	2412	18.99	19.19	162.235	22.10	30	Pass
6	2437	18.54	18.91	149.254	21.74	30	Pass
11	2462	16.46	17.08	95.309	19.79	30	Pass

802.11n (HT20)

Chan.	Freq. (MHz)	Average Power (dBm)		Total Power (mW)	Total Power (dBm)	Limit (dBm)	Pass / Fail
		Chain 0	Chain 1				
1	2412	18.37	18.90	146.332	21.65	30	Pass
6	2437	18.44	19.04	149.991	21.76	30	Pass
11	2462	16.13	17.31	94.847	19.77	30	Pass

802.11n (HT40)

Chan.	Freq. (MHz)	Average Power (dBm)		Total Power (mW)	Total Power (dBm)	Limit (dBm)	Pass / Fail
		Chain 0	Chain 1				
3	2422	16.03	16.01	79.989	19.03	30	Pass
6	2437	14.69	14.94	60.633	17.83	30	Pass
9	2452	14.33	14.84	57.581	17.60	30	Pass

Beamforming Mode

802.11n (HT20)

Chan.	Freq. (MHz)	Average Power (dBm)		Total Power (mW)	Total Power (dBm)	Limit (dBm)	Pass / Fail
		Chain 0	Chain 1				
1	2412	15.36	15.89	77.601	18.90	29.80	Pass
6	2437	15.43	16.03	184.818	22.67	29.80	Pass
11	2462	13.12	14.30	85.956	19.34	29.80	Pass

Note: Directional gain = $3.19\text{dBi} + 10\log(2) = 6.20\text{dBi} > 6\text{dBi}$, so the limit shall be reduced to $30 - (6.20 - 6) = 29.80\text{dBm}$.

802.11n (HT40)

Chan.	Freq. (MHz)	Average Power (dBm)		Total Power (mW)	Total Power (dBm)	Limit (dBm)	Pass / Fail
		Chain 0	Chain 1				
3	2422	13.02	13.00	57.566	17.60	29.80	Pass
6	2437	11.68	11.93	79.367	19.00	29.80	Pass
9	2452	11.32	11.83	68.688	18.37	29.80	Pass

Note: Directional gain = $3.19\text{dBi} + 10\log(2) = 6.20\text{dBi} > 6\text{dBi}$, so the limit shall be reduced to $30 - (6.20 - 6) = 29.80\text{dBm}$.

4.5 Power Spectral Density Measurement

4.5.1 Limits of Power Spectral Density Measurement

The Maximum of Power Spectral Density Measurement is 8dBm in any 3 kHz.

4.5.2 Test Setup

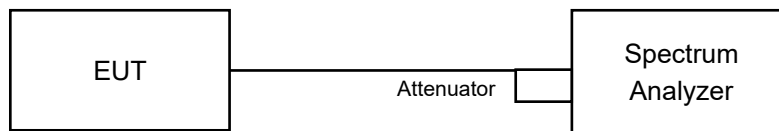

4.5.3 Test Instruments

Refer to section 4.1.2 to get information of above instrument.

4.5.4 Test Procedure

For duty cycle $\geq 98\%$

- Set instrument center frequency to DTS channel center frequency.
- Set span to at least 1.5 times the OBW.
- Set RBW to: $3 \text{ kHz} \leq \text{RBW} \leq 100 \text{ kHz}$.
- Set VBW $\geq 3 \times \text{RBW}$.
- Detector = power averaging (RMS) or sample detector (when RMS not available).
- Ensure that the number of measurement points in the sweep $\geq 2 \times \text{span}/\text{RBW}$.
- Sweep time = auto couple.
- Employ trace averaging (RMS) mode over a minimum of 100 traces.
- Use the peak marker function to determine the maximum amplitude level.

For duty cycle $< 98\%$

- Measure the duty cycle (x).
- Set instrument center frequency to DTS channel center frequency.
- Set span to at least 1.5 times the OBW.
- Set RBW to: $3 \text{ kHz} \leq \text{RBW} \leq 100 \text{ kHz}$.
- Set VBW $\geq 3 \times \text{RBW}$.
- Detector = power averaging (RMS) or sample detector (when RMS not available).
- Ensure that the number of measurement points in the sweep $\geq 2 \times \text{span}/\text{RBW}$.
- Sweep time = auto couple.
- Do not use sweep triggering. Allow sweep to “free run”.
- Employ trace averaging (RMS) mode over a minimum of 100 traces.
- Use the peak marker function to determine the maximum amplitude level.
- Add $10 \log (1/x)$, where x is the duty cycle measured in step (a), to the measured PSD to compute the average PSD during the actual transmission time.

4.5.5 Deviation from Test Standard

No deviation.

4.5.6 EUT Operating Condition

Same as Item 4.3.6

4.5.7 Test Results

802.11b

TX chain	Chan.	Frequency (MHz)	PSD (dBm/3kHz)	10 log (N=2) dB	Total PSD (dBm/3kHz)	Limit (dBm/3kHz)	Pass / Fail
0	1	2412	-9.61	3.01	-6.60	7.80	Pass
	6	2437	-16.01	3.01	-13.00	7.80	Pass
	11	2462	-13.56	3.01	-10.55	7.80	Pass
1	1	2412	-10.34	3.01	-7.33	7.80	Pass
	6	2437	-15.52	3.01	-12.51	7.80	Pass
	11	2462	-12.83	3.01	-9.82	7.80	Pass

Note:

- Method E) 2) c) of power density measurement of KDB 662911 is using for calculating total power density.
- Directional gain = $3.19\text{dBi} + 10\log(2) = 6.20\text{dBi} > 6\text{dBi}$, so the power density limit shall be reduced to $8 - (6.20 - 6) = 7.80\text{dBm}$.

802.11g

TX chain	Channel	Frequency (MHz)	PSD (dBm/3kHz)	10 log (N=2) dB	Duty Factor (dB)	Total PSD (dBm/3kHz)	Limit (dBm/3kHz)	Pass / Fail
0	1	2412	-19.63	3.01	0.20	-16.42	7.80	Pass
	6	2437	-20.26	3.01	0.20	-17.05	7.80	Pass
	11	2462	-22.17	3.01	0.20	-18.96	7.80	Pass
1	1	2412	-18.79	3.01	0.20	-15.58	7.80	Pass
	6	2437	-18.92	3.01	0.20	-15.71	7.80	Pass
	11	2462	-20.50	3.01	0.20	-17.29	7.80	Pass

Note:

- Method E) 2) c) of power density measurement of KDB 662911 is using for calculating total power density.
- Directional gain = $3.19\text{dBi} + 10\log(2) = 6.20\text{dBi} > 6\text{dBi}$, so the power density limit shall be reduced to $8 - (6.20 - 6) = 7.80\text{dBm}$.
- Refer to section 3.3 for duty cycle spectrum plot.

802.11n (HT20)

TX chain	Channel	Frequency (MHz)	PSD (dBm/3kHz)	10 log (N=2) dB	Duty Factor (dB)	Total PSD (dBm/3kHz)	Limit (dBm/3kHz)	Pass / Fail
0	1	2412	-20.33	3.01	0.39	-16.93	7.80	Pass
	6	2437	-20.65	3.01	0.39	-17.25	7.80	Pass
	11	2462	-23.16	3.01	0.39	-19.76	7.80	Pass
1	1	2412	-19.41	3.01	0.39	-16.01	7.80	Pass
	6	2437	-20.07	3.01	0.39	-16.67	7.80	Pass
	11	2462	-21.13	3.01	0.39	-17.73	7.80	Pass

Note:

1. Method E) 2) c) of power density measurement of KDB 662911 is using for calculating total power density.
2. Directional gain = $3.19\text{dBi} + 10\log(2) = 6.20\text{dBi} > 6\text{dBi}$, so the power density limit shall be reduced to $8 - (6.20 - 6) = 7.80\text{dBm}$.
3. Refer to section 3.3 for duty cycle spectrum plot.

802.11n (HT40)

TX chain	Channel	Frequency (MHz)	PSD (dBm/3kHz)	10 log (N=2) dB	Duty Factor (dB)	Total PSD (dBm/3kHz)	Limit (dBm/3kHz)	Pass / Fail
0	3	2422	-26.42	3.01	0.75	-22.66	7.80	Pass
	6	2437	-27.68	3.01	0.75	-23.92	7.80	Pass
	9	2452	-27.65	3.01	0.75	-23.89	7.80	Pass
1	3	2422	-25.59	3.01	0.75	-21.83	7.80	Pass
	6	2437	-28.24	3.01	0.75	-24.48	7.80	Pass
	9	2452	-25.87	3.01	0.75	-22.11	7.80	Pass

Note:

1. Method E) 2) c) of power density measurement of KDB 662911 is using for calculating total power density.
2. Directional gain = $3.19\text{dBi} + 10\log(2) = 6.20\text{dBi} > 6\text{dBi}$, so the power density limit shall be reduced to $8 - (6.20 - 6) = 7.80\text{dBm}$.
3. Refer to section 3.3 for duty cycle spectrum plot.

Spectrum Plot of Worst Value

802.11b

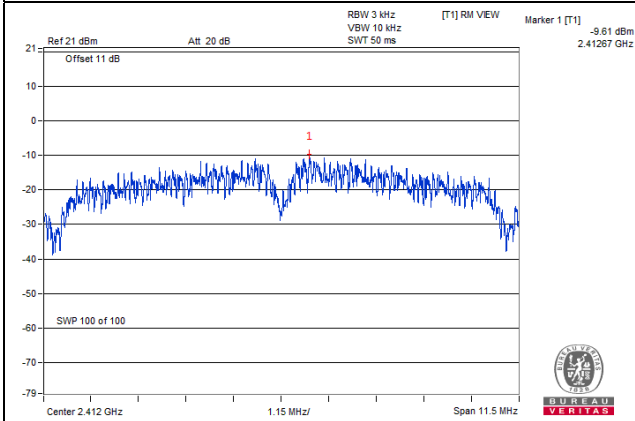

802.11g

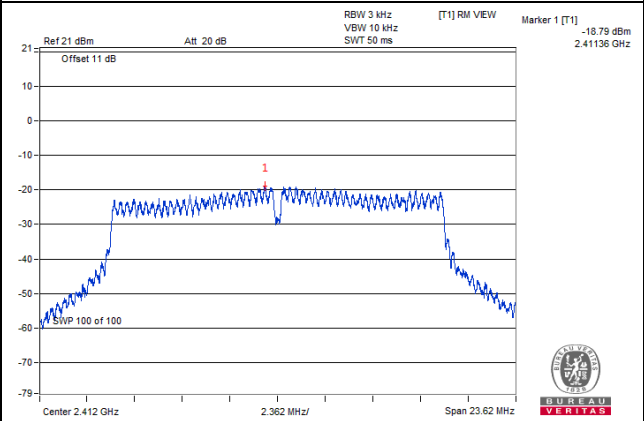

802.11n (HT20)

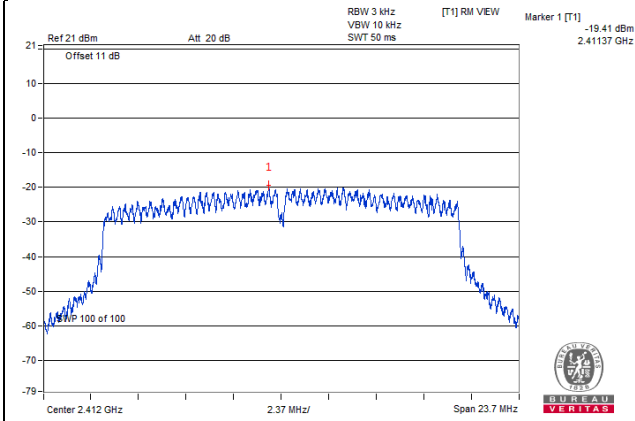

802.11n (HT40)

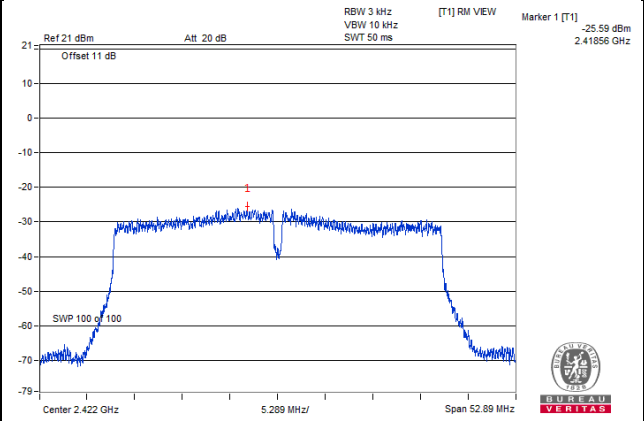

4.6 Conducted Out of Band Emission Measurement

4.6.1 Limits of Conducted Out of Band Emission Measurement

Below 30dB of the highest emission level of operating band (in 100kHz Resolution Bandwidth).

4.6.2 Test Setup

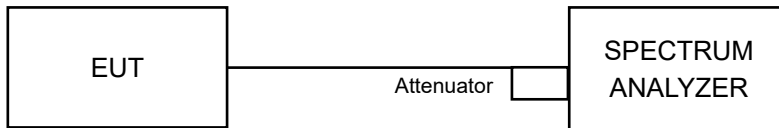

4.6.3 Test Instruments

Refer to section 4.1.2 to get information of above instrument.

4.6.4 Test Procedure

MEASUREMENT PROCEDURE REF

- Set the RBW = 100 kHz.
- Set the VBW \geq 300 kHz.
- Detector = peak.
- Sweep time = auto couple.
- Trace mode = max hold.
- Allow trace to fully stabilize.
- Use the peak marker function to determine the maximum power level in any 100 kHz band segment within the fundamental EBW.

MEASUREMENT PROCEDURE OOBE

- Set RBW = 100 kHz.
- Set VBW \geq 300 kHz.
- Ensure that the number of measurement points \geq span/RBW
- According to measurement points to set differ measurement span.
- Detector = peak.
- Trace Mode = max hold.
- Sweep = auto couple.

4.6.5 Deviation from Test Standard

No deviation.

4.6.6 EUT Operating Condition

Same as Item 4.3.6

4.6.7 Test Results

The conducted emission test is performed on each TX port of operating mode without summing or adding $10\log(N)$ since the limit is relative emission limit.

The spectrum plots are attached on the following pages. D1 line indicates the highest level, and D2 line indicates the 30dB offset below D1. It shows compliance with the requirement.

802.11b_Chain 0

CH 1

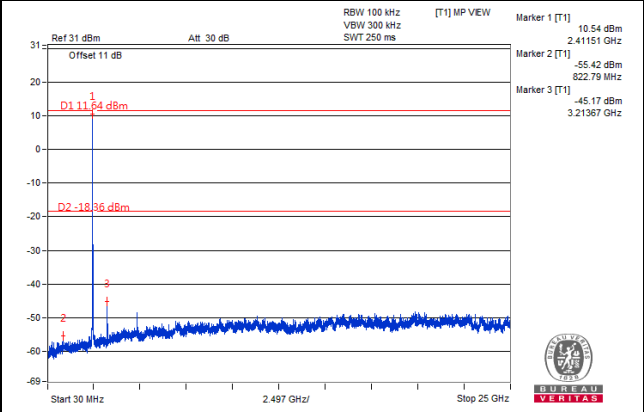
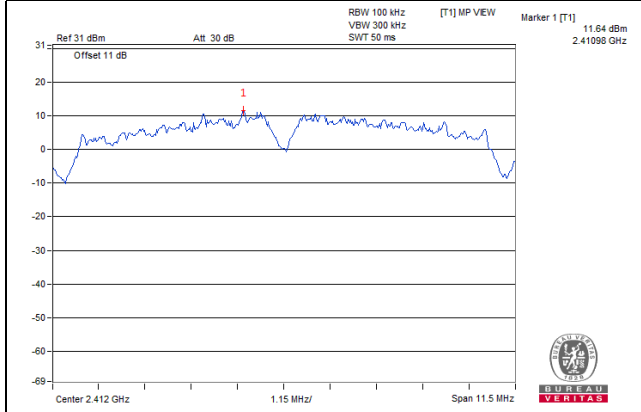

CH 6

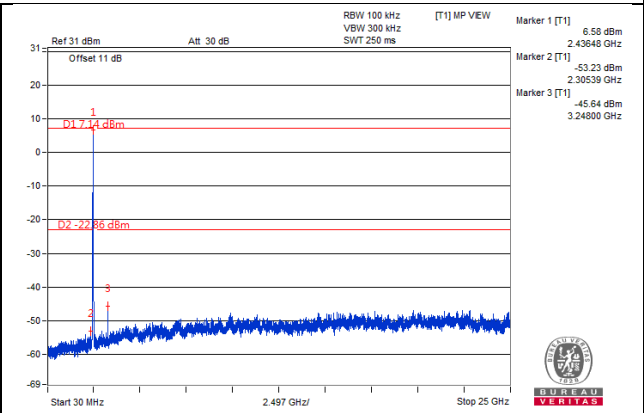
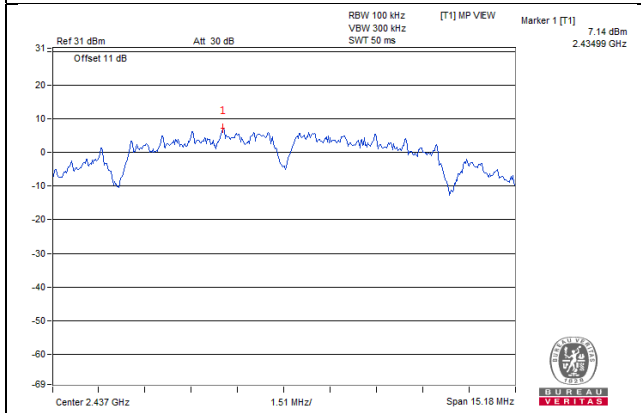

CH 11

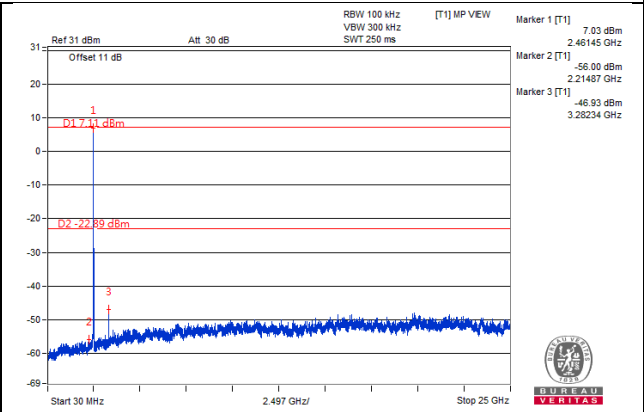
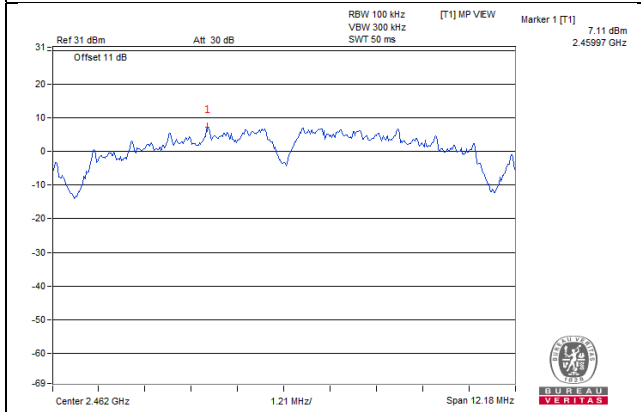

CH 1 Band edge

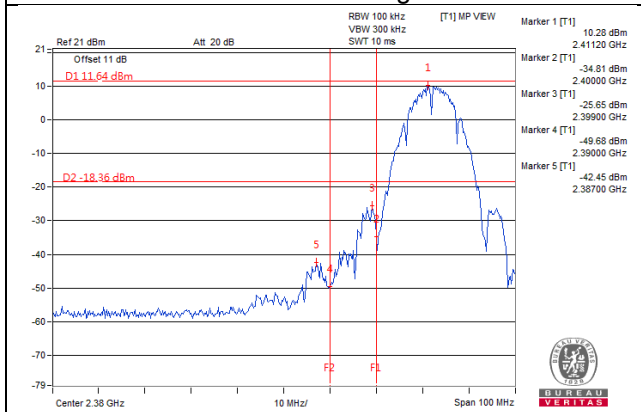

CH 11 Band edge

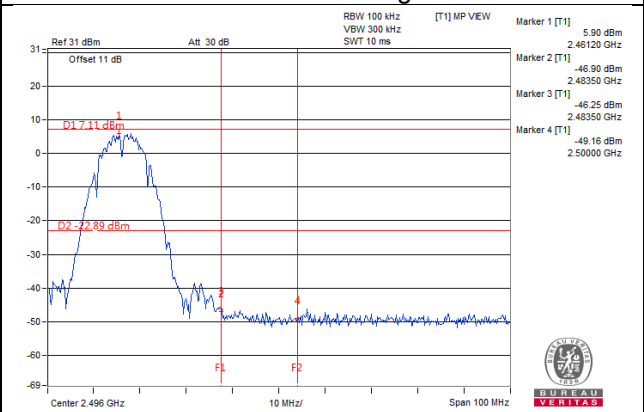

802.11b_Chain 1

CH 1

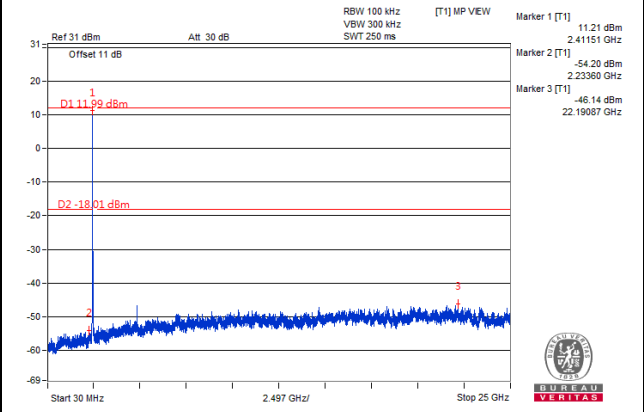
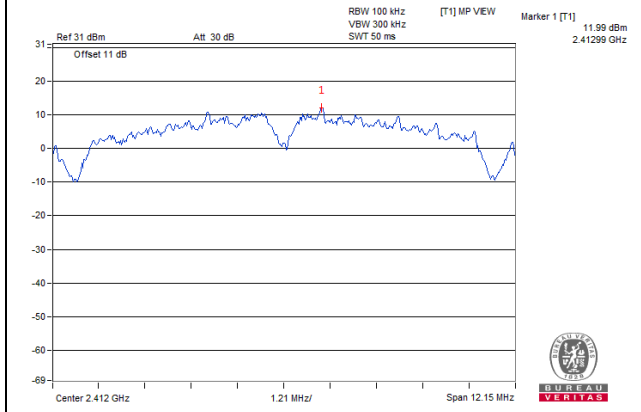

CH 6

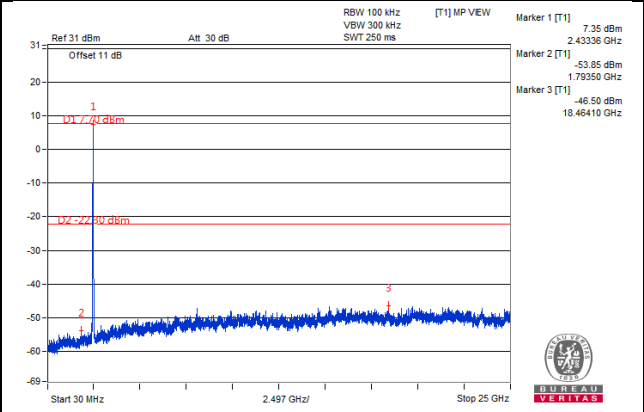
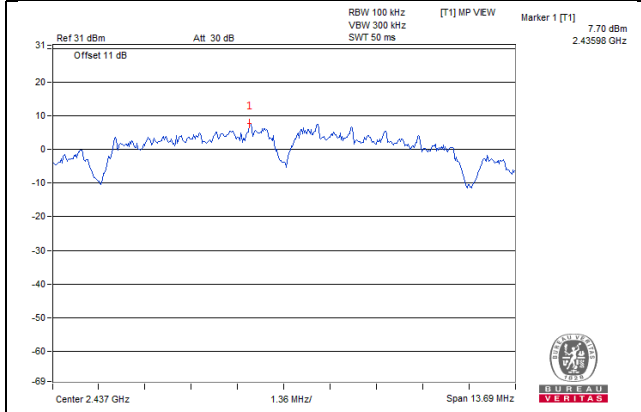

CH 11

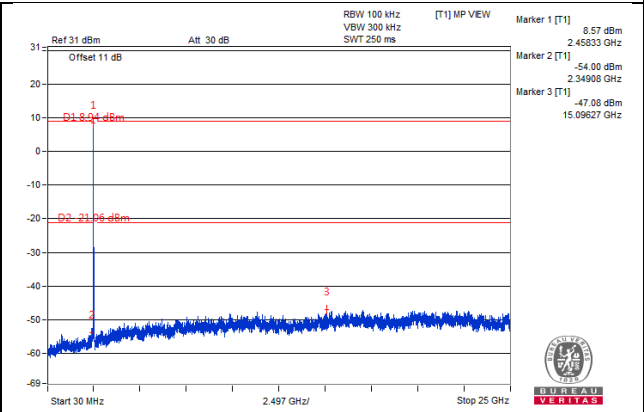
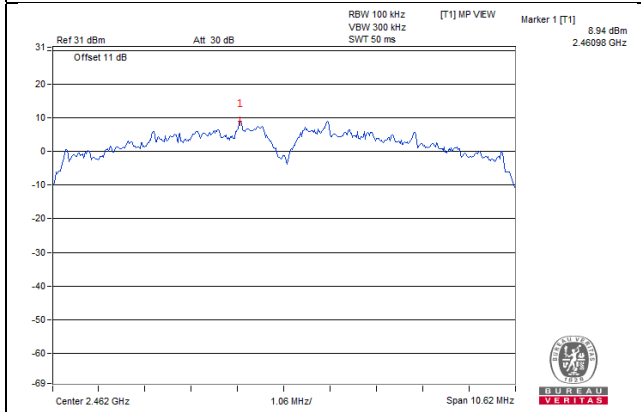

CH 1 Band edge

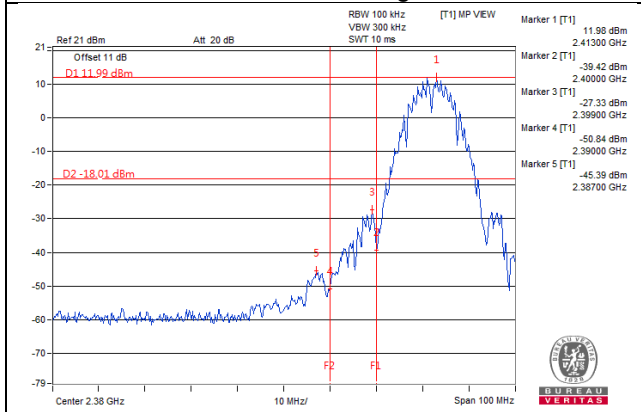

CH 11 Band edge

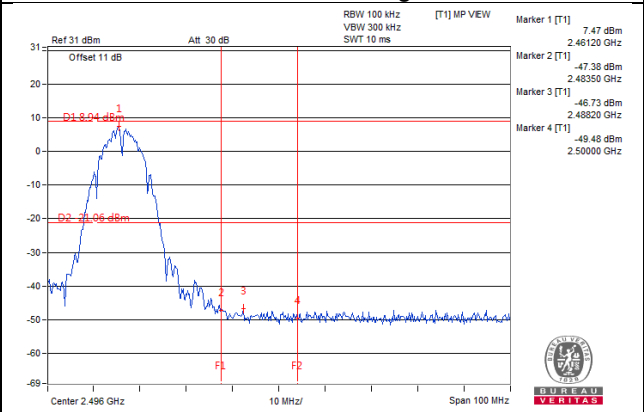

802.11g_Chain 0

CH 1

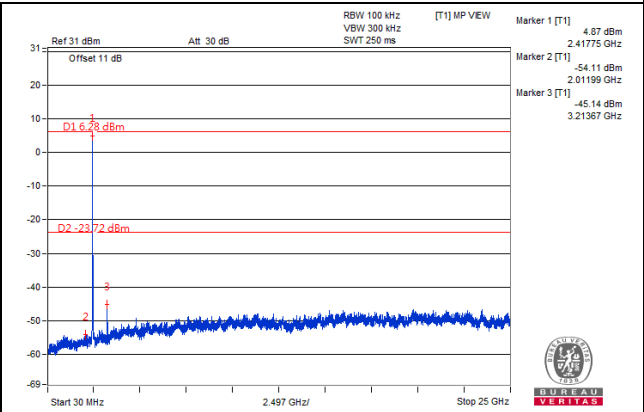
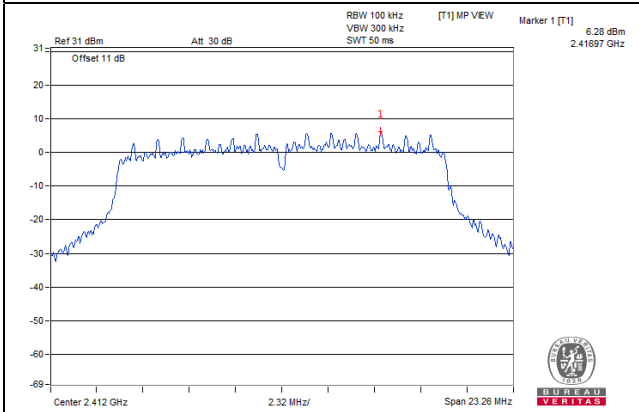

CH 6

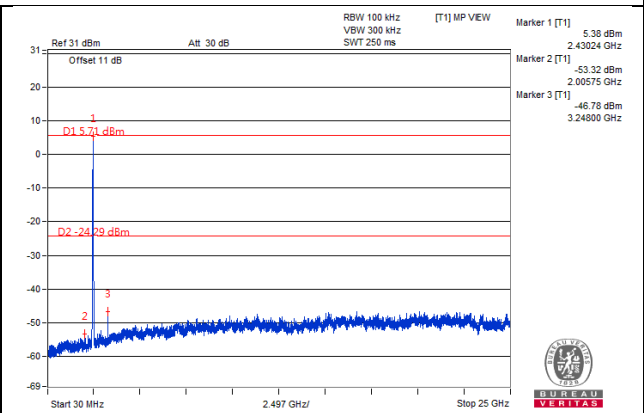
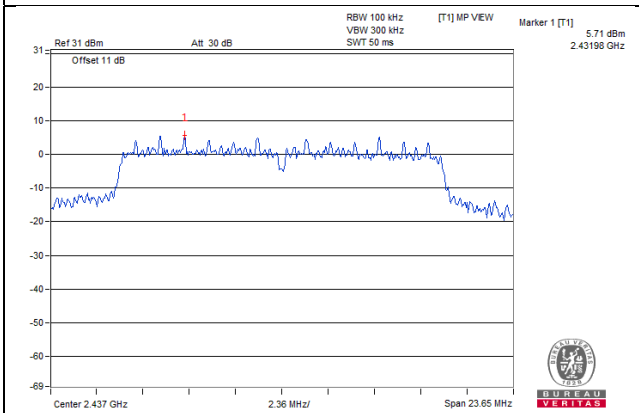

CH 11

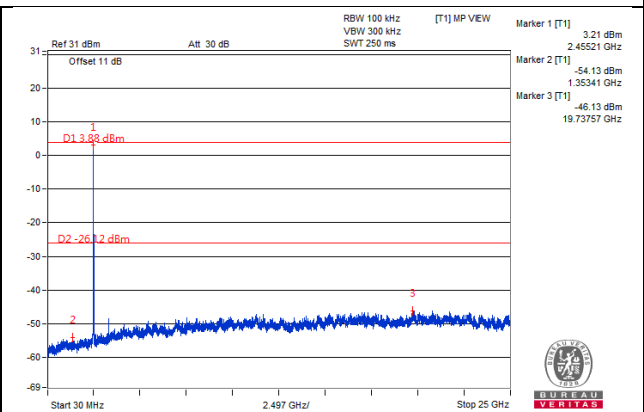
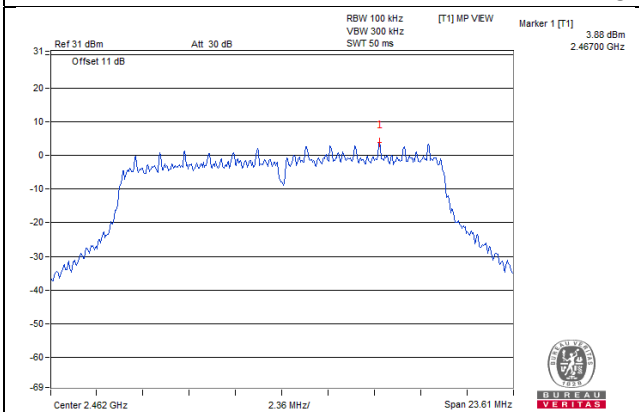

CH 1 Band edge

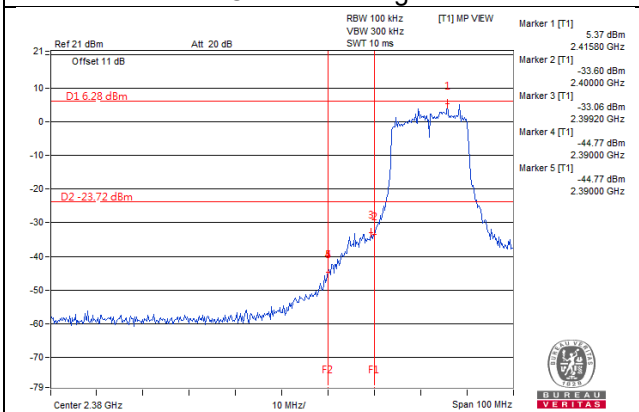

CH 11 Band edge

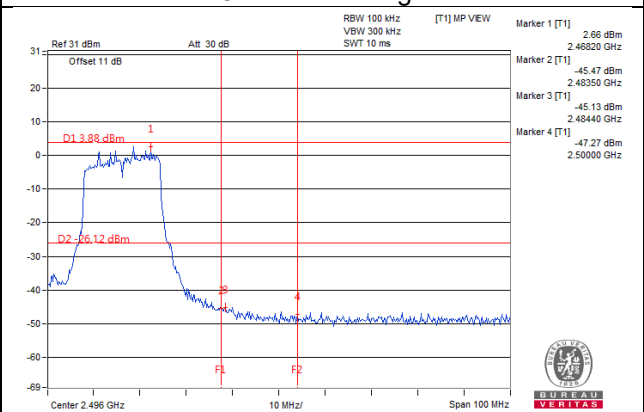

802.11g_Chain 1

CH 1

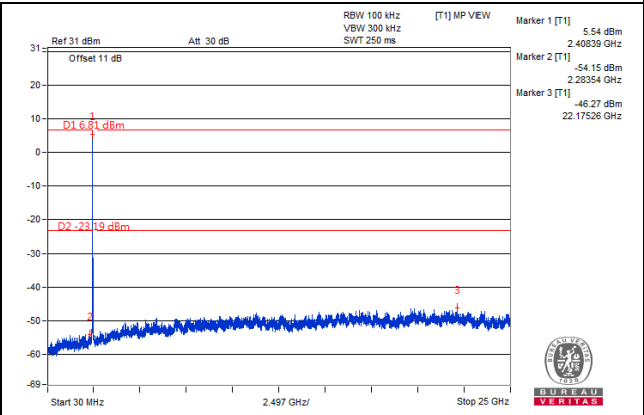
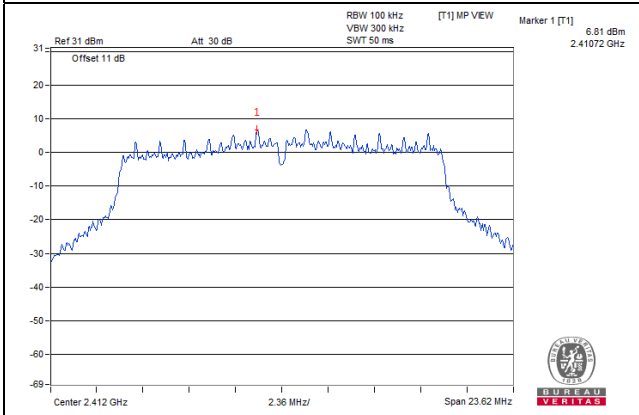

CH 6

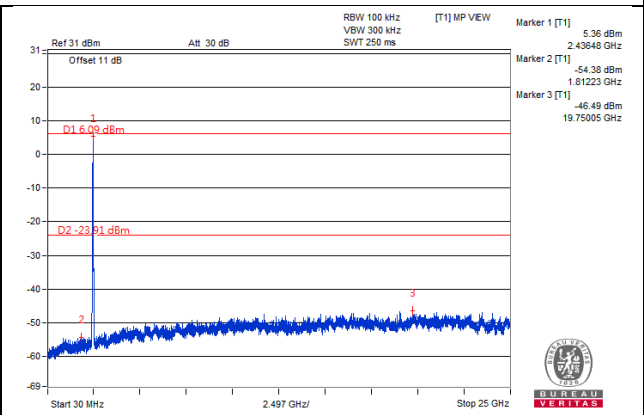
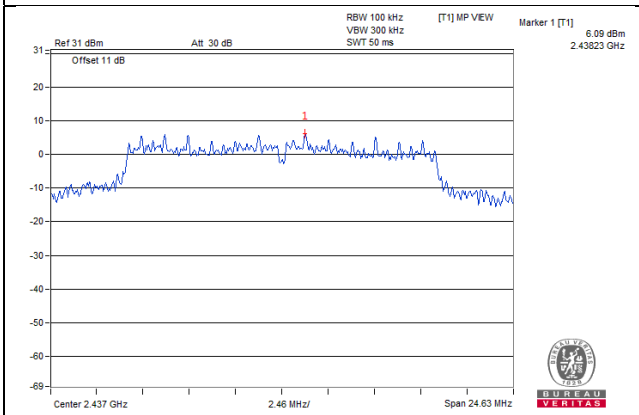

CH 11

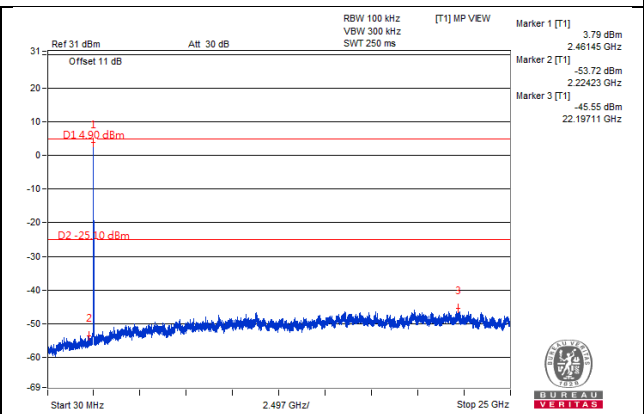
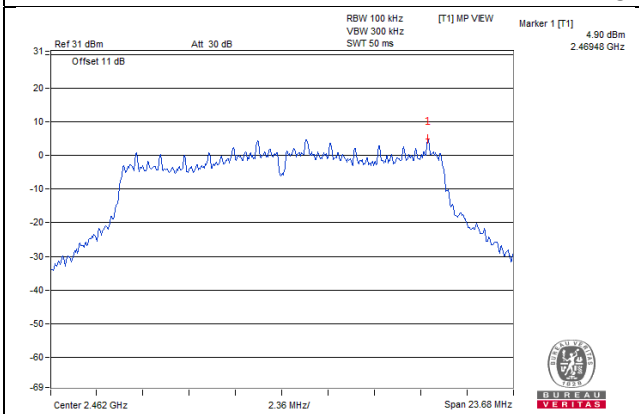

CH 1 Band edge

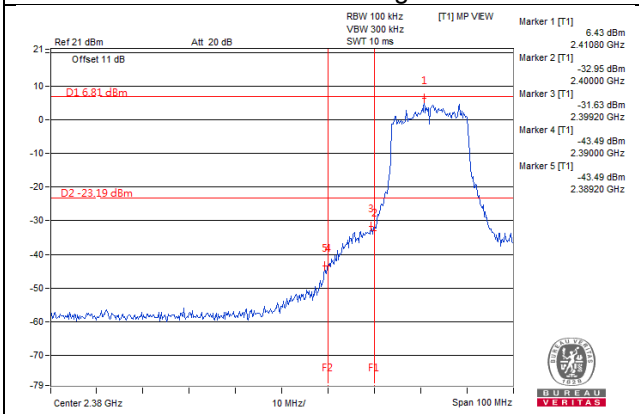

CH 11 Band edge

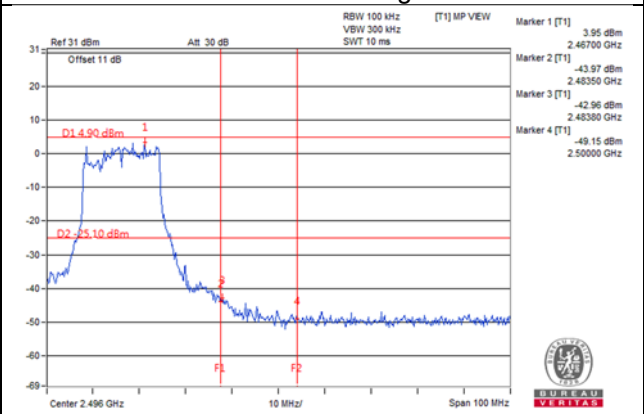

802.11n (HT20)_Chain 0

CH 1

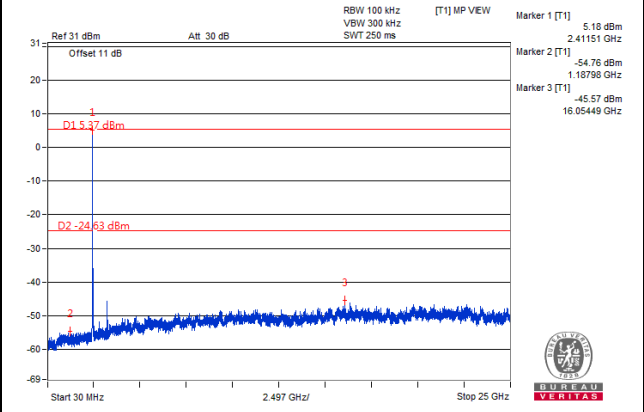
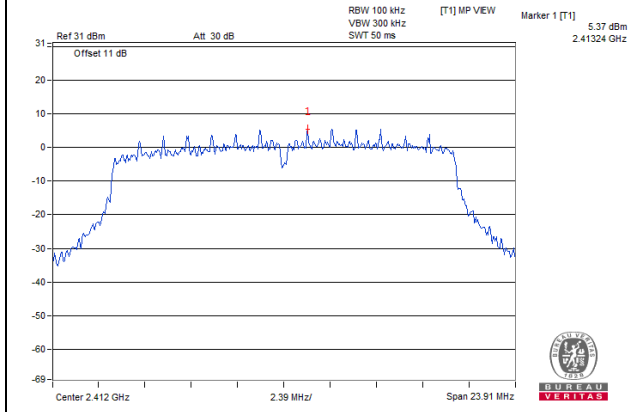

CH 6

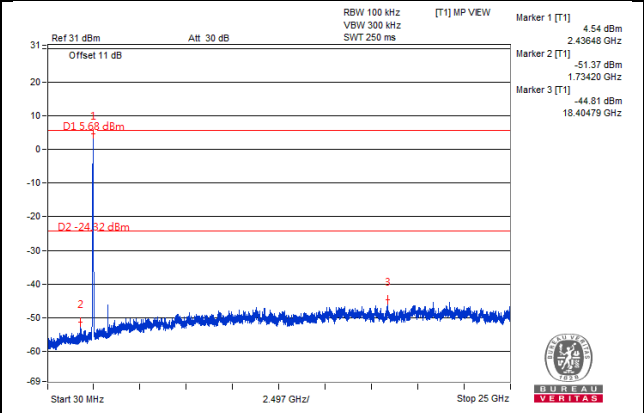
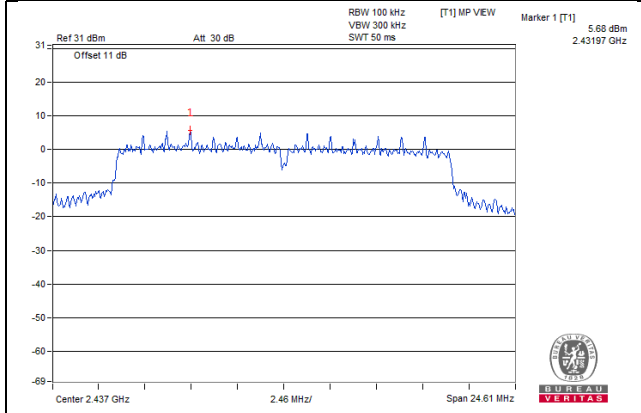

CH 11

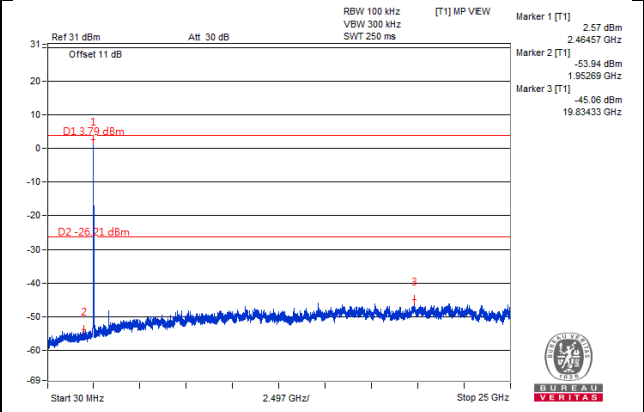
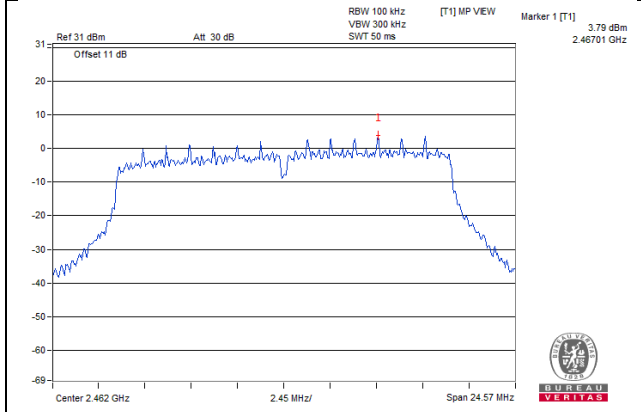

CH 1 Band edge

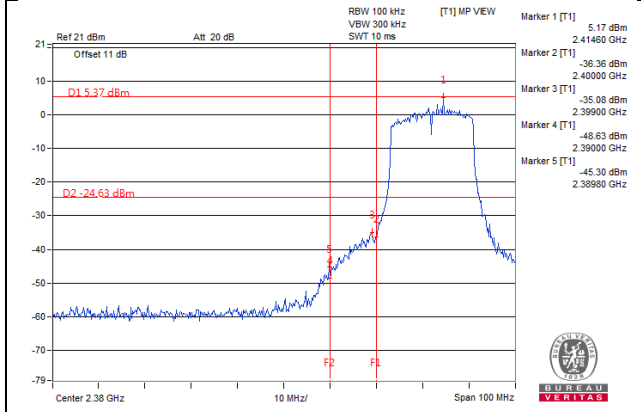

CH 11 Band edge

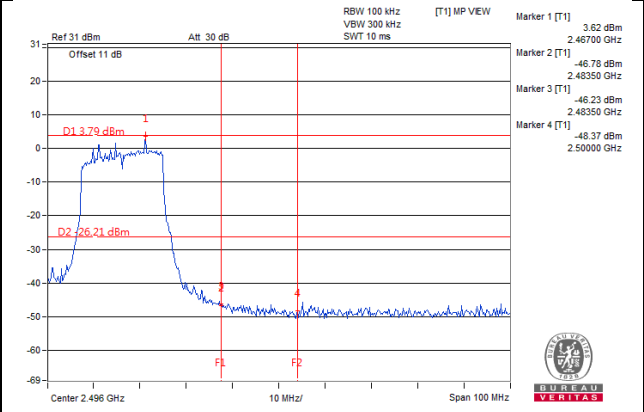

802.11n (HT20) Chain 1

CH 1

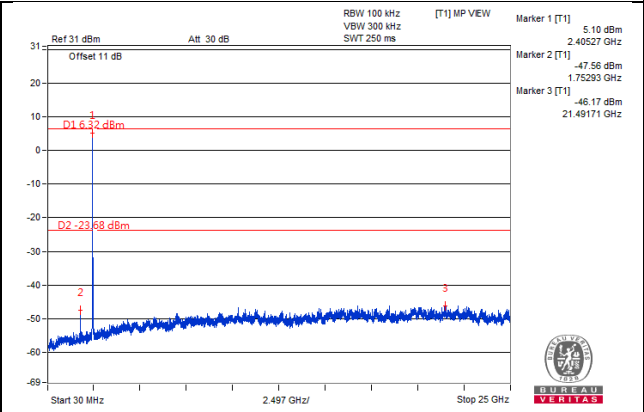
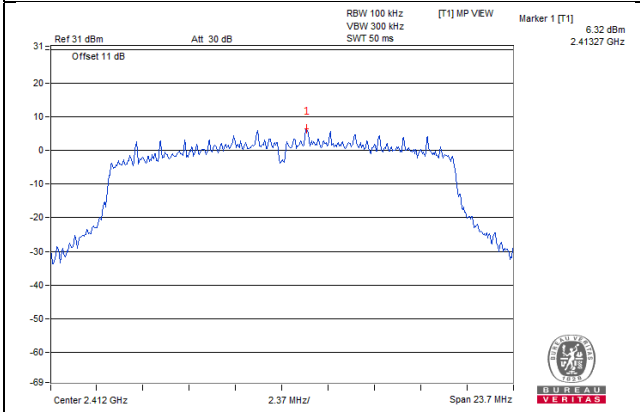

CH 6

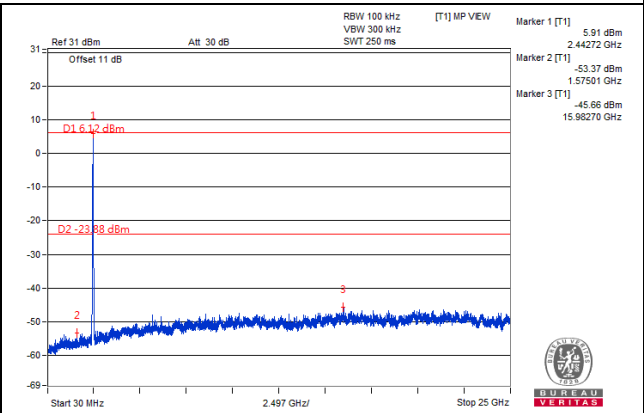
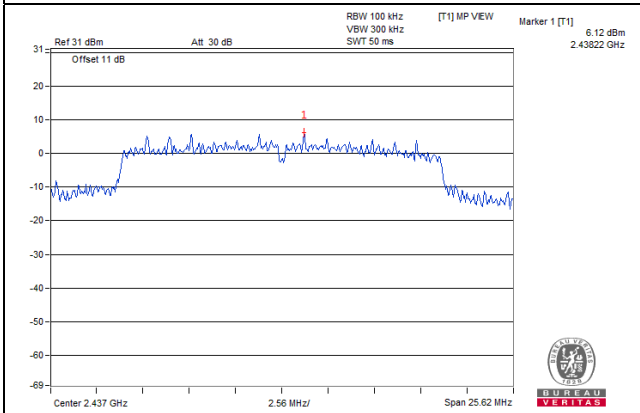

CH 11

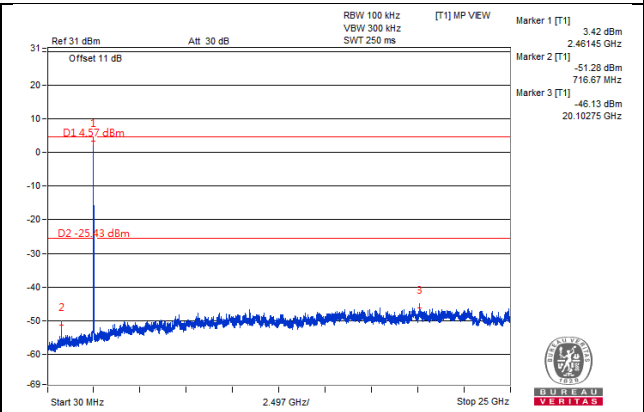
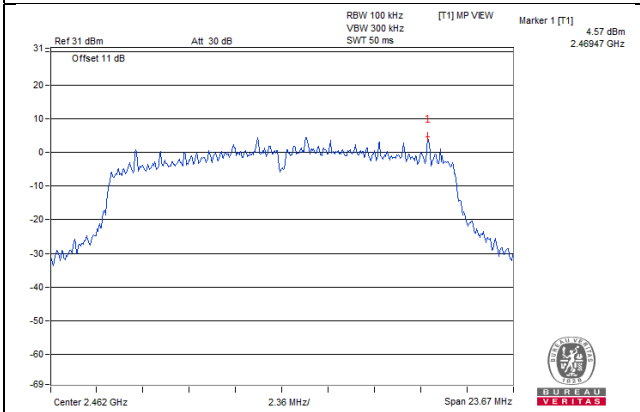

CH 1 Band edge

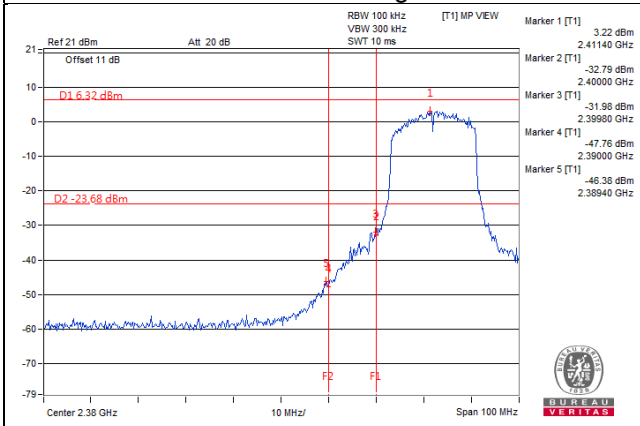

CH 11 Band edge

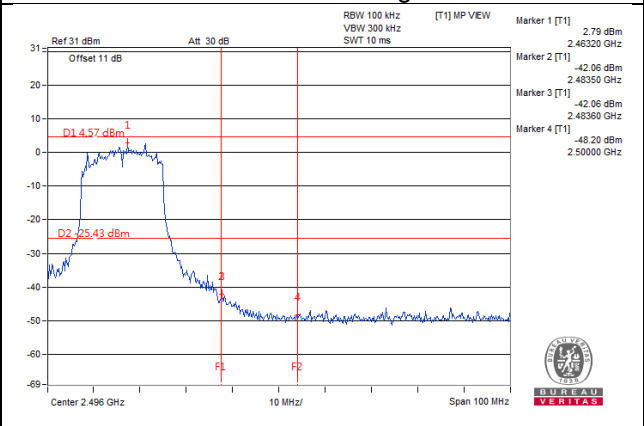

802.11n (HT40)_Chain 0

CH 3

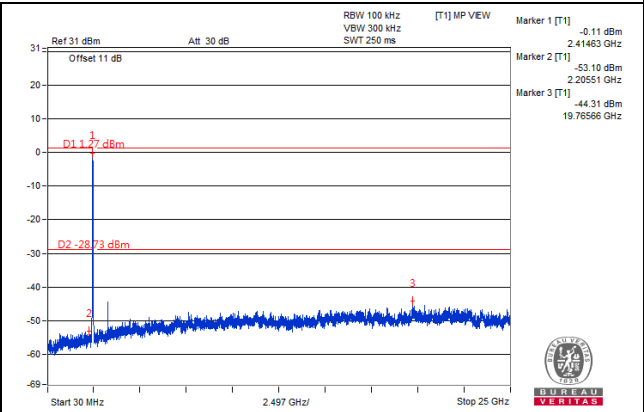
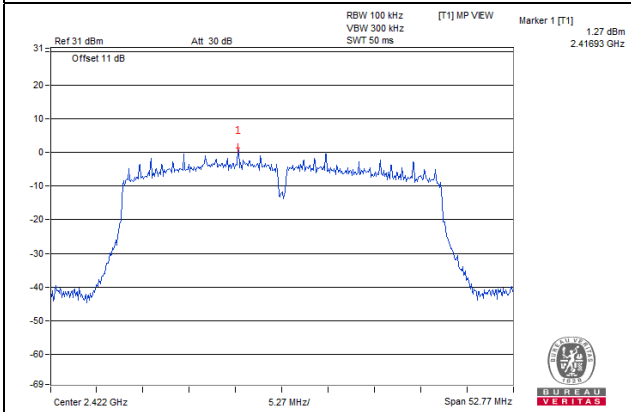

CH 6

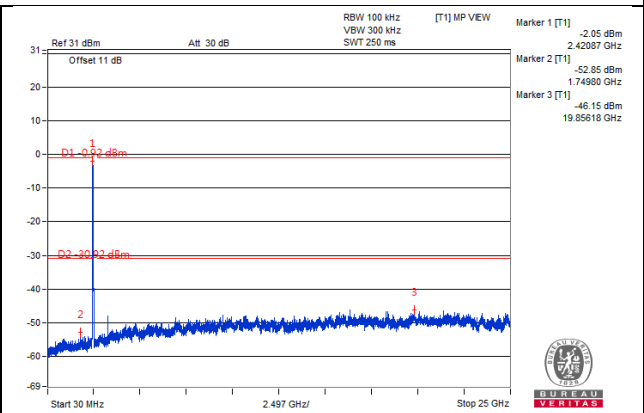
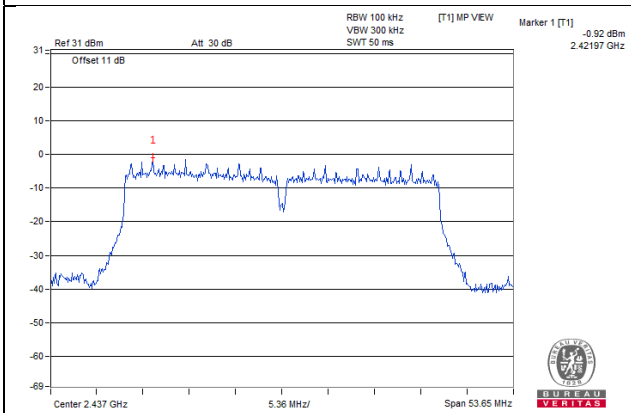

CH 9

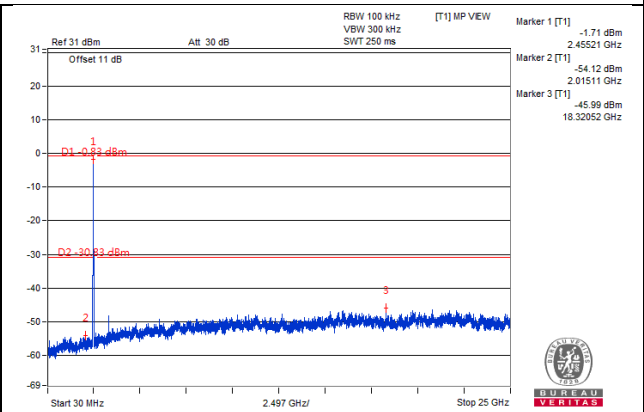
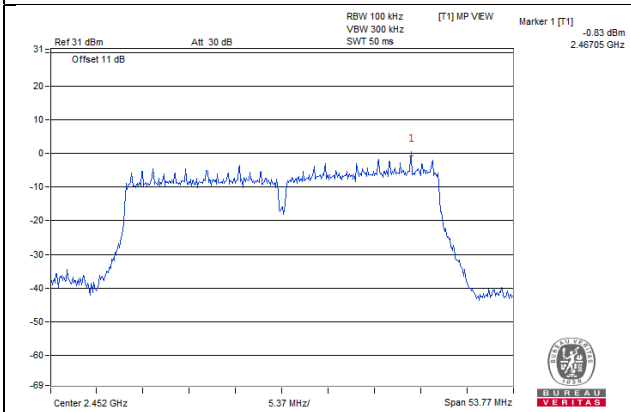

CH 3 Band edge

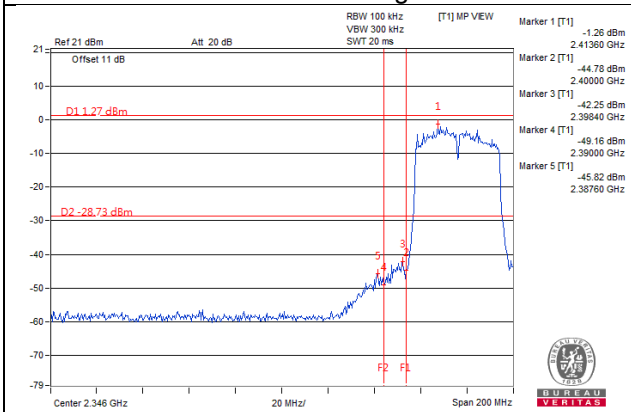

CH 9 Band edge

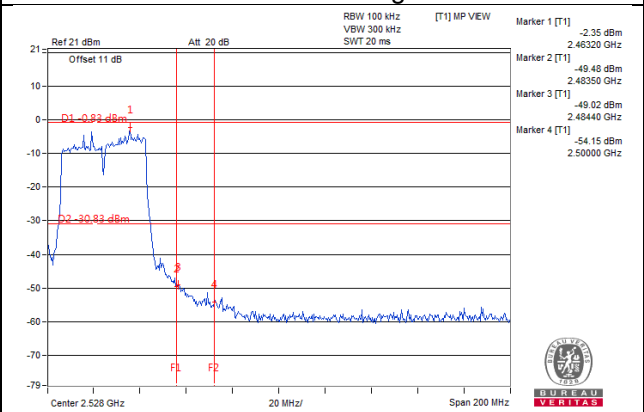

802.11n (HT40)_Chain 1

CH 3

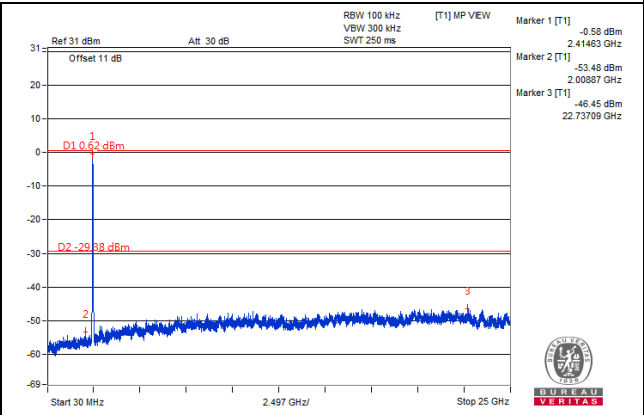
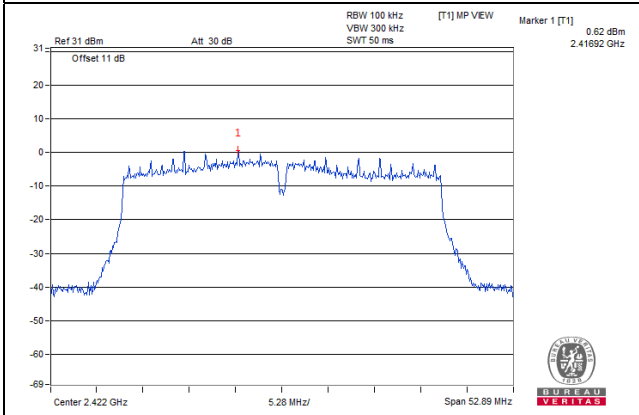

CH 6

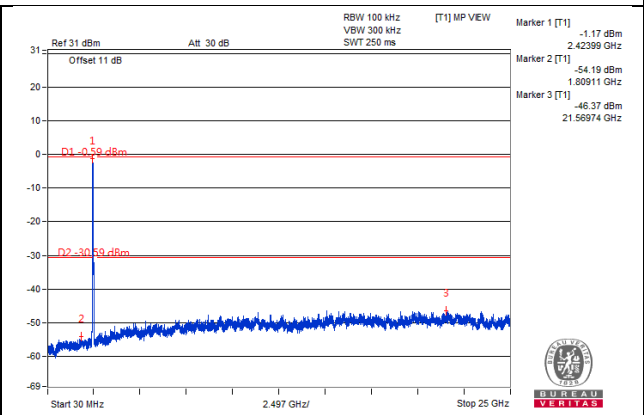
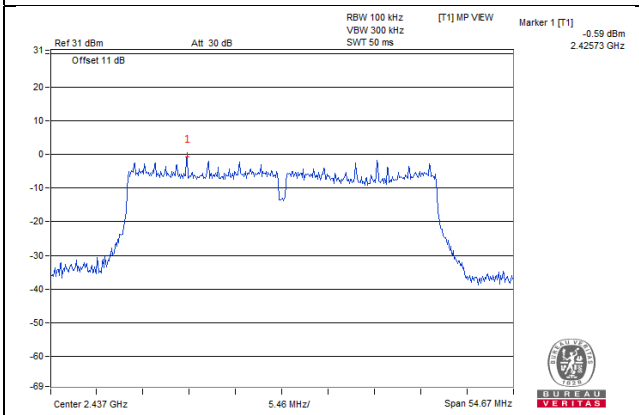

CH 9

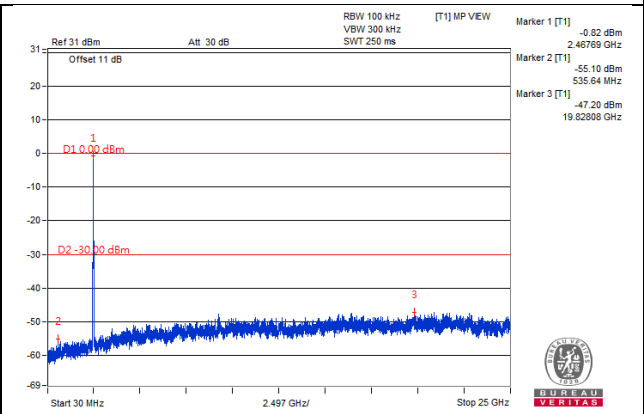
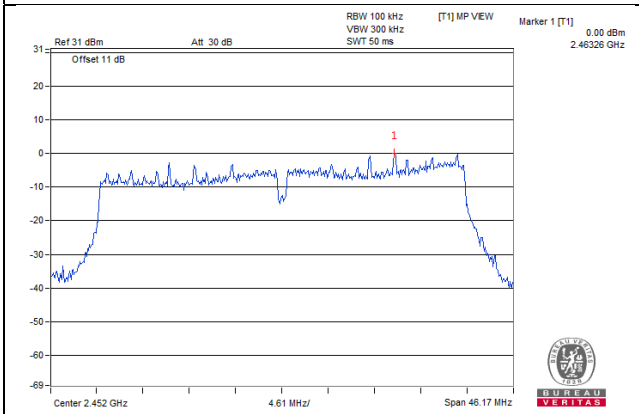

CH 3 Band edge

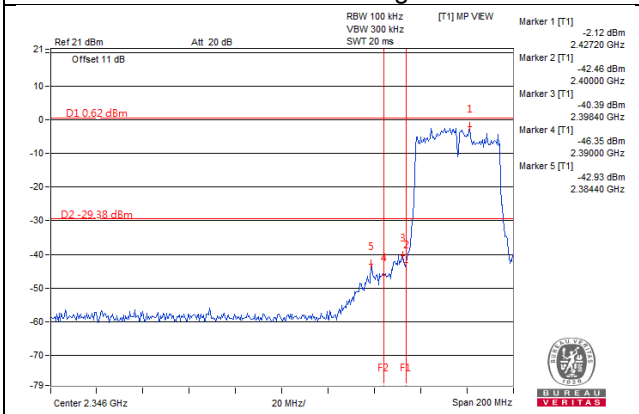

CH 9 Band edge

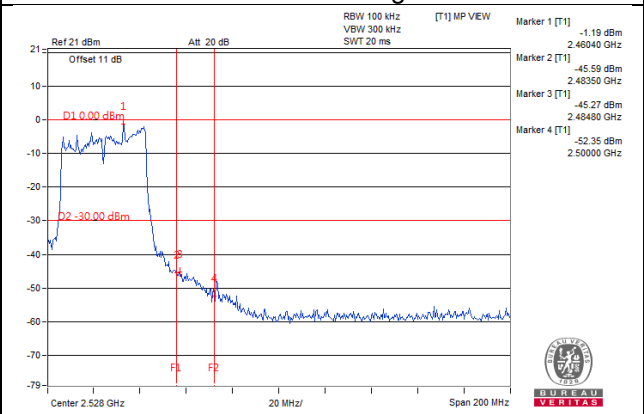

5 Pictures of Test Arrangements

Please refer to the attached file (Test Setup Photo).

Appendix – Information of the Testing Laboratories

We, Bureau Veritas Consumer Products Services (H.K.) Ltd., Taoyuan Branch, were founded in 1988 to provide our best service in EMC, Radio, Telecom and Safety consultation. Our laboratories are FCC recognized accredited test firms and accredited and approved according to ISO/IEC 17025.

If you have any comments, please feel free to contact us at the following:

Lin Kou EMC/RF Lab

Tel: 886-2-26052180

Fax: 886-2-26051924

Hsin Chu EMC/RF/Telecom Lab

Tel: 886-3-6668565

Fax: 886-3-6668323

Hwa Ya EMC/RF/Safety Lab

Tel: 886-3-3183232

Fax: 886-3-3270892

Email: service.adt@tw.bureauveritas.com

Web Site: <http://ee.bureauveritas.com.tw>

The address and road map of all our labs can be found in our web site also.

--- END ---