

FCC Test Report

Report No.: RF180316C33

FCC ID: 2AKCZ-0CF

Test Model: APL44-0CF

Received Date: Mar. 16, 2018

Test Date: Mar. 19 ~ Mar. 27, 2018

Issued Date: Apr. 19, 2018

Applicant: SonicWall Inc.

Address: 1033 McCarthy Blvd., Milpitas, CA 95035, USA

Issued By: Bureau Veritas Consumer Products Services (H.K.) Ltd., Taoyuan Branch

Lab Address: No. 47-2, 14th Ling, Chia Pau Vil., Lin Kou Dist., New Taipei City, Taiwan (R.O.C.)

Test Location: No. 19, Hwa Ya 2nd Rd., Wen Hwa Vil., Kwei Shan Dist., Taoyuan City 33383, TAIWAN (R.O.C.)

**FCC Registration /
Designation Number:** 788550 / TW0003



This report is for your exclusive use. Any copying or replication of this report to or for any other person or entity, or use of our name or trademark, is permitted only with our prior written permission. This report sets forth our findings solely with respect to the test samples identified herein. The results set forth in this report are not indicative or representative of the quality or characteristics of the lot from which a test sample was taken or any similar or identical product unless specifically and expressly noted. Our report includes all of the tests requested by you and the results thereof based upon the information that you provided to us. You have 60 days from date of issuance of this report to notify us of any material error or omission caused by our negligence, provided, however, that such notice shall be in writing and shall specifically address the issue you wish to raise. A failure to raise such issue within the prescribed time shall constitute your unqualified acceptance of the completeness of this report, the tests conducted and the correctness of the report contents. Unless specific mention, the uncertainty of measurement has been explicitly taken into account to declare the compliance or non-compliance to the specification. This report should not be used by the client to claim product certification, approval, or endorsement by TAF or any government agencies.

Table of Contents

Release Control Record	4
1 Certificate of Conformity	5
2 Summary of Test Results	6
2.1 Measurement Uncertainty.....	6
2.2 Modification Record.....	6
3 General Information	7
3.1 General Description of EUT.....	7
3.2 Description of Test Modes.....	8
3.2.1 Test Mode Applicability and Tested Channel Detail.....	9
3.3 Duty Cycle of Test Signal.....	11
3.4 Description of Support Units.....	13
3.4.1 Configuration of System under Test.....	13
3.5 General Description of Applied Standards.....	13
4 Test Types and Results	15
4.1 Radiated Emission and Bandedge Measurement.....	15
4.1.1 Limits of Radiated Emission and Bandedge Measurement.....	15
4.1.2 Test Instruments.....	16
4.1.3 Test Procedures.....	17
4.1.4 Deviation from Test Standard.....	17
4.1.5 Test Setup.....	18
4.1.6 EUT Operating Conditions.....	19
4.1.7 Test Results.....	20
4.2 Conducted Emission Measurement.....	45
4.2.1 Limits of Conducted Emission Measurement.....	45
4.2.2 Test Instruments.....	45
4.2.3 Test Procedures.....	46
4.2.4 Deviation from Test Standard.....	46
4.2.5 Test Setup.....	46
4.2.6 EUT Operating Conditions.....	46
4.2.7 Test Results.....	47
4.3 6dB Bandwidth Measurement.....	55
4.3.1 Limits of 6dB Bandwidth Measurement.....	55
4.3.2 Test Setup.....	55
4.3.3 Test Instruments.....	55
4.3.4 Test Procedure.....	55
4.3.5 Deviation from Test Standard.....	55
4.3.6 EUT Operating Conditions.....	55
4.3.7 Test Result.....	56
4.4 Conducted Output Power Measurement.....	60
4.4.1 Limits of Conducted Output Power Measurement.....	60
4.4.2 Test Setup.....	60
4.4.3 Test Instruments.....	60
4.4.4 Test Procedures.....	60
4.4.5 Deviation from Test Standard.....	60
4.4.6 EUT Operating Conditions.....	60
4.4.7 Test Results.....	61
4.5 Power Spectral Density Measurement.....	64
4.5.1 Limits of Power Spectral Density Measurement.....	64
4.5.2 Test Setup.....	64
4.5.3 Test Instruments.....	64
4.5.4 Test Procedure.....	64
4.5.5 Deviation from Test Standard.....	65
4.5.6 EUT Operating Condition.....	65

4.5.7 Test Results	66
4.6 Conducted Out of Band Emission Measurement.....	71
4.6.1 Limits of Conducted Out of Band Emission Measurement	71
4.6.2 Test Setup.....	71
4.6.3 Test Instruments	71
4.6.4 Test Procedure	71
4.6.5 Deviation from Test Standard	71
4.6.6 EUT Operating Condition	71
4.6.7 Test Results	71
5 Pictures of Test Arrangements.....	83
Appendix – Information on the Testing Laboratories	84

Release Control Record

Issue No.	Description	Date Issued
RF180316C33	Original release	Apr. 19, 2018

1 Certificate of Conformity

Product: Wireless Access Point
Brand: SONICWALL
Test Model: APL44-0CF
Sample Status: Engineering sample
Applicant: SonicWall Inc.
Test Date: Mar. 19 ~ Mar. 27, 2018
Standards: 47 CFR FCC Part 15, Subpart C (Section 15.247)
ANSI C63.10:2013

The above equipment has been tested by **Bureau Veritas Consumer Products Services (H.K.) Ltd., Taoyuan Branch**, and found compliance with the requirement of the above standards. The test record, data evaluation & Equipment Under Test (EUT) configurations represented herein are true and accurate accounts of the measurements of the sample's RF characteristics under the conditions specified in this report.

Prepared by : Celine Chou , **Date:** Apr. 19, 2018
Celine Chou / Specialist

Approved by : Bruce Chen , **Date:** Apr. 19, 2018
Bruce Chen / Project Engineer

2 Summary of Test Results

47 CFR FCC Part 15, Subpart C (Section 15.247)			
FCC Clause	Test Item	Result	Remarks
15.207	AC Power Conducted Emission	Pass	Meet the requirement of limit. Minimum passing margin is -13.41dB at 0.20600MHz.
15.205 / 15.209 / 15.247(d)	Radiated Emissions and Band Edge Measurement	Pass	Meet the requirement of limit. Minimum passing margin is -1.1dB at 2483.50MHz.
15.247(d)	Antenna Port Emission	Pass	Meet the requirement of limit.
15.247(a)(2)	6dB bandwidth	Pass	Meet the requirement of limit.
15.247(b)	Conducted power	Pass	Meet the requirement of limit.
15.247(e)	Power Spectral Density	Pass	Meet the requirement of limit.
15.203	Antenna Requirement	Pass	Antenna connector is I-PEX not a standard connector.

2.1 Measurement Uncertainty

Where relevant, the following measurement uncertainty levels have been estimated for tests performed on the EUT as specified in CISPR 16-4-2:

Measurement	Frequency	Expanded Uncertainty (k=2) (\pm)
Conducted Emissions at mains ports	150kHz ~ 30MHz	2.94 dB
Radiated Emissions up to 1 GHz	30MHz ~ 200MHz	3.86 dB
	200MHz ~ 1000MHz	3.87 dB
Radiated Emissions above 1 GHz	1GHz ~ 18GHz	2.29 dB
	18GHz ~ 40GHz	2.29 dB

2.2 Modification Record

There were no modifications required for compliance.

3 General Information

3.1 General Description of EUT

Product	Wireless Access Point
Brand	SONICWALL
Test Model	APL44-OCF
Sample Status	Engineering sample
Power Supply Rating	12Vdc from Adapter 52Vdc from PoE
Modulation Type	CCK, DQPSK, DBPSK for DSSS 64QAM, 16QAM, QPSK, BPSK for OFDM
Modulation Technology	DSSS, OFDM
Transfer Rate	802.11b: 11/5.5/2/1Mbps 802.11g: 54/48/36/24/18/12/9/6Mbps 802.11n: up to 300Mbps
Operating Frequency	2412 ~ 2462MHz
Number of Channel	802.11b, 802.11g, 802.11n (HT20): 11 802.11n (HT40): 7
Output Power	Radio 1: CDD Mode: 401.377mW Beamforming Mode: 171.624mW Radio 3: 96.383mW
Antenna Type	Refer to note
Antenna Connector	Refer to note
Accessory Device	NA
Cable Supplied	1.75m non-shielded RJ45 cable without core

Note:

- The EUT incorporates a MIMO function. Physically, the EUT provides 2 completed transmitters and 2 receivers.

Modulation Mode	Beamforming Mode	TX Function	Remark
802.11b	Not Support	2TX	Radio 1 (Ant. 1, 2)
802.11g	Not Support	2TX	
802.11n (HT20)	Support	2TX	
802.11n (HT40)	Support	2TX	
802.11b	Not Support	1TX	Radio 3 (Ant. 6)
802.11g	Not Support	1TX	
802.11n (HT20)	Not Support	1TX	

* For 802.11n, CDD mode and Beamforming mode are presented in power output test item. For other test items, CDD mode is the worst case for final tests after pretesting.

2. The EUT consumes power from the following Adapter and PoE. (support unit only)

Adapter	
Brand	Powertron Electronics Corp.
Model	PA1015-120DUB150
Input	100-240Vac~50-60Hz 0.4A
Output	12Vdc/ 1.5A 18W Max.
Power Line	1.5m cable without core attached on adapter

PoE	
Brand	DELL
Model	ADPE01-0B1
Input	100-240Vac~50-60Hz 0.6A
Output	52Vdc/ 0.58A

3. The following antennas were provided to the EUT.

Ant. No.	1	2	3	4	5 (BLE)	6 (Scan)
Ant. Type	PIFA	PIFA	PIFA	PIFA	PCB	PCB
Ant. Connector	IPEX	IPEX	IPEX	IPEX	IPEX	IPEX
Frequency (MHz)	2400-2500		5150-5850		2400-2500	2400-2500
Peak Gain (dBi)	4.58	3.63	5.56	4.58	5.80	3.89

3.2 Description of Test Modes

11 channels are provided for 802.11b, 802.11g and 802.11n (HT20):

Channel	Frequency	Channel	Frequency
1	2412MHz	7	2442MHz
2	2417MHz	8	2447MHz
3	2422MHz	9	2452MHz
4	2427MHz	10	2457MHz
5	2432MHz	11	2462MHz
6	2437MHz		

7 channels are provided for 802.11n (HT40):

Channel	Frequency	Channel	Frequency
3	2422MHz	7	2442MHz
4	2427MHz	8	2447MHz
5	2432MHz	9	2452MHz
6	2437MHz		

3.2.1 Test Mode Applicability and Tested Channel Detail

EUT Configure Mode	Applicable to				Description
	RE \geq 1G	RE<1G	PLC	APCM	
A	√	√	√	√	Powered by adapter
B	-	√	√	-	Powered by POE

Where RE \geq 1G: Radiated Emission above 1GHz & Bandedge Measurement
 RE<1G: Radiated Emission below 1GHz
 PLC: Power Line Conducted Emission
 APCM: Antenna Port Conducted Measurement

Note:

1. The EUT had been pre-tested on the positioned of each 3 axis. The worst case was found when positioned on **Z-plane**.
2. "-" means no effect.

Radiated Emission Test (Above 1GHz):

- Pre-Scan has been conducted to determine the worst-case mode from all possible combinations between available modulations, data rates and antenna ports (if EUT with antenna diversity architecture).
- Following channel(s) was (were) selected for the final test as listed below.

EUT Configure Mode	Mode	Available Channel	Tested Channel	Modulation Technology	Modulation Type	Data Rate (Mbps)	Remark
A	802.11b	1 to 11	1, 6, 11	DSSS	DBPSK	1.0	Radio 1 (2TX)
		1 to 11	1, 6, 11	DSSS	DBPSK	1.0	Radio 3 (1TX)
A	802.11g	1 to 11	1, 6, 11	OFDM	BPSK	6.0	Radio 1 (2TX)
		1 to 11	1, 6, 11	OFDM	BPSK	6.0	Radio 3 (1TX)
A	802.11n (HT20)	1 to 11	1, 6, 11	OFDM	BPSK	6.5	Radio 1 (2TX)
		1 to 11	1, 6, 11	OFDM	BPSK	6.5	Radio 3 (1TX)
A	802.11n (HT40)	3 to 9	3, 6, 9	OFDM	BPSK	13.5	Radio 1 (2TX)

Radiated Emission Test (Below 1GHz):

- Pre-Scan has been conducted to determine the worst-case mode from all possible combinations between available modulations, data rates and antenna ports (if EUT with antenna diversity architecture).
- Following channel(s) was (were) selected for the final test as listed below.

EUT Configure Mode	Mode	Available Channel	Tested Channel	Modulation Technology	Modulation Type	Data Rate (Mbps)	Remark
A, B	802.11b	1 to 11	6	DSSS	DBPSK	1.0	Radio 1 (2TX)
		1 to 11	6	DSSS	DBPSK	1.0	Radio 3 (1TX)

Power Line Conducted Emission Test:

- Pre-Scan has been conducted to determine the worst-case mode from all possible combinations between available modulations, data rates and antenna ports (if EUT with antenna diversity architecture).
- Following channel(s) was (were) selected for the final test as listed below.

EUT Configure Mode	Mode	Available Channel	Tested Channel	Modulation Technology	Modulation Type	Data Rate (Mbps)	Remark
A, B	802.11b	1 to 11	6	DSSS	DBPSK	1.0	Radio 1 (2TX)
		1 to 11	6	DSSS	DBPSK	1.0	Radio 3 (1TX)

6dB Bandwidth, Power Spectral Density and Conducted Out of Band Emission Measurement:

- This item includes all test value of each mode, but only includes spectrum plot of worst value of each mode.
- Pre-Scan has been conducted to determine the worst-case mode from all possible combinations between available modulations, data rates and antenna ports (if EUT with antenna diversity architecture).
- Following channel(s) was (were) selected for the final test as listed below.

EUT Configure Mode	Mode	Available Channel	Tested Channel	Modulation Technology	Modulation Type	Data Rate (Mbps)	Remark
A	802.11b	1 to 11	1, 6, 11	DSSS	DBPSK	1.0	Radio 1 (2TX)
		1 to 11	1, 6, 11	DSSS	DBPSK	1.0	Radio 3 (1TX)
A	802.11g	1 to 11	1, 6, 11	OFDM	BPSK	6.0	Radio 1 (2TX)
		1 to 11	1, 6, 11	OFDM	BPSK	6.0	Radio 3 (1TX)
A	802.11n (HT20)	1 to 11	1, 6, 11	OFDM	BPSK	6.5	Radio 1 (2TX)
		1 to 11	1, 6, 11	OFDM	BPSK	6.5	Radio 3 (1TX)
A	802.11n (HT40)	3 to 9	3, 6, 9	OFDM	BPSK	13.5	Radio 1 (2TX)

Conducted Output Power Measurement:

- This item includes all test value of each mode, but only includes spectrum plot of worst value of each mode.
- Pre-Scan has been conducted to determine the worst-case mode from all possible combinations between available modulations, data rates and antenna ports (if EUT with antenna diversity architecture).
- Following channel(s) was (were) selected for the final test as listed below.

EUT Configure Mode	Mode	Available Channel	Tested Channel	Modulation Technology	Modulation Type	Data Rate (Mbps)	Remark
CDD Mode							
A	802.11b	1 to 11	1, 6, 11	DSSS	DBPSK	1.0	Radio 1 (2TX)
		1 to 11	1, 6, 11	DSSS	DBPSK	1.0	Radio 3 (1TX)
A	802.11g	1 to 11	1, 6, 11	OFDM	BPSK	6.0	Radio 1 (2TX)
		1 to 11	1, 6, 11	OFDM	BPSK	6.0	Radio 3 (1TX)
A	802.11n (HT20)	1 to 11	1, 6, 11	OFDM	BPSK	6.5	Radio 1 (2TX)
		1 to 11	1, 6, 11	OFDM	BPSK	6.5	Radio 3 (1TX)
A	802.11n (HT40)	3 to 9	3, 6, 9	OFDM	BPSK	13.5	Radio 1 (2TX)
Beamforming Mode							
A	802.11n (HT20)	1 to 11	1, 6, 11	OFDM	BPSK	6.5	Radio 1 (2TX)
A	802.11n (HT40)	3 to 9	3, 6, 9	OFDM	BPSK	13.5	Radio 1 (2TX)

Test Condition:

Applicable to	Environmental Conditions	Input Power	Tested by
RE \geq 1G	24 deg. C, 66% RH 23 deg. C, 66% RH	120Vac, 60Hz	Will Cheng
RE<1G	23 deg. C, 66% RH	120Vac, 60Hz 52Vdc	Will Cheng
PLC	25 deg. C, 75% RH	120Vac, 60Hz 52Vdc	Adair Peng
APCM	25 deg. C, 60% RH	120Vac, 60Hz	Chris Lin

3.3 Duty Cycle of Test Signal

Radio 1

802.11b: Duty cycle of test signal > 98%, duty factor is not required.

802.11g, 802.11n (HT20), 802.11n (HT40): Duty cycle of test signal is < 98%, duty factor is required.

802.11b: Duty cycle = $12.395/12.513 = 0.991$

802.11g: Duty cycle = $2.059/2.152 = 0.957$, Duty factor = $10 * \log(1/0.957) = 0.19$

802.11n (HT20): Duty cycle = $4.991/5.107 = 0.977$, Duty factor = $10 * \log(1/0.977) = 0.10$

802.11n (HT40): Duty cycle = $2.428/2.512 = 0.967$, Duty factor = $10 * \log(1/0.967) = 0.15$

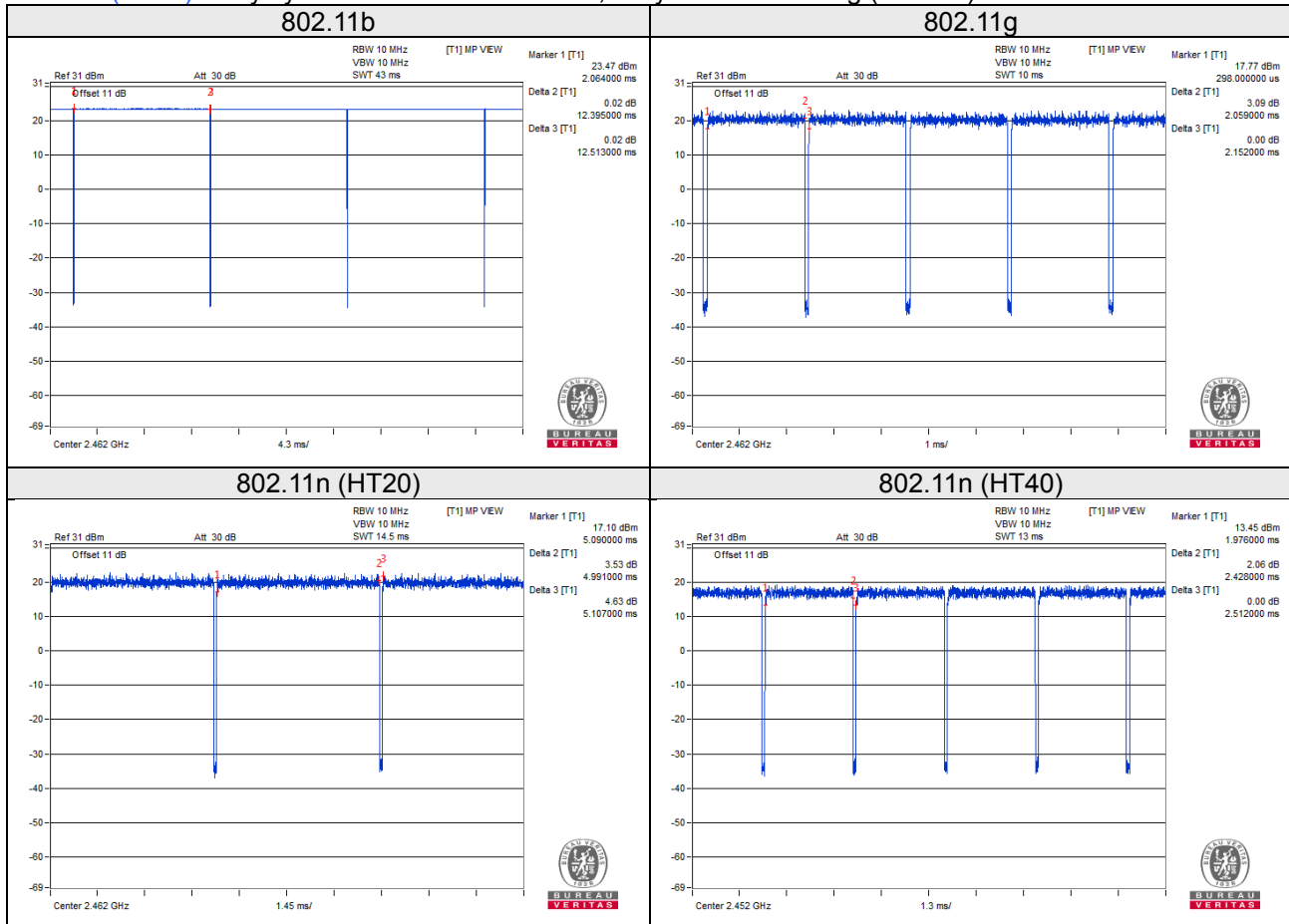

Radio 3

802.11b: Duty cycle of test signal is 100%, duty factor is not required.

802.11g, 802.11n (HT20): Duty cycle of test signal is < 98%, duty factor is required.

802.11b: Duty cycle = $12.369/12.516 = 0.988$

802.11g: Duty cycle = $2.057/2.167 = 0.949$, Duty factor = $10 * \log(1/0.949) = 0.23$

802.11n (HT20): Duty cycle = $1.913/2.015 = 0.949$, Duty factor = $10 * \log(1/0.949) = 0.23$

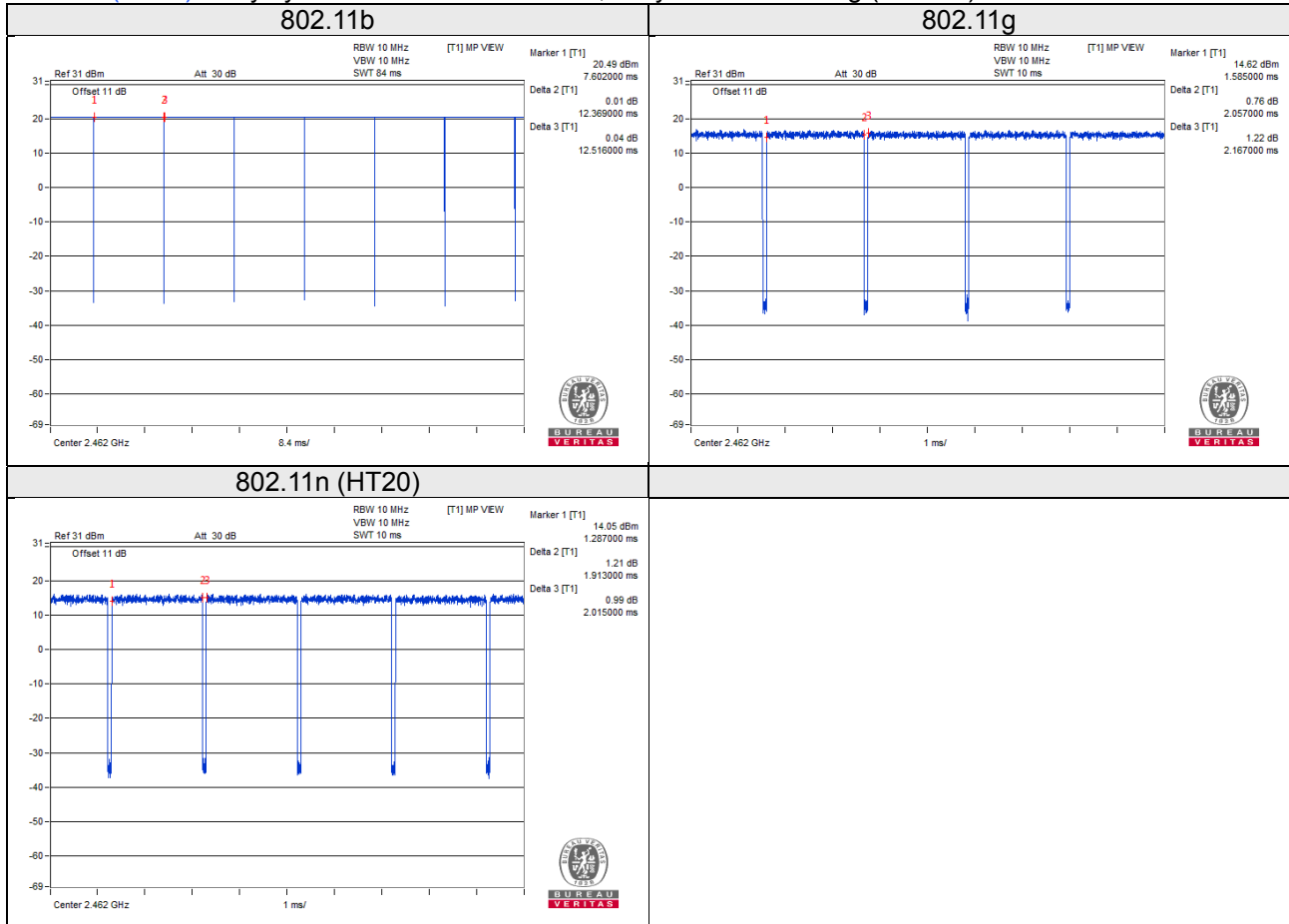

3.4 Description of Support Units

The EUT has been tested as an independent unit together with other necessary accessories or support units. The following support units or accessories were used to form a representative test configuration during the tests.

ID	Product	Brand	Model No.	Serial No.	FCC ID	Remarks
A.	Notebook	DELL	E5410	6RP2YM1	FCC DoC Approved	-
B.	USB Flash	HP	v250W	01	FCC DoC Approved	-
C.	Adapter	Powertron Electronics Corp.	PA1015-120DUB150	NA	NA	Provided by client
D.	PoE	DELL	ADPE01-0B1	NA	NA	Provided by client

Note:

1. All power cords of the above support units are non-shielded (1.8m).
2. Item A acted as a communication partner to transfer data.

ID	Descriptions	Qty.	Length (m)	Shielding (Yes/No)	Cores (Qty.)	Remarks
1.	DC cable	1	1.5	N	0	Attached on adapter
2.	RJ45, Cat5e	1	3	N	0	-
3.	RJ45, Cat5e	1	1.8	N	0	-

3.4.1 Configuration of System under Test

Test Mode A

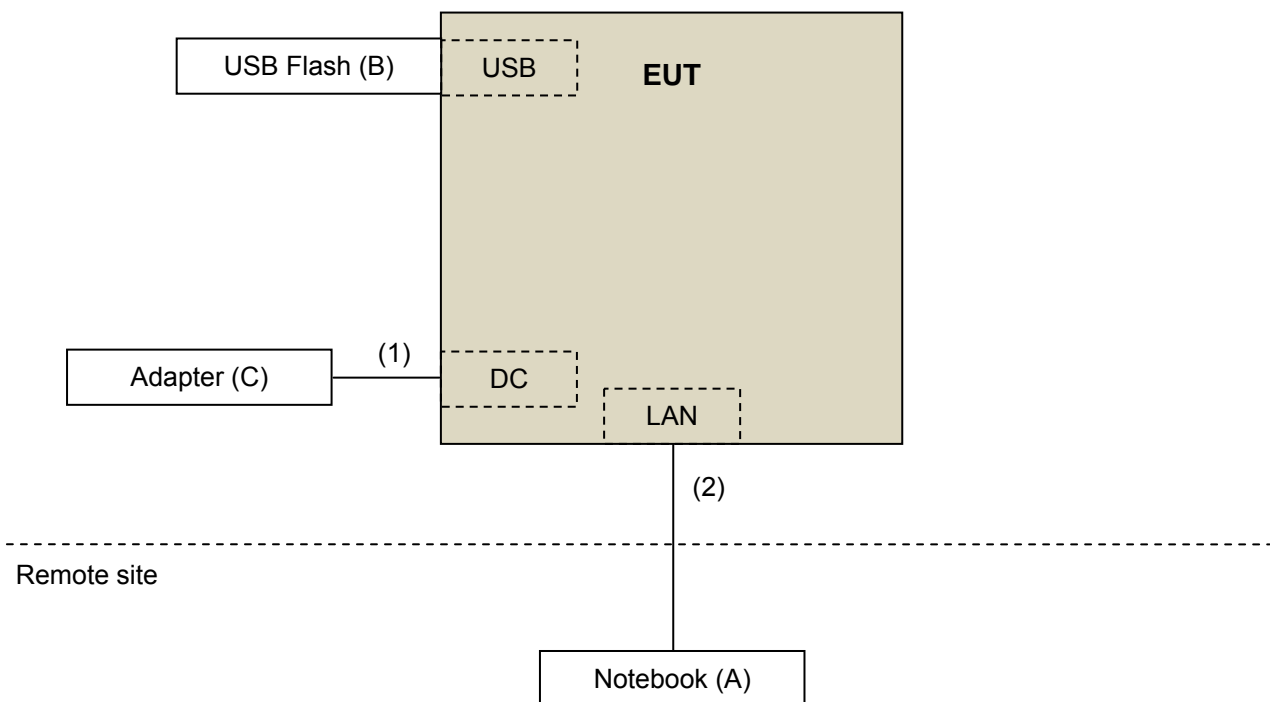

Test Mode B

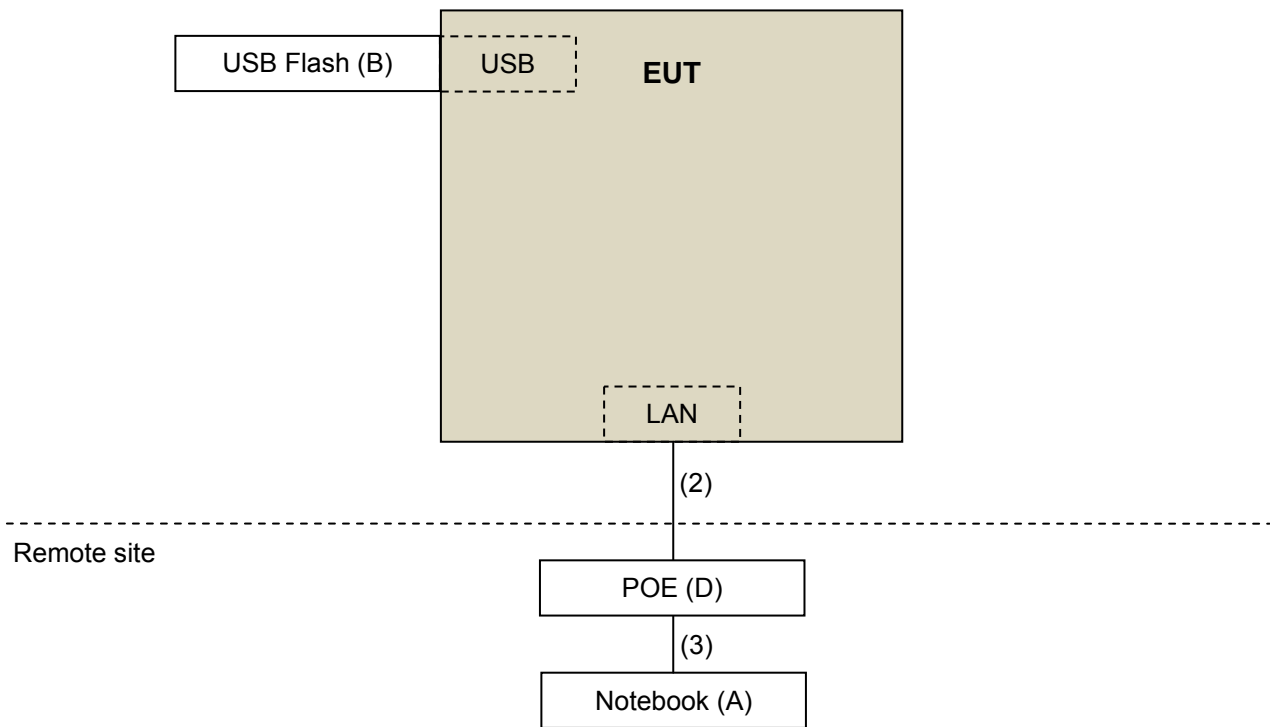

3.5 General Description of Applied Standards

The EUT is a RF Product. According to the specifications of the manufacturer, it must comply with the requirements of the following standards:

FCC Part 15, Subpart C (15.247)

KDB 558074 D01 DTS Meas Guidance v04

KDB 662911 D01 Multiple Transmitter Output v02r01

ANSI C63.10-2013

All test items have been performed and recorded as per the above standards.

4 Test Types and Results

4.1 Radiated Emission and Bandedge Measurement

4.1.1 Limits of Radiated Emission and Bandedge Measurement

Radiated emissions which fall in the restricted bands must comply with the radiated emission limits specified as below table. Other emissions shall be at least 30dB below the highest level of the desired power:

Frequencies (MHz)	Field Strength (microvolts/meter)	Measurement Distance (meters)
0.009 ~ 0.490	2400/F(kHz)	300
0.490 ~ 1.705	24000/F(kHz)	30
1.705 ~ 30.0	30	30
30 ~ 88	100	3
88 ~ 216	150	3
216 ~ 960	200	3
Above 960	500	3

Note:

1. The lower limit shall apply at the transition frequencies.
2. Emission level (dBuV/m) = 20 log Emission level (uV/m).
3. For frequencies above 1000MHz, the field strength limits are based on average detector, however, the peak field strength of any emission shall not exceed the maximum permitted average limits, specified above by more than 30dB under any condition of modulation.

4.1.2 Test Instruments

Description & Manufacturer	Model No.	Serial No.	Cal. Date	Cal. Due
Test Receiver ROHDE & SCHWARZ	ESIB7	100187	May 02, 2017	May 01, 2018
Spectrum Analyzer ROHDE & SCHWARZ	FSP40	100041	Dec. 12, 2017	Dec. 11, 2018
BILOG Antenna SCHWARZBECK	VULB9168	9168-171	Dec. 11, 2017	Dec. 10, 2018
HORN Antenna SCHWARZBECK	9120D	209	Dec. 13, 2017	Dec. 12, 2018
HORN Antenna SCHWARZBECK	BBHA 9170	BBHA9170241	Dec. 01, 2017	Nov. 30, 2018
Loop Antenna EMCI	EM-6879	269	Aug. 11, 2017	Aug. 10, 2018
Preamplifier Agilent (Below 1GHz)	8447D	2944A10738	Aug. 21, 2017	Aug. 20, 2018
Preamplifier Agilent (Above 1GHz)	8449B	3008A01976	Aug. 21, 2017	Aug. 20, 2018
RF signal cable HUBER+SUHNER	SUCOFLEX 104	Cable-CH3-03 (223653/4)	Aug. 21, 2017	Aug. 20, 2018
RF signal cable HUBER+SUHNER& EMCI	SUCOFLEX 104&EMC104-SM-SM-8 000	Cable-CH3-03 (309224+170907)	Sep.11, 2017	Sep. 10, 2018
Software BV ADT	ADT_Radiated_ V7.6.15.9.4	NA	NA	NA
Antenna Tower inn-co GmbH	MA 4000	013303	NA	NA
Antenna Tower Controller BV ADT	AT100	AT93021702	NA	NA
Turn Table BV ADT	TT100	TT93021702	NA	NA
Turn Table Controller BV ADT	SC100	SC93021702	NA	NA
Boresight Antenna Fixture	FBA-01	FBA-SIP01	NA	NA
High Speed Peak Power Meter	ML2495A	0824012	Aug. 18, 2017	Aug. 17, 2018
Power Sensor	MA2411B	0738171	Aug. 18, 2017	Aug. 17, 2018

- Note:
1. The calibration interval of the above test instruments is 12 months and the calibrations are traceable to NML/ROC and NIST/USA.
 2. The test was performed in HwaYa Chamber 3.
 3. The horn antenna and preamplifier (model: 8449B) are used only for the measurement of emission frequency above 1GHz if tested.
 4. The FCC Designation Number is TW0003. The number will be varied with the Lab location and scope as attached.
 5. The IC Site Registration No. is IC 7450F-3.

4.1.3 Test Procedures

For Radiated emission below 30MHz

- a. The EUT was placed on the top of a rotating table 0.8 meters above the ground at a 3 meter chamber room. The table was rotated 360 degrees to determine the position of the highest radiation.
- b. The EUT was set 3 meters away from the interference-receiving antenna, which was mounted on the top of a variable-height antenna tower.
- c. Parallel, perpendicular, and ground-parallel orientations of the antenna are set to make the measurement.
- d. For each suspected emission, the EUT was arranged to its worst case and the rotatable table was turned from 0 degrees to 360 degrees to find the maximum reading.
- e. The test-receiver system was set to Quasi-Peak Detect Function and Specified Bandwidth with Maximum Hold Mode.

Note:

1. The resolution bandwidth and video bandwidth of test receiver/spectrum analyzer is 9kHz at frequency below 30MHz.

For Radiated emission above 30MHz

- a. The EUT was placed on the top of a rotating table 0.8 meters (for 30MHz ~ 1GHz) / 1.5 meters (for above 1GHz) above the ground at 3 meter chamber room for test. The table was rotated 360 degrees to determine the position of the highest radiation.
- b. The EUT was set 3 meters away from the interference-receiving antenna, which was mounted on the top of a variable-height antenna tower.
- c. The height of antenna is varied from one meter to four meters above the ground to determine the maximum value of the field strength. Both horizontal and vertical polarizations of the antenna are set to make the measurement.
- d. For each suspected emission, the EUT was arranged to its worst case and then the antenna was tuned to heights from 1 meter to 4 meters and the rotatable table was turned from 0 degrees to 360 degrees to find the maximum reading.
- e. The test-receiver system was set to quasi-peak detect function and specified bandwidth with maximum hold mode when the test frequency is below 1 GHz.
- f. The test-receiver system was set to peak and average detect function and specified bandwidth with maximum hold mode when the test frequency is above 1 GHz. If the peak reading value also meets average limit, measurement with the average detector is unnecessary.

Note:

1. The resolution bandwidth and video bandwidth of test receiver/spectrum analyzer is 120kHz for Quasi-peak detection (QP) at frequency below 1GHz.
2. The resolution bandwidth of test receiver/spectrum analyzer is 1 MHz and the video bandwidth is 3 MHz for Peak detection (PK) at frequency above 1GHz.
3. The resolution bandwidth of test receiver/spectrum analyzer is 1 MHz and the video bandwidth is $\geq 1/T$ (Duty cycle < 98%) or 10 Hz (Duty cycle $\geq 98\%$) for Peak detection at frequency above 1GHz.
4. All modes of operation were investigated and the worst-case emissions are reported.

4.1.4 Deviation from Test Standard

No deviation.

4.1.5 Test Setup

For Radiated emission below 30MHz

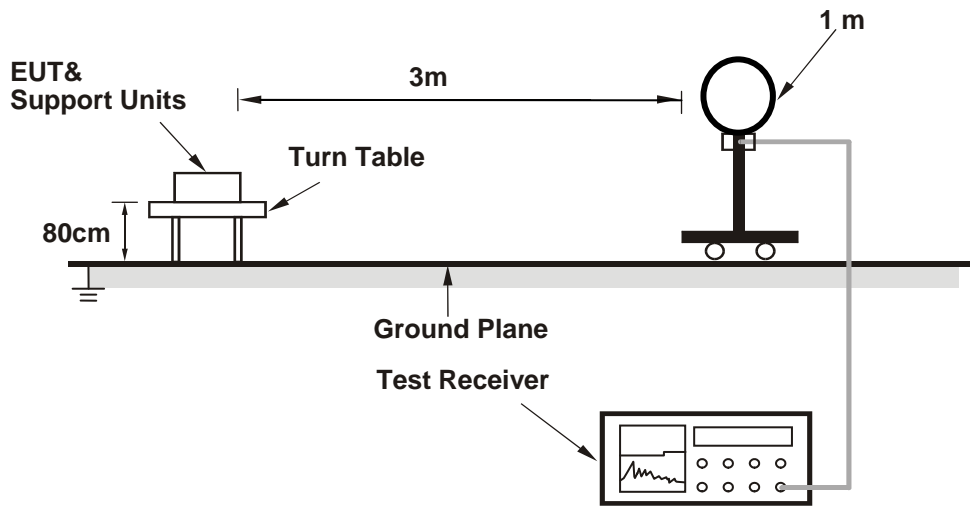

For Radiated emission 30MHz to 1GHz

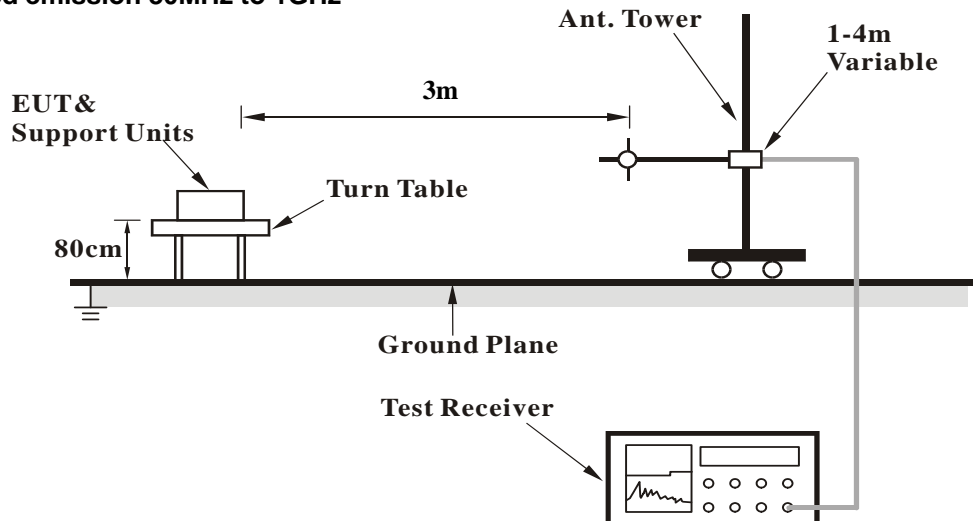

For Radiated emission above 1GHz

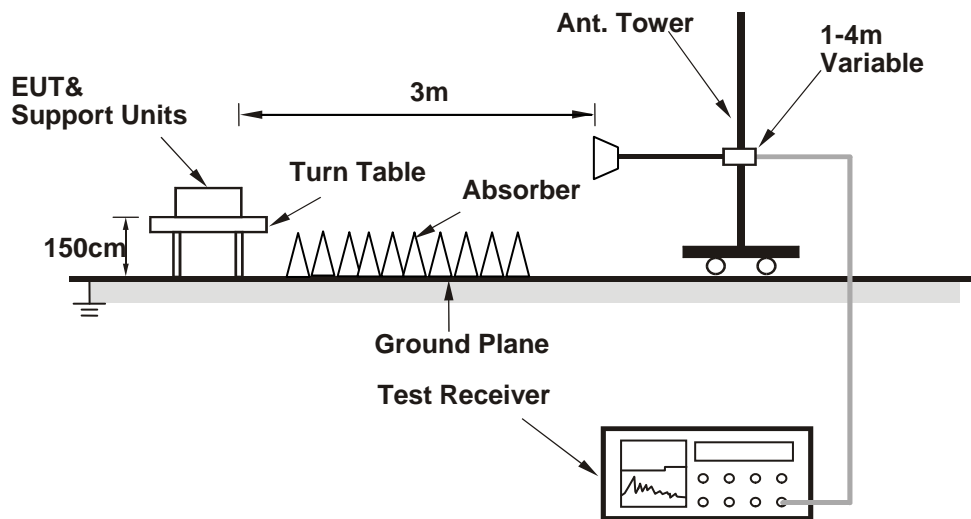

For the actual test configuration, please refer to the attached file (Test Setup Photo).

4.1.6 EUT Operating Conditions

- a. Placed the EUT on the testing table.
- b. Prepared a notebook to act as a communication partner and placed it outside of testing area.
- c. The communication partner connected with EUT via a RJ45 cable and ran a test program (provided by manufacturer) to enable EUT under transmission condition continuously at specific channel frequency.
- d. The communication partner sent data to EUT by command "PING".

4.1.7 Test Results

Above 1GHz Data:

Radio 1

802.11b

CHANNEL	TX Channel 1	DETECTOR FUNCTION	Peak (PK)
FREQUENCY RANGE	1GHz ~ 25GHz		Average (AV)

ANTENNA POLARITY & TEST DISTANCE: HORIZONTAL AT 3 M								
NO.	FREQ. (MHz)	EMISSION LEVEL (dBuV/m)	LIMIT (dBuV/m)	MARGIN (dB)	ANTENNA HEIGHT (m)	TABLE ANGLE (Degree)	RAW VALUE (dBuV)	CORRECTION FACTOR (dB/m)
1	2390.00	61.0 PK	74.0	-13.0	1.50 H	321	27.5	33.5
2	2390.00	52.3 AV	54.0	-1.7	1.50 H	321	18.8	33.5
3	*2412.00	114.7 PK			1.81 H	313	81.3	33.4
4	*2412.00	111.0 AV			1.81 H	313	77.6	33.4
5	4824.00	48.3 PK	74.0	-25.7	1.82 H	109	44.6	3.7
6	4824.00	40.0 AV	54.0	-14.0	1.82 H	109	36.3	3.7
ANTENNA POLARITY & TEST DISTANCE: VERTICAL AT 3 M								
NO.	FREQ. (MHz)	EMISSION LEVEL (dBuV/m)	LIMIT (dBuV/m)	MARGIN (dB)	ANTENNA HEIGHT (m)	TABLE ANGLE (Degree)	RAW VALUE (dBuV)	CORRECTION FACTOR (dB/m)
1	2390.00	58.7 PK	74.0	-15.3	2.02 V	338	25.2	33.5
2	2390.00	46.7 AV	54.0	-7.3	2.02 V	338	13.2	33.5
3	*2412.00	103.7 PK			1.53 V	243	70.3	33.4
4	*2412.00	99.9 AV			1.53 V	243	66.5	33.4
5	4824.00	47.6 PK	74.0	-26.4	1.63 V	203	43.9	3.7
6	4824.00	38.8 AV	54.0	-15.2	1.63 V	203	35.1	3.7

Remarks:

1. Emission Level(dBuV/m) = Raw Value(dBuV) + Correction Factor(dB/m)
2. Correction Factor(dB/m) = Antenna Factor(dB/m) + Cable Factor(dB) – Pre-Amplifier Factor(dB)
3. The other emission levels were very low against the limit.
4. Margin value = Emission Level – Limit value
5. " * ": Fundamental frequency.

CHANNEL	TX Channel 6	DETECTOR FUNCTION	Peak (PK)
FREQUENCY RANGE	1GHz ~ 25GHz		Average (AV)

ANTENNA POLARITY & TEST DISTANCE: HORIZONTAL AT 3 M

NO.	FREQ. (MHz)	EMISSION LEVEL (dBuV/m)	LIMIT (dBuV/m)	MARGIN (dB)	ANTENNA HEIGHT (m)	TABLE ANGLE (Degree)	RAW VALUE (dBuV)	CORRECTION FACTOR (dB/m)
1	2390.00	58.6 PK	74.0	-15.4	1.71 H	309	25.1	33.5
2	2390.00	52.2 AV	54.0	-1.8	1.71 H	309	18.7	33.5
3	*2437.00	115.9 PK			1.47 H	319	82.5	33.4
4	*2437.00	112.2 AV			1.47 H	319	78.8	33.4
5	4874.00	49.2 PK	74.0	-24.8	1.76 H	121	45.7	3.5
6	4874.00	41.3 AV	54.0	-12.7	1.76 H	121	37.8	3.5

ANTENNA POLARITY & TEST DISTANCE: VERTICAL AT 3 M

NO.	FREQ. (MHz)	EMISSION LEVEL (dBuV/m)	LIMIT (dBuV/m)	MARGIN (dB)	ANTENNA HEIGHT (m)	TABLE ANGLE (Degree)	RAW VALUE (dBuV)	CORRECTION FACTOR (dB/m)
1	2390.00	57.1 PK	74.0	-16.9	2.50 V	319	23.6	33.5
2	2390.00	46.0 AV	54.0	-8.0	2.50 V	319	12.5	33.5
3	*2437.00	106.3 PK			1.51 V	214	72.9	33.4
4	*2437.00	102.9 AV			1.51 V	214	69.5	33.4
5	4874.00	48.4 PK	74.0	-25.6	1.54 V	204	44.9	3.5
6	4874.00	40.9 AV	54.0	-13.1	1.54 V	204	37.4	3.5

Remarks:

1. Emission Level(dBuV/m) = Raw Value(dBuV) + Correction Factor(dB/m)
2. Correction Factor(dB/m) = Antenna Factor(dB/m) + Cable Factor(dB) – Pre-Amplifier Factor(dB)
3. The other emission levels were very low against the limit.
4. Margin value = Emission Level – Limit value
5. " * ": Fundamental frequency.

CHANNEL	TX Channel 11	DETECTOR FUNCTION	Peak (PK)
FREQUENCY RANGE	1GHz ~ 25GHz		Average (AV)

ANTENNA POLARITY & TEST DISTANCE: HORIZONTAL AT 3 M								
NO.	FREQ. (MHz)	EMISSION LEVEL (dBuV/m)	LIMIT (dBuV/m)	MARGIN (dB)	ANTENNA HEIGHT (m)	TABLE ANGLE (Degree)	RAW VALUE (dBuV)	CORRECTION FACTOR (dB/m)
1	*2462.00	112.8 PK			1.89 H	317	79.5	33.3
2	*2462.00	109.2 AV			1.89 H	317	75.9	33.3
3	2483.50	60.4 PK	74.0	-13.6	1.53 H	311	27.2	33.2
4	2483.50	52.6 AV	54.0	-1.4	1.53 H	311	19.4	33.2
5	4924.00	48.9 PK	74.0	-25.1	1.92 H	110	45.6	3.3
6	4924.00	41.1 AV	54.0	-12.9	1.92 H	110	37.8	3.3

ANTENNA POLARITY & TEST DISTANCE: VERTICAL AT 3 M								
NO.	FREQ. (MHz)	EMISSION LEVEL (dBuV/m)	LIMIT (dBuV/m)	MARGIN (dB)	ANTENNA HEIGHT (m)	TABLE ANGLE (Degree)	RAW VALUE (dBuV)	CORRECTION FACTOR (dB/m)
1	*2462.00	103.2 PK			2.03 V	167	69.9	33.3
2	*2462.00	99.5 AV			2.03 V	167	66.2	33.3
3	2483.50	57.5 PK	74.0	-16.5	1.93 V	201	24.3	33.2
4	2483.50	46.9 AV	54.0	-7.1	1.93 V	201	13.7	33.2
5	4924.00	49.0 PK	74.0	-25.0	1.73 V	197	45.7	3.3
6	4924.00	42.2 AV	54.0	-11.8	1.73 V	197	38.9	3.3

Remarks:

1. Emission Level(dBuV/m) = Raw Value(dBuV) + Correction Factor(dB/m)
2. Correction Factor(dB/m) = Antenna Factor(dB/m) + Cable Factor(dB) – Pre-Amplifier Factor(dB)
3. The other emission levels were very low against the limit.
4. Margin value = Emission Level – Limit value
5. " * ": Fundamental frequency.

802.11g

CHANNEL	TX Channel 1	DETECTOR FUNCTION	Peak (PK) Average (AV)
FREQUENCY RANGE	1GHz ~ 25GHz		

ANTENNA POLARITY & TEST DISTANCE: HORIZONTAL AT 3 M

NO.	FREQ. (MHz)	EMISSION LEVEL (dBuV/m)	LIMIT (dBuV/m)	MARGIN (dB)	ANTENNA HEIGHT (m)	TABLE ANGLE (Degree)	RAW VALUE (dBuV)	CORRECTION FACTOR (dB/m)
1	2390.00	69.0 PK	74.0	-5.0	1.41 H	310	35.5	33.5
2	2390.00	52.5 AV	54.0	-1.5	1.41 H	310	19.0	33.5
3	*2412.00	111.9 PK			1.81 H	311	78.5	33.4
4	*2412.00	100.0 AV			1.81 H	311	66.6	33.4
5	4824.00	46.9 PK	74.0	-27.1	1.84 H	118	43.2	3.7
6	4824.00	36.1 AV	54.0	-17.9	1.84 H	118	32.4	3.7

ANTENNA POLARITY & TEST DISTANCE: VERTICAL AT 3 M

NO.	FREQ. (MHz)	EMISSION LEVEL (dBuV/m)	LIMIT (dBuV/m)	MARGIN (dB)	ANTENNA HEIGHT (m)	TABLE ANGLE (Degree)	RAW VALUE (dBuV)	CORRECTION FACTOR (dB/m)
1	2390.00	58.4 PK	74.0	-15.6	1.83 V	199	24.9	33.5
2	2390.00	46.9 AV	54.0	-7.1	1.83 V	199	13.4	33.5
3	*2412.00	101.6 PK			1.79 V	205	68.2	33.4
4	*2412.00	90.0 AV			1.79 V	205	56.6	33.4
5	4824.00	47.0 PK	74.0	-27.0	1.66 V	201	43.3	3.7
6	4824.00	36.1 AV	54.0	-17.9	1.66 V	201	32.4	3.7

Remarks:

1. Emission Level(dBuV/m) = Raw Value(dBuV) + Correction Factor(dB/m)
2. Correction Factor(dB/m) = Antenna Factor(dB/m) + Cable Factor(dB) – Pre-Amplifier Factor(dB)
3. The other emission levels were very low against the limit.
4. Margin value = Emission Level – Limit value
5. " * ": Fundamental frequency.

CHANNEL	TX Channel 6	DETECTOR FUNCTION	Peak (PK)
FREQUENCY RANGE	1GHz ~ 25GHz		Average (AV)

ANTENNA POLARITY & TEST DISTANCE: HORIZONTAL AT 3 M

NO.	FREQ. (MHz)	EMISSION LEVEL (dBuV/m)	LIMIT (dBuV/m)	MARGIN (dB)	ANTENNA HEIGHT (m)	TABLE ANGLE (Degree)	RAW VALUE (dBuV)	CORRECTION FACTOR (dB/m)
1	2390.00	69.2 PK	74.0	-4.8	1.53 H	318	35.7	33.5
2	2390.00	51.9 AV	54.0	-2.1	1.53 H	318	18.4	33.5
3	*2437.00	117.2 PK			1.49 H	310	83.8	33.4
4	*2437.00	105.9 AV			1.49 H	310	72.5	33.4
5	4874.00	47.0 PK	74.0	-27.0	1.60 H	119	43.5	3.5
6	4874.00	35.2 AV	54.0	-18.8	1.60 H	119	31.7	3.5

ANTENNA POLARITY & TEST DISTANCE: VERTICAL AT 3 M

NO.	FREQ. (MHz)	EMISSION LEVEL (dBuV/m)	LIMIT (dBuV/m)	MARGIN (dB)	ANTENNA HEIGHT (m)	TABLE ANGLE (Degree)	RAW VALUE (dBuV)	CORRECTION FACTOR (dB/m)
1	2390.00	59.9 PK	74.0	-14.1	1.88 V	196	26.4	33.5
2	2390.00	46.8 AV	54.0	-7.2	1.88 V	196	13.3	33.5
3	*2437.00	108.6 PK			1.71 V	154	75.2	33.4
4	*2437.00	96.6 AV			1.71 V	154	63.2	33.4
5	4874.00	47.3 PK	74.0	-26.7	1.71 V	198	43.8	3.5
6	4874.00	36.0 AV	54.0	-18.0	1.71 V	198	32.5	3.5

Remarks:

1. Emission Level(dBuV/m) = Raw Value(dBuV) + Correction Factor(dB/m)
2. Correction Factor(dB/m) = Antenna Factor(dB/m) + Cable Factor(dB) – Pre-Amplifier Factor(dB)
3. The other emission levels were very low against the limit.
4. Margin value = Emission Level – Limit value
5. " * ": Fundamental frequency.

CHANNEL	TX Channel 11	DETECTOR FUNCTION	Peak (PK)
FREQUENCY RANGE	1GHz ~ 25GHz		Average (AV)

ANTENNA POLARITY & TEST DISTANCE: HORIZONTAL AT 3 M								
NO.	FREQ. (MHz)	EMISSION LEVEL (dBuV/m)	LIMIT (dBuV/m)	MARGIN (dB)	ANTENNA HEIGHT (m)	TABLE ANGLE (Degree)	RAW VALUE (dBuV)	CORRECTION FACTOR (dB/m)
1	*2462.00	111.8 PK			1.81 H	312	78.5	33.3
2	*2462.00	99.9 AV			1.81 H	312	66.6	33.3
3	2483.50	68.5 PK	74.0	-5.5	1.51 H	310	35.3	33.2
4	2483.50	52.6 AV	54.0	-1.4	1.51 H	310	19.4	33.2
5	4924.00	46.5 PK	74.0	-27.5	1.94 H	107	43.2	3.3
6	4924.00	36.0 AV	54.0	-18.0	1.94 H	107	32.7	3.3

ANTENNA POLARITY & TEST DISTANCE: VERTICAL AT 3 M								
NO.	FREQ. (MHz)	EMISSION LEVEL (dBuV/m)	LIMIT (dBuV/m)	MARGIN (dB)	ANTENNA HEIGHT (m)	TABLE ANGLE (Degree)	RAW VALUE (dBuV)	CORRECTION FACTOR (dB/m)
1	*2462.00	101.4 PK			1.72 V	201	68.1	33.3
2	*2462.00	89.7 AV			1.72 V	201	56.4	33.3
3	2483.50	59.1 PK	74.0	-14.9	1.77 V	203	25.9	33.2
4	2483.50	46.2 AV	54.0	-7.8	1.77 V	203	13.0	33.2
5	4924.00	46.8 PK	74.0	-27.2	1.68 V	197	43.5	3.3
6	4924.00	36.6 AV	54.0	-17.4	1.68 V	197	33.3	3.3

Remarks:

1. Emission Level(dBuV/m) = Raw Value(dBuV) + Correction Factor(dB/m)
2. Correction Factor(dB/m) = Antenna Factor(dB/m) + Cable Factor(dB) – Pre-Amplifier Factor(dB)
3. The other emission levels were very low against the limit.
4. Margin value = Emission Level – Limit value
5. " * ": Fundamental frequency.

802.11n (HT20)

CHANNEL	TX Channel 1	DETECTOR FUNCTION	Peak (PK)
FREQUENCY RANGE	1GHz ~ 25GHz		Average (AV)

ANTENNA POLARITY & TEST DISTANCE: HORIZONTAL AT 3 M

NO.	FREQ. (MHz)	EMISSION LEVEL (dBuV/m)	LIMIT (dBuV/m)	MARGIN (dB)	ANTENNA HEIGHT (m)	TABLE ANGLE (Degree)	RAW VALUE (dBuV)	CORRECTION FACTOR (dB/m)
1	2390.00	68.1 PK	74.0	-5.9	1.34 H	314	34.6	33.5
2	2390.00	52.6 AV	54.0	-1.4	1.34 H	314	19.1	33.5
3	*2412.00	110.9 PK			1.58 H	314	77.5	33.4
4	*2412.00	99.2 AV			1.58 H	314	65.8	33.4
5	4824.00	46.5 PK	74.0	-27.5	1.82 H	117	42.8	3.7
6	4824.00	35.6 AV	54.0	-18.4	1.82 H	117	31.9	3.7

ANTENNA POLARITY & TEST DISTANCE: VERTICAL AT 3 M

NO.	FREQ. (MHz)	EMISSION LEVEL (dBuV/m)	LIMIT (dBuV/m)	MARGIN (dB)	ANTENNA HEIGHT (m)	TABLE ANGLE (Degree)	RAW VALUE (dBuV)	CORRECTION FACTOR (dB/m)
1	2390.00	58.8 PK	74.0	-15.2	1.48 V	166	25.3	33.5
2	2390.00	46.8 AV	54.0	-7.2	1.48 V	166	13.3	33.5
3	*2412.00	100.4 PK			1.39 V	145	67.0	33.4
4	*2412.00	89.0 AV			1.39 V	145	55.6	33.4
5	4824.00	47.0 PK	74.0	-27.0	1.66 V	208	43.3	3.7
6	4824.00	35.4 AV	54.0	-18.6	1.66 V	208	31.7	3.7

Remarks:

1. Emission Level(dBuV/m) = Raw Value(dBuV) + Correction Factor(dB/m)
2. Correction Factor(dB/m) = Antenna Factor(dB/m) + Cable Factor(dB) – Pre-Amplifier Factor(dB)
3. The other emission levels were very low against the limit.
4. Margin value = Emission Level – Limit value
5. " * ": Fundamental frequency.

CHANNEL	TX Channel 6	DETECTOR FUNCTION	Peak (PK)
FREQUENCY RANGE	1GHz ~ 25GHz		Average (AV)

ANTENNA POLARITY & TEST DISTANCE: HORIZONTAL AT 3 M

NO.	FREQ. (MHz)	EMISSION LEVEL (dBuV/m)	LIMIT (dBuV/m)	MARGIN (dB)	ANTENNA HEIGHT (m)	TABLE ANGLE (Degree)	RAW VALUE (dBuV)	CORRECTION FACTOR (dB/m)
1	2390.00	69.7 PK	74.0	-4.3	2.24 H	312	36.2	33.5
2	2390.00	52.7 AV	54.0	-1.3	2.24 H	312	19.2	33.5
3	*2437.00	116.1 PK			1.43 H	318	82.7	33.4
4	*2437.00	105.1 AV			1.43 H	318	71.7	33.4
5	4874.00	46.8 PK	74.0	-27.2	1.74 H	120	43.3	3.5
6	4874.00	35.3 AV	54.0	-18.7	1.74 H	120	31.8	3.5

ANTENNA POLARITY & TEST DISTANCE: VERTICAL AT 3 M

NO.	FREQ. (MHz)	EMISSION LEVEL (dBuV/m)	LIMIT (dBuV/m)	MARGIN (dB)	ANTENNA HEIGHT (m)	TABLE ANGLE (Degree)	RAW VALUE (dBuV)	CORRECTION FACTOR (dB/m)
1	2390.00	61.1 PK	74.0	-12.9	1.83 V	166	27.6	33.5
2	2390.00	46.9 AV	54.0	-7.1	1.83 V	166	13.4	33.5
3	*2437.00	107.6 PK			1.72 V	152	74.2	33.4
4	*2437.00	96.6 AV			1.72 V	152	63.2	33.4
5	4874.00	47.7 PK	74.0	-26.3	1.72 V	201	44.2	3.5
6	4874.00	36.3 AV	54.0	-17.7	1.72 V	201	32.8	3.5

Remarks:

1. Emission Level(dBuV/m) = Raw Value(dBuV) + Correction Factor(dB/m)
2. Correction Factor(dB/m) = Antenna Factor(dB/m) + Cable Factor(dB) – Pre-Amplifier Factor(dB)
3. The other emission levels were very low against the limit.
4. Margin value = Emission Level – Limit value
5. " * ": Fundamental frequency.

CHANNEL	TX Channel 11	DETECTOR FUNCTION	Peak (PK)
FREQUENCY RANGE	1GHz ~ 25GHz		Average (AV)

ANTENNA POLARITY & TEST DISTANCE: HORIZONTAL AT 3 M								
NO.	FREQ. (MHz)	EMISSION LEVEL (dBuV/m)	LIMIT (dBuV/m)	MARGIN (dB)	ANTENNA HEIGHT (m)	TABLE ANGLE (Degree)	RAW VALUE (dBuV)	CORRECTION FACTOR (dB/m)
1	*2462.00	111.2 PK			1.40 H	319	77.9	33.3
2	*2462.00	99.3 AV			1.40 H	319	66.0	33.3
3	2483.50	66.0 PK	74.0	-8.0	1.33 H	321	32.8	33.2
4	2483.50	52.2 AV	54.0	-1.8	1.33 H	321	19.0	33.2
5	4924.00	46.9 PK	74.0	-27.1	1.69 H	120	43.6	3.3
6	4924.00	36.0 AV	54.0	-18.0	1.69 H	120	32.7	3.3

ANTENNA POLARITY & TEST DISTANCE: VERTICAL AT 3 M								
NO.	FREQ. (MHz)	EMISSION LEVEL (dBuV/m)	LIMIT (dBuV/m)	MARGIN (dB)	ANTENNA HEIGHT (m)	TABLE ANGLE (Degree)	RAW VALUE (dBuV)	CORRECTION FACTOR (dB/m)
1	*2462.00	101.3 PK			1.47 V	201	68.0	33.3
2	*2462.00	89.2 AV			1.47 V	201	55.9	33.3
3	2483.50	58.4 PK	74.0	-15.6	1.48 V	206	25.2	33.2
4	2483.50	46.0 AV	54.0	-8.0	1.48 V	206	12.8	33.2
5	4924.00	47.2 PK	74.0	-26.8	1.46 V	205	43.9	3.3
6	4924.00	36.7 AV	54.0	-17.3	1.46 V	205	33.4	3.3

Remarks:

1. Emission Level(dBuV/m) = Raw Value(dBuV) + Correction Factor(dB/m)
2. Correction Factor(dB/m) = Antenna Factor(dB/m) + Cable Factor(dB) – Pre-Amplifier Factor(dB)
3. The other emission levels were very low against the limit.
4. Margin value = Emission Level – Limit value
5. " * ": Fundamental frequency.

802.11n (HT40)

CHANNEL	TX Channel 3	DETECTOR	Peak (PK)
FREQUENCY RANGE	1GHz ~ 25GHz	FUNCTION	Average (AV)

ANTENNA POLARITY & TEST DISTANCE: HORIZONTAL AT 3 M								
NO.	FREQ. (MHz)	EMISSION LEVEL (dBuV/m)	LIMIT (dBuV/m)	MARGIN (dB)	ANTENNA HEIGHT (m)	TABLE ANGLE (Degree)	RAW VALUE (dBuV)	CORRECTION FACTOR (dB/m)
1	2390.00	65.1 PK	74.0	-8.9	1.47 H	322	31.6	33.5
2	2390.00	52.7 AV	54.0	-1.3	1.47 H	322	19.2	33.5
3	*2422.00	104.6 PK			1.54 H	319	71.2	33.4
4	*2422.00	94.1 AV			1.54 H	319	60.7	33.4
5	4844.00	46.8 PK	74.0	-27.2	1.77 H	119	43.2	3.6
6	4844.00	35.6 AV	54.0	-18.4	1.77 H	119	32.0	3.6
ANTENNA POLARITY & TEST DISTANCE: VERTICAL AT 3 M								
NO.	FREQ. (MHz)	EMISSION LEVEL (dBuV/m)	LIMIT (dBuV/m)	MARGIN (dB)	ANTENNA HEIGHT (m)	TABLE ANGLE (Degree)	RAW VALUE (dBuV)	CORRECTION FACTOR (dB/m)
1	2390.00	58.0 PK	74.0	-16.0	1.89 V	159	24.5	33.5
2	2390.00	46.5 AV	54.0	-7.5	1.89 V	159	13.0	33.5
3	*2422.00	95.9 PK			1.83 V	165	62.5	33.4
4	*2422.00	85.2 AV			1.83 V	165	51.8	33.4
5	4844.00	46.9 PK	74.0	-27.1	1.75 V	200	43.3	3.6
6	4844.00	35.9 AV	54.0	-18.1	1.75 V	200	32.3	3.6

Remarks:

1. Emission Level(dBuV/m) = Raw Value(dBuV) + Correction Factor(dB/m)
2. Correction Factor(dB/m) = Antenna Factor(dB/m) + Cable Factor(dB) – Pre-Amplifier Factor(dB)
3. The other emission levels were very low against the limit.
4. Margin value = Emission Level – Limit value
5. " * ": Fundamental frequency.

CHANNEL	TX Channel 6	DETECTOR FUNCTION	Peak (PK)
FREQUENCY RANGE	1GHz ~ 25GHz		Average (AV)

ANTENNA POLARITY & TEST DISTANCE: HORIZONTAL AT 3 M								
NO.	FREQ. (MHz)	EMISSION LEVEL (dBuV/m)	LIMIT (dBuV/m)	MARGIN (dB)	ANTENNA HEIGHT (m)	TABLE ANGLE (Degree)	RAW VALUE (dBuV)	CORRECTION FACTOR (dB/m)
1	2390.00	66.7 PK	74.0	-7.3	1.59 H	314	33.2	33.5
2	2390.00	52.8 AV	54.0	-1.2	1.59 H	314	19.3	33.5
3	*2437.00	109.1 PK			1.82 H	312	75.7	33.4
4	*2437.00	98.0 AV			1.82 H	312	64.6	33.4
5	4874.00	46.7 PK	74.0	-27.3	1.95 H	111	43.2	3.5
6	4874.00	35.4 AV	54.0	-18.6	1.95 H	111	31.9	3.5

ANTENNA POLARITY & TEST DISTANCE: VERTICAL AT 3 M								
NO.	FREQ. (MHz)	EMISSION LEVEL (dBuV/m)	LIMIT (dBuV/m)	MARGIN (dB)	ANTENNA HEIGHT (m)	TABLE ANGLE (Degree)	RAW VALUE (dBuV)	CORRECTION FACTOR (dB/m)
1	2390.00	58.4 PK	74.0	-15.6	1.77 V	162	24.9	33.5
2	2390.00	46.8 AV	54.0	-7.2	1.77 V	162	13.3	33.5
3	*2437.00	99.3 PK			1.73 V	148	65.9	33.4
4	*2437.00	88.8 AV			1.73 V	148	55.4	33.4
5	4874.00	47.2 PK	74.0	-26.8	1.71 V	201	43.7	3.5
6	4874.00	36.0 AV	54.0	-18.0	1.71 V	201	32.5	3.5

Remarks:

1. Emission Level(dBuV/m) = Raw Value(dBuV) + Correction Factor(dB/m)
2. Correction Factor(dB/m) = Antenna Factor(dB/m) + Cable Factor(dB) – Pre-Amplifier Factor(dB)
3. The other emission levels were very low against the limit.
4. Margin value = Emission Level – Limit value
5. " * ": Fundamental frequency.

CHANNEL	TX Channel 9	DETECTOR FUNCTION	Peak (PK)
FREQUENCY RANGE	1GHz ~ 25GHz		Average (AV)

ANTENNA POLARITY & TEST DISTANCE: HORIZONTAL AT 3 M								
NO.	FREQ. (MHz)	EMISSION LEVEL (dBuV/m)	LIMIT (dBuV/m)	MARGIN (dB)	ANTENNA HEIGHT (m)	TABLE ANGLE (Degree)	RAW VALUE (dBuV)	CORRECTION FACTOR (dB/m)
1	*2452.00	107.6 PK			1.37 H	323	74.2	33.4
2	*2452.00	96.7 AV			1.37 H	323	63.3	33.4
3	2483.50	68.0 PK	74.0	-6.0	1.34 H	324	34.8	33.2
4	2483.50	52.4 AV	54.0	-1.6	1.34 H	324	19.2	33.2
5	4904.00	46.8 PK	74.0	-27.2	1.79 H	116	43.4	3.4
6	4904.00	36.1 AV	54.0	-17.9	1.79 H	116	32.7	3.4
ANTENNA POLARITY & TEST DISTANCE: VERTICAL AT 3 M								
NO.	FREQ. (MHz)	EMISSION LEVEL (dBuV/m)	LIMIT (dBuV/m)	MARGIN (dB)	ANTENNA HEIGHT (m)	TABLE ANGLE (Degree)	RAW VALUE (dBuV)	CORRECTION FACTOR (dB/m)
1	*2452.00	98.0 PK			1.71 V	152	64.6	33.4
2	*2452.00	87.0 AV			1.71 V	152	53.6	33.4
3	2483.50	59.3 PK	74.0	-14.7	1.87 V	212	26.1	33.2
4	2483.50	46.3 AV	54.0	-7.7	1.87 V	212	13.1	33.2
5	4904.00	46.8 PK	74.0	-27.2	1.62 V	200	43.4	3.4
6	4904.00	37.1 AV	54.0	-16.9	1.62 V	200	33.7	3.4

Remarks:

1. Emission Level(dBuV/m) = Raw Value(dBuV) + Correction Factor(dB/m)
2. Correction Factor(dB/m) = Antenna Factor(dB/m) + Cable Factor(dB) – Pre-Amplifier Factor(dB)
3. The other emission levels were very low against the limit.
4. Margin value = Emission Level – Limit value
5. " * ": Fundamental frequency.

Radio 3

802.11b

CHANNEL	TX Channel 1	DETECTOR FUNCTION	Peak (PK)
FREQUENCY RANGE	1GHz ~ 25GHz		Average (AV)

ANTENNA POLARITY & TEST DISTANCE: HORIZONTAL AT 3 M								
NO.	FREQ. (MHz)	EMISSION LEVEL (dBuV/m)	LIMIT (dBuV/m)	MARGIN (dB)	ANTENNA HEIGHT (m)	TABLE ANGLE (Degree)	RAW VALUE (dBuV)	CORRECTION FACTOR (dB/m)
1	2390.00	57.4 PK	74.0	-16.6	1.98 H	218	23.9	33.5
2	2390.00	45.9 AV	54.0	-8.1	1.98 H	218	12.4	33.5
3	*2412.00	96.2 PK			1.69 H	196	62.8	33.4
4	*2412.00	92.6 AV			1.69 H	196	59.2	33.4
5	4824.00	49.1 PK	74.0	-24.9	3.88 H	78	45.4	3.7
6	4824.00	42.3 AV	54.0	-11.7	3.88 H	78	38.6	3.7
ANTENNA POLARITY & TEST DISTANCE: VERTICAL AT 3 M								
NO.	FREQ. (MHz)	EMISSION LEVEL (dBuV/m)	LIMIT (dBuV/m)	MARGIN (dB)	ANTENNA HEIGHT (m)	TABLE ANGLE (Degree)	RAW VALUE (dBuV)	CORRECTION FACTOR (dB/m)
1	2390.00	61.0 PK	74.0	-13.0	1.88 V	235	27.5	33.5
2	2390.00	48.2 AV	54.0	-5.8	1.88 V	235	14.7	33.5
3	*2412.00	103.0 PK			1.57 V	201	69.6	33.4
4	*2412.00	99.4 AV			1.57 V	201	66.0	33.4
5	4824.00	48.0 PK	74.0	-26.0	1.60 V	244	44.3	3.7
6	4824.00	39.4 AV	54.0	-14.6	1.60 V	244	35.7	3.7

Remarks:

1. Emission Level(dBuV/m) = Raw Value(dBuV) + Correction Factor(dB/m)
2. Correction Factor(dB/m) = Antenna Factor(dB/m) + Cable Factor(dB) – Pre-Amplifier Factor(dB)
3. The other emission levels were very low against the limit.
4. Margin value = Emission Level – Limit value
5. " * ": Fundamental frequency.

CHANNEL	TX Channel 6	DETECTOR FUNCTION	Peak (PK)
FREQUENCY RANGE	1GHz ~ 25GHz		Average (AV)

ANTENNA POLARITY & TEST DISTANCE: HORIZONTAL AT 3 M

NO.	FREQ. (MHz)	EMISSION LEVEL (dBuV/m)	LIMIT (dBuV/m)	MARGIN (dB)	ANTENNA HEIGHT (m)	TABLE ANGLE (Degree)	RAW VALUE (dBuV)	CORRECTION FACTOR (dB/m)
1	*2437.00	103.4 PK			3.55 H	325	70.0	33.4
2	*2437.00	99.7 AV			3.55 H	325	66.3	33.4
3	4874.00	47.9 PK	74.0	-26.1	3.83 H	80	44.4	3.5
4	4874.00	38.7 AV	54.0	-15.3	3.83 H	80	35.2	3.5

ANTENNA POLARITY & TEST DISTANCE: VERTICAL AT 3 M

NO.	FREQ. (MHz)	EMISSION LEVEL (dBuV/m)	LIMIT (dBuV/m)	MARGIN (dB)	ANTENNA HEIGHT (m)	TABLE ANGLE (Degree)	RAW VALUE (dBuV)	CORRECTION FACTOR (dB/m)
1	*2437.00	110.9 PK			1.70 V	222	77.5	33.4
2	*2437.00	107.2 AV			1.70 V	222	73.8	33.4
3	4874.00	47.8 PK	74.0	-26.2	1.68 V	246	44.3	3.5
4	4874.00	38.5 AV	54.0	-15.5	1.68 V	246	35.0	3.5

Remarks:

1. Emission Level(dBuV/m) = Raw Value(dBuV) + Correction Factor(dB/m)
2. Correction Factor(dB/m) = Antenna Factor(dB/m) + Cable Factor(dB) – Pre-Amplifier Factor(dB)
3. The other emission levels were very low against the limit.
4. Margin value = Emission Level – Limit value
5. " * ": Fundamental frequency.

CHANNEL	TX Channel 11	DETECTOR FUNCTION	Peak (PK)
FREQUENCY RANGE	1GHz ~ 25GHz		Average (AV)

ANTENNA POLARITY & TEST DISTANCE: HORIZONTAL AT 3 M								
NO.	FREQ. (MHz)	EMISSION LEVEL (dBuV/m)	LIMIT (dBuV/m)	MARGIN (dB)	ANTENNA HEIGHT (m)	TABLE ANGLE (Degree)	RAW VALUE (dBuV)	CORRECTION FACTOR (dB/m)
1	*2462.00	97.4 PK			3.58 H	311	64.1	33.3
2	*2462.00	93.7 AV			3.58 H	311	60.4	33.3
3	2483.50	57.2 PK	74.0	-16.8	2.99 H	178	24.0	33.2
4	2483.50	49.9 AV	54.0	-4.1	2.99 H	178	16.7	33.2
5	4924.00	48.9 PK	74.0	-25.1	2.38 H	219	45.6	3.3
6	4924.00	41.0 AV	54.0	-13.0	2.38 H	219	37.7	3.3
ANTENNA POLARITY & TEST DISTANCE: VERTICAL AT 3 M								
NO.	FREQ. (MHz)	EMISSION LEVEL (dBuV/m)	LIMIT (dBuV/m)	MARGIN (dB)	ANTENNA HEIGHT (m)	TABLE ANGLE (Degree)	RAW VALUE (dBuV)	CORRECTION FACTOR (dB/m)
1	*2462.00	106.1 PK			1.89 V	192	72.8	33.3
2	*2462.00	102.2 AV			1.89 V	192	68.9	33.3
3	2483.50	61.7 PK	74.0	-12.3	1.52 V	223	28.5	33.2
4	2483.50	50.6 AV	54.0	-3.4	1.52 V	223	17.4	33.2
5	4924.00	47.1 PK	74.0	-26.9	1.70 V	175	43.8	3.3
6	4924.00	37.1 AV	54.0	-16.9	1.70 V	175	33.8	3.3

Remarks:

1. Emission Level(dBuV/m) = Raw Value(dBuV) + Correction Factor(dB/m)
2. Correction Factor(dB/m) = Antenna Factor(dB/m) + Cable Factor(dB) – Pre-Amplifier Factor(dB)
3. The other emission levels were very low against the limit.
4. Margin value = Emission Level – Limit value
5. " * ": Fundamental frequency.

802.11g

CHANNEL	TX Channel 1	DETECTOR FUNCTION	Peak (PK) Average (AV)
FREQUENCY RANGE	1GHz ~ 25GHz		

ANTENNA POLARITY & TEST DISTANCE: HORIZONTAL AT 3 M								
NO.	FREQ. (MHz)	EMISSION LEVEL (dBuV/m)	LIMIT (dBuV/m)	MARGIN (dB)	ANTENNA HEIGHT (m)	TABLE ANGLE (Degree)	RAW VALUE (dBuV)	CORRECTION FACTOR (dB/m)
1	2390.00	57.3 PK	74.0	-16.7	1.99 H	123	23.8	33.5
2	2390.00	46.7 AV	54.0	-7.3	1.99 H	123	13.2	33.5
3	*2412.00	96.6 PK			2.02 H	12	63.2	33.4
4	*2412.00	85.8 AV			2.02 H	12	52.4	33.4
5	4824.00	46.9 PK	74.0	-27.1	1.83 H	262	43.2	3.7
6	4824.00	32.6 AV	54.0	-21.4	1.83 H	262	28.9	3.7
ANTENNA POLARITY & TEST DISTANCE: VERTICAL AT 3 M								
NO.	FREQ. (MHz)	EMISSION LEVEL (dBuV/m)	LIMIT (dBuV/m)	MARGIN (dB)	ANTENNA HEIGHT (m)	TABLE ANGLE (Degree)	RAW VALUE (dBuV)	CORRECTION FACTOR (dB/m)
1	2390.00	67.5 PK	74.0	-6.5	1.62 V	224	34.0	33.5
2	2390.00	50.6 AV	54.0	-3.4	1.62 V	224	17.1	33.5
3	*2412.00	104.7 PK			1.28 V	188	71.3	33.4
4	*2412.00	95.0 AV			1.28 V	188	61.6	33.4
5	4824.00	46.3 PK	74.0	-27.7	2.26 V	117	42.6	3.7
6	4824.00	35.0 AV	54.0	-19.0	2.26 V	117	31.3	3.7

Remarks:

1. Emission Level(dBuV/m) = Raw Value(dBuV) + Correction Factor(dB/m)
2. Correction Factor(dB/m) = Antenna Factor(dB/m) + Cable Factor(dB) – Pre-Amplifier Factor(dB)
3. The other emission levels were very low against the limit.
4. Margin value = Emission Level – Limit value
5. " * " : Fundamental frequency.

CHANNEL	TX Channel 6	DETECTOR FUNCTION	Peak (PK)
FREQUENCY RANGE	1GHz ~ 25GHz		Average (AV)

ANTENNA POLARITY & TEST DISTANCE: HORIZONTAL AT 3 M

NO.	FREQ. (MHz)	EMISSION LEVEL (dBuV/m)	LIMIT (dBuV/m)	MARGIN (dB)	ANTENNA HEIGHT (m)	TABLE ANGLE (Degree)	RAW VALUE (dBuV)	CORRECTION FACTOR (dB/m)
1	*2437.00	103.7 PK			3.56 H	324	70.3	33.4
2	*2437.00	92.9 AV			3.56 H	324	59.5	33.4
3	2483.50	58.5 PK	74.0	-15.5	3.03 H	294	25.3	33.2
4	2483.50	46.8 AV	54.0	-7.2	3.03 H	294	13.6	33.2
5	4874.00	46.6 PK	74.0	-27.4	2.18 H	165	43.1	3.5
6	4874.00	33.2 AV	54.0	-20.8	2.18 H	165	29.7	3.5

ANTENNA POLARITY & TEST DISTANCE: VERTICAL AT 3 M

NO.	FREQ. (MHz)	EMISSION LEVEL (dBuV/m)	LIMIT (dBuV/m)	MARGIN (dB)	ANTENNA HEIGHT (m)	TABLE ANGLE (Degree)	RAW VALUE (dBuV)	CORRECTION FACTOR (dB/m)
1	*2437.00	112.4 PK			1.69 V	214	79.0	33.4
2	*2437.00	102.0 AV			1.69 V	214	68.6	33.4
3	2483.50	64.9 PK	74.0	-9.1	1.72 V	205	31.7	33.2
4	2483.50	52.1 AV	54.0	-1.9	1.72 V	205	18.9	33.2
5	4874.00	46.0 PK	74.0	-28.0	1.74 V	213	42.5	3.5
6	4874.00	33.1 AV	54.0	-20.9	1.74 V	213	29.6	3.5

Remarks:

1. Emission Level(dBuV/m) = Raw Value(dBuV) + Correction Factor(dB/m)
2. Correction Factor(dB/m) = Antenna Factor(dB/m) + Cable Factor(dB) – Pre-Amplifier Factor(dB)
3. The other emission levels were very low against the limit.
4. Margin value = Emission Level – Limit value
5. " * ": Fundamental frequency.

CHANNEL	TX Channel 11	DETECTOR FUNCTION	Peak (PK)
FREQUENCY RANGE	1GHz ~ 25GHz		Average (AV)

ANTENNA POLARITY & TEST DISTANCE: HORIZONTAL AT 3 M								
NO.	FREQ. (MHz)	EMISSION LEVEL (dBuV/m)	LIMIT (dBuV/m)	MARGIN (dB)	ANTENNA HEIGHT (m)	TABLE ANGLE (Degree)	RAW VALUE (dBuV)	CORRECTION FACTOR (dB/m)
1	*2462.00	94.3 PK			1.50 H	123	61.0	33.3
2	*2462.00	83.9 AV			1.50 H	123	50.6	33.3
3	2483.50	58.8 PK	74.0	-15.2	1.89 H	87	25.6	33.2
4	2483.50	46.4 AV	54.0	-7.6	1.89 H	87	13.2	33.2
5	4924.00	45.4 PK	74.0	-28.6	2.36 H	179	42.1	3.3
6	4924.00	32.2 AV	54.0	-21.8	2.36 H	179	28.9	3.3
ANTENNA POLARITY & TEST DISTANCE: VERTICAL AT 3 M								
NO.	FREQ. (MHz)	EMISSION LEVEL (dBuV/m)	LIMIT (dBuV/m)	MARGIN (dB)	ANTENNA HEIGHT (m)	TABLE ANGLE (Degree)	RAW VALUE (dBuV)	CORRECTION FACTOR (dB/m)
1	*2462.00	105.2 PK			1.58 V	203	71.9	33.3
2	*2462.00	94.8 AV			1.58 V	203	61.5	33.3
3	2483.50	67.7 PK	74.0	-6.3	1.52 V	229	34.5	33.2
4	2483.50	52.4 AV	54.0	-1.6	1.52 V	229	19.2	33.2
5	4924.00	45.9 PK	74.0	-28.1	1.66 V	212	42.6	3.3
6	4924.00	32.4 AV	54.0	-21.6	1.66 V	212	29.1	3.3

Remarks:

1. Emission Level(dBuV/m) = Raw Value(dBuV) + Correction Factor(dB/m)
2. Correction Factor(dB/m) = Antenna Factor(dB/m) + Cable Factor(dB) – Pre-Amplifier Factor(dB)
3. The other emission levels were very low against the limit.
4. Margin value = Emission Level – Limit value
5. " * ": Fundamental frequency.

802.11n (HT20)

CHANNEL	TX Channel 1	DETECTOR FUNCTION	Peak (PK) Average (AV)
FREQUENCY RANGE	1GHz ~ 25GHz		

ANTENNA POLARITY & TEST DISTANCE: HORIZONTAL AT 3 M

NO.	FREQ. (MHz)	EMISSION LEVEL (dBuV/m)	LIMIT (dBuV/m)	MARGIN (dB)	ANTENNA HEIGHT (m)	TABLE ANGLE (Degree)	RAW VALUE (dBuV)	CORRECTION FACTOR (dB/m)
1	2390.00	58.4 PK	74.0	-15.6	3.54 H	308	24.9	33.5
2	2390.00	46.8 AV	54.0	-7.2	3.54 H	308	13.3	33.5
3	*2412.00	97.7 PK			3.69 H	322	64.3	33.4
4	*2412.00	87.7 AV			3.69 H	322	54.3	33.4
5	4824.00	49.4 PK	74.0	-24.6	2.87 H	186	45.7	3.7
6	4824.00	37.1 AV	54.0	-16.9	2.87 H	186	33.4	3.7

ANTENNA POLARITY & TEST DISTANCE: VERTICAL AT 3 M

NO.	FREQ. (MHz)	EMISSION LEVEL (dBuV/m)	LIMIT (dBuV/m)	MARGIN (dB)	ANTENNA HEIGHT (m)	TABLE ANGLE (Degree)	RAW VALUE (dBuV)	CORRECTION FACTOR (dB/m)
1	2390.00	65.6 PK	74.0	-8.4	1.64 V	233	32.1	33.5
2	2390.00	51.3 AV	54.0	-2.7	1.64 V	233	17.8	33.5
3	*2412.00	105.4 PK			1.64 V	203	72.0	33.4
4	*2412.00	94.7 AV			1.64 V	203	61.3	33.4
5	4824.00	46.9 PK	74.0	-27.1	1.65 V	198	43.2	3.7
6	4824.00	35.4 AV	54.0	-18.6	1.65 V	198	31.7	3.7

Remarks:

1. Emission Level(dBuV/m) = Raw Value(dBuV) + Correction Factor(dB/m)
2. Correction Factor(dB/m) = Antenna Factor(dB/m) + Cable Factor(dB) – Pre-Amplifier Factor(dB)
3. The other emission levels were very low against the limit.
4. Margin value = Emission Level – Limit value
5. " * ": Fundamental frequency.

CHANNEL	TX Channel 6	DETECTOR FUNCTION	Peak (PK)
FREQUENCY RANGE	1GHz ~ 25GHz		Average (AV)

ANTENNA POLARITY & TEST DISTANCE: HORIZONTAL AT 3 M

NO.	FREQ. (MHz)	EMISSION LEVEL (dBuV/m)	LIMIT (dBuV/m)	MARGIN (dB)	ANTENNA HEIGHT (m)	TABLE ANGLE (Degree)	RAW VALUE (dBuV)	CORRECTION FACTOR (dB/m)
1	*2437.00	103.5 PK			3.53 H	325	70.1	33.4
2	*2437.00	93.0 AV			3.53 H	325	59.6	33.4
3	2483.50	59.4 PK	74.0	-14.6	3.05 H	311	26.2	33.2
4	2483.50	46.8 AV	54.0	-7.2	3.05 H	311	13.6	33.2
5	4874.00	47.2 PK	74.0	-26.8	2.41 H	138	43.7	3.5
6	4874.00	32.8 AV	54.0	-21.2	2.41 H	138	29.3	3.5

ANTENNA POLARITY & TEST DISTANCE: VERTICAL AT 3 M

NO.	FREQ. (MHz)	EMISSION LEVEL (dBuV/m)	LIMIT (dBuV/m)	MARGIN (dB)	ANTENNA HEIGHT (m)	TABLE ANGLE (Degree)	RAW VALUE (dBuV)	CORRECTION FACTOR (dB/m)
1	*2437.00	111.3 PK			1.58 V	234	77.9	33.4
2	*2437.00	101.0 AV			1.58 V	234	67.6	33.4
3	2483.50	64.8 PK	74.0	-9.2	1.50 V	230	31.6	33.2
4	2483.50	51.4 AV	54.0	-2.6	1.50 V	230	18.2	33.2
5	4874.00	46.7 PK	74.0	-27.3	1.86 V	202	43.2	3.5
6	4874.00	32.4 AV	54.0	-21.6	1.86 V	202	28.9	3.5

Remarks:

1. Emission Level(dBuV/m) = Raw Value(dBuV) + Correction Factor(dB/m)
2. Correction Factor(dB/m) = Antenna Factor(dB/m) + Cable Factor(dB) – Pre-Amplifier Factor(dB)
3. The other emission levels were very low against the limit.
4. Margin value = Emission Level – Limit value
5. " * ": Fundamental frequency.

CHANNEL	TX Channel 11	DETECTOR FUNCTION	Peak (PK)
FREQUENCY RANGE	1GHz ~ 25GHz		Average (AV)

ANTENNA POLARITY & TEST DISTANCE: HORIZONTAL AT 3 M								
NO.	FREQ. (MHz)	EMISSION LEVEL (dBuV/m)	LIMIT (dBuV/m)	MARGIN (dB)	ANTENNA HEIGHT (m)	TABLE ANGLE (Degree)	RAW VALUE (dBuV)	CORRECTION FACTOR (dB/m)
1	*2462.00	94.7 PK			1.50 H	123	61.4	33.3
2	*2462.00	83.5 AV			1.50 H	123	50.2	33.3
3	2483.50	59.6 PK	74.0	-14.4	1.66 H	148	26.4	33.2
4	2483.50	46.9 AV	54.0	-7.1	1.66 H	148	13.7	33.2
5	4924.00	46.9 PK	74.0	-27.1	2.48 H	238	43.6	3.3
6	4924.00	32.9 AV	54.0	-21.1	2.48 H	238	29.6	3.3
ANTENNA POLARITY & TEST DISTANCE: VERTICAL AT 3 M								
NO.	FREQ. (MHz)	EMISSION LEVEL (dBuV/m)	LIMIT (dBuV/m)	MARGIN (dB)	ANTENNA HEIGHT (m)	TABLE ANGLE (Degree)	RAW VALUE (dBuV)	CORRECTION FACTOR (dB/m)
1	*2462.00	104.5 PK			1.59 V	202	71.2	33.3
2	*2462.00	94.1 AV			1.59 V	202	60.8	33.3
3	2483.50	67.8 PK	74.0	-6.2	1.50 V	234	34.6	33.2
4	2483.50	52.5 AV	54.0	-1.5	1.50 V	234	19.3	33.2
5	4924.00	45.9 PK	74.0	-28.1	1.89 V	215	42.6	3.3
6	4924.00	32.5 AV	54.0	-21.5	1.89 V	215	29.2	3.3

Remarks:

1. Emission Level(dBuV/m) = Raw Value(dBuV) + Correction Factor(dB/m)
2. Correction Factor(dB/m) = Antenna Factor(dB/m) + Cable Factor(dB) – Pre-Amplifier Factor(dB)
3. The other emission levels were very low against the limit.
4. Margin value = Emission Level – Limit value
5. " * ": Fundamental frequency.

Below 1GHz worst-case data:

Radio 1

802.11b

CHANNEL	TX Channel 6	DETECTOR FUNCTION	Quasi-Peak (QP)
FREQUENCY RANGE	9kHz ~ 1GHz		
TEST MODE	A		

ANTENNA POLARITY & TEST DISTANCE: HORIZONTAL AT 3 M								
NO.	FREQ. (MHz)	EMISSION LEVEL (dBuV/m)	LIMIT (dBuV/m)	MARGIN (dB)	ANTENNA HEIGHT (m)	TABLE ANGLE (Degree)	RAW VALUE (dBuV)	CORRECTION FACTOR (dB/m)
1	57.12	27.3 QP	40.0	-12.7	2.00 H	287	41.7	-14.4
2	92.12	26.9 QP	43.5	-16.6	2.00 H	123	46.5	-19.6
3	274.88	37.4 QP	46.0	-8.6	1.00 H	242	50.7	-13.3
4	414.87	37.8 QP	46.0	-8.2	2.00 H	18	48.8	-11.0
5	469.31	36.4 QP	46.0	-9.6	1.49 H	116	46.2	-9.8
6	624.85	39.0 QP	46.0	-7.0	1.00 H	139	45.8	-6.8

ANTENNA POLARITY & TEST DISTANCE: VERTICAL AT 3 M								
NO.	FREQ. (MHz)	EMISSION LEVEL (dBuV/m)	LIMIT (dBuV/m)	MARGIN (dB)	ANTENNA HEIGHT (m)	TABLE ANGLE (Degree)	RAW VALUE (dBuV)	CORRECTION FACTOR (dB/m)
1	38.21	20.9 QP	40.0	-19.1	1.48 V	156	36.1	-15.2
2	53.23	32.9 QP	40.0	-7.1	1.00 V	10	47.1	-14.2
3	276.82	34.8 QP	46.0	-11.2	2.00 V	274	48.1	-13.3
4	411.13	41.0 QP	46.0	-5.0	1.12 V	115	52.0	-11.0
5	523.75	33.5 QP	46.0	-12.5	1.00 V	257	42.6	-9.1
6	624.85	40.4 QP	46.0	-5.6	1.00 V	244	47.2	-6.8

Remarks:

1. Emission Level(dBuV/m) = Raw Value(dBuV) + Correction Factor(dB/m)
2. Correction Factor(dB/m) = Antenna Factor(dB/m) + Cable Factor(dB) – Pre-Amplifier Factor(dB)
3. The other emission levels were very low against the limit.
4. Margin value = Emission Level – Limit value

CHANNEL	TX Channel 6	DETECTOR FUNCTION	Quasi-Peak (QP)
FREQUENCY RANGE	9kHz ~ 1GHz		
TEST MODE	B		

ANTENNA POLARITY & TEST DISTANCE: HORIZONTAL AT 3 M

NO.	FREQ. (MHz)	EMISSION LEVEL (dBuV/m)	LIMIT (dBuV/m)	MARGIN (dB)	ANTENNA HEIGHT (m)	TABLE ANGLE (Degree)	RAW VALUE (dBuV)	CORRECTION FACTOR (dB/m)
1	57.12	26.3 QP	40.0	-13.7	2.00 H	6	40.7	-14.4
2	154.33	29.3 QP	43.5	-14.2	2.00 H	277	43.1	-13.8
3	189.33	29.2 QP	43.5	-14.3	1.00 H	298	45.4	-16.2
4	276.82	28.7 QP	46.0	-17.3	1.00 H	260	42.0	-13.3
5	471.25	36.7 QP	46.0	-9.3	2.00 H	321	46.5	-9.8
6	624.85	37.3 QP	46.0	-8.7	1.00 H	150	44.1	-6.8

ANTENNA POLARITY & TEST DISTANCE: VERTICAL AT 3 M

NO.	FREQ. (MHz)	EMISSION LEVEL (dBuV/m)	LIMIT (dBuV/m)	MARGIN (dB)	ANTENNA HEIGHT (m)	TABLE ANGLE (Degree)	RAW VALUE (dBuV)	CORRECTION FACTOR (dB/m)
1	37.68	31.8 QP	40.0	-8.2	1.00 V	296	47.1	-15.3
2	99.89	33.5 QP	43.5	-10.0	1.00 V	135	52.0	-18.5
3	278.77	30.7 QP	46.0	-15.3	2.00 V	98	43.9	-13.2
4	374.04	33.4 QP	46.0	-12.6	1.49 V	277	45.0	-11.6
5	410.98	37.8 QP	46.0	-8.2	1.49 V	15	48.8	-11.0
6	624.85	36.4 QP	46.0	-9.6	1.00 V	230	43.2	-6.8

Remarks:

1. Emission Level(dBuV/m) = Raw Value(dBuV) + Correction Factor(dB/m)
2. Correction Factor(dB/m) = Antenna Factor(dB/m) + Cable Factor(dB) – Pre-Amplifier Factor(dB)
3. The other emission levels were very low against the limit.
4. Margin value = Emission Level – Limit value

Radio 3

802.11b

CHANNEL	TX Channel 6	DETECTOR FUNCTION	Quasi-Peak (QP)
FREQUENCY RANGE	9kHz ~ 1GHz		
TEST MODE	A		

ANTENNA POLARITY & TEST DISTANCE: HORIZONTAL AT 3 M

NO.	FREQ. (MHz)	EMISSION LEVEL (dBuV/m)	LIMIT (dBuV/m)	MARGIN (dB)	ANTENNA HEIGHT (m)	TABLE ANGLE (Degree)	RAW VALUE (dBuV)	CORRECTION FACTOR (dB/m)
1	57.12	26.2 QP	40.0	-13.8	2.00 H	10	40.6	-14.4
2	278.77	33.3 QP	46.0	-12.7	1.00 H	236	46.5	-13.2
3	374.04	33.6 QP	46.0	-12.4	1.00 H	245	45.2	-11.6
4	414.87	36.5 QP	46.0	-9.5	1.00 H	25	47.5	-11.0
5	469.31	38.9 QP	46.0	-7.1	2.00 H	131	48.7	-9.8
6	624.85	39.1 QP	46.0	-6.9	1.00 H	149	45.9	-6.8

ANTENNA POLARITY & TEST DISTANCE: VERTICAL AT 3 M

NO.	FREQ. (MHz)	EMISSION LEVEL (dBuV/m)	LIMIT (dBuV/m)	MARGIN (dB)	ANTENNA HEIGHT (m)	TABLE ANGLE (Degree)	RAW VALUE (dBuV)	CORRECTION FACTOR (dB/m)
1	37.26	33.9 QP	40.0	-6.1	1.00 V	234	49.3	-15.4
2	45.45	34.2 QP	40.0	-5.8	1.00 V	76	48.6	-14.4
3	280.71	31.0 QP	46.0	-15.0	2.00 V	266	44.1	-13.1
4	412.92	40.0 QP	46.0	-6.0	1.00 V	118	51.0	-11.0
5	465.42	37.1 QP	46.0	-8.9	1.00 V	280	47.0	-9.9
6	624.85	36.5 QP	46.0	-9.5	1.00 V	242	43.3	-6.8

Remarks:

1. Emission Level(dBuV/m) = Raw Value(dBuV) + Correction Factor(dB/m)
2. Correction Factor(dB/m) = Antenna Factor(dB/m) + Cable Factor(dB) – Pre-Amplifier Factor(dB)
3. The other emission levels were very low against the limit.
4. Margin value = Emission Level – Limit value

CHANNEL	TX Channel 6	DETECTOR FUNCTION	Quasi-Peak (QP)
FREQUENCY RANGE	9kHz ~ 1GHz		
TEST MODE	B		

ANTENNA POLARITY & TEST DISTANCE: HORIZONTAL AT 3 M

NO.	FREQ. (MHz)	EMISSION LEVEL (dBuV/m)	LIMIT (dBuV/m)	MARGIN (dB)	ANTENNA HEIGHT (m)	TABLE ANGLE (Degree)	RAW VALUE (dBuV)	CORRECTION FACTOR (dB/m)
1	57.12	26.5 QP	40.0	-13.5	2.00 H	251	40.9	-14.4
2	152.39	28.9 QP	43.5	-14.6	2.00 H	91	42.7	-13.8
3	189.33	29.6 QP	43.5	-13.9	2.00 H	304	45.8	-16.2
4	274.88	31.8 QP	46.0	-14.2	1.01 H	278	45.1	-13.3
5	469.31	38.5 QP	46.0	-7.5	2.00 H	303	48.3	-9.8
6	624.85	37.5 QP	46.0	-8.5	1.01 H	153	44.3	-6.8

ANTENNA POLARITY & TEST DISTANCE: VERTICAL AT 3 M

NO.	FREQ. (MHz)	EMISSION LEVEL (dBuV/m)	LIMIT (dBuV/m)	MARGIN (dB)	ANTENNA HEIGHT (m)	TABLE ANGLE (Degree)	RAW VALUE (dBuV)	CORRECTION FACTOR (dB/m)
1	37.68	35.7 QP	40.0	-4.3	1.00 V	7	51.0	-15.3
2	97.95	35.0 QP	43.5	-8.5	1.00 V	121	53.6	-18.6
3	185.44	28.9 QP	43.5	-14.6	1.00 V	92	44.7	-15.8
4	276.82	32.2 QP	46.0	-13.8	1.99 V	295	45.5	-13.3
5	410.98	39.4 QP	46.0	-6.6	1.50 V	13	50.4	-11.0
6	624.85	36.4 QP	46.0	-9.6	1.00 V	237	43.2	-6.8

Remarks:

1. Emission Level(dBuV/m) = Raw Value(dBuV) + Correction Factor(dB/m)
2. Correction Factor(dB/m) = Antenna Factor(dB/m) + Cable Factor(dB) – Pre-Amplifier Factor(dB)
3. The other emission levels were very low against the limit.
4. Margin value = Emission Level – Limit value

4.2 Conducted Emission Measurement

4.2.1 Limits of Conducted Emission Measurement

Frequency (MHz)	Conducted Limit (dBuV)	
	Quasi-peak	Average
0.15 - 0.5	66 - 56	56 - 46
0.50 - 5.0	56	46
5.0 - 30.0	60	50

Note: 1. The lower limit shall apply at the transition frequencies.
 2. The limit decreases in line with the logarithm of the frequency in the range of 0.15 to 0.50MHz.

4.2.2 Test Instruments

Description & Manufacturer	Model No.	Serial No.	Cal. Date	Cal. Due
Test Receiver ROHDE & SCHWARZ	ESCI	100613	Nov. 23, 2017	Nov. 22, 2018
RF signal cable (with 10dB PAD) Woken	5D-FB	Cable-cond1-01	Sep. 05, 2017	Sep. 04, 2018
LISN ROHDE & SCHWARZ (EUT)	ESH3-Z5	835239/001	Mar. 06, 2018	Mar. 05, 2019
LISN ROHDE & SCHWARZ (Peripheral)	ESH3-Z5	100311	Aug. 15, 2017	Aug. 14, 2018
Software ADT	BV ADT_Cond_ V7.3.7.3	NA	NA	NA

Note: 1. The calibration interval of the above test instruments is 12 months and the calibrations are traceable to NML/ROC and NIST/USA.
 2. The test was performed in HwaYa Shielded Room 1.
 3. The VCCI Site Registration No. is C-2040.

4.2.3 Test Procedures

- The EUT was placed 0.4 meters from the conducting wall of the shielded room with EUT being connected to the power mains through a line impedance stabilization network (LISN). Other support units were connected to the power mains through another LISN. The two LISNs provide 50 ohm/ 50uH of coupling impedance for the measuring instrument.
- Both lines of the power mains connected to the EUT were checked for maximum conducted interference.
- The frequency range from 150kHz to 30MHz was searched. Emission levels under (Limit - 20dB) was not recorded.

Note: The resolution bandwidth and video bandwidth of test receiver is 9kHz for quasi-peak detection (QP) and average detection (AV) at frequency 0.15MHz-30MHz.

4.2.4 Deviation from Test Standard

No deviation.

4.2.5 Test Setup

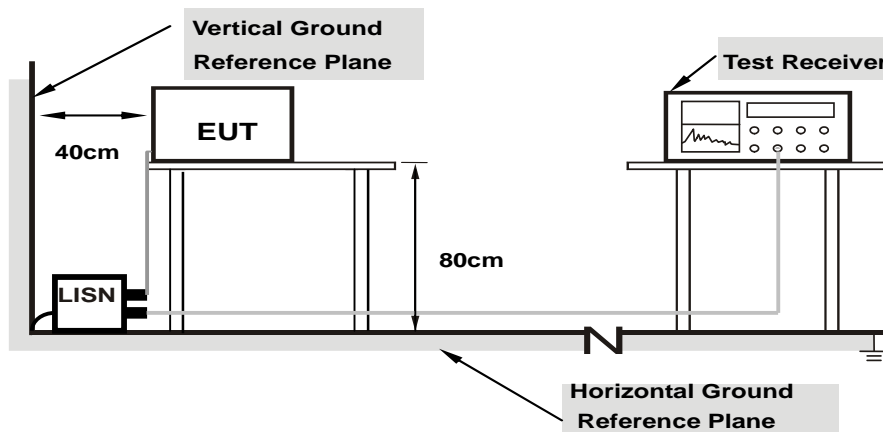

Note: 1.Support units were connected to second LISN.

For the actual test configuration, please refer to the attached file (Test Setup Photo).

4.2.6 EUT Operating Conditions

Same as 4.1.6.

4.2.7 Test Results

Worst-case data:

Radio 1

802.11b

Phase	Line (L)	Detector Function	Quasi-Peak (QP) / Average (AV)
Test Mode	A		

No	Freq. [MHz]	Corr. Factor (dB)	Reading Value		Emission Level		Limit		Margin	
			[dB (uV)]		[dB (uV)]		[dB (uV)]		(dB)	
			Q.P.	AV.	Q.P.	AV.	Q.P.	AV.	Q.P.	AV.
1	0.16579	10.16	36.79	22.63	46.95	32.79	65.17	55.17	-18.22	-22.38
2	0.19000	10.16	33.68	18.98	43.84	29.14	64.04	54.04	-20.20	-24.90
3	0.21000	10.16	31.85	16.14	42.01	26.30	63.21	53.21	-21.20	-26.91
4	0.36200	10.20	23.56	18.64	33.76	28.84	58.68	48.68	-24.92	-19.84
5	5.47400	10.42	7.19	2.31	17.61	12.73	60.00	50.00	-42.39	-37.27
6	14.11000	10.90	4.04	1.44	14.94	12.34	60.00	50.00	-45.06	-37.66

Remarks:

1. Q.P. and AV. are abbreviations of quasi-peak and average individually.
2. The emission levels of other frequencies were very low against the limit.
3. Margin value = Emission level - Limit value
4. Correction factor = Insertion loss + Cable loss
5. Emission Level = Correction Factor + Reading Value.

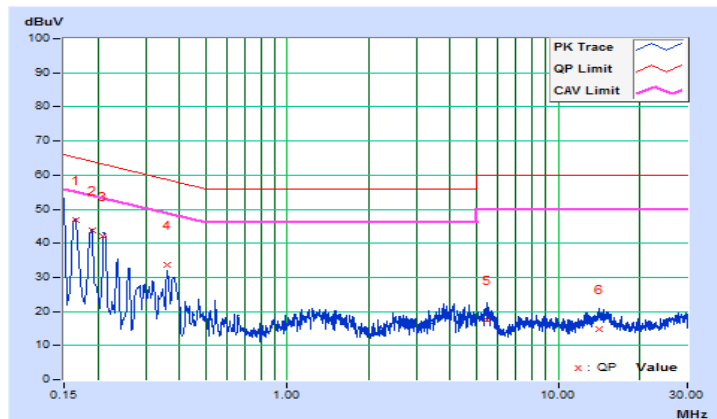

Phase	Neutral (N)	Detector Function	Quasi-Peak (QP) / Average (AV)
Test Mode	A		

No	Freq. [MHz]	Corr. Factor (dB)	Reading Value [dB (uV)]		Emission Level [dB (uV)]		Limit [dB (uV)]		Margin (dB)	
			Q.P.	AV.	Q.P.	AV.	Q.P.	AV.	Q.P.	AV.
			1	0.15400	10.15	39.39	24.87	49.54	35.02	65.78
2	0.18617	10.16	34.66	19.70	44.82	29.86	64.21	54.21	-19.39	-24.35
3	0.24164	10.17	26.59	11.08	36.76	21.25	62.04	52.04	-25.28	-30.79
4	0.29058	10.18	23.19	12.66	33.37	22.84	60.51	50.51	-27.14	-27.67
5	0.34200	10.19	17.69	6.85	27.88	17.04	59.15	49.15	-31.27	-32.11
6	0.43400	10.20	11.62	1.39	21.82	11.59	57.18	47.18	-35.36	-35.59

Remarks:

1. Q.P. and AV. are abbreviations of quasi-peak and average individually.
2. The emission levels of other frequencies were very low against the limit.
3. Margin value = Emission level - Limit value
4. Correction factor = Insertion loss + Cable loss
5. Emission Level = Correction Factor + Reading Value.

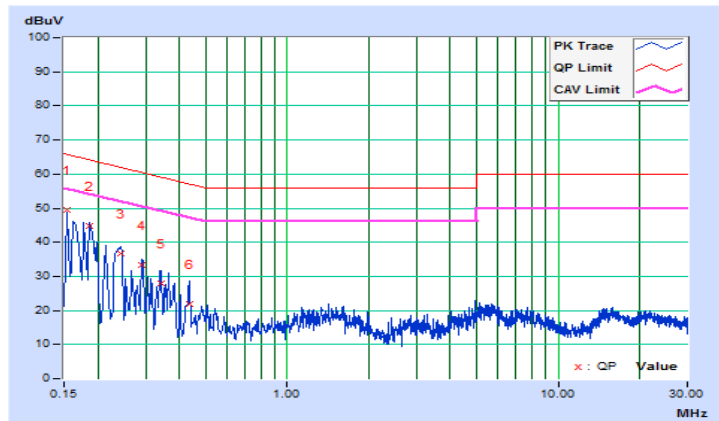

Phase	Line (L)	Detector Function	Quasi-Peak (QP) / Average (AV)
Test Mode	B		

No	Freq. [MHz]	Corr. Factor (dB)	Reading Value [dB (uV)]		Emission Level [dB (uV)]		Limit [dB (uV)]		Margin (dB)	
			Q.P.	AV.	Q.P.	AV.	Q.P.	AV.	Q.P.	AV.
			1	0.19418	10.10	37.97	27.50	48.07	37.60	63.86
2	0.26200	10.11	32.40	23.10	42.51	33.21	61.37	51.37	-18.86	-18.16
3	0.33325	10.11	33.38	25.72	43.49	35.83	59.37	49.37	-15.88	-13.54
4	0.46567	10.12	24.55	15.00	34.67	25.12	56.59	46.59	-21.92	-21.47
5	9.08600	10.57	16.50	8.97	27.07	19.54	60.00	50.00	-32.93	-30.46
6	18.65400	11.13	19.96	15.21	31.09	26.34	60.00	50.00	-28.91	-23.66

Remarks:

1. Q.P. and AV. are abbreviations of quasi-peak and average individually.
2. The emission levels of other frequencies were very low against the limit.
3. Margin value = Emission level - Limit value
4. Correction factor = Insertion loss + Cable loss
5. Emission Level = Correction Factor + Reading Value.

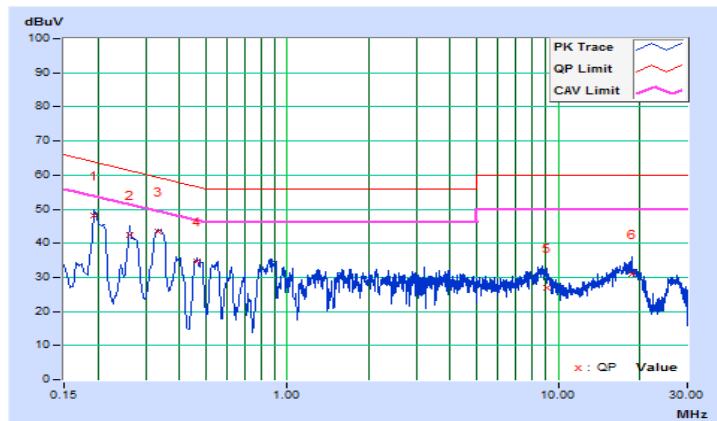

Phase	Neutral (N)	Detector Function	Quasi-Peak (QP) / Average (AV)
Test Mode	B		

No	Freq. [MHz]	Corr. Factor (dB)	Reading Value [dB (uV)]		Emission Level [dB (uV)]		Limit [dB (uV)]		Margin (dB)	
			Q.P.	AV.	Q.P.	AV.	Q.P.	AV.	Q.P.	AV.
			1	0.21000	10.10	34.76	24.49	44.86	34.59	63.21
2	0.26152	10.11	29.91	21.45	40.02	31.56	61.38	51.38	-21.36	-19.82
3	0.34486	10.11	32.04	22.49	42.15	32.60	59.09	49.09	-16.94	-16.49
4	0.47400	10.12	25.13	14.92	35.25	25.04	56.44	46.44	-21.19	-21.40
5	0.85357	10.13	24.44	11.94	34.57	22.07	56.00	46.00	-21.43	-23.93
6	17.69000	10.84	19.37	12.98	30.21	23.82	60.00	50.00	-29.79	-26.18

Remarks:

1. Q.P. and AV. are abbreviations of quasi-peak and average individually.
2. The emission levels of other frequencies were very low against the limit.
3. Margin value = Emission level - Limit value
4. Correction factor = Insertion loss + Cable loss
5. Emission Level = Correction Factor + Reading Value.

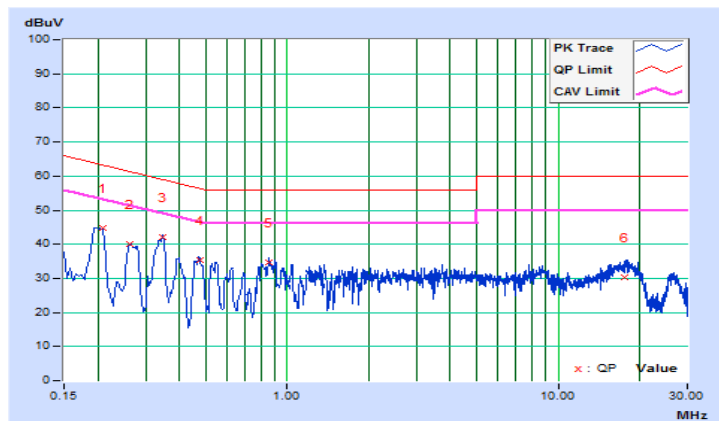

Radio 3

802.11b

Phase	Line (L)	Detector Function	Quasi-Peak (QP) / Average (AV)
Test Mode	A		

No	Freq. [MHz]	Corr. Factor (dB)	Reading Value		Emission Level		Limit		Margin	
			[dB (uV)]		[dB (uV)]		[dB (uV)]		(dB)	
			Q.P.	AV.	Q.P.	AV.	Q.P.	AV.	Q.P.	AV.
1	0.17000	10.16	37.82	21.39	47.98	31.55	64.96	54.96	-16.98	-23.41
2	0.19367	10.16	33.53	16.35	43.69	26.51	63.88	53.88	-20.19	-27.37
3	0.26569	10.17	24.20	13.67	34.37	23.84	61.25	51.25	-26.88	-27.41
4	0.35800	10.20	22.95	17.95	33.15	28.15	58.77	48.77	-25.62	-20.62
5	0.47800	10.20	8.65	1.23	18.85	11.43	56.37	46.37	-37.52	-34.94
6	1.39800	10.20	6.32	1.38	16.52	11.58	56.00	46.00	-39.48	-34.42

Remarks:

1. Q.P. and AV. are abbreviations of quasi-peak and average individually.
2. The emission levels of other frequencies were very low against the limit.
3. Margin value = Emission level - Limit value
4. Correction factor = Insertion loss + Cable loss
5. Emission Level = Correction Factor + Reading Value.

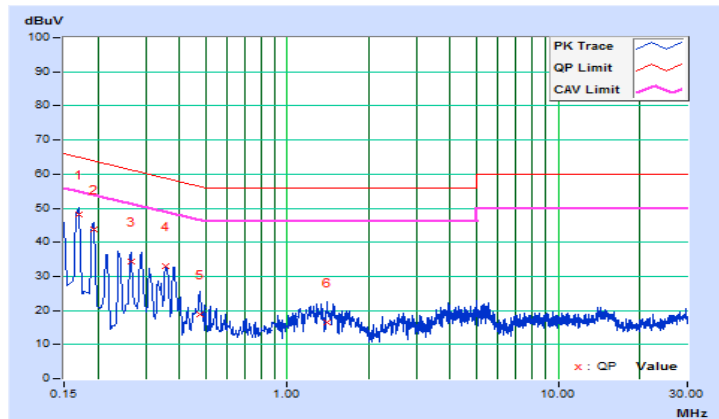

Phase	Neutral (N)	Detector Function	Quasi-Peak (QP) / Average (AV)
Test Mode	A		

No	Freq. [MHz]	Corr. Factor (dB)	Reading Value [dB (uV)]		Emission Level [dB (uV)]		Limit [dB (uV)]		Margin (dB)	
			Q.P.	AV.	Q.P.	AV.	Q.P.	AV.	Q.P.	AV.
			1	0.16977	10.15	38.09	21.14	48.24	31.29	64.97
2	0.18600	10.16	33.53	19.01	43.69	29.17	64.21	54.21	-20.52	-25.04
3	0.28602	10.18	21.91	9.55	32.09	19.73	60.64	50.64	-28.55	-30.91
4	1.35800	10.21	6.46	1.67	16.67	11.88	56.00	46.00	-39.33	-34.12
5	5.29000	10.39	8.27	1.54	18.66	11.93	60.00	50.00	-41.34	-38.07
6	14.81000	10.79	5.17	1.31	15.96	12.10	60.00	50.00	-44.04	-37.90

Remarks:

1. Q.P. and AV. are abbreviations of quasi-peak and average individually.
2. The emission levels of other frequencies were very low against the limit.
3. Margin value = Emission level - Limit value
4. Correction factor = Insertion loss + Cable loss
5. Emission Level = Correction Factor + Reading Value.

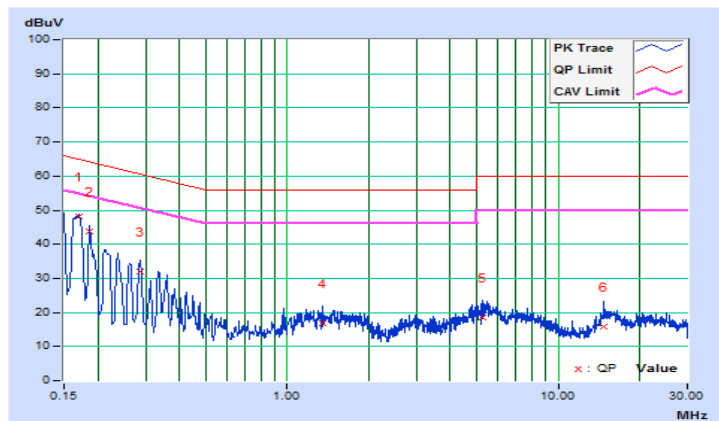

Phase	Line (L)	Detector Function	Quasi-Peak (QP) / Average (AV)
Test Mode	B		

No	Freq. [MHz]	Corr. Factor (dB)	Reading Value [dB (uV)]		Emission Level [dB (uV)]		Limit [dB (uV)]		Margin (dB)	
			Q.P.	AV.	Q.P.	AV.	Q.P.	AV.	Q.P.	AV.
			1	0.20600	10.10	36.81	29.86	46.91	39.96	63.37
2	0.26221	10.11	31.63	23.24	41.74	33.35	61.36	51.36	-19.62	-18.01
3	0.33237	10.11	33.44	25.77	43.55	35.88	59.39	49.39	-15.84	-13.51
4	0.87000	10.14	24.20	11.50	34.34	21.64	56.00	46.00	-21.66	-24.36
5	8.39800	10.53	17.28	9.26	27.81	19.79	60.00	50.00	-32.19	-30.21
6	18.26200	11.11	17.44	11.76	28.55	22.87	60.00	50.00	-31.45	-27.13

Remarks:

1. Q.P. and AV. are abbreviations of quasi-peak and average individually.
2. The emission levels of other frequencies were very low against the limit.
3. Margin value = Emission level - Limit value
4. Correction factor = Insertion loss + Cable loss
5. Emission Level = Correction Factor + Reading Value.

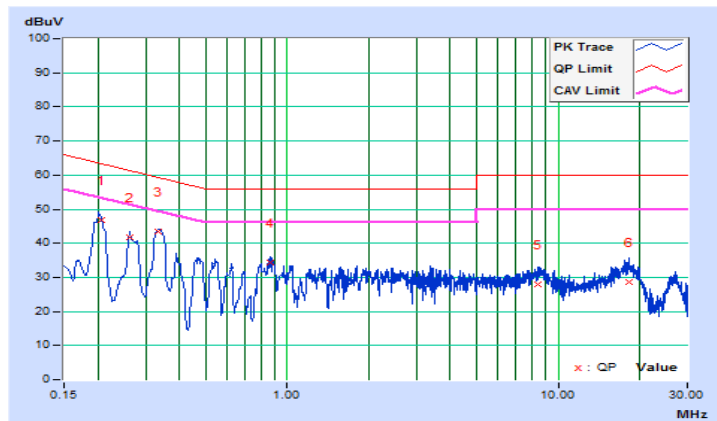

Phase	Neutral (N)	Detector Function	Quasi-Peak (QP) / Average (AV)
Test Mode	B		

No	Freq. [MHz]	Corr. Factor (dB)	Reading Value [dB (uV)]		Emission Level [dB (uV)]		Limit [dB (uV)]		Margin (dB)	
			Q.P.	AV.	Q.P.	AV.	Q.P.	AV.	Q.P.	AV.
			1	0.19800	10.10	35.97	29.64	46.07	39.74	63.69
2	0.26221	10.11	29.48	21.74	39.59	31.85	61.36	51.36	-21.77	-19.51
3	0.33000	10.11	31.23	22.50	41.34	32.61	59.45	49.45	-18.11	-16.84
4	0.85357	10.13	24.86	12.44	34.99	22.57	56.00	46.00	-21.01	-23.43
5	17.11400	10.82	18.44	11.94	29.26	22.76	60.00	50.00	-30.74	-27.24
6	26.37400	11.03	15.34	9.32	26.37	20.35	60.00	50.00	-33.63	-29.65

Remarks:

1. Q.P. and AV. are abbreviations of quasi-peak and average individually.
2. The emission levels of other frequencies were very low against the limit.
3. Margin value = Emission level - Limit value
4. Correction factor = Insertion loss + Cable loss
5. Emission Level = Correction Factor + Reading Value.

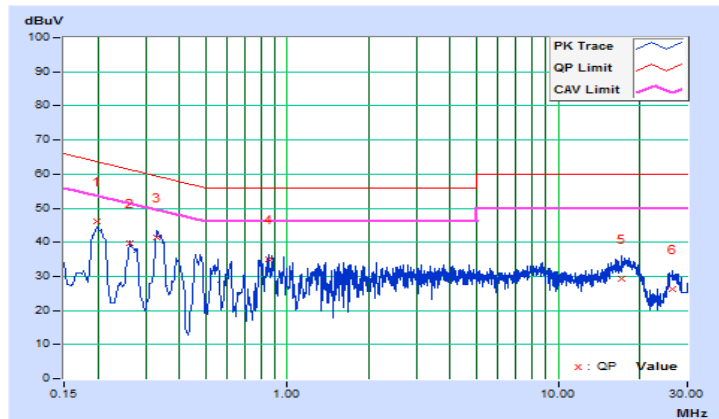

4.3 6dB Bandwidth Measurement

4.3.1 Limits of 6dB Bandwidth Measurement

The minimum of 6dB Bandwidth Measurement is 0.5 MHz.

4.3.2 Test Setup

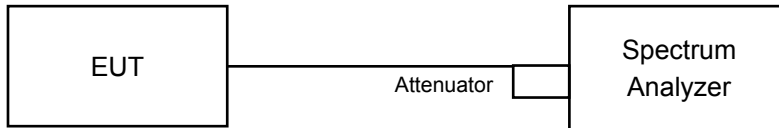

4.3.3 Test Instruments

Refer to section 4.1.2 to get information of above instrument.

4.3.4 Test Procedure

- Set resolution bandwidth (RBW) = 100kHz.
- Set the video bandwidth (VBW) $\geq 3 \times$ RBW, Detector = peak.
- Trace mode = max hold.
- Sweep = auto couple.
- Measure the maximum width of the emission that is constrained by the frequencies associated with the two amplitude points (upper and lower) that are attenuated by 6 dB relative to the maximum level measured in the fundamental emission.

4.3.5 Deviation from Test Standard

No deviation.

4.3.6 EUT Operating Conditions

The software provided by client to enable the EUT under transmission condition continuously at lowest, middle and highest channel frequencies individually.

4.3.7 Test Result

Radio 1

802.11b

Channel	Frequency (MHz)	6dB Bandwidth (MHz)		Minimum Limit (MHz)	Pass / Fail
		Chain 0	Chain 1		
1	2412	8.12	8.11	0.5	Pass
6	2437	8.12	8.12	0.5	Pass
11	2462	8.12	10.08	0.5	Pass

802.11g

Channel	Frequency (MHz)	6dB Bandwidth (MHz)		Minimum Limit (MHz)	Pass / Fail
		Chain 0	Chain 1		
1	2412	16.41	16.42	0.5	Pass
6	2437	16.36	16.36	0.5	Pass
11	2462	16.37	16.39	0.5	Pass

802.11n (HT20)

Channel	Frequency (MHz)	6dB Bandwidth (MHz)		Minimum Limit (MHz)	Pass / Fail
		Chain 0	Chain 1		
1	2412	17.60	17.63	0.5	Pass
6	2437	17.58	16.99	0.5	Pass
11	2462	17.58	17.36	0.5	Pass

802.11n (HT40)

Channel	Frequency (MHz)	6dB Bandwidth (MHz)		Minimum Limit (MHz)	Pass / Fail
		Chain 0	Chain 1		
3	2422	35.33	35.31	0.5	Pass
6	2437	35.26	35.16	0.5	Pass
9	2452	35.38	35.19	0.5	Pass

Spectrum Plot of Worst Value

802.11b

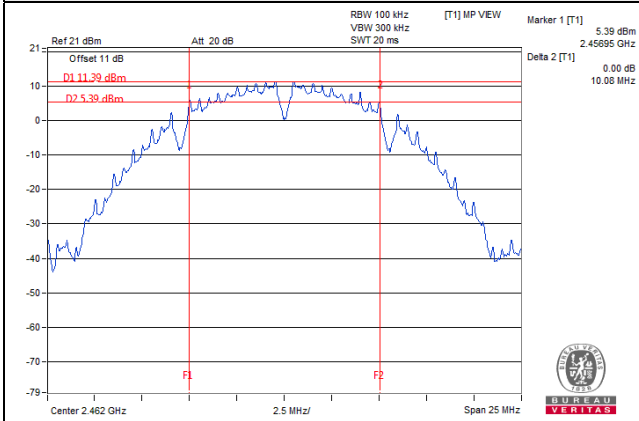

802.11g

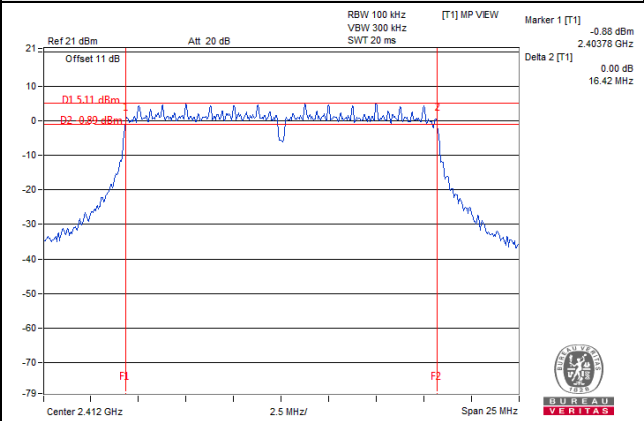

802.11n (HT20)

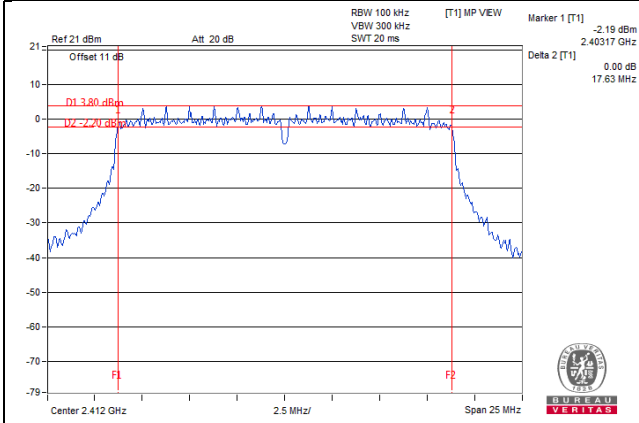

802.11n (HT40)

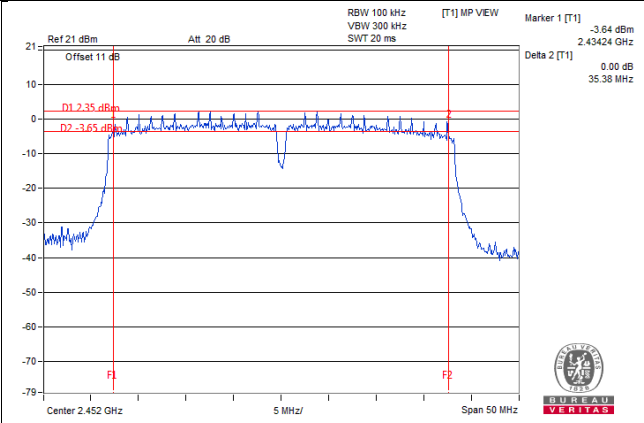

Radio 3

802.11b

Channel	Frequency (MHz)	6dB Bandwidth (MHz)	Minimum Limit (MHz)	Pass / Fail
1	2412	6.14	0.5	Pass
6	2437	7.12	0.5	Pass
11	2462	6.16	0.5	Pass

802.11g

Channel	Frequency (MHz)	6dB Bandwidth (MHz)	Minimum Limit (MHz)	Pass / Fail
1	2412	16.09	0.5	Pass
6	2437	16.36	0.5	Pass
11	2462	16.32	0.5	Pass

802.11n (HT20)

Channel	Frequency (MHz)	6dB Bandwidth (MHz)	Minimum Limit (MHz)	Pass / Fail
1	2412	16.86	0.5	Pass
6	2437	17.23	0.5	Pass
11	2462	16.88	0.5	Pass

Spectrum Plot of Worst Value

802.11b

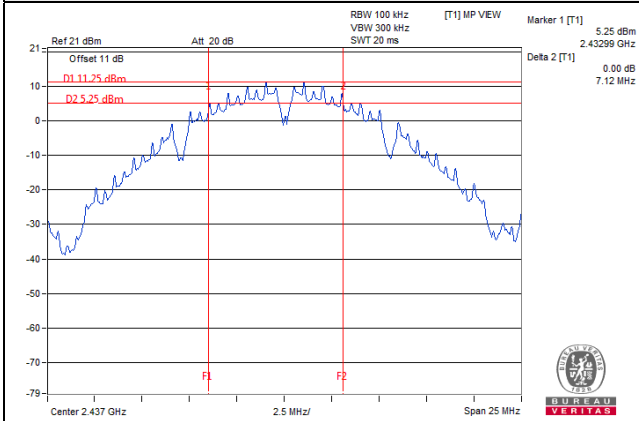

802.11g

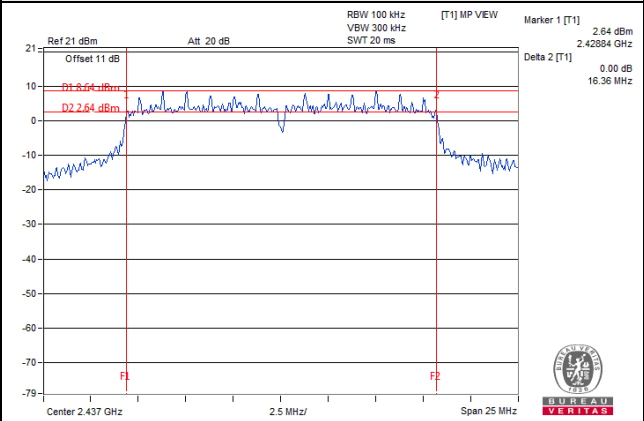

802.11n (HT20)

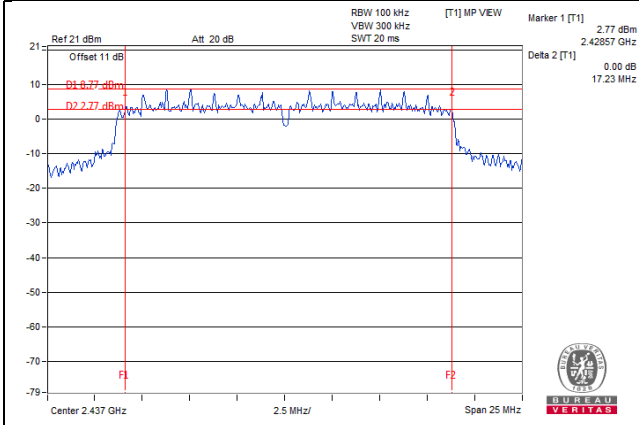

4.4 Conducted Output Power Measurement

4.4.1 Limits of Conducted Output Power Measurement

For systems using digital modulation in the 2400–2483.5 MHz bands: 1 Watt (30dBm)

Per KDB 662911 D01 Multiple Transmitter Output Method of conducted output power measurement on IEEE 802.11 devices,

Array Gain = 0 dB (i.e., no array gain) for $N_{ANT} \leq 4$;

Array Gain = 0 dB (i.e., no array gain) for channel widths ≥ 40 MHz for any N_{ANT} ;

Array Gain = $5 \log(N_{ANT}/N_{SS})$ dB or 3 dB, whichever is less for 20-MHz channel widths with $N_{ANT} \geq 5$.

For power measurements on all other devices: Array Gain = $10 \log(N_{ANT}/N_{SS})$ dB.

4.4.2 Test Setup

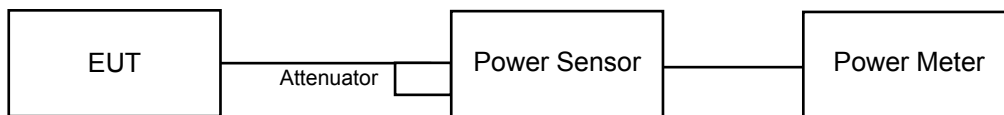

4.4.3 Test Instruments

Refer to section 4.1.2 to get information of above instrument.

4.4.4 Test Procedures

Average power sensor was used to perform output power measurement, trigger and gating function of wide band power meter is enabled to measure max output power of TX on burst. Duty factor is not added to measured value.

4.4.5 Deviation from Test Standard

No deviation.

4.4.6 EUT Operating Conditions

Same as item 4.3.6.

4.4.7 Test Results

Radio 1, CDD Mode

802.11b

Channel	Frequency (MHz)	Average Power (dBm)		Total Power (mW)	Total Power (dBm)	Limit (dBm)	Pass / Fail
		Chain 0	Chain 1				
1	2412	22.24	21.92	323.091	25.09	30.00	Pass
6	2437	23.07	22.98	401.377	26.04	30.00	Pass
11	2462	21.48	21.38	278.009	24.44	30.00	Pass

802.11g

Channel	Frequency (MHz)	Average Power (dBm)		Total Power (mW)	Total Power (dBm)	Limit (dBm)	Pass / Fail
		Chain 0	Chain 1				
1	2412	17.07	16.93	100.250	20.01	30.00	Pass
6	2437	23.23	22.72	397.446	25.99	30.00	Pass
11	2462	17.33	17.25	107.163	20.30	30.00	Pass

802.11n (HT20)

Channel	Frequency (MHz)	Average Power (dBm)		Total Power (mW)	Total Power (dBm)	Limit (dBm)	Pass / Fail
		Chain 0	Chain 1				
1	2412	15.99	15.94	78.983	18.98	30.00	Pass
6	2437	22.41	22.28	343.225	25.36	30.00	Pass
11	2462	16.82	16.78	95.727	19.81	30.00	Pass

802.11n (HT40)

Channel	Frequency (MHz)	Average Power (dBm)		Total Power (mW)	Total Power (dBm)	Limit (dBm)	Pass / Fail
		Chain 0	Chain 1				
3	2422	13.74	13.57	46.410	16.67	30.00	Pass
6	2437	17.35	17.24	107.291	20.31	30.00	Pass
9	2452	16.72	16.57	92.383	19.66	30.00	Pass

Radio 1, Beamforming Mode

802.11n (HT20)

Channel	Frequency (MHz)	Average Power (dBm)		Total Power (mW)	Total Power (dBm)	Limit (dBm)	Pass / Fail
		Chain 0	Chain 1				
1	2412	12.98	12.93	39.495	15.97	28.41	Pass
6	2437	19.40	19.27	171.624	22.35	28.41	Pass
11	2462	13.81	13.77	47.867	16.80	28.41	Pass

Note: Beamforming gain = $4.58\text{dBi} + 10\log(2) = 7.59\text{dBi} > 6\text{dBi}$, so the power limit shall be reduced to $30 - (7.59 - 6) = 28.41\text{dBm}$.

802.11n (HT40)

Channel	Frequency (MHz)	Average Power (dBm)		Total Power (mW)	Total Power (dBm)	Limit (dBm)	Pass / Fail
		Chain 0	Chain 1				
3	2422	10.73	10.56	23.206	13.66	28.41	Pass
6	2437	14.34	14.23	53.649	17.30	28.41	Pass
9	2452	13.71	13.56	46.195	16.65	28.41	Pass

Note: Beamforming gain = $4.58\text{dBi} + 10\log(2) = 7.59\text{dBi} > 6\text{dBi}$, so the power limit shall be reduced to $30 - (7.59 - 6) = 28.41\text{dBm}$.

Radio 3

802.11b

Channel	Frequency (MHz)	Average Power (mW)	Average Power (dBm)	Limit (dBm)	Pass / Fail
1	2412	17.620	12.46	30.00	Pass
6	2437	96.383	19.84	30.00	Pass
11	2462	34.119	15.33	30.00	Pass

802.11g

Channel	Frequency (MHz)	Average Power (mW)	Average Power (dBm)	Limit (dBm)	Pass / Fail
1	2412	23.823	13.77	30.00	Pass
6	2437	92.897	19.68	30.00	Pass
11	2462	24.099	13.82	30.00	Pass

802.11n (HT20)

Channel	Frequency (MHz)	Average Power (mW)	Average Power (dBm)	Limit (dBm)	Pass / Fail
1	2412	23.388	13.69	30.00	Pass
6	2437	90.573	19.57	30.00	Pass
11	2462	20.797	13.18	30.00	Pass

4.5 Power Spectral Density Measurement

4.5.1 Limits of Power Spectral Density Measurement

The Maximum of Power Spectral Density Measurement is 8dBm.

4.5.2 Test Setup

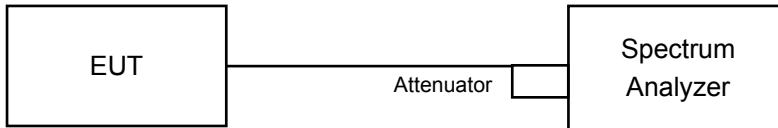

4.5.3 Test Instruments

Refer to section 4.1.2 to get information of above instrument.

4.5.4 Test Procedure

For Average Power (Duty cycle $\geq 98\%$)

- Set instrument center frequency to DTS channel center frequency.
- Set span to at least 1.5 times the OBW.
- Set RBW to: $3 \text{ kHz} \leq \text{RBW} \leq 100 \text{ kHz}$.
- Set VBW $\geq 3 \times \text{RBW}$.
- Detector = power averaging (RMS) or sample detector (when RMS not available).
- Ensure that the number of measurement points in the sweep $\geq 2 \times \text{span}/\text{RBW}$.
- Sweep time = auto couple.
- Employ trace averaging (RMS) mode over a minimum of 100 traces.
- Use the peak marker function to determine the maximum amplitude level.

For Average Power (Duty cycle $< 98\%$)

- Measure the duty cycle (x).
- Set instrument center frequency to DTS channel center frequency.
- Set span to at least 1.5 times the OBW.
- Set RBW to: $3 \text{ kHz} \leq \text{RBW} \leq 100 \text{ kHz}$.
- Set VBW $\geq 3 \times \text{RBW}$.
- Detector = power averaging (RMS) or sample detector (when RMS not available).
- Ensure that the number of measurement points in the sweep $\geq 2 \times \text{span}/\text{RBW}$.
- Sweep time = auto couple.
- Do not use sweep triggering. Allow sweep to "free run".
- Employ trace averaging (RMS) mode over a minimum of 100 traces.
- Use the peak marker function to determine the maximum amplitude level.
- Add $10 \log (1/x)$, where x is the duty cycle measured in step (a), to the measured PSD to compute the average PSD during the actual transmission time.

4.5.5 Deviation from Test Standard

No deviation.

4.5.6 EUT Operating Condition

Same as item 4.3.6

4.5.7 Test Results

Radio 1

802.11b

TX chain	Channel	Frequency (MHz)	PSD (dBm/10kHz)	10 log (N=2) dB	Total PSD (dBm/10kHz)	Limit (dBm/3kHz)	Pass / Fail
0	1	2412	-5.27	3.01	-2.26	6.41	Pass
	6	2437	-4.46	3.01	-1.45	6.41	Pass
	11	2462	-5.90	3.01	-2.89	6.41	Pass
1	1	2412	-5.81	3.01	-2.80	6.41	Pass
	6	2437	-4.51	3.01	-1.50	6.41	Pass
	11	2462	-6.15	3.01	-3.14	6.41	Pass

Note:

- Method 1 of power density measurement of KDB 662911 is using for calculating total power density. Total power density is summing entire spectra across corresponding frequency bins on the various outputs by computer.
- Directional gain = $4.58\text{dBi} + 10\log(2) = 7.59\text{dBi} > 6\text{dBi}$, so the power density limit shall be reduced to $8 - (7.59 - 6) = 6.41\text{dBm}$.

802.11g

TX chain	Channel	Frequency (MHz)	PSD w/o Duty Factor (dBm/10kHz)	10 log (N=2) dB	Duty Factor (dB)	Total PSD With Duty Factor (dBm/10kHz)	Limit (dBm/3kHz)	Pass / Fail
0	1	2412	-13.98	3.01	0.19	-10.78	6.41	Pass
	6	2437	-7.89	3.01	0.19	-4.69	6.41	Pass
	11	2462	-13.79	3.01	0.19	-10.59	6.41	Pass
1	1	2412	-14.06	3.01	0.19	-10.86	6.41	Pass
	6	2437	-8.12	3.01	0.19	-4.92	6.41	Pass
	11	2462	-13.51	3.01	0.19	-10.31	6.41	Pass

Note:

- Method 1 of power density measurement of KDB 662911 is using for calculating total power density. Total power density is summing entire spectra across corresponding frequency bins on the various outputs by computer.
- Directional gain = $4.58\text{dBi} + 10\log(2) = 7.59\text{dBi} > 6\text{dBi}$, so the power density limit shall be reduced to $8 - (7.59 - 6) = 6.41\text{dBm}$.
- Refer to section 3.3 for duty cycle spectrum plot.

802.11n (HT20)

TX chain	Channel	Frequency (MHz)	PSD w/o Duty Factor (dBm/10kHz)	10 log (N=2) dB	Duty Factor (dB)	Total PSD With Duty Factor (dBm/10kHz)	Limit (dBm/3kHz)	Pass / Fail
0	1	2412	-14.48	3.01	0.10	-11.37	6.41	Pass
	6	2437	-8.34	3.01	0.10	-5.23	6.41	Pass
	11	2462	-13.31	3.01	0.10	-10.20	6.41	Pass
1	1	2412	-14.13	3.01	0.10	-11.02	6.41	Pass
	6	2437	-8.26	3.01	0.10	-5.15	6.41	Pass
	11	2462	-13.63	3.01	0.10	-10.52	6.41	Pass

Note:

- Method 1 of power density measurement of KDB 662911 is using for calculating total power density. Total power density is summing entire spectra across corresponding frequency bins on the various outputs by computer.
- Directional gain = $4.58\text{dBi} + 10\log(2) = 7.59\text{dBi} > 6\text{dBi}$, so the power density limit shall be reduced to $8 - (7.59 - 6) = 6.41\text{dBm}$.
- Refer to section 3.3 for duty cycle spectrum plot.

802.11n (HT40)

TX chain	Channel	Frequency (MHz)	PSD w/o Duty Factor (dBm/10kHz)	10 log (N=2) dB	Duty Factor (dB)	Total PSD With Duty Factor (dBm/10kHz)	Limit (dBm/3kHz)	Pass / Fail
0	3	2422	-19.97	3.01	0.15	-16.81	6.41	Pass
	6	2437	-16.17	3.01	0.15	-13.01	6.41	Pass
	9	2452	-17.18	3.01	0.15	-14.02	6.41	Pass
1	3	2422	-20.14	3.01	0.15	-16.98	6.41	Pass
	6	2437	-16.60	3.01	0.15	-13.44	6.41	Pass
	9	2452	-16.71	3.01	0.15	-13.55	6.41	Pass

Note:

- Method 1 of power density measurement of KDB 662911 is using for calculating total power density. Total power density is summing entire spectra across corresponding frequency bins on the various outputs by computer.
- Directional gain = $4.58\text{dBi} + 10\log(2) = 7.59\text{dBi} > 6\text{dBi}$, so the power density limit shall be reduced to $8 - (7.59 - 6) = 6.41\text{dBm}$.
- Refer to section 3.3 for duty cycle spectrum plot.

Spectrum Plot of Worst Value

802.11b

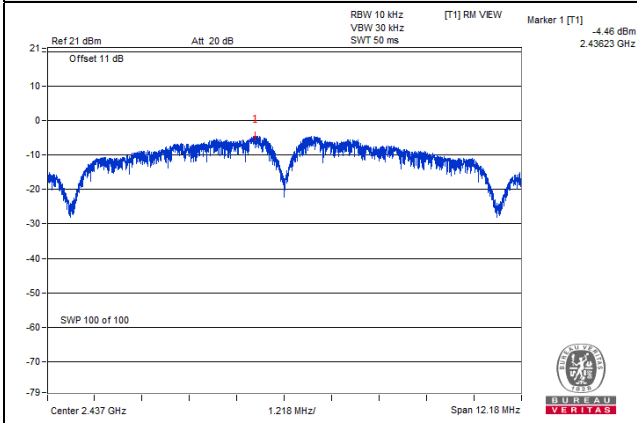

802.11g

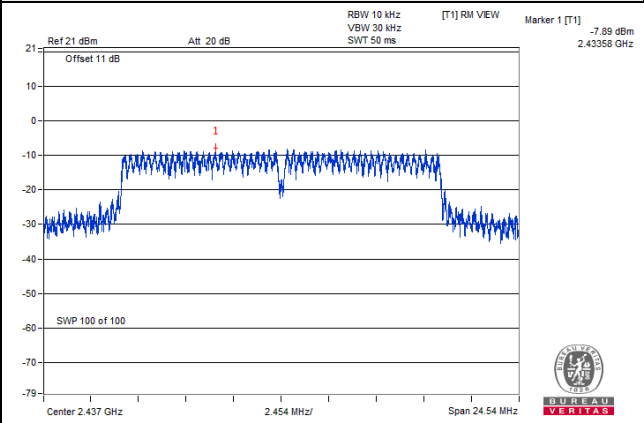

802.11n (HT20)

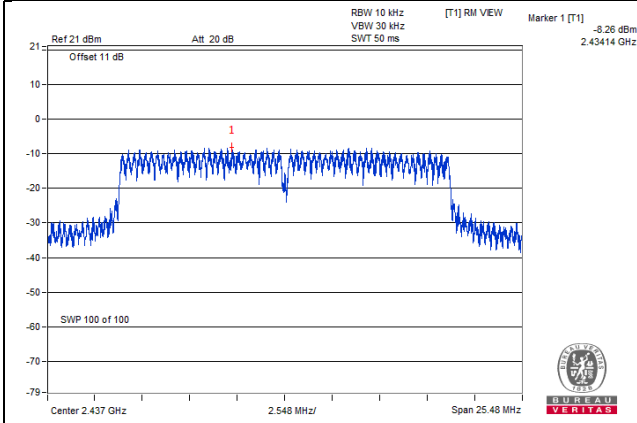

802.11n (HT40)

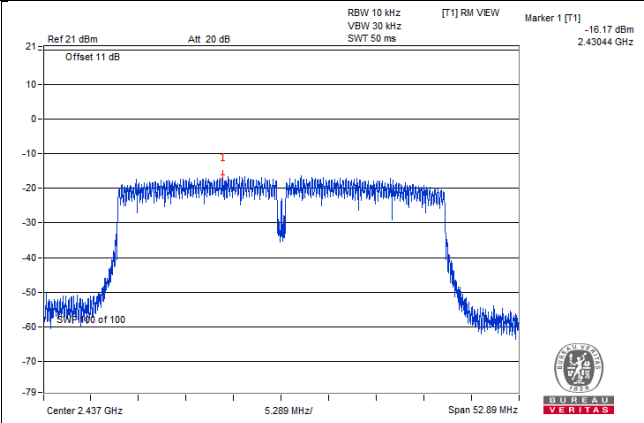

Radio 3

802.11b

Channel	Frequency (MHz)	PSD (dBm/10kHz)	Limit (dBm/3kHz)	Pass / Fail
1	2412	-14.80	8.00	Pass
6	2437	-8.35	8.00	Pass
11	2462	-12.14	8.00	Pass

802.11g

Channel	Frequency (MHz)	PSD w/o Duty Factor (dBm/10kHz)	Duty Factor (dB)	Total PSD With Duty Factor (dBm/10kHz)	Limit (dBm/3kHz)	Pass / Fail
1	2412	-17.21	0.23	-16.98	8.00	Pass
6	2437	-11.60	0.23	-11.37	8.00	Pass
11	2462	-17.22	0.23	-16.99	8.00	Pass

Note: Refer to section 3.3 for duty cycle spectrum plot.

802.11n (HT20)

Channel	Frequency (MHz)	PSD w/o Duty Factor (dBm/10kHz)	Duty Factor (dB)	Total PSD With Duty Factor (dBm/10kHz)	Limit (dBm/3kHz)	Pass / Fail
1	2412	-17.41	0.23	-17.18	8.00	Pass
6	2437	-11.54	0.23	-11.31	8.00	Pass
11	2462	-18.04	0.23	-17.81	8.00	Pass

Note: Refer to section 3.3 for duty cycle spectrum plot.

Spectrum Plot of Worst Value

802.11b

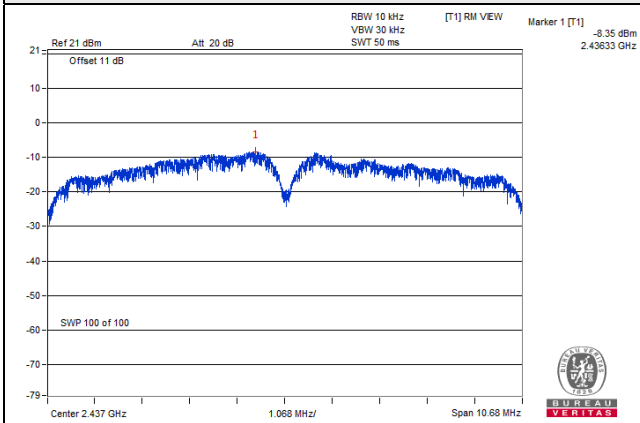

802.11g

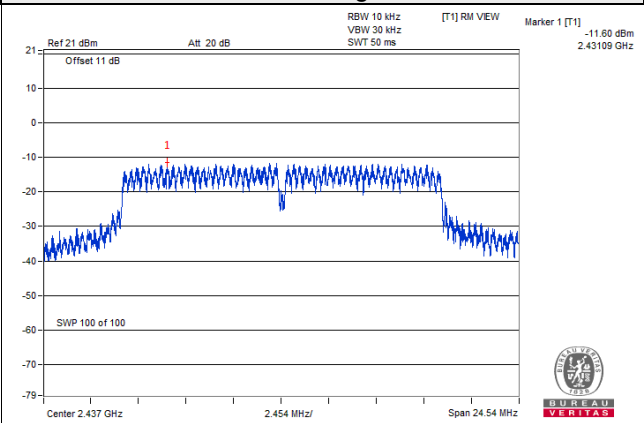

802.11n (HT20)

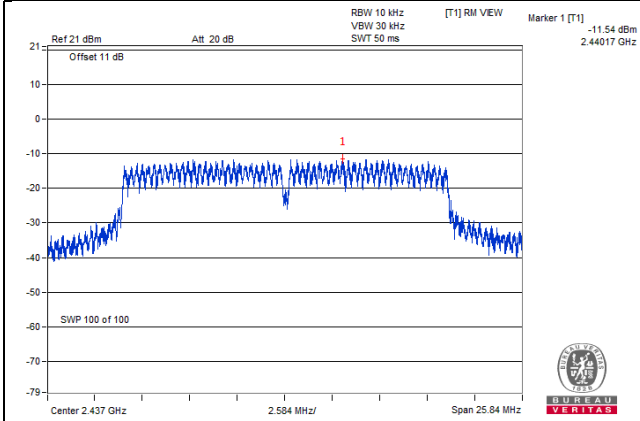

4.6 Conducted Out of Band Emission Measurement

4.6.1 Limits of Conducted Out of Band Emission Measurement

Below -30dB of the highest emission level of operating band (in 100kHz Resolution Bandwidth).

4.6.2 Test Setup

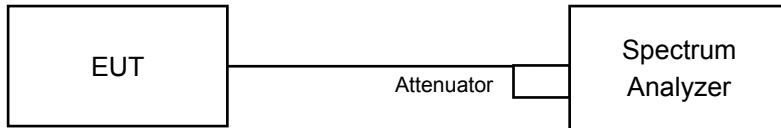

4.6.3 Test Instruments

Refer to section 4.1.2 to get information of above instrument.

4.6.4 Test Procedure

MEASUREMENT PROCEDURE REF

- Set the RBW = 100 kHz.
- Set the VBW \geq 300 kHz.
- Detector = average.
- Sweep time = auto couple.
- Trace mode = max hold.
- Allow trace to fully stabilize.
- Use the peak marker function to determine the maximum power level in any 100 kHz band segment within the fundamental EBW.

MEASUREMENT PROCEDURE OOB

- Set RBW = 100 kHz.
- Set VBW \geq 300 kHz.
- Detector = average.
- Sweep = auto couple.
- Trace Mode = max hold.
- Allow trace to fully stabilize.
- Use the peak marker function to determine the maximum amplitude level.

4.6.5 Deviation from Test Standard

No deviation.

4.6.6 EUT Operating Condition

Same as item 4.3.6

4.6.7 Test Results

The conducted emission test is performed on each TX port of operating mode without summing or adding 10log (N) since the limit is relative emission limit.

The spectrum plots are attached on the following pages. D1 line indicates the highest level, and D2 line indicates the 30dB offset below D1. It shows compliance with the requirement.

Radio 1
802.11b_Chain 0

CH 1

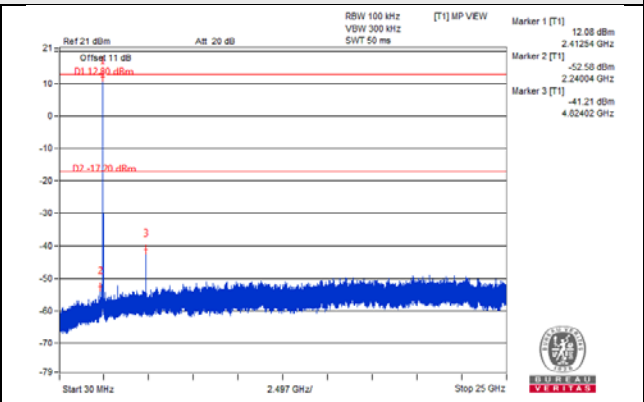
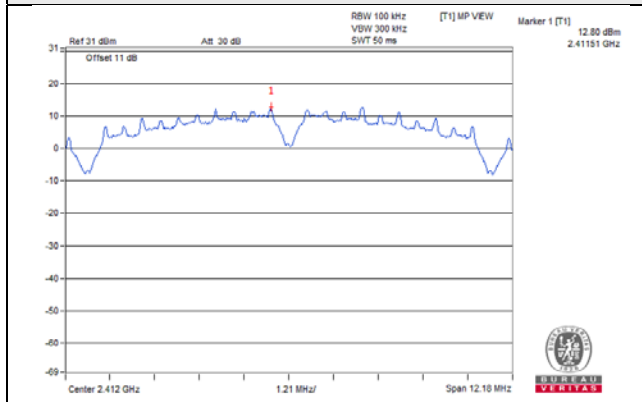

CH 6

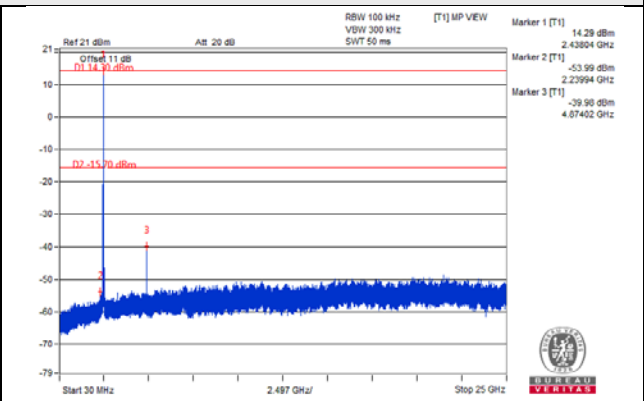
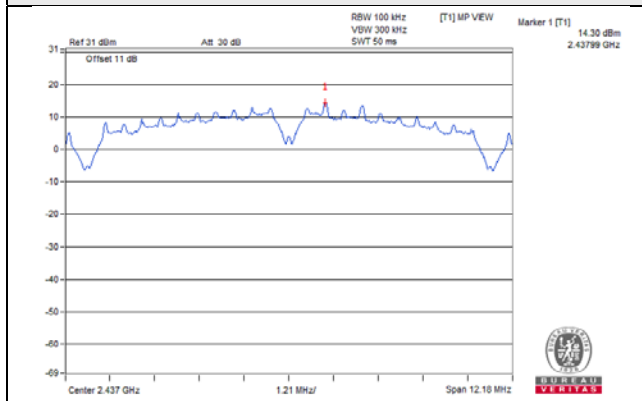

CH 11

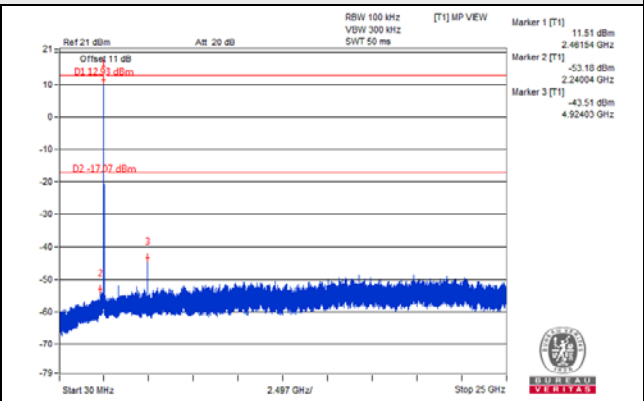
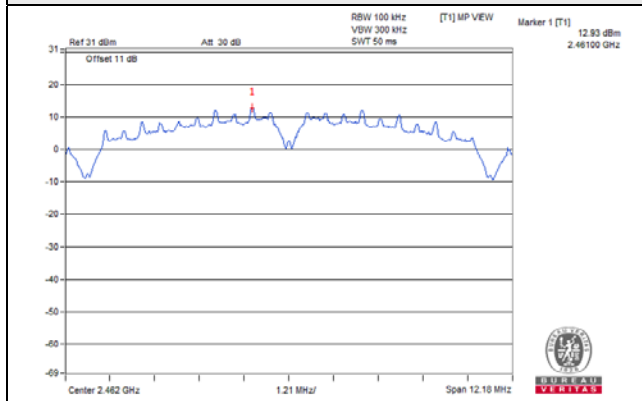

CH 1 Band edge

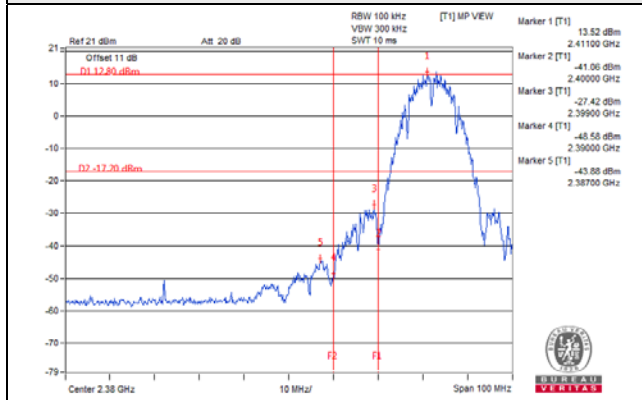

CH 11 Band edge

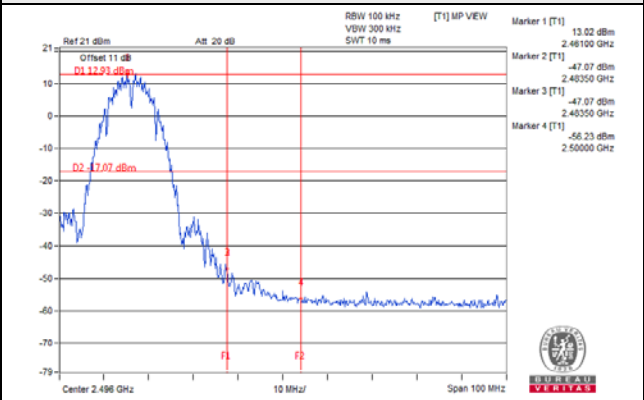

802.11b_Chain 1

CH 1

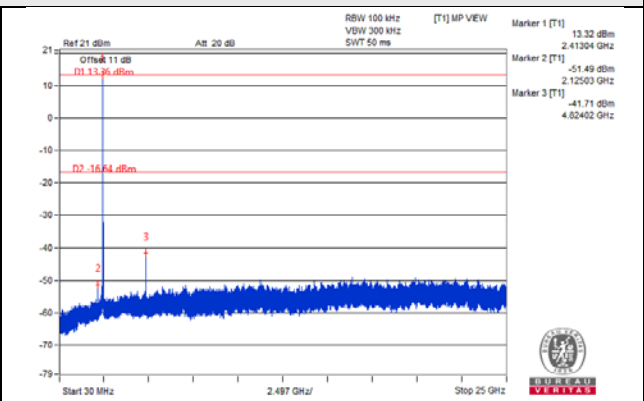
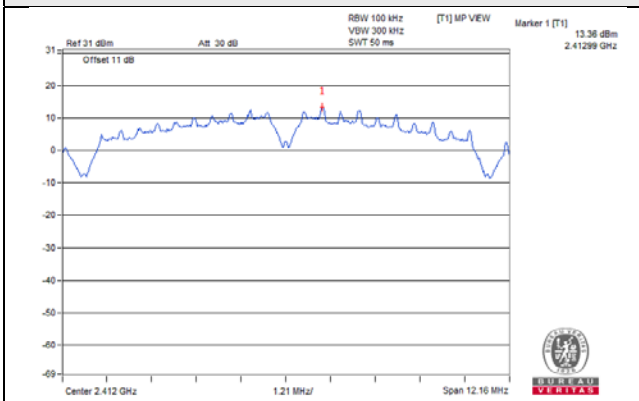

CH 6

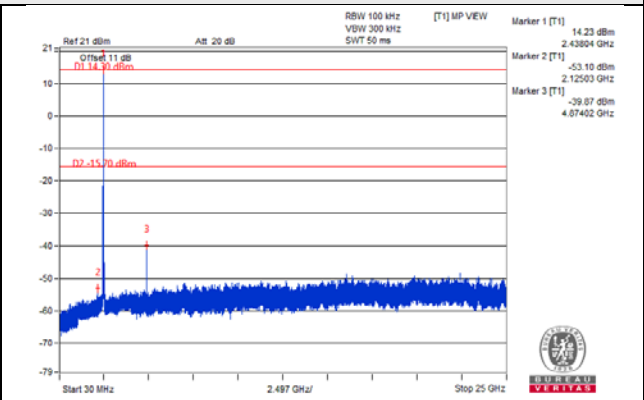
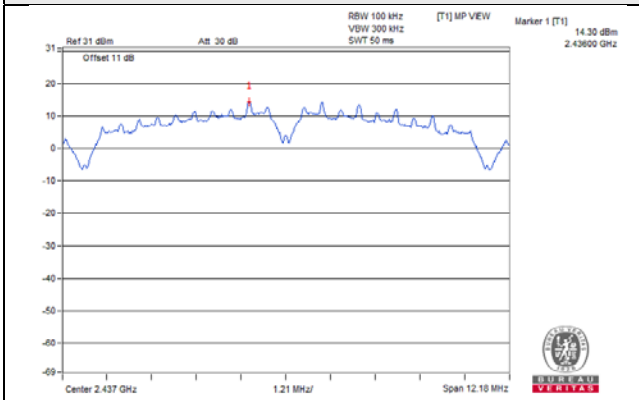

CH 11

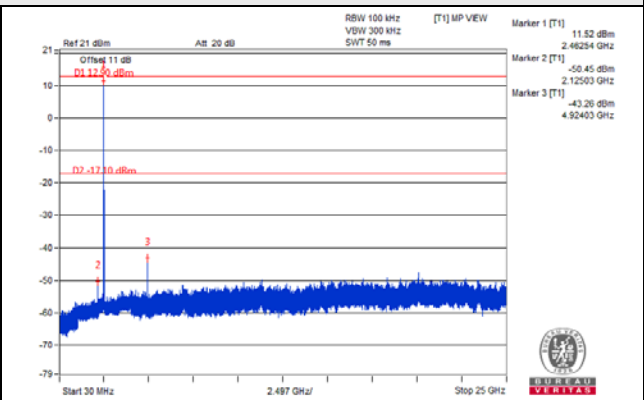
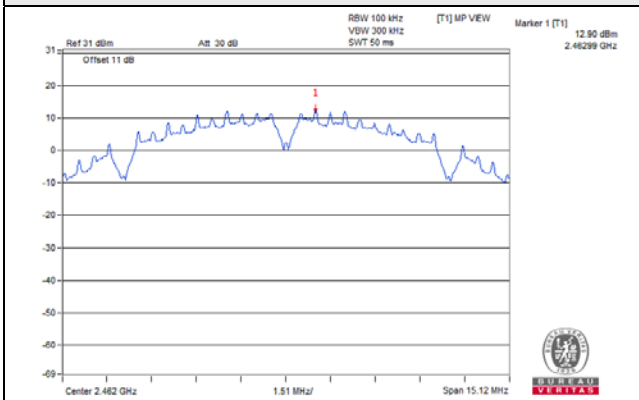

CH 1 Band edge

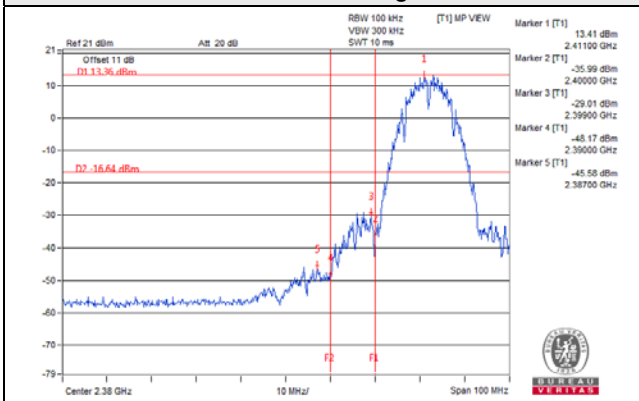

CH 11 Band edge

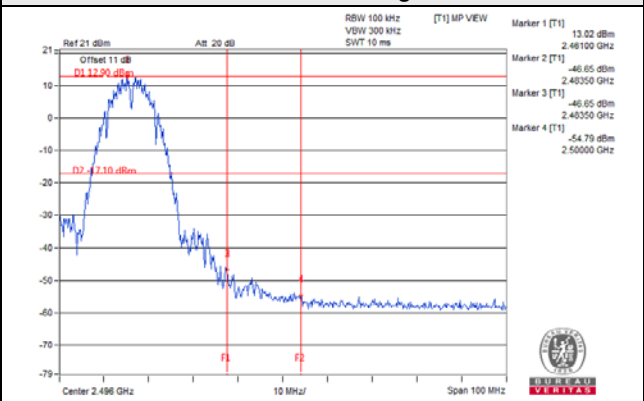

802.11g_Chain 0

CH 1

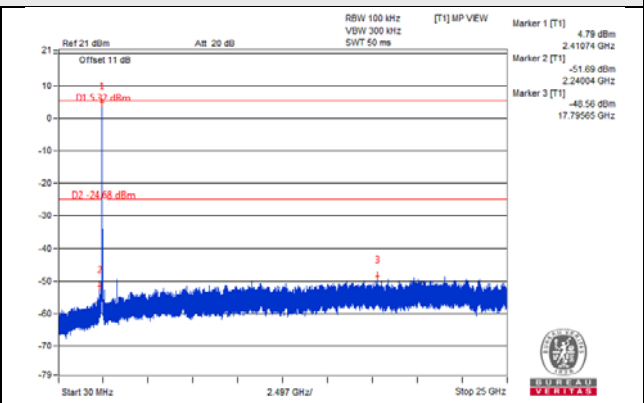
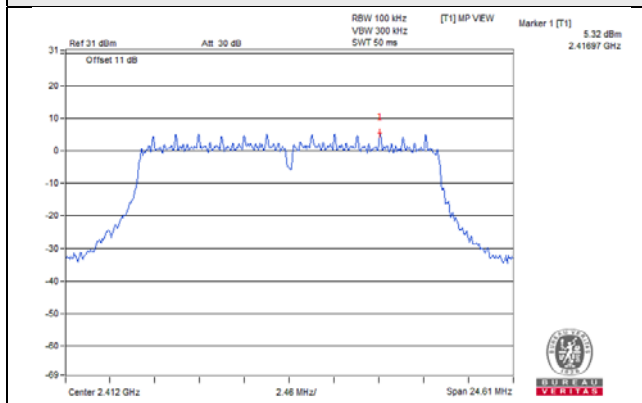

CH 6

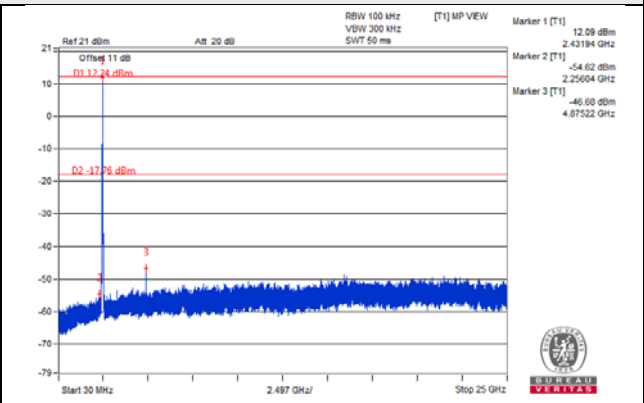
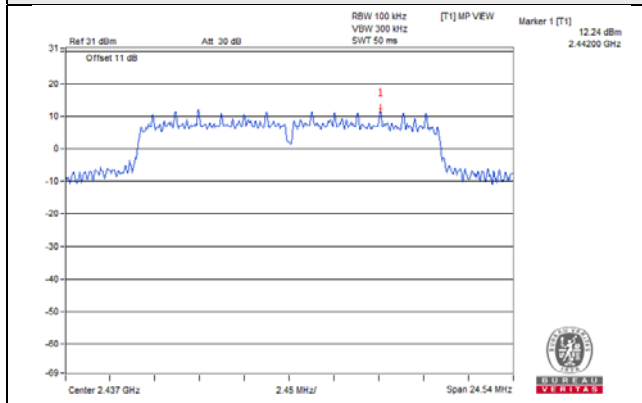

CH 11

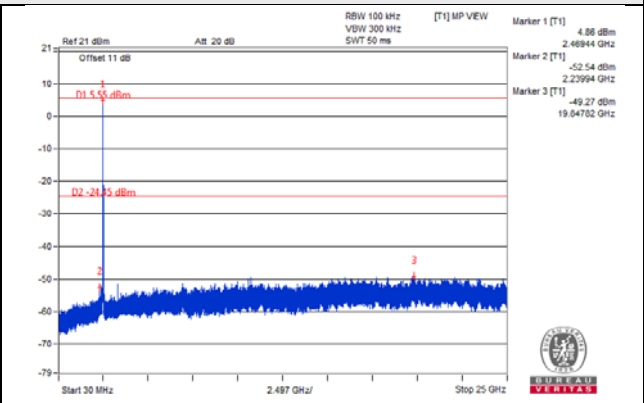
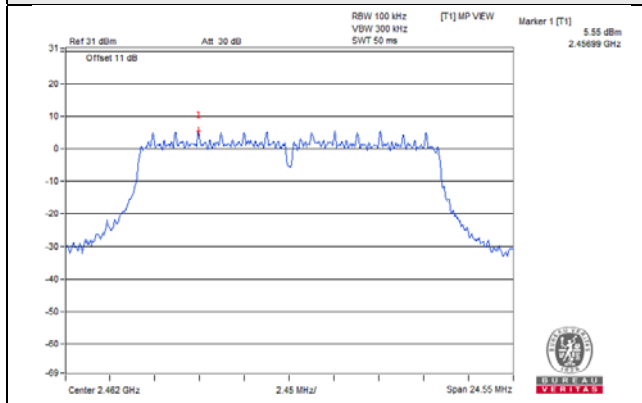

CH 1 Band edge

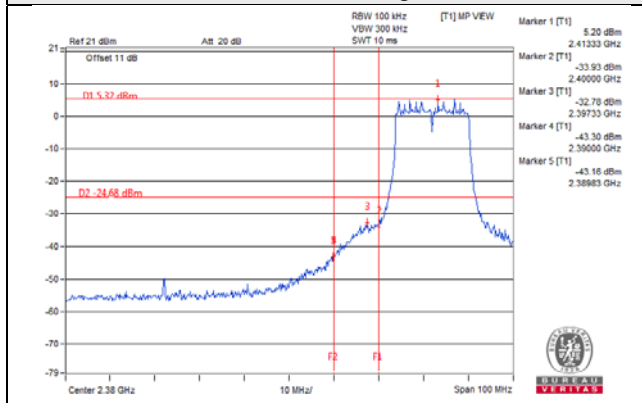

CH 11 Band edge

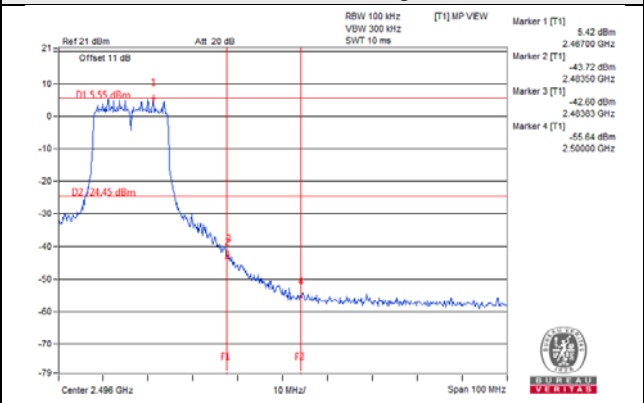

802.11g_Chain 1

CH 1

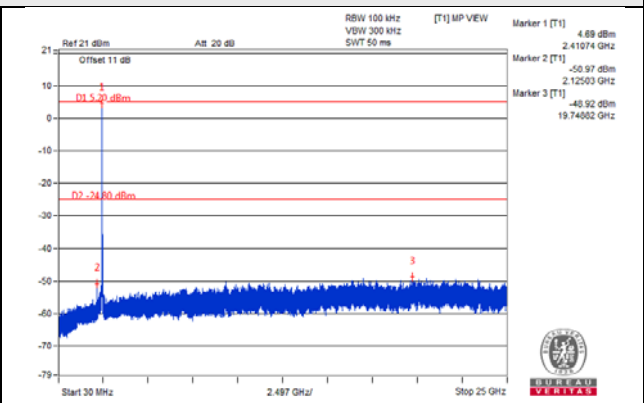
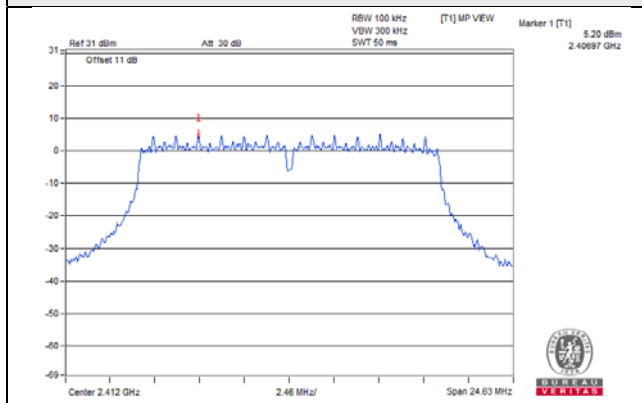

CH 6

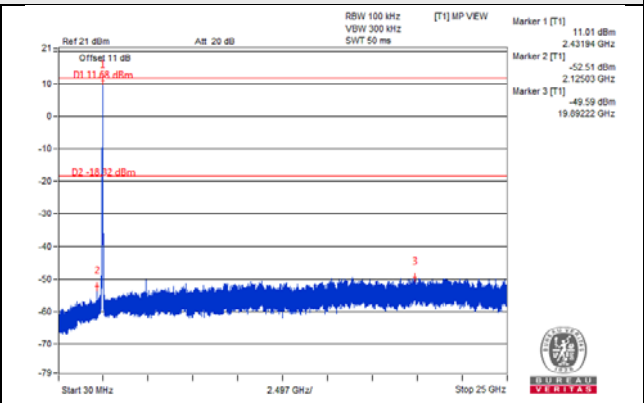
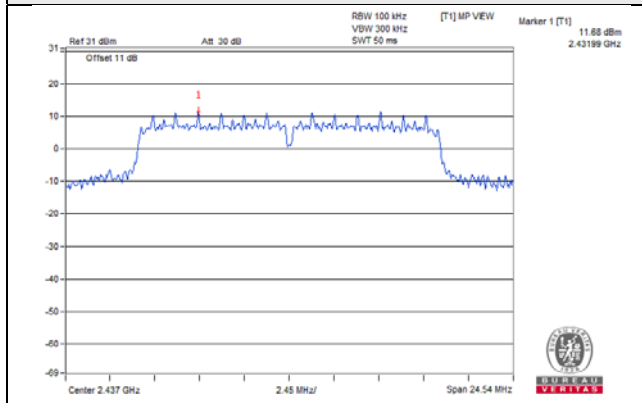

CH 11

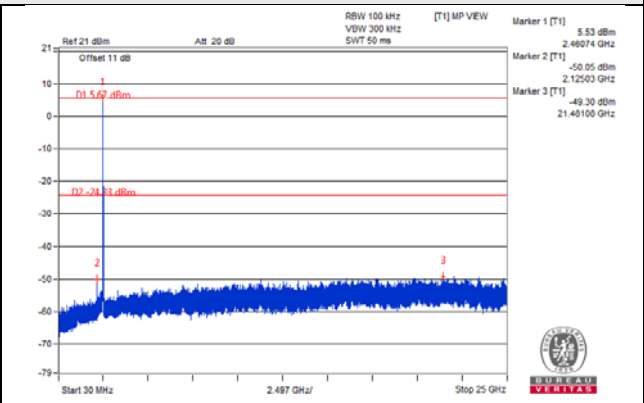
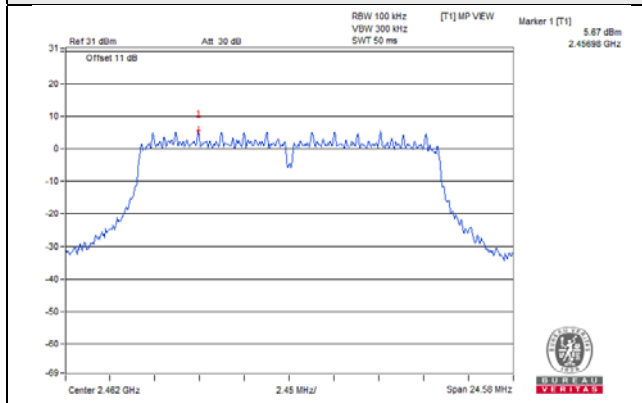

CH 1 Band edge

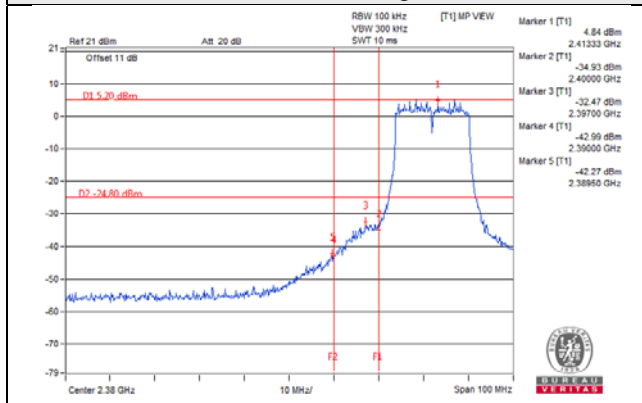

CH 11 Band edge

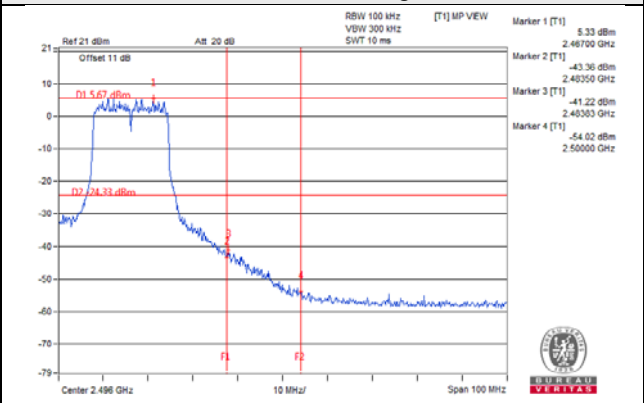

802.11n (HT20)_Chain 0

CH 1

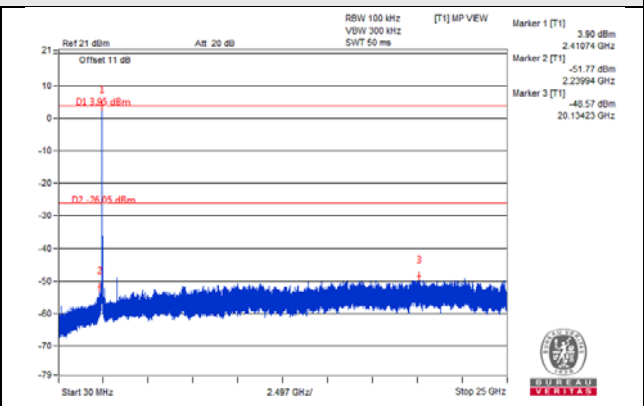
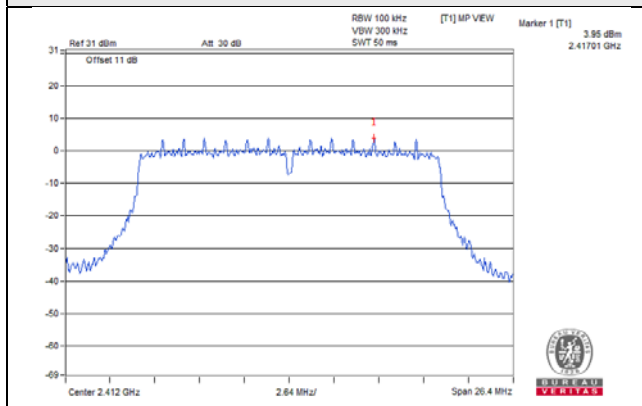

CH 6

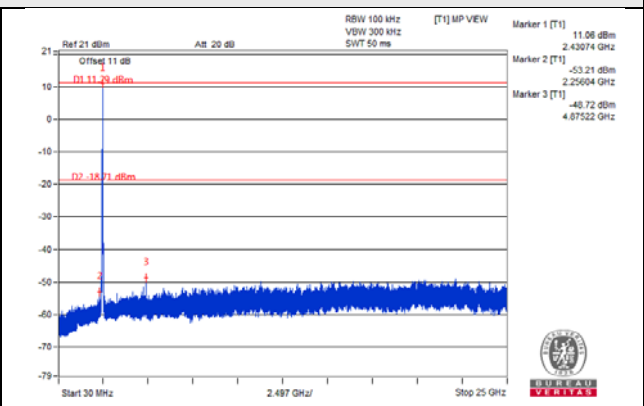
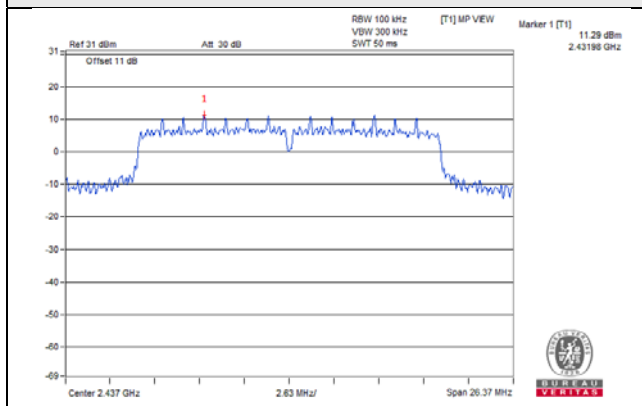

CH 11

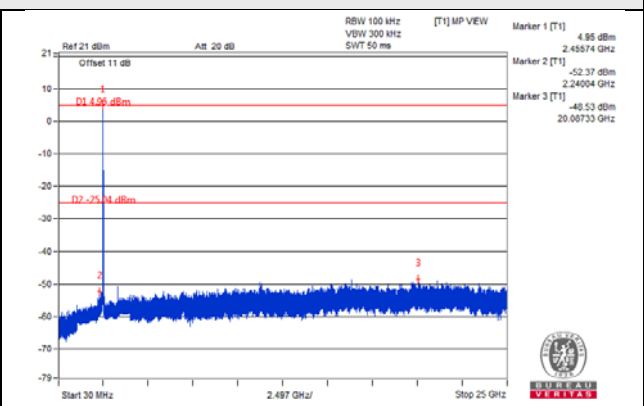
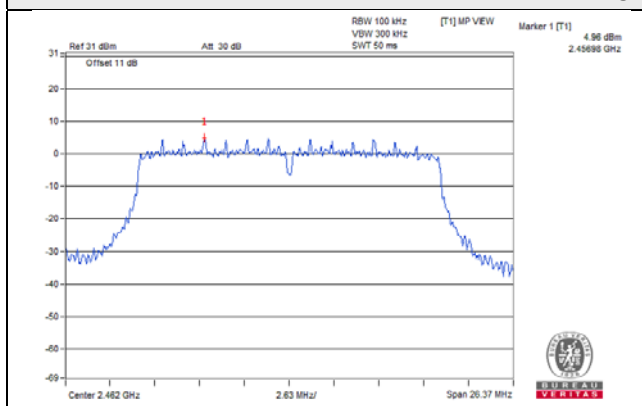

CH 1 Band edge

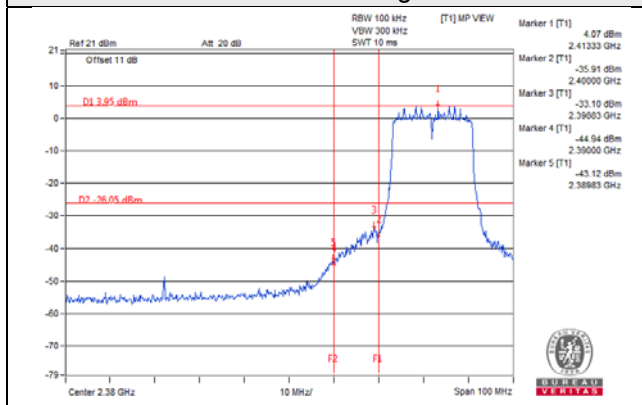

CH 11 Band edge

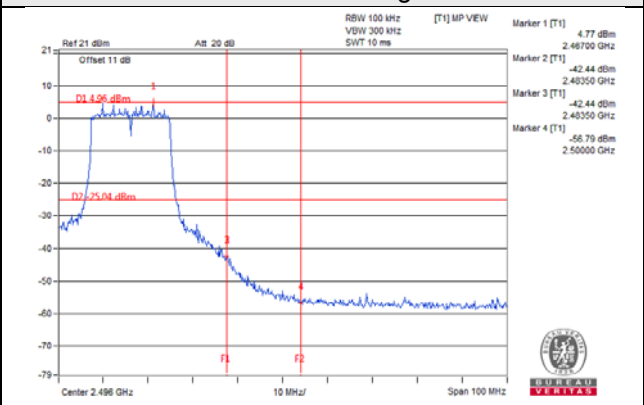

802.11n (HT20)_Chain 1

CH 1

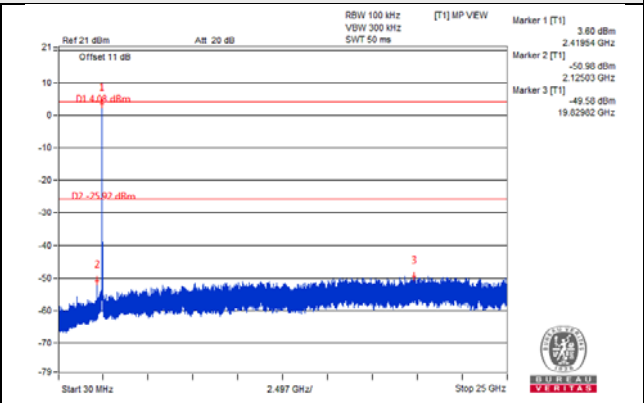
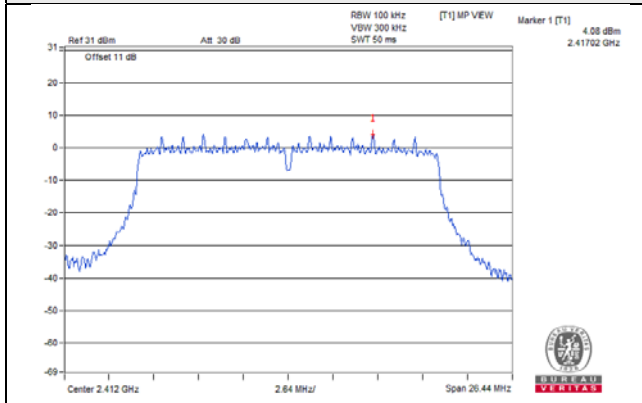

CH 6

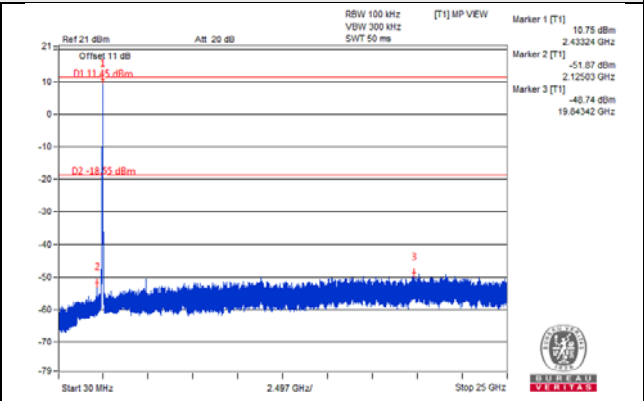
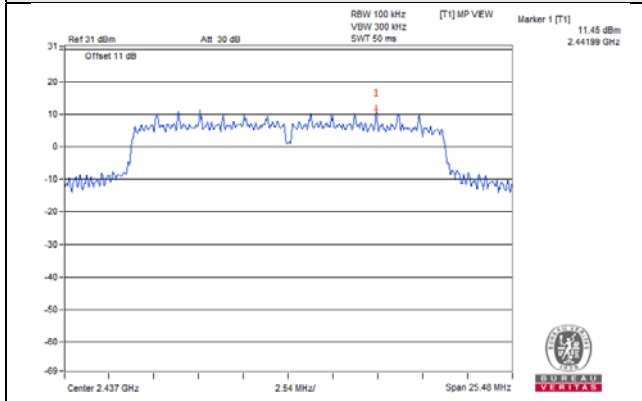

CH 11

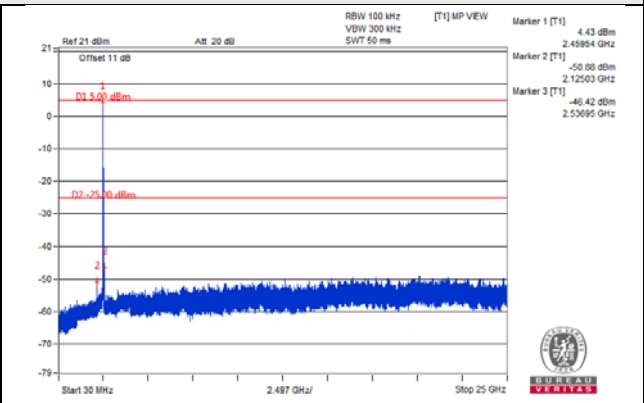
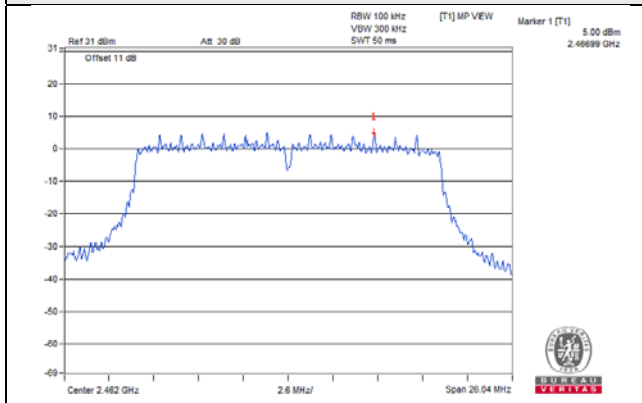

CH 1 Band edge

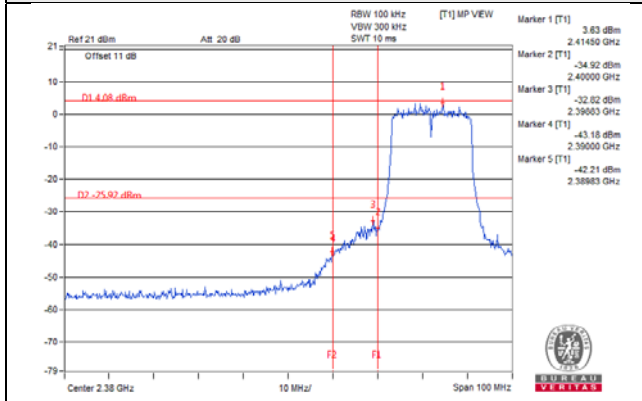

CH 11 Band edge

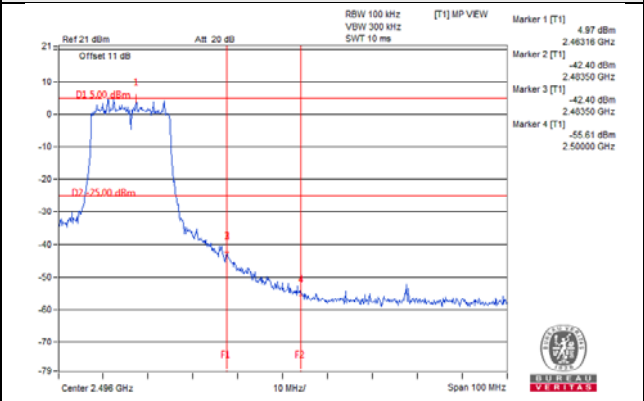

802.11n (HT40)_Chain 0

CH 3

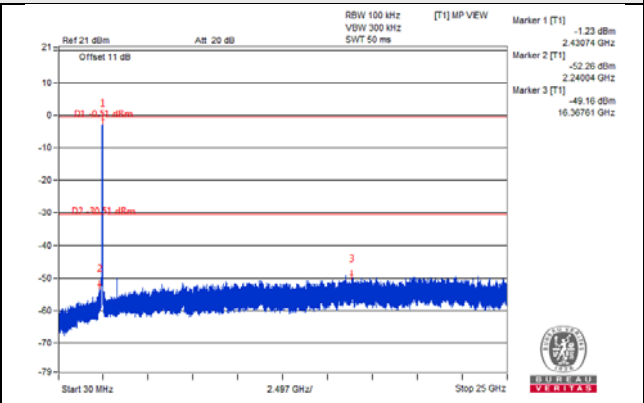
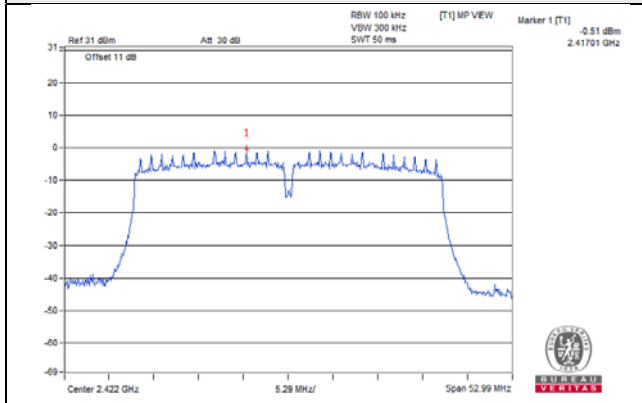

CH 6

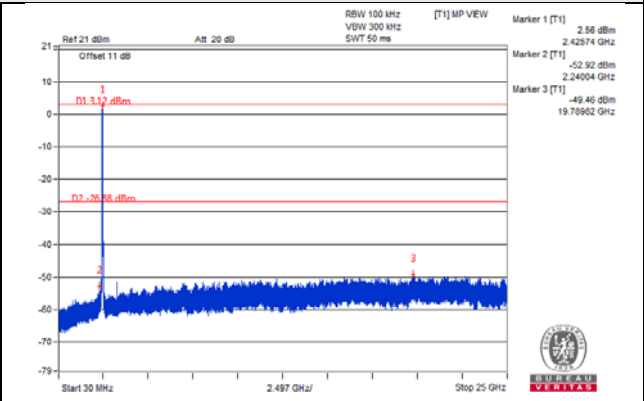
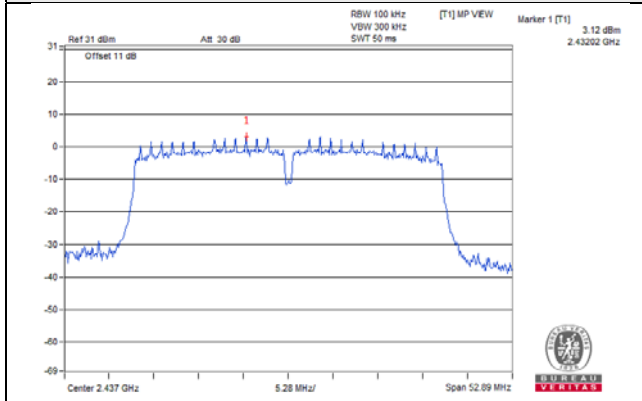

CH 9

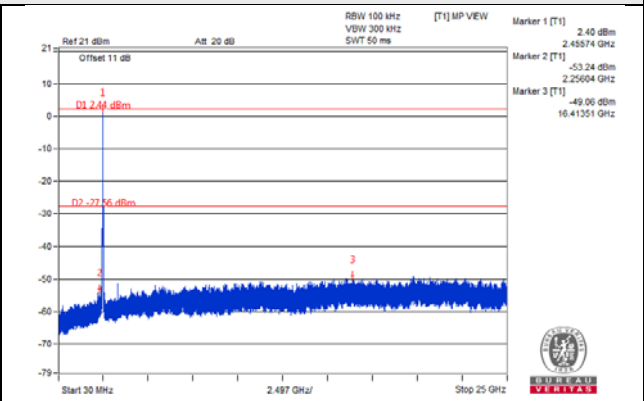
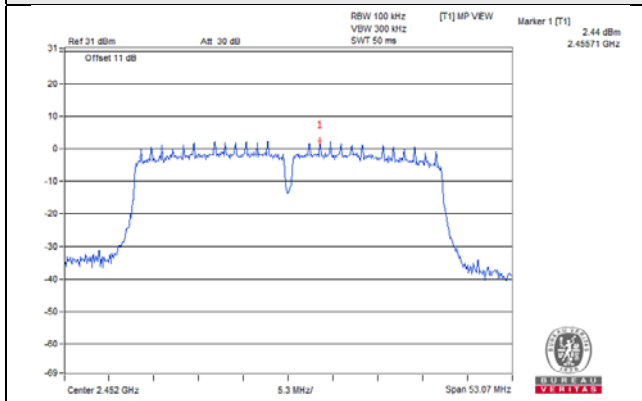

CH 3 Band edge

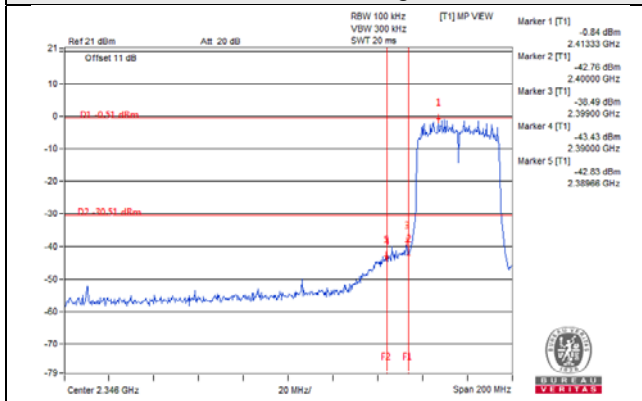

CH 9 Band edge

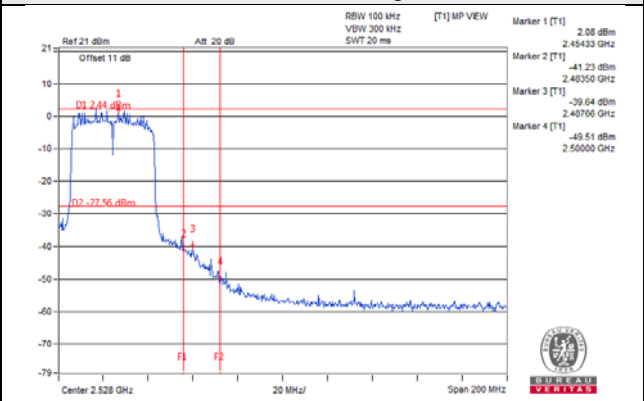

802.11n (HT40)_Chain 1

CH 3

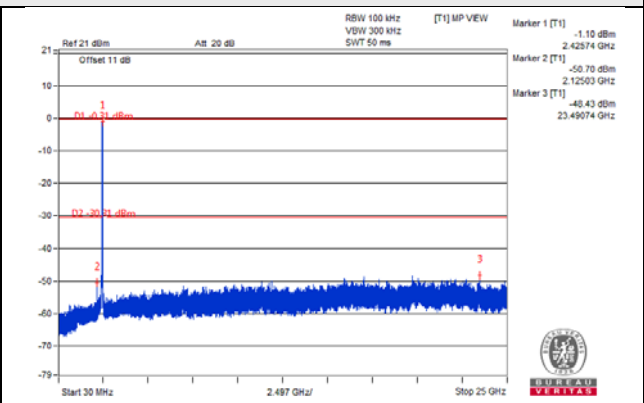
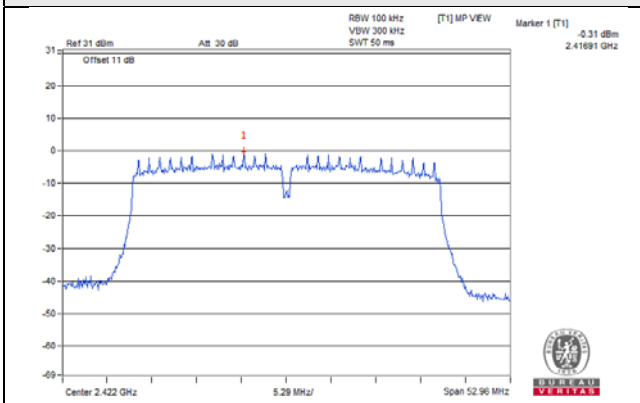

CH 6

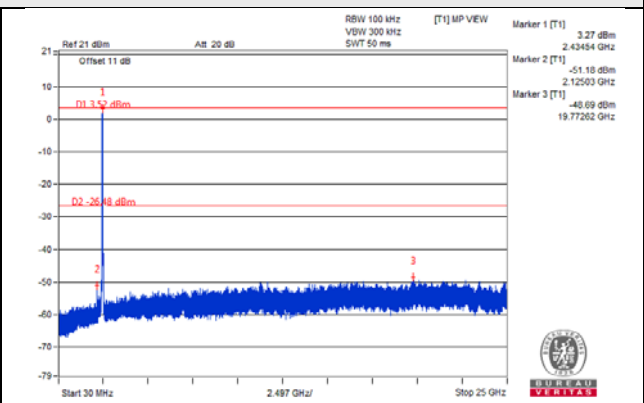
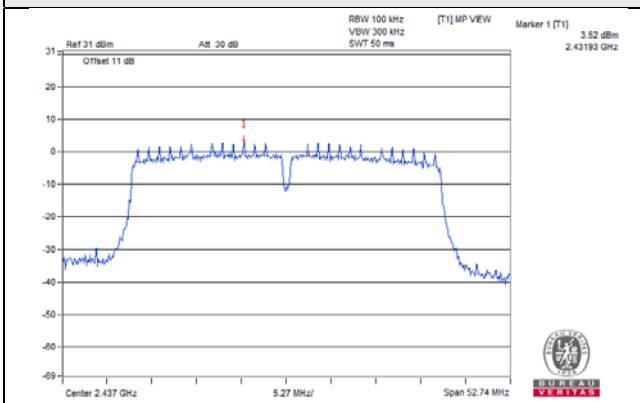

CH 9

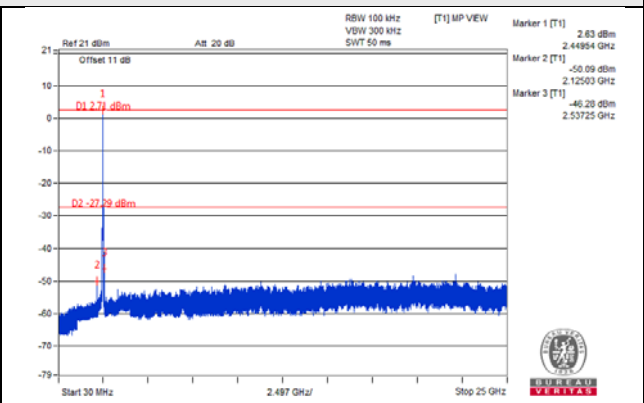
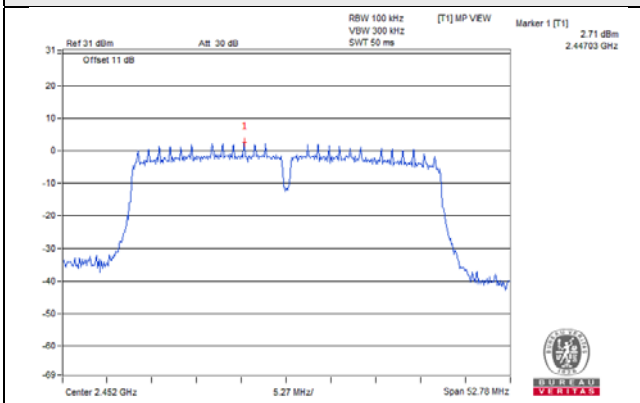

CH 3 Band edge

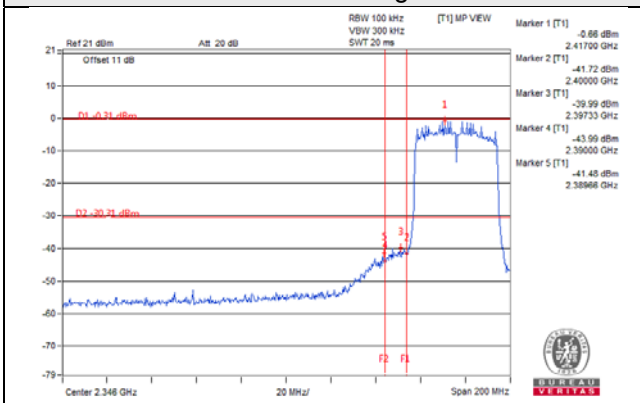

CH 9 Band edge

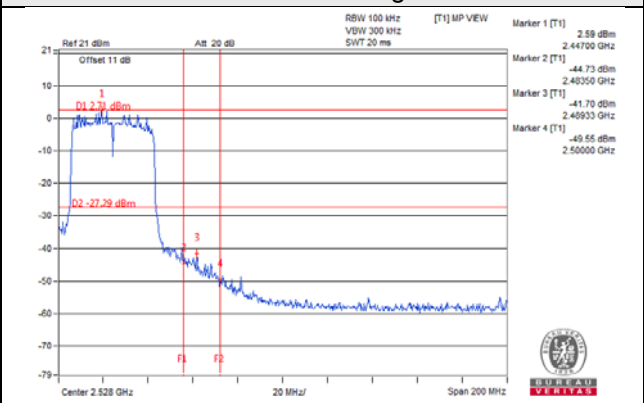

Radio 3
802.11b

CH 1

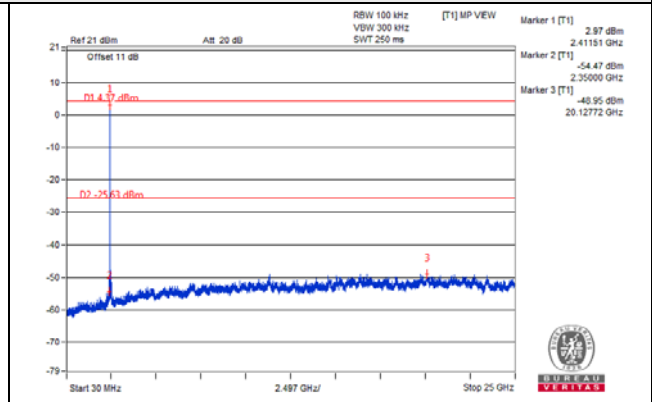
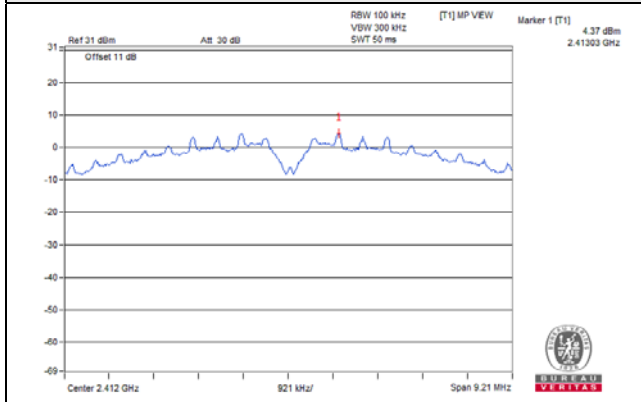

CH 6

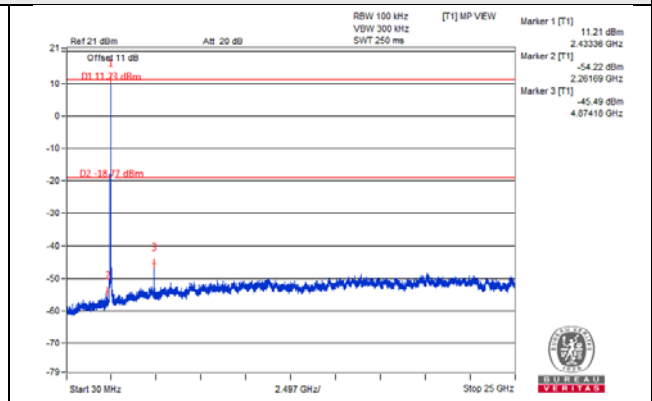
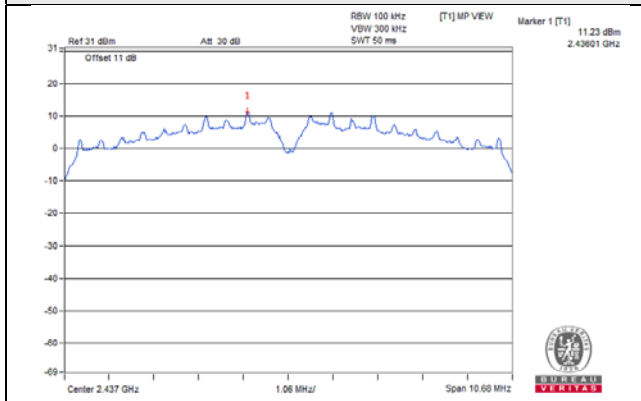

CH 11

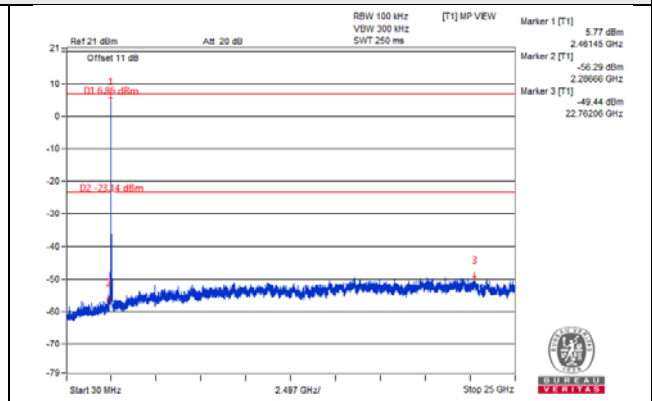
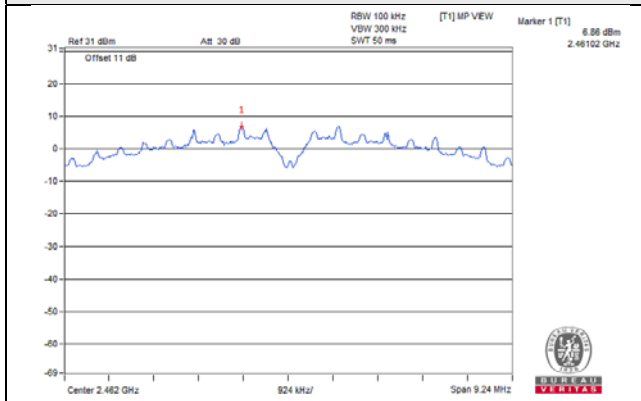

CH 1 Band edge

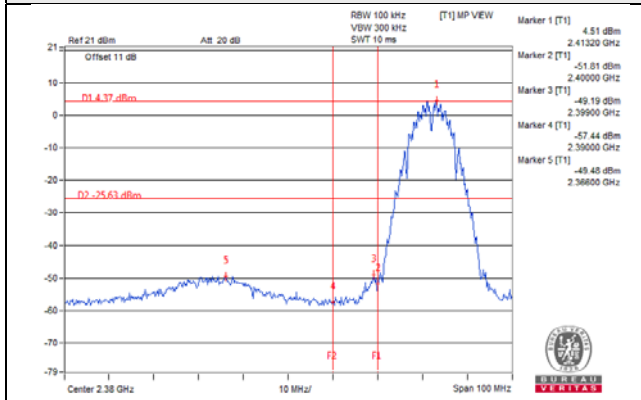

CH 11 Band edge

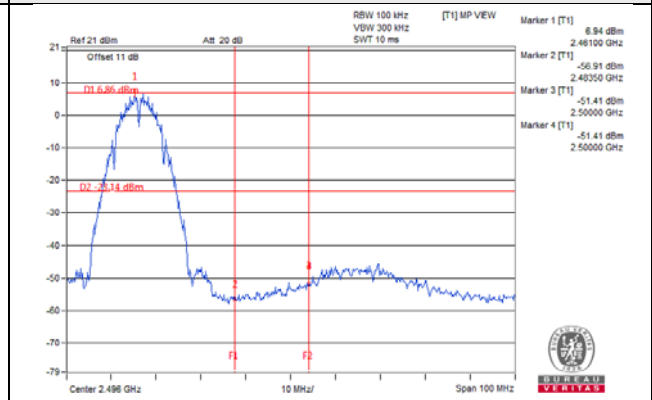

802.11g

CH 1

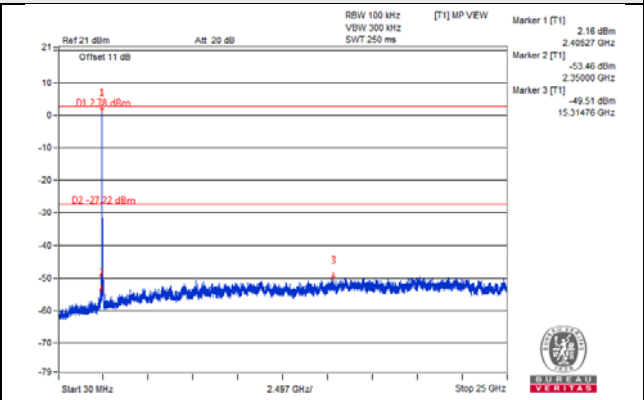
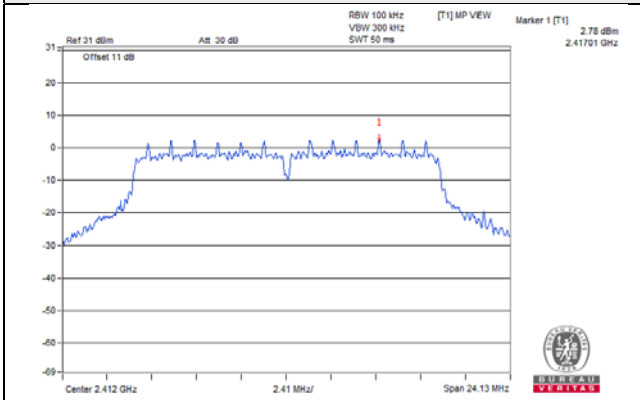

CH 6

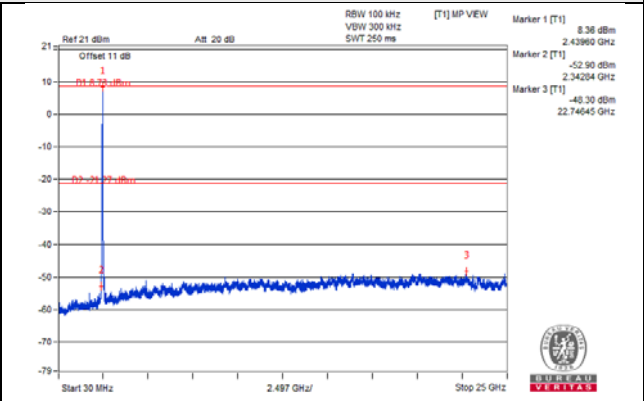
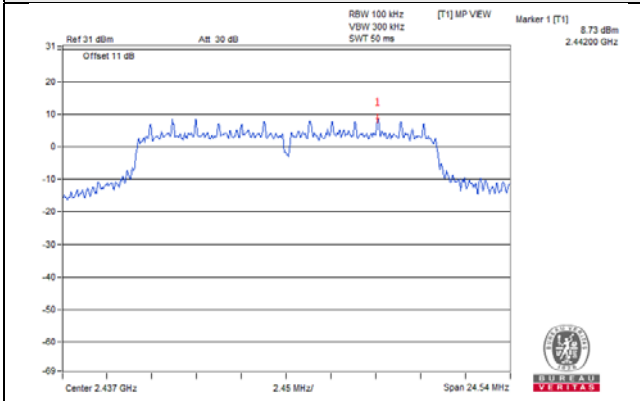

CH 11

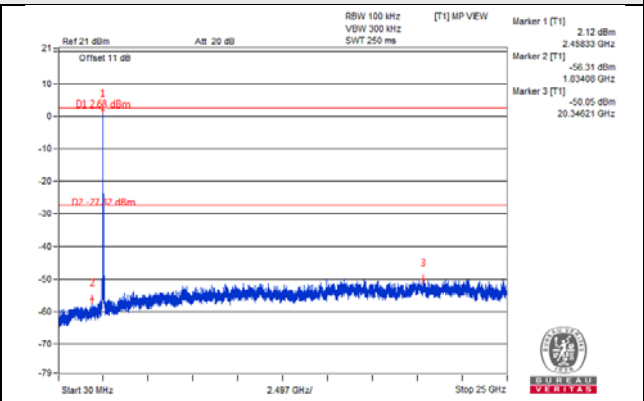
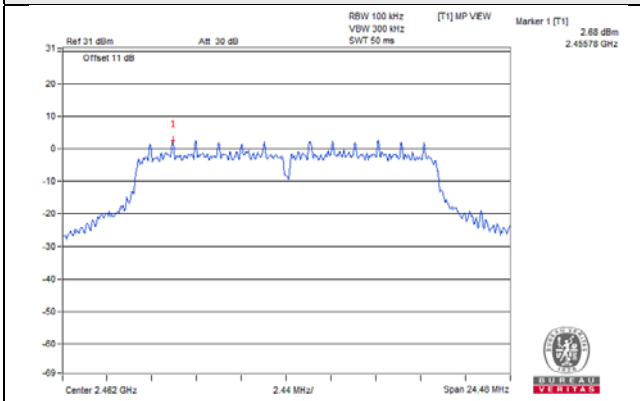

CH 1 Band edge

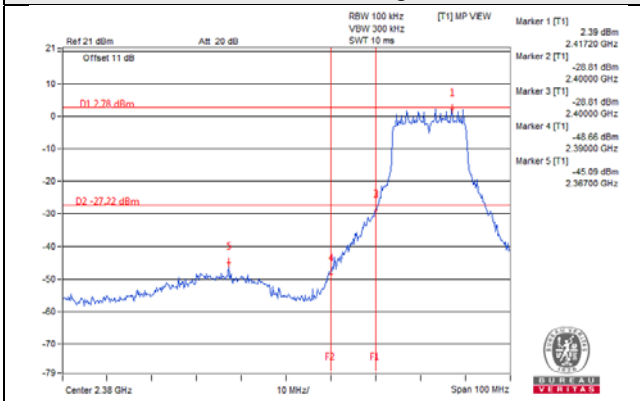

CH 11 Band edge

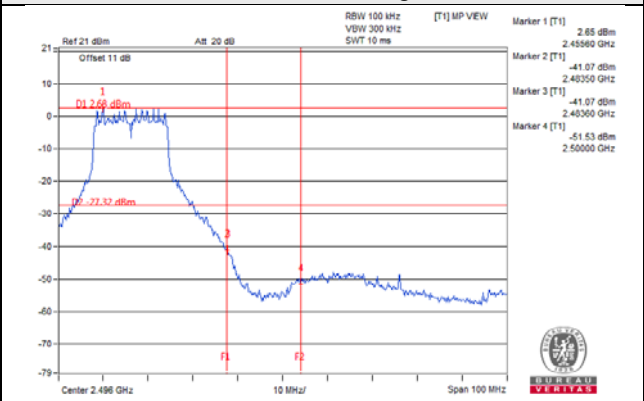

802.11n (HT20)

CH 1

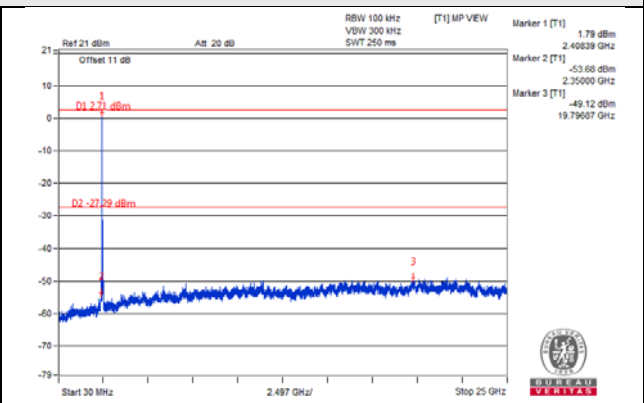
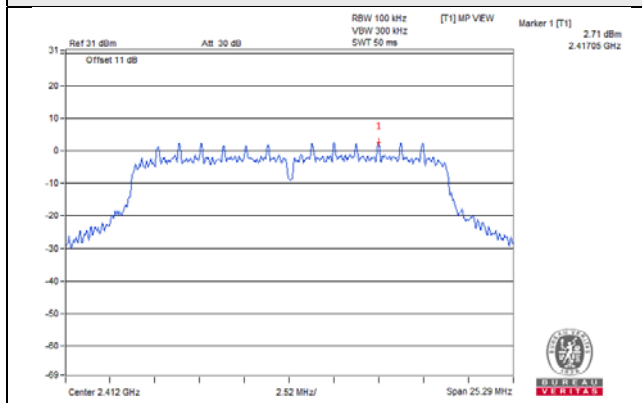

CH 6

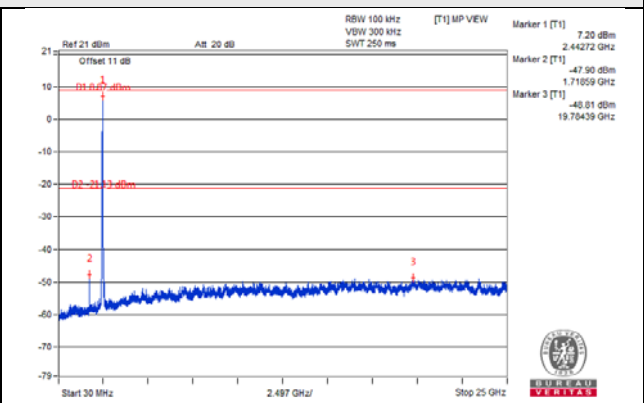
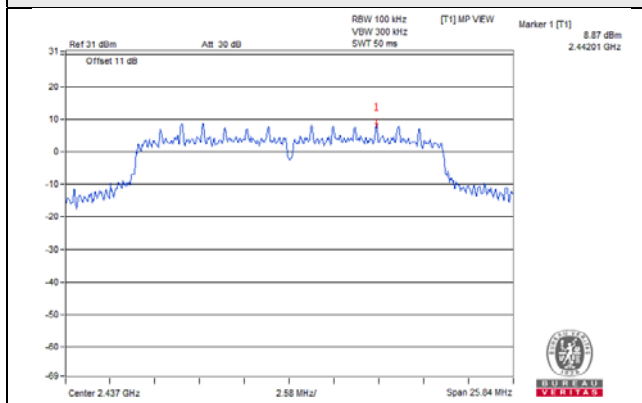

CH 11

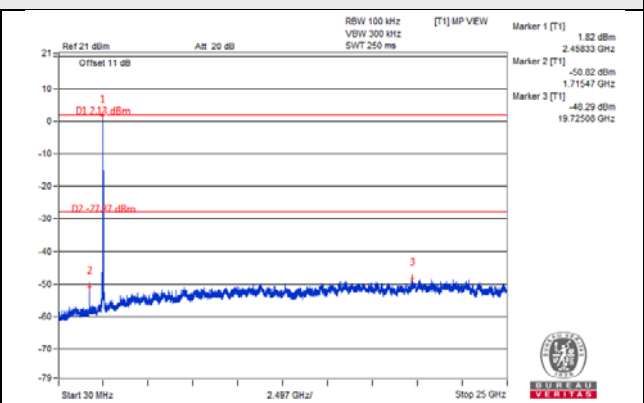
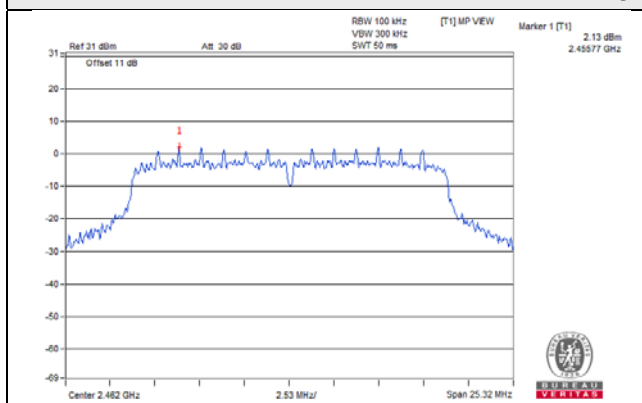

CH 1 Band edge

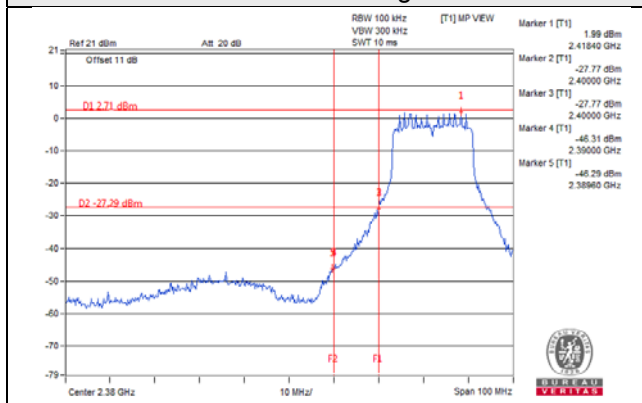

CH 11 Band edge

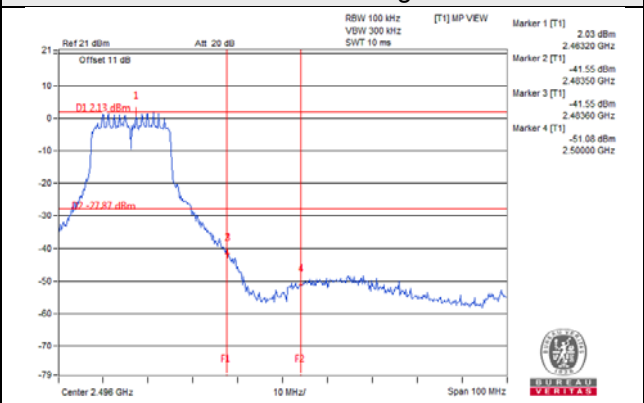

5 Pictures of Test Arrangements

Please refer to the attached file (Test Setup Photo).

Appendix – Information on the Testing Laboratories

We, Bureau Veritas Consumer Products Services (H.K.) Ltd., Taoyuan Branch, were founded in 1988 to provide our best service in EMC, Radio, Telecom and Safety consultation. Our laboratories are FCC recognized accredited test firms and accredited and approved according to ISO/IEC 17025.

If you have any comments, please feel free to contact us at the following:

Linko EMC/RF Lab

Tel: 886-2-26052180

Fax: 886-2-26051924

Hsin Chu EMC/RF/Telecom Lab

Tel: 886-3-6668565

Fax: 886-3-6668323

Hwa Ya EMC/RF/Safety Lab

Tel: 886-3-3183232

Fax: 886-3-3270892

Email: service.adt@tw.bureauveritas.com

Web Site: www.bureauveritas-adt.com

The address and road map of all our labs can be found in our web site also.

--- END ---