

FCC Test Report

Report No.: RF180316C33-1

FCC ID: 2AKCZ-0CF

Test Model: APL44-0CF

Received Date: Mar. 16, 2018

Test Date: Mar. 19 ~ Mar. 29, 2018

Issued Date: Apr. 19, 2018

Applicant: SonicWall Inc.

Address: 1033 McCarthy Blvd., Milpitas, CA 95035, USA

Issued By: Bureau Veritas Consumer Products Services (H.K.) Ltd., Taoyuan Branch

Lab Address: No. 47-2, 14th Ling, Chia Pau Vil., Lin Kou Dist., New Taipei City, Taiwan (R.O.C.)

Test Location: No. 19, Hwa Ya 2nd Rd., Wen Hwa Vil., Kwei Shan Dist., Taoyuan City 33383, TAIWAN (R.O.C.)

**FCC Registration /
Designation Number:** 788550 / TW0003



This report is for your exclusive use. Any copying or replication of this report to or for any other person or entity, or use of our name or trademark, is permitted only with our prior written permission. This report sets forth our findings solely with respect to the test samples identified herein. The results set forth in this report are not indicative or representative of the quality or characteristics of the lot from which a test sample was taken or any similar or identical product unless specifically and expressly noted. Our report includes all of the tests requested by you and the results thereof based upon the information that you provided to us. You have 60 days from date of issuance of this report to notify us of any material error or omission caused by our negligence, provided, however, that such notice shall be in writing and shall specifically address the issue you wish to raise. A failure to raise such issue within the prescribed time shall constitute your unqualified acceptance of the completeness of this report, the tests conducted and the correctness of the report contents. Unless specific mention, the uncertainty of measurement has been explicitly taken into account to declare the compliance or non-compliance to the specification. The report must not be used by the client to claim product certification, approval, or endorsement by TAF or any government agencies.

Table of Contents

| | |
|---|-----------|
| Release Control Record | 4 |
| 1 Certificate of Conformity | 5 |
| 2 Summary of Test Results | 6 |
| 2.1 Measurement Uncertainty..... | 6 |
| 2.2 Modification Record..... | 6 |
| 3 General Information | 7 |
| 3.1 General Description of EUT..... | 7 |
| 3.2 Description of Test Modes..... | 9 |
| 3.2.1 Test Mode Applicability and Tested Channel Detail..... | 10 |
| 3.3 Duty Cycle of Test Signal..... | 12 |
| 3.4 Description of Support Units..... | 13 |
| 3.4.1 Configuration of System under Test..... | 13 |
| 3.5 General Description of Applied Standards..... | 14 |
| 4 Test Types and Results | 15 |
| 4.1 Radiated Emission and Bandedge Measurement..... | 15 |
| 4.1.1 Limits of Radiated Emission and Bandedge Measurement..... | 15 |
| 4.1.2 Test Instruments..... | 16 |
| 4.1.3 Test Procedures..... | 17 |
| 4.1.4 Deviation from Test Standard..... | 17 |
| 4.1.5 Test Setup..... | 18 |
| 4.1.6 EUT Operating Conditions..... | 19 |
| 4.1.7 Test Results..... | 20 |
| 4.2 Conducted Emission Measurement..... | 40 |
| 4.2.1 Limits of Conducted Emission Measurement..... | 40 |
| 4.2.2 Test Instruments..... | 40 |
| 4.2.3 Test Procedures..... | 41 |
| 4.2.4 Deviation from Test Standard..... | 41 |
| 4.2.5 Test Setup..... | 41 |
| 4.2.6 EUT Operating Conditions..... | 41 |
| 4.2.7 Test Results..... | 42 |
| 4.3 Transmit Power Measurement..... | 46 |
| 4.3.1 Limits of Transmit Power Measurement..... | 46 |
| 4.3.2 Test Setup..... | 46 |
| 4.3.3 Test Instruments..... | 46 |
| 4.3.4 Test Procedure..... | 47 |
| 4.3.5 Deviation from Test Standard..... | 47 |
| 4.3.6 EUT Operating Conditions..... | 47 |
| 4.3.7 Test Result..... | 48 |
| 4.4 Occupied Bandwidth Measurement..... | 50 |
| 4.4.1 Test Setup..... | 50 |
| 4.4.2 Test Instruments..... | 50 |
| 4.4.3 Test Procedure..... | 50 |
| 4.4.4 Test Result..... | 51 |
| 4.5 Peak Power Spectral Density Measurement..... | 53 |
| 4.5.1 Limits of Peak Power Spectral Density Measurement..... | 53 |
| 4.5.2 Test Setup..... | 53 |
| 4.5.3 Test Instruments..... | 53 |
| 4.5.4 Test Procedures..... | 53 |
| 4.5.5 Deviation from Test Standard..... | 54 |
| 4.5.6 EUT Operating Conditions..... | 54 |
| 4.5.7 Test Results..... | 55 |
| 4.6 Frequency Stability..... | 60 |
| 4.6.1 Limits of Frequency Stability Measurement..... | 60 |

| | | |
|----------|--|-----------|
| 4.6.2 | Test Setup..... | 60 |
| 4.6.3 | Test Instruments | 60 |
| 4.6.4 | Test Procedure | 60 |
| 4.6.5 | Deviation from Test Standard | 60 |
| 4.6.6 | EUT Operating Condition | 60 |
| 4.6.7 | Test Results | 61 |
| 4.7 | 6dB Bandwidth Measurement..... | 62 |
| 4.7.1 | Limits of 6dB Bandwidth Measurement..... | 62 |
| 4.7.2 | Test Setup..... | 62 |
| 4.7.3 | Test Instruments | 62 |
| 4.7.4 | Test Procedure | 62 |
| 4.7.5 | Deviation from Test Standard | 62 |
| 4.7.6 | EUT Operating Condition | 62 |
| 4.7.7 | Test Results | 63 |
| 5 | Pictures of Test Arrangements..... | 65 |
| | Annex A- Radiated Out of Band Emission (OOBE) Measurement (For U-NII-3 band)..... | 66 |
| | Appendix – Information on the Testing Laboratories | 69 |

Release Control Record

| Issue No. | Description | Date Issued |
|---------------|------------------|---------------|
| RF180316C33-1 | Original release | Apr. 19, 2018 |

1 Certificate of Conformity

Product: Wireless Access Point
Brand: SONICWALL
Test Model: APL44-0CF
Sample Status: Engineering sample
Applicant: SonicWall Inc.
Test Date: Mar. 19 ~ Mar. 29, 2018
Standards: 47 CFR FCC Part 15, Subpart E (Section 15.407)
ANSI C63.10:2013

The above equipment has been tested by **Bureau Veritas Consumer Products Services (H.K.) Ltd., Taoyuan Branch**, and found compliance with the requirement of the above standards. The test record, data evaluation & Equipment Under Test (EUT) configurations represented herein are true and accurate accounts of the measurements of the sample's RF characteristics under the conditions specified in this report.

Prepared by : Celine Chou , **Date:** Apr. 19, 2018
Celine Chou / Specialist

Approved by : Bruce Chen , **Date:** Apr. 19, 2018
Bruce Chen / Project Engineer

2 Summary of Test Results

| 47 CFR FCC Part 15, Subpart E (Section 15.407) | | | |
|--|--|--------|---|
| FCC Clause | Test Item | Result | Remarks |
| 15.407(b)(6) | AC Power Conducted Emissions | Pass | Meet the requirement of limit. Minimum passing margin is -12.63dB at 0.20201MHz. |
| 15.407(b)(1/2/3/4(i/ii)/6) | Radiated Emissions & Band Edge Measurement | Pass | Meet the requirement of limit. Minimum passing margin is -1.3dB at 5925.00MHz, 5150.00MHz and 5650.00MHz. |
| 15.407(a)(1/2/3) | Max Average Transmit Power | Pass | Meet the requirement of limit. |
| --- | Occupied Bandwidth Measurement | - | Reference only. |
| 15.407(a)(1/2/3) | Peak Power Spectral Density | Pass | Meet the requirement of limit. |
| 15.407(e) | 6dB bandwidth | Pass | Meet the requirement of limit. (U-NII-3 Band only) |
| 15.407(g) | Frequency Stability | Pass | Meet the requirement of limit. |
| 15.203 | Antenna Requirement | Pass | Antenna connector is I-PEX not a standard connector. |

*For U-NII-3 band compliance with rule part 15.407(b)(4)(i), the OOB test plots were recorded in Annex A.

2.1 Measurement Uncertainty

Where relevant, the following measurement uncertainty levels have been estimated for tests performed on the EUT as specified in CISPR 16-4-2:

| Measurement | Frequency | Expanded Uncertainty (k=2) (±) |
|------------------------------------|-----------------|--------------------------------|
| Conducted Emissions at mains ports | 150kHz ~ 30MHz | 2.94 dB |
| Radiated Emissions up to 1 GHz | 30MHz ~ 200MHz | 3.86 dB |
| | 200MHz ~1000MHz | 3.87 dB |
| Radiated Emissions above 1 GHz | 1GHz ~ 18GHz | 2.29 dB |
| | 18GHz ~ 40GHz | 2.29 dB |

2.2 Modification Record

There were no modifications required for compliance.

3 General Information

3.1 General Description of EUT

| | |
|-----------------------|--|
| Product | Wireless Access Point |
| Brand | SONICWALL |
| Test Model | APL44-OCF |
| Sample Status | Engineering sample |
| Power Supply Rating | 12Vdc from Adapter 52Vdc from PoE |
| Modulation Type | 256QAM, 64QAM, 16QAM, QPSK, BPSK |
| Modulation Technology | OFDM |
| Transfer Rate | 802.11a: 54/48/36/24/18/12/9/6Mbps 802.11n: up to 300Mbps 802.11ac: up to 867Mbps |
| Operating Frequency | 5180 ~ 5240MHz, 5745 ~ 5825MHz |
| Number of Channel | 5180 ~ 5240MHz: 802.11a, 802.11n (HT20), 802.11ac (VHT20): 4 802.11n (HT40), 802.11ac (VHT40): 2 802.11ac (VHT80): 1 5745 ~ 5825MHz: 802.11a, 802.11n (HT20), 802.11ac (VHT20): 5 802.11n (HT40), 802.11ac (VHT40): 2 802.11ac (VHT80): 1 |
| Output Power | CDD Mode: 5180 ~ 5240MHz: 469.456mW 5745 ~ 5825MHz: 475.872mW Beamforming Mode: 5180 ~ 5240MHz: 232.592mW 5745 ~ 5825MHz: 233.262mW |
| Antenna Type | Refer to note |
| Antenna Connector | Refer to note |
| Accessory Device | NA |
| Cable Supplied | 1.75m non-shielded RJ45 cable without core |

Note:

1. The EUT incorporates a MIMO function. Physically, the EUT provides 2 completed transmitters and 2 receivers.

| Modulation Mode | Beamforming Mode | TX Function | Remark |
|------------------|------------------|-------------|---------------------|
| 802.11a | Not Support | 2TX | Radio 2 (Ant. 3, 4) |
| 802.11n (HT20) | Support | 2TX | |
| 802.11n (HT40) | Support | 2TX | |
| 802.11ac (VHT20) | Support | 2TX | |
| 802.11ac (VHT40) | Support | 2TX | |
| 802.11ac (VHT80) | Support | 2TX | |

* The modulation and bandwidth are similar for 802.11n mode for 20MHz/40MHz and 802.11ac mode for 20MHz/40MHz, therefore investigated worst case to representative mode in test report. (Final test mode refer section 3.2.1)

* For 802.11n and 802.11ac, CDD mode and Beamforming mode are presented in power output test item. For other test items, CDD mode is the worst case for final tests after pretesting.

2. The EUT consumes power from the following Adapter and PoE. (support unit only)

| Adapter | |
|------------|---|
| Brand | Powertron Electronics Corp. |
| Model | PA1015-120DUB150 |
| Input | 100-240Vac~50-60Hz 0.4A |
| Output | 12Vdc/ 1.5A 18W Max. |
| Power Line | 1.5m cable without core attached on adapter |

| PoE | |
|--------|-------------------------|
| Brand | DELL |
| Model | ADPE01-0B1 |
| Input | 100-240Vac~50-60Hz 0.6A |
| Output | 52Vdc/ 0.58A |

3. The following antennas were provided to the EUT.

| Ant. No. | 1 | 2 | 3 | 4 | 5 (BLE) | 6 (Scan) |
|-----------------|-----------|------|-----------|------|-----------|-----------|
| Ant. Type | PIFA | PIFA | PIFA | PIFA | PCB | PCB |
| Ant. Connector | IPEX | IPEX | IPEX | IPEX | IPEX | IPEX |
| Frequency (MHz) | 2400-2500 | | 5150-5850 | | 2400-2500 | 2400-2500 |
| Peak Gain (dBi) | 4.58 | 3.63 | 5.56 | 4.58 | 5.80 | 3.89 |

3.2 Description of Test Modes

For 5180 ~ 5240MHz:

4 channels are provided for 802.11a, 802.11n (HT20), 802.11ac (VHT20):

| Channel | Frequency | Channel | Frequency |
|---------|-----------|---------|-----------|
| 36 | 5180 MHz | 44 | 5220 MHz |
| 40 | 5200 MHz | 48 | 5240 MHz |

2 channels are provided for 802.11n (HT40), 802.11ac (VHT40):

| Channel | Frequency | Channel | Frequency |
|---------|-----------|---------|-----------|
| 38 | 5190 MHz | 46 | 5230 MHz |

1 channel is provided for 802.11ac (VHT80):

| Channel | Frequency |
|---------|-----------|
| 42 | 5210MHz |

For 5745 ~ 5825MHz:

5 channels are provided for 802.11a, 802.11n (HT20), 802.11ac (VHT20):

| Channel | Frequency | Channel | Frequency |
|---------|-----------|---------|-----------|
| 149 | 5745MHz | 161 | 5805MHz |
| 153 | 5765MHz | 165 | 5825MHz |
| 157 | 5785MHz | | |

2 channels are provided for 802.11n (HT40), 802.11ac (VHT40):

| Channel | Frequency | Channel | Frequency |
|---------|-----------|---------|-----------|
| 151 | 5755MHz | 159 | 5795MHz |

1 channel is provided for 802.11ac (VHT80):

| Channel | Frequency |
|---------|-----------|
| 155 | 5775MHz |

3.2.1 Test Mode Applicability and Tested Channel Detail

| EUT Configure Mode | Applicable to | | | | Description |
|--------------------|---------------|-------|-----|------|--------------------|
| | RE \geq 1G | RE<1G | PLC | APCM | |
| A | √ | √ | √ | √ | Powered by adapter |
| B | - | √ | √ | - | Powered by POE |

Where RE \geq 1G: Radiated Emission above 1GHz & Bandedge Measurement
 RE<1G: Radiated Emission below 1GHz
 PLC: Power Line Conducted Emission
 APCM: Antenna Port Conducted Measurement

Note:

1. The EUT had been pre-tested on the positioned of each 3 axis. The worst case was found when positioned on **Z-plane**.
2. "-" means no effect.

Radiated Emission Test (Above 1GHz):

- Pre-Scan has been conducted to determine the worst-case mode from all possible combinations between available modulations, data rates and antenna ports (if EUT with antenna diversity architecture).
- Following channel(s) was (were) selected for the final test as listed below.

| EUT Configure Mode | Mode | Frequency Band (MHz) | Available Channel | Tested Channel | Modulation Technology | Data Rate (Mbps) |
|--------------------|------------------|----------------------|-------------------|----------------|-----------------------|------------------|
| A | 802.11a | 5180-5240 | 36 to 48 | 36, 40, 48 | OFDM | 6.0 |
| | 802.11n (HT20) | | 36 to 48 | 36, 40, 48 | OFDM | 6.5 |
| | 802.11n (HT40) | | 38 to 46 | 38, 46 | OFDM | 13.5 |
| | 802.11ac (VHT80) | | 42 | 42 | OFDM | 29.3 |
| A | 802.11a | 5745-5825 | 149 to 165 | 149, 157, 165 | OFDM | 6.0 |
| | 802.11n (HT20) | | 149 to 165 | 149, 157, 165 | OFDM | 6.5 |
| | 802.11n (HT40) | | 151 to 159 | 151, 159 | OFDM | 13.5 |
| | 802.11ac (VHT80) | | 155 | 155 | OFDM | 29.3 |

Radiated Emission Test (Below 1GHz):

- Pre-Scan has been conducted to determine the worst-case mode from all possible combinations between available modulations, data rates and antenna ports (if EUT with antenna diversity architecture).
- Following channel(s) was (were) selected for the final test as listed below.

| EUT Configure Mode | Mode | Frequency Band (MHz) | Available Channel | Tested Channel | Modulation Technology | Data Rate (Mbps) |
|--------------------|---------|----------------------|-------------------|----------------|-----------------------|------------------|
| A, B | 802.11a | 5180-5240 | 36 to 48 | 157 | OFDM | 6.0 |
| | 802.11a | 5745-5825 | 149 to 165 | | OFDM | 6.0 |

Power Line Conducted Emission Test:

- Pre-Scan has been conducted to determine the worst-case mode from all possible combinations between available modulations, data rates and antenna ports (if EUT with antenna diversity architecture).
- Following channel(s) was (were) selected for the final test as listed below.

| EUT Configure Mode | Mode | Frequency Band (MHz) | Available Channel | Tested Channel | Modulation Technology | Data Rate (Mbps) |
|--------------------|---------|----------------------|-------------------|----------------|-----------------------|------------------|
| A, B | 802.11a | 5180-5240 | 36 to 48 | 157 | OFDM | 6.0 |
| | 802.11a | 5745-5825 | 149 to 165 | | OFDM | 6.0 |

Peak Power Spectral Density, Bandwidth and Frequency Stability Measurement:

- This item includes all test value of each mode, but only includes spectrum plot of worst value of each mode.
- Pre-Scan has been conducted to determine the worst-case mode from all possible combinations between available modulations, data rates and antenna ports (if EUT with antenna diversity architecture).
- Following channel(s) was (were) selected for the final test as listed below.

| EUT Configure Mode | Mode | Frequency Band (MHz) | Available Channel | Tested Channel | Modulation Technology | Data Rate (Mbps) |
|--------------------|------------------|----------------------|-------------------|----------------|-----------------------|------------------|
| A | 802.11a | 5180-5240 | 36 to 48 | 36, 40, 48 | OFDM | 6.0 |
| | 802.11n (HT20) | | 36 to 48 | 36, 40, 48 | OFDM | 6.5 |
| | 802.11n (HT40) | | 38 to 46 | 38, 46 | OFDM | 13.5 |
| | 802.11ac (VHT80) | | 42 | 42 | OFDM | 29.3 |
| A | 802.11a | 5745-5825 | 149 to 165 | 149, 157, 165 | OFDM | 6.0 |
| | 802.11n (HT20) | | 149 to 165 | 149, 157, 165 | OFDM | 6.5 |
| | 802.11n (HT40) | | 151 to 159 | 151, 159 | OFDM | 13.5 |
| | 802.11ac (VHT80) | | 155 | 155 | OFDM | 29.3 |

Transmit Power Measurement:

- This item includes all test value of each mode, but only includes spectrum plot of worst value of each mode.
- Pre-Scan has been conducted to determine the worst-case mode from all possible combinations between available modulations, data rates and antenna ports (if EUT with antenna diversity architecture).
- Following channel(s) was (were) selected for the final test as listed below.

| EUT Configure Mode | Mode | Frequency Band (MHz) | Available Channel | Tested Channel | Modulation Technology | Data Rate (Mbps) |
|--------------------|------------------|----------------------|-------------------|----------------|-----------------------|------------------|
| CDD Mode | | | | | | |
| A | 802.11a | 5180-5240 | 36 to 48 | 36, 40, 48 | OFDM | 6.0 |
| | 802.11n (HT20) | | 36 to 48 | 36, 40, 48 | OFDM | 6.5 |
| | 802.11n (HT40) | | 38 to 46 | 38, 46 | OFDM | 13.5 |
| | 802.11ac (VHT80) | | 42 | 42 | OFDM | 29.3 |
| A | 802.11a | 5745-5825 | 149 to 165 | 149, 157, 165 | OFDM | 6.0 |
| | 802.11n (HT20) | | 149 to 165 | 149, 157, 165 | OFDM | 6.5 |
| | 802.11n (HT40) | | 151 to 159 | 151, 159 | OFDM | 13.5 |
| | 802.11ac (VHT80) | | 155 | 155 | OFDM | 29.3 |
| Beamforming Mode | | | | | | |
| A | 802.11n (HT20) | 5180-5240 | 36 to 48 | 36, 40, 48 | OFDM | 6.5 |
| | 802.11n (HT40) | | 38 to 46 | 38, 46 | OFDM | 13.5 |
| | 802.11ac (VHT80) | | 42 | 42 | OFDM | 29.3 |
| A | 802.11n (HT20) | 5745-5825 | 149 to 165 | 149, 157, 165 | OFDM | 6.5 |
| | 802.11n (HT40) | | 151 to 159 | 151, 159 | OFDM | 13.5 |
| | 802.11ac (VHT80) | | 155 | 155 | OFDM | 29.3 |

Test Condition:

| Applicable to | Environmental Conditions | Input Power | Tested by |
|---------------|--|-----------------------|--------------------------|
| RE \geq 1G | 24 deg. C, 66% RH 23 deg. C, 69% RH | 120Vac, 60Hz | Adair Peng Will Cheng |
| RE $<$ 1G | 23 deg. C, 66% RH | 120Vac, 60Hz 52Vdc | Will Cheng |
| PLC | 25 deg. C, 75% RH | 120Vac, 60Hz 52Vdc | Adair Peng |
| APCM | 25 deg. C, 60% RH | 120Vac, 60Hz | Chris Lin |

3.3 Duty Cycle of Test Signal

802.11n (HT20): Duty cycle of test signal is > 98%, duty factor is not required.

802.11a, 802.11n (HT40), 802.11ac (VHT80): Duty cycle of test signal is < 98%, duty factor is required.

802.11a: Duty cycle = 2.064/2.187 = 0.944, Duty factor = 10 * log (1/0.944) = 0.25

802.11n (HT20): Duty cycle = 4.977/5.075 = 0.981

802.11n (HT40): Duty cycle = 2.415/2.508 = 0.963, Duty factor = 10 * log (1/0.963) = 0.16

802.11ac (VHT80): Duty cycle = 1.140/1.234 = 0.924, Duty factor = 10 * log (1/0.924) = 0.34

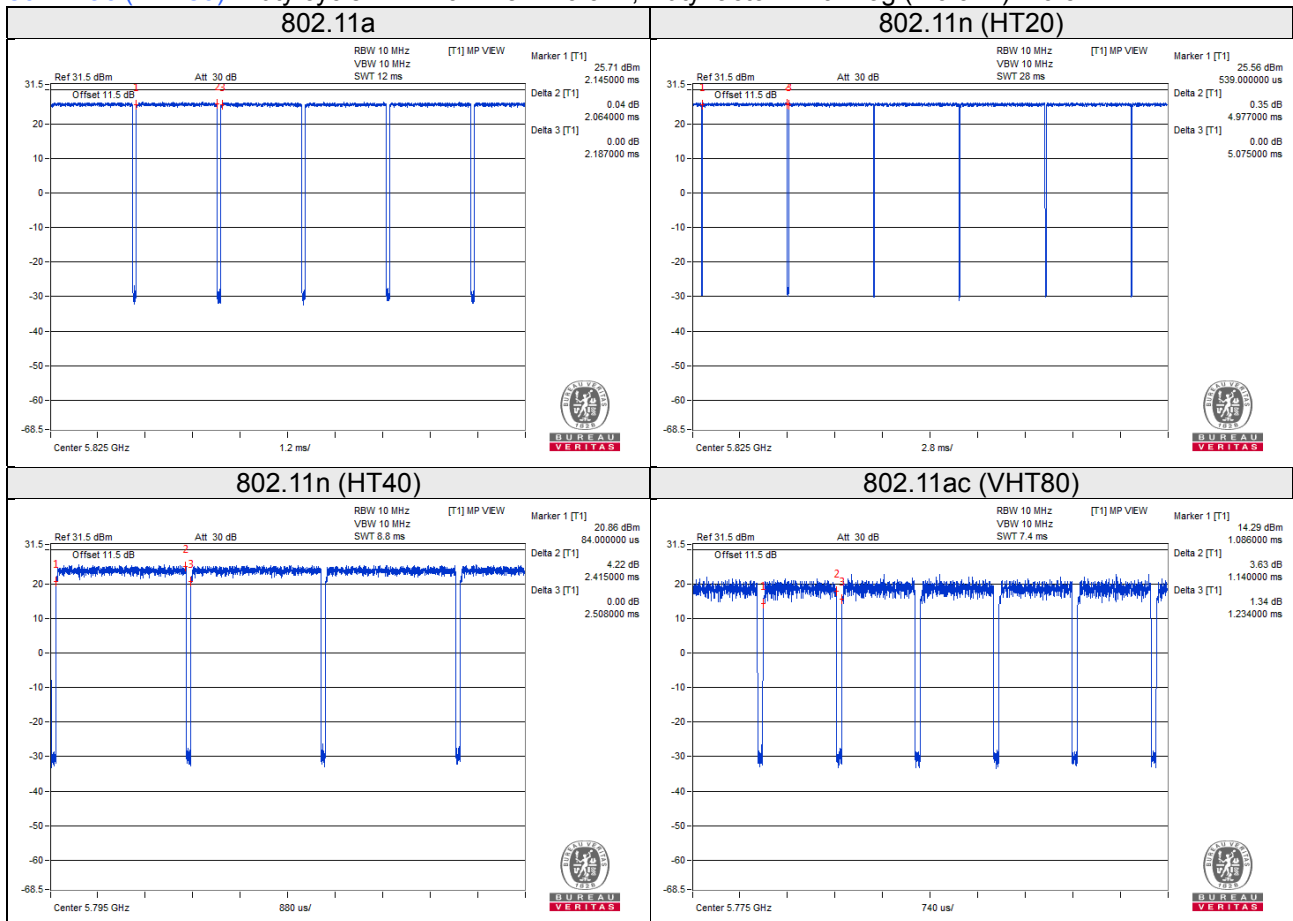

3.4 Description of Support Units

The EUT has been tested as an independent unit together with other necessary accessories or support units. The following support units or accessories were used to form a representative test configuration during the tests.

| ID | Product | Brand | Model No. | Serial No. | FCC ID | Remarks |
|----|-----------|-----------------------------|------------------|------------|------------------|--------------------|
| A. | Notebook | DELL | E5410 | 6RP2YM1 | FCC DoC Approved | - |
| B. | USB Flash | HP | v250W | 01 | FCC DoC Approved | - |
| C. | Adapter | Powertron Electronics Corp. | PA1015-120DUB150 | NA | NA | Provided by client |
| D. | PoE | DELL | ADPE01-0B1 | NA | NA | Provided by client |

Note:

1. All power cords of the above support units are non-shielded (1.8m).
2. Item A acted as a communication partner to transfer data.

| ID | Descriptions | Qty. | Length (m) | Shielding (Yes/No) | Cores (Qty.) | Remarks |
|----|--------------|------|------------|--------------------|--------------|---------------------|
| 1. | DC cable | 1 | 1.5 | N | 0 | Attached on adapter |
| 2. | RJ45, Cat5e | 1 | 3 | N | 0 | - |
| 3. | RJ45, Cat5e | 1 | 1.8 | N | 0 | - |

3.4.1 Configuration of System under Test

Test Mode A

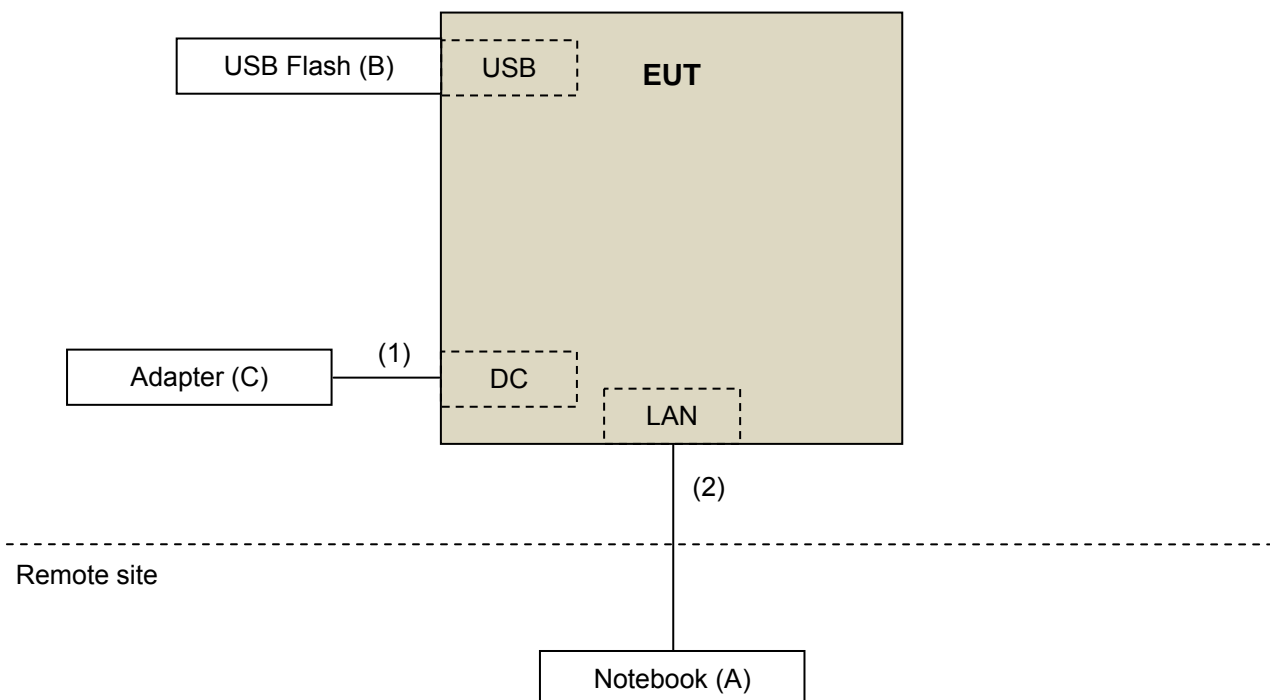

Test Mode B

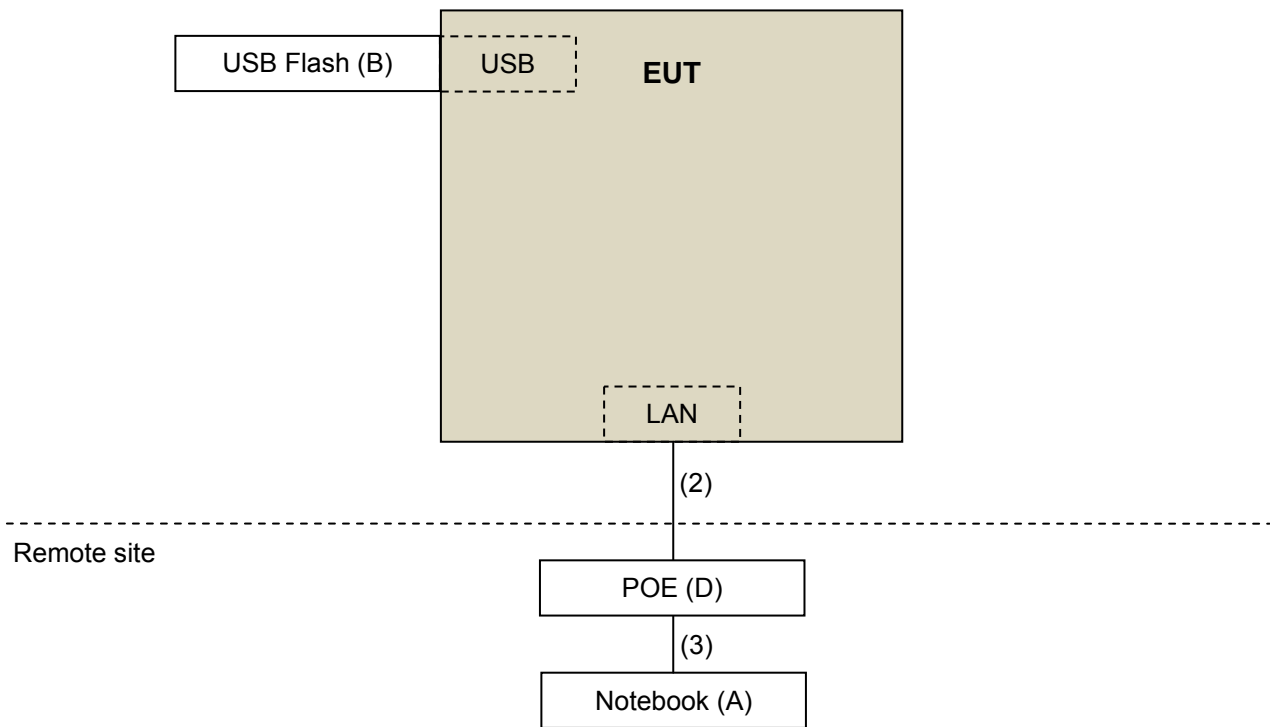

3.5 General Description of Applied Standards

The EUT is a RF Product. According to the specifications of the manufacturer, it must comply with the requirements of the following standards:

FCC Part 15, Subpart E (15.407)

KDB 789033 D02 General UNII Test Procedure New Rules v02r01

KDB 662911 D01 Multiple Transmitter Output v02r01

ANSI C63.10:2013

All test items have been performed and recorded as per the above standards.

4 Test Types and Results

4.1 Radiated Emission and Bandedge Measurement

4.1.1 Limits of Radiated Emission and Bandedge Measurement

Radiated emissions which fall in the restricted bands must comply with the radiated emission limits specified as below table.

| Frequencies (MHz) | Field Strength (microvolts/meter) | Measurement Distance (meters) |
|-------------------|-----------------------------------|-------------------------------|
| 0.009 ~ 0.490 | 2400/F(kHz) | 300 |
| 0.490 ~ 1.705 | 24000/F(kHz) | 30 |
| 1.705 ~ 30.0 | 30 | 30 |
| 30 ~ 88 | 100 | 3 |
| 88 ~ 216 | 150 | 3 |
| 216 ~ 960 | 200 | 3 |
| Above 960 | 500 | 3 |

Note:

1. The lower limit shall apply at the transition frequencies.
2. Emission level (dBuV/m) = 20 log Emission level (uV/m).
3. For frequencies above 1000MHz, the field strength limits are based on average detector, however, the peak field strength of any emission shall not exceed the maximum permitted average limits, specified above by more than 20dB under any condition of modulation.

Limits of unwanted emission out of the restricted bands

| Applicable To | | Limit | |
|--|---|---|---|
| 789033 D02 General UNII Test Procedure New Rules v02r01 | | Field Strength at 3m | |
| | | PK: 74 (dBuV/m) | AV: 54 (dBuV/m) |
| Frequency Band | Applicable To | EIRP Limit | Equivalent Field Strength at 3m |
| 5150~5250 MHz | 15.407(b)(1) | PK: -27 (dBm/MHz) | PK: 68.2(dBuV/m) |
| 5250~5350 MHz | 15.407(b)(2) | | |
| 5470~5725 MHz | 15.407(b)(3) | | |
| 5725~5850 MHz | <input checked="" type="checkbox"/> 15.407(b)(4)(i) | PK: -27 (dBm/MHz) ^{*1} PK: 10 (dBm/MHz) ^{*2} PK: 15.6 (dBm/MHz) ^{*3} PK: 27 (dBm/MHz) ^{*4} | PK: 68.2(dBuV/m) ^{*1} PK: 105.2 (dBuV/m) ^{*2} PK: 110.8(dBuV/m) ^{*3} PK: 122.2 (dBuV/m) ^{*4} |
| | <input type="checkbox"/> 15.407(b)(4)(ii) | Emission limits in section 15.247(d) | |
| ^{*1} beyond 75 MHz or more above of the band edge. | | ^{*2} below the band edge increasing linearly to 10 dBm/MHz at 25 MHz above. | |
| ^{*3} below the band edge increasing linearly to a level of 15.6 dBm/MHz at 5 MHz above. | | ^{*4} from 5 MHz above or below the band edge increasing linearly to a level of 27 dBm/MHz at the band edge. | |

Note: The following formula is used to convert the equipment isotropic radiated power (eirp) to field strength:

$$E = \frac{1000000 \sqrt{30P}}{3} \mu\text{V/m, where P is the eirp (Watts).}$$

4.1.2 Test Instruments

| Description & Manufacturer | Model No. | Serial No. | Cal. Date | Cal. Due |
|--|---------------------------------------|---------------------------------|---------------|---------------|
| Test Receiver ROHDE & SCHWARZ | ESIB7 | 100187 | May 02, 2017 | May 01, 2018 |
| Spectrum Analyzer ROHDE & SCHWARZ | FSP40 | 100041 | Dec. 12, 2017 | Dec. 11, 2018 |
| BILOG Antenna SCHWARZBECK | VULB9168 | 9168-171 | Dec. 11, 2017 | Dec. 10, 2018 |
| HORN Antenna SCHWARZBECK | 9120D | 209 | Dec. 13, 2017 | Dec. 12, 2018 |
| HORN Antenna SCHWARZBECK | BBHA 9170 | BBHA9170241 | Dec. 01, 2017 | Nov. 30, 2018 |
| Loop Antenna EMCI | EM-6879 | 269 | Aug. 11, 2017 | Aug. 10, 2018 |
| Preamplifier Agilent (Below 1GHz) | 8447D | 2944A10738 | Aug. 21, 2017 | Aug. 20, 2018 |
| Preamplifier Agilent (Above 1GHz) | 8449B | 3008A01976 | Aug. 21, 2017 | Aug. 20, 2018 |
| RF signal cable HUBER+SUHNER | SUCOFLEX 104 | Cable-CH3-03 (223653/4) | Aug. 21, 2017 | Aug. 20, 2018 |
| RF signal cable HUBER+SUHNER& EMCI | SUCOFLEX 104&EMC104-SM-SM-8 000 | Cable-CH3-03 (309224+170907) | Sep.11, 2017 | Sep. 10, 2018 |
| Software BV ADT | ADT_Radiated_ V7.6.15.9.4 | NA | NA | NA |
| Antenna Tower inn-co GmbH | MA 4000 | 013303 | NA | NA |
| Antenna Tower Controller BV ADT | AT100 | AT93021702 | NA | NA |
| Turn Table BV ADT | TT100 | TT93021702 | NA | NA |
| Turn Table Controller BV ADT | SC100 | SC93021702 | NA | NA |
| Boresight Antenna Fixture | FBA-01 | FBA-SIP01 | NA | NA |
| 26GHz ~ 40GHz Amplifier Agilent | 8449B | 3008A1960 | Aug. 08, 2017 | Aug. 07, 2018 |
| High Speed Peak Power Meter | ML2495A | 0824012 | Aug. 18, 2017 | Aug. 17, 2018 |
| Power Sensor | MA2411B | 0738171 | Aug. 18, 2017 | Aug. 17, 2018 |

- Note:
1. The calibration interval of the above test instruments is 12 months and the calibrations are traceable to NML/ROC and NIST/USA.
 2. The test was performed in HwaYa Chamber 3.
 3. The horn antenna and preamplifier (model: 8449B) are used only for the measurement of emission frequency above 1GHz if tested.
 4. The FCC Designation Number is TW0003. The number will be varied with the Lab location and scope as attached.
 5. The IC Site Registration No. is IC 7450F-3.

4.1.3 Test Procedures

For Radiated emission below 30MHz

- a. The EUT was placed on the top of a rotating table 0.8 meters above the ground at a 3 meter chamber room. The table was rotated 360 degrees to determine the position of the highest radiation.
- b. The EUT was set 3 meters away from the interference-receiving antenna, which was mounted on the top of a variable-height antenna tower.
- c. Parallel, perpendicular, and ground-parallel orientations of the antenna are set to make the measurement.
- d. For each suspected emission, the EUT was arranged to its worst case and the rotatable table was turned from 0 degrees to 360 degrees to find the maximum reading.
- e. The test-receiver system was set to Quasi-Peak Detect Function and Specified Bandwidth with Maximum Hold Mode.

Note:

1. The resolution bandwidth and video bandwidth of test receiver/spectrum analyzer is 9kHz at frequency below 30MHz.

For Radiated emission above 30MHz

- a. The EUT was placed on the top of a rotating table 0.8 meters (for 30MHz ~ 1GHz) / 1.5 meters (for above 1GHz) above the ground at 3 meter chamber room for test. The table was rotated 360 degrees to determine the position of the highest radiation.
- b. The EUT was set 3 meters away from the interference-receiving antenna, which was mounted on the top of a variable-height antenna tower.
- c. The height of antenna is varied from one meter to four meters above the ground to determine the maximum value of the field strength. Both horizontal and vertical polarizations of the antenna are set to make the measurement.
- d. For each suspected emission, the EUT was arranged to its worst case and then the antenna was tuned to heights from 1 meter to 4 meters and the rotatable table was turned from 0 degrees to 360 degrees to find the maximum reading.
- e. The test-receiver system was set to quasi-peak detect function and specified bandwidth with maximum hold mode when the test frequency is below 1 GHz.
- f. The test-receiver system was set to peak and average detect function and specified bandwidth with maximum hold mode when the test frequency is above 1 GHz. If the peak reading value also meets average limit, measurement with the average detector is unnecessary.

Note:

1. The resolution bandwidth and video bandwidth of test receiver/spectrum analyzer is 120kHz for Quasi-peak detection (QP) at frequency below 1GHz.
2. The resolution bandwidth of test receiver/spectrum analyzer is 1 MHz and the video bandwidth is 3 MHz for Peak detection (PK) at frequency above 1GHz.
3. The resolution bandwidth of test receiver/spectrum analyzer is 1MHz and the video bandwidth is $\geq 1/T$ (Duty cycle < 98%) or 10Hz (Duty cycle $\geq 98\%$) for Average detection (AV) at frequency above 1GHz.
4. All modes of operation were investigated and the worst-case emissions are reported.

4.1.4 Deviation from Test Standard

No deviation.

4.1.5 Test Setup

For Radiated emission below 30MHz

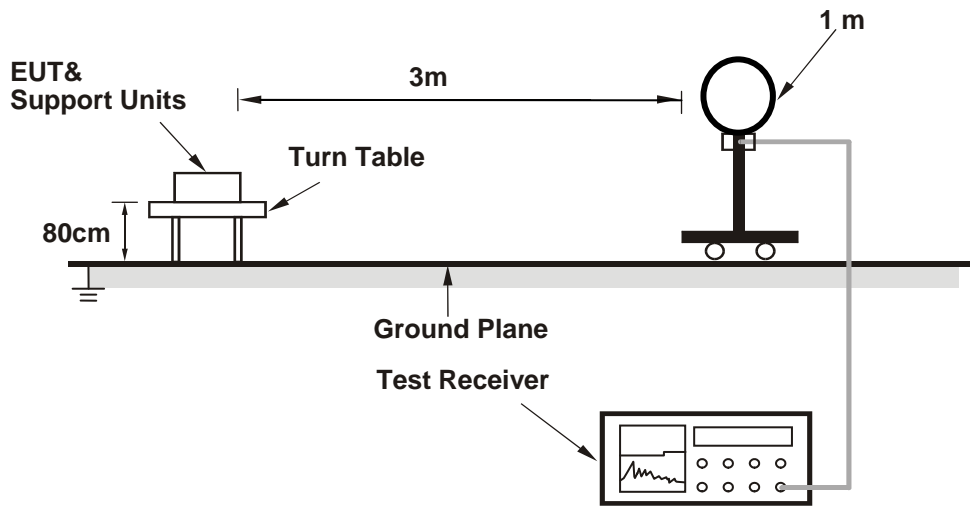

For Radiated emission 30MHz to 1GHz

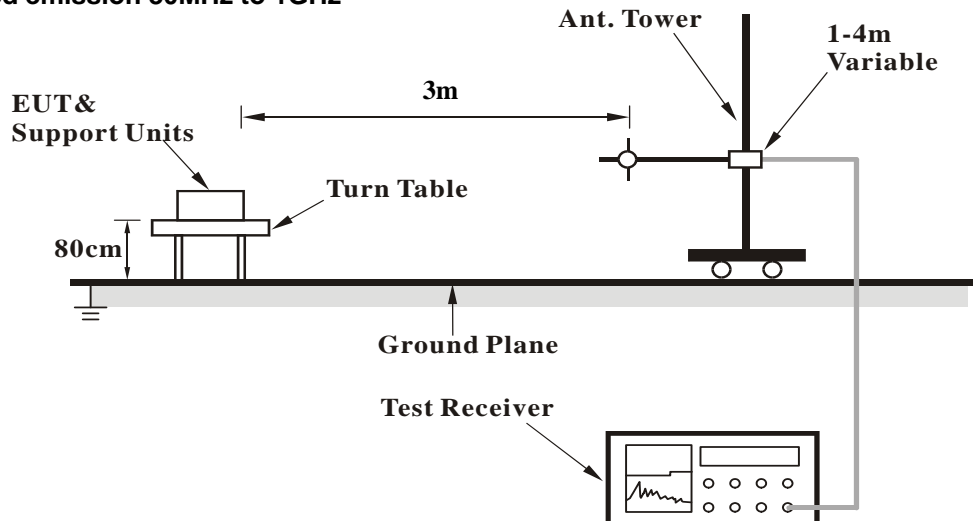

For Radiated emission above 1GHz

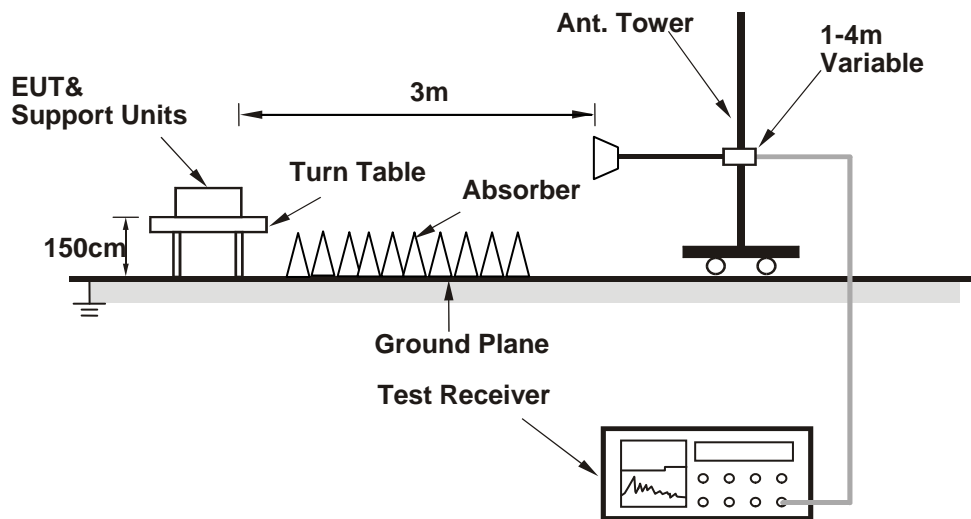

For the actual test configuration, please refer to the attached file (Test Setup Photo).

4.1.6 EUT Operating Conditions

- a. Placed the EUT on the testing table.
- b. Prepared a notebook to act as a communication partner and placed it outside of testing area.
- c. The communication partner connected with EUT via a RJ45 cable and ran a test program (provided by manufacturer) to enable EUT under transmission condition continuously at specific channel frequency.
- d. The communication partner sent data to EUT by command "PING".

4.1.7 Test Results

Above 1GHz data:

802.11a

| | | | |
|-----------------|---------------|----------|--------------|
| CHANNEL | TX Channel 36 | DETECTOR | Peak (PK) |
| FREQUENCY RANGE | 1GHz ~ 40GHz | FUNCTION | Average (AV) |

| ANTENNA POLARITY & TEST DISTANCE: HORIZONTAL AT 3 M | | | | | | | | |
|---|-------------|-------------------------|----------------|-------------|--------------------|----------------------|------------------|--------------------------|
| NO. | FREQ. (MHz) | EMISSION LEVEL (dBuV/m) | LIMIT (dBuV/m) | MARGIN (dB) | ANTENNA HEIGHT (m) | TABLE ANGLE (Degree) | RAW VALUE (dBuV) | CORRECTION FACTOR (dB/m) |
| 1 | 5150.00 | 71.4 PK | 74.0 | -2.6 | 1.86 H | 283 | 67.7 | 3.7 |
| 2 | 5150.00 | 52.6 AV | 54.0 | -1.4 | 1.86 H | 283 | 48.9 | 3.7 |
| 3 | *5180.00 | 118.8 PK | | | 1.84 H | 283 | 79.2 | 39.6 |
| 4 | *5180.00 | 108.1 AV | | | 1.84 H | 283 | 68.5 | 39.6 |
| 5 | #10360.00 | 58.5 PK | 74.0 | -15.5 | 2.23 H | 151 | 42.9 | 15.6 |
| 6 | #10360.00 | 45.0 AV | 54.0 | -9.0 | 2.23 H | 151 | 29.4 | 15.6 |
| ANTENNA POLARITY & TEST DISTANCE: VERTICAL AT 3 M | | | | | | | | |
| NO. | FREQ. (MHz) | EMISSION LEVEL (dBuV/m) | LIMIT (dBuV/m) | MARGIN (dB) | ANTENNA HEIGHT (m) | TABLE ANGLE (Degree) | RAW VALUE (dBuV) | CORRECTION FACTOR (dB/m) |
| 1 | 5150.00 | 69.0 PK | 74.0 | -5.0 | 1.64 V | 330 | 65.3 | 3.7 |
| 2 | 5150.00 | 49.5 AV | 54.0 | -4.5 | 1.64 V | 330 | 45.8 | 3.7 |
| 3 | *5180.00 | 116.8 PK | | | 1.46 V | 359 | 77.2 | 39.6 |
| 4 | *5180.00 | 106.0 AV | | | 1.46 V | 359 | 66.4 | 39.6 |
| 5 | #10360.00 | 57.6 PK | 74.0 | -16.4 | 1.80 V | 266 | 42.0 | 15.6 |
| 6 | #10360.00 | 44.7 AV | 54.0 | -9.3 | 1.80 V | 266 | 29.1 | 15.6 |

Remarks:

1. Emission Level(dBuV/m) = Raw Value(dBuV) + Correction Factor(dB/m)
2. Correction Factor(dB/m) = Antenna Factor(dB/m) + Cable Factor(dB) – Pre-Amplifier Factor(dB)
3. The other emission levels were very low against the limit.
4. Margin value = Emission Level – Limit value
5. " * ": Fundamental frequency.
6. " # ": The radiated frequency is out of the restricted band.

| | | | |
|-----------------|---------------|----------------------|--------------|
| CHANNEL | TX Channel 40 | DETECTOR FUNCTION | Peak (PK) |
| FREQUENCY RANGE | 1GHz ~ 40GHz | | Average (AV) |

| ANTENNA POLARITY & TEST DISTANCE: HORIZONTAL AT 3 M | | | | | | | | |
|---|----------------|-------------------------------|-------------------|----------------|--------------------------|----------------------------|------------------------|--------------------------------|
| NO. | FREQ. (MHz) | EMISSION LEVEL (dBuV/m) | LIMIT (dBuV/m) | MARGIN (dB) | ANTENNA HEIGHT (m) | TABLE ANGLE (Degree) | RAW VALUE (dBuV) | CORRECTION FACTOR (dB/m) |
| 1 | *5200.00 | 122.1 PK | | | 2.54 H | 301 | 82.5 | 39.6 |
| 2 | *5200.00 | 111.4 AV | | | 2.54 H | 301 | 71.8 | 39.6 |
| 3 | #10400.00 | 58.1 PK | 74.0 | -15.9 | 1.93 H | 166 | 42.5 | 15.6 |
| 4 | #10400.00 | 44.9 AV | 54.0 | -9.1 | 1.93 H | 166 | 29.3 | 15.6 |
| ANTENNA POLARITY & TEST DISTANCE: VERTICAL AT 3 M | | | | | | | | |
| NO. | FREQ. (MHz) | EMISSION LEVEL (dBuV/m) | LIMIT (dBuV/m) | MARGIN (dB) | ANTENNA HEIGHT (m) | TABLE ANGLE (Degree) | RAW VALUE (dBuV) | CORRECTION FACTOR (dB/m) |
| 1 | *5200.00 | 119.7 PK | | | 1.42 V | 351 | 80.1 | 39.6 |
| 2 | *5200.00 | 109.0 AV | | | 1.42 V | 351 | 69.4 | 39.6 |
| 3 | #10400.00 | 57.7 PK | 74.0 | -16.3 | 1.93 V | 278 | 42.1 | 15.6 |
| 4 | #10400.00 | 44.3 AV | 54.0 | -9.7 | 1.93 V | 278 | 28.7 | 15.6 |

Remarks:

1. Emission Level(dBuV/m) = Raw Value(dBuV) + Correction Factor(dB/m)
2. Correction Factor(dB/m) = Antenna Factor(dB/m) + Cable Factor(dB) – Pre-Amplifier Factor(dB)
3. The other emission levels were very low against the limit.
4. Margin value = Emission Level – Limit value
5. " * ": Fundamental frequency.
6. " # ": The radiated frequency is out of the restricted band.

| | | | |
|-----------------|---------------|-------------------|--------------|
| CHANNEL | TX Channel 48 | DETECTOR FUNCTION | Peak (PK) |
| FREQUENCY RANGE | 1GHz ~ 40GHz | | Average (AV) |

| ANTENNA POLARITY & TEST DISTANCE: HORIZONTAL AT 3 M | | | | | | | | |
|---|-------------|-------------------------|----------------|-------------|--------------------|----------------------|------------------|--------------------------|
| NO. | FREQ. (MHz) | EMISSION LEVEL (dBuV/m) | LIMIT (dBuV/m) | MARGIN (dB) | ANTENNA HEIGHT (m) | TABLE ANGLE (Degree) | RAW VALUE (dBuV) | CORRECTION FACTOR (dB/m) |
| 1 | *5240.00 | 121.2 PK | | | 2.59 H | 295 | 81.8 | 39.4 |
| 2 | *5240.00 | 110.9 AV | | | 2.59 H | 295 | 71.5 | 39.4 |
| 3 | 5350.00 | 57.7 PK | 74.0 | -16.3 | 2.31 H | 289 | 53.9 | 3.8 |
| 4 | 5350.00 | 44.7 AV | 54.0 | -9.3 | 2.31 H | 289 | 40.9 | 3.8 |
| 5 | #10480.00 | 57.7 PK | 74.0 | -16.3 | 2.19 H | 193 | 41.1 | 16.6 |
| 6 | #10480.00 | 44.4 AV | 54.0 | -9.6 | 2.19 H | 193 | 27.8 | 16.6 |

| ANTENNA POLARITY & TEST DISTANCE: VERTICAL AT 3 M | | | | | | | | |
|---|-------------|-------------------------|----------------|-------------|--------------------|----------------------|------------------|--------------------------|
| NO. | FREQ. (MHz) | EMISSION LEVEL (dBuV/m) | LIMIT (dBuV/m) | MARGIN (dB) | ANTENNA HEIGHT (m) | TABLE ANGLE (Degree) | RAW VALUE (dBuV) | CORRECTION FACTOR (dB/m) |
| 1 | *5240.00 | 119.9 PK | | | 1.40 V | 353 | 80.5 | 39.4 |
| 2 | *5240.00 | 109.6 AV | | | 1.40 V | 353 | 70.2 | 39.4 |
| 3 | 5350.00 | 56.3 PK | 74.0 | -17.7 | 1.51 V | 344 | 52.5 | 3.8 |
| 4 | 5350.00 | 42.8 AV | 54.0 | -11.2 | 1.51 V | 344 | 39.0 | 3.8 |
| 5 | #10480.00 | 57.6 PK | 74.0 | -16.4 | 2.13 V | 261 | 41.0 | 16.6 |
| 6 | #10480.00 | 44.1 AV | 54.0 | -9.9 | 2.13 V | 261 | 27.5 | 16.6 |

Remarks:

1. Emission Level(dBuV/m) = Raw Value(dBuV) + Correction Factor(dB/m)
2. Correction Factor(dB/m) = Antenna Factor(dB/m) + Cable Factor(dB) – Pre-Amplifier Factor(dB)
3. The other emission levels were very low against the limit.
4. Margin value = Emission Level – Limit value
5. " * ": Fundamental frequency.
6. " # ": The radiated frequency is out of the restricted band.

| | | | |
|-----------------|----------------|----------------------|--------------|
| CHANNEL | TX Channel 149 | DETECTOR FUNCTION | Peak (PK) |
| FREQUENCY RANGE | 1GHz ~ 40GHz | | Average (AV) |

| ANTENNA POLARITY & TEST DISTANCE: HORIZONTAL AT 3 M | | | | | | | | |
|---|----------------|-------------------------------|-------------------|----------------|--------------------------|----------------------------|------------------------|--------------------------------|
| NO. | FREQ. (MHz) | EMISSION LEVEL (dBuV/m) | LIMIT (dBuV/m) | MARGIN (dB) | ANTENNA HEIGHT (m) | TABLE ANGLE (Degree) | RAW VALUE (dBuV) | CORRECTION FACTOR (dB/m) |
| 1 | #5642.40 | 56.1 PK | 68.2 | -12.1 | 2.51 H | 302 | 51.8 | 4.3 |
| 2 | *5745.00 | 122.2 PK | | | 2.51 H | 302 | 82.1 | 40.1 |
| 3 | *5745.00 | 111.3 AV | | | 2.51 H | 302 | 71.2 | 40.1 |
| 4 | #5934.40 | 58.0 PK | 68.2 | -10.2 | 2.51 H | 302 | 53.0 | 5.0 |
| 5 | 11490.00 | 62.0 PK | 74.0 | -12.0 | 1.78 H | 201 | 44.2 | 17.8 |
| 6 | 11490.00 | 47.2 AV | 54.0 | -6.8 | 1.78 H | 201 | 29.4 | 17.8 |

| ANTENNA POLARITY & TEST DISTANCE: VERTICAL AT 3 M | | | | | | | | |
|---|----------------|-------------------------------|-------------------|----------------|--------------------------|----------------------------|------------------------|--------------------------------|
| NO. | FREQ. (MHz) | EMISSION LEVEL (dBuV/m) | LIMIT (dBuV/m) | MARGIN (dB) | ANTENNA HEIGHT (m) | TABLE ANGLE (Degree) | RAW VALUE (dBuV) | CORRECTION FACTOR (dB/m) |
| 1 | #5612.80 | 55.6 PK | 68.2 | -12.6 | 3.74 V | 328 | 51.4 | 4.2 |
| 2 | *5745.00 | 119.4 PK | | | 3.74 V | 328 | 79.3 | 40.1 |
| 3 | *5745.00 | 108.9 AV | | | 3.74 V | 328 | 68.8 | 40.1 |
| 4 | #5955.20 | 57.2 PK | 68.2 | -11.0 | 3.74 V | 328 | 52.2 | 5.0 |
| 5 | 11490.00 | 61.0 PK | 74.0 | -13.0 | 2.18 V | 188 | 43.2 | 17.8 |
| 6 | 11490.00 | 47.5 AV | 54.0 | -6.5 | 2.18 V | 188 | 29.7 | 17.8 |

Remarks:

1. Emission Level(dBuV/m) = Raw Value(dBuV) + Correction Factor(dB/m)
2. Correction Factor(dB/m) = Antenna Factor(dB/m) + Cable Factor(dB) – Pre-Amplifier Factor(dB)
3. The other emission levels were very low against the limit.
4. Margin value = Emission Level – Limit value
5. " * ": Fundamental frequency.
6. " # ": The radiated frequency is out of the restricted band.

| | | | |
|-----------------|----------------|-------------------|--------------|
| CHANNEL | TX Channel 157 | DETECTOR FUNCTION | Peak (PK) |
| FREQUENCY RANGE | 1GHz ~ 40GHz | | Average (AV) |

ANTENNA POLARITY & TEST DISTANCE: HORIZONTAL AT 3 M

| NO. | FREQ. (MHz) | EMISSION LEVEL (dBuV/m) | LIMIT (dBuV/m) | MARGIN (dB) | ANTENNA HEIGHT (m) | TABLE ANGLE (Degree) | RAW VALUE (dBuV) | CORRECTION FACTOR (dB/m) |
|-----|-------------|-------------------------|----------------|-------------|--------------------|----------------------|------------------|--------------------------|
| 1 | #5613.60 | 55.9 PK | 68.2 | -12.3 | 2.43 H | 295 | 51.7 | 4.2 |
| 2 | *5785.00 | 122.2 PK | | | 2.43 H | 295 | 81.9 | 40.3 |
| 3 | *5785.00 | 111.2 AV | | | 2.43 H | 295 | 70.9 | 40.3 |
| 4 | #5971.20 | 57.8 PK | 68.2 | -10.4 | 2.43 H | 295 | 52.8 | 5.0 |
| 5 | 11570.00 | 62.8 PK | 74.0 | -11.2 | 1.71 H | 354 | 44.7 | 18.1 |
| 6 | 11570.00 | 48.6 AV | 54.0 | -5.4 | 1.71 H | 354 | 30.5 | 18.1 |

ANTENNA POLARITY & TEST DISTANCE: VERTICAL AT 3 M

| NO. | FREQ. (MHz) | EMISSION LEVEL (dBuV/m) | LIMIT (dBuV/m) | MARGIN (dB) | ANTENNA HEIGHT (m) | TABLE ANGLE (Degree) | RAW VALUE (dBuV) | CORRECTION FACTOR (dB/m) |
|-----|-------------|-------------------------|----------------|-------------|--------------------|----------------------|------------------|--------------------------|
| 1 | #5617.60 | 56.2 PK | 68.2 | -12.0 | 3.87 V | 320 | 52.0 | 4.2 |
| 2 | *5785.00 | 119.5 PK | | | 3.87 V | 320 | 79.2 | 40.3 |
| 3 | *5785.00 | 108.9 AV | | | 3.87 V | 320 | 68.6 | 40.3 |
| 4 | #5947.20 | 57.4 PK | 68.2 | -10.8 | 3.87 V | 320 | 52.4 | 5.0 |
| 5 | 11570.00 | 60.9 PK | 74.0 | -13.1 | 1.69 V | 186 | 42.8 | 18.1 |
| 6 | 11570.00 | 47.3 AV | 54.0 | -6.7 | 1.69 V | 186 | 29.2 | 18.1 |

Remarks:

1. Emission Level(dBuV/m) = Raw Value(dBuV) + Correction Factor(dB/m)
2. Correction Factor(dB/m) = Antenna Factor(dB/m) + Cable Factor(dB) – Pre-Amplifier Factor(dB)
3. The other emission levels were very low against the limit.
4. Margin value = Emission Level – Limit value
5. " * ": Fundamental frequency.
6. " # ": The radiated frequency is out of the restricted band.

| | | | |
|-----------------|----------------|-------------------|--------------|
| CHANNEL | TX Channel 165 | DETECTOR FUNCTION | Peak (PK) |
| FREQUENCY RANGE | 1GHz ~ 40GHz | | Average (AV) |

| ANTENNA POLARITY & TEST DISTANCE: HORIZONTAL AT 3 M | | | | | | | | |
|---|-------------|-------------------------|----------------|-------------|--------------------|----------------------|------------------|--------------------------|
| NO. | FREQ. (MHz) | EMISSION LEVEL (dBuV/m) | LIMIT (dBuV/m) | MARGIN (dB) | ANTENNA HEIGHT (m) | TABLE ANGLE (Degree) | RAW VALUE (dBuV) | CORRECTION FACTOR (dB/m) |
| 1 | #5609.60 | 55.8 PK | 68.2 | -12.4 | 2.39 H | 292 | 51.6 | 4.2 |
| 2 | *5825.00 | 122.5 PK | | | 2.39 H | 292 | 82.0 | 40.5 |
| 3 | *5825.00 | 111.2 AV | | | 2.39 H | 292 | 70.7 | 40.5 |
| 4 | #5927.20 | 59.3 PK | 68.2 | -8.9 | 2.39 H | 292 | 54.4 | 4.9 |
| 5 | 11650.00 | 61.6 PK | 74.0 | -12.4 | 2.67 H | 9 | 43.9 | 17.7 |
| 6 | 11650.00 | 48.4 AV | 54.0 | -5.6 | 2.67 H | 9 | 30.7 | 17.7 |

| ANTENNA POLARITY & TEST DISTANCE: VERTICAL AT 3 M | | | | | | | | |
|---|-------------|-------------------------|----------------|-------------|--------------------|----------------------|------------------|--------------------------|
| NO. | FREQ. (MHz) | EMISSION LEVEL (dBuV/m) | LIMIT (dBuV/m) | MARGIN (dB) | ANTENNA HEIGHT (m) | TABLE ANGLE (Degree) | RAW VALUE (dBuV) | CORRECTION FACTOR (dB/m) |
| 1 | #5634.40 | 56.1 PK | 68.2 | -12.1 | 2.38 V | 334 | 51.9 | 4.2 |
| 2 | *5825.00 | 120.9 PK | | | 2.38 V | 334 | 80.4 | 40.5 |
| 3 | *5825.00 | 109.8 AV | | | 2.38 V | 334 | 69.3 | 40.5 |
| 4 | #5959.20 | 57.9 PK | 68.2 | -10.3 | 2.38 V | 334 | 52.9 | 5.0 |
| 5 | 11650.00 | 59.5 PK | 74.0 | -14.5 | 2.12 V | 188 | 41.8 | 17.7 |
| 6 | 11650.00 | 46.6 AV | 54.0 | -7.4 | 2.12 V | 188 | 28.9 | 17.7 |

Remarks:

1. Emission Level(dBuV/m) = Raw Value(dBuV) + Correction Factor(dB/m)
2. Correction Factor(dB/m) = Antenna Factor(dB/m) + Cable Factor(dB) – Pre-Amplifier Factor(dB)
3. The other emission levels were very low against the limit.
4. Margin value = Emission Level – Limit value
5. " * ": Fundamental frequency.
6. " # ": The radiated frequency is out of the restricted band.

802.11n (HT20)

| | | | |
|-----------------|---------------|----------------------|---------------------------|
| CHANNEL | TX Channel 36 | DETECTOR FUNCTION | Peak (PK) Average (AV) |
| FREQUENCY RANGE | 1GHz ~ 40GHz | | |

| ANTENNA POLARITY & TEST DISTANCE: HORIZONTAL AT 3 M | | | | | | | | |
|---|----------------|-------------------------------|-------------------|----------------|--------------------------|----------------------------|------------------------|--------------------------------|
| NO. | FREQ. (MHz) | EMISSION LEVEL (dBuV/m) | LIMIT (dBuV/m) | MARGIN (dB) | ANTENNA HEIGHT (m) | TABLE ANGLE (Degree) | RAW VALUE (dBuV) | CORRECTION FACTOR (dB/m) |
| 1 | 5150.00 | 70.3 PK | 74.0 | -3.7 | 1.78 H | 40 | 66.6 | 3.7 |
| 2 | 5150.00 | 52.4 AV | 54.0 | -1.6 | 1.78 H | 40 | 48.7 | 3.7 |
| 3 | *5180.00 | 119.4 PK | | | 1.73 H | 287 | 79.8 | 39.6 |
| 4 | *5180.00 | 108.2 AV | | | 1.73 H | 287 | 68.6 | 39.6 |
| 5 | #10360.00 | 58.2 PK | 74.0 | -15.8 | 2.11 H | 187 | 42.6 | 15.6 |
| 6 | #10360.00 | 44.7 AV | 54.0 | -9.3 | 2.11 H | 187 | 29.1 | 15.6 |
| ANTENNA POLARITY & TEST DISTANCE: VERTICAL AT 3 M | | | | | | | | |
| NO. | FREQ. (MHz) | EMISSION LEVEL (dBuV/m) | LIMIT (dBuV/m) | MARGIN (dB) | ANTENNA HEIGHT (m) | TABLE ANGLE (Degree) | RAW VALUE (dBuV) | CORRECTION FACTOR (dB/m) |
| 1 | 5150.00 | 68.6 PK | 74.0 | -5.4 | 1.54 V | 356 | 64.9 | 3.7 |
| 2 | 5150.00 | 50.6 AV | 54.0 | -3.4 | 1.54 V | 356 | 46.9 | 3.7 |
| 3 | *5180.00 | 117.4 PK | | | 1.41 V | 340 | 77.8 | 39.6 |
| 4 | *5180.00 | 106.3 AV | | | 1.41 V | 340 | 66.7 | 39.6 |
| 5 | #10360.00 | 57.6 PK | 74.0 | -16.4 | 1.83 V | 241 | 42.0 | 15.6 |
| 6 | #10360.00 | 44.1 AV | 54.0 | -9.9 | 1.83 V | 241 | 28.5 | 15.6 |

Remarks:

1. Emission Level(dBuV/m) = Raw Value(dBuV) + Correction Factor(dB/m)
2. Correction Factor(dB/m) = Antenna Factor(dB/m) + Cable Factor(dB) – Pre-Amplifier Factor(dB)
3. The other emission levels were very low against the limit.
4. Margin value = Emission Level – Limit value
5. " * ": Fundamental frequency.
6. " # ": The radiated frequency is out of the restricted band.

| | | | |
|-----------------|---------------|-------------------|--------------|
| CHANNEL | TX Channel 40 | DETECTOR FUNCTION | Peak (PK) |
| FREQUENCY RANGE | 1GHz ~ 40GHz | | Average (AV) |

ANTENNA POLARITY & TEST DISTANCE: HORIZONTAL AT 3 M

| NO. | FREQ. (MHz) | EMISSION LEVEL (dBuV/m) | LIMIT (dBuV/m) | MARGIN (dB) | ANTENNA HEIGHT (m) | TABLE ANGLE (Degree) | RAW VALUE (dBuV) | CORRECTION FACTOR (dB/m) |
|-----|-------------|-------------------------|----------------|-------------|--------------------|----------------------|------------------|--------------------------|
| 1 | *5200.00 | 122.2 PK | | | 1.77 H | 282 | 82.6 | 39.6 |
| 2 | *5200.00 | 111.2 AV | | | 1.77 H | 282 | 71.6 | 39.6 |
| 3 | #10400.00 | 58.2 PK | 74.0 | -15.8 | 2.22 H | 213 | 42.6 | 15.6 |
| 4 | #10400.00 | 44.5 AV | 54.0 | -9.5 | 2.22 H | 213 | 28.9 | 15.6 |

ANTENNA POLARITY & TEST DISTANCE: VERTICAL AT 3 M

| NO. | FREQ. (MHz) | EMISSION LEVEL (dBuV/m) | LIMIT (dBuV/m) | MARGIN (dB) | ANTENNA HEIGHT (m) | TABLE ANGLE (Degree) | RAW VALUE (dBuV) | CORRECTION FACTOR (dB/m) |
|-----|-------------|-------------------------|----------------|-------------|--------------------|----------------------|------------------|--------------------------|
| 1 | *5200.00 | 119.9 PK | | | 1.55 V | 337 | 80.3 | 39.6 |
| 2 | *5200.00 | 108.8 AV | | | 1.55 V | 337 | 69.2 | 39.6 |
| 3 | #10400.00 | 57.8 PK | 74.0 | -16.2 | 1.95 V | 234 | 42.2 | 15.6 |
| 4 | #10400.00 | 44.1 AV | 54.0 | -9.9 | 1.95 V | 234 | 28.5 | 15.6 |

Remarks:

1. Emission Level(dBuV/m) = Raw Value(dBuV) + Correction Factor(dB/m)
2. Correction Factor(dB/m) = Antenna Factor(dB/m) + Cable Factor(dB) – Pre-Amplifier Factor(dB)
3. The other emission levels were very low against the limit.
4. Margin value = Emission Level – Limit value
5. " * ": Fundamental frequency.
6. " # ": The radiated frequency is out of the restricted band.

| | | | |
|-----------------|---------------|-------------------|--------------|
| CHANNEL | TX Channel 48 | DETECTOR FUNCTION | Peak (PK) |
| FREQUENCY RANGE | 1GHz ~ 40GHz | | Average (AV) |

| ANTENNA POLARITY & TEST DISTANCE: HORIZONTAL AT 3 M | | | | | | | | |
|---|-------------|-------------------------|----------------|-------------|--------------------|----------------------|------------------|--------------------------|
| NO. | FREQ. (MHz) | EMISSION LEVEL (dBuV/m) | LIMIT (dBuV/m) | MARGIN (dB) | ANTENNA HEIGHT (m) | TABLE ANGLE (Degree) | RAW VALUE (dBuV) | CORRECTION FACTOR (dB/m) |
| 1 | *5240.00 | 121.9 PK | | | 1.78 H | 285 | 82.5 | 39.4 |
| 2 | *5240.00 | 111.0 AV | | | 1.78 H | 285 | 71.6 | 39.4 |
| 3 | 5350.00 | 56.5 PK | 74.0 | -17.5 | 1.91 H | 277 | 52.7 | 3.8 |
| 4 | 5350.00 | 44.1 AV | 54.0 | -9.9 | 1.91 H | 277 | 40.3 | 3.8 |
| 5 | #10480.00 | 57.4 PK | 74.0 | -16.6 | 1.87 H | 179 | 40.8 | 16.6 |
| 6 | #10480.00 | 44.3 AV | 54.0 | -9.7 | 1.87 H | 179 | 27.7 | 16.6 |
| ANTENNA POLARITY & TEST DISTANCE: VERTICAL AT 3 M | | | | | | | | |
| NO. | FREQ. (MHz) | EMISSION LEVEL (dBuV/m) | LIMIT (dBuV/m) | MARGIN (dB) | ANTENNA HEIGHT (m) | TABLE ANGLE (Degree) | RAW VALUE (dBuV) | CORRECTION FACTOR (dB/m) |
| 1 | *5240.00 | 119.8 PK | | | 1.54 V | 342 | 80.4 | 39.4 |
| 2 | *5240.00 | 108.8 AV | | | 1.54 V | 342 | 69.4 | 39.4 |
| 3 | 5350.00 | 55.8 PK | 74.0 | -18.2 | 1.61 V | 354 | 52.0 | 3.8 |
| 4 | 5350.00 | 42.6 AV | 54.0 | -11.4 | 1.61 V | 354 | 38.8 | 3.8 |
| 5 | #10480.00 | 57.6 PK | 74.0 | -16.4 | 1.79 V | 197 | 41.0 | 16.6 |
| 6 | #10480.00 | 44.1 AV | 54.0 | -9.9 | 1.79 V | 197 | 27.5 | 16.6 |

Remarks:

1. Emission Level(dBuV/m) = Raw Value(dBuV) + Correction Factor(dB/m)
2. Correction Factor(dB/m) = Antenna Factor(dB/m) + Cable Factor(dB) – Pre-Amplifier Factor(dB)
3. The other emission levels were very low against the limit.
4. Margin value = Emission Level – Limit value
5. " * ": Fundamental frequency.
6. " # ": The radiated frequency is out of the restricted band.

| | | | |
|-----------------|----------------|----------------------|--------------|
| CHANNEL | TX Channel 149 | DETECTOR FUNCTION | Peak (PK) |
| FREQUENCY RANGE | 1GHz ~ 40GHz | | Average (AV) |

| ANTENNA POLARITY & TEST DISTANCE: HORIZONTAL AT 3 M | | | | | | | | |
|---|----------------|-------------------------------|-------------------|----------------|--------------------------|----------------------------|------------------------|--------------------------------|
| NO. | FREQ. (MHz) | EMISSION LEVEL (dBuV/m) | LIMIT (dBuV/m) | MARGIN (dB) | ANTENNA HEIGHT (m) | TABLE ANGLE (Degree) | RAW VALUE (dBuV) | CORRECTION FACTOR (dB/m) |
| 1 | #5643.20 | 56.9 PK | 68.2 | -11.3 | 2.49 H | 298 | 52.6 | 4.3 |
| 2 | *5745.00 | 122.0 PK | | | 2.49 H | 298 | 81.9 | 40.1 |
| 3 | *5745.00 | 110.8 AV | | | 2.49 H | 298 | 70.7 | 40.1 |
| 4 | #5968.00 | 57.9 PK | 68.2 | -10.3 | 2.49 H | 298 | 52.9 | 5.0 |
| 5 | 11490.00 | 60.4 PK | 74.0 | -13.6 | 1.77 H | 212 | 42.6 | 17.8 |
| 6 | 11490.00 | 47.3 AV | 54.0 | -6.7 | 1.77 H | 212 | 29.5 | 17.8 |

| ANTENNA POLARITY & TEST DISTANCE: VERTICAL AT 3 M | | | | | | | | |
|---|----------------|-------------------------------|-------------------|----------------|--------------------------|----------------------------|------------------------|--------------------------------|
| NO. | FREQ. (MHz) | EMISSION LEVEL (dBuV/m) | LIMIT (dBuV/m) | MARGIN (dB) | ANTENNA HEIGHT (m) | TABLE ANGLE (Degree) | RAW VALUE (dBuV) | CORRECTION FACTOR (dB/m) |
| 1 | #5626.40 | 57.1 PK | 68.2 | -11.1 | 1.41 V | 12 | 52.9 | 4.2 |
| 2 | *5745.00 | 120.5 PK | | | 1.41 V | 12 | 80.4 | 40.1 |
| 3 | *5745.00 | 109.4 AV | | | 1.41 V | 12 | 69.3 | 40.1 |
| 4 | #5937.60 | 57.1 PK | 68.2 | -11.1 | 1.41 V | 12 | 52.2 | 4.9 |
| 5 | 11490.00 | 60.2 PK | 74.0 | -13.8 | 1.72 V | 293 | 42.4 | 17.8 |
| 6 | 11490.00 | 47.3 AV | 54.0 | -6.7 | 1.72 V | 293 | 29.5 | 17.8 |

Remarks:

1. Emission Level(dBuV/m) = Raw Value(dBuV) + Correction Factor(dB/m)
2. Correction Factor(dB/m) = Antenna Factor(dB/m) + Cable Factor(dB) – Pre-Amplifier Factor(dB)
3. The other emission levels were very low against the limit.
4. Margin value = Emission Level – Limit value
5. " * ": Fundamental frequency.
6. " # ": The radiated frequency is out of the restricted band.

| | | | |
|-----------------|----------------|----------------------|--------------|
| CHANNEL | TX Channel 157 | DETECTOR FUNCTION | Peak (PK) |
| FREQUENCY RANGE | 1GHz ~ 40GHz | | Average (AV) |

ANTENNA POLARITY & TEST DISTANCE: HORIZONTAL AT 3 M

| NO. | FREQ. (MHz) | EMISSION LEVEL (dBuV/m) | LIMIT (dBuV/m) | MARGIN (dB) | ANTENNA HEIGHT (m) | TABLE ANGLE (Degree) | RAW VALUE (dBuV) | CORRECTION FACTOR (dB/m) |
|-----|----------------|-------------------------------|-------------------|----------------|--------------------------|----------------------------|------------------------|--------------------------------|
| 1 | #5612.80 | 56.0 PK | 68.2 | -12.2 | 2.48 H | 285 | 51.8 | 4.2 |
| 2 | *5785.00 | 121.9 PK | | | 2.48 H | 285 | 81.6 | 40.3 |
| 3 | *5785.00 | 110.9 AV | | | 2.48 H | 285 | 70.6 | 40.3 |
| 4 | #5966.40 | 57.8 PK | 68.2 | -10.4 | 2.48 H | 285 | 52.8 | 5.0 |
| 5 | 11570.00 | 60.4 PK | 74.0 | -13.6 | 2.37 H | 189 | 42.3 | 18.1 |
| 6 | 11570.00 | 47.9 AV | 54.0 | -6.1 | 2.37 H | 189 | 29.8 | 18.1 |

ANTENNA POLARITY & TEST DISTANCE: VERTICAL AT 3 M

| NO. | FREQ. (MHz) | EMISSION LEVEL (dBuV/m) | LIMIT (dBuV/m) | MARGIN (dB) | ANTENNA HEIGHT (m) | TABLE ANGLE (Degree) | RAW VALUE (dBuV) | CORRECTION FACTOR (dB/m) |
|-----|----------------|-------------------------------|-------------------|----------------|--------------------------|----------------------------|------------------------|--------------------------------|
| 1 | #5624.00 | 56.0 PK | 68.2 | -12.2 | 1.29 V | 5 | 51.8 | 4.2 |
| 2 | *5785.00 | 120.7 PK | | | 1.29 V | 5 | 80.4 | 40.3 |
| 3 | *5785.00 | 109.4 AV | | | 1.29 V | 5 | 69.1 | 40.3 |
| 4 | #5962.40 | 57.8 PK | 68.2 | -10.4 | 1.29 V | 5 | 52.8 | 5.0 |
| 5 | 11570.00 | 60.0 PK | 74.0 | -14.0 | 1.99 V | 256 | 41.9 | 18.1 |
| 6 | 11570.00 | 47.2 AV | 54.0 | -6.8 | 1.99 V | 256 | 29.1 | 18.1 |

Remarks:

1. Emission Level(dBuV/m) = Raw Value(dBuV) + Correction Factor(dB/m)
2. Correction Factor(dB/m) = Antenna Factor(dB/m) + Cable Factor(dB) – Pre-Amplifier Factor(dB)
3. The other emission levels were very low against the limit.
4. Margin value = Emission Level – Limit value
5. " * ": Fundamental frequency.
6. " # ": The radiated frequency is out of the restricted band.

| | | | |
|-----------------|----------------|----------------------|--------------|
| CHANNEL | TX Channel 165 | DETECTOR FUNCTION | Peak (PK) |
| FREQUENCY RANGE | 1GHz ~ 40GHz | | Average (AV) |

| ANTENNA POLARITY & TEST DISTANCE: HORIZONTAL AT 3 M | | | | | | | | |
|---|----------------|-------------------------------|-------------------|----------------|--------------------------|----------------------------|------------------------|--------------------------------|
| NO. | FREQ. (MHz) | EMISSION LEVEL (dBuV/m) | LIMIT (dBuV/m) | MARGIN (dB) | ANTENNA HEIGHT (m) | TABLE ANGLE (Degree) | RAW VALUE (dBuV) | CORRECTION FACTOR (dB/m) |
| 1 | #5644.80 | 55.8 PK | 68.2 | -12.4 | 1.95 H | 291 | 51.5 | 4.3 |
| 2 | *5825.00 | 122.1 PK | | | 1.95 H | 291 | 81.6 | 40.5 |
| 3 | *5825.00 | 111.2 AV | | | 1.95 H | 291 | 70.7 | 40.5 |
| 4 | #5930.40 | 60.3 PK | 68.2 | -7.9 | 1.95 H | 291 | 55.3 | 5.0 |
| 5 | 11650.00 | 60.3 PK | 74.0 | -13.7 | 1.77 H | 213 | 42.6 | 17.7 |
| 6 | 11650.00 | 47.5 AV | 54.0 | -6.5 | 1.77 H | 213 | 29.8 | 17.7 |

| ANTENNA POLARITY & TEST DISTANCE: VERTICAL AT 3 M | | | | | | | | |
|---|----------------|-------------------------------|-------------------|----------------|--------------------------|----------------------------|------------------------|--------------------------------|
| NO. | FREQ. (MHz) | EMISSION LEVEL (dBuV/m) | LIMIT (dBuV/m) | MARGIN (dB) | ANTENNA HEIGHT (m) | TABLE ANGLE (Degree) | RAW VALUE (dBuV) | CORRECTION FACTOR (dB/m) |
| 1 | #5624.80 | 54.4 PK | 68.2 | -13.8 | 1.31 V | 10 | 50.2 | 4.2 |
| 2 | *5825.00 | 120.7 PK | | | 1.31 V | 10 | 80.2 | 40.5 |
| 3 | *5825.00 | 109.2 AV | | | 1.31 V | 10 | 68.7 | 40.5 |
| 4 | #5927.20 | 56.7 PK | 68.2 | -11.5 | 1.31 V | 10 | 51.8 | 4.9 |
| 5 | 11650.00 | 59.8 PK | 74.0 | -14.2 | 1.93 V | 303 | 42.1 | 17.7 |
| 6 | 11650.00 | 47.2 AV | 54.0 | -6.8 | 1.93 V | 303 | 29.5 | 17.7 |

Remarks:

1. Emission Level(dBuV/m) = Raw Value(dBuV) + Correction Factor(dB/m)
2. Correction Factor(dB/m) = Antenna Factor(dB/m) + Cable Factor(dB) – Pre-Amplifier Factor(dB)
3. The other emission levels were very low against the limit.
4. Margin value = Emission Level – Limit value
5. " * ": Fundamental frequency.
6. " # ": The radiated frequency is out of the restricted band.

802.11n (HT40)

| | | | |
|-----------------|---------------|----------|--------------|
| CHANNEL | TX Channel 38 | DETECTOR | Peak (PK) |
| FREQUENCY RANGE | 1GHz ~ 40GHz | FUNCTION | Average (AV) |

ANTENNA POLARITY & TEST DISTANCE: HORIZONTAL AT 3 M

| NO. | FREQ. (MHz) | EMISSION LEVEL (dBuV/m) | LIMIT (dBuV/m) | MARGIN (dB) | ANTENNA HEIGHT (m) | TABLE ANGLE (Degree) | RAW VALUE (dBuV) | CORRECTION FACTOR (dB/m) |
|-----|-------------|-------------------------|----------------|-------------|--------------------|----------------------|------------------|--------------------------|
| 1 | 5150.00 | 70.7 PK | 74.0 | -3.3 | 1.68 H | 286 | 67.0 | 3.7 |
| 2 | 5150.00 | 52.4 AV | 54.0 | -1.6 | 1.68 H | 286 | 48.7 | 3.7 |
| 3 | *5190.00 | 114.1 PK | | | 1.85 H | 278 | 74.5 | 39.6 |
| 4 | *5190.00 | 103.9 AV | | | 1.85 H | 278 | 64.3 | 39.6 |
| 5 | #10380.00 | 58.4 PK | 74.0 | -15.6 | 2.22 H | 203 | 42.8 | 15.6 |
| 6 | #10380.00 | 44.3 AV | 54.0 | -9.7 | 2.22 H | 203 | 28.7 | 15.6 |

ANTENNA POLARITY & TEST DISTANCE: VERTICAL AT 3 M

| NO. | FREQ. (MHz) | EMISSION LEVEL (dBuV/m) | LIMIT (dBuV/m) | MARGIN (dB) | ANTENNA HEIGHT (m) | TABLE ANGLE (Degree) | RAW VALUE (dBuV) | CORRECTION FACTOR (dB/m) |
|-----|-------------|-------------------------|----------------|-------------|--------------------|----------------------|------------------|--------------------------|
| 1 | 5150.00 | 68.0 PK | 74.0 | -6.0 | 1.45 V | 335 | 64.3 | 3.7 |
| 2 | 5150.00 | 50.4 AV | 54.0 | -3.6 | 1.45 V | 335 | 46.7 | 3.7 |
| 3 | *5190.00 | 112.0 PK | | | 1.51 V | 334 | 72.4 | 39.6 |
| 4 | *5190.00 | 101.8 AV | | | 1.51 V | 334 | 62.2 | 39.6 |
| 5 | #10380.00 | 57.9 PK | 74.0 | -16.1 | 2.21 V | 189 | 42.3 | 15.6 |
| 6 | #10380.00 | 43.8 AV | 54.0 | -10.2 | 2.21 V | 189 | 28.2 | 15.6 |

Remarks:

1. Emission Level(dBuV/m) = Raw Value(dBuV) + Correction Factor(dB/m)
2. Correction Factor(dB/m) = Antenna Factor(dB/m) + Cable Factor(dB) – Pre-Amplifier Factor(dB)
3. The other emission levels were very low against the limit.
4. Margin value = Emission Level – Limit value
5. " * ": Fundamental frequency.
6. " # ": The radiated frequency is out of the restricted band.

| | | | |
|-----------------|---------------|-------------------|--------------|
| CHANNEL | TX Channel 46 | DETECTOR FUNCTION | Peak (PK) |
| FREQUENCY RANGE | 1GHz ~ 40GHz | | Average (AV) |

| ANTENNA POLARITY & TEST DISTANCE: HORIZONTAL AT 3 M | | | | | | | | |
|---|-------------|-------------------------|----------------|-------------|--------------------|----------------------|------------------|--------------------------|
| NO. | FREQ. (MHz) | EMISSION LEVEL (dBuV/m) | LIMIT (dBuV/m) | MARGIN (dB) | ANTENNA HEIGHT (m) | TABLE ANGLE (Degree) | RAW VALUE (dBuV) | CORRECTION FACTOR (dB/m) |
| 1 | 5150.00 | 69.2 PK | 74.0 | -4.8 | 1.76 H | 288 | 65.5 | 3.7 |
| 2 | 5150.00 | 52.3 AV | 54.0 | -1.7 | 1.76 H | 288 | 48.6 | 3.7 |
| 3 | *5230.00 | 117.0 PK | | | 1.82 H | 283 | 77.6 | 39.4 |
| 4 | *5230.00 | 106.9 AV | | | 1.82 H | 283 | 67.5 | 39.4 |
| 5 | #10460.00 | 57.7 PK | 74.0 | -16.3 | 2.20 H | 199 | 41.5 | 16.2 |
| 6 | #10460.00 | 44.4 AV | 54.0 | -9.6 | 2.20 H | 199 | 28.2 | 16.2 |

| ANTENNA POLARITY & TEST DISTANCE: VERTICAL AT 3 M | | | | | | | | |
|---|-------------|-------------------------|----------------|-------------|--------------------|----------------------|------------------|--------------------------|
| NO. | FREQ. (MHz) | EMISSION LEVEL (dBuV/m) | LIMIT (dBuV/m) | MARGIN (dB) | ANTENNA HEIGHT (m) | TABLE ANGLE (Degree) | RAW VALUE (dBuV) | CORRECTION FACTOR (dB/m) |
| 1 | 5150.00 | 67.7 PK | 74.0 | -6.3 | 1.44 V | 332 | 64.0 | 3.7 |
| 2 | 5150.00 | 51.2 AV | 54.0 | -2.8 | 1.44 V | 332 | 47.5 | 3.7 |
| 3 | *5230.00 | 116.4 PK | | | 1.48 V | 358 | 77.0 | 39.4 |
| 4 | *5230.00 | 105.7 AV | | | 1.48 V | 358 | 66.3 | 39.4 |
| 5 | #10460.00 | 57.3 PK | 74.0 | -16.7 | 1.91 V | 263 | 41.1 | 16.2 |
| 6 | #10460.00 | 44.1 AV | 54.0 | -9.9 | 1.91 V | 263 | 27.9 | 16.2 |

Remarks:

1. Emission Level(dBuV/m) = Raw Value(dBuV) + Correction Factor(dB/m)
2. Correction Factor(dB/m) = Antenna Factor(dB/m) + Cable Factor(dB) – Pre-Amplifier Factor(dB)
3. The other emission levels were very low against the limit.
4. Margin value = Emission Level – Limit value
5. " * ": Fundamental frequency.
6. " # ": The radiated frequency is out of the restricted band.

| | | | |
|-----------------|----------------|----------------------|--------------|
| CHANNEL | TX Channel 151 | DETECTOR FUNCTION | Peak (PK) |
| FREQUENCY RANGE | 1GHz ~ 40GHz | | Average (AV) |

| ANTENNA POLARITY & TEST DISTANCE: HORIZONTAL AT 3 M | | | | | | | | |
|---|----------------|-------------------------------|-------------------|----------------|--------------------------|----------------------------|------------------------|--------------------------------|
| NO. | FREQ. (MHz) | EMISSION LEVEL (dBuV/m) | LIMIT (dBuV/m) | MARGIN (dB) | ANTENNA HEIGHT (m) | TABLE ANGLE (Degree) | RAW VALUE (dBuV) | CORRECTION FACTOR (dB/m) |
| 1 | #5649.60 | 64.4 PK | 68.2 | -3.8 | 2.21 H | 296 | 60.1 | 4.3 |
| 2 | #5650.00 | 66.5 PK | 68.2 | -1.7 | 2.46 H | 318 | 62.2 | 4.3 |
| 3 | *5755.00 | 118.7 PK | | | 2.21 H | 296 | 78.6 | 40.1 |
| 4 | *5755.00 | 108.4 AV | | | 2.21 H | 296 | 68.3 | 40.1 |
| 5 | #5930.40 | 58.3 PK | 68.2 | -9.9 | 2.21 H | 296 | 53.3 | 5.0 |
| 6 | 11510.00 | 60.6 PK | 74.0 | -13.4 | 2.22 H | 199 | 42.8 | 17.8 |
| 7 | 11510.00 | 47.3 AV | 54.0 | -6.7 | 2.22 H | 199 | 29.5 | 17.8 |

| ANTENNA POLARITY & TEST DISTANCE: VERTICAL AT 3 M | | | | | | | | |
|---|----------------|-------------------------------|-------------------|----------------|--------------------------|----------------------------|------------------------|--------------------------------|
| NO. | FREQ. (MHz) | EMISSION LEVEL (dBuV/m) | LIMIT (dBuV/m) | MARGIN (dB) | ANTENNA HEIGHT (m) | TABLE ANGLE (Degree) | RAW VALUE (dBuV) | CORRECTION FACTOR (dB/m) |
| 1 | #5648.00 | 63.3 PK | 68.2 | -4.9 | 1.28 V | 4 | 59.0 | 4.3 |
| 2 | #5650.00 | 66.3 PK | 68.2 | -1.9 | 1.46 V | 5 | 62.0 | 4.3 |
| 3 | *5755.00 | 117.3 PK | | | 1.28 V | 4 | 77.2 | 40.1 |
| 4 | *5755.00 | 106.9 AV | | | 1.28 V | 4 | 66.8 | 40.1 |
| 5 | #5932.80 | 58.9 PK | 68.2 | -9.3 | 1.28 V | 4 | 53.9 | 5.0 |
| 6 | 11510.00 | 60.1 PK | 74.0 | -13.9 | 2.21 V | 197 | 42.3 | 17.8 |
| 7 | 11510.00 | 46.9 AV | 54.0 | -7.1 | 2.21 V | 197 | 29.1 | 17.8 |

Remarks:

1. Emission Level(dBuV/m) = Raw Value(dBuV) + Correction Factor(dB/m)
2. Correction Factor(dB/m) = Antenna Factor(dB/m) + Cable Factor(dB) – Pre-Amplifier Factor(dB)
3. The other emission levels were very low against the limit.
4. Margin value = Emission Level – Limit value
5. " * ": Fundamental frequency.
6. " # ": The radiated frequency is out of the restricted band.

| | | | |
|-----------------|----------------|----------------------|--------------|
| CHANNEL | TX Channel 159 | DETECTOR FUNCTION | Peak (PK) |
| FREQUENCY RANGE | 1GHz ~ 40GHz | | Average (AV) |

| ANTENNA POLARITY & TEST DISTANCE: HORIZONTAL AT 3 M | | | | | | | | |
|---|-----------------|-------------------------------|-------------------|----------------|--------------------------|----------------------------|------------------------|--------------------------------|
| NO. | FREQ. (MHz) | EMISSION LEVEL (dBuV/m) | LIMIT (dBuV/m) | MARGIN (dB) | ANTENNA HEIGHT (m) | TABLE ANGLE (Degree) | RAW VALUE (dBuV) | CORRECTION FACTOR (dB/m) |
| 1 | #5636.80 | 58.6 PK | 68.2 | -9.6 | 2.29 H | 290 | 54.4 | 4.2 |
| 2 | *5795.00 | 119.3 PK | | | 2.29 H | 290 | 79.0 | 40.3 |
| 3 | *5795.00 | 108.7 AV | | | 2.29 H | 290 | 68.4 | 40.3 |
| 4 | #5925.00 | 66.9 PK | 68.2 | -1.3 | 2.35 H | 310 | 62.0 | 4.9 |
| 5 | #5936.00 | 62.8 PK | 68.2 | -5.4 | 2.29 H | 290 | 57.9 | 4.9 |
| 6 | 11590.00 | 60.7 PK | 74.0 | -13.3 | 1.89 H | 188 | 42.7 | 18.0 |
| 7 | 11590.00 | 47.6 AV | 54.0 | -6.4 | 1.89 H | 188 | 29.6 | 18.0 |

| ANTENNA POLARITY & TEST DISTANCE: VERTICAL AT 3 M | | | | | | | | |
|---|----------------|-------------------------------|-------------------|----------------|--------------------------|----------------------------|------------------------|--------------------------------|
| NO. | FREQ. (MHz) | EMISSION LEVEL (dBuV/m) | LIMIT (dBuV/m) | MARGIN (dB) | ANTENNA HEIGHT (m) | TABLE ANGLE (Degree) | RAW VALUE (dBuV) | CORRECTION FACTOR (dB/m) |
| 1 | #5632.80 | 55.9 PK | 68.2 | -12.3 | 1.59 V | 17 | 51.7 | 4.2 |
| 2 | *5795.00 | 116.7 PK | | | 1.59 V | 17 | 76.4 | 40.3 |
| 3 | *5795.00 | 106.3 AV | | | 1.59 V | 17 | 66.0 | 40.3 |
| 4 | #5925.00 | 64.9 PK | 68.2 | -3.3 | 1.66 V | 359 | 60.0 | 4.9 |
| 5 | #5934.40 | 63.0 PK | 68.2 | -5.2 | 1.59 V | 17 | 58.0 | 5.0 |
| 6 | 11590.00 | 60.2 PK | 74.0 | -13.8 | 1.87 V | 254 | 42.2 | 18.0 |
| 7 | 11590.00 | 47.2 AV | 54.0 | -6.8 | 1.87 V | 254 | 29.2 | 18.0 |

Remarks:

1. Emission Level(dBuV/m) = Raw Value(dBuV) + Correction Factor(dB/m)
2. Correction Factor(dB/m) = Antenna Factor(dB/m) + Cable Factor(dB) – Pre-Amplifier Factor(dB)
3. The other emission levels were very low against the limit.
4. Margin value = Emission Level – Limit value
5. " * ": Fundamental frequency.
6. " # ": The radiated frequency is out of the restricted band.

802.11ac (VHT80)

| | | | |
|-----------------|---------------|----------------------|--------------|
| CHANNEL | TX Channel 42 | DETECTOR FUNCTION | Peak (PK) |
| FREQUENCY RANGE | 1GHz ~ 40GHz | | Average (AV) |

ANTENNA POLARITY & TEST DISTANCE: HORIZONTAL AT 3 M

| NO. | FREQ. (MHz) | EMISSION LEVEL (dBuV/m) | LIMIT (dBuV/m) | MARGIN (dB) | ANTENNA HEIGHT (m) | TABLE ANGLE (Degree) | RAW VALUE (dBuV) | CORRECTION FACTOR (dB/m) |
|-----|----------------|-------------------------------|-------------------|----------------|--------------------------|----------------------------|------------------------|--------------------------------|
| 1 | 5150.00 | 68.2 PK | 74.0 | -5.8 | 1.99 H | 288 | 64.5 | 3.7 |
| 2 | 5150.00 | 52.7 AV | 54.0 | -1.3 | 1.99 H | 288 | 49.0 | 3.7 |
| 3 | *5210.00 | 110.3 PK | | | 2.70 H | 298 | 70.8 | 39.5 |
| 4 | *5210.00 | 99.7 AV | | | 2.70 H | 298 | 60.2 | 39.5 |
| 5 | 5350.00 | 59.2 PK | 74.0 | -14.8 | 2.25 H | 286 | 55.4 | 3.8 |
| 6 | 5350.00 | 45.6 AV | 54.0 | -8.4 | 2.25 H | 286 | 41.8 | 3.8 |
| 7 | #10420.00 | 57.8 PK | 74.0 | -16.2 | 1.87 H | 193 | 42.0 | 15.8 |
| 8 | #10420.00 | 44.5 AV | 54.0 | -9.5 | 1.87 H | 193 | 28.7 | 15.8 |

ANTENNA POLARITY & TEST DISTANCE: VERTICAL AT 3 M

| NO. | FREQ. (MHz) | EMISSION LEVEL (dBuV/m) | LIMIT (dBuV/m) | MARGIN (dB) | ANTENNA HEIGHT (m) | TABLE ANGLE (Degree) | RAW VALUE (dBuV) | CORRECTION FACTOR (dB/m) |
|-----|----------------|-------------------------------|-------------------|----------------|--------------------------|----------------------------|------------------------|--------------------------------|
| 1 | 5150.00 | 65.0 PK | 74.0 | -9.0 | 1.58 V | 337 | 61.3 | 3.7 |
| 2 | 5150.00 | 51.5 AV | 54.0 | -2.5 | 1.58 V | 337 | 47.8 | 3.7 |
| 3 | *5210.00 | 108.5 PK | | | 1.47 V | 359 | 69.0 | 39.5 |
| 4 | *5210.00 | 98.5 AV | | | 1.47 V | 359 | 59.0 | 39.5 |
| 5 | 5350.00 | 58.0 PK | 74.0 | -16.0 | 1.27 V | 354 | 54.2 | 3.8 |
| 6 | 5350.00 | 45.1 AV | 54.0 | -8.9 | 1.27 V | 354 | 41.3 | 3.8 |
| 7 | #10420.00 | 57.4 PK | 74.0 | -16.6 | 1.88 V | 209 | 41.6 | 15.8 |
| 8 | #10420.00 | 44.1 AV | 54.0 | -9.9 | 1.88 V | 209 | 28.3 | 15.8 |

Remarks:

1. Emission Level(dBuV/m) = Raw Value(dBuV) + Correction Factor(dB/m)
2. Correction Factor(dB/m) = Antenna Factor(dB/m) + Cable Factor(dB) – Pre-Amplifier Factor(dB)
3. The other emission levels were very low against the limit.
4. Margin value = Emission Level – Limit value
5. " * ": Fundamental frequency.
6. " # ": The radiated frequency is out of the restricted band.

| | | | |
|-----------------|----------------|----------------------|--------------|
| CHANNEL | TX Channel 155 | DETECTOR FUNCTION | Peak (PK) |
| FREQUENCY RANGE | 1GHz ~ 40GHz | | Average (AV) |

| ANTENNA POLARITY & TEST DISTANCE: HORIZONTAL AT 3 M | | | | | | | | |
|---|-----------------|-------------------------------|-------------------|----------------|--------------------------|----------------------------|------------------------|--------------------------------|
| NO. | FREQ. (MHz) | EMISSION LEVEL (dBuV/m) | LIMIT (dBuV/m) | MARGIN (dB) | ANTENNA HEIGHT (m) | TABLE ANGLE (Degree) | RAW VALUE (dBuV) | CORRECTION FACTOR (dB/m) |
| 1 | #5645.60 | 65.4 PK | 68.2 | -2.8 | 2.52 H | 304 | 61.1 | 4.3 |
| 2 | #5650.00 | 66.9 PK | 68.2 | -1.3 | 1.85 H | 280 | 62.6 | 4.3 |
| 3 | *5775.00 | 111.8 PK | | | 2.52 H | 304 | 71.6 | 40.2 |
| 4 | *5775.00 | 101.3 AV | | | 2.52 H | 304 | 61.1 | 40.2 |
| 5 | #5925.00 | 65.7 PK | 68.2 | -2.5 | 3.34 H | 287 | 60.8 | 4.9 |
| 6 | #5926.40 | 63.5 PK | 68.2 | -4.7 | 2.52 H | 304 | 58.6 | 4.9 |
| 7 | 11550.00 | 60.3 PK | 74.0 | -13.7 | 2.08 H | 156 | 42.3 | 18.0 |
| 8 | 11550.00 | 47.3 AV | 54.0 | -6.7 | 2.08 H | 156 | 29.3 | 18.0 |
| ANTENNA POLARITY & TEST DISTANCE: VERTICAL AT 3 M | | | | | | | | |
| NO. | FREQ. (MHz) | EMISSION LEVEL (dBuV/m) | LIMIT (dBuV/m) | MARGIN (dB) | ANTENNA HEIGHT (m) | TABLE ANGLE (Degree) | RAW VALUE (dBuV) | CORRECTION FACTOR (dB/m) |
| 1 | #5648.80 | 62.8 PK | 68.2 | -5.4 | 1.40 V | 13 | 58.5 | 4.3 |
| 2 | #5650.00 | 64.0 PK | 68.2 | -4.2 | 1.68 V | 344 | 59.7 | 4.3 |
| 3 | *5775.00 | 109.3 PK | | | 1.40 V | 13 | 69.1 | 40.2 |
| 4 | *5775.00 | 99.0 AV | | | 1.40 V | 13 | 58.8 | 40.2 |
| 5 | #5925.00 | 56.9 PK | 68.2 | -11.3 | 1.57 V | 358 | 52.0 | 4.9 |
| 6 | #5954.40 | 60.7 PK | 68.2 | -7.5 | 1.40 V | 13 | 55.7 | 5.0 |
| 7 | 11550.00 | 59.5 PK | 74.0 | -14.5 | 1.87 V | 226 | 41.5 | 18.0 |
| 8 | 11550.00 | 46.8 AV | 54.0 | -7.2 | 1.87 V | 226 | 28.8 | 18.0 |

Remarks:

1. Emission Level(dBuV/m) = Raw Value(dBuV) + Correction Factor(dB/m)
2. Correction Factor(dB/m) = Antenna Factor(dB/m) + Cable Factor(dB) – Pre-Amplifier Factor(dB)
3. The other emission levels were very low against the limit.
4. Margin value = Emission Level – Limit value
5. " * ": Fundamental frequency.
6. " # ": The radiated frequency is out of the restricted band.

Below 1GHz Worst-Case Data: 802.11a

| | | | |
|-----------------|----------------|----------------------|-----------------|
| CHANNEL | TX Channel 157 | DETECTOR FUNCTION | Quasi-Peak (QP) |
| FREQUENCY RANGE | 9kHz ~ 1GHz | | |
| TEST MODE | A | | |

ANTENNA POLARITY & TEST DISTANCE: HORIZONTAL AT 3 M

| NO. | FREQ. (MHz) | EMISSION LEVEL (dBuV/m) | LIMIT (dBuV/m) | MARGIN (dB) | ANTENNA HEIGHT (m) | TABLE ANGLE (Degree) | RAW VALUE (dBuV) | CORRECTION FACTOR (dB/m) |
|-----|----------------|-------------------------------|-------------------|----------------|--------------------------|----------------------------|------------------------|--------------------------------|
| 1 | 57.12 | 26.7 QP | 40.0 | -13.3 | 2.00 H | 97 | 41.1 | -14.4 |
| 2 | 131.00 | 26.9 QP | 43.5 | -16.6 | 2.00 H | 273 | 42.2 | -15.3 |
| 3 | 278.77 | 31.8 QP | 46.0 | -14.2 | 1.00 H | 235 | 45.0 | -13.2 |
| 4 | 416.81 | 34.2 QP | 46.0 | -11.8 | 1.00 H | 15 | 45.1 | -10.9 |
| 5 | 471.25 | 38.3 QP | 46.0 | -7.7 | 2.00 H | 125 | 48.1 | -9.8 |
| 6 | 624.85 | 38.9 QP | 46.0 | -7.1 | 1.00 H | 152 | 45.7 | -6.8 |

ANTENNA POLARITY & TEST DISTANCE: VERTICAL AT 3 M

| NO. | FREQ. (MHz) | EMISSION LEVEL (dBuV/m) | LIMIT (dBuV/m) | MARGIN (dB) | ANTENNA HEIGHT (m) | TABLE ANGLE (Degree) | RAW VALUE (dBuV) | CORRECTION FACTOR (dB/m) |
|-----|----------------|-------------------------------|-------------------|----------------|--------------------------|----------------------------|------------------------|--------------------------------|
| 1 | 37.67 | 30.1 QP | 40.0 | -9.9 | 1.00 V | 182 | 45.4 | -15.3 |
| 2 | 55.18 | 31.9 QP | 40.0 | -8.1 | 1.00 V | 5 | 46.2 | -14.3 |
| 3 | 99.89 | 29.9 QP | 43.5 | -13.6 | 1.00 V | 108 | 48.4 | -18.5 |
| 4 | 278.77 | 29.6 QP | 46.0 | -16.4 | 1.99 V | 269 | 42.8 | -13.2 |
| 5 | 416.81 | 38.4 QP | 46.0 | -7.6 | 1.49 V | 15 | 49.3 | -10.9 |
| 6 | 624.85 | 36.9 QP | 46.0 | -9.1 | 1.00 V | 235 | 43.7 | -6.8 |

Remarks:

1. Emission Level(dBuV/m) = Raw Value(dBuV) + Correction Factor(dB/m)
2. Correction Factor(dB/m) = Antenna Factor(dB/m) + Cable Factor(dB) – Pre-Amplifier Factor(dB)
3. The other emission levels were very low against the limit.
4. Margin value = Emission Level – Limit value

| | | | |
|-----------------|----------------|----------------------|-----------------|
| CHANNEL | TX Channel 157 | DETECTOR FUNCTION | Quasi-Peak (QP) |
| FREQUENCY RANGE | 9kHz ~ 1GHz | | |
| TEST MODE | B | | |

ANTENNA POLARITY & TEST DISTANCE: HORIZONTAL AT 3 M

| NO. | FREQ. (MHz) | EMISSION LEVEL (dBuV/m) | LIMIT (dBuV/m) | MARGIN (dB) | ANTENNA HEIGHT (m) | TABLE ANGLE (Degree) | RAW VALUE (dBuV) | CORRECTION FACTOR (dB/m) |
|-----|----------------|-------------------------------|-------------------|----------------|--------------------------|----------------------------|------------------------|--------------------------------|
| 1 | 57.12 | 26.2 QP | 40.0 | -13.8 | 1.99 H | 254 | 40.6 | -14.4 |
| 2 | 152.39 | 27.7 QP | 43.5 | -15.8 | 1.00 H | 77 | 41.5 | -13.8 |
| 3 | 189.33 | 28.5 QP | 43.5 | -15.0 | 1.99 H | 272 | 44.7 | -16.2 |
| 4 | 276.82 | 29.4 QP | 46.0 | -16.6 | 1.00 H | 253 | 42.7 | -13.3 |
| 5 | 467.36 | 37.0 QP | 46.0 | -9.0 | 1.99 H | 318 | 46.9 | -9.9 |
| 6 | 624.85 | 37.1 QP | 46.0 | -8.9 | 1.00 H | 151 | 43.9 | -6.8 |

ANTENNA POLARITY & TEST DISTANCE: VERTICAL AT 3 M

| NO. | FREQ. (MHz) | EMISSION LEVEL (dBuV/m) | LIMIT (dBuV/m) | MARGIN (dB) | ANTENNA HEIGHT (m) | TABLE ANGLE (Degree) | RAW VALUE (dBuV) | CORRECTION FACTOR (dB/m) |
|-----|----------------|-------------------------------|-------------------|----------------|--------------------------|----------------------------|------------------------|--------------------------------|
| 1 | 36.37 | 31.4 QP | 40.0 | -8.6 | 1.00 V | 184 | 46.9 | -15.5 |
| 2 | 105.73 | 34.7 QP | 43.5 | -8.8 | 1.00 V | 103 | 52.5 | -17.8 |
| 3 | 276.82 | 29.4 QP | 46.0 | -16.6 | 2.00 V | 309 | 42.7 | -13.3 |
| 4 | 374.04 | 33.1 QP | 46.0 | -12.9 | 1.50 V | 109 | 44.7 | -11.6 |
| 5 | 412.92 | 37.3 QP | 46.0 | -8.7 | 1.50 V | 268 | 48.3 | -11.0 |
| 6 | 624.85 | 36.2 QP | 46.0 | -9.8 | 1.00 V | 234 | 43.0 | -6.8 |

Remarks:

1. Emission Level(dBuV/m) = Raw Value(dBuV) + Correction Factor(dB/m)
2. Correction Factor(dB/m) = Antenna Factor(dB/m) + Cable Factor(dB) – Pre-Amplifier Factor(dB)
3. The other emission levels were very low against the limit.
4. Margin value = Emission Level – Limit value

4.2 Conducted Emission Measurement

4.2.1 Limits of Conducted Emission Measurement

| Frequency (MHz) | Conducted Limit (dBuV) | |
|-----------------|------------------------|---------|
| | Quasi-peak | Average |
| 0.15 - 0.5 | 66 - 56 | 56 - 46 |
| 0.50 - 5.0 | 56 | 46 |
| 5.0 - 30.0 | 60 | 50 |

Note: 1. The lower limit shall apply at the transition frequencies.

2. The limit decreases in line with the logarithm of the frequency in the range of 0.15 to 0.50MHz.

4.2.2 Test Instruments

| Description & Manufacturer | Model No. | Serial No. | Cal. Date | Cal. Due |
|--|--------------------------|----------------|---------------|---------------|
| Test Receiver ROHDE & SCHWARZ | ESCI | 100613 | Nov. 23, 2017 | Nov. 22, 2018 |
| RF signal cable (with 10dB PAD) Woken | 5D-FB | Cable-cond1-01 | Sep. 05, 2017 | Sep. 04, 2018 |
| LISN ROHDE & SCHWARZ (EUT) | ESH3-Z5 | 835239/001 | Mar. 06, 2018 | Mar. 05, 2019 |
| LISN ROHDE & SCHWARZ (Peripheral) | ESH3-Z5 | 100311 | Aug. 15, 2017 | Aug. 14, 2018 |
| Software ADT | BV ADT_Cond_ V7.3.7.3 | NA | NA | NA |

Note: 1. The calibration interval of the above test instruments is 12 months and the calibrations are traceable to NML/ROC and NIST/USA.

2. The test was performed in HwaYa Shielded Room 1.

3. The VCCI Site Registration No. is C-2040.

4.2.3 Test Procedures

- The EUT was placed 0.4 meters from the conducting wall of the shielded room with EUT being connected to the power mains through a line impedance stabilization network (LISN). Other support units were connected to the power mains through another LISN. The two LISNs provide 50 ohm/ 50uH of coupling impedance for the measuring instrument.
- Both lines of the power mains connected to the EUT were checked for maximum conducted interference.
- The frequency range from 150kHz to 30MHz was searched. Emission levels under (Limit - 20dB) was not recorded.

Note: The resolution bandwidth and video bandwidth of test receiver is 9kHz for quasi-peak detection (QP) and average detection (AV) at frequency 0.15MHz-30MHz.

4.2.4 Deviation from Test Standard

No deviation.

4.2.5 Test Setup

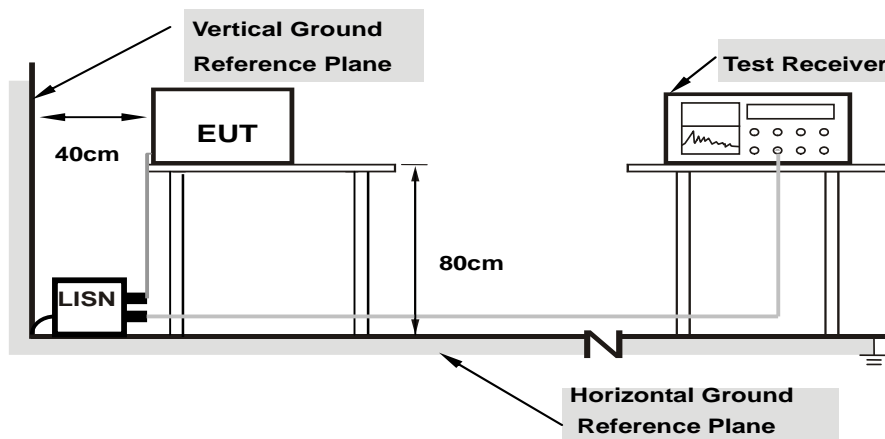

Note: 1.Support units were connected to second LISN.

For the actual test configuration, please refer to the attached file (Test Setup Photo).

4.2.6 EUT Operating Conditions

Same as 4.1.6.

4.2.7 Test Results

Worst-case data: 802.11a

| | | | |
|-----------|----------|-------------------|--------------------------------|
| Phase | Line (L) | Detector Function | Quasi-Peak (QP) / Average (AV) |
| Test Mode | A | | |

| No | Freq. [MHz] | Corr. Factor (dB) | Reading Value | | Emission Level | | Limit | | Margin | |
|----|----------------|----------------------|---------------|-------|----------------|-------|-----------|-------|--------|--------|
| | | | [dB (uV)] | | [dB (uV)] | | [dB (uV)] | | (dB) | |
| | | | Q.P. | AV. | Q.P. | AV. | Q.P. | AV. | Q.P. | AV. |
| 1 | 0.15811 | 10.16 | 40.84 | 24.65 | 51.00 | 34.81 | 65.56 | 55.56 | -14.56 | -20.75 |
| 2 | 0.18228 | 10.16 | 35.98 | 20.68 | 46.14 | 30.84 | 64.38 | 54.38 | -18.24 | -23.54 |
| 3 | 0.23400 | 10.16 | 26.61 | 10.85 | 36.77 | 21.01 | 62.31 | 52.31 | -25.54 | -31.30 |
| 4 | 0.36200 | 10.20 | 23.55 | 18.45 | 33.75 | 28.65 | 58.68 | 48.68 | -24.93 | -20.03 |
| 5 | 1.28200 | 10.19 | 7.70 | 3.85 | 17.89 | 14.04 | 56.00 | 46.00 | -38.11 | -31.96 |
| 6 | 4.25400 | 10.36 | 7.35 | 2.31 | 17.71 | 12.67 | 56.00 | 46.00 | -38.29 | -33.33 |

Remarks:

1. Q.P. and AV. are abbreviations of quasi-peak and average individually.
2. The emission levels of other frequencies were very low against the limit.
3. Margin value = Emission level - Limit value
4. Correction factor = Insertion loss + Cable loss
5. Emission Level = Correction Factor + Reading Value.

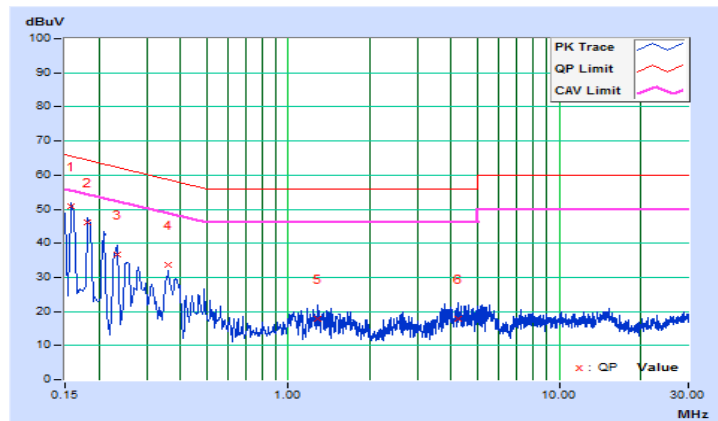

| | | | |
|-----------|-------------|-------------------|--------------------------------|
| Phase | Neutral (N) | Detector Function | Quasi-Peak (QP) / Average (AV) |
| Test Mode | A | | |

| No | Freq. [MHz] | Corr. Factor (dB) | Reading Value [dB (uV)] | | Emission Level [dB (uV)] | | Limit [dB (uV)] | | Margin (dB) | |
|----|----------------|----------------------|----------------------------|---------|-----------------------------|-------|--------------------|-------|----------------|--------|
| | | | Q.P. | AV. | Q.P. | AV. | Q.P. | AV. | Q.P. | AV. |
| | | | 1 | 0.16535 | 10.15 | 36.56 | 21.70 | 46.71 | 31.85 | 65.19 |
| 2 | 0.18519 | 10.16 | 34.95 | 19.54 | 45.11 | 29.70 | 64.25 | 54.25 | -19.14 | -24.55 |
| 3 | 0.47000 | 10.20 | 10.35 | 1.17 | 20.55 | 11.37 | 56.51 | 46.51 | -35.96 | -35.14 |
| 4 | 1.25800 | 10.21 | 6.32 | 2.58 | 16.53 | 12.79 | 56.00 | 46.00 | -39.47 | -33.21 |
| 5 | 5.03400 | 10.38 | 7.61 | 1.87 | 17.99 | 12.25 | 60.00 | 50.00 | -42.01 | -37.75 |
| 6 | 16.01000 | 10.84 | 5.55 | 1.38 | 16.39 | 12.22 | 60.00 | 50.00 | -43.61 | -37.78 |

Remarks:

1. Q.P. and AV. are abbreviations of quasi-peak and average individually.
2. The emission levels of other frequencies were very low against the limit.
3. Margin value = Emission level - Limit value
4. Correction factor = Insertion loss + Cable loss
5. Emission Level = Correction Factor + Reading Value.

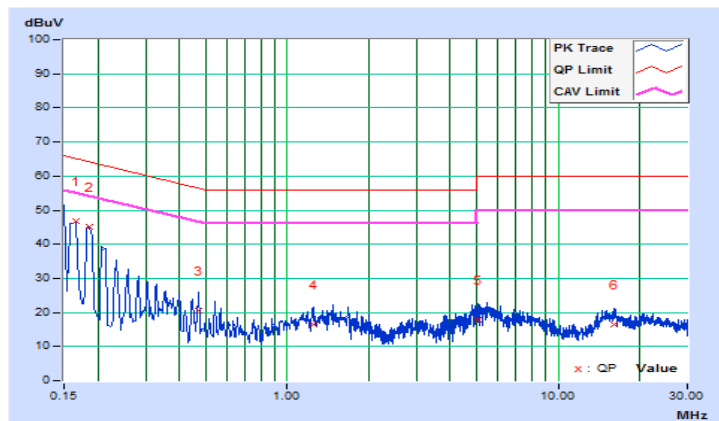

| | | | |
|-----------|----------|-------------------|--------------------------------|
| Phase | Line (L) | Detector Function | Quasi-Peak (QP) / Average (AV) |
| Test Mode | B | | |

| No | Freq. [MHz] | Corr. Factor (dB) | Reading Value [dB (uV)] | | Emission Level [dB (uV)] | | Limit [dB (uV)] | | Margin (dB) | |
|----|----------------|----------------------|----------------------------|---------|-----------------------------|-------|--------------------|-------|----------------|--------|
| | | | Q.P. | AV. | Q.P. | AV. | Q.P. | AV. | Q.P. | AV. |
| | | | 1 | 0.20600 | 10.10 | 37.31 | 30.09 | 47.41 | 40.19 | 63.37 |
| 2 | 0.26639 | 10.11 | 31.62 | 24.60 | 41.73 | 34.71 | 61.23 | 51.23 | -19.50 | -16.52 |
| 3 | 0.32630 | 10.11 | 33.18 | 23.81 | 43.29 | 33.92 | 59.54 | 49.54 | -16.25 | -15.62 |
| 4 | 0.85400 | 10.14 | 23.88 | 11.39 | 34.02 | 21.53 | 56.00 | 46.00 | -21.98 | -24.47 |
| 5 | 8.74600 | 10.55 | 17.86 | 11.19 | 28.41 | 21.74 | 60.00 | 50.00 | -31.59 | -28.26 |
| 6 | 18.15000 | 11.10 | 19.31 | 13.85 | 30.41 | 24.95 | 60.00 | 50.00 | -29.59 | -25.05 |

Remarks:

1. Q.P. and AV. are abbreviations of quasi-peak and average individually.
2. The emission levels of other frequencies were very low against the limit.
3. Margin value = Emission level - Limit value
4. Correction factor = Insertion loss + Cable loss
5. Emission Level = Correction Factor + Reading Value.

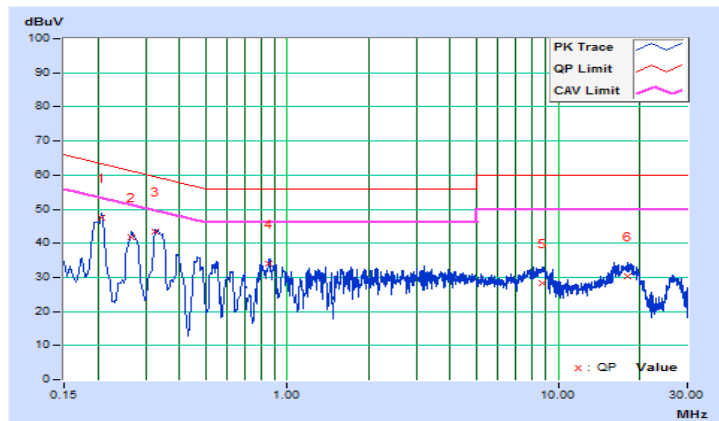

| | | | |
|-----------|-------------|-------------------|--------------------------------|
| Phase | Neutral (N) | Detector Function | Quasi-Peak (QP) / Average (AV) |
| Test Mode | B | | |

| No | Freq. [MHz] | Corr. Factor (dB) | Reading Value [dB (uV)] | | Emission Level [dB (uV)] | | Limit [dB (uV)] | | Margin (dB) | |
|----|----------------|----------------------|----------------------------|----------------|-----------------------------|--------------|--------------------|--------------|----------------|--------------|
| | | | Q.P. | AV. | Q.P. | AV. | Q.P. | AV. | Q.P. | AV. |
| | | | 1 | 0.20201 | 10.10 | 35.69 | 30.80 | 45.79 | 40.90 | 63.53 |
| 2 | 0.35000 | 10.11 | 30.23 | 17.78 | 40.34 | 27.89 | 58.96 | 48.96 | -18.62 | -21.07 |
| 3 | 0.87000 | 10.13 | 24.85 | 12.26 | 34.98 | 22.39 | 56.00 | 46.00 | -21.02 | -23.61 |
| 4 | 8.98200 | 10.48 | 18.10 | 11.00 | 28.58 | 21.48 | 60.00 | 50.00 | -31.42 | -28.52 |
| 5 | 17.83800 | 10.85 | 20.10 | 13.64 | 30.95 | 24.49 | 60.00 | 50.00 | -29.05 | -25.51 |
| 6 | 26.47400 | 11.03 | 15.70 | 10.10 | 26.73 | 21.13 | 60.00 | 50.00 | -33.27 | -28.87 |

Remarks:

1. Q.P. and AV. are abbreviations of quasi-peak and average individually.
2. The emission levels of other frequencies were very low against the limit.
3. Margin value = Emission level - Limit value
4. Correction factor = Insertion loss + Cable loss
5. Emission Level = Correction Factor + Reading Value.

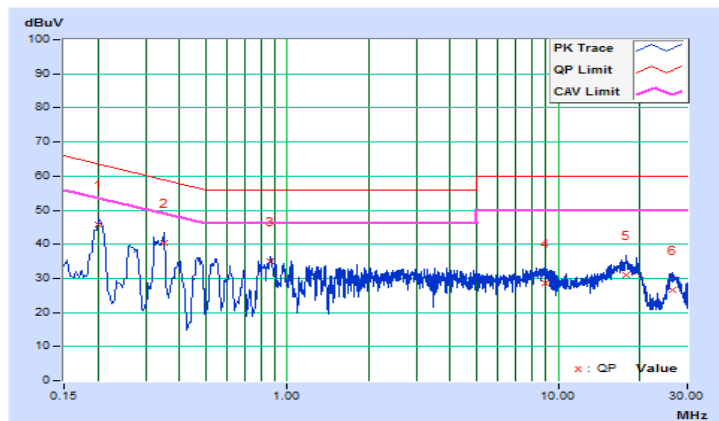

4.3 Transmit Power Measurement

4.3.1 Limits of Transmit Power Measurement

| Operation Band | EUT Category | | Limit |
|----------------|--------------|-----------------------------------|---|
| U-NII-1 | | Outdoor Access Point | 1 Watt (30 dBm) (Max. e.i.r.p \leq 125mW(21 dBm) at any elevation angle above 30 degrees as measured from the horizon) |
| | | Fixed point-to-point Access Point | 1 Watt (30 dBm) |
| | √ | Indoor Access Point | 1 Watt (30 dBm) |
| | | Mobile and Portable client device | 250mW (24 dBm) |
| U-NII-2A | - | | 250mW (24 dBm) or 11 dBm+10 log B* |
| U-NII-2C | - | | 250mW (24 dBm) or 11 dBm+10 log B* |
| U-NII-3 | √ | | 1 Watt (30 dBm) |

*B is the 26 dB emission bandwidth in megahertz

Per KDB 662911 Method of conducted output power measurement on IEEE 802.11 devices,

Array Gain = 0 dB (i.e., no array gain) for $N_{ANT} \leq 4$;

Array Gain = 0 dB (i.e., no array gain) for channel widths ≥ 40 MHz for any N_{ANT} ;

Array Gain = $5 \log(N_{ANT}/N_{SS})$ dB or 3 dB, whichever is less for 20-MHz channel widths with $N_{ANT} \geq 5$.

For power measurements on all other devices: Array Gain = $10 \log(N_{ANT}/N_{SS})$ dB.

4.3.2 Test Setup

For Power Output

802.11a, 802.11n (HT20), 802.11n (HT40)

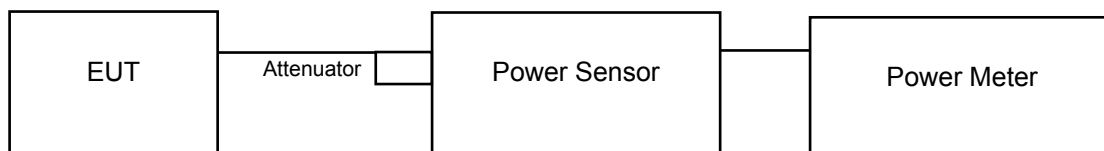

802.11ac (VHT80)

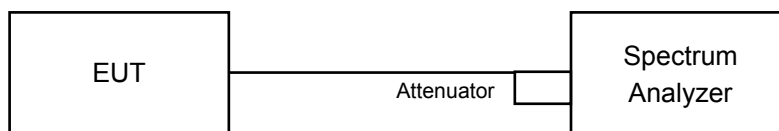

4.3.3 Test Instruments

Refer to section 4.1.2 to get information of above instrument.

4.3.4 Test Procedure

For Average Power Measurement

For 802.11a, 802.11n (HT20), 802.11n (HT40)

Method PM is used to perform output power measurement, trigger and gating function of wide band power meter is enabled to measure max output power of TX on burst and set the detector to average. Duty factor is not added to measured value.

For 802.11ac (VHT80)

- a. Set span to encompass the entire 26 dB EBW (or, alternatively, the entire 99% occupied bandwidth) of the signal.
- b. Set sweep trigger to “free run”.
- c. Set RBW = 1 MHz.
- d. Set VBW \geq 3 MHz.
- e. Number of points in sweep \geq 2 Span / RBW.
- f. Sweep time \leq (number of points in sweep) * T
- g. Using emission bandwidth to determine the frequency span for integration the channel bandwidth.
- h. Detector = RMS.
- i. Trace mode = max hold.
- j. Allow max hold to run for at least 60 seconds, or longer as needed to allow the trace to stabilize.
- k. Compute power by integrating the spectrum across the EBW (or, alternatively, the entire 99% occupied bandwidth) of the signal using the instrument’s band power measurement function with band limits set equal to the EBW (or occupied bandwidth) band edges. If the instrument does not have a band power function, sum the spectrum levels (in power units) at 1 MHz intervals extending across the EBW (or, alternatively, the entire 99% occupied bandwidth) of the spectrum.

4.3.5 Deviation from Test Standard

No deviation.

4.3.6 EUT Operating Conditions

The software provided by client to enable the EUT under transmission condition continuously at lowest, middle and highest channel frequencies individually.

4.3.7 Test Result

Power Output:

CDD Mode

802.11a

| Chan. | Freq. (MHz) | Maximum Conducted Power (dBm) | | Total Power (mW) | Total Power (dBm) | Power Limit (dBm) | Pass / Fail |
|-------|-------------|-------------------------------|---------|------------------|-------------------|-------------------|-------------|
| | | Chain 0 | Chain 1 | | | | |
| 36 | 5180 | 20.98 | 20.77 | 244.713 | 23.89 | 30.00 | Pass |
| 40 | 5200 | 23.78 | 23.63 | 469.456 | 26.72 | 30.00 | Pass |
| 48 | 5240 | 23.12 | 23.01 | 405.102 | 26.08 | 30.00 | Pass |
| 149 | 5745 | 23.92 | 23.47 | 468.935 | 26.71 | 30.00 | Pass |
| 157 | 5785 | 23.88 | 23.47 | 466.674 | 26.69 | 30.00 | Pass |
| 165 | 5825 | 23.96 | 23.56 | 475.872 | 26.77 | 30.00 | Pass |

802.11n (HT20)

| Chan. | Freq. (MHz) | Maximum Conducted Power (dBm) | | Total Power (mW) | Total Power (dBm) | Power Limit (dBm) | Pass / Fail |
|-------|-------------|-------------------------------|---------|------------------|-------------------|-------------------|-------------|
| | | Chain 0 | Chain 1 | | | | |
| 36 | 5180 | 20.79 | 20.85 | 241.569 | 23.83 | 30.00 | Pass |
| 40 | 5200 | 23.74 | 23.59 | 465.152 | 26.68 | 30.00 | Pass |
| 48 | 5240 | 23.02 | 23.01 | 400.433 | 26.03 | 30.00 | Pass |
| 149 | 5745 | 23.84 | 23.41 | 461.383 | 26.64 | 30.00 | Pass |
| 157 | 5785 | 23.13 | 23.19 | 414.038 | 26.17 | 30.00 | Pass |
| 165 | 5825 | 23.84 | 23.51 | 466.491 | 26.69 | 30.00 | Pass |

802.11n (HT40)

| Chan. | Freq. (MHz) | Maximum Conducted Power (dBm) | | Total Power (mW) | Total Power (dBm) | Power Limit (dBm) | Pass / Fail |
|-------|-------------|-------------------------------|---------|------------------|-------------------|-------------------|-------------|
| | | Chain 0 | Chain 1 | | | | |
| 38 | 5190 | 19.93 | 19.79 | 193.681 | 22.87 | 30.00 | Pass |
| 46 | 5230 | 23.54 | 23.28 | 438.758 | 26.42 | 30.00 | Pass |
| 151 | 5755 | 23.28 | 23.13 | 418.403 | 26.22 | 30.00 | Pass |
| 159 | 5795 | 23.69 | 23.20 | 442.814 | 26.46 | 30.00 | Pass |

802.11ac (VHT80)

| Chan. | Freq. (MHz) | Maximum Conducted Power (dBm) | | Total Power (mW) | Total Power (dBm) | Power Limit (dBm) | Pass / Fail |
|-------|-------------|-------------------------------|---------|------------------|-------------------|-------------------|-------------|
| | | Chain 0 | Chain 1 | | | | |
| 42 | 5210 | 19.37 | 19.31 | 171.807 | 22.35 | 30.00 | Pass |
| 155 | 5775 | 20.07 | 19.42 | 189.123 | 22.77 | 30.00 | Pass |

Beamforming Mode

802.11n (HT20)

| Chan. | Freq. (MHz) | Maximum Conducted Power (dBm) | | Total Power (mW) | Total Power (dBm) | Power Limit (dBm) | Pass / Fail |
|-------|-------------|-------------------------------|---------|------------------|-------------------|-------------------|-------------|
| | | Chain 0 | Chain 1 | | | | |
| 36 | 5180 | 17.78 | 17.84 | 120.793 | 20.82 | 27.43 | Pass |
| 40 | 5200 | 20.73 | 20.58 | 232.592 | 23.67 | 27.43 | Pass |
| 48 | 5240 | 20.01 | 20.00 | 200.231 | 23.02 | 27.43 | Pass |
| 149 | 5745 | 20.83 | 20.40 | 230.708 | 23.63 | 27.43 | Pass |
| 157 | 5785 | 20.12 | 20.18 | 207.034 | 23.16 | 27.43 | Pass |
| 165 | 5825 | 20.83 | 20.50 | 233.262 | 23.68 | 27.43 | Pass |

Note: Beamforming gain = $5.56\text{dBi} + 10\log(2) = 8.57\text{dBi} > 6\text{dBi}$, so the power limit shall be reduced to $30 - (8.57 - 6) = 27.43\text{dBm}$.

802.11n (HT40)

| Chan. | Freq. (MHz) | Maximum Conducted Power (dBm) | | Total Power (mW) | Total Power (dBm) | Power Limit (dBm) | Pass / Fail |
|-------|-------------|-------------------------------|---------|------------------|-------------------|-------------------|-------------|
| | | Chain 0 | Chain 1 | | | | |
| 38 | 5190 | 16.92 | 16.78 | 96.847 | 19.86 | 27.43 | Pass |
| 46 | 5230 | 20.53 | 20.27 | 219.394 | 23.41 | 27.43 | Pass |
| 151 | 5755 | 20.27 | 20.12 | 209.216 | 23.21 | 27.43 | Pass |
| 159 | 5795 | 20.68 | 20.19 | 221.422 | 23.45 | 27.43 | Pass |

Note: Beamforming gain = $5.56\text{dBi} + 10\log(2) = 8.57\text{dBi} > 6\text{dBi}$, so the power limit shall be reduced to $30 - (8.57 - 6) = 27.43\text{dBm}$.

802.11ac (VHT80)

| Chan. | Freq. (MHz) | Maximum Conducted Power (dBm) | | Total Power (mW) | Total Power (dBm) | Power Limit (dBm) | Pass / Fail |
|-------|-------------|-------------------------------|---------|------------------|-------------------|-------------------|-------------|
| | | Chain 0 | Chain 1 | | | | |
| 42 | 5210 | 16.36 | 16.30 | 85.909 | 19.34 | 27.43 | Pass |
| 155 | 5775 | 17.06 | 16.41 | 94.568 | 19.76 | 27.43 | Pass |

Note: Beamforming gain = $5.56\text{dBi} + 10\log(2) = 8.57\text{dBi} > 6\text{dBi}$, so the power limit shall be reduced to $30 - (8.57 - 6) = 27.43\text{dBm}$.

4.4 Occupied Bandwidth Measurement

4.4.1 Test Setup

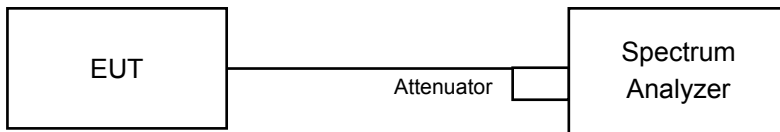

4.4.2 Test Instruments

Refer to section 4.1.2 to get information of above instrument.

4.4.3 Test Procedure

The transmitter output was connected to the spectrum analyzer through an attenuator. The bandwidth of the fundamental frequency was measured by spectrum analyzer with resolution bandwidth in the range of 1% to 5% of the anticipated emission bandwidth, and a video bandwidth at least 3x the resolution bandwidth and set the detector to sampling. The width of a frequency band such that, below the lower and above the upper frequency limits, the mean powers emitted are each equal to a specified percentage 0.5 %of the total mean power of a given emission.

4.4.4 Test Result

802.11a

| Chan. | Freq. (MHz) | Occupied Bandwidth (MHz) | |
|-------|-------------|--------------------------|---------|
| | | Chain 0 | Chain 1 |
| 36 | 5180 | 16.56 | 16.56 |
| 40 | 5200 | 25.80 | 25.08 |
| 48 | 5240 | 17.57 | 16.68 |
| 149 | 5745 | 28.08 | 23.30 |
| 157 | 5785 | 27.96 | 24.24 |
| 165 | 5825 | 32.76 | 30.00 |

802.11n (HT20)

| Chan. | Freq. (MHz) | Occupied Bandwidth (MHz) | |
|-------|-------------|--------------------------|---------|
| | | Chain 0 | Chain 1 |
| 36 | 5180 | 17.64 | 17.64 |
| 40 | 5200 | 27.00 | 19.20 |
| 48 | 5240 | 18.35 | 17.88 |
| 149 | 5745 | 28.80 | 22.87 |
| 157 | 5785 | 28.56 | 24.60 |
| 165 | 5825 | 34.20 | 30.72 |

802.11n (HT40)

| Chan. | Freq. (MHz) | Occupied Bandwidth (MHz) | |
|-------|-------------|--------------------------|---------|
| | | Chain 0 | Chain 1 |
| 38 | 5190 | 36.24 | 36.12 |
| 46 | 5230 | 37.80 | 36.60 |
| 151 | 5755 | 40.80 | 36.96 |
| 159 | 5795 | 46.20 | 40.56 |

802.11ac (VHT80)

| Chan. | Freq. (MHz) | Occupied Bandwidth (MHz) | |
|-------|-------------|--------------------------|---------|
| | | Chain 0 | Chain 1 |
| 42 | 5210 | 75.84 | 76.32 |
| 155 | 5775 | 75.84 | 75.84 |

Spectrum Plot of Worst Value

802.11a

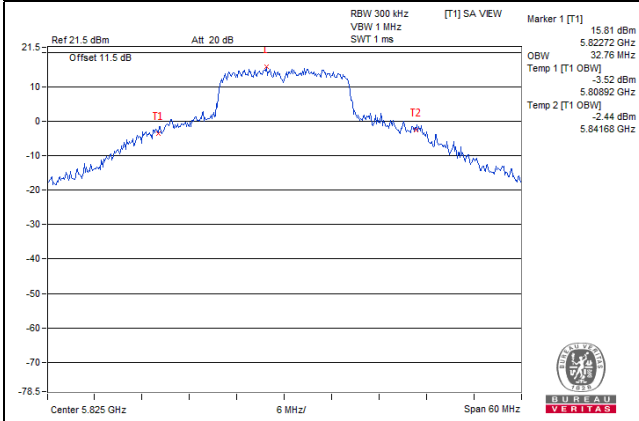

802.11n (HT20)

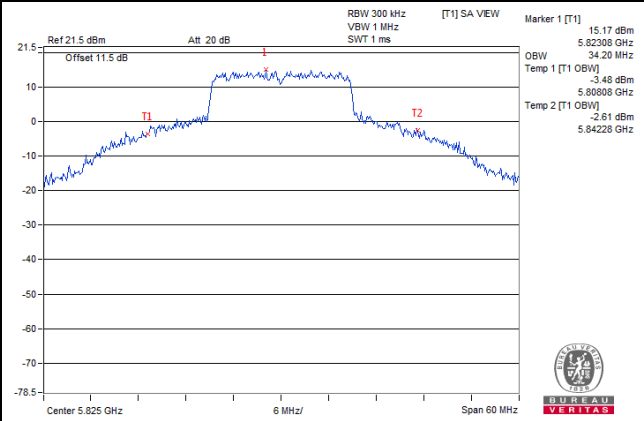

802.11n (HT40)

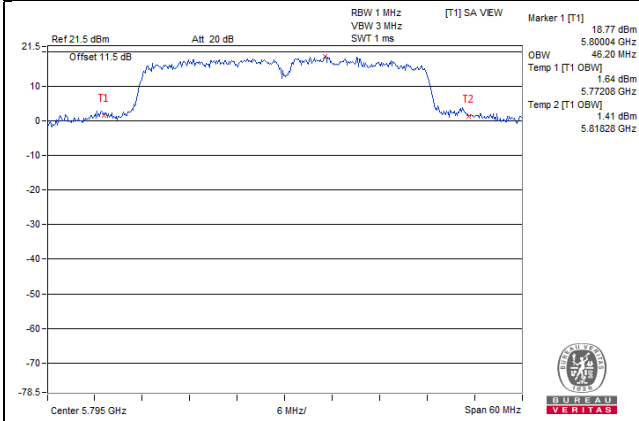

802.11ac (VHT80)

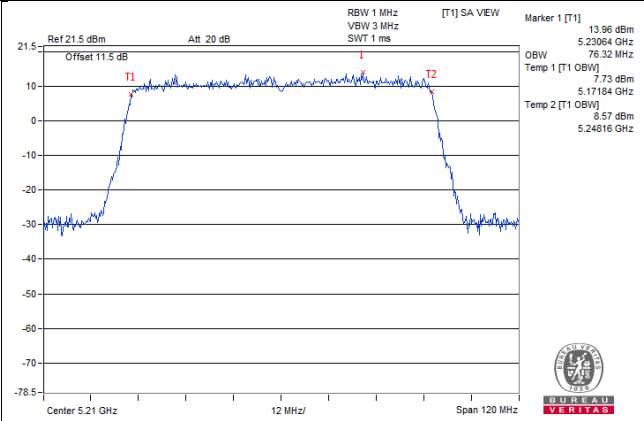

4.5 Peak Power Spectral Density Measurement

4.5.1 Limits of Peak Power Spectral Density Measurement

| Operation Band | EUT Category | | Limit |
|----------------|--------------|-----------------------------------|---------------|
| U-NII-1 | | Outdoor Access Point | 17dBm/ MHz |
| | | Fixed point-to-point Access Point | |
| | √ | Indoor Access Point | |
| | | Mobile and Portable client device | 11dBm/ MHz |
| U-NII-2A | | | 11dBm/ MHz |
| U-NII-2C | | | 11dBm/ MHz |
| U-NII-3 | √ | | 30dBm/ 500kHz |

4.5.2 Test Setup

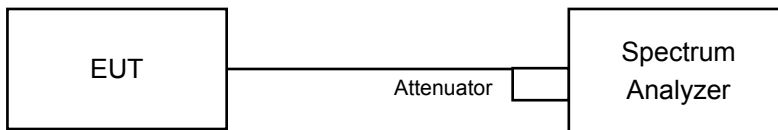

4.5.3 Test Instruments

Refer to section 4.1.2 to get information of above instrument.

4.5.4 Test Procedures

For U-NII-1 band:

Duty cycle of test signal is > 98%

Using method SA-1

- Set span to encompass the entire emission bandwidth (EBW) of the signal.
- Set RBW = 1 MHz, Set VBW \geq 3 MHz, Detector = RMS
- Sweep time = auto, trigger set to "free run".
- Trace average at least 100 traces in power averaging mode.
- Record the max value

Duty cycle of test signal is < 98%

Using method SA-2

- Set span to encompass the entire emission bandwidth (EBW) of the signal.
- Set RBW = 1MHz, Set VBW \geq 3 MHz, Detector = RMS
- Set Channel power measure = 1MHz
- Sweep time = auto, trigger set to "free run".
- Trace average at least 100 traces in power averaging mode.
- Record the max value and add $10 \log (1/\text{duty cycle})$

For U-NII-3 band:

Duty cycle of test signal is > 98%

- a. Set span to encompass the entire emission bandwidth (EBW) of the signal.
- b. Set RBW = 300 kHz, Set VBW \geq 1 MHz, Detector = RMS
- c. Use the peak marker function to determine the maximum power level in any 300 kHz band segment within the fundamental EBW.
- d. Scale the observed power level to an equivalent value in 500 kHz by adjusting (reducing) the measured power by a bandwidth correction factor (BWCF) where $BWCF = 10\log(500 \text{ kHz}/300\text{kHz})$
- e. Sweep time = auto, trigger set to "free run".
- f. Trace average at least 100 traces in power averaging mode.
- g. Record the max value

Duty cycle of test signal is < 98%

- a. Set span to encompass the entire emission bandwidth (EBW) of the signal.
- b. Set RBW = 300 kHz, Set VBW \geq 1 MHz, Detector = RMS
- c. Use the peak marker function to determine the maximum power level in any 300 kHz band segment within the fundamental EBW.
- d. Scale the observed power level to an equivalent value in 500 kHz by adjusting (reducing) the measured power by a bandwidth correction factor (BWCF) where $BWCF = 10\log(500 \text{ kHz} / 300 \text{ kHz})$
- e. Sweep time = auto, trigger set to "free run".
- f. Trace average at least 100 traces in power averaging mode.
- g. Record the max value and add $10 \log (1/\text{duty cycle})$

4.5.5 Deviation from Test Standard

No deviation.

4.5.6 EUT Operating Conditions

Same as Item 4.3.6.

4.5.7 Test Results

For U-NII-1 band:

802.11a

| Chan. | Freq. (MHz) | PSD w/o Duty Factor (dBm/MHz) | | Duty Factor (dB) | Total PSD with Duty Factor (dBm/MHz) | Max. Limit (dBm/MHz) | Pass / Fail |
|-------|-------------|-------------------------------|---------|------------------|--------------------------------------|----------------------|-------------|
| | | Chain 0 | Chain 1 | | | | |
| 36 | 5180 | 7.36 | 7.31 | 0.25 | 10.60 | 14.43 | Pass |
| 40 | 5200 | 10.71 | 10.66 | 0.25 | 13.95 | 14.43 | Pass |
| 48 | 5240 | 9.45 | 9.26 | 0.25 | 12.62 | 14.43 | Pass |

Note:

- Method 1 of power density measurement of KDB 662911 is using for calculating total power density. Total power density is summing entire spectra across corresponding frequency bins on the various outputs by computer.
- Directional gain = $5.56\text{dBi} + 10\log(2) = 8.57\text{dBi} > 6\text{dBi}$, so the power density limit shall be reduced to $17 - (8.57 - 6) = 14.43\text{dBm}$.
- Refer to section 3.3 for duty cycle spectrum plot.

802.11n (HT20)

| Chan. | Freq. (MHz) | PSD (dBm/MHz) | | Total PSD (dBm/MHz) | Max. Limit (dBm/MHz) | Pass / Fail |
|-------|-------------|---------------|---------|---------------------|----------------------|-------------|
| | | Chain 0 | Chain 1 | | | |
| 36 | 5180 | 7.08 | 6.94 | 10.02 | 14.43 | Pass |
| 40 | 5200 | 10.42 | 10.24 | 13.34 | 14.43 | Pass |
| 48 | 5240 | 9.23 | 9.12 | 12.19 | 14.43 | Pass |

Note:

- Method 1 of power density measurement of KDB 662911 is using for calculating total power density. Total power density is summing entire spectra across corresponding frequency bins on the various outputs by computer.
- Directional gain = $5.56\text{dBi} + 10\log(2) = 8.57\text{dBi} > 6\text{dBi}$, so the power density limit shall be reduced to $17 - (8.57 - 6) = 14.43\text{dBm}$.

802.11n (HT40)

| Chan. | Freq. (MHz) | PSD w/o Duty Factor (dBm/MHz) | | Duty Factor (dB) | Total PSD with Duty Factor (dBm/MHz) | Max. Limit (dBm/MHz) | Pass / Fail |
|-------|-------------|-------------------------------|---------|------------------|--------------------------------------|----------------------|-------------|
| | | Chain 0 | Chain 1 | | | | |
| 38 | 5190 | 3.33 | 3.23 | 0.16 | 6.45 | 14.43 | Pass |
| 46 | 5230 | 7.28 | 6.37 | 0.16 | 10.02 | 14.43 | Pass |

Note:

- Method 1 of power density measurement of KDB 662911 is using for calculating total power density. Total power density is summing entire spectra across corresponding frequency bins on the various outputs by computer.
- Directional gain = $5.56\text{dBi} + 10\log(2) = 8.57\text{dBi} > 6\text{dBi}$, so the power density limit shall be reduced to $17 - (8.57 - 6) = 14.43\text{dBm}$.
- Refer to section 3.3 for duty cycle spectrum plot.

802.11ac (VHT80)

| Chan. | Freq. (MHz) | PSD w/o Duty Factor (dBm/MHz) | | Duty Factor (dB) | Total PSD with Duty Factor (dBm/MHz) | Max. Limit (dBm/MHz) | Pass / Fail |
|-------|-------------|-------------------------------|---------|------------------|--------------------------------------|----------------------|-------------|
| | | Chain 0 | Chain 1 | | | | |
| 42 | 5210 | -0.53 | -0.98 | 0.34 | 2.61 | 14.43 | Pass |

Note:

- Method 1 of power density measurement of KDB 662911 is using for calculating total power density. Total power density is summing entire spectra across corresponding frequency bins on the various outputs by computer.
- Directional gain = $5.56\text{dBi} + 10\log(2) = 8.57\text{dBi} > 6\text{dBi}$, so the power density limit shall be reduced to $17 - (8.57 - 6) = 14.43\text{dBm}$.
- Refer to section 3.3 for duty cycle spectrum plot.

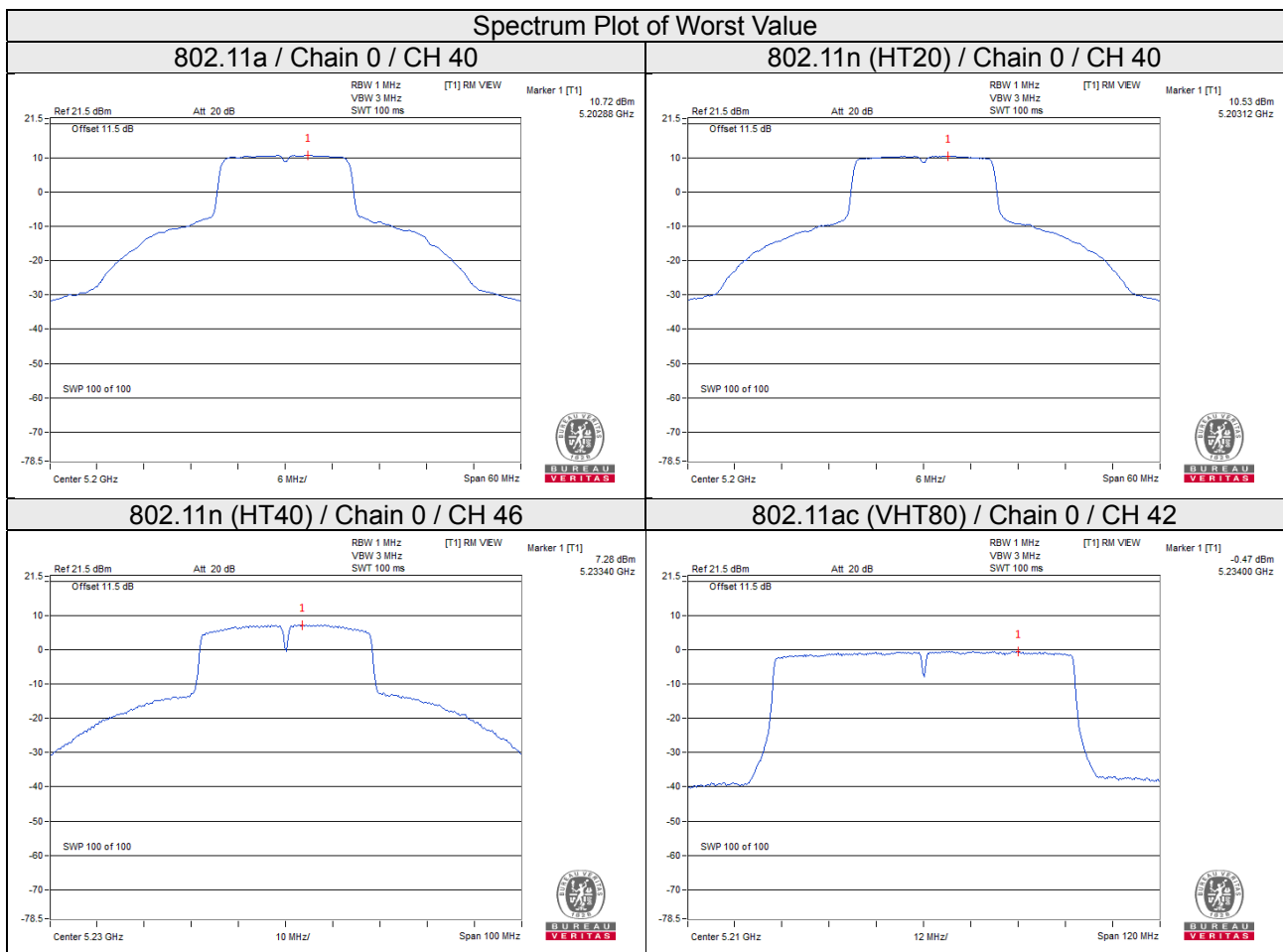

For U-NII-3 band:

802.11a

| TX chain | Chan. | Freq. (MHz) | PSD W/O Duty Factor | | 10 log (N=2) dB | Duty Factor (dB) | Total PSD With Duty Factor (dBm/500kHz) | Limit (dBm/500kHz) | Pass / Fail |
|----------|-------|-------------|---------------------|--------------|-----------------|------------------|---|--------------------|-------------|
| | | | (dBm/300kHz) | (dBm/500kHz) | | | | | |
| 0 | 149 | 5745 | 2.70 | 4.92 | 3.01 | 0.25 | 8.18 | 27.43 | Pass |
| | 157 | 5785 | 2.27 | 4.49 | 3.01 | 0.25 | 7.75 | 27.43 | Pass |
| | 165 | 5825 | 2.70 | 4.92 | 3.01 | 0.25 | 8.18 | 27.43 | Pass |
| 1 | 149 | 5745 | 2.61 | 4.83 | 3.01 | 0.25 | 8.09 | 27.43 | Pass |
| | 157 | 5785 | 2.39 | 4.61 | 3.01 | 0.25 | 7.87 | 27.43 | Pass |
| | 165 | 5825 | 2.77 | 4.99 | 3.01 | 0.25 | 8.25 | 27.43 | Pass |

Note:

1. Method 1 of power density measurement of KDB 662911 is using for calculating total power density. Total power density is summing entire spectra across corresponding frequency bins on the various outputs by computer.
2. Directional gain = $5.56\text{dBi} + 10\log(2) = 8.57\text{dBi} > 6\text{dBi}$, so the power density limit shall be reduced to $30 - (8.57 - 6) = 27.43\text{dBm}$.
3. Refer to section 3.3 for duty cycle spectrum plot.

802.11n (HT20)

| TX chain | Chan. | Freq. (MHz) | PSD (dBm/300 kHz) | PSD (dBm/500 kHz) | 10 log (N=2) dB | Total PSD (dBm/500 kHz) | Limit (dBm/500 kHz) | Pass / Fail |
|----------|-------|-------------|-------------------|-------------------|-----------------|-------------------------|---------------------|-------------|
| 0 | 149 | 5745 | 2.56 | 4.78 | 3.01 | 7.79 | 27.43 | Pass |
| | 157 | 5785 | 1.96 | 4.18 | 3.01 | 7.19 | 27.43 | Pass |
| | 165 | 5825 | 2.33 | 4.55 | 3.01 | 7.56 | 27.43 | Pass |
| 1 | 149 | 5745 | 2.30 | 4.52 | 3.01 | 7.53 | 27.43 | Pass |
| | 157 | 5785 | 2.12 | 4.34 | 3.01 | 7.35 | 27.43 | Pass |
| | 165 | 5825 | 2.17 | 4.39 | 3.01 | 7.40 | 27.43 | Pass |

Note:

1. Method 1 of power density measurement of KDB 662911 is using for calculating total power density. Total power density is summing entire spectra across corresponding frequency bins on the various outputs by computer.
2. Directional gain = $5.56\text{dBi} + 10\log(2) = 8.57\text{dBi} > 6\text{dBi}$, so the power density limit shall be reduced to $30 - (8.57 - 6) = 27.43\text{dBm}$.

802.11n (HT40)

| TX chain | Chan. | Freq. (MHz) | PSD W/O Duty Factor | | 10 log (N=2) dB | Duty Factor (dB) | Total PSD With Duty Factor (dBm/500kHz) | Limit (dBm/500kHz) | Pass / Fail |
|----------|-------|-------------|---------------------|--------------|-----------------|------------------|---|--------------------|-------------|
| | | | (dBm/300kHz) | (dBm/500kHz) | | | | | |
| 0 | 151 | 5755 | -1.03 | 1.19 | 3.01 | 0.16 | 4.36 | 27.43 | Pass |
| | 159 | 5795 | -0.75 | 1.47 | 3.01 | 0.16 | 4.64 | 27.43 | Pass |
| 1 | 151 | 5755 | -1.59 | 0.63 | 3.01 | 0.16 | 3.80 | 27.43 | Pass |
| | 159 | 5795 | -1.00 | 1.22 | 3.01 | 0.16 | 4.39 | 27.43 | Pass |

Note:

1. Method 1 of power density measurement of KDB 662911 is using for calculating total power density. Total power density is summing entire spectra across corresponding frequency bins on the various outputs by computer.
2. Directional gain = $5.56\text{dBi} + 10\log(2) = 8.57\text{dBi} > 6\text{dBi}$, so the power density limit shall be reduced to $30 - (8.57 - 6) = 27.43\text{dBm}$.
3. Refer to section 3.3 for duty cycle spectrum plot.

802.11ac (VHT80)

| TX chain | Chan. | Freq. (MHz) | PSD W/O Duty Factor | | 10 log (N=2) dB | Duty Factor (dB) | Total PSD With Duty Factor (dBm/500kHz) | Limit (dBm/500kHz) | Pass / Fail |
|----------|-------|-------------|---------------------|--------------|-----------------|------------------|---|--------------------|-------------|
| | | | (dBm/300kHz) | (dBm/500kHz) | | | | | |
| 0 | 155 | 5775 | -7.56 | -5.34 | 3.01 | 0.34 | -1.99 | 27.43 | Pass |
| 1 | 155 | 5775 | -7.97 | -5.75 | 3.01 | 0.34 | -2.40 | 27.43 | Pass |

Note:

1. Method 1 of power density measurement of KDB 662911 is using for calculating total power density. Total power density is summing entire spectra across corresponding frequency bins on the various outputs by computer.
2. Directional gain = $5.56\text{dBi} + 10\log(2) = 8.57\text{dBi} > 6\text{dBi}$, so the power density limit shall be reduced to $30 - (8.57 - 6) = 27.43\text{dBm}$.
3. Refer to section 3.3 for duty cycle spectrum plot.

Spectrum Plot of Worst Value

802.11a

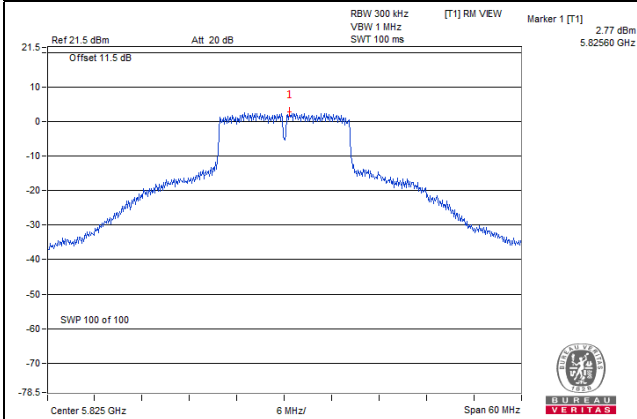

802.11n (HT20)

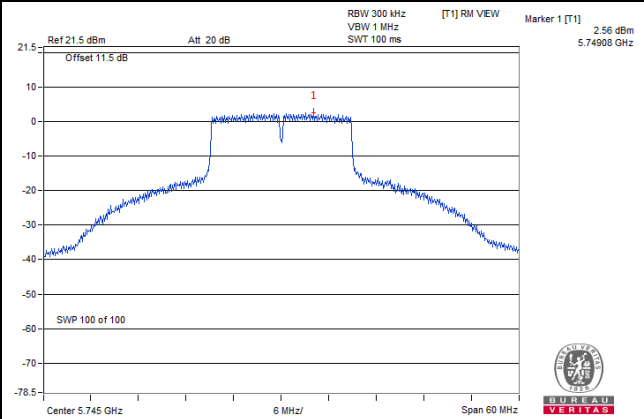

802.11n (HT40)

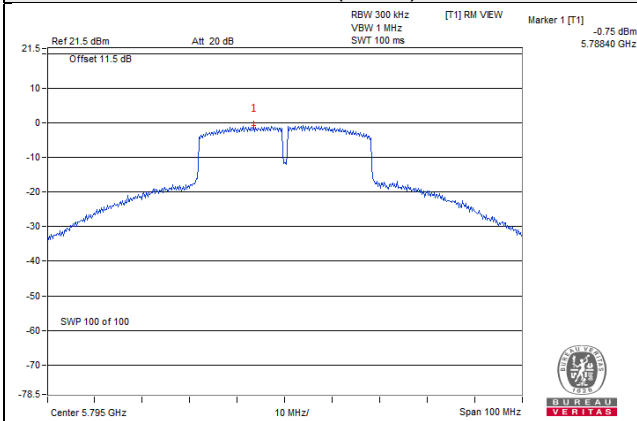

802.11ac (VHT80)

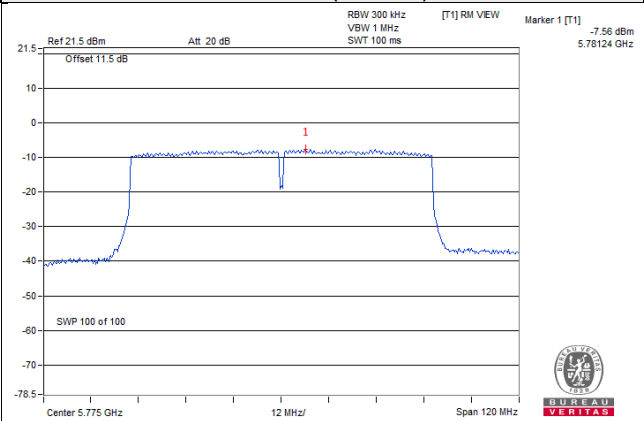

4.6 Frequency Stability

4.6.1 Limits of Frequency Stability Measurement

The frequency of the carrier signal shall be maintained within band of operation

4.6.2 Test Setup

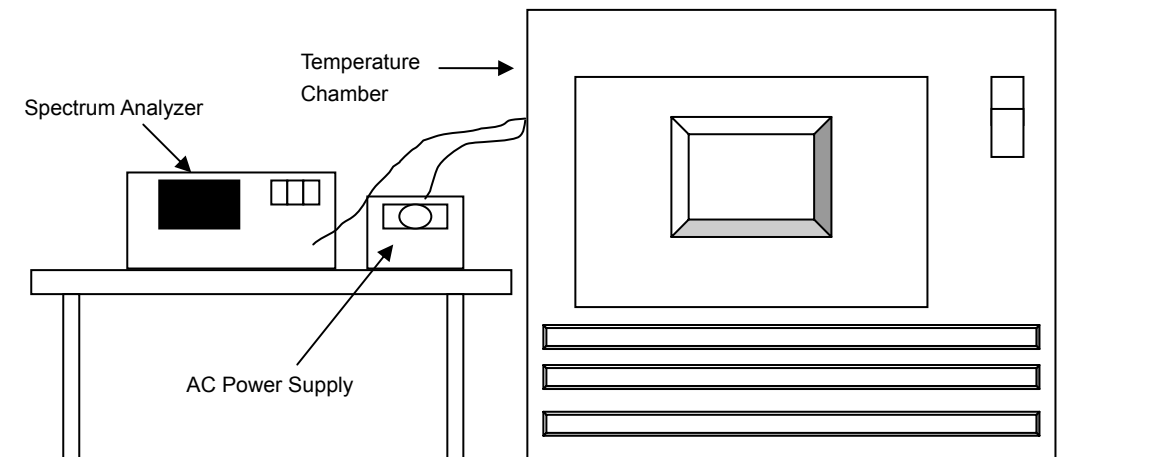

4.6.3 Test Instruments

Refer to section 4.1.2 to get information of above instrument.

4.6.4 Test Procedure

- The EUT was placed inside the environmental test chamber and powered by nominal AC voltage.
- Turn the EUT on and couple its output to a spectrum analyzer.
- Turn the EUT off and set the chamber to the highest temperature specified.
- Allow sufficient time (approximately 30 min) for the temperature of the chamber to stabilize, turn the EUT on and measure the operating frequency after 2, 5, and 10 minutes.
- Repeat step 2 and 3 with the temperature chamber set to the lowest temperature.
- The test chamber was allowed to stabilize at +20 degree C for a minimum of 30 minutes. The supply voltage was then adjusted on the EUT from 85% to 115% and the frequency record.

4.6.5 Deviation from Test Standard

No deviation.

4.6.6 EUT Operating Condition

Set the EUT transmit at un-modulation mode to test frequency stability.

4.6.7 Test Results

| Frequency Stability Versus Temp. | | | | | | | | | |
|----------------------------------|--------------------------|--------------------------------|--------|--------------------------------|--------|--------------------------------|--------|--------------------------------|--------|
| Operating Frequency: 5180MHz | | | | | | | | | |
| Temp. (°C) | Power Supply (Vac) | 0 Minute | | 2 Minute | | 5 Minute | | 10 Minute | |
| | | Measured Frequency (MHz) | Result | Measured Frequency (MHz) | Result | Measured Frequency (MHz) | Result | Measured Frequency (MHz) | Result |
| 50 | 120 | 5179.9905 | Pass | 5179.9857 | Pass | 5179.9905 | Pass | 5179.9877 | Pass |
| 40 | 120 | 5179.9933 | Pass | 5179.9917 | Pass | 5179.9932 | Pass | 5179.9933 | Pass |
| 30 | 120 | 5179.9845 | Pass | 5179.9847 | Pass | 5179.9846 | Pass | 5179.9845 | Pass |
| 20 | 120 | 5179.9803 | Pass | 5179.9786 | Pass | 5179.9786 | Pass | 5179.9808 | Pass |
| 10 | 120 | 5179.9802 | Pass | 5179.9791 | Pass | 5179.9757 | Pass | 5179.9784 | Pass |
| 0 | 120 | 5179.994 | Pass | 5179.9928 | Pass | 5179.995 | Pass | 5179.9919 | Pass |
| -10 | 120 | 5179.9786 | Pass | 5179.9816 | Pass | 5179.9805 | Pass | 5179.9822 | Pass |
| -20 | 120 | 5179.9885 | Pass | 5179.9856 | Pass | 5179.9876 | Pass | 5179.9887 | Pass |
| -30 | 120 | 5180.0007 | Pass | 5180.0031 | Pass | 5179.9993 | Pass | 5180.0037 | Pass |

| Frequency Stability Versus Voltage | | | | | | | | | |
|------------------------------------|--------------------------|--------------------------------|--------|--------------------------------|--------|--------------------------------|--------|--------------------------------|--------|
| Operating Frequency: 5180MHz | | | | | | | | | |
| Temp. (°C) | Power Supply (Vac) | 0 Minute | | 2 Minute | | 5 Minute | | 10 Minute | |
| | | Measured Frequency (MHz) | Result | Measured Frequency (MHz) | Result | Measured Frequency (MHz) | Result | Measured Frequency (MHz) | Result |
| 20 | 138 | 5179.9801 | Pass | 5179.9778 | Pass | 5179.9796 | Pass | 5179.9811 | Pass |
| | 120 | 5179.9803 | Pass | 5179.9786 | Pass | 5179.9786 | Pass | 5179.9808 | Pass |
| | 102 | 5179.9794 | Pass | 5179.979 | Pass | 5179.978 | Pass | 5179.9809 | Pass |

4.7 6dB Bandwidth Measurement

4.7.1 Limits of 6dB Bandwidth Measurement

The minimum of 6dB Bandwidth Measurement is 0.5MHz.

4.7.2 Test Setup

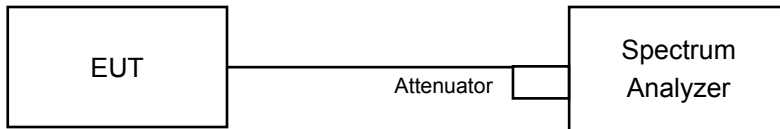

4.7.3 Test Instruments

Refer to section 4.1.2 to get information of above instrument.

4.7.4 Test Procedure

Measurement Procedure REF

- Set resolution bandwidth (RBW) = 100kHz
- Set the video bandwidth (VBW) $\geq 3 \times$ RBW, Detector = Peak.
- Trace mode = max hold.
- Sweep = auto couple.
- Measure the maximum width of the emission that is constrained by the frequencies associated with the two amplitude points (upper and lower) that are attenuated by 6 dB relative to the maximum level measured in the fundamental emission

4.7.5 Deviation from Test Standard

No deviation.

4.7.6 EUT Operating Condition

The software provided by client to enable the EUT under transmission condition continuously at lowest, middle and highest channel frequencies individually.

4.7.7 Test Results

802.11a

| Channel | Frequency (MHz) | 6dB Bandwidth (MHz) | | Minimum Limit (MHz) | Pass / Fail |
|---------|-----------------|---------------------|---------|---------------------|-------------|
| | | Chain 0 | Chain 1 | | |
| 149 | 5745 | 16.35 | 16.36 | 0.5 | Pass |
| 157 | 5785 | 16.37 | 16.37 | 0.5 | Pass |
| 165 | 5825 | 16.35 | 16.36 | 0.5 | Pass |

802.11n (HT20)

| Channel | Frequency (MHz) | 6dB Bandwidth (MHz) | | Minimum Limit (MHz) | Pass / Fail |
|---------|-----------------|---------------------|---------|---------------------|-------------|
| | | Chain 0 | Chain 1 | | |
| 149 | 5745 | 17.63 | 17.60 | 0.5 | Pass |
| 157 | 5785 | 17.62 | 17.58 | 0.5 | Pass |
| 165 | 5825 | 17.62 | 17.57 | 0.5 | Pass |

802.11n (HT40)

| Channel | Frequency (MHz) | 6dB Bandwidth (MHz) | | Minimum Limit (MHz) | Pass / Fail |
|---------|-----------------|---------------------|---------|---------------------|-------------|
| | | Chain 0 | Chain 1 | | |
| 151 | 5755 | 35.24 | 35.31 | 0.5 | Pass |
| 159 | 5795 | 35.27 | 35.46 | 0.5 | Pass |

802.11ac (VHT80)

| Channel | Frequency (MHz) | 6dB Bandwidth (MHz) | | Minimum Limit (MHz) | Pass / Fail |
|---------|-----------------|---------------------|---------|---------------------|-------------|
| | | Chain 0 | Chain 1 | | |
| 155 | 5775 | 76.44 | 75.65 | 0.5 | Pass |

Spectrum Plot of Worst Value

802.11a

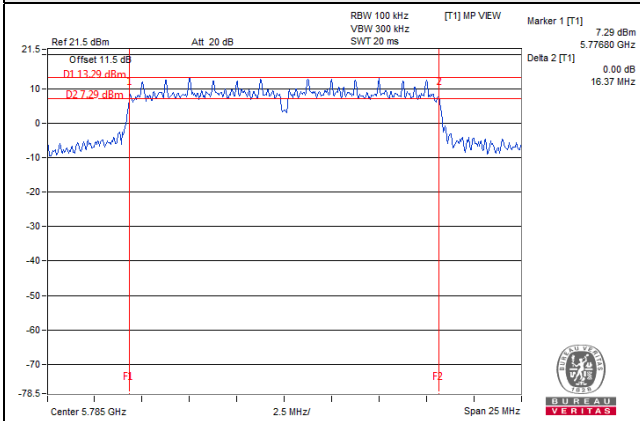

802.11n (HT20)

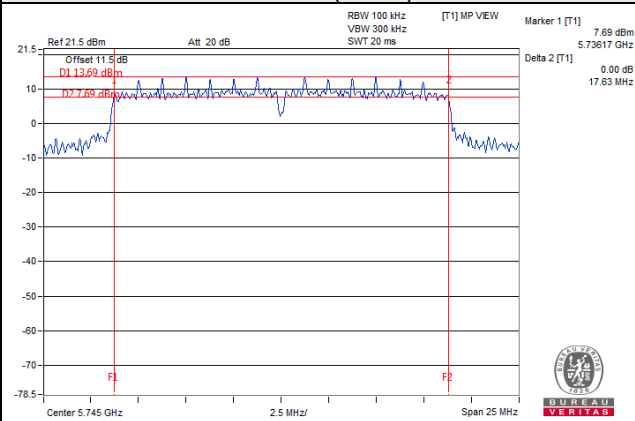

802.11n (HT40)

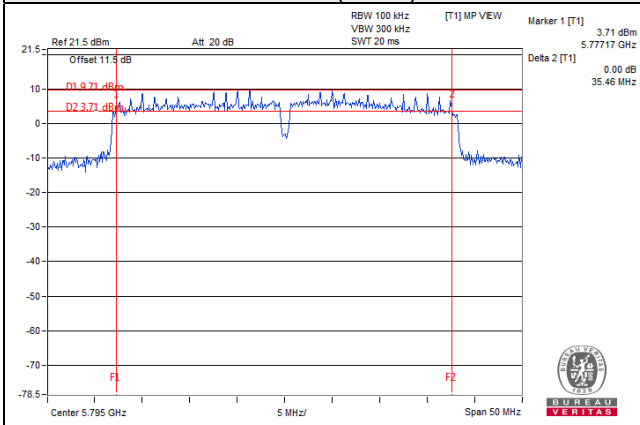

802.11ac (VHT80)

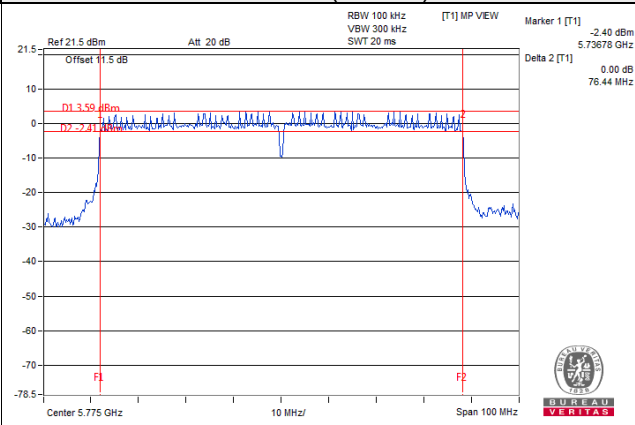

5 Pictures of Test Arrangements

Please refer to the attached file (Test Setup Photo).

Annex A- Radiated Out of Band Emission (OOBE) Measurement (For U-NII-3 band)

802.11a

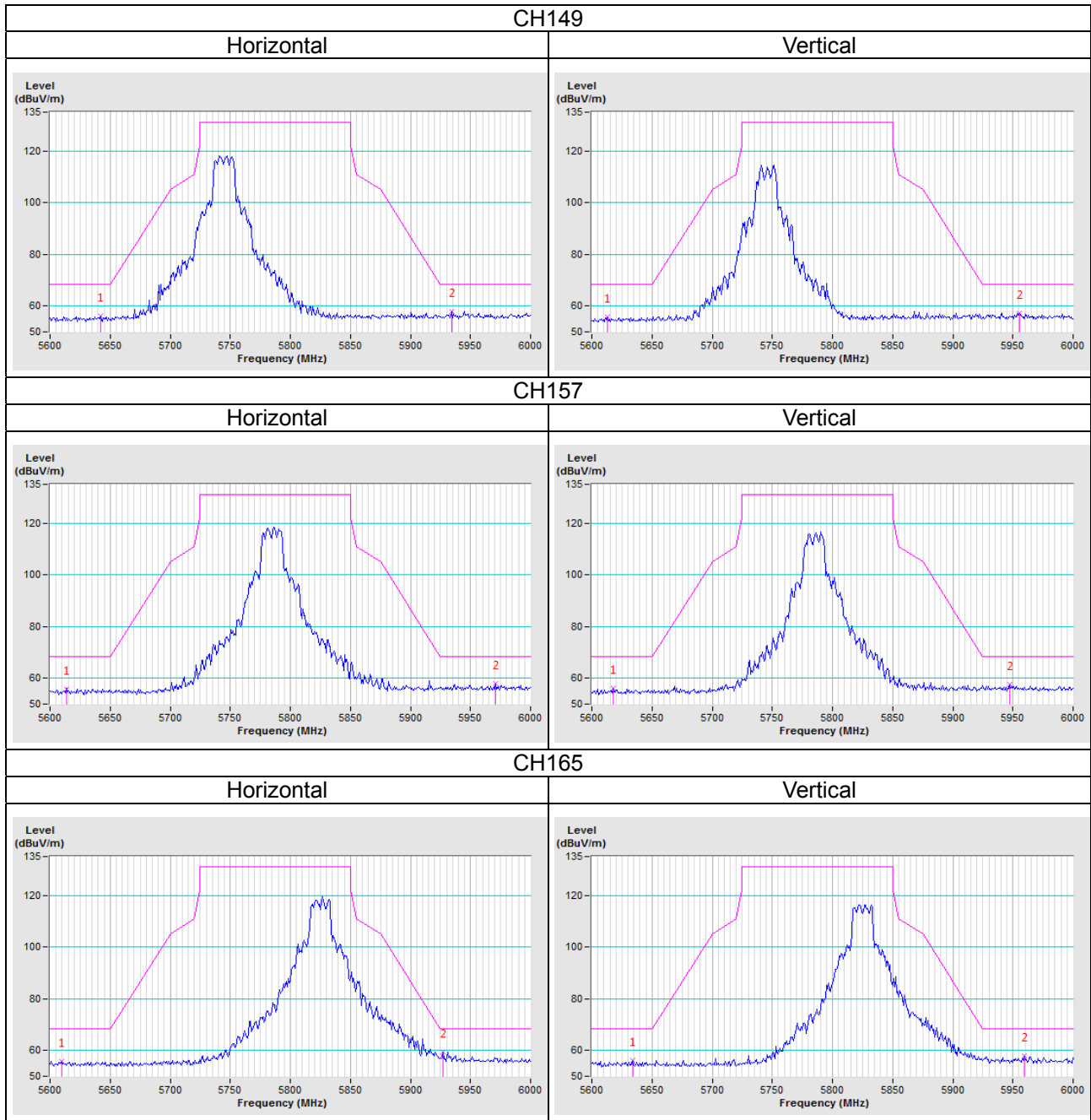

802.11n (HT20)

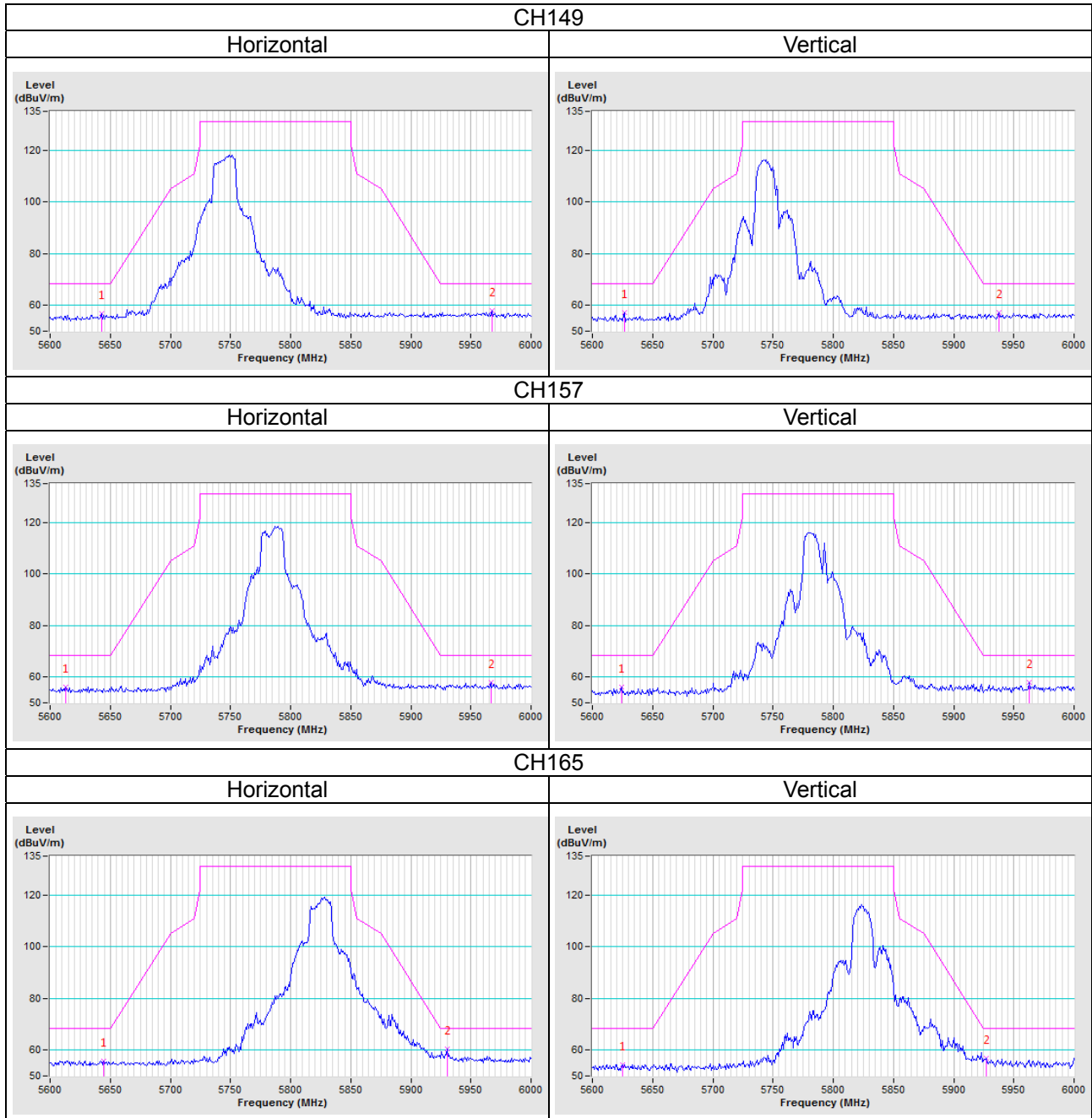

802.11n (HT40)

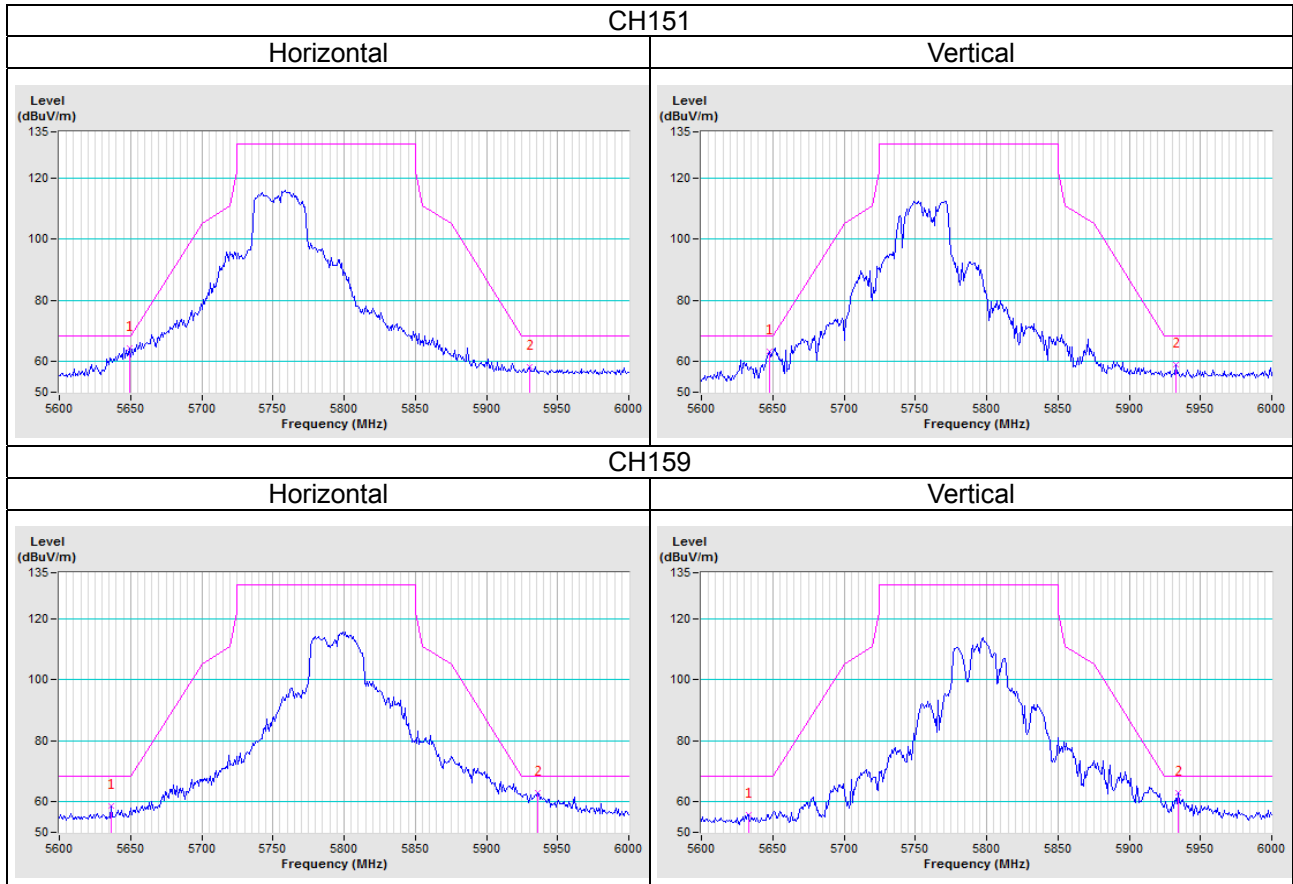

802.11ac (VHT80)

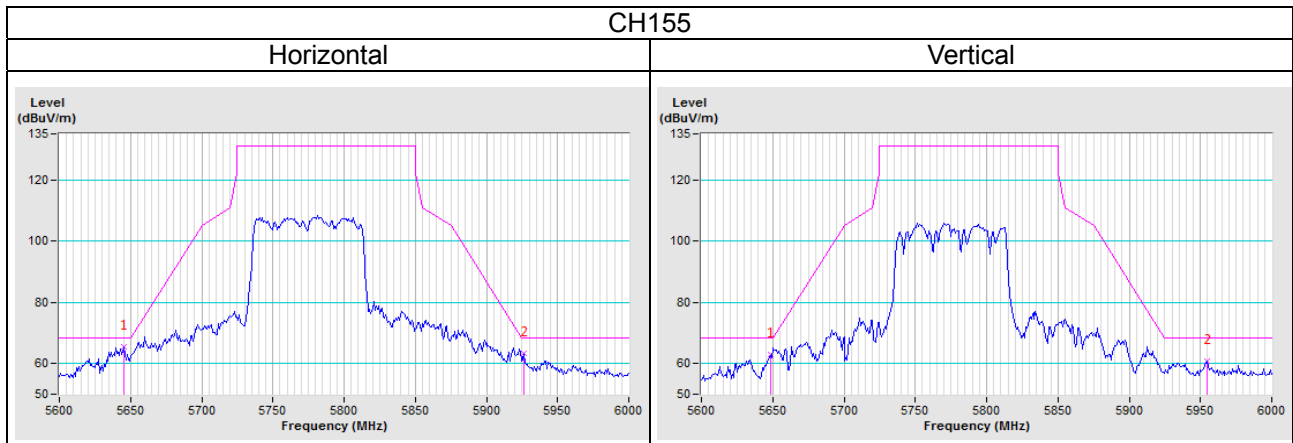

Appendix – Information on the Testing Laboratories

We, Bureau Veritas Consumer Products Services (H.K.) Ltd., Taoyuan Branch, were founded in 1988 to provide our best service in EMC, Radio, Telecom and Safety consultation. Our laboratories are FCC recognized accredited test firms and accredited and approved according to ISO/IEC 17025.

If you have any comments, please feel free to contact us at the following:

Linko EMC/RF Lab

Tel: 886-2-26052180

Fax: 886-2-26051924

Hsin Chu EMC/RF/Telecom Lab

Tel: 886-3-6668565

Fax: 886-3-6668323

Hwa Ya EMC/RF/Safety

Tel: 886-3-3183232

Fax: 886-3-3270892

Email: service.adt@tw.bureauveritas.com

Web Site: www.bureauveritas-adt.com

The address and road map of all our labs can be found in our web site also.

--- END ---