

FCC Test Report

(For 5.18 ~ 5.24GHz, 5.745 ~ 5.825GHz)

Report No.: RF170601E12-1

FCC ID: 2AKCZ-0C2

Test Model: APL43-0C2

Received Date: June 01, 2017

Test Date: June 15 to Aug. 01, 2017

Issued Date: Aug. 23, 2017

Applicant: SonicWall Inc.

Address: 5455 Great America Parkway, Santa Clara, CA 95054 USA

Issued By: Bureau Veritas Consumer Products Services (H.K.) Ltd., Taoyuan Branch
Hsin Chu Laboratory

Lab Address: E-2, No.1, Li Hsin 1st Road, Hsinchu Science Park, Hsinchu City 300,
Taiwan R.O.C.

Test Location (1): E-2, No.1, Li Hsin 1st Road, Hsinchu Science Park, Hsinchu City 300,
Taiwan R.O.C.

Test Location (2): No. 49, Ln. 206, Wende Rd., Shangshan Tsuen, Chiung Lin Hsiang, Hsin
Chu Hsien 307, Taiwan R.O.C.



This report is for your exclusive use. Any copying or replication of this report to or for any other person or entity, or use of our name or trademark, is permitted only with our prior written permission. This report sets forth our findings solely with respect to the test samples identified herein. The results set forth in this report are not indicative or representative of the quality or characteristics of the lot from which a test sample was taken or any similar or identical product unless specifically and expressly noted. Our report includes all of the tests requested by you and the results thereof based upon the information that you provided to us. You have 60 days from date of issuance of this report to notify us of any material error or omission caused by our negligence, provided, however, that such notice shall be in writing and shall specifically address the issue you wish to raise. A failure to raise such issue within the prescribed time shall constitute your unqualified acceptance of the completeness of this report, the tests conducted and the correctness of the report contents. Unless specifically mentioned, the uncertainty of measurement has been explicitly taken into account to declare the compliance or non-compliance to the specification. The report must not be used by the client to claim product certification, approval, or endorsement by TAF or any government agencies.

Table of Contents

Release Control Record	4
1 Certificate of Conformity	5
2 Summary of Test Results	6
2.1 Measurement Uncertainty	6
2.2 Modification Record	6
3 General Information	7
3.1 General Description of EUT	7
3.2 Description of Test Modes	9
3.2.1 Test Mode Applicability and Tested Channel Detail	10
3.3 Duty Cycle of Test Signal	12
3.4 Description of Support Units	13
3.4.1 Configuration of System under Test	14
3.5 General Description of Applied Standard	16
4 Test Types and Results	17
4.1 Radiated Emission and Bandedge Measurement	17
4.1.1 Limits of Radiated Emission and Bandedge Measurement	17
4.1.2 Test Instruments	18
4.1.3 Test Procedure	21
4.1.4 Deviation from Test Standard	21
4.1.5 Test Setup	22
4.1.6 EUT Operating Conditions	23
4.1.7 Test Results	24
4.2 Conducted Emission Measurement	43
4.2.1 Limits of Conducted Emission Measurement	43
4.2.2 Test Instruments	43
4.2.3 Test Procedure	44
4.2.4 Deviation from Test Standard	44
4.2.5 Test Setup	44
4.2.6 EUT Operating Conditions	44
4.2.7 Test Results	45
4.3 Transmit Power Measurement	47
4.3.1 Limits of Transmit Power Measurement	47
4.3.2 Test Setup	47
4.3.3 Test Instruments	47
4.3.4 Test Procedure	48
4.3.5 Deviation from Test Standard	48
4.3.6 EUT Operating Conditions	48
4.3.7 Test Result	49
4.4 Occupied Bandwidth Measurement	54
4.4.1 Test Setup	54
4.4.2 Test Instruments	54
4.4.3 Test Procedure	54
4.4.4 Test Results	55
4.5 Peak Power Spectral Density Measurement	65
4.5.1 Limits of Peak Power Spectral Density Measurement	65
4.5.2 Test Setup	65
4.5.3 Test Instruments	65
4.5.4 Test Procedure	66
4.5.5 Deviation from Test Standard	66
4.5.6 EUT Operating Condition	66
4.5.7 Test Results	67
4.6 Frequency Stability	74
4.6.1 Limits of Frequency Stability Measurement	74

4.6.2	Test Setup.....	74
4.6.3	Test Instruments	74
4.6.4	Test Procedure	74
4.6.5	Deviation from Test Standard	74
4.6.6	EUT Operating Condition	74
4.6.7	Test Results	75
4.7	6dB Bandwidth Measurement	76
4.7.1	Limits of 6dB Bandwidth Measurement.....	76
4.7.2	Test Setup.....	76
4.7.3	Test Instruments	76
4.7.4	Test Procedure	76
4.7.5	Deviation from Test Standard	76
4.7.6	EUT Operating Condition	76
4.7.7	Test Results	77
5	Pictures of Test Arrangements.....	79
	Annex A- Radiated Out of Band Emission (OOBE) Measurement (For U-NII-3 band)	80
	Appendix – Information on the Testing Laboratories	83

Release Control Record

Issue No.	Description	Date Issued
RF170601E12-1	Original release.	Aug. 23, 2017

1 Certificate of Conformity

Product: Wireless Access Point

Brand: SONICWALL

Test Model: APL43-0C2

Sample Status: ENGINEERING SAMPLE

Applicant: SonicWall Inc.

Test Date: June 15 to Aug. 01, 2017

Standard: 47 CFR FCC Part 15, Subpart E (Section 15.407)
ANSI C63.10:2013

The above equipment has been tested by **Bureau Veritas Consumer Products Services (H.K.) Ltd., Taoyuan Branch**, and found compliance with the requirement of the above standards. The test record, data evaluation & Equipment Under Test (EUT) configurations represented herein are true and accurate accounts of the measurements of the sample's EMC characteristics under the Conditions specified in this report.

Prepared by :  _____, **Date:** _____ Aug. 23, 2017
Claire Kuan / Specialist

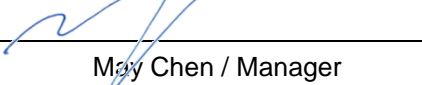
Approved by :  _____, **Date:** _____ Aug. 23, 2017
May Chen / Manager

2 Summary of Test Results

47 CFR FCC Part 15, Subpart E (Section 15.407)			
FCC Clause	Test Item	Result	Remarks
15.407(b)(6)	AC Power Conducted Emissions	Pass	Meet the requirement of limit. Minimum passing margin is -8.30dB at 0.35369MHz.
15.407(b)(1/2/3/4(i/ii)/6)	Radiated Emissions & Band Edge Measurement*	Pass	Meet the requirement of limit. Minimum passing margin is -1.1dB at 5134.00MHz.
15.407(a)(1/2/3)	Max Average Transmit Power	Pass	Meet the requirement of limit.
15.407(a)(1/2/3)	Peak Power Spectral Density	Pass	Meet the requirement of limit.
15.407(e)	6dB bandwidth	Pass	Meet the requirement of limit. (U-NII-3 Band only)
15.407(g)	Frequency Stability	Pass	Meet the requirement of limit.
15.203	Antenna Requirement	Pass	Antenna connector is RSMA not a standard connector.

*For U-NII-3 band compliance with rule part 15.407(b)(i), the OOB test plots were recorded in Annex A.

2.1 Measurement Uncertainty

Where relevant, the following measurement uncertainty levels have been estimated for tests performed on the EUT as specified in CISPR 16-4-2:

Measurement	Frequency	Expanded Uncertainty (k=2) (\pm)
Conducted Emissions at mains ports	150kHz ~ 30MHz	1.84 dB
Radiated Emissions up to 1 GHz	30MHz ~ 1GHz	5.32 dB
Radiated Emissions above 1 GHz	1GHz ~ 6GHz	5.14 dB
	6GHz ~ 18GHz	5.04 dB
	18GHz ~ 40GHz	5.25 dB

2.2 Modification Record

There were no modifications required for compliance.

3 General Information

3.1 General Description of EUT

Product	Wireless Access Point
Brand	SONICWALL
Test Model	APL43-0C2
Status of EUT	ENGINEERING SAMPLE
Power Supply Rating	48-55Vdc (POE)
Modulation Type	256QAM, 64QAM, 16QAM, QPSK, BPSK
Modulation Technology	OFDM
Transfer Rate	802.11a: 54/ 48/ 36/ 24/ 18/ 12/ 9/ 6Mbps 802.11n: up to 600Mbps 802.11ac: up to 1733Mbps
Operating Frequency	5180 ~ 5240MHz & 5745 ~ 5825MHz
Number of Channel	5180 ~ 5240MHz: 4 for 802.11a, 802.11n (HT20), 802.11ac (VHT20) 2 for 802.11n (HT40), 802.11ac (VHT40) 1 for 802.11ac (VHT80) 5745 ~ 5825MHz: 5 for 802.11a, 802.11n (HT20), 802.11ac (VHT20) 2 for 802.11n (HT40), 802.11ac (VHT40) 1 for 802.11ac (VHT80)
Output Power	Radio 2: 5180~5240MHz CDD Mode: 263.238 mW Beamforming Mode: 137.106 mW 5745~5825MHz CDD Mode: 566.969 mW Beamforming Mode: 140.499 mW
Antenna Type	Refer to Note
Antenna Connector	Refer to Note
Accessory Device	NA
Data Cable Supplied	NA

Note:

1. The EUT incorporates a MIMO function.

Band	Modulation Mode	TX Function	Beamforming	Radio
5GHz	802.11a	4TX	Not Support	Radio 2
	802.11n (HT20)	4TX	Support	
	802.11n (HT40)	4TX	Support	
	802.11ac (VHT20)	4TX	Support	
	802.11ac (VHT40)	4TX	Support	
	802.11ac (VHT80)	4TX	Support	

2. The EUT uses following antennas.

External antenna								Internal antenna		
Type	Dipole							PIFA		
Connector	RSMA							IPEX		
Radio	1				2				3	4
Frequency	2.4GHz				5GHz				2.4GHz	BT-LE
Antenna	1	2	3	4	5	6	7	8	9	10
Gain (dBi)	5.08	5.08	5.08	5.08	8.41	8.41	8.41	8.41	2.91	3.13

3. Radio 1 & Radio 2 & Radio 3 & BLE technologies can transmit at same time.

4. Spurious emission of the simultaneous operation (2.4GHz, 5GHz and BT LE) has been evaluated and no non-compliance was found.

5. The power settings are list as below.

Modulation Mode	Frequency (MHz)	Power Setting	
		CDD Mode	Beamforming mode
802.11a	5180	13.5	-
	5200	13	-
	5240	13	-
	5745	18.5	-
	5785	18.5	-
	5825	18.5	-
802.11ac (VHT20)	5180	13.5	13.5
	5200	13.5	13.5
	5240	13.5	13.5
	5745	18.5	12.5
	5785	18.5	12.5
	5825	18.5	12.5
802.11ac (VHT40)	5190	14.5	13.5
	5230	16.5	13.5
	5755	19	13
	5795	18.5	12.5
802.11ac (VHT80)	5210	7.5	7.5
	5775	15	12.5

6. The above EUT information is declared by manufacturer and for more detailed features description, please refer to the manufacturer's specifications or user's manual.

3.2 Description of Test Modes

FOR 5180 ~ 5240MHz

4 channels are provided for 802.11a, 802.11n (HT20), 802.11ac (VHT20):

Channel	Frequency	Channel	Frequency
36	5180 MHz	44	5220 MHz
40	5200 MHz	48	5240 MHz

2 channels are provided for 802.11n (HT40), 802.11ac (VHT40):

Channel	Frequency	Channel	Frequency
38	5190 MHz	46	5230 MHz

1 channel is provided for 802.11ac (VHT80):

Channel	Frequency
42	5210MHz

FOR 5745 ~ 5825MHz:

5 channels are provided for 802.11a, 802.11n (HT20), 802.11ac (VHT20):

Channel	Frequency	Channel	Frequency
149	5745MHz	161	5805MHz
153	5765MHz	165	5825MHz
157	5785MHz		

2 channels are provided for 802.11n (HT40), 802.11ac (VHT40):

Channel	Frequency	Channel	Frequency
151	5755MHz	159	5795MHz

1 channel is provided for 802.11ac (VHT80):

Channel	Frequency
155	5775MHz

3.2.1 Test Mode Applicability and Tested Channel Detail

EUT CONFIGURE MODE	APPLICABLE TO				DESCRIPTION
	RE \geq 1G	RE<1G	PLC	APCM	
-	√	√	√	√	-

Where **RE \geq 1G**: Radiated Emission above 1GHz **RE<1G**: Radiated Emission below 1GHz
PLC: Power Line Conducted Emission **APCM**: Antenna Port Conducted Measurement

Note: The EUT had been pre-tested on the positioned of each 3 axis. The worst case was found when positioned on **X-plane**.

Radiated Emission Test (Above 1GHz):

- Pre-Scan has been conducted to determine the worst-case mode from all possible combinations between available modulations, data rates and antenna ports (if EUT with antenna diversity architecture).
- Following channel(s) was (were) selected for the final test as listed below.

CDD Mode						
Mode	Freq. Band (MHz)	Available Channel	Tested Channel	Modulation Technology	Modulation Type	Data Rate (Mbps)
802.11a	5180-5240	36 to 48	36, 40, 48	OFDM	BPSK	6
802.11ac (VHT20)		36 to 48	36, 40, 48	OFDM	BPSK	6.5
802.11ac (VHT40)		38 to 46	38, 46	OFDM	BPSK	13.5
802.11ac (VHT80)		42	42	OFDM	BPSK	29.3
802.11a	5745-5825	149 to 165	149, 157, 165	OFDM	BPSK	6
802.11ac (VHT20)		149 to 165	149, 157, 165	OFDM	BPSK	6.5
802.11ac (VHT40)		151 to 159	151, 159	OFDM	BPSK	13.5
802.11ac (VHT80)		155	155	OFDM	BPSK	29.3

Radiated Emission Test (Below 1GHz):

- Pre-Scan has been conducted to determine the worst-case mode from all possible combinations between available modulations, data rates and antenna ports (if EUT with antenna diversity architecture).
- Following channel(s) was (were) selected for the final test as listed below.

CDD Mode						
Mode	Freq. Band (MHz)	Available Channel	Tested Channel	Modulation Technology	Modulation Type	Data Rate (Mbps)
802.11ac (VHT40)	5180-5240 5745-5825	38 to 46 151 to 159	151	OFDM	BPSK	13.5

Power Line Conducted Emission Test:

- Pre-Scan has been conducted to determine the worst-case mode from all possible combinations between available modulations, data rates and antenna ports (if EUT with antenna diversity architecture).
- Following channel(s) was (were) selected for the final test as listed below.

CDD Mode						
Mode	Freq. Band (MHz)	Available Channel	Tested Channel	Modulation Technology	Modulation Type	Data Rate (Mbps)
802.11ac (VHT40)	5180-5240 5745-5825	38 to 46 151 to 159	151	OFDM	BPSK	13.5

Antenna Port Conducted Measurement:

- This item includes all test value of each mode, but only includes spectrum plot of worst value of each mode.
- Pre-Scan has been conducted to determine the worst-case mode from all possible combinations between available modulations, data rates and antenna ports (if EUT with antenna diversity architecture).
- Following channel(s) was (were) selected for the final test as listed below.

CDD Mode						
Mode	Freq. Band (MHz)	Available Channel	Tested Channel	Modulation Technology	Modulation Type	Data Rate (Mbps)
802.11a	5180-5240	36 to 48	36, 40, 48	OFDM	BPSK	6
802.11ac (VHT20)		36 to 48	36, 40, 48	OFDM	BPSK	6.5
802.11ac (VHT40)		38 to 46	38, 46	OFDM	BPSK	13.5
802.11ac (VHT80)		42	42	OFDM	BPSK	29.3
802.11a	5745-5825	149 to 165	149, 157, 165	OFDM	BPSK	6
802.11ac (VHT20)		149 to 165	149, 157, 165	OFDM	BPSK	6.5
802.11ac (VHT40)		151 to 159	151, 159	OFDM	BPSK	13.5
802.11ac (VHT80)		155	155	OFDM	BPSK	29.3

Beamforming Mode (Output power only)						
Mode	Freq. Band (MHz)	Available Channel	Tested Channel	Modulation Technology	Modulation Type	Data Rate (Mbps)
802.11ac (VHT20)	5180-5240	36 to 48	36, 40, 48	OFDM	BPSK	6.5
802.11ac (VHT40)		38 to 46	38, 46	OFDM	BPSK	13.5
802.11ac (VHT80)		42	42	OFDM	BPSK	29.3
802.11ac (VHT20)	5745-5825	149 to 165	149, 157, 165	OFDM	BPSK	6.5
802.11ac (VHT40)		151 to 159	151, 159	OFDM	BPSK	13.5
802.11ac (VHT80)		155	155	OFDM	BPSK	29.3

Test Condition:

APPLICABLE TO	ENVIRONMENTAL CONDITIONS	INPUT POWER (SYSTEM)	TESTED BY
RE \geq 1G	25deg. C, 70%RH	120Vac, 60Hz	Andy Ho
RE $<$ 1G	22deg. C, 67%RH	120Vac, 60Hz	Weiwei Lo
PLC	25deg. C, 75%RH	120Vac, 60Hz	Andy Ho
APCM	25deg. C, 60%RH	120Vac, 60Hz	Robert Cheng

3.3 Duty Cycle of Test Signal

If duty cycle of test signal is $\geq 98\%$, duty factor is not required.

If duty cycle of test signal is $< 98\%$, duty factor is required

802.11a: Duty cycle = $2.027/2.089 = 0.97$, Duty factor = $10 * \log(1/0.97) = 0.13$

802.11ac (VHT20): Duty cycle = $4.966/5.033 = 0.987$

802.11ac (VHT40): Duty cycle = $2.415/2.484 = 0.972$, Duty factor = $10 * \log(1/0.972) = 0.12$

802.11ac (VHT80): Duty cycle = $1.135/1.205 = 0.942$, Duty factor = $10 * \log(1/0.942) = 0.26$

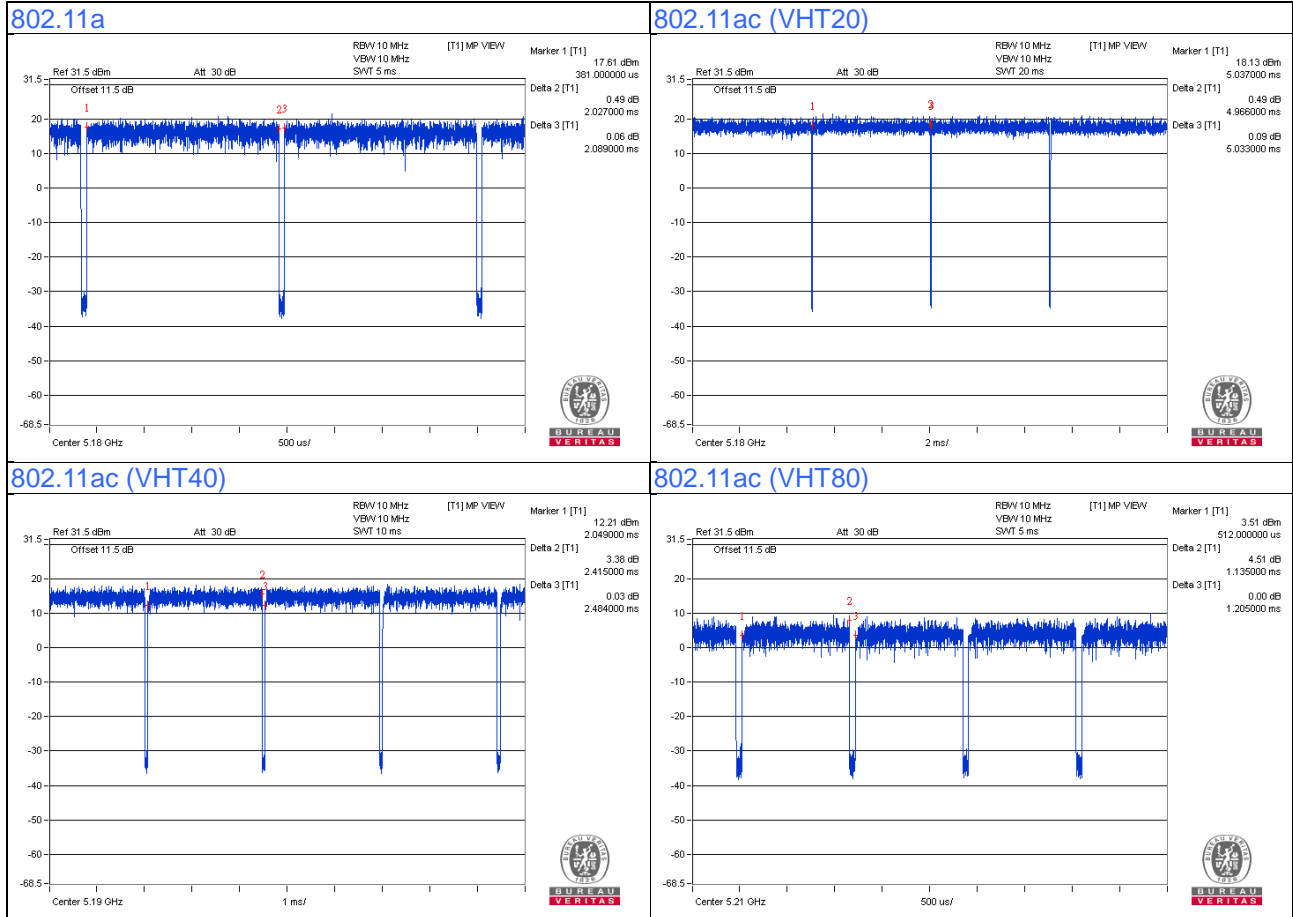

3.4 Description of Support Units

The EUT has been tested as an independent unit together with other necessary accessories or support units. The following support units or accessories were used to form a representative test configuration during the tests.

ID	Product	Brand	Model No.	Serial No.	FCC ID	Remarks
A.	PoE Adapter	Microsemi	PD-9501-10G	NA	NA	Supplied by client
B.	Laptop	DELL	E5430	HYV4VY1	FCC DoC	Provided by Lab
C.	Laptop	DELL	E5430	GM1SKV1	FCC DoC	Provided by Lab
D.	USB Disk 3.0	Transcend	16GB	NA	NA	Provided by Lab

Note:

1. All power cords of the above support units are non-shielded (1.8m).

ID	Descriptions	Qty.	Length (m)	Shielding (Yes/No)	Cores (Qty.)	Remarks
1.	RJ-45 Cable	1	10	No	0	Provided by Lab
2.	RJ-45 Cable	1	10	No	0	Provided by Lab
3.	Console Cable	1	1.6	No	0	Provided by Lab
4.	RJ-45 Cable	1	3	No	0	Provided by Lab

3.4.1 Configuration of System under Test

For conducted emission test:

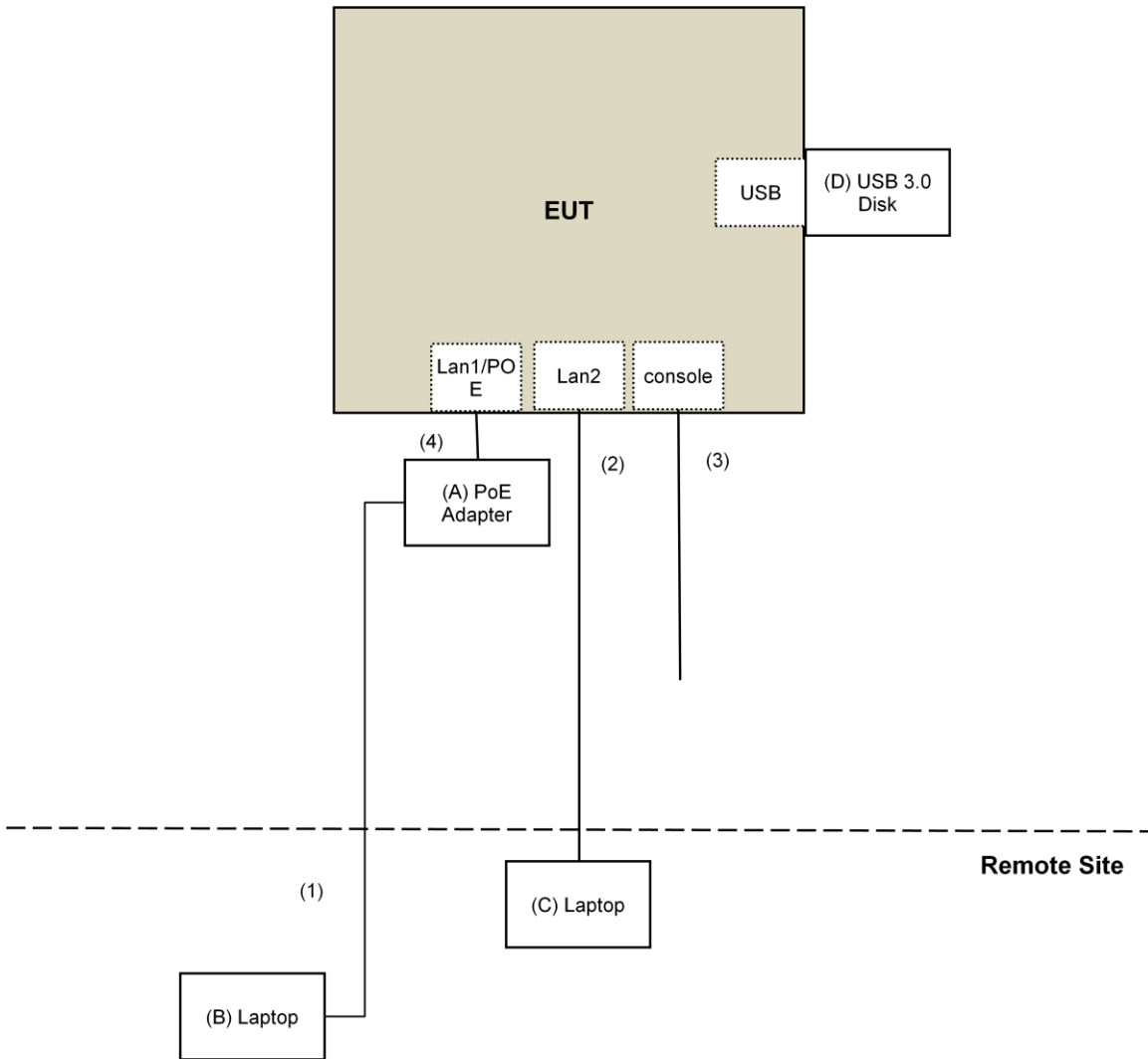

For other test items:

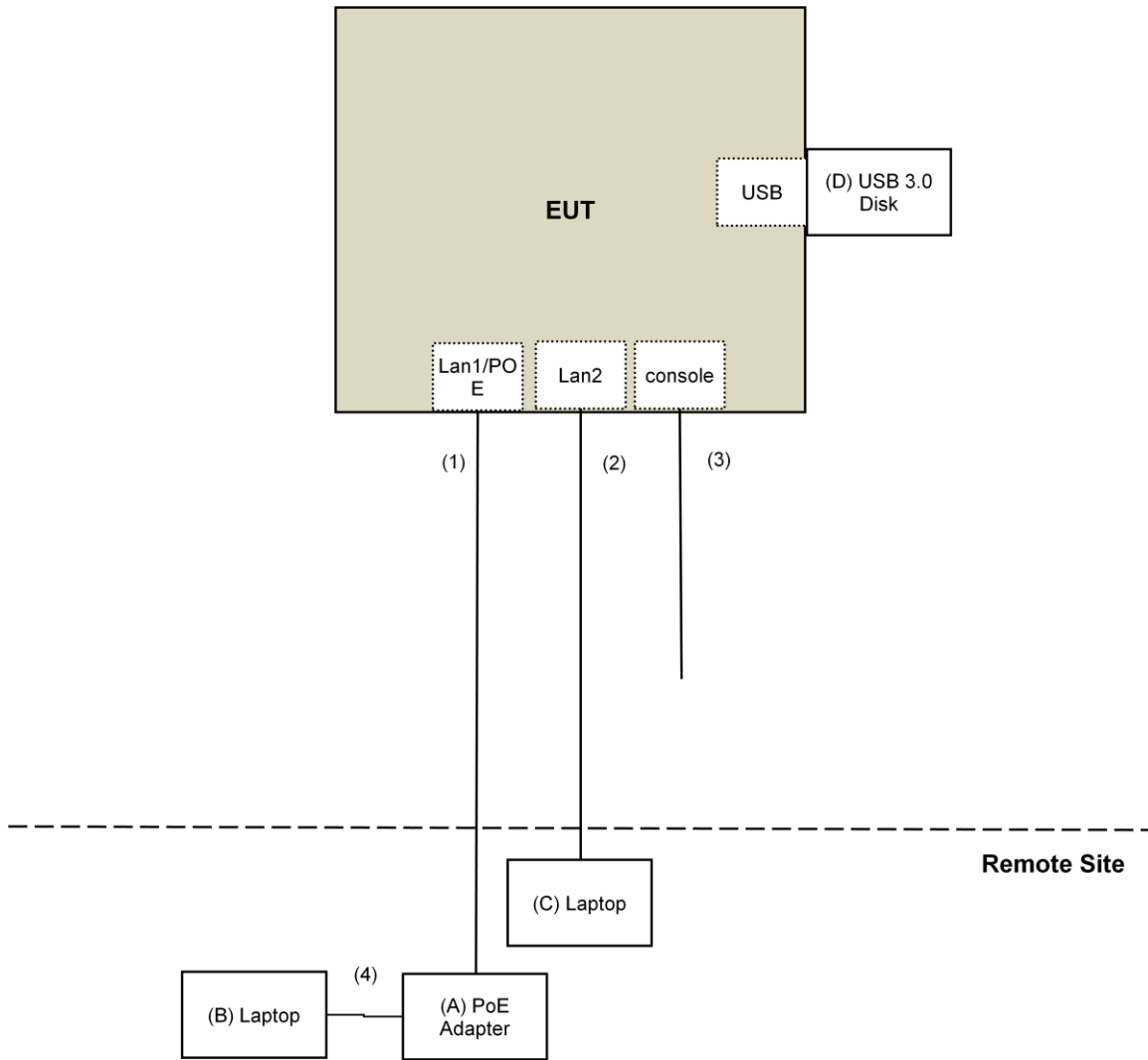

3.5 General Description of Applied Standard

The EUT is a RF Product. According to the specifications of the manufacturer, it must comply with the requirements of the following standards:

FCC Part 15, Subpart E (15.407)
KDB 789033 D02 General UNII Test Procedure New Rules v01r04
KDB 662911 D01 Multiple Transmitter Output v02r01
ANSI C63.10-2013

All test items have been performed and recorded as per the above standards.

NOTE: The EUT has been verified to comply with the requirements of FCC Part 15, Subpart B, Class B (DoC). The test report has been issued separately.

4 Test Types and Results

4.1 Radiated Emission and Bandedge Measurement

4.1.1 Limits of Radiated Emission and Bandedge Measurement

Radiated emissions which fall in the restricted bands must comply with the radiated emission limits specified as below table.

Frequencies (MHz)	Field Strength (microvolts/meter)	Measurement Distance (meters)
0.009 ~ 0.490	2400/F(kHz)	300
0.490 ~ 1.705	24000/F(kHz)	30
1.705 ~ 30.0	30	30
30 ~ 88	100	3
88 ~ 216	150	3
216 ~ 960	200	3
Above 960	500	3

NOTE:

1. The lower limit shall apply at the transition frequencies.
2. Emission level (dBuV/m) = 20 log Emission level (uV/m).
3. For frequencies above 1000MHz, the field strength limits are based on average detector, however, the peak field strength of any emission shall not exceed the maximum permitted average limits, specified above by more than 20dB under any Condition of modulation.

Limits of Unwanted Emission Out of the Restricted Bands

Applicable To		Limit	
789033 D02 General UNII Test Procedure New Rules v01r04		Field Strength at 3m	
		PK:74 (dBµV/m)	AV:54 (dBµV/m)
Frequency Band	Applicable To	EIRP Limit	Equivalent Field Strength at 3m
5150~5250 MHz	15.407(b)(1)	PK:-27 (dBm/MHz)	PK:68.2(dBµV/m)
5250~5350 MHz	15.407(b)(2)		
5470~5725 MHz	15.407(b)(3)		
5725~5850 MHz	<input checked="" type="checkbox"/> 15.407(b)(4)(i)	PK:-27 (dBm/MHz) ^{*1} PK:10 (dBm/MHz) ^{*2} PK:15.6 (dBm/MHz) ^{*3} PK:27 (dBm/MHz) ^{*4}	PK: 68.2(dBµV/m) ^{*1} PK:105.2 (dBµV/m) ^{*2} PK: 110.8(dBµV/m) ^{*3} PK:122.2 (dBµV/m) ^{*4}
	<input type="checkbox"/> 15.407(b)(4)(ii)	Emission limits in section 15.247(d)	
^{*1} beyond 75 MHz or more above of the band edge.		^{*2} below the band edge increasing linearly to 10 dBm/MHz at 25 MHz above.	
^{*3} below the band edge increasing linearly to a level of 15.6 dBm/MHz at 5 MHz above.		^{*4} from 5 MHz above or below the band edge increasing linearly to a level of 27 dBm/MHz at the band edge.	

NOTE: The following formula is used to convert the equipment isotropic radiated power (eirp) to field strength:

$$E = \frac{1000000\sqrt{30P}}{3} \mu\text{V/m, where } P \text{ is the eirp (Watts).}$$

4.1.2 Test Instruments

For Radiated Out of Band Emission (OOBE) test:

DESCRIPTION & MANUFACTURER	MODEL NO.	SERIAL NO.	CALIBRATED DATE	CALIBRATED UNTIL
Test Receiver Agilent	N9038A	MY50010156	Aug. 18, 2016	Aug. 17, 2017
Horn_Antenna SCHWARZBECK	BBHA9120-D	9120D-406	Dec. 28, 2016	Dec. 27, 2017
Pre-Amplifier EMCI	EMC12630SE	980384	Feb. 02, 2017	Feb. 01, 2018
RF Cable	EMC104-SM-SM-1200 EMC104-SM-SM-2000 EMC104-SM-SM-5000	160922 150317 150322	Feb. 02, 2017 Mar. 29, 2017 Mar. 29, 2017	Feb. 01, 2018 Mar. 28, 2018 Mar. 28, 2018
Spectrum Analyzer Keysight	N9030A	MY54490520	July 29, 2016	July 28, 2017
Pre-Amplifier EMCI	EMC184045SE	980386	Feb. 02, 2017	Feb. 01, 2018
Horn_Antenna SCHWARZBECK	BBHA 9170	BBHA9170608	Dec. 15, 2016	Dec. 14, 2017
RF Cable	SUCOFLEX 102	36432/2 36433/2	Jan. 15, 2017	Jan. 14, 2018
Software	ADT_Radiated_V8.7.08	NA	NA	NA
Antenna Tower & Turn Table Max-Full	MF-7802	MF780208406	NA	NA
Boresight Antenna Fixture	FBA-01	FBA-SIP01	NA	NA

Note:

1. The calibration interval of the above test instruments is 12 months and the calibrations are traceable to NML/ROC and NIST/USA.
2. The test was performed in 966 Chamber No. 3.
3. The CANADA Site Registration No. is 20331-1
4. Tested Date: June 23, 2017

For other test items:

DESCRIPTION & MANUFACTURER	MODEL NO.	SERIAL NO.	CALIBRATED DATE	CALIBRATED UNTIL
Test Receiver Agilent	N9038A	MY50010156	Aug. 18, 2016	Aug. 17, 2017
Pre-Amplifier ^(*) EMCI	EMC001340	980142	Jan. 20, 2016	Jan. 19, 2018
Loop Antenna ^(*) Electro-Metrics	EM-6879	264	Dec. 16, 2016	Dec. 15, 2018
RF Cable	NA	LOOPCAB-001 LOOPCAB-002	Jan. 17, 2017	Jan. 16, 2018
Pre-Amplifier Mini-Circuits	ZFL-1000VH2B	AMP-ZFL-05	May 06, 2017	May 05, 2018
Trilog Broadband Antenna SCHWARZBECK	VULB 9168	9168-361	Dec. 29, 2016	Dec. 28, 2017
RF Cable	8D	966-3-1 966-3-2 966-3-3	Apr. 01, 2017	Mar. 31, 2018
Fixed attenuator Mini-Circuits	UNAT-5+	PAD-3m-3-01	Oct. 05, 2016	Oct. 04, 2017
Horn_Antenna SCHWARZBECK	BBHA9120-D	9120D-406	Dec. 28, 2016	Dec. 27, 2017
Pre-Amplifier EMCI	EMC12630SE	980384	Feb. 02, 2017	Feb. 01, 2018
RF Cable	EMC104-SM-SM-1200 EMC104-SM-SM-2000 EMC104-SM-SM-5000	160922 150317 150322	Feb. 02, 2017 Mar. 29, 2017 Mar. 29, 2017	Feb. 01, 2018 Mar. 28, 2018 Mar. 28, 2018
Spectrum Analyzer Keysight	N9030A	MY54490570	July 08, 2017	July 07, 2018
Pre-Amplifier EMCI	EMC184045SE	980386	Feb. 02, 2017	Feb. 01, 2018
Horn_Antenna SCHWARZBECK	BBHA 9170	BBHA9170608	Dec. 15, 2016	Dec. 14, 2017
RF Cable	SUCOFLEX 102	36432/2 36433/2	Jan. 15, 2017	Jan. 14, 2018
Software	ADT_Radiated_V8.7.08	NA	NA	NA
Antenna Tower & Turn Table Max-Full	MF-7802	MF780208406	NA	NA
Boresight Antenna Fixture	FBA-01	FBA-SIP01	NA	NA
Spectrum Analyzer Agilent	E4446A	MY48250253	Dec. 21, 2016	Dec. 20, 2017
Power meter Anritsu	ML2495A	1014008	May 11, 2017	May 10, 2018
Power sensor Anritsu	MA2411B	0917122	May 11, 2017	May 10, 2018

Note:

1. The calibration interval of the above test instruments is 12 months and the calibrations are traceable to NML/ROC and NIST/USA.
2. The test was performed in 966 Chamber No. 3.
3. The CANADA Site Registration No. is 20331-1
4. Tested Date: July 28 to Aug. 01, 2017

4.1.3 Test Procedure

For Radiated emission below 30MHz

- a. The EUT was placed on the top of a rotating table 0.8 meters above the ground at a 3 meter chamber room. The table was rotated 360 degrees to determine the position of the highest radiation.
- b. The EUT was set 3 meters away from the interference-receiving antenna, which was mounted on the top of a variable-height antenna tower.
- c. Both X and Y axes of the antenna are set to make the measurement.
- d. For each suspected emission, the EUT was arranged to its worst case and the rotatable table was turned from 0 degrees to 360 degrees to find the maximum reading.
- e. The test-receiver system was set to Quasi-Peak Detect Function and Specified Bandwidth with Maximum Hold Mode.

NOTE:

1. The resolution bandwidth and video bandwidth of test receiver/spectrum analyzer is 9kHz at frequency below 30MHz.

For Radiated emission above 30MHz

- a. The EUT was placed on the top of a rotating table 0.8 meters (for 30MHz ~ 1GHz) / 1.5 meters (for above 1GHz) above the ground at 3 meter chamber room for test. The table was rotated 360 degrees to determine the position of the highest radiation.
- b. The EUT was set 3 meters away from the interference-receiving antenna, which was mounted on the top of a variable-height antenna tower.
- c. The height of antenna is varied from one meter to four meters above the ground to determine the maximum value of the field strength. Both horizontal and vertical polarizations of the antenna are set to make the measurement.
- d. For each suspected emission, the EUT was arranged to its worst case and then the antenna was tuned to heights from 1 meter to 4 meters and the rotatable table was turned from 0 degrees to 360 degrees to find the maximum reading.
- e. The test-receiver system was set to quasi-peak detect function and specified bandwidth with maximum hold mode when the test frequency is below 1 GHz.
- f. The test-receiver system was set to peak and average detect function and specified bandwidth with maximum hold mode when the test frequency is above 1 GHz. If the peak reading value also meets average limit, measurement with the average detector is unnecessary.

Note:

1. The resolution bandwidth and video bandwidth of test receiver/spectrum analyzer is 120kHz for Quasi-peak detection (QP) at frequency below 1GHz.
2. The resolution bandwidth of test receiver/spectrum analyzer is 1 MHz and the video bandwidth is 3 MHz for Peak detection (PK) at frequency above 1GHz.
3. The resolution bandwidth of test receiver/spectrum analyzer is 1MHz and the video bandwidth is $\geq 1/T$ (Duty cycle < 98%) or 10Hz (Duty cycle $\geq 98\%$) for Average detection (AV) at frequency above 1GHz.
4. All modes of operation were investigated and the worst-case emissions are reported.

4.1.4 Deviation from Test Standard

No deviation.

4.1.5 Test Setup

For Radiated emission below 30MHz

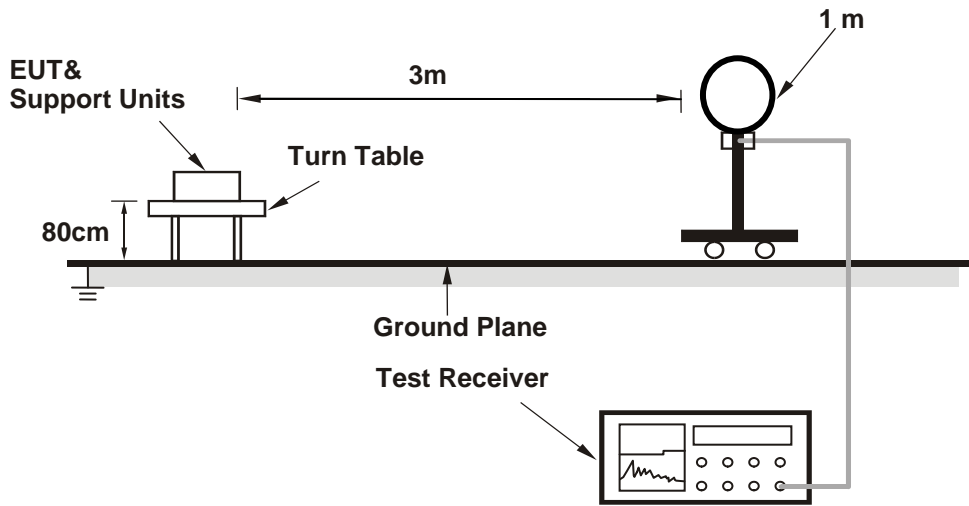

For Radiated emission 30MHz to 1GHz

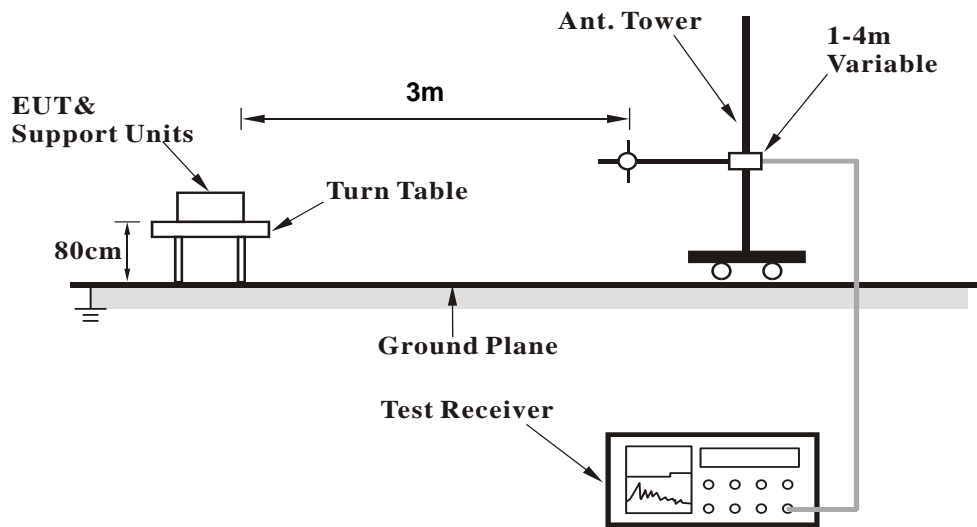

For Radiated emission above 1GHz

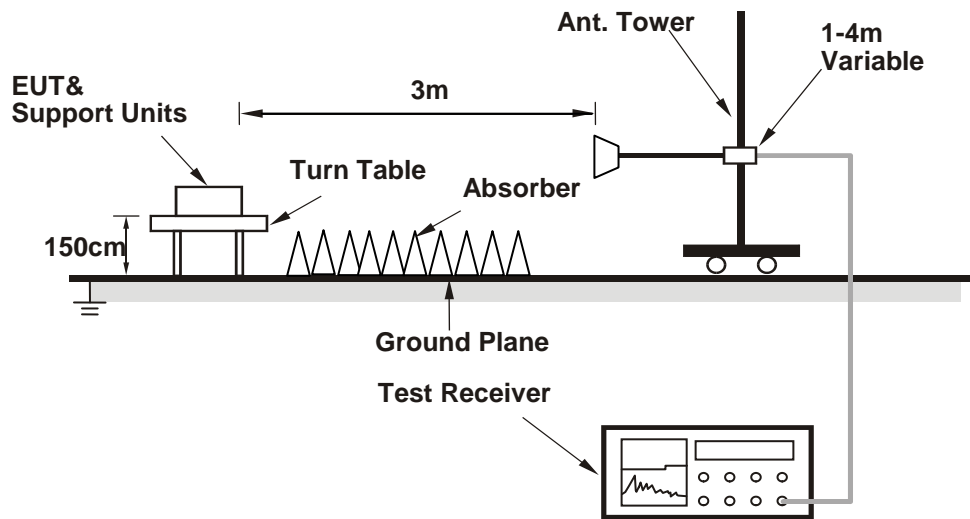

For the actual test configuration, please refer to the attached file (Test Setup Photo).

4.1.6 EUT Operating Conditions

- a. Connected the EUT with the Laptop which is placed on remote site.
- b. Controlling software (QRCT Ver3.0.187.0) has been activated to set the EUT on specific status.

4.1.7 Test Results

Above 1GHz Data :

802.11a

CHANNEL	TX Channel 36	DETECTOR FUNCTION	Peak (PK)
FREQUENCY RANGE	1GHz ~ 40GHz		Average (AV)

ANTENNA POLARITY & TEST DISTANCE: HORIZONTAL AT 3 M								
NO.	FREQ. (MHz)	EMISSION LEVEL (dBuV/m)	LIMIT (dBuV/m)	MARGIN (dB)	ANTENNA HEIGHT (m)	TABLE ANGLE (Degree)	RAW VALUE (dBuV)	CORRECTION FACTOR (dB/m)
1	5150.00	46.9 PK	74.0	-27.1	1.10 H	360	43.2	3.7
2	5150.00	36.7 AV	54.0	-17.3	1.10 H	360	33.0	3.7
3	*5180.00	103.7 PK			1.10 H	360	100.0	3.7
4	*5180.00	93.1 AV			1.10 H	360	89.4	3.7
5	#10360.00	57.2 PK	74.0	-16.8	1.39 H	324	44.2	13.0
6	#10360.00	43.7 AV	54.0	-10.3	1.39 H	324	30.7	13.0
7	15540.00	45.4 PK	74.0	-28.6	1.50 H	335	32.3	13.1
8	15540.00	33.8 AV	54.0	-20.2	1.50 H	335	20.7	13.1
ANTENNA POLARITY & TEST DISTANCE: VERTICAL AT 3 M								
NO.	FREQ. (MHz)	EMISSION LEVEL (dBuV/m)	LIMIT (dBuV/m)	MARGIN (dB)	ANTENNA HEIGHT (m)	TABLE ANGLE (Degree)	RAW VALUE (dBuV)	CORRECTION FACTOR (dB/m)
1	5150.00	60.5 PK	74.0	-13.5	1.49 V	280	56.8	3.7
2	5150.00	48.0 AV	54.0	-6.0	1.49 V	280	44.3	3.7
3	*5180.00	117.8 PK			1.49 V	280	114.1	3.7
4	*5180.00	107.8 AV			1.49 V	280	104.1	3.7
5	#10360.00	58.9 PK	74.0	-15.1	1.48 V	347	45.9	13.0
6	#10360.00	46.6 AV	54.0	-7.4	1.48 V	347	33.6	13.0
7	15540.00	46.1 PK	74.0	-27.9	2.73 V	146	33.0	13.1
8	15540.00	36.1 AV	54.0	-17.9	2.73 V	146	23.0	13.1

REMARKS:

1. Emission Level(dBuV/m) = Raw Value(dBuV) + Correction Factor(dB/m)
2. Correction Factor(dB/m) = Antenna Factor(dB/m) + Cable Factor(dB) – Pre-Amplifier Factor(dB)
3. The other emission levels were very low against the limit.
4. Margin value = Emission Level – Limit value
5. " * ": Fundamental frequency.
6. " # ": The radiated frequency is out of the restricted band.

CHANNEL	TX Channel 40	DETECTOR FUNCTION	Peak (PK)
FREQUENCY RANGE	1GHz ~ 40GHz		Average (AV)

ANTENNA POLARITY & TEST DISTANCE: HORIZONTAL AT 3 M

NO.	FREQ. (MHz)	EMISSION LEVEL (dBuV/m)	LIMIT (dBuV/m)	MARGIN (dB)	ANTENNA HEIGHT (m)	TABLE ANGLE (Degree)	RAW VALUE (dBuV)	CORRECTION FACTOR (dB/m)
1	5150.00	43.9 PK	74.0	-30.1	1.08 H	360	40.2	3.7
2	5150.00	36.2 AV	54.0	-17.8	1.08 H	360	32.5	3.7
3	*5200.00	102.2 PK			1.08 H	360	98.5	3.7
4	*5200.00	92.8 AV			1.08 H	360	89.1	3.7
5	#10400.00	56.8 PK	74.0	-17.2	1.37 H	320	43.8	13.0
6	#10400.00	43.2 AV	54.0	-10.8	1.37 H	320	30.2	13.0
7	15600.00	45.2 PK	74.0	-28.8	1.52 H	322	31.9	13.3
8	15600.00	33.6 AV	54.0	-20.4	1.52 H	322	20.3	13.3

ANTENNA POLARITY & TEST DISTANCE: VERTICAL AT 3 M

NO.	FREQ. (MHz)	EMISSION LEVEL (dBuV/m)	LIMIT (dBuV/m)	MARGIN (dB)	ANTENNA HEIGHT (m)	TABLE ANGLE (Degree)	RAW VALUE (dBuV)	CORRECTION FACTOR (dB/m)
1	5150.00	55.1 PK	74.0	-18.9	1.60 V	331	51.4	3.7
2	5150.00	46.4 AV	54.0	-7.6	1.60 V	331	42.7	3.7
3	*5200.00	116.3 PK			1.60 V	331	112.6	3.7
4	*5200.00	107.5 AV			1.60 V	331	103.8	3.7
5	#10400.00	58.6 PK	74.0	-15.4	1.52 V	346	45.6	13.0
6	#10400.00	46.5 AV	54.0	-7.5	1.52 V	346	33.5	13.0
7	15600.00	46.9 PK	74.0	-27.1	2.70 V	151	33.6	13.3
8	15600.00	36.7 AV	54.0	-17.3	2.70 V	151	23.4	13.3

REMARKS:

1. Emission Level(dBuV/m) = Raw Value(dBuV) + Correction Factor(dB/m)
2. Correction Factor(dB/m) = Antenna Factor(dB/m) + Cable Factor(dB) – Pre-Amplifier Factor(dB)
3. The other emission levels were very low against the limit.
4. Margin value = Emission Level – Limit value
5. " * ": Fundamental frequency.
6. " # ": The radiated frequency is out of the restricted band.

CHANNEL	TX Channel 48	DETECTOR FUNCTION	Peak (PK)
FREQUENCY RANGE	1GHz ~ 40GHz		Average (AV)

ANTENNA POLARITY & TEST DISTANCE: HORIZONTAL AT 3 M

NO.	FREQ. (MHz)	EMISSION LEVEL (dBuV/m)	LIMIT (dBuV/m)	MARGIN (dB)	ANTENNA HEIGHT (m)	TABLE ANGLE (Degree)	RAW VALUE (dBuV)	CORRECTION FACTOR (dB/m)
1	5150.00	48.5 PK	74.0	-25.5	1.06 H	360	44.8	3.7
2	5150.00	35.1 AV	54.0	-18.9	1.06 H	360	31.4	3.7
3	*5240.00	103.3 PK			1.06 H	360	99.5	3.8
4	*5240.00	93.0 AV			1.06 H	360	89.2	3.8
5	5350.00	46.5 PK	74.0	-27.5	1.06 H	360	42.4	4.1
6	5350.00	34.6 AV	54.0	-19.4	1.06 H	360	30.5	4.1
7	#10480.00	56.7 PK	74.0	-17.3	1.36 H	322	43.5	13.2
8	#10480.00	43.3 AV	54.0	-10.7	1.36 H	322	30.1	13.2
9	15720.00	46.1 PK	74.0	-27.9	1.44 H	315	32.5	13.6
10	15720.00	34.2 AV	54.0	-19.8	1.44 H	315	20.6	13.6

ANTENNA POLARITY & TEST DISTANCE: VERTICAL AT 3 M

NO.	FREQ. (MHz)	EMISSION LEVEL (dBuV/m)	LIMIT (dBuV/m)	MARGIN (dB)	ANTENNA HEIGHT (m)	TABLE ANGLE (Degree)	RAW VALUE (dBuV)	CORRECTION FACTOR (dB/m)
1	5150.00	51.9 PK	74.0	-22.1	1.40 V	12	48.2	3.7
2	5150.00	38.2 AV	54.0	-15.8	1.40 V	12	34.5	3.7
3	*5240.00	117.4 PK			1.40 V	12	113.6	3.8
4	*5240.00	107.7 AV			1.40 V	12	103.9	3.8
5	5350.00	49.6 PK	74.0	-24.4	1.40 V	12	45.5	4.1
6	5350.00	37.8 AV	54.0	-16.2	1.40 V	12	33.7	4.1
7	#10480.00	58.7 PK	74.0	-15.3	1.50 V	359	45.5	13.2
8	#10480.00	46.7 AV	54.0	-7.3	1.50 V	359	33.5	13.2
9	15720.00	46.2 PK	74.0	-27.8	2.69 V	160	32.6	13.6
10	15720.00	36.1 AV	54.0	-17.9	2.69 V	160	22.5	13.6

REMARKS:

1. Emission Level(dBuV/m) = Raw Value(dBuV) + Correction Factor(dB/m)
2. Correction Factor(dB/m) = Antenna Factor(dB/m) + Cable Factor(dB) – Pre-Amplifier Factor(dB)
3. The other emission levels were very low against the limit.
4. Margin value = Emission Level – Limit value
5. " * ": Fundamental frequency.
6. " # ": The radiated frequency is out of the restricted band.

CHANNEL	TX Channel 149	DETECTOR FUNCTION	Peak (PK)
FREQUENCY RANGE	1GHz ~ 40GHz		Average (AV)

ANTENNA POLARITY & TEST DISTANCE: HORIZONTAL AT 3 M

NO.	FREQ. (MHz)	EMISSION LEVEL (dBuV/m)	LIMIT (dBuV/m)	MARGIN (dB)	ANTENNA HEIGHT (m)	TABLE ANGLE (Degree)	RAW VALUE (dBuV)	CORRECTION FACTOR (dB/m)
1	#5643.80	61.6 PK	68.2	-6.6	1.07 H	56	57.2	4.4
2	*5745.00	111.1 PK			1.07 H	56	106.7	4.4
3	*5745.00	100.4 AV			1.07 H	56	96.0	4.4
4	#5952.59	58.8 PK	68.2	-9.4	1.07 H	56	54.1	4.7
5	11490.00	45.3 PK	74.0	-28.7	1.50 H	12	31.8	13.5
6	11490.00	34.6 AV	54.0	-19.4	1.50 H	12	21.1	13.5
7	#17235.00	44.4 PK	74.0	-29.6	1.50 H	330	27.1	17.3
8	#17235.00	32.6 AV	54.0	-21.4	1.50 H	330	15.3	17.3

ANTENNA POLARITY & TEST DISTANCE: VERTICAL AT 3 M

NO.	FREQ. (MHz)	EMISSION LEVEL (dBuV/m)	LIMIT (dBuV/m)	MARGIN (dB)	ANTENNA HEIGHT (m)	TABLE ANGLE (Degree)	RAW VALUE (dBuV)	CORRECTION FACTOR (dB/m)
1	#5647.85	66.5 PK	68.2	-1.7	1.86 V	312	62.1	4.4
2	#5660.68	71.3 PK	76.1	-4.8	1.86 V	312	67.0	4.3
3	*5745.00	123.1 PK			1.86 V	312	118.7	4.4
4	*5745.00	113.6 AV			1.86 V	312	109.2	4.4
5	#5965.15	59.4 PK	68.2	-8.8	1.86 V	312	54.7	4.7
6	11490.00	57.4 PK	74.0	-16.6	1.76 V	238	43.9	13.5
7	11490.00	45.9 AV	54.0	-8.1	1.76 V	238	32.4	13.5
8	#17235.00	45.5 PK	74.0	-28.5	2.75 V	142	28.2	17.3
9	#17235.00	34.5 AV	54.0	-19.5	2.75 V	142	17.2	17.3

REMARKS:

1. Emission Level(dBuV/m) = Raw Value(dBuV) + Correction Factor(dB/m)
2. Correction Factor(dB/m) = Antenna Factor(dB/m) + Cable Factor(dB) – Pre-Amplifier Factor(dB)
3. The other emission levels were very low against the limit.
4. Margin value = Emission Level – Limit value
5. " * ": Fundamental frequency.
6. " # ": The radiated frequency is out of the restricted band.

CHANNEL	TX Channel 157	DETECTOR FUNCTION	Peak (PK)
FREQUENCY RANGE	1GHz ~ 40GHz		Average (AV)

ANTENNA POLARITY & TEST DISTANCE: HORIZONTAL AT 3 M

NO.	FREQ. (MHz)	EMISSION LEVEL (dBuV/m)	LIMIT (dBuV/m)	MARGIN (dB)	ANTENNA HEIGHT (m)	TABLE ANGLE (Degree)	RAW VALUE (dBuV)	CORRECTION FACTOR (dB/m)
1	#5638.60	60.5 PK	68.2	-7.7	1.04 H	50	56.1	4.4
2	*5785.00	110.2 PK			1.04 H	50	105.8	4.4
3	*5785.00	99.3 AV			1.04 H	50	94.9	4.4
4	#5993.18	60.1 PK	68.2	-8.1	1.04 H	50	55.4	4.7
5	11570.00	45.1 PK	74.0	-28.9	1.55 H	7	31.6	13.5
6	11570.00	34.6 AV	54.0	-19.4	1.55 H	7	21.1	13.5
7	#17355.00	44.3 PK	74.0	-29.7	1.54 H	334	26.3	18.0
8	#17355.00	32.6 AV	54.0	-21.4	1.54 H	334	14.6	18.0

ANTENNA POLARITY & TEST DISTANCE: VERTICAL AT 3 M

NO.	FREQ. (MHz)	EMISSION LEVEL (dBuV/m)	LIMIT (dBuV/m)	MARGIN (dB)	ANTENNA HEIGHT (m)	TABLE ANGLE (Degree)	RAW VALUE (dBuV)	CORRECTION FACTOR (dB/m)
1	#5636.45	60.4 PK	68.2	-7.8	1.88 V	281	56.0	4.4
2	*5785.00	122.3 PK			1.88 V	281	117.9	4.4
3	*5785.00	112.6 AV			1.88 V	281	108.2	4.4
4	#5932.37	59.8 PK	68.2	-8.4	1.88 V	281	55.1	4.7
5	11570.00	57.3 PK	74.0	-16.7	1.72 V	254	43.8	13.5
6	11570.00	46.1 AV	54.0	-7.9	1.72 V	254	32.6	13.5
7	#17355.00	45.3 PK	74.0	-28.7	2.76 V	148	27.3	18.0
8	#17355.00	34.6 AV	54.0	-19.4	2.76 V	148	16.6	18.0

REMARKS:

1. Emission Level(dBuV/m) = Raw Value(dBuV) + Correction Factor(dB/m)
2. Correction Factor(dB/m) = Antenna Factor(dB/m) + Cable Factor(dB) – Pre-Amplifier Factor(dB)
3. The other emission levels were very low against the limit.
4. Margin value = Emission Level – Limit value
5. " * ": Fundamental frequency.
6. " # ": The radiated frequency is out of the restricted band.

CHANNEL	TX Channel 165	DETECTOR FUNCTION	Peak (PK)
FREQUENCY RANGE	1GHz ~ 40GHz		Average (AV)

ANTENNA POLARITY & TEST DISTANCE: HORIZONTAL AT 3 M

NO.	FREQ. (MHz)	EMISSION LEVEL (dBuV/m)	LIMIT (dBuV/m)	MARGIN (dB)	ANTENNA HEIGHT (m)	TABLE ANGLE (Degree)	RAW VALUE (dBuV)	CORRECTION FACTOR (dB/m)
1	#5619.56	60.4 PK	68.2	-7.8	1.07 H	67	56.0	4.4
2	*5825.00	110.3 PK			1.07 H	67	105.9	4.4
3	*5825.00	99.1 AV			1.07 H	67	94.7	4.4
4	#5930.84	60.1 PK	68.2	-8.1	1.07 H	67	55.4	4.7
5	11650.00	45.6 PK	74.0	-28.4	1.54 H	21	31.9	13.7
6	11650.00	34.9 AV	54.0	-19.1	1.54 H	21	21.2	13.7
7	#17475.00	44.6 PK	74.0	-29.4	1.50 H	326	26.0	18.6
8	#17475.00	32.9 AV	54.0	-21.1	1.50 H	326	14.3	18.6

ANTENNA POLARITY & TEST DISTANCE: VERTICAL AT 3 M

NO.	FREQ. (MHz)	EMISSION LEVEL (dBuV/m)	LIMIT (dBuV/m)	MARGIN (dB)	ANTENNA HEIGHT (m)	TABLE ANGLE (Degree)	RAW VALUE (dBuV)	CORRECTION FACTOR (dB/m)
1	#5580.87	62.8 PK	68.2	-5.4	1.72 V	0	58.6	4.2
2	*5825.00	122.2 PK			1.72 V	0	117.8	4.4
3	*5825.00	112.7 AV			1.72 V	0	108.3	4.4
4	#5937.60	61.7 PK	68.2	-6.5	1.72 V	0	57.0	4.7
5	11650.00	57.4 PK	74.0	-16.6	1.73 V	226	43.7	13.7
6	11650.00	46.0 AV	54.0	-8.0	1.73 V	226	32.3	13.7
7	#17475.00	44.9 PK	74.0	-29.1	2.75 V	140	26.3	18.6
8	#17475.00	34.0 AV	54.0	-20.0	2.75 V	140	15.4	18.6

REMARKS:

1. Emission Level(dBuV/m) = Raw Value(dBuV) + Correction Factor(dB/m)
2. Correction Factor(dB/m) = Antenna Factor(dB/m) + Cable Factor(dB) – Pre-Amplifier Factor(dB)
3. The other emission levels were very low against the limit.
4. Margin value = Emission Level – Limit value
5. " * ": Fundamental frequency.
6. " # ": The radiated frequency is out of the restricted band.

802.11ac (VHT20)

CHANNEL	TX Channel 36	DETECTOR FUNCTION	Peak (PK)
FREQUENCY RANGE	1GHz ~ 40GHz		Average (AV)

ANTENNA POLARITY & TEST DISTANCE: HORIZONTAL AT 3 M								
NO.	FREQ. (MHz)	EMISSION LEVEL (dBuV/m)	LIMIT (dBuV/m)	MARGIN (dB)	ANTENNA HEIGHT (m)	TABLE ANGLE (Degree)	RAW VALUE (dBuV)	CORRECTION FACTOR (dB/m)
1	5150.00	56.2 PK	74.0	-17.8	1.13 H	356	52.5	3.7
2	5150.00	41.3 AV	54.0	-12.7	1.13 H	356	37.6	3.7
3	*5180.00	103.8 PK			1.13 H	356	100.1	3.7
4	*5180.00	92.6 AV			1.13 H	356	88.9	3.7
5	#10360.00	56.5 PK	74.0	-17.5	1.34 H	313	43.5	13.0
6	#10360.00	43.3 AV	54.0	-10.7	1.34 H	313	30.3	13.0
7	15540.00	45.5 PK	74.0	-28.5	1.55 H	340	32.4	13.1
8	15540.00	33.6 AV	54.0	-20.4	1.55 H	340	20.5	13.1

ANTENNA POLARITY & TEST DISTANCE: VERTICAL AT 3 M								
NO.	FREQ. (MHz)	EMISSION LEVEL (dBuV/m)	LIMIT (dBuV/m)	MARGIN (dB)	ANTENNA HEIGHT (m)	TABLE ANGLE (Degree)	RAW VALUE (dBuV)	CORRECTION FACTOR (dB/m)
1	5150.00	62.6 PK	74.0	-11.4	1.50 V	12	58.9	3.7
2	5150.00	47.7 AV	54.0	-6.3	1.50 V	12	44.0	3.7
3	*5180.00	117.9 PK			1.50 V	12	114.2	3.7
4	*5180.00	107.2 AV			1.50 V	12	103.5	3.7
5	#10360.00	59.0 PK	74.0	-15.0	1.51 V	357	46.0	13.0
6	#10360.00	46.7 AV	54.0	-7.3	1.51 V	357	33.7	13.0
7	15540.00	46.0 PK	74.0	-28.0	2.69 V	154	32.9	13.1
8	15540.00	35.7 AV	54.0	-18.3	2.69 V	154	22.6	13.1

REMARKS:

1. Emission Level(dBuV/m) = Raw Value(dBuV) + Correction Factor(dB/m)
2. Correction Factor(dB/m) = Antenna Factor(dB/m) + Cable Factor(dB) – Pre-Amplifier Factor(dB)
3. The other emission levels were very low against the limit.
4. Margin value = Emission Level – Limit value
5. " * ": Fundamental frequency.
6. " # ": The radiated frequency is out of the restricted band.

CHANNEL	TX Channel 40	DETECTOR FUNCTION	Peak (PK)
FREQUENCY RANGE	1GHz ~ 40GHz		Average (AV)

ANTENNA POLARITY & TEST DISTANCE: HORIZONTAL AT 3 M

NO.	FREQ. (MHz)	EMISSION LEVEL (dBuV/m)	LIMIT (dBuV/m)	MARGIN (dB)	ANTENNA HEIGHT (m)	TABLE ANGLE (Degree)	RAW VALUE (dBuV)	CORRECTION FACTOR (dB/m)
1	5150.00	52.0 PK	74.0	-22.0	1.09 H	355	48.3	3.7
2	5150.00	39.9 AV	54.0	-14.1	1.09 H	355	36.2	3.7
3	*5200.00	104.1 PK			1.09 H	355	100.4	3.7
4	*5200.00	93.0 AV			1.09 H	355	89.3	3.7
5	#10400.00	56.4 PK	74.0	-17.6	1.33 H	326	43.4	13.0
6	#10400.00	43.2 AV	54.0	-10.8	1.33 H	326	30.2	13.0
7	15600.00	45.2 PK	74.0	-28.8	1.54 H	356	31.9	13.3
8	15600.00	33.4 AV	54.0	-20.6	1.54 H	356	20.1	13.3

ANTENNA POLARITY & TEST DISTANCE: VERTICAL AT 3 M

NO.	FREQ. (MHz)	EMISSION LEVEL (dBuV/m)	LIMIT (dBuV/m)	MARGIN (dB)	ANTENNA HEIGHT (m)	TABLE ANGLE (Degree)	RAW VALUE (dBuV)	CORRECTION FACTOR (dB/m)
1	5150.00	58.4 PK	74.0	-15.6	1.60 V	333	54.7	3.7
2	5150.00	46.3 AV	54.0	-7.7	1.60 V	333	42.6	3.7
3	*5200.00	118.2 PK			1.60 V	333	114.5	3.7
4	*5200.00	107.6 AV			1.60 V	333	103.9	3.7
5	#10400.00	58.9 PK	74.0	-15.1	1.46 V	345	45.9	13.0
6	#10400.00	46.5 AV	54.0	-7.5	1.46 V	345	33.5	13.0
7	15600.00	45.9 PK	74.0	-28.1	2.64 V	152	32.6	13.3
8	15600.00	35.4 AV	54.0	-18.6	2.64 V	152	22.1	13.3

REMARKS:

1. Emission Level(dBuV/m) = Raw Value(dBuV) + Correction Factor(dB/m)
2. Correction Factor(dB/m) = Antenna Factor(dB/m) + Cable Factor(dB) – Pre-Amplifier Factor(dB)
3. The other emission levels were very low against the limit.
4. Margin value = Emission Level – Limit value
5. " * ": Fundamental frequency.
6. " # ": The radiated frequency is out of the restricted band.

CHANNEL	TX Channel 48	DETECTOR FUNCTION	Peak (PK)
FREQUENCY RANGE	1GHz ~ 40GHz		Average (AV)

ANTENNA POLARITY & TEST DISTANCE: HORIZONTAL AT 3 M

NO.	FREQ. (MHz)	EMISSION LEVEL (dBuV/m)	LIMIT (dBuV/m)	MARGIN (dB)	ANTENNA HEIGHT (m)	TABLE ANGLE (Degree)	RAW VALUE (dBuV)	CORRECTION FACTOR (dB/m)
1	*5240.00	103.8 PK			1.03 H	346	100.0	3.8
2	*5240.00	93.1 AV			1.03 H	346	89.3	3.8
3	5350.00	48.3 PK	74.0	-25.7	1.03 H	346	44.2	4.1
4	5350.00	35.7 AV	54.0	-18.3	1.03 H	346	31.6	4.1
5	#10480.00	56.6 PK	74.0	-17.4	1.36 H	303	43.4	13.2
6	#10480.00	43.3 AV	54.0	-10.7	1.36 H	303	30.1	13.2
7	15720.00	44.9 PK	74.0	-29.1	1.50 H	347	31.3	13.6
8	15720.00	33.2 AV	54.0	-20.8	1.50 H	347	19.6	13.6

ANTENNA POLARITY & TEST DISTANCE: VERTICAL AT 3 M

NO.	FREQ. (MHz)	EMISSION LEVEL (dBuV/m)	LIMIT (dBuV/m)	MARGIN (dB)	ANTENNA HEIGHT (m)	TABLE ANGLE (Degree)	RAW VALUE (dBuV)	CORRECTION FACTOR (dB/m)
1	*5240.00	117.9 PK			1.45 V	24	114.1	3.8
2	*5240.00	107.8 AV			1.45 V	24	104.0	3.8
3	5350.00	50.4 PK	74.0	-23.6	1.45 V	24	46.3	4.1
4	5350.00	37.8 AV	54.0	-16.2	1.45 V	24	33.7	4.1
5	#10480.00	59.0 PK	74.0	-15.0	1.50 V	359	45.8	13.2
6	#10480.00	45.9 AV	54.0	-8.1	1.50 V	359	32.7	13.2
7	15720.00	46.6 PK	74.0	-27.4	2.70 V	153	33.0	13.6
8	15720.00	35.8 AV	54.0	-18.2	2.70 V	153	22.2	13.6

REMARKS:

1. Emission Level(dBuV/m) = Raw Value(dBuV) + Correction Factor(dB/m)
2. Correction Factor(dB/m) = Antenna Factor(dB/m) + Cable Factor(dB) – Pre-Amplifier Factor(dB)
3. The other emission levels were very low against the limit.
4. Margin value = Emission Level – Limit value
5. " * ": Fundamental frequency.
6. " # ": The radiated frequency is out of the restricted band.

CHANNEL	TX Channel 149	DETECTOR FUNCTION	Peak (PK)
FREQUENCY RANGE	1GHz ~ 40GHz		Average (AV)

ANTENNA POLARITY & TEST DISTANCE: HORIZONTAL AT 3 M

NO.	FREQ. (MHz)	EMISSION LEVEL (dBuV/m)	LIMIT (dBuV/m)	MARGIN (dB)	ANTENNA HEIGHT (m)	TABLE ANGLE (Degree)	RAW VALUE (dBuV)	CORRECTION FACTOR (dB/m)
1	#5594.19	60.4 PK	68.2	-7.8	1.36 H	303	56.1	4.3
2	*5745.00	108.2 PK			1.36 H	303	103.8	4.4
3	*5745.00	97.3 AV			1.36 H	303	92.9	4.4
4	#5947.95	60.1 PK	68.2	-8.1	1.36 H	303	55.4	4.7
5	11490.00	44.8 PK	74.0	-29.2	1.53 H	15	31.3	13.5
6	11490.00	34.2 AV	54.0	-19.8	1.53 H	15	20.7	13.5
7	#17235.00	44.7 PK	74.0	-29.3	1.54 H	343	27.4	17.3
8	#17235.00	33.1 AV	54.0	-20.9	1.54 H	343	15.8	17.3

ANTENNA POLARITY & TEST DISTANCE: VERTICAL AT 3 M

NO.	FREQ. (MHz)	EMISSION LEVEL (dBuV/m)	LIMIT (dBuV/m)	MARGIN (dB)	ANTENNA HEIGHT (m)	TABLE ANGLE (Degree)	RAW VALUE (dBuV)	CORRECTION FACTOR (dB/m)
1	#5649.56	66.6 PK	68.2	-1.6	1.76 V	232	62.2	4.4
2	*5745.00	123.9 PK			1.76 V	232	119.5	4.4
3	*5745.00	113.0 AV			1.76 V	232	108.6	4.4
4	#5983.01	59.8 PK	68.2	-8.4	1.76 V	232	55.1	4.7
5	11490.00	57.4 PK	74.0	-16.6	1.81 V	241	43.9	13.5
6	11490.00	46.1 AV	54.0	-7.9	1.81 V	241	32.6	13.5
7	#17235.00	45.7 PK	74.0	-28.3	2.69 V	133	28.4	17.3
8	#17235.00	34.9 AV	54.0	-19.1	2.69 V	133	17.6	17.3

REMARKS:

1. Emission Level(dBuV/m) = Raw Value(dBuV) + Correction Factor(dB/m)
2. Correction Factor(dB/m) = Antenna Factor(dB/m) + Cable Factor(dB) – Pre-Amplifier Factor(dB)
3. The other emission levels were very low against the limit.
4. Margin value = Emission Level – Limit value
5. " * ": Fundamental frequency.
6. " # ": The radiated frequency is out of the restricted band.

CHANNEL	TX Channel 157	DETECTOR FUNCTION	Peak (PK)
FREQUENCY RANGE	1GHz ~ 40GHz		Average (AV)

ANTENNA POLARITY & TEST DISTANCE: HORIZONTAL AT 3 M

NO.	FREQ. (MHz)	EMISSION LEVEL (dBuV/m)	LIMIT (dBuV/m)	MARGIN (dB)	ANTENNA HEIGHT (m)	TABLE ANGLE (Degree)	RAW VALUE (dBuV)	CORRECTION FACTOR (dB/m)
1	#5588.63	60.4 PK	68.2	-7.8	1.38 H	308	56.2	4.2
2	*5785.00	106.6 PK			1.38 H	308	102.2	4.4
3	*5785.00	96.1 AV			1.38 H	308	91.7	4.4
4	#5962.25	59.5 PK	68.2	-8.7	1.38 H	308	54.8	4.7
5	11570.00	44.4 PK	74.0	-29.6	1.59 H	11	30.9	13.5
6	11570.00	33.9 AV	54.0	-20.1	1.59 H	11	20.4	13.5
7	#17355.00	45.2 PK	74.0	-28.8	1.58 H	353	27.2	18.0
8	#17355.00	33.4 AV	54.0	-20.6	1.58 H	353	15.4	18.0

ANTENNA POLARITY & TEST DISTANCE: VERTICAL AT 3 M

NO.	FREQ. (MHz)	EMISSION LEVEL (dBuV/m)	LIMIT (dBuV/m)	MARGIN (dB)	ANTENNA HEIGHT (m)	TABLE ANGLE (Degree)	RAW VALUE (dBuV)	CORRECTION FACTOR (dB/m)
1	#5622.64	61.3 PK	68.2	-6.9	1.86 V	278	56.9	4.4
2	*5785.00	122.4 PK			1.86 V	278	118.0	4.4
3	*5785.00	112.1 AV			1.86 V	278	107.7	4.4
4	#5949.62	59.3 PK	68.2	-8.9	1.86 V	278	54.6	4.7
5	11570.00	57.4 PK	74.0	-16.6	1.80 V	255	43.9	13.5
6	11570.00	46.0 AV	54.0	-8.0	1.80 V	255	32.5	13.5
7	#17355.00	45.9 PK	74.0	-28.1	2.65 V	125	27.9	18.0
8	#17355.00	34.9 AV	54.0	-19.1	2.65 V	125	16.9	18.0

REMARKS:

1. Emission Level(dBuV/m) = Raw Value(dBuV) + Correction Factor(dB/m)
2. Correction Factor(dB/m) = Antenna Factor(dB/m) + Cable Factor(dB) – Pre-Amplifier Factor(dB)
3. The other emission levels were very low against the limit.
4. Margin value = Emission Level – Limit value
5. " * ": Fundamental frequency.
6. " # ": The radiated frequency is out of the restricted band.

CHANNEL	TX Channel 165	DETECTOR FUNCTION	Peak (PK)
FREQUENCY RANGE	1GHz ~ 40GHz		Average (AV)

ANTENNA POLARITY & TEST DISTANCE: HORIZONTAL AT 3 M

NO.	FREQ. (MHz)	EMISSION LEVEL (dBuV/m)	LIMIT (dBuV/m)	MARGIN (dB)	ANTENNA HEIGHT (m)	TABLE ANGLE (Degree)	RAW VALUE (dBuV)	CORRECTION FACTOR (dB/m)
1	#5631.28	60.4 PK	68.2	-7.8	1.37 H	298	56.0	4.4
2	*5825.00	106.8 PK			1.37 H	298	102.4	4.4
3	*5825.00	95.9 AV			1.37 H	298	91.5	4.4
4	#6012.27	60.2 PK	68.2	-8.0	1.37 H	298	55.4	4.8
5	11650.00	44.4 PK	74.0	-29.6	1.51 H	7	30.7	13.7
6	11650.00	34.0 AV	54.0	-20.0	1.51 H	7	20.3	13.7
7	#17475.00	44.1 PK	74.0	-29.9	1.57 H	334	25.5	18.6
8	#17475.00	32.7 AV	54.0	-21.3	1.57 H	334	14.1	18.6

ANTENNA POLARITY & TEST DISTANCE: VERTICAL AT 3 M

NO.	FREQ. (MHz)	EMISSION LEVEL (dBuV/m)	LIMIT (dBuV/m)	MARGIN (dB)	ANTENNA HEIGHT (m)	TABLE ANGLE (Degree)	RAW VALUE (dBuV)	CORRECTION FACTOR (dB/m)
1	#5567.61	61.2 PK	68.2	-7.0	1.94 V	278	57.0	4.2
2	*5825.00	122.3 PK			1.94 V	278	117.9	4.4
3	*5825.00	111.7 AV			1.94 V	278	107.3	4.4
4	#5954.65	61.9 PK	68.2	-6.3	1.94 V	278	57.2	4.7
5	11650.00	57.6 PK	74.0	-16.4	1.85 V	246	43.9	13.7
6	11650.00	46.3 AV	54.0	-7.7	1.85 V	246	32.6	13.7
7	#17475.00	46.2 PK	74.0	-27.8	2.72 V	145	27.6	18.6
8	#17475.00	35.2 AV	54.0	-18.8	2.72 V	145	16.6	18.6

REMARKS:

- Emission Level(dBuV/m) = Raw Value(dBuV) + Correction Factor(dB/m)
- Correction Factor(dB/m) = Antenna Factor(dB/m) + Cable Factor(dB) – Pre-Amplifier Factor(dB)
- The other emission levels were very low against the limit.
- Margin value = Emission Level – Limit value
- " * ": Fundamental frequency.
- " # ": The radiated frequency is out of the restricted band.

802.11ac (VHT40)

CHANNEL	TX Channel 38	DETECTOR FUNCTION	Peak (PK)
FREQUENCY RANGE	1GHz ~ 40GHz		Average (AV)

ANTENNA POLARITY & TEST DISTANCE: HORIZONTAL AT 3 M								
NO.	FREQ. (MHz)	EMISSION LEVEL (dBuV/m)	LIMIT (dBuV/m)	MARGIN (dB)	ANTENNA HEIGHT (m)	TABLE ANGLE (Degree)	RAW VALUE (dBuV)	CORRECTION FACTOR (dB/m)
1	5147.60	58.5 PK	74.0	-15.5	1.09 H	339	54.9	3.6
2	5147.60	46.4 AV	54.0	-7.6	1.09 H	339	42.8	3.6
3	*5190.00	102.6 PK			1.09 H	339	98.9	3.7
4	*5190.00	92.1 AV			1.09 H	339	88.4	3.7
5	5350.00	48.2 PK	74.0	-25.8	1.09 H	339	44.1	4.1
6	5350.00	36.6 AV	54.0	-17.4	1.09 H	339	32.5	4.1
7	#10380.00	55.7 PK	74.0	-18.3	1.31 H	302	42.6	13.1
8	#10380.00	42.2 AV	54.0	-11.8	1.31 H	302	29.1	13.1
9	15570.00	44.9 PK	74.0	-29.1	1.53 H	344	31.6	13.3
10	15570.00	33.2 AV	54.0	-20.8	1.53 H	344	19.9	13.3

ANTENNA POLARITY & TEST DISTANCE: VERTICAL AT 3 M								
NO.	FREQ. (MHz)	EMISSION LEVEL (dBuV/m)	LIMIT (dBuV/m)	MARGIN (dB)	ANTENNA HEIGHT (m)	TABLE ANGLE (Degree)	RAW VALUE (dBuV)	CORRECTION FACTOR (dB/m)
1	5147.60	64.9 PK	74.0	-9.1	1.50 V	360	61.3	3.6
2	5147.60	52.8 AV	54.0	-1.2	1.50 V	360	49.2	3.6
3	*5190.00	116.7 PK			1.50 V	360	113.0	3.7
4	*5190.00	106.4 AV			1.50 V	360	102.7	3.7
5	5350.00	50.3 PK	74.0	-23.7	1.50 V	360	46.2	4.1
6	5350.00	38.7 AV	54.0	-15.3	1.50 V	360	34.6	4.1
7	#10380.00	58.1 PK	74.0	-15.9	1.48 V	360	45.0	13.1
8	#10380.00	46.0 AV	54.0	-8.0	1.48 V	360	32.9	13.1
9	15570.00	45.6 PK	74.0	-28.4	2.72 V	150	32.3	13.3
10	15570.00	35.5 AV	54.0	-18.5	2.72 V	150	22.2	13.3

REMARKS:

1. Emission Level(dBuV/m) = Raw Value(dBuV) + Correction Factor(dB/m)
2. Correction Factor(dB/m) = Antenna Factor(dB/m) + Cable Factor(dB) – Pre-Amplifier Factor(dB)
3. The other emission levels were very low against the limit.
4. Margin value = Emission Level – Limit value
5. " * ": Fundamental frequency.
6. " # ": The radiated frequency is out of the restricted band.

CHANNEL	TX Channel 46	DETECTOR FUNCTION	Peak (PK)
FREQUENCY RANGE	1GHz ~ 40GHz		Average (AV)

ANTENNA POLARITY & TEST DISTANCE: HORIZONTAL AT 3 M

NO.	FREQ. (MHz)	EMISSION LEVEL (dBuV/m)	LIMIT (dBuV/m)	MARGIN (dB)	ANTENNA HEIGHT (m)	TABLE ANGLE (Degree)	RAW VALUE (dBuV)	CORRECTION FACTOR (dB/m)
1	5148.00	56.7 PK	74.0	-17.3	1.13 H	348	53.1	3.6
2	5148.00	44.2 AV	54.0	-9.8	1.13 H	348	40.6	3.6
3	*5230.00	103.9 PK			1.13 H	348	100.1	3.8
4	*5230.00	94.3 AV			1.13 H	348	90.5	3.8
5	5350.00	48.0 PK	74.0	-26.0	1.13 H	348	43.9	4.1
6	5350.00	37.2 AV	54.0	-16.8	1.13 H	348	33.1	4.1
7	#10460.00	56.0 PK	74.0	-18.0	1.35 H	310	42.9	13.1
8	#10460.00	42.5 AV	54.0	-11.5	1.35 H	310	29.4	13.1
9	15690.00	45.3 PK	74.0	-28.7	1.54 H	355	31.5	13.8
10	15690.00	33.4 AV	54.0	-20.6	1.54 H	355	19.6	13.8

ANTENNA POLARITY & TEST DISTANCE: VERTICAL AT 3 M

NO.	FREQ. (MHz)	EMISSION LEVEL (dBuV/m)	LIMIT (dBuV/m)	MARGIN (dB)	ANTENNA HEIGHT (m)	TABLE ANGLE (Degree)	RAW VALUE (dBuV)	CORRECTION FACTOR (dB/m)
1	5148.00	63.1 PK	74.0	-10.9	1.50 V	360	59.5	3.6
2	5148.00	50.6 AV	54.0	-3.4	1.50 V	360	47.0	3.6
3	*5230.00	118.1 PK			1.50 V	360	114.3	3.8
4	*5230.00	108.5 AV			1.50 V	360	104.7	3.8
5	5350.00	50.4 PK	74.0	-23.6	1.50 V	360	46.3	4.1
6	5350.00	39.6 AV	54.0	-14.4	1.50 V	360	35.5	4.1
7	#10460.00	57.4 PK	74.0	-16.6	1.45 V	355	44.3	13.1
8	#10460.00	45.5 AV	54.0	-8.5	1.45 V	355	32.4	13.1
9	15690.00	45.6 PK	74.0	-28.4	2.68 V	145	31.8	13.8
10	15690.00	35.5 AV	54.0	-18.5	2.68 V	145	21.7	13.8

REMARKS:

- Emission Level(dBuV/m) = Raw Value(dBuV) + Correction Factor(dB/m)
- Correction Factor(dB/m) = Antenna Factor(dB/m) + Cable Factor(dB) – Pre-Amplifier Factor(dB)
- The other emission levels were very low against the limit.
- Margin value = Emission Level – Limit value
- " * ": Fundamental frequency.
- " # ": The radiated frequency is out of the restricted band.

CHANNEL	TX Channel 151	DETECTOR FUNCTION	Peak (PK)
FREQUENCY RANGE	1GHz ~ 40GHz		Average (AV)

ANTENNA POLARITY & TEST DISTANCE: HORIZONTAL AT 3 M

NO.	FREQ. (MHz)	EMISSION LEVEL (dBuV/m)	LIMIT (dBuV/m)	MARGIN (dB)	ANTENNA HEIGHT (m)	TABLE ANGLE (Degree)	RAW VALUE (dBuV)	CORRECTION FACTOR (dB/m)
1	#5606.70	60.5 PK	68.2	-7.7	1.47 H	209	56.1	4.4
2	*5755.00	106.1 PK			1.47 H	209	101.7	4.4
3	*5755.00	95.7 AV			1.47 H	209	91.3	4.4
4	#5929.29	59.7 PK	68.2	-8.5	1.47 H	209	55.0	4.7
5	11510.00	46.2 PK	74.0	-27.8	1.54 H	9	32.6	13.6
6	11510.00	34.2 AV	54.0	-19.8	1.54 H	9	20.6	13.6
7	#17265.00	44.9 PK	74.0	-29.1	1.57 H	353	27.3	17.6
8	#17265.00	35.1 AV	54.0	-18.9	1.57 H	353	17.5	17.6

ANTENNA POLARITY & TEST DISTANCE: VERTICAL AT 3 M

NO.	FREQ. (MHz)	EMISSION LEVEL (dBuV/m)	LIMIT (dBuV/m)	MARGIN (dB)	ANTENNA HEIGHT (m)	TABLE ANGLE (Degree)	RAW VALUE (dBuV)	CORRECTION FACTOR (dB/m)
1	#5643.90	67.0 PK	68.2	-1.2	1.50 V	314	62.6	4.4
2	*5755.00	121.6 PK			1.50 V	314	117.2	4.4
3	*5755.00	111.9 AV			1.50 V	314	107.5	4.4
4	#5952.94	60.0 PK	68.2	-8.2	1.50 V	314	55.3	4.7
5	11510.00	54.7 PK	74.0	-19.3	1.87 V	226	41.1	13.6
6	11510.00	44.8 AV	54.0	-9.2	1.87 V	226	31.2	13.6
7	#17265.00	46.1 PK	74.0	-27.9	2.70 V	120	28.5	17.6
8	#17265.00	35.3 AV	54.0	-18.7	2.70 V	120	17.7	17.6

REMARKS:

1. Emission Level(dBuV/m) = Raw Value(dBuV) + Correction Factor(dB/m)
2. Correction Factor(dB/m) = Antenna Factor(dB/m) + Cable Factor(dB) – Pre-Amplifier Factor(dB)
3. The other emission levels were very low against the limit.
4. Margin value = Emission Level – Limit value
5. " * ": Fundamental frequency.
6. " # ": The radiated frequency is out of the restricted band.

CHANNEL	TX Channel 159	DETECTOR FUNCTION	Peak (PK)
FREQUENCY RANGE	1GHz ~ 40GHz		Average (AV)

ANTENNA POLARITY & TEST DISTANCE: HORIZONTAL AT 3 M

NO.	FREQ. (MHz)	EMISSION LEVEL (dBuV/m)	LIMIT (dBuV/m)	MARGIN (dB)	ANTENNA HEIGHT (m)	TABLE ANGLE (Degree)	RAW VALUE (dBuV)	CORRECTION FACTOR (dB/m)
1	#5562.74	61.3 PK	68.2	-6.9	1.50 H	209	57.1	4.2
2	*5795.00	105.4 PK			1.50 H	209	101.0	4.4
3	*5795.00	95.6 AV			1.50 H	209	91.2	4.4
4	#5929.32	61.0 PK	68.2	-7.2	1.50 H	209	56.3	4.7
5	11590.00	46.6 PK	74.0	-27.4	1.50 H	24	33.1	13.5
6	11590.00	34.6 AV	54.0	-19.4	1.50 H	24	21.1	13.5
7	#17385.00	44.9 PK	74.0	-29.1	1.54 H	358	26.6	18.3
8	#17385.00	35.4 AV	54.0	-18.6	1.54 H	358	17.1	18.3

ANTENNA POLARITY & TEST DISTANCE: VERTICAL AT 3 M

NO.	FREQ. (MHz)	EMISSION LEVEL (dBuV/m)	LIMIT (dBuV/m)	MARGIN (dB)	ANTENNA HEIGHT (m)	TABLE ANGLE (Degree)	RAW VALUE (dBuV)	CORRECTION FACTOR (dB/m)
1	#5635.36	66.3 PK	68.2	-1.9	1.50 V	360	61.9	4.4
2	#5652.98	68.6 PK	70.4	-1.8	1.50 V	360	64.3	4.3
3	*5795.00	120.9 PK			1.50 V	360	116.5	4.4
4	*5795.00	111.8 AV			1.50 V	360	107.4	4.4
5	#5933.43	64.6 PK	68.2	-3.6	1.50 V	360	59.9	4.7
6	11590.00	54.3 PK	74.0	-19.7	1.87 V	239	40.8	13.5
7	11590.00	44.6 AV	54.0	-9.4	1.87 V	239	31.1	13.5
8	#17385.00	45.4 PK	74.0	-28.6	2.69 V	131	27.1	18.3
9	#17385.00	34.9 AV	54.0	-19.1	2.69 V	131	16.6	18.3

REMARKS:

1. Emission Level(dBuV/m) = Raw Value(dBuV) + Correction Factor(dB/m)
2. Correction Factor(dB/m) = Antenna Factor(dB/m) + Cable Factor(dB) – Pre-Amplifier Factor(dB)
3. The other emission levels were very low against the limit.
4. Margin value = Emission Level – Limit value
5. " * ": Fundamental frequency.
6. " # ": The radiated frequency is out of the restricted band.

802.11ac (VHT80)

CHANNEL	TX Channel 42	DETECTOR FUNCTION	Peak (PK)
FREQUENCY RANGE	1GHz ~ 40GHz		Average (AV)

ANTENNA POLARITY & TEST DISTANCE: HORIZONTAL AT 3 M

NO.	FREQ. (MHz)	EMISSION LEVEL (dBuV/m)	LIMIT (dBuV/m)	MARGIN (dB)	ANTENNA HEIGHT (m)	TABLE ANGLE (Degree)	RAW VALUE (dBuV)	CORRECTION FACTOR (dB/m)
1	5134.00	58.4 PK	74.0	-15.6	1.53 H	222	54.8	3.6
2	5134.00	46.5 AV	54.0	-7.5	1.53 H	222	42.9	3.6
3	*5210.00	93.4 PK			1.53 H	222	89.7	3.7
4	*5210.00	82.9 AV			1.53 H	222	79.2	3.7
5	5350.00	50.0 PK	74.0	-24.0	1.53 H	222	45.9	4.1
6	5350.00	38.2 AV	54.0	-15.8	1.53 H	222	34.1	4.1
7	#10420.00	47.6 PK	74.0	-26.4	1.27 H	293	34.5	13.1
8	#10420.00	36.4 AV	54.0	-17.6	1.27 H	293	23.3	13.1
9	15630.00	45.2 PK	74.0	-28.8	1.58 H	342	31.6	13.6
10	15630.00	33.3 AV	54.0	-20.7	1.58 H	342	19.7	13.6

ANTENNA POLARITY & TEST DISTANCE: VERTICAL AT 3 M

NO.	FREQ. (MHz)	EMISSION LEVEL (dBuV/m)	LIMIT (dBuV/m)	MARGIN (dB)	ANTENNA HEIGHT (m)	TABLE ANGLE (Degree)	RAW VALUE (dBuV)	CORRECTION FACTOR (dB/m)
1	5134.00	64.8 PK	74.0	-9.2	1.50 V	220	61.2	3.6
2	5134.00	52.9 AV	54.0	-1.1	1.50 V	220	49.3	3.6
3	*5210.00	107.5 PK			1.50 V	220	103.8	3.7
4	*5210.00	97.5 AV			1.50 V	220	93.8	3.7
5	5350.00	51.4 PK	74.0	-22.6	1.50 V	220	47.3	4.1
6	5350.00	39.6 AV	54.0	-14.4	1.50 V	220	35.5	4.1
7	#10420.00	48.6 PK	74.0	-25.4	1.46 V	358	35.5	13.1
8	#10420.00	37.4 AV	54.0	-16.6	1.46 V	358	24.3	13.1
9	15630.00	45.7 PK	74.0	-28.3	2.67 V	157	32.1	13.6
10	15630.00	35.6 AV	54.0	-18.4	2.67 V	157	22.0	13.6

REMARKS:

1. Emission Level(dBuV/m) = Raw Value(dBuV) + Correction Factor(dB/m)
2. Correction Factor(dB/m) = Antenna Factor(dB/m) + Cable Factor(dB) – Pre-Amplifier Factor(dB)
3. The other emission levels were very low against the limit.
4. Margin value = Emission Level – Limit value
5. " * ": Fundamental frequency.
6. " # ": The radiated frequency is out of the restricted band.

CHANNEL	TX Channel 155	DETECTOR FUNCTION	Peak (PK)
FREQUENCY RANGE	1GHz ~ 40GHz		Average (AV)

ANTENNA POLARITY & TEST DISTANCE: HORIZONTAL AT 3 M

NO.	FREQ. (MHz)	EMISSION LEVEL (dBuV/m)	LIMIT (dBuV/m)	MARGIN (dB)	ANTENNA HEIGHT (m)	TABLE ANGLE (Degree)	RAW VALUE (dBuV)	CORRECTION FACTOR (dB/m)
1	#5645.31	61.8 PK	68.2	-6.4	1.50 H	211	57.4	4.4
2	*5775.00	99.0 PK			1.50 H	211	94.6	4.4
3	*5775.00	89.3 AV			1.50 H	211	84.9	4.4
4	#5949.15	59.4 PK	68.2	-8.8	1.50 H	211	54.7	4.7
5	11550.00	44.6 PK	74.0	-29.4	1.58 H	7	31.1	13.5
6	11550.00	34.2 AV	54.0	-19.8	1.58 H	7	20.7	13.5
7	#17325.00	44.6 PK	74.0	-29.4	1.51 H	339	26.8	17.8
8	#17325.00	34.8 AV	54.0	-19.2	1.51 H	339	17.0	17.8

ANTENNA POLARITY & TEST DISTANCE: VERTICAL AT 3 M

NO.	FREQ. (MHz)	EMISSION LEVEL (dBuV/m)	LIMIT (dBuV/m)	MARGIN (dB)	ANTENNA HEIGHT (m)	TABLE ANGLE (Degree)	RAW VALUE (dBuV)	CORRECTION FACTOR (dB/m)
1	#5634.50	66.3 PK	68.2	-1.9	1.50 V	0	61.9	4.4
2	*5775.00	114.5 PK			1.50 V	0	110.1	4.4
3	*5775.00	105.5 AV			1.50 V	0	101.1	4.4
4	#5938.94	62.8 PK	68.2	-5.4	1.50 V	0	58.1	4.7
5	11550.00	48.7 PK	74.0	-25.3	1.84 V	232	35.2	13.5
6	11550.00	38.8 AV	54.0	-15.2	1.84 V	232	25.3	13.5
7	#17325.00	46.4 PK	74.0	-27.6	2.70 V	133	28.6	17.8
8	#17325.00	35.7 AV	54.0	-18.3	2.70 V	133	17.9	17.8

REMARKS:

1. Emission Level(dBuV/m) = Raw Value(dBuV) + Correction Factor(dB/m)
2. Correction Factor(dB/m) = Antenna Factor(dB/m) + Cable Factor(dB) – Pre-Amplifier Factor(dB)
3. The other emission levels were very low against the limit.
4. Margin value = Emission Level – Limit value
5. " * ": Fundamental frequency.
6. " # ": The radiated frequency is out of the restricted band.

Below 1GHz Worst-Case Data: 802.11ac (VHT40)

CHANNEL	TX Channel 151	DETECTOR FUNCTION	Quasi-Peak (QP)
FREQUENCY RANGE	9kHz ~ 1GHz		

ANTENNA POLARITY & TEST DISTANCE: HORIZONTAL AT 3 M

NO.	FREQ. (MHz)	EMISSION LEVEL (dBuV/m)	LIMIT (dBuV/m)	MARGIN (dB)	ANTENNA HEIGHT (m)	TABLE ANGLE (Degree)	RAW VALUE (dBuV)	CORRECTION FACTOR (dB/m)
1	88.98	36.9 QP	43.5	-6.6	2.00 H	66	51.0	-14.1
2	109.13	36.6 QP	43.5	-6.9	3.00 H	278	47.7	-11.1
3	250.00	29.8 QP	46.0	-16.2	1.00 H	101	39.4	-9.6
4	300.00	29.2 QP	46.0	-16.8	1.00 H	29	36.7	-7.5
5	750.03	35.0 QP	46.0	-11.0	1.00 H	316	33.4	1.6
6	799.99	36.2 QP	46.0	-9.8	2.00 H	360	34.2	2.0

ANTENNA POLARITY & TEST DISTANCE: VERTICAL AT 3 M

NO.	FREQ. (MHz)	EMISSION LEVEL (dBuV/m)	LIMIT (dBuV/m)	MARGIN (dB)	ANTENNA HEIGHT (m)	TABLE ANGLE (Degree)	RAW VALUE (dBuV)	CORRECTION FACTOR (dB/m)
1	71.71	32.5 QP	40.0	-7.5	2.00 V	360	43.3	-10.8
2	88.85	31.7 QP	43.5	-11.8	3.00 V	318	45.8	-14.1
3	300.02	31.2 QP	46.0	-14.8	2.00 V	0	38.7	-7.5
4	500.01	30.7 QP	46.0	-15.3	1.00 V	266	33.7	-3.0
5	600.00	33.2 QP	46.0	-12.8	1.00 V	179	34.1	-0.9
6	800.03	35.2 QP	46.0	-10.8	3.00 V	360	33.2	2.0

REMARKS:

1. Emission Level(dBuV/m) = Raw Value(dBuV) + Correction Factor(dB/m)
2. Correction Factor(dB/m) = Antenna Factor(dB/m) + Cable Factor(dB) – Pre-Amplifier Factor(dB)
3. The other emission levels were very low against the limit.
4. Margin value = Emission Level – Limit value

4.2 Conducted Emission Measurement

4.2.1 Limits of Conducted Emission Measurement

Frequency (MHz)	Conducted Limit (dBuV)	
	Quasi-peak	Average
0.15 - 0.5	66 - 56	56 - 46
0.50 - 5.0	56	46
5.0 - 30.0	60	50

Note: 1. The lower limit shall apply at the transition frequencies.

2. The limit decreases in line with the logarithm of the frequency in the range of 0.15 to 0.50MHz.

4.2.2 Test Instruments

DESCRIPTION & MANUFACTURER	MODEL NO.	SERIAL NO.	CALIBRATED DATE	CALIBRATED UNTIL
Test Receiver R&S	ESCS 30	847124/029	Oct. 24, 2016	Oct. 23, 2017
Line-Impedance Stabilization Network (for EUT) R&S	ESH3-Z5	848773/004	Oct. 26, 2016	Oct. 25, 2017
Line-Impedance Stabilization Network (for Peripheral) R&S	ENV216	100072	June 03, 2017	June 02, 2018
50 ohms Terminator	N/A	EMC-02	Sep. 29, 2016	Sep. 28, 2017
RF Cable	5D-FB	COCCAB-001	Sep. 30, 2016	Sep. 29, 2017
10 dB PAD Mini-Circuits	HAT-10+	CONATT-004	June 20, 2016	June 19, 2017
Software BVADT	BVADT_Cond_ V7.3.7.4	NA	NA	NA

Note:

1. The calibration interval of the above test instruments are 12 months and the calibrations are traceable to NML/ROC and NIST/USA.
2. The test was performed in Shielded Room No. 1.
3. Tested Date: June 15, 2017

4.2.3 Test Procedure

- The EUT was placed 0.4 meters from the conducting wall of the shielded room with EUT being connected to the power mains through a line impedance stabilization network (LISN). Other support units were connected to the power mains through another LISN. The two LISNs provide 50 ohm/ 50uH of coupling impedance for the measuring instrument.
- Both lines of the power mains connected to the EUT were checked for maximum conducted interference.
- The frequency range from 150kHz to 30MHz was searched. Emission levels under (Limit - 20dB) was not recorded.

NOTE: The resolution bandwidth and video bandwidth of test receiver is 9kHz for quasi-peak detection (QP) and average detection (AV) at frequency 0.15MHz-30MHz.

4.2.4 Deviation from Test Standard

No deviation.

4.2.5 Test Setup

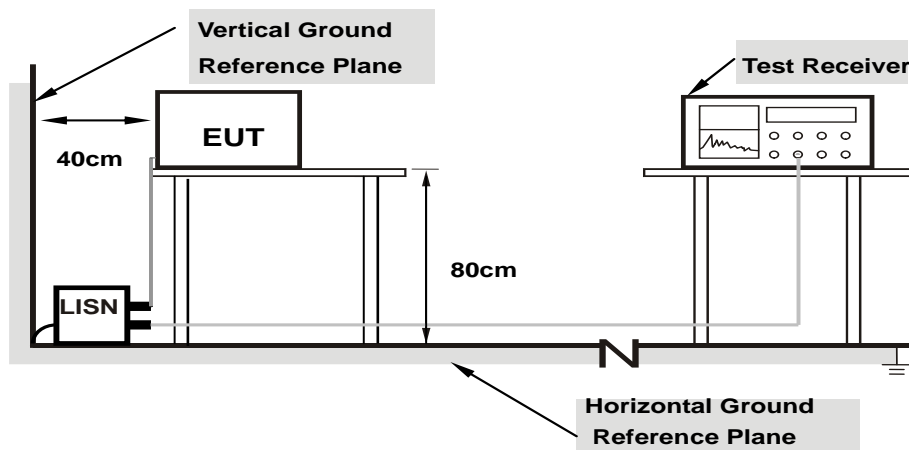

Note: 1.Support units were connected to second LISN.

For the actual test configuration, please refer to the attached file (Test Setup Photo).

4.2.6 EUT Operating Conditions

Same as 4.1.6.

4.2.7 Test Results

Phase	Line (L)	Detector Function	Quasi-Peak (QP) / Average (AV)
-------	----------	-------------------	--------------------------------

No	Freq. [MHz]	Corr. Factor (dB)	Reading Value [dB (uV)]		Emission Level [dB (uV)]		Limit [dB (uV)]		Margin (dB)	
			Q.P.	AV.	Q.P.	AV.	Q.P.	AV.	Q.P.	AV.
			1	0.17734	10.19	37.78	33.34	47.97	43.53	64.61
2	0.26684	10.20	29.50	26.16	39.70	36.36	61.22	51.22	-21.52	-14.86
3	0.35369	10.21	31.21	30.37	41.42	40.58	58.88	48.88	-17.46	-8.30
4	1.15234	10.26	28.55	20.00	38.81	30.26	56.00	46.00	-17.19	-15.74
5	3.95313	10.24	27.78	22.34	38.02	32.58	56.00	46.00	-17.98	-13.42
6	28.82813	11.46	19.05	13.95	30.51	25.41	60.00	50.00	-29.49	-24.59

REMARKS:

1. Q.P. and AV. are abbreviations of quasi-peak and average individually.
2. The emission levels of other frequencies were very low against the limit.
3. Margin value = Emission level - Limit value
4. Correction factor = Insertion loss + Cable loss
5. Emission Level = Correction Factor + Reading Value.

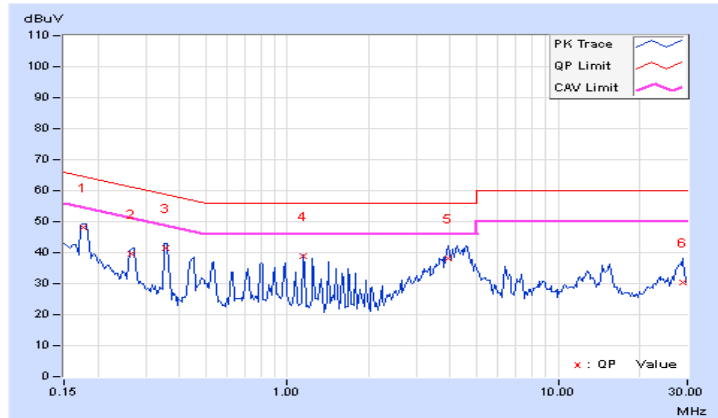

Phase	Neutral (N)	Detector Function	Quasi-Peak (QP) / Average (AV)
-------	-------------	-------------------	--------------------------------

No	Freq. [MHz]	Corr. Factor (dB)	Reading Value		Emission Level		Limit		Margin	
			[dB (uV)]		[dB (uV)]		[dB (uV)]		(dB)	
			Q.P.	AV.	Q.P.	AV.	Q.P.	AV.	Q.P.	AV.
1	0.17344	10.17	29.55	21.61	39.72	31.78	64.79	54.79	-25.07	-23.01
2	0.35313	10.20	27.38	26.47	37.58	36.67	58.89	48.89	-21.31	-12.22
3	0.98406	10.23	24.70	17.12	34.93	27.35	56.00	46.00	-21.07	-18.65
4	3.94531	10.16	27.49	22.05	37.65	32.21	56.00	46.00	-18.35	-13.79
5	4.58222	10.19	30.70	27.08	40.89	37.27	56.00	46.00	-15.11	-8.73
6	14.94141	10.88	29.19	19.52	40.07	30.40	60.00	50.00	-19.93	-19.60

REMARKS:

1. Q.P. and AV. are abbreviations of quasi-peak and average individually.
2. The emission levels of other frequencies were very low against the limit.
3. Margin value = Emission level - Limit value
4. Correction factor = Insertion loss + Cable loss
5. Emission Level = Correction Factor + Reading Value.

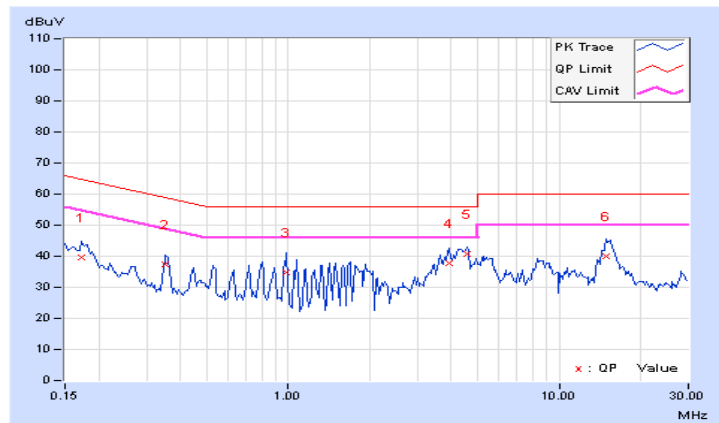

4.3 Transmit Power Measurement

4.3.1 Limits of Transmit Power Measurement

Operation Band	EUT Category		LIMIT
U-NII-1	---	Outdoor Access Point	1 Watt (30 dBm) (Max. e.i.r.p \leq 125mW(21 dBm) at any elevation angle above 30 degrees as measured from the horizon)
	---	Fixed point-to-point Access Point	1 Watt (30 dBm)
	√	Indoor Access Point	1 Watt (30 dBm)
	---	Mobile and Portable client device	250mW (24 dBm)
U-NII-2A	---		250mW (24 dBm) or 11 dBm+10 log B*
U-NII-2C	---		250mW (24 dBm) or 11 dBm+10 log B*
U-NII-3	√		1 Watt (30 dBm)

*B is the 26 dB emission bandwidth in megahertz

Per KDB 662911 Method of conducted output power measurement on IEEE 802.11 devices,

Array Gain = 0 dB (i.e., no array gain) for $N_{ANT} \leq 4$;

Array Gain = 0 dB (i.e., no array gain) for channel widths ≥ 40 MHz for any N_{ANT} ;

Array Gain = $5 \log(N_{ANT}/N_{SS})$ dB or 3 dB, whichever is less for 20-MHz channel widths with $N_{ANT} \geq 5$.

For power measurements on all other devices: Array Gain = $10 \log(N_{ANT}/N_{SS})$ dB.

4.3.2 Test Setup

For Power Output Measurement

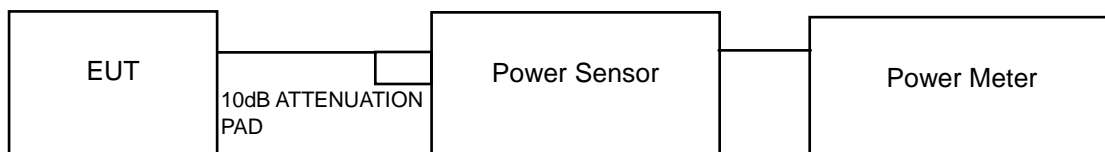

For 26dB Bandwidth

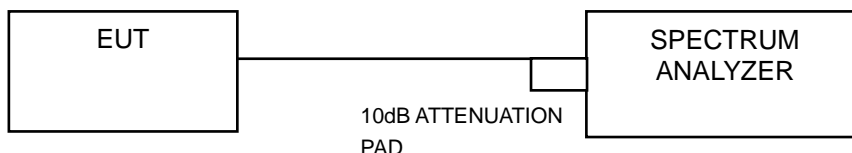

4.3.3 Test Instruments

Refer to section 4.1.2 to get information of above instrument.

4.3.4 Test Procedure

FOR AVERAGE POWER MEASUREMENT

Method PM is used to perform output power measurement, trigger and gating function of wide band power meter is enabled to measure max output power of TX on burst. Duty factor is not added to measured value.

FOR 26dB BANDWIDTH

- 1) Set RBW = approximately 1% of the emission bandwidth.
- 2) Set the VBW > RBW.
- 3) Detector = Peak.
- 4) Trace mode = max hold.
- 5) Measure the maximum width of the emission that is 26 dB down from the peak of the emission. Compare this with the RBW setting of the analyzer. Readjust RBW and repeat measurement as needed until the RBW/EBW ratio is approximately 1%.

4.3.5 Deviation from Test Standard

No deviation.

4.3.6 EUT Operating Conditions

The software provided by client to enable the EUT under transmission Condition continuously at lowest, middle and highest channel frequencies individually.

4.3.7 Test Result

POWER OUTPUT:

CDD Mode:

802.11a

Chan.	Chan. Freq. (MHz)	Average Power (dBm)				Total Power (mW)	Total Power (dBm)	Limit (dBm)	Pass / Fail
		Chain 0	Chain 1	Chain 2	Chain 3				
36	5180	15.15	15.13	15.70	15.85	140.931	21.49	27.59	Pass
40	5200	14.55	14.56	15.51	15.64	129.293	21.12	27.59	Pass
48	5240	14.81	14.13	15.46	15.95	130.662	21.16	27.59	Pass
149	5745	21.41	20.80	20.83	22.25	547.523	27.38	27.59	Pass
157	5785	21.17	21.16	21.23	22.05	554.599	27.44	27.59	Pass
165	5825	20.72	21.53	21.72	21.80	560.215	27.48	27.59	Pass

Note: Max.gain = 8.41dBi > 6dBi , so the power limit shall be reduced to $30-(8.41-6) = 27.59\text{dBm}$.

802.11ac (VHT20)

Chan.	Chan. Freq. (MHz)	Average Power (dBm)				Total Power (mW)	Total Power (dBm)	Limit (dBm)	Pass / Fail
		Chain 0	Chain 1	Chain 2	Chain 3				
36	5180	14.83	14.78	15.43	15.65	132.112	21.21	27.59	Pass
40	5200	14.81	14.63	15.51	15.86	133.42	21.25	27.59	Pass
48	5240	15.00	14.35	15.55	16.27	137.106	21.37	27.59	Pass
149	5745	21.11	20.59	20.65	21.96	516.854	27.13	27.59	Pass
157	5785	20.94	20.95	21.02	21.94	531.405	27.25	27.59	Pass
165	5825	20.51	21.32	21.64	21.69	541.431	27.34	27.59	Pass

Note: Max.gain = 8.41dBi > 6dBi , so the power limit shall be reduced to $30-(8.41-6) = 27.59\text{dBm}$.

802.11ac (VHT40)

Chan.	Chan. Freq. (MHz)	Average Power (dBm)				Total Power (mW)	Total Power (dBm)	Limit (dBm)	Pass / Fail
		Chain 0	Chain 1	Chain 2	Chain 3				
38	5190	15.71	15.64	16.38	16.59	162.938	22.12	27.59	Pass
46	5230	17.83	17.23	18.48	18.99	263.238	24.20	27.59	Pass
151	5755	21.54	20.95	20.94	22.45	566.969	27.54	27.59	Pass
159	5795	20.99	20.92	21.20	21.85	534.133	27.28	27.59	Pass

Note: Max.gain = 8.41dBi > 6dBi , so the power limit shall be reduced to $30-(8.41-6) = 27.59\text{dBm}$.

802.11ac (VHT80)

Chan.	Chan. Freq. (MHz)	Average Power (dBm)				Total Power (mW)	Total Power (dBm)	Limit (dBm)	Pass / Fail
		Chain 0	Chain 1	Chain 2	Chain 3				
45	5210	9.50	9.25	10.14	10.56	39.031	15.91	27.59	Pass
55	5775	17.80	17.61	17.73	18.66	250.677	23.99	27.59	Pass

Note: Max.gain = 8.41dBi > 6dBi , so the power limit shall be reduced to $30-(8.41-6) = 27.59\text{dBm}$.

Beamforming Mode:

802.11ac (VHT20)

Chan.	Chan. Freq. (MHz)	Average Power (dBm)				Total Power (mW)	Total Power (dBm)	Limit (dBm)	Pass / Fail
		Chain 0	Chain 1	Chain 2	Chain 3				
36	5180	14.83	14.78	15.43	15.65	132.112	21.21	21.57	Pass
40	5200	14.81	14.63	15.51	15.86	133.42	21.25	21.57	Pass
48	5240	15.00	14.35	15.55	16.27	137.106	21.37	21.57	Pass
149	5745	15.09	14.58	14.67	15.94	129.566	21.12	21.57	Pass
157	5785	14.94	14.97	15.03	15.92	133.52	21.26	21.57	Pass
165	5825	14.52	15.21	15.52	15.70	134.302	21.28	21.57	Pass

Note: Max.gain = 8.41dBi > 6dBi , so the power limit shall be reduced to 30-(8.41-6) = 27.59dBm.

802.11ac (VHT40)

Chan.	Chan. Freq. (MHz)	Average Power (dBm)				Total Power (mW)	Total Power (dBm)	Limit (dBm)	Pass / Fail
		Chain 0	Chain 1	Chain 2	Chain 3				
38	5190	15.71	15.64	16.38	16.59	162.938	22.12	27.59	Pass
46	5230	17.83	17.23	18.48	18.99	263.238	24.20	27.59	Pass
151	5755	21.54	20.95	20.94	22.45	566.969	27.54	27.59	Pass
159	5795	20.99	20.92	21.20	21.85	534.133	27.28	27.59	Pass

Note: Max.gain = 8.41dBi > 6dBi , so the power limit shall be reduced to 30-(8.41-6) = 27.59dBm.

802.11ac (VHT80)

Chan.	Chan. Freq. (MHz)	Average Power (dBm)				Total Power (mW)	Total Power (dBm)	Limit (dBm)	Pass / Fail
		Chain 0	Chain 1	Chain 2	Chain 3				
45	5210	9.50	9.25	10.14	10.56	39.031	15.91	27.59	Pass
55	5775	17.80	17.61	17.73	18.66	250.677	23.99	27.59	Pass

Note: Max.gain = 8.41dBi > 6dBi , so the power limit shall be reduced to 30-(8.41-6) = 27.59dBm.

26dB BANDWIDTH:

802.11a

Channel	Frequency (MHz)	26dBc Bandwidth (MHz)			
		Chain 0	Chain 1	Chain 2	Chain 3
36	5180	19.75	19.81	19.95	20.18
40	5200	20.04	19.76	19.90	19.92
48	5240	20.07	19.90	20.13	19.80

802.11ac (VHT20)

Channel	Frequency (MHz)	26dBc Bandwidth (MHz)			
		Chain 0	Chain 1	Chain 2	Chain 3
36	5180	20.82	20.68	20.91	20.82
40	5200	20.69	20.58	20.80	20.81
48	5240	20.73	20.73	21.07	21.00

802.11ac (VHT40)

Channel	Frequency (MHz)	26dBc Bandwidth (MHz)			
		Chain 0	Chain 1	Chain 2	Chain 3
38	5190	40.98	40.95	40.84	40.91
46	5230	40.89	41.14	40.96	40.99

802.11ac (VHT80)

Channel	Frequency (MHz)	26dBc Bandwidth (MHz)			
		Chain 0	Chain 1	Chain 2	Chain 3
42	5210	84.74	84.98	85.45	84.91

SPECTRUM PLOT OF WORST VALUE

802.11a/Chain 2/CH48

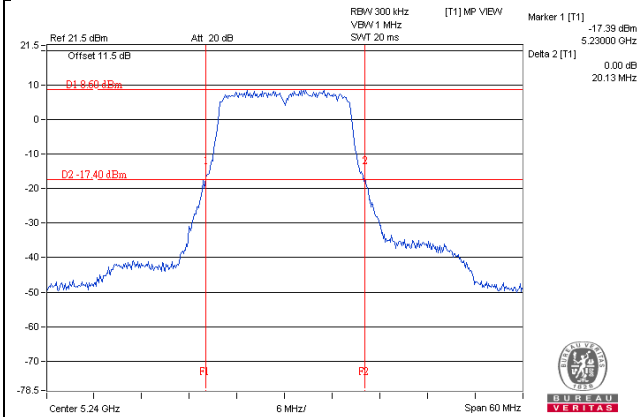

802.11ac (VHT20)/Chain 2/CH48

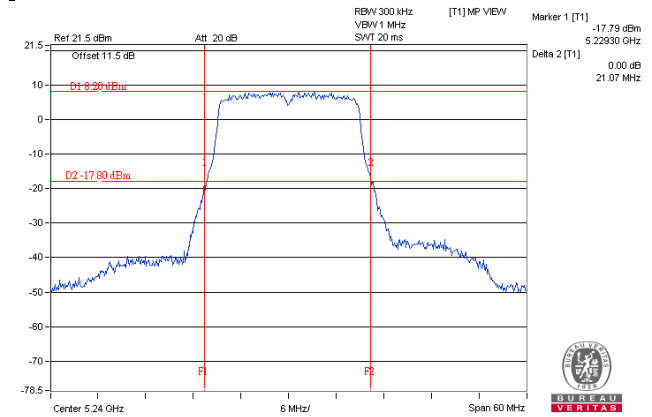

802.11ac (VHT40)/Chain 1/CH46

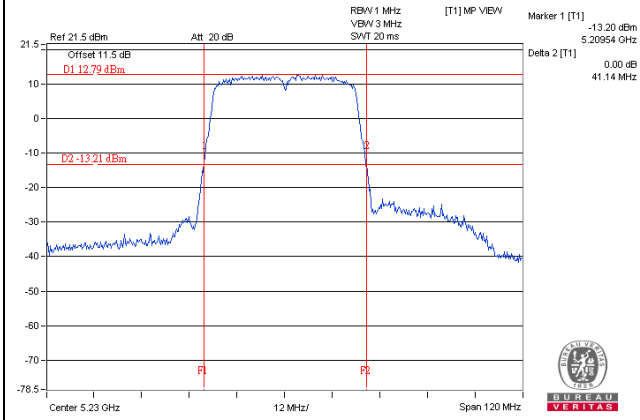

802.11ac (VHT80)/Chain 2/CH42

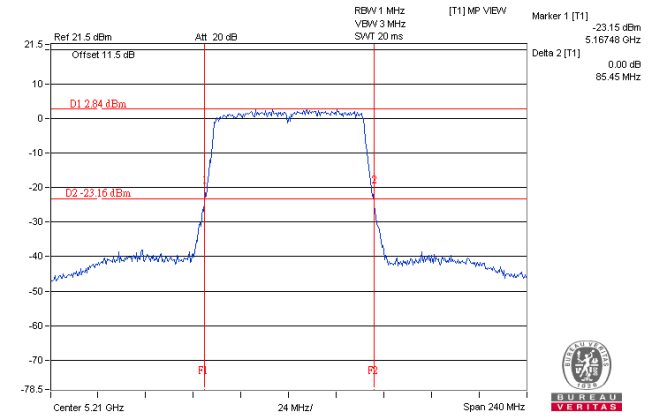

4.4 Occupied Bandwidth Measurement

4.4.1 Test Setup

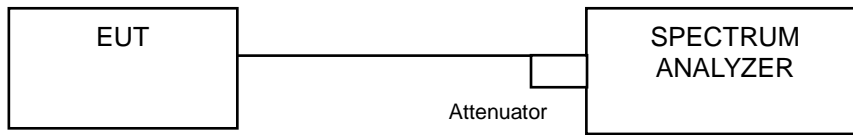

4.4.2 Test Instruments

Refer to section 4.1.2 to get information of above instrument.

4.4.3 Test Procedure

The transmitter output was connected to the spectrum analyzer through an attenuator. The bandwidth of the fundamental frequency was measured by spectrum analyzer with resolution bandwidth in the range of 1% to 5% of the anticipated emission bandwidth, and a video bandwidth at least 3x the resolution bandwidth and set the detector to SAMPLE. The width of a frequency band such that, below the lower and above the upper frequency limits, the mean powers emitted are each equal to a specified percentage 0.5 %of the total mean power of a given emission.

4.4.4 Test Results

802.11a

Channel	Frequency (MHz)	Occupied Bandwidth (MHz)			
		Chain 0	Chain 1	Chain 2	Chain 3
36	5180	16.56	16.44	16.68	16.44
40	5200	16.44	16.44	16.44	16.44
48	5240	16.44	16.56	16.56	16.44
149	5745	16.68	16.56	16.56	16.92
157	5785	16.68	16.80	16.68	16.80
165	5825	16.56	16.92	16.68	16.80

802.11ac (VHT20)

Channel	Frequency (MHz)	Occupied Bandwidth (MHz)			
		Chain 0	Chain 1	Chain 2	Chain 3
36	5180	17.64	17.64	17.76	17.64
40	5200	17.64	17.76	17.64	17.64
48	5240	17.64	17.64	17.64	17.64
149	5745	17.76	17.76	17.76	18.00
157	5785	17.76	17.76	18.00	18.00
165	5825	17.88	18.00	18.00	17.88

802.11ac (VHT40)

Channel	Frequency (MHz)	Occupied Bandwidth (MHz)			
		Chain 0	Chain 1	Chain 2	Chain 3
38	5190	36.24	36.24	36.24	36.24
46	5230	36.24	36.24	36.24	36.24
151	5755	36.24	36.48	36.24	36.72
159	5795	36.48	36.72	36.48	36.96

802.11ac (VHT80)

Channel	Frequency (MHz)	Occupied Bandwidth (MHz)			
		Chain 0	Chain 1	Chain 2	Chain 3
42	5210	75.84	75.84	76.32	76.32
155	5775	75.84	75.84	75.84	76.32

SPECTRUM PLOT OF WORST VALUE

802.11a/Chain 1/CH165

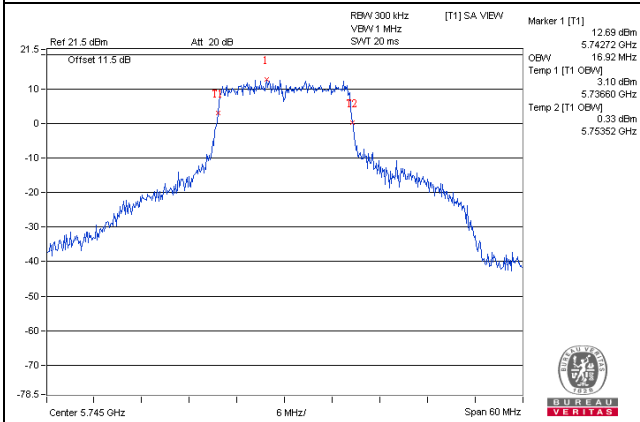

802.11ac (VHT20)/Chain 1/CH165

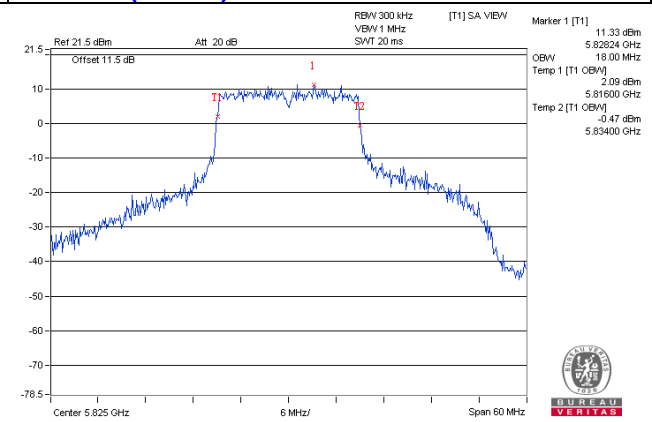

802.11ac (VHT40)/Chain 3/CH159

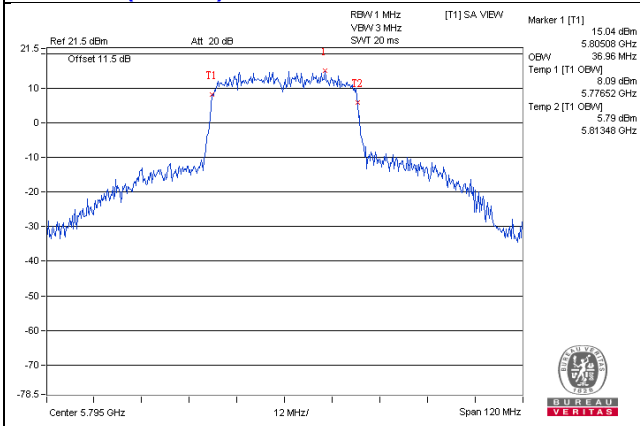

802.11ac (VHT80)/Chain 2/CH42

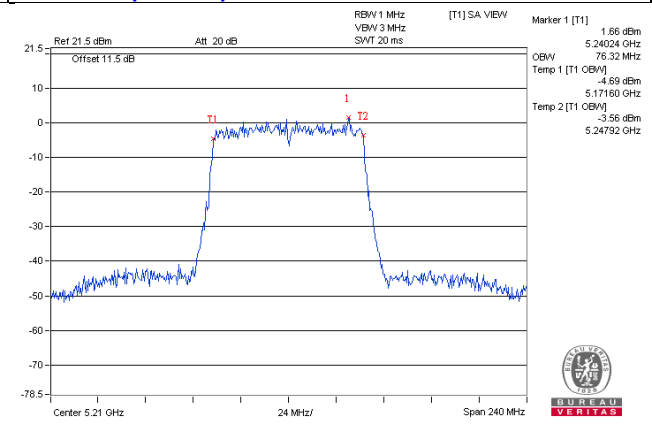

Spectrum Plot for near by DFS band (DFS is required, if 99% OCP straddle into U-NII-2A band)

802.11a_Chain0 / CH48

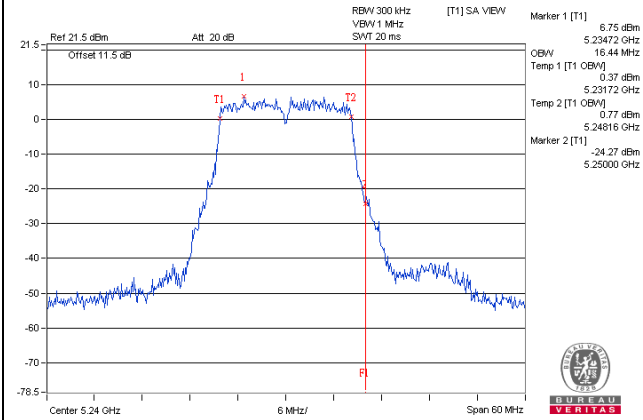

802.11a_Chain1 / CH48

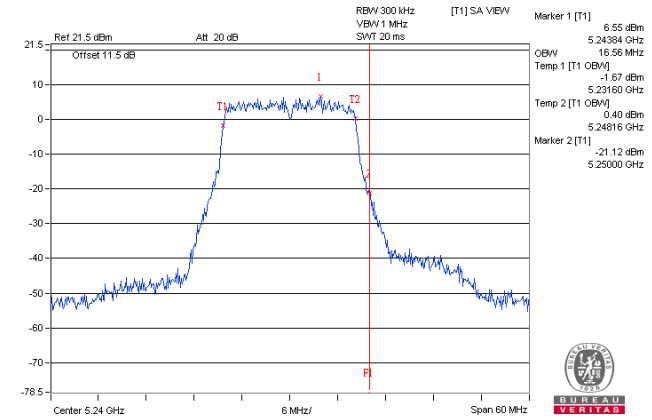

802.11a_Chain2 / CH48

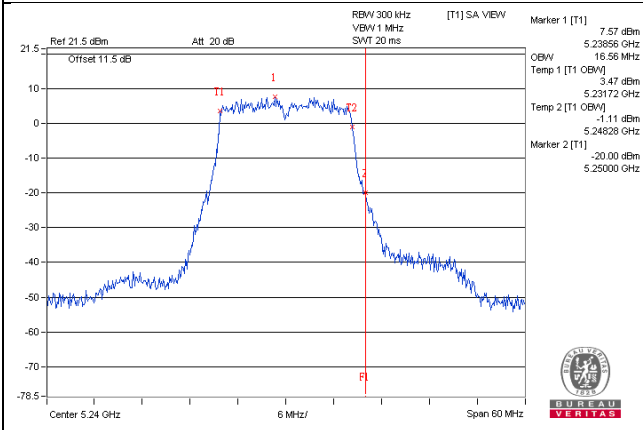

802.11a_Chain3 / CH48

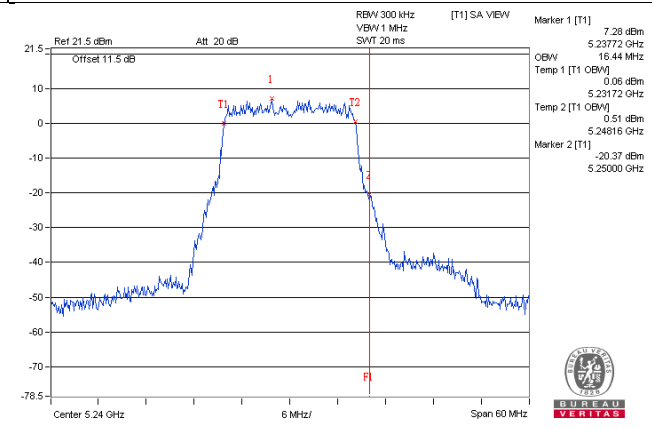

802.11ac(VHT20)_Chain0 / CH48

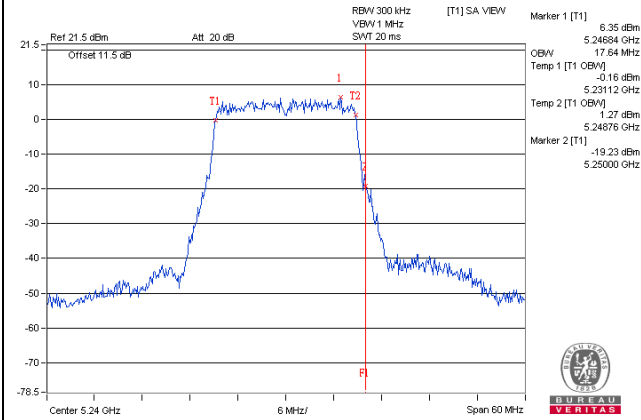

802.11ac(VHT20)_Chain1 / CH48

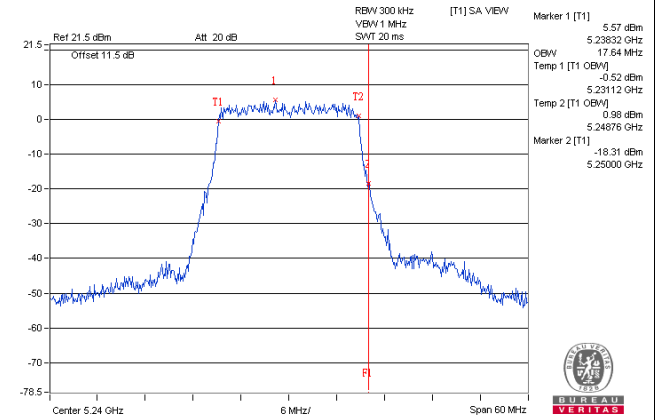

802.11ac(VHT20)_Chain2 / CH48

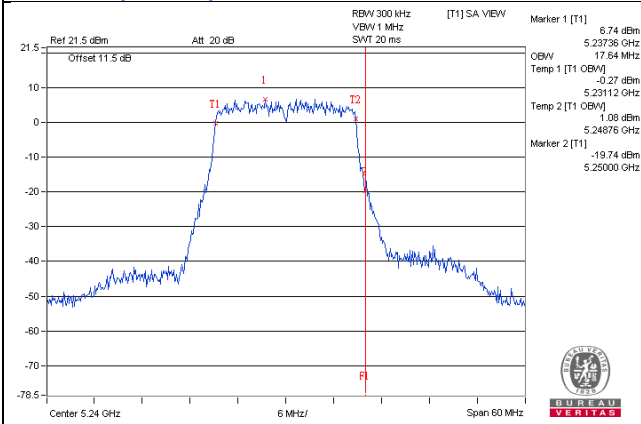

802.11ac(VHT20)_Chain3 / CH48

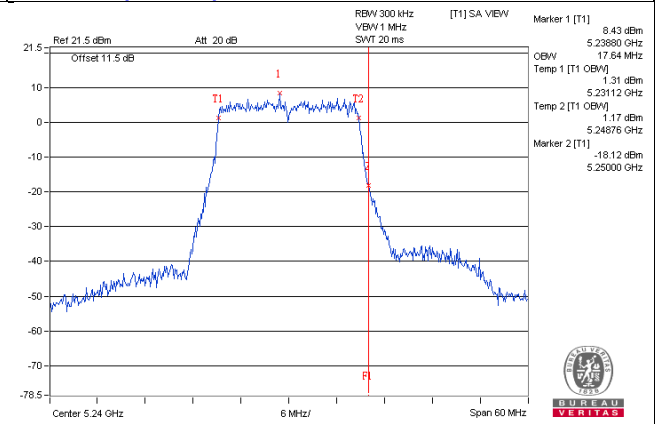

802.11ac(VHT40)_Chain0 / CH46

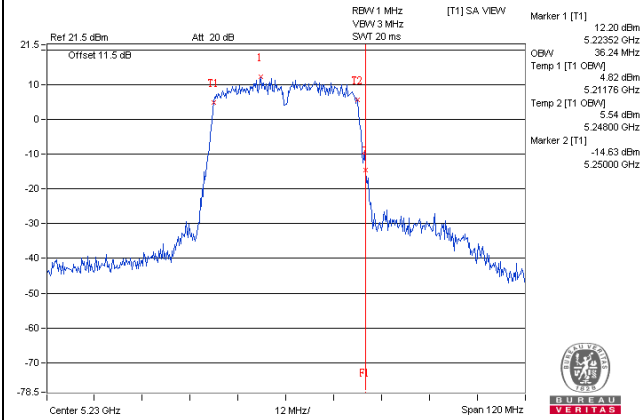

802.11ac(VHT40)_Chain1 / CH46

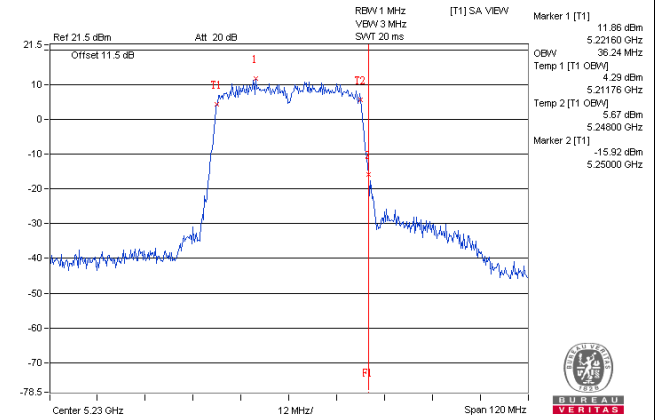

802.11ac(VHT40)_Chain2 / CH46

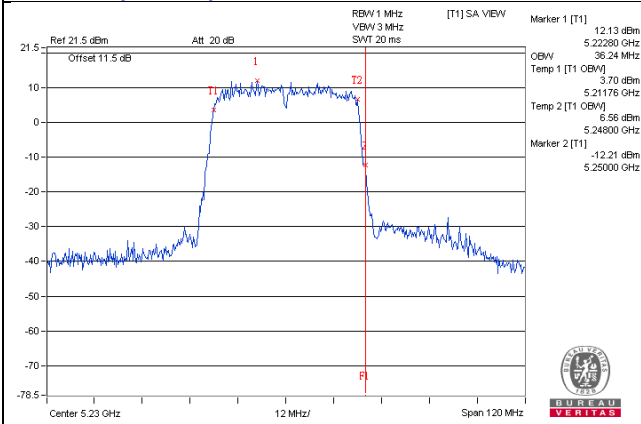

802.11ac(VHT40)_Chain3 / CH46

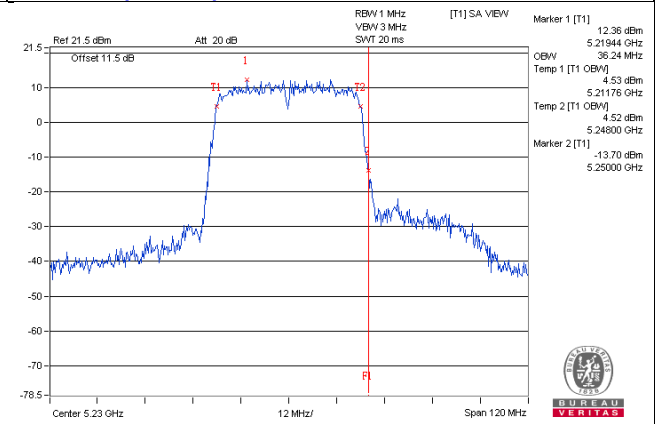

802.11ac(VHT80)_Chain0 / CH42

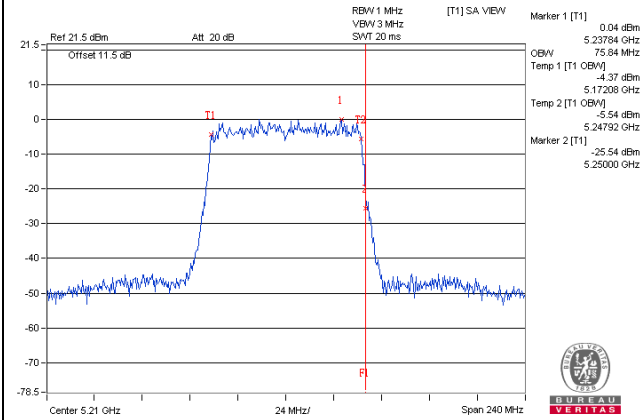

802.11ac(VHT80)_Chain1 / CH42

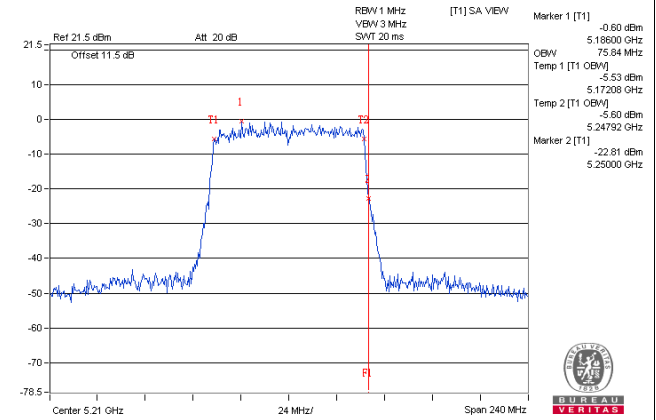

802.11ac(VHT80)_Chain2 / CH42

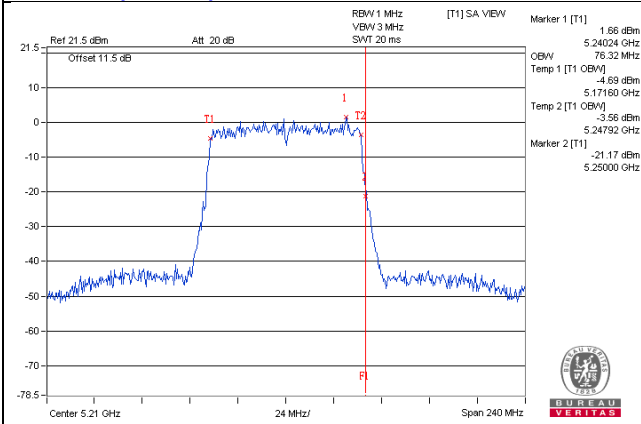

802.11ac(VHT80)_Chain3 / CH42

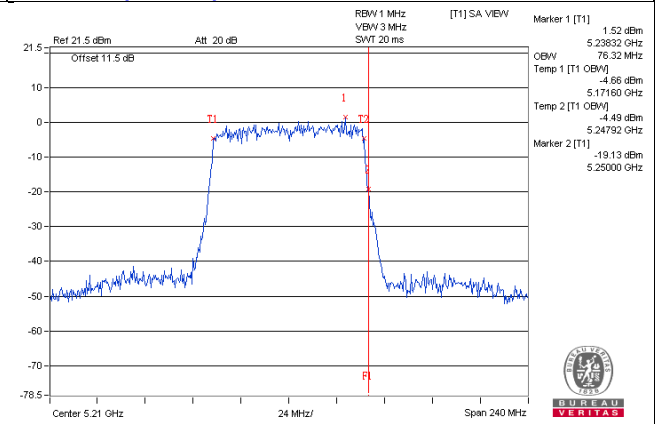

Spectrum Plot for near by DFS band (DFS is required, if 99% OCP straddle into U-NII-2C band)

802.11a_Chain0 / CH149

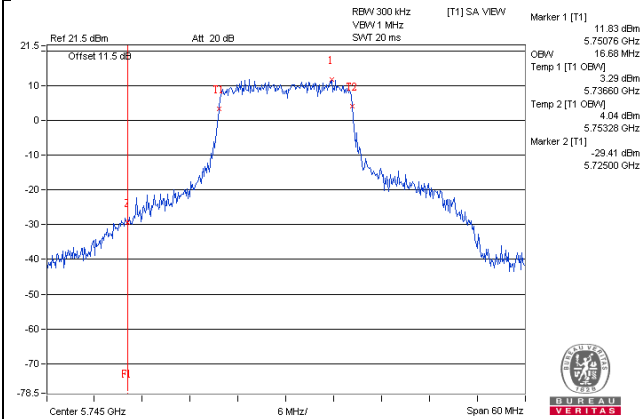

802.11a_Chain1 / CH149

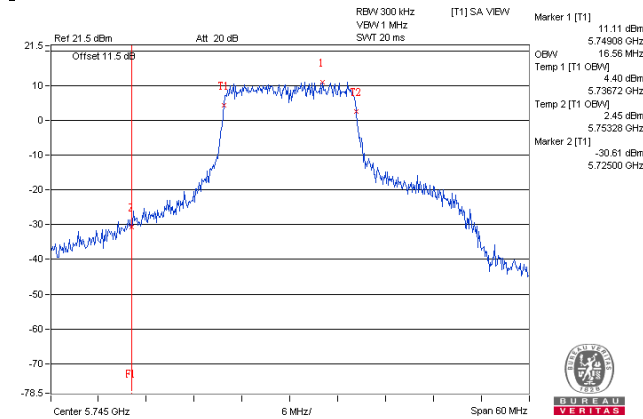

802.11a_Chain2 / CH149

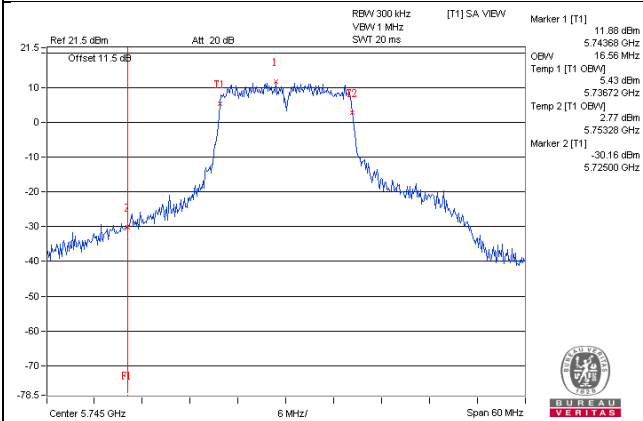

802.11a_Chain3 / CH149

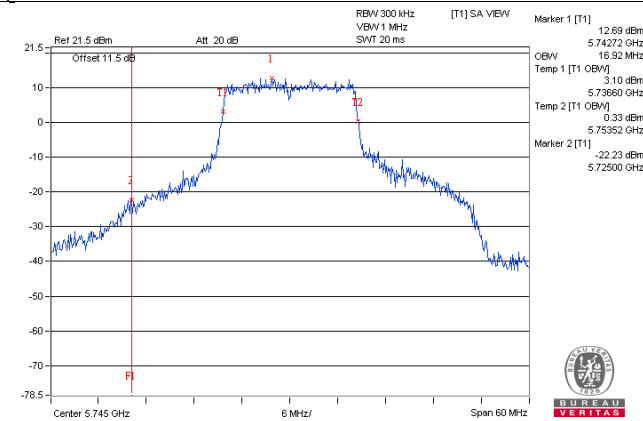

802.11ac(VHT20)_Chain0 / CH149

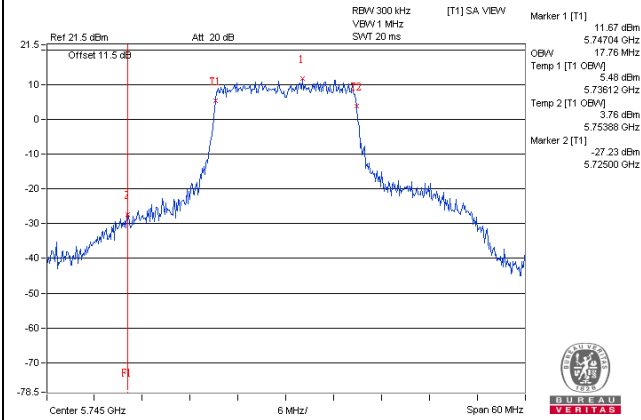

802.11ac(VHT20)_Chain1 / CH149

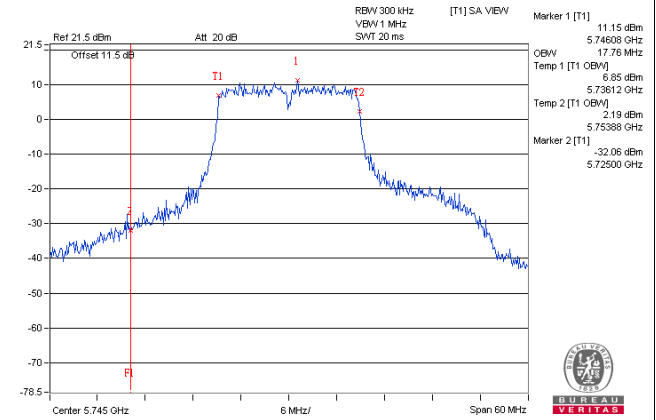

802.11ac(VHT20)_Chain2 / CH149

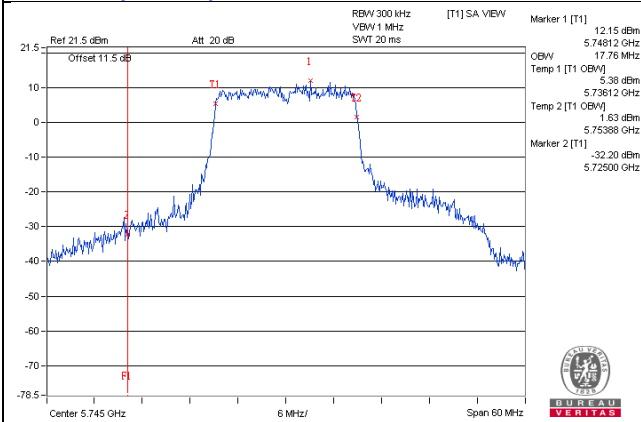

802.11ac(VHT20)_Chain3 / CH149

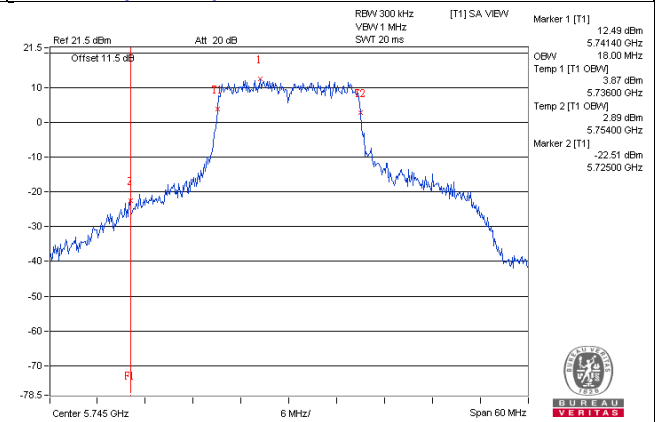

802.11ac(VHT40)_Chain0 / CH151

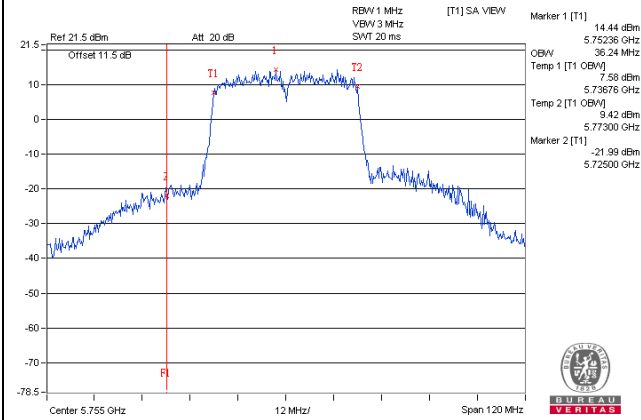

802.11ac(VHT40)_Chain1 / CH151

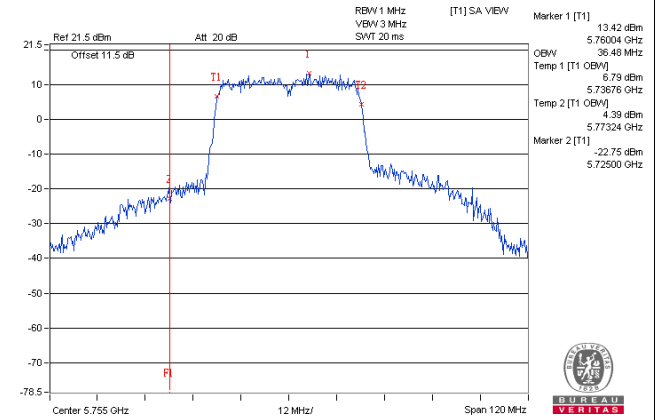

802.11ac(VHT40)_Chain2 / CH151

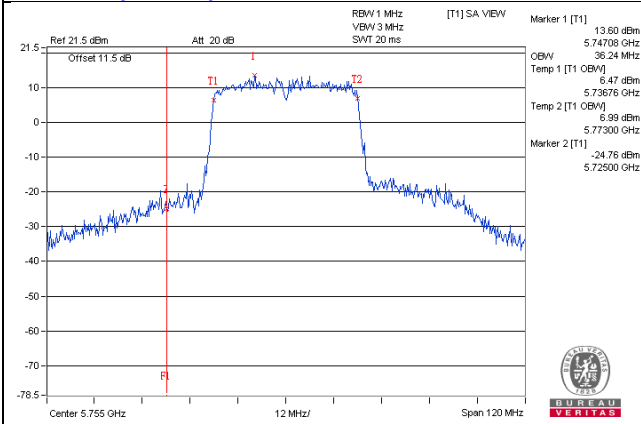

802.11ac(VHT40)_Chain3 / CH151

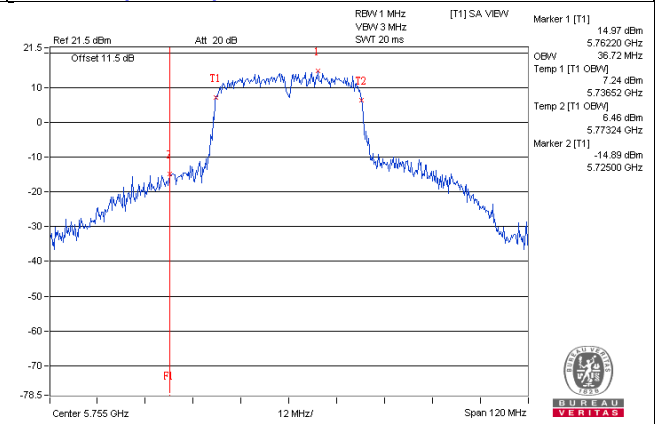

802.11ac(VHT80)_Chain0 / CH155

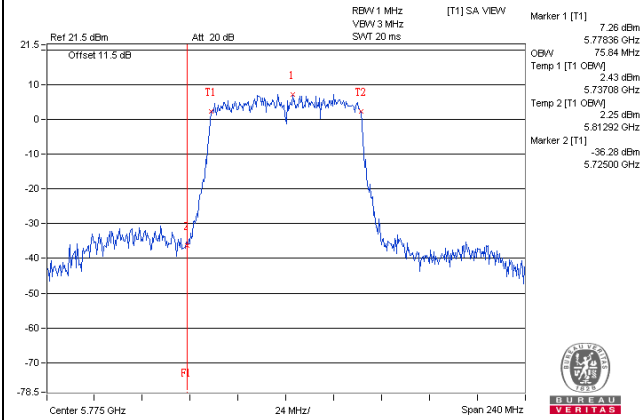

802.11ac(VHT80)_Chain1 / CH155

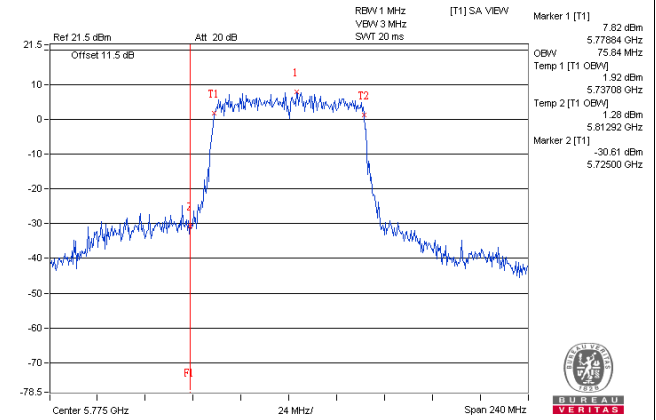

802.11ac(VHT80)_Chain2 / CH155

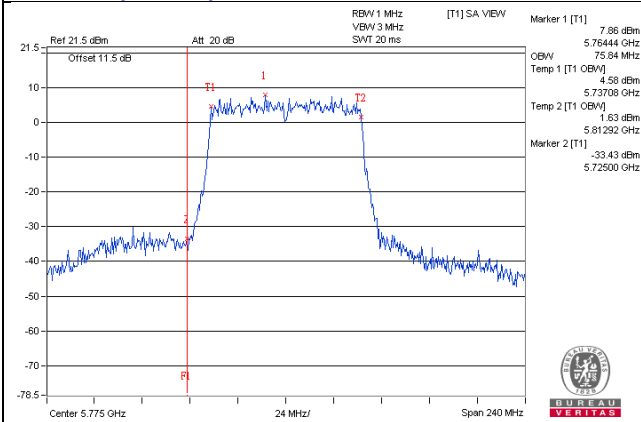

802.11ac(VHT80)_Chain3 / CH155

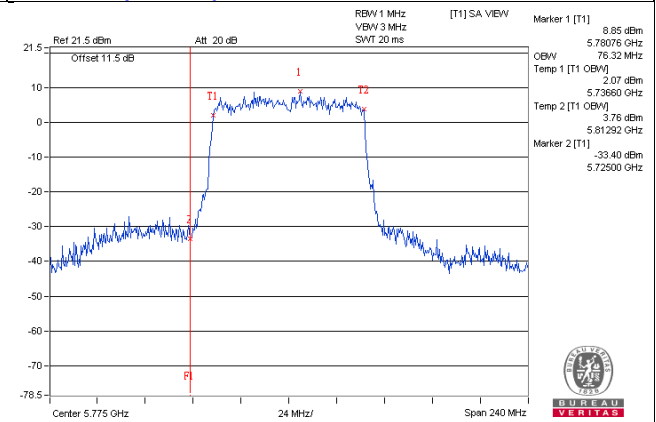

4.5 Peak Power Spectral Density Measurement

4.5.1 Limits of Peak Power Spectral Density Measurement

Operation Band	EUT Category		LIMIT
U-NII-1	---	Outdoor Access Point	17dBm/ MHz
	---	Fixed point-to-point Access Point	
	√	Indoor Access Point	
	---	Mobile and Portable client device	11dBm/ MHz
U-NII-2A	---		11dBm/ MHz
U-NII-2C	---		11dBm/ MHz
U-NII-3	√		30dBm/ 500kHz

4.5.2 Test Setup

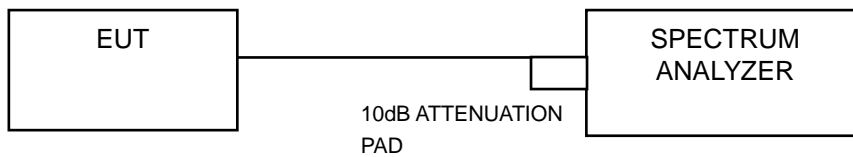

4.5.3 Test Instruments

Refer to section 4.1.2 to get information of above instrument.

4.5.4 Test Procedure

For U-NII-1 band:

If duty cycle of test signal is $\geq 98\%$

Using method SA-1

1. Set span to encompass the entire emission bandwidth (EBW) of the signal.
2. Set RBW = 1MHz, Set VBW ≥ 3 MHz, Detector = RMS
3. Set Channel power measure = 1MHz
4. Sweep time = auto, trigger set to "free run".
5. Trace average at least 100 traces in power averaging mode.
6. Record the max value

If duty cycle of test signal is $< 98\%$

Using method SA-2

1. Set span to encompass the entire emission bandwidth (EBW) of the signal.
2. Set RBW = 1MHz, Set VBW ≥ 3 MHz, Detector = RMS
3. Set Channel power measure = 1MHz
4. Sweep time = auto, trigger set to "free run".
5. Trace average at least 100 traces in power averaging mode.
6. Record the max value and add $10 \log(1/\text{duty cycle})$

For U-NII-3 band:

If duty cycle of test signal is $\geq 98\%$

1. Set span to encompass the entire emission bandwidth (EBW) of the signal.
2. Set RBW = 300 kHz, Set VBW ≥ 1 MHz, Detector = RMS
3. Use the peak marker function to determine the maximum power level in any 300 kHz band segment within the fundamental EBW.
4. Scale the observed power level to an equivalent value in 500 kHz by adjusting (reducing) the measured power by a bandwidth correction factor (BWCF) where $BWCF = 10 \log(500 \text{ kHz}/300 \text{ kHz})$
5. Sweep time = auto, trigger set to "free run".
6. Trace average at least 100 traces in power averaging mode.
7. Record the max value

If duty cycle of test signal is $< 98\%$

1. Set span to encompass the entire emission bandwidth (EBW) of the signal.
2. Set RBW = 300 kHz, Set VBW ≥ 1 MHz, Detector = RMS
3. Use the peak marker function to determine the maximum power level in any 300 kHz band segment within the fundamental EBW.
4. Scale the observed power level to an equivalent value in 500 kHz by adjusting (reducing) the measured power by a bandwidth correction factor (BWCF) where $BWCF = 10 \log(500 \text{ kHz}/300 \text{ kHz})$
5. Sweep time = auto, trigger set to "free run".
6. Trace average at least 100 traces in power averaging mode.
7. Record the max value and add $10 \log(1/\text{duty cycle})$

4.5.5 Deviation from Test Standard

No deviation.

4.5.6 EUT Operating Condition

Same as Item 4.3.6.

4.5.7 Test Results

For U-NII-1 Band

802.11a

Chan.	Freq. (MHz)	PSD (dBm/MHz)				Duty Factor	Total PSD With Duty Factor (dBm/MHz)	Maximum Limit (dBm/MHz)	Pass / Fail
		Chain 0	Chain 1	Chain 2	Chain 3				
36	5180	2.21	1.12	2.60	2.78	0.13	8.37	8.57	Pass
40	5200	1.73	0.85	3.01	2.20	0.13	8.17	8.57	Pass
48	5240	1.68	1.82	2.94	2.21	0.13	8.34	8.57	Pass

Note:

1. Method 1 of power density measurement of KDB 662911 is using for calculating total power density. Total power density is summing entire spectra across corresponding frequency bins on the various outputs by computer.
2. For U-NII-1: Directional gain = $8.41\text{dBi} + 10\log(4) = 14.43\text{dBi} > 6\text{dBi}$, so the power density limit shall be reduced to $17 - (14.43 - 6) = 8.57\text{dBm}$.
3. Refer to section 3.3 for duty cycle spectrum plot.

802.11ac (VHT20)

Chan.	Freq. (MHz)	PSD (dBm/MHz)				Total PSD (dBm/MHz)	Maximum Limit (dBm/MHz)	Pass / Fail
		Chain 0	Chain 1	Chain 2	Chain 3			
36	5180	1.52	1.30	2.17	2.22	7.84	8.57	Pass
40	5200	1.74	1.49	2.32	2.35	8.01	8.57	Pass
48	5240	1.91	1.07	2.39	2.75	8.10	8.57	Pass

Note:

1. Method 1 of power density measurement of KDB 662911 is using for calculating total power density. Total power density is summing entire spectra across corresponding frequency bins on the various outputs by computer.
2. For U-NII-1: Directional gain = $8.41\text{dBi} + 10\log(4) = 14.43\text{dBi} > 6\text{dBi}$, so the power density limit shall be reduced to $17 - (14.43 - 6) = 8.57\text{dBm}$.

802.11ac (VHT40)

Chan.	Freq. (MHz)	PSD (dBm/MHz)				Duty Factor	Total PSD With Duty Factor (dBm/MHz)	Maximum Limit (dBm/MHz)	Pass / Fail
		Chain 0	Chain 1	Chain 2	Chain 3				
38	5190	-0.32	-0.59	0.26	0.33	0.12	6.08	8.57	Pass
46	5230	1.54	1.03	1.72	2.06	0.12	7.75	8.57	Pass

Note:

1. Method 1 of power density measurement of KDB 662911 is using for calculating total power density. Total power density is summing entire spectra across corresponding frequency bins on the various outputs by computer.
2. For U-NII-1: Directional gain = $8.41\text{dBi} + 10\log(4) = 14.43\text{dBi} > 6\text{dBi}$, so the power density limit shall be reduced to $17 - (14.43 - 6) = 8.57\text{dBm}$.
3. Refer to section 3.3 for duty cycle spectrum plot.

802.11ac (VHT80)

Chan.	Freq. (MHz)	PSD (dBm/MHz)				Duty Factor	Total PSD With Duty Factor (dBm/MHz)	Maximum Limit (dBm/MHz)	Pass / Fail
		Chain 0	Chain 1	Chain 2	Chain 3				
42	5210	-10.51	-11.14	-8.76	-9.72	0.24	-3.66	8.57	Pass

Note:

1. Method 1 of power density measurement of KDB 662911 is using for calculating total power density. Total power density is summing entire spectra across corresponding frequency bins on the various outputs by computer.
2. For U-NII-1: Directional gain = $8.41\text{dBi} + 10\log(4) = 14.43\text{dBi} > 6\text{dBi}$, so the power density limit shall be reduced to $17 - (14.43 - 6) = 8.57\text{dBm}$.
3. Refer to section 3.3 for duty cycle spectrum plot.

SPECTRUM PLOT OF WORST VALUE

802.11a / Chain 2 / CH 40

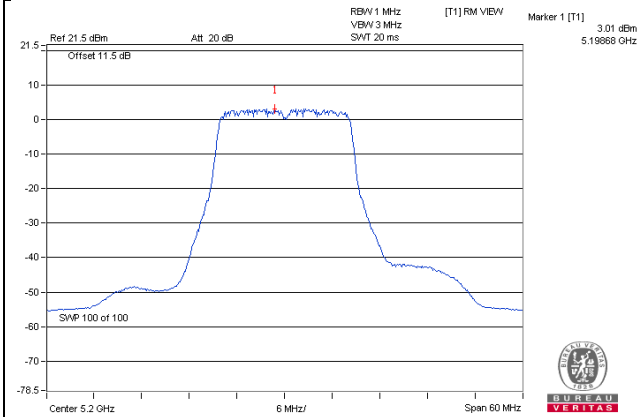

802.11ac (VHT20) / Chain 3 / CH 48

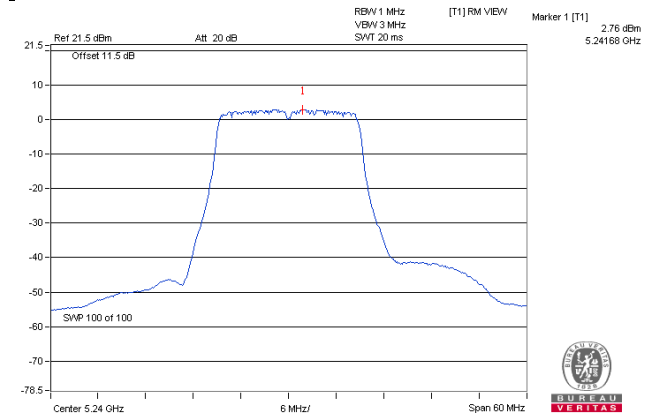

802.11acn (VHT40) / Chain 3 / CH 46

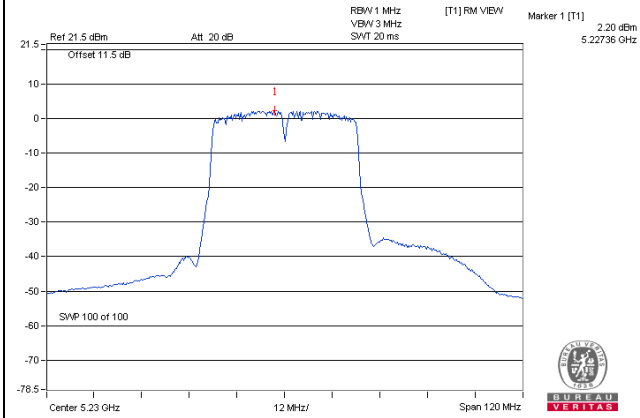

802.11ac (VHT80) / Chain 2 / CH 42

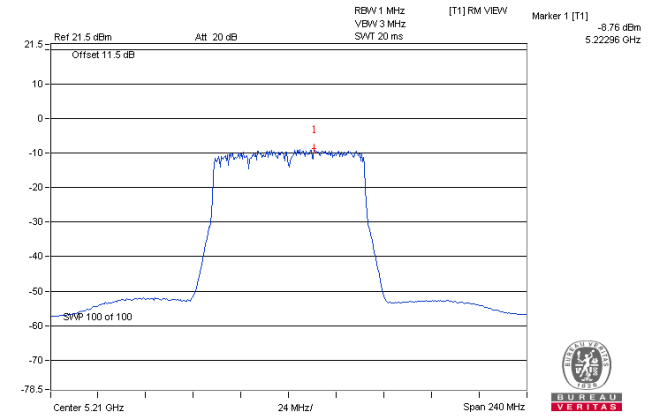

For U-NII-3 Band

802.11a

TX chain	Chan.	Chan. Freq. (MHz)	PSD W/O Duty Factor		10 log (N=4) dB	Duty Factor (dB)	Total PSD With Duty Factor (dBm/500kHz)	Limit (dBm/500kHz)	Pass /Fail
			(dBm/300kHz)	(dBm/500kHz)					
0	149	5745	-0.25	1.97	6.02	0.13	8.12	21.57	Pass
	157	5785	-0.56	1.66	6.02	0.13	7.81	21.57	Pass
	165	5825	-0.93	1.29	6.02	0.13	7.44	21.57	Pass
1	149	5745	-1.17	1.05	6.02	0.13	7.20	21.57	Pass
	157	5785	-0.89	1.33	6.02	0.13	7.48	21.57	Pass
	165	5825	-0.55	1.67	6.02	0.13	7.82	21.57	Pass
2	149	5745	-0.62	1.60	6.02	0.13	7.75	21.57	Pass
	157	5785	-0.44	1.78	6.02	0.13	7.93	21.57	Pass
	165	5825	-0.29	1.93	6.02	0.13	8.08	21.57	Pass
3	149	5745	0.20	2.42	6.02	0.13	8.57	21.57	Pass
	157	5785	-0.04	2.18	6.02	0.13	8.33	21.57	Pass
	165	5825	-0.03	2.19	6.02	0.13	8.34	21.57	Pass

Note:

1. Method 1 of power density measurement of KDB 662911 is using for calculating total power density. Total power density is summing entire spectra across corresponding frequency bins on the various outputs by computer.
2. For U-NII-3: Directional gain = $8.41\text{dBi} + 10\log(4) = 14.43\text{dBi} > 6\text{dBi}$, so the power density limit shall be reduced to $30 - (14.43 - 6) = 21.57\text{dBm}$.
3. Refer to section 3.3 for duty cycle spectrum plot.

802.11ac (VHT20)

TX chain	Chan.	Chan. Freq. (MHz)	PSD W/O Duty Factor		10 log (N=4) dB	Total PSD (dBm/500kHz)	Limit (dBm/500kHz)	Pass /Fail
			(dBm/300kHz)	(dBm/500kHz)				
0	149	5745	-0.72	1.50	6.02	7.52	21.57	Pass
	157	5785	-1.21	1.01	6.02	7.03	21.57	Pass
	165	5825	-1.11	1.11	6.02	7.13	21.57	Pass
1	149	5745	-1.43	0.79	6.02	6.81	21.57	Pass
	157	5785	-1.37	0.85	6.02	6.87	21.57	Pass
	165	5825	-1.43	0.79	6.02	6.81	21.57	Pass
2	149	5745	-1.13	1.09	6.02	7.11	21.57	Pass
	157	5785	-0.68	1.54	6.02	7.56	21.57	Pass
	165	5825	-0.51	1.71	6.02	7.73	21.57	Pass
3	149	5745	-0.18	2.04	6.02	8.06	21.57	Pass
	157	5785	-0.34	1.88	6.02	7.90	21.57	Pass
	165	5825	-0.42	1.80	6.02	7.82	21.57	Pass

Note:

- Method 1 of power density measurement of KDB 662911 is using for calculating total power density. Total power density is summing entire spectra across corresponding frequency bins on the various outputs by computer.
- For U-NII-3: Directional gain = $8.41\text{dBi} + 10\log(4) = 14.43\text{dBi} > 6\text{dBi}$, so the power density limit shall be reduced to $30 - (14.43 - 6) = 21.57\text{dBm}$.

802.11ac (VHT40)

TX chain	Chan.	Chan. Freq. (MHz)	PSD W/O Duty Factor		10 log (N=4) dB	Duty Factor (dB)	Total PSD With Duty Factor (dBm/500kHz)	Limit (dBm/500kHz)	Pass /Fail
			(dBm/300kHz)	(dBm/500kHz)					
0	151	5755	-4.11	-1.89	6.02	0.12	4.25	21.57	Pass
	159	5795	-4.77	-2.55	6.02	0.12	3.59	21.57	Pass
1	151	5755	-4.75	-2.53	6.02	0.12	3.61	21.57	Pass
	159	5795	-4.66	-2.44	6.02	0.12	3.70	21.57	Pass
2	151	5755	-4.85	-2.63	6.02	0.12	3.51	21.57	Pass
	159	5795	-4.66	-2.44	6.02	0.12	3.70	21.57	Pass
3	151	5755	-3.55	-1.33	6.02	0.12	4.81	21.57	Pass
	159	5795	-3.22	-1.00	6.02	0.12	5.14	21.57	Pass

Note:

1. Method 1 of power density measurement of KDB 662911 is using for calculating total power density. Total power density is summing entire spectra across corresponding frequency bins on the various outputs by computer.
2. For U-NII-3: Directional gain =8.41dBi + 10log(4)=14.43dBi > 6dBi, so the power density limit shall be reduced to 30-(14.43-6) = 21.57dBm.
3. Refer to section 3.3 for duty cycle spectrum plot.

802.11ac (VHT80)

TX chain	Chan.	Chan. Freq. (MHz)	PSD W/O Duty Factor		10 log (N=4) dB	Duty Factor (dB)	Total PSD With Duty Factor (dBm/500kHz)	Limit (dBm/500kHz)	Pass /Fail
			(dBm/300kHz)	(dBm/500kHz)					
0	155	5775	-10.73	-8.51	6.02	0.26	-2.23	21.57	Pass
1	155	5775	-10.92	-8.70	6.02	0.26	-2.42	21.57	Pass
2	155	5775	-11.39	-9.17	6.02	0.26	-2.89	21.57	Pass
3	155	5775	-10.33	-8.11	6.02	0.26	-1.83	21.57	Pass

Note:

1. Method 1 of power density measurement of KDB 662911 is using for calculating total power density. Total power density is summing entire spectra across corresponding frequency bins on the various outputs by computer.
2. For U-NII-3: Directional gain =8.41dBi + 10log(4)=14.43dBi > 6dBi, so the power density limit shall be reduced to 30-(14.43-6) = 21.57dBm.
3. Refer to section 3.3 for duty cycle spectrum plot.

SPECTRUM PLOT OF WORST VALUE

802.11a / Chain 3 / CH 149

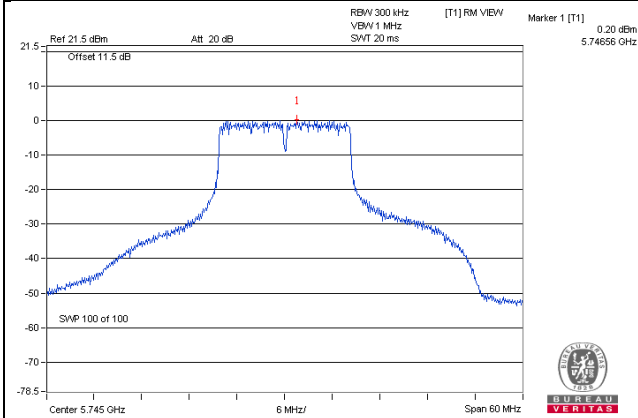

802.11ac (VHT20) / Chain 3 / CH 149

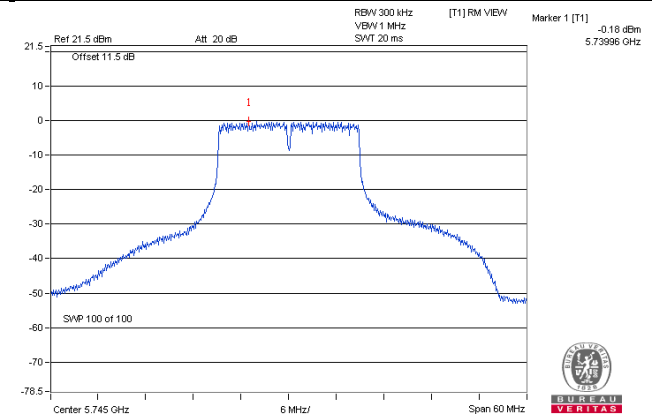

802.11ac (VHT40) / Chain 3 / CH 159

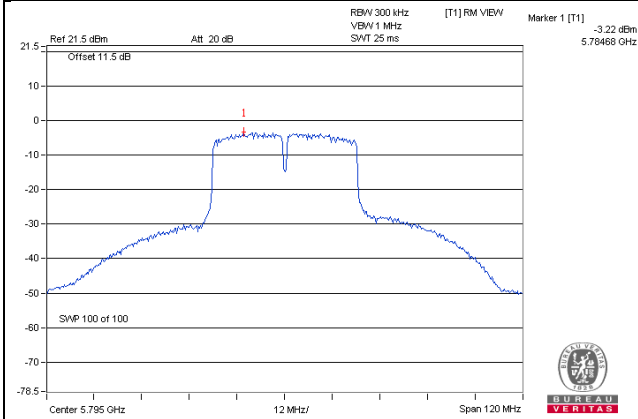

802.11ac (VHT80) / Chain 3 / CH 155

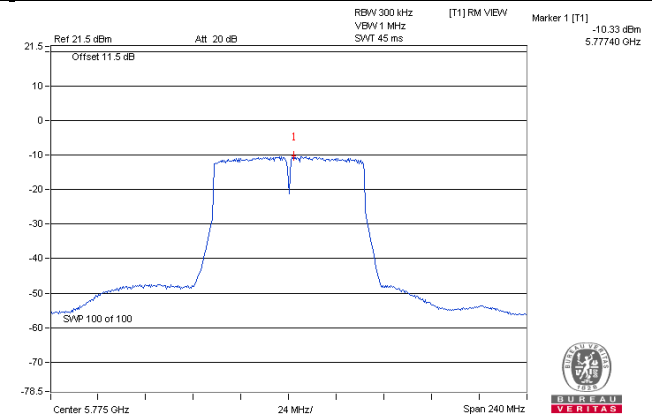

4.6 Frequency Stability

4.6.1 Limits of Frequency Stability Measurement

The frequency of the carrier signal shall be maintained within band of operation

4.6.2 Test Setup

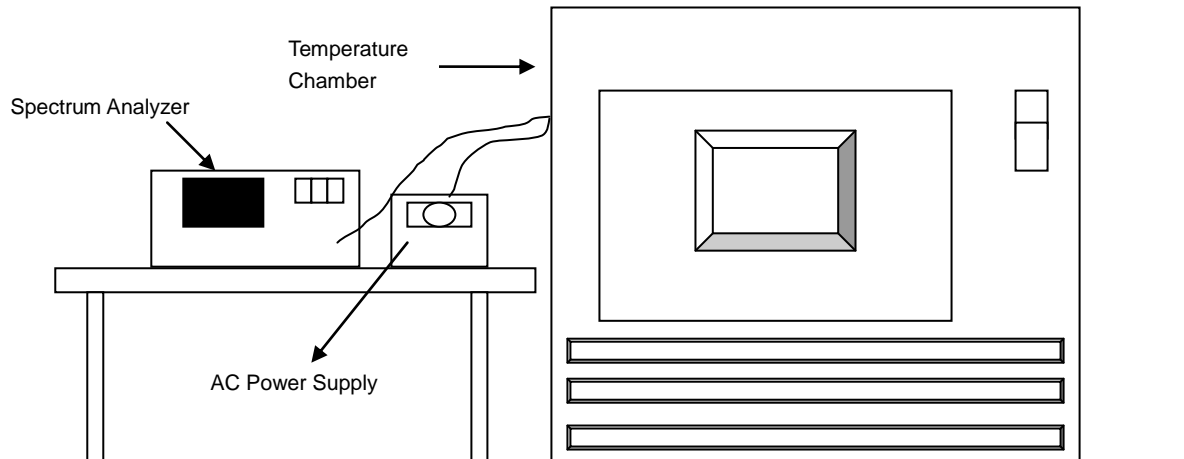

4.6.3 Test Instruments

Refer to section 4.1.2 to get information of above instrument.

4.6.4 Test Procedure

- The EUT was placed inside the environmental test chamber and powered by nominal AC voltage.
- Turn the EUT on and couple its output to a spectrum analyzer.
- Turn the EUT off and set the chamber to the highest temperature specified.
- Allow sufficient time (approximately 30 min) for the temperature of the chamber to stabilize, turn the EUT on and measure the operating frequency after 2, 5, and 10 minutes.
- Repeat step 2 and 3 with the temperature chamber set to the lowest temperature.
- The test chamber was allowed to stabilize at +20 degree C for a minimum of 30 minutes. The supply voltage was then adjusted on the EUT from 85% to 115% and the frequency record.

4.6.5 Deviation from Test Standard

No deviation.

4.6.6 EUT Operating Condition

Set the EUT transmit at un-modulation mode to test frequency stability.

4.6.7 Test Results

Frequency Stability Versus Temp.									
Operating Frequency: 5180 MHz									
TEMP. (°C)	Power Supply (Vac)	0 Minute		2 Minute		5 Minute		10 Minute	
		Measured Frequency (MHz)	Pass/Fail	Measured Frequency (MHz)	Pass/Fail	Measured Frequency (MHz)	Pass/Fail	Measured Frequency (MHz)	Pass/Fail
50	120	5179.9853	PASS	5179.9857	PASS	5179.986	PASS	5179.9842	PASS
40	120	5180.0088	PASS	5180.0124	PASS	5180.0116	PASS	5180.0088	PASS
30	120	5180.0229	PASS	5180.0255	PASS	5180.024	PASS	5180.0263	PASS
20	120	5179.9889	PASS	5179.992	PASS	5179.9912	PASS	5179.9912	PASS
10	120	5180.0197	PASS	5180.0186	PASS	5180.0209	PASS	5180.0202	PASS
0	120	5179.9893	PASS	5179.9869	PASS	5179.9859	PASS	5179.9878	PASS
-10	120	5179.9865	PASS	5179.9866	PASS	5179.9897	PASS	5179.9873	PASS
-20	120	5179.9986	PASS	5179.9959	PASS	5179.9952	PASS	5179.9946	PASS
-30	120	5180.0039	PASS	5180.0014	PASS	5180.0025	PASS	5180.0058	PASS

Frequency Stability Versus Voltage									
Operating Frequency: 5180 MHz									
TEMP. (°C)	Power Supply (Vac)	0 Minute		2 Minute		5 Minute		10 Minute	
		Measured Frequency (MHz)	Pass/Fail	Measured Frequency (MHz)	Pass/Fail	Measured Frequency (MHz)	Pass/Fail	Measured Frequency (MHz)	Pass/Fail
20	138	5179.9882	PASS	5179.9913	PASS	5179.9906	PASS	5179.992	PASS
	120	5179.9889	PASS	5179.992	PASS	5179.9912	PASS	5179.9912	PASS
	102	5179.9884	PASS	5179.9925	PASS	5179.9912	PASS	5179.9912	PASS

4.7 6dB Bandwidth Measurement

4.7.1 Limits of 6dB Bandwidth Measurement

The minimum of 6dB Bandwidth Measurement is 0.5MHz.

4.7.2 Test Setup

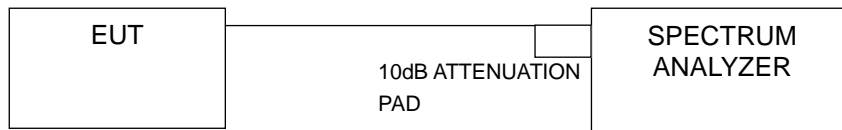

4.7.3 Test Instruments

Refer to section 4.1.2 to get information of above instrument.

4.7.4 Test Procedure

- a. Set resolution bandwidth (RBW) = 100kHz
- b. Set the video bandwidth (VBW) $\geq 3 \times$ RBW, Detector = Peak.
- c. Trace mode = max hold.
- d. Sweep = auto couple.
- e. Measure the maximum width of the emission that is constrained by the frequencies associated with the two amplitude points (upper and lower) that are attenuated by 6 dB relative to the maximum level measured in the fundamental emission

4.7.5 Deviation from Test Standard

No deviation.

4.7.6 EUT Operating Condition

The software provided by client to enable the EUT under transmission Condition continuously at lowest, middle and highest channel frequencies individually.

4.7.7 Test Results

802.11a

Channel	Frequency (MHz)	6dB Bandwidth (MHz)				Minimum Limit (MHz)	Pass / Fail
		Chain 0	Chain 1	Chain 2	Chain 3		
149	5745	16.37	16.38	16.37	16.38	0.5	Pass
157	5785	16.36	16.37	16.37	16.39	0.5	Pass
165	5825	16.38	16.38	16.38	16.37	0.5	Pass

802.11ac (VHT20)

Channel	Frequency (MHz)	6dB Bandwidth (MHz)				Minimum Limit (MHz)	Pass / Fail
		Chain 0	Chain 1	Chain 2	Chain 3		
149	5745	17.01	17.57	17.60	17.59	0.5	Pass
157	5785	17.31	17.59	17.57	17.60	0.5	Pass
165	5825	17.57	17.58	17.60	17.58	0.5	Pass

802.11ac (VHT40)

Channel	Frequency (MHz)	6dB Bandwidth (MHz)				Minimum Limit (MHz)	Pass / Fail
		Chain 0	Chain 1	Chain 2	Chain 3		
151	5755	35.18	35.19	35.25	35.17	0.5	Pass
159	5795	35.17	35.10	35.15	35.10	0.5	Pass

802.11ac (VHT80)

Channel	Frequency (MHz)	6dB Bandwidth (MHz)				Minimum Limit (MHz)	Pass / Fail
		Chain 0	Chain 1	Chain 2	Chain 3		
155	5775	75.42	75.52	75.46	75.43	0.5	Pass

SPECTRUM PLOT OF WORST VALUE

802.11a / Chain 0 / CH157

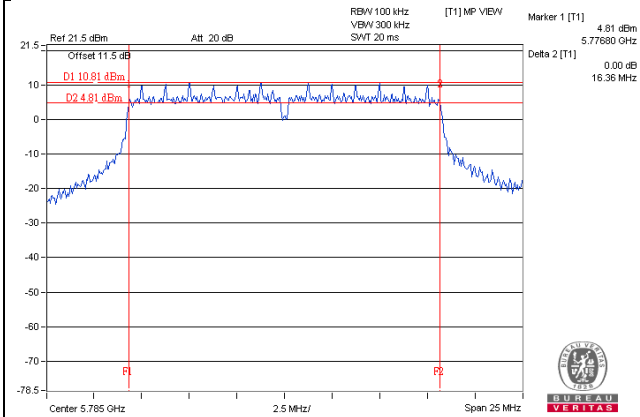

802.11ac (VHT20) / Chain 0 / CH149

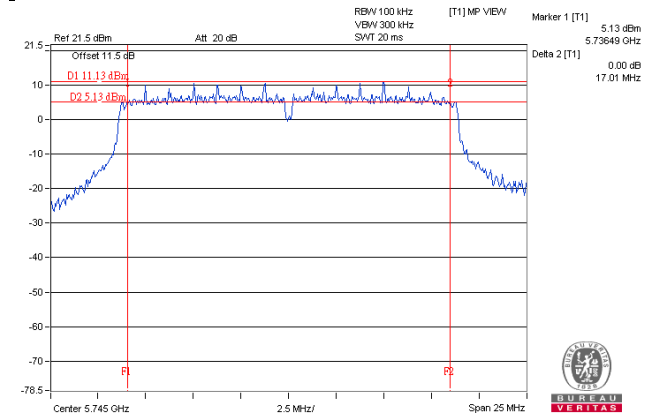

802.11ac (VHT40) / Chain 1 / CH159

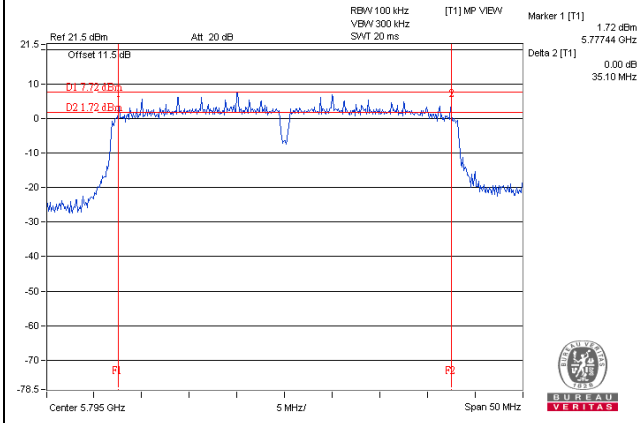

802.11ac (VHT80) / Chain 0 / CH155

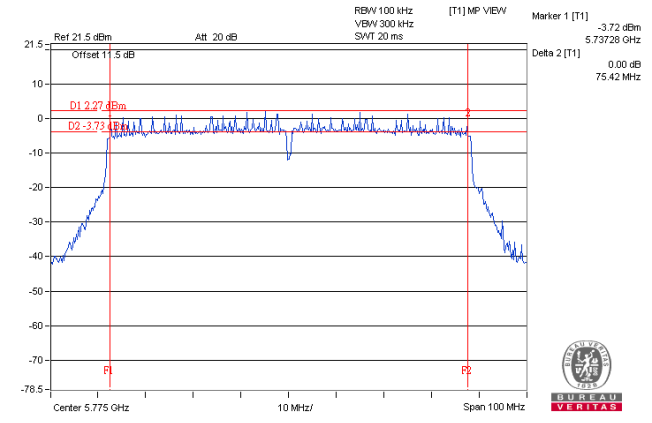

5 Pictures of Test Arrangements

Please refer to the attached file (Test Setup Photo).

Annex A- Radiated Out of Band Emission (OOBE) Measurement (For U-NII-3 band)

802.11a

CH 149 5745 MHz

Horizontal

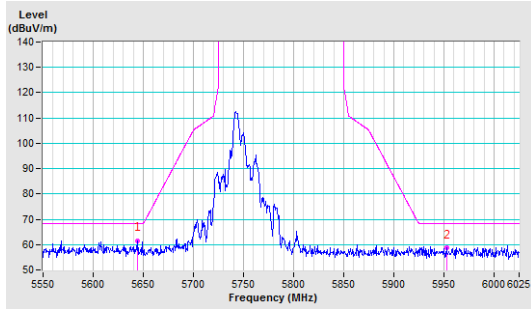

Vertical

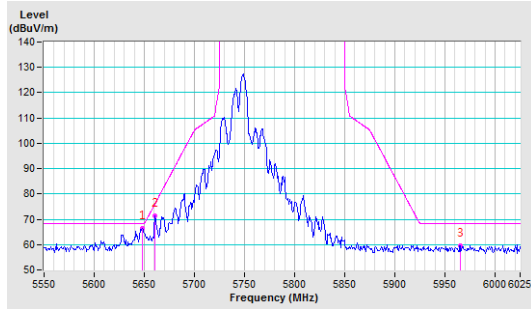

CH 157 5785 MHz

Horizontal

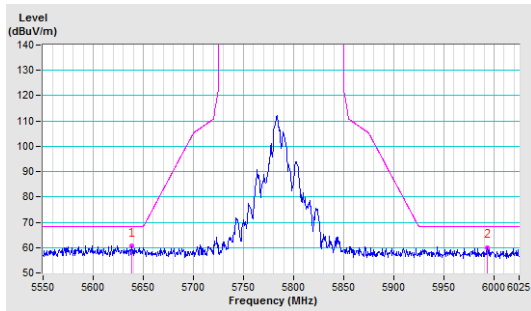

Vertical

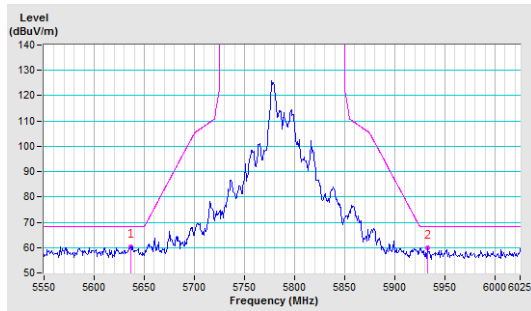

CH 165 5825 MHz

Horizontal

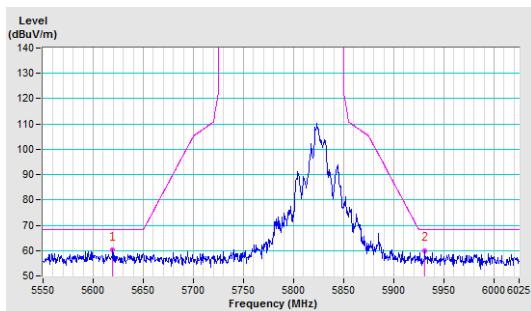

Vertical

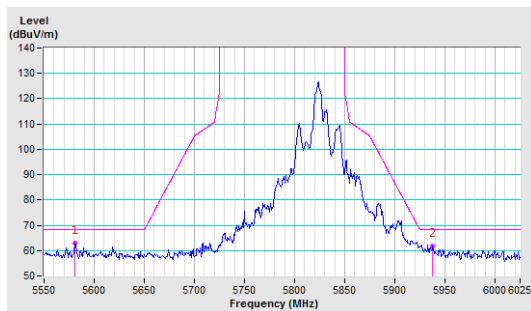

802.11ac (VHT20)

CH 149 5745 MHz

Horizontal

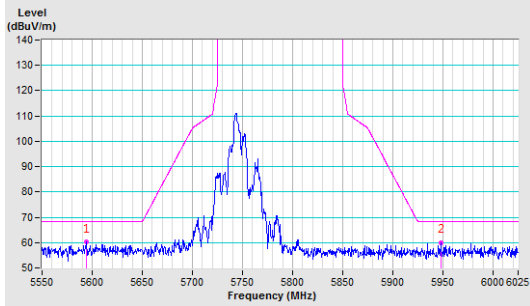

Vertical

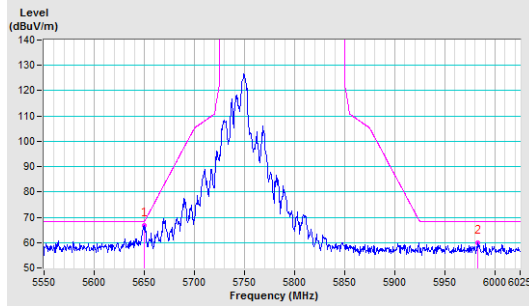

CH 157 5785 MHz

Horizontal

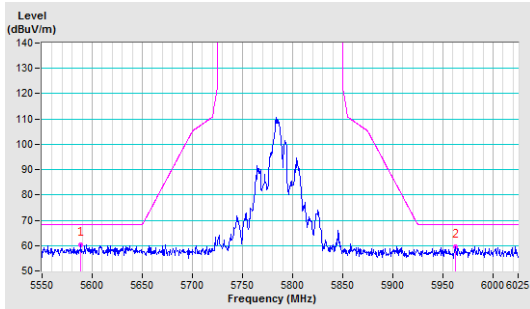

Vertical

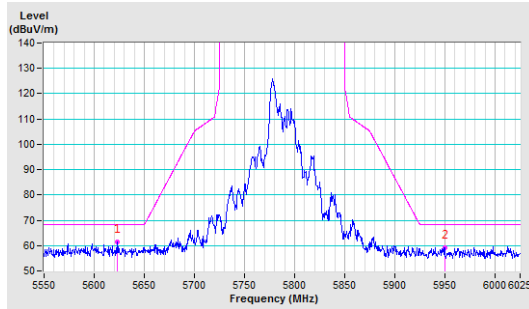

CH 165 5825 MHz

Horizontal

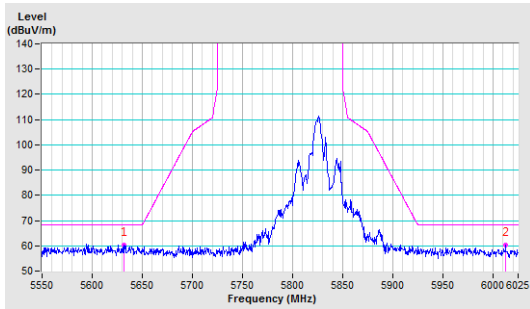

Vertical

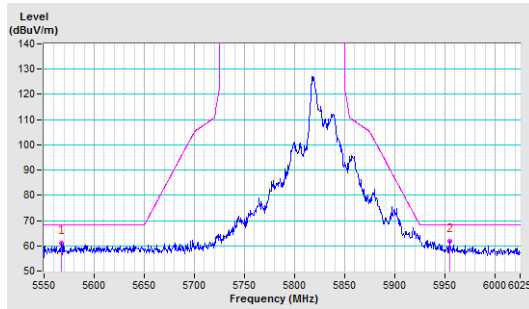

802.11ac (VHT40)

CH 151 5755 MHz

Horizontal

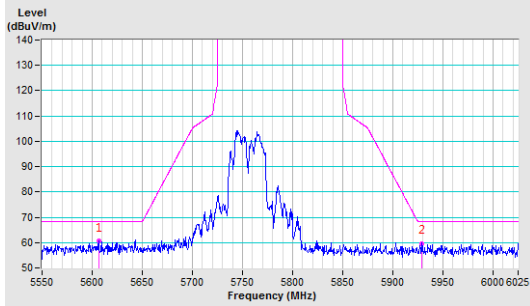

Vertical

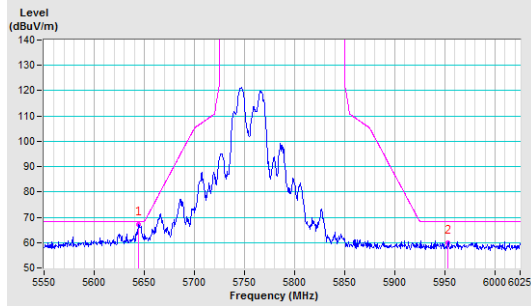

CH 159 5795 MHz

Horizontal

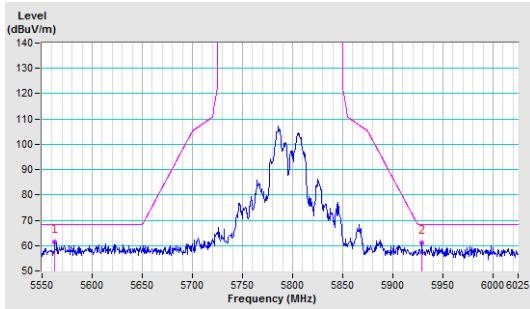

Vertical

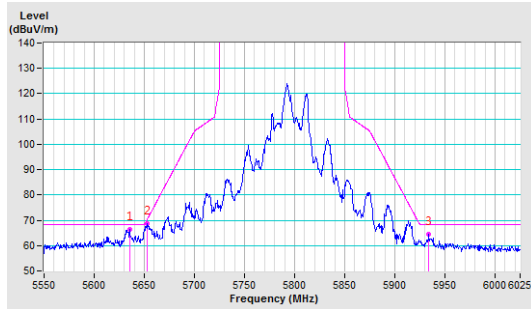

802.11ac (VHT80)

CH 155 5775 MHz

Horizontal

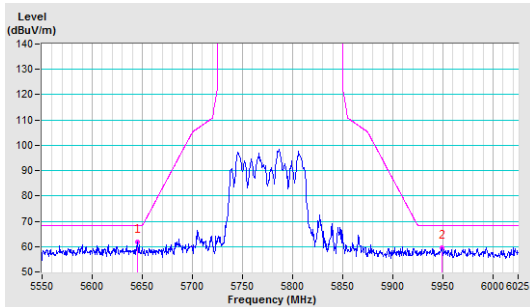

Vertical

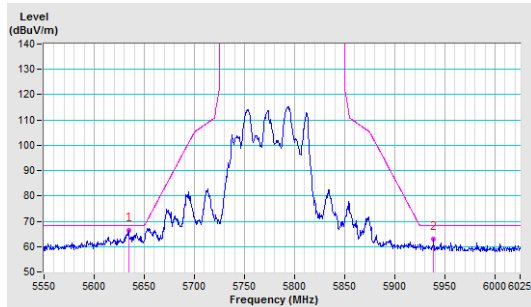

Appendix – Information on the Testing Laboratories

We, Bureau Veritas Consumer Products Services (H.K.) Ltd., Taoyuan Branch, were founded in 1988 to provide our best service in EMC, Radio, Telecom and Safety consultation. Our laboratories are FCC recognized accredited test firms and accredited and approved according to ISO/IEC 17025.

If you have any comments, please feel free to contact us at the following:

Linko EMC/RF Lab

Tel: 886-2-26052180

Fax: 886-2-26051924

Hsin Chu EMC/RF/Telecom Lab

Tel: 886-3-6668565

Fax: 886-3-6668323

Hwa Ya EMC/RF/Safety Lab

Tel: 886-3-3183232

Fax: 886-3-3270892

Email: service.adt@tw.bureauveritas.com

Web Site: www.bureauveritas-adt.com

The address and road map of all our labs can be found in our web site also.

--- END ---