

FCC Test Report

Report No.: RF170417C09

FCC ID: 2AKCZ-0C1

Model: APL42-0C1

Received Date: Apr. 17, 2017

Test Date: Apr. 28 ~ Jun. 06, 2017

Issued Date: Jun. 27, 2017

Applicant: SonicWall Inc.

Address: 5455 Great America Parkway, Santa Clara, CA 95054 USA

Issued By: Bureau Veritas Consumer Products Services (H.K.) Ltd., Taoyuan Branch

Lab Address: No. 47-2, 14th Ling, Chia Pau Vil., Lin Kou Dist., New Taipei City, Taiwan, R.O.C.

Test Location: No.19, Hwa Ya 2nd Rd., Wen Hwa Vil., Kwei Shan Dist., Taoyuan City 33383, TAIWAN (R.O.C.)



This report is for your exclusive use. Any copying or replication of this report to or for any other person or entity, or use of our name or trademark, is permitted only with our prior written permission. This report sets forth our findings solely with respect to the test samples identified herein. The results set forth in this report are not indicative or representative of the quality or characteristics of the lot from which a test sample was taken or any similar or identical product unless specifically and expressly noted. Our report includes all of the tests requested by you and the results thereof based upon the information that you provided to us. You have 60 days from date of issuance of this report to notify us of any material error or omission caused by our negligence, provided, however, that such notice shall be in writing and shall specifically address the issue you wish to raise. A failure to raise such issue within the prescribed time shall constitute your unqualified acceptance of the completeness of this report, the tests conducted and the correctness of the report contents. Unless specific mention, the uncertainty of measurement has been explicitly taken into account to declare the compliance or non-compliance to the specification. This report should not be used by the client to claim product certification, approval, or endorsement by TAF or any government agencies.

Table of Contents

Release Control Record	4
1 Certificate of Conformity	5
2 Summary of Test Results	6
2.1 Measurement Uncertainty.....	6
2.2 Modification Record.....	6
3 General Information	7
3.1 General Description of EUT.....	7
3.2 Description of Test Modes.....	9
3.2.1 Test Mode Applicability and Tested Channel Detail.....	10
3.3 Duty Cycle of Test Signal.....	12
3.4 Description of Support Units.....	17
3.4.1 Configuration of System under Test.....	17
3.5 General Description of Applied Standards.....	18
4 Test Types and Results	19
4.1 Radiated Emission and Bandedge Measurement.....	19
4.1.1 Limits of Radiated Emission and Bandedge Measurement.....	19
4.1.2 Test Instruments.....	20
4.1.3 Test Procedures.....	21
4.1.4 Deviation from Test Standard.....	21
4.1.5 Test Set Up.....	22
4.1.6 EUT Operating Conditions.....	23
4.1.7 Test Results.....	24
4.2 Conducted Emission Measurement.....	89
4.2.1 Limits of Conducted Emission Measurement.....	89
4.2.2 Test Instruments.....	89
4.2.3 Test Procedures.....	90
4.2.4 Deviation from Test Standard.....	90
4.2.5 Test Setup.....	90
4.2.6 EUT Operating Conditions.....	90
4.2.7 Test Results.....	91
4.3 6dB Bandwidth Measurement.....	101
4.3.1 Limits of 6dB Bandwidth Measurement.....	101
4.3.2 Test Setup.....	101
4.3.3 Test Instruments.....	101
4.3.4 Test Procedure.....	101
4.3.5 Deviation from Test Standard.....	101
4.3.6 EUT Operating Conditions.....	101
4.3.7 Test Result.....	102
4.4 Conducted Output Power Measurement.....	112
4.4.1 Limits of Conducted Output Power Measurement.....	112
4.4.2 Test Setup.....	112
4.4.3 Test Instruments.....	112
4.4.4 Test Procedures.....	112
4.4.5 Deviation from Test Standard.....	112
4.4.6 EUT Operating Conditions.....	112
4.4.7 Test Results.....	113
4.5 Power Spectral Density Measurement.....	122
4.5.1 Limits of Power Spectral Density Measurement.....	122
4.5.2 Test Setup.....	122
4.5.3 Test Instruments.....	122
4.5.4 Test Procedure.....	122
4.5.5 Deviation from Test Standard.....	123
4.5.6 EUT Operating Condition.....	123

4.5.7 Test Results	124
4.6 Conducted Out of Band Emission Measurement.....	146
4.6.1 Limits of Conducted Out of Band Emission Measurement	146
4.6.2 Test Setup.....	146
4.6.3 Test Instruments	146
4.6.4 Test Procedure	146
4.6.5 Deviation from Test Standard	146
4.6.6 EUT Operating Condition	147
4.6.7 Test Results	147
5 Pictures of Test Arrangements.....	216
Appendix – Information on the Testing Laboratories	217

Release Control Record

Issue No.	Description	Date Issued
RF170417C09	Original release	Jun. 27, 2017

1 Certificate of Conformity

Product: Wireless Access Point

Brand: SONICWALL

Model: APL42-0C1

Sample Status: Engineering sample

Applicant: SonicWall Inc.

Test Date: Apr. 28 ~ Jun. 06, 2017

Standards: 47 CFR FCC Part 15, Subpart C (Section 15.247)
ANSI C63.10:2013

The above equipment has been tested by **Bureau Veritas Consumer Products Services (H.K.) Ltd., Taoyuan Branch**, and found compliance with the requirement of the above standards. The test record, data evaluation & Equipment Under Test (EUT) configurations represented herein are true and accurate accounts of the measurements of the sample's EMC characteristics under the conditions specified in this report.

Prepared by :  , **Date:** Jun. 27, 2017
Pettie Chen / Senior Specialist

Approved by :  , **Date:** Jun. 27, 2017
Ken Liu / Senior Manager

2 Summary of Test Results

47 CFR FCC Part 15, Subpart C (Section 15.247)			
FCC Clause	Test Item	Result	Remarks
15.207	AC Power Conducted Emission	Pass	Meet the requirement of limit. Minimum passing margin is -6.16dB at 0.19418MHz
15.205 / 15.209 / 15.247(d)	Radiated Emissions and Band Edge Measurement	Pass	Meet the requirement of limit. Minimum passing margin is -1.0dB at 2390.00, 2483.50MHz.
15.247(d)	Antenna Port Emission	Pass	Meet the requirement of limit.
15.247(a)(2)	6dB bandwidth	Pass	Meet the requirement of limit.
15.247(b)	Conducted power	Pass	Meet the requirement of limit.
15.247(e)	Power Spectral Density	Pass	Meet the requirement of limit.
15.203	Antenna Requirement	Pass	For Dipole antenna: Antenna connector is N-TYPE not a standard connector. For Sector antenna: Antenna connector is N-jack not a standard connector. For Panel antenna: Antenna connector is N-jack not a standard connector. For PIFA antenna: Antenna connector is IPEX not a standard connector.

2.1 Measurement Uncertainty

Where relevant, the following measurement uncertainty levels have been estimated for tests performed on the EUT as specified in CISPR 16-4-2:

Measurement	Frequency	Expanded Uncertainty (k=2) (\pm)
Conducted Emissions at mains ports	150kHz ~ 30MHz	2.94 dB
Radiated Emissions up to 1 GHz	30MHz ~ 200MHz	3.86 dB
	200MHz ~ 1000MHz	3.87 dB
Radiated Emissions above 1 GHz	1GHz ~ 18GHz	2.29 dB
	18GHz ~ 40GHz	2.29 dB

2.2 Modification Record

There were no modifications required for compliance.

3 General Information

3.1 General Description of EUT

Product	Wireless Access Point
Brand	SONICWALL
Model	APL42-0C1
Sample Status	Engineering sample
Power Supply Rating	48-55Vdc (PoE)
Modulation Type	CCK, DQPSK, DBPSK for DSSS 64QAM, 16QAM, QPSK, BPSK for OFDM
Modulation Technology	DSSS, OFDM
Transfer Rate	802.11b: 11.0/ 5.5/ 2.0/ 1.0Mbps 802.11g: 54.0/ 48.0/ 36.0/ 24.0/ 18.0/ 12.0/ 9.0/ 6.0Mbps 802.11n: up to 600Mbps
Operating Frequency	2412 ~ 2462MHz
Number of Channel	11 for 802.11b, 802.11g, 802.11n (HT20) 7 for 802.11n (HT40)
Output Power	<p>Radio 1: Dipole antenna CDD Mode: 652.164mW Beamforming Mode: 130.764mW</p> <p>Radio 1: Sector antenna CDD Mode: 214.284mW Beamforming Mode: 53.578mW</p> <p>Radio 1: Panel antenna (Model: P254-07) CDD Mode: 519.563mW Beamforming Mode: 119.277mW</p> <p>Radio 1: Panel antenna (Model: P254-13) CDD Mode: 192.928mW Beamforming Mode: 48.238mW</p> <p>Radio 3: PIFA antenna: 129.420mW</p>
Antenna Type	Refer to note
Antenna Connector	Refer to note
Accessory Device	1.8m non-shielded ground cable without core
Data Cable Supplied	0.7m non-shielded antenna cable without core

Note:

- The EUT incorporates a MIMO function. Physically, the EUT provides 4 completed transmitters and 4 receivers.

2.4GHz Band			
Modulation Mode	TX Function	Beamforming	Remark
802.11b	4TX	Not Support	Radio 1
802.11g	4TX	Not Support	
802.11n (HT20)	4TX	Support	
802.11n (HT40)	4TX	Support	
802.11b	1TX	Not Support	Radio 3
802.11g	1TX	Not Support	
802.11n (HT20)	1TX	Not Support	
802.11n (HT40)	1TX	Not Support	

- The EUT consumes power from the following PoE (support unit only).

Adapter for PoE	
Brand	Powertron Electronics Corp.
Model	PA1040-480IB080
Input Power	100-240Vac~50-60Hz 1.5A
Output Power	48Vdc, 0.8A 38.4W Max
Power Line	1.55m non-shielded cable with one core

PoE (support unit only)	
Brand	EnGenius
Model	EPE-48GR
Output Power	48Vdc, 1.25A maximum

- The following antennas were provided to the EUT.

	Antenna Model	Freq. Range	Type	Con nector	Gain (dBi)										Remark	
					2400	2450	2500	5150	5250	5350	5500	5600	5725	5850		
1	D121-05	2.4G	Dipole	N-TYPE	4.1	4.2	4.5	-	-	-	-	-	-	-	-	Radio 1 (WLAN 2.4G:4TX)
2	D151-07	5G	Dipole	N-TYPE	-	-	-	6.3	6.3	5.4	5.0	5.1	5.2	5.1	Radio 2 (WLAN 5G:4TX)	
					Ant.1		Ant.2		Ant.3			Ant.4				
3	S124-12	2.4G	Sector	N-jack	12.60		12.00		12.30			12.10			Radio 1 (WLAN 2.4G:4TX)	
4	S154-15	5G	Sector	N-jack	14.10		14.60		13.81			13.23			Radio 2 (WLAN 5G:4TX)	
					2400-2500MHz					5150-5850MHz						
5	P254-07	2.4G/5G	Panel	N-jack	Ant. 5	Ant. 6	Ant. 7	Ant. 8	Ant. 1	Ant. 2	Ant. 3	Ant. 4	Radio 1 (WLAN 2.4G:4TX)/ Radio 2 (WLAN 5G:4TX)			
					7.33	8.62	7.58	7.83	10.03	10.16	10.23	10.16				
6	P254-13	2.4G/5G	Panel	N-jack	Ant. 1	Ant. 2	Ant. 3	Ant. 4	Ant. 5	Ant. 6	Ant. 7	Ant. 8				
					11.72	12.91	12.77	11.93	14.48	13.49	13.51	14.26				
7	P254-09	2.4G/5G	Panel	N-jack	Ant. 1	Ant. 2	Ant. 3	Ant. 4	Ant. 5	Ant. 6	Ant. 7	Ant. 8	Radio 1 (WLAN 2.4G:4TX)			
					8.9	9.4	9.4	8.9	10.4	9.7	9.7	10.4				
8	P124-10	2.4G	Panel	N-jack	9.7	9.6	9.6	9.7	-	-	-	-	Radio 1 (WLAN 2.4G:4TX)			
					5150 MHz	5250 MHz	5350 MHz	5450 MHz	5550 MHz	5650 MHz	5750 MHz	5850 MHz				
9	P154-12	5G	Panel	N-jack	12.51	12.58	12.78	12.53	12.50	12.69	11.91	11.48	Radio 2 (WLAN 5G:4TX)			
					2400-2500 MHz											
10	Scanning Antenna	2.4G	PIFA	IPEX	3.15										Radio 3 (WLAN 2.4G: 1TX)	
11	BLE Antenna	2.4G	PIFA	IPEX	3.37										Radio 4 (BTLE)	

*For Panel antenna: Item 5, 6 were chosen for the final tests.

*The power of item 7, 9 were following item 6.

4. WLAN 2.4GHz, 5GHz and BT LE technology can transmit at same time.
5. Spurious emission of the simultaneous operation (2.4GHz, 5GHz and BT LE) has been evaluated and no non-compliance was found.
6. The power setting are list as below:

Radio 1: Dipole antenna					
	802.11b	802.11g	802.11n (HT20)		802.11n (HT40)
CH01	22	19	19	CH03	15.5
CH06	23	23.5	23	CH06	17.5
CH11	21.5	19	18.5	CH09	12.5
Radio 1: Sector antenna					
	802.11b	802.11g	802.11n (HT20)		802.11n (HT40)
CH01	17.5	18	18	CH03	14.5
CH06	17.5	18.5	19	CH06	17
CH11	17	16.5	16	CH09	12.5
Radio 1: Panel antenna (Model: P254-07)					
	802.11b	802.11g	802.11n (HT20)		802.11n (HT40)
CH01	21	18.5	18.5	CH03	15
CH06	21	22.5	22.5	CH06	17.5
CH11	20	17	17	CH09	14
Radio 1: Panel antenna (Model: P254-13)					
	802.11b	802.11g	802.11n (HT20)		802.11n (HT40)
CH01	17	15.5	15	CH03	12
CH06	17	18	18.5	CH06	15
CH11	17	15.5	14.5	CH09	11
Radio 3: PIFA antenna					
	802.11b	802.11g	802.11n (HT20)		802.11n (HT40)
CH01	15	12	11	CH03	9.5
CH06	15	21	21	CH06	13.5
CH11	16	14	14	CH09	13

3.2 Description of Test Modes

11 channels are provided for 802.11b, 802.11g and 802.11n (HT20):

Channel	Frequency	Channel	Frequency
1	2412MHz	7	2442MHz
2	2417MHz	8	2447MHz
3	2422MHz	9	2452MHz
4	2427MHz	10	2457MHz
5	2432MHz	11	2462MHz
6	2437MHz		

7 channels are provided for 802.11n (HT40):

Channel	Frequency	Channel	Frequency
3	2422MHz	7	2442MHz
4	2427MHz	8	2447MHz
5	2432MHz	9	2452MHz
6	2437MHz		

3.2.1 Test Mode Applicability and Tested Channel Detail

EUT CONFIGURE MODE	APPLICABLE TO				DESCRIPTION
	RE \geq 1G	RE $<$ 1G	PLC	APCM	
A	√	√	√	√	EUT with Dipole antenna
B	√	√	√	√	EUT with Sector antenna
C	√	√	√	√	EUT with Panel antenna (Model: P254-07)
D	√	√	√	√	EUT with Panel antenna (Model: P254-13)
E	√	√	√	√	EUT with PIFA antenna

Where **RE \geq 1G**: Radiated Emission above 1GHz & Bandedge Measurement
RE $<$ 1G: Radiated Emission below 1GHz
PLC: Power Line Conducted Emission
APCM: Antenna Port Conducted Measurement

Note: The EUT had been pre-tested on the positioned of each 3 axis. The worst case was found when positioned on **Z-plane**.

Radiated Emission Test (Above 1GHz):

- Pre-Scan has been conducted to determine the worst-case mode from all possible combinations between available modulations, data rates and antenna ports (if EUT with antenna diversity architecture).
- Following channel(s) was (were) selected for the final test as listed below.

EUT CONFIGURE MODE	MODE	AVAILABLE CHANNEL	TESTED CHANNEL	MODULATION TECHNOLOGY	MODULATION TYPE	DATA RATE (Mbps)	REMARK
A, B, C, D	802.11b	1 to 11	1, 6, 11	DSSS	DBPSK	1.0	Radio 1 (WLAN 2.4G:4TX)
E		1 to 11	1, 6, 11	DSSS	DBPSK	1.0	Radio 3 (WLAN 2.4G: 1TX)
A, B, C, D	802.11g	1 to 11	1, 6, 11	OFDM	BPSK	6.0	Radio 1 (WLAN 2.4G:4TX)
E		1 to 11	1, 6, 11	OFDM	BPSK	6.0	Radio 3 (WLAN 2.4G: 1TX)
A, B, C, D	802.11n (HT20)	1 to 11	1, 6, 11	OFDM	BPSK	6.5	Radio 1 (WLAN 2.4G:4TX)
E		1 to 11	1, 6, 11	OFDM	BPSK	6.5	Radio 3 (WLAN 2.4G: 1TX)
A, B, C, D	802.11n (HT40)	3 to 9	3, 6, 9	OFDM	BPSK	13.5	Radio 1 (WLAN 2.4G:4TX)
E		3 to 9	3, 6, 9	OFDM	BPSK	13.5	Radio 3 (WLAN 2.4G: 1TX)

Radiated Emission Test (Below 1GHz):

- Pre-Scan has been conducted to determine the worst-case mode from all possible combinations between available modulations, data rates and antenna ports (if EUT with antenna diversity architecture).
- Following channel(s) was (were) selected for the final test as listed below.

EUT CONFIGURE MODE	MODE	AVAILABLE CHANNEL	TESTED CHANNEL	MODULATION TECHNOLOGY	MODULATION TYPE	DATA RATE (Mbps)	REMARK
A, B, C, D	802.11b	1 to 11	6	DSSS	DBPSK	1.0	Radio 1 (WLAN 2.4G:4TX)
E		1 to 11	6	DSSS	DBPSK	1.0	Radio 3 (WLAN 2.4G: 1TX)

Power Line Conducted Emission Test:

- Pre-Scan has been conducted to determine the worst-case mode from all possible combinations between available modulations, data rates and antenna ports (if EUT with antenna diversity architecture).
- Following channel(s) was (were) selected for the final test as listed below.

EUT CONFIGURE MODE	MODE	AVAILABLE CHANNEL	TESTED CHANNEL	MODULATION TECHNOLOGY	MODULATION TYPE	DATA RATE (Mbps)	REMARK
A, B, C, D	802.11b	1 to 11	6	DSSS	DBPSK	1.0	Radio 1 (WLAN 2.4G:4TX)
E		1 to 11	6	DSSS	DBPSK	1.0	Radio 3 (WLAN 2.4G: 1TX)

Antenna Port Conducted Measurement:

- This item includes all test value of each mode, but only includes spectrum plot of worst value of each mode.
- Pre-Scan has been conducted to determine the worst-case mode from all possible combinations between available modulations, data rates and antenna ports (if EUT with antenna diversity architecture).
- Following channel(s) was (were) selected for the final test as listed below.

EUT CONFIGURE MODE	MODE	AVAILABLE CHANNEL	TESTED CHANNEL	MODULATION TECHNOLOGY	MODULATION TYPE	DATA RATE (Mbps)	REMARK
A, B, C, D	802.11b	1 to 11	1, 6, 11	DSSS	DBPSK	1.0	Radio 1 (WLAN 2.4G:4TX)
E		1 to 11	1, 6, 11	DSSS	DBPSK	1.0	Radio 3 (WLAN 2.4G: 1TX)
A, B, C, D	802.11g	1 to 11	1, 6, 11	OFDM	BPSK	6.0	Radio 1 (WLAN 2.4G:4TX)
E		1 to 11	1, 6, 11	OFDM	BPSK	6.0	Radio 3 (WLAN 2.4G: 1TX)
A, B, C, D	802.11n (HT20)	1 to 11	1, 6, 11	OFDM	BPSK	6.5	Radio 1 (WLAN 2.4G:4TX)
E		1 to 11	1, 6, 11	OFDM	BPSK	6.5	Radio 3 (WLAN 2.4G: 1TX)
A, B, C, D	802.11n (HT40)	3 to 9	3, 6, 9	OFDM	BPSK	13.5	Radio 1 (WLAN 2.4G:4TX)
E		3 to 9	3, 6, 9	OFDM	BPSK	13.5	Radio 3 (WLAN 2.4G: 1TX)

Test Condition:

APPLICABLE TO	ENVIRONMENTAL CONDITIONS	INPUT POWER	TESTED BY
RE≥1G	25deg. C, 67%RH	120Vac, 60Hz	James Yang
RE<1G	26deg. C, 67%RH	120Vac, 60Hz	Jones Chang
PLC	25deg. C, 72%RH	120Vac, 60Hz	Jones Chang
APCM	25deg. C, 60%RH	120Vac, 60Hz	Leo Tsai

3.3 Duty Cycle of Test Signal

Duty cycle of test signal is > 98%, duty factor is not required.

Duty cycle of test signal is < 98%, duty factor shall be considered.

Test Mode A

802.11b: Duty cycle = $12.24/12.328 = 0.993$

802.11g: Duty cycle = $2.023/2.103 = 0.962$, Duty factor = $10 * \log(1/0.962) = 0.17$

802.11n (HT20): Duty cycle = $4.955/5.041 = 0.983$

802.11n (HT40): Duty cycle = $2.403/2.488 = 0.966$, Duty factor = $10 * \log(1/0.966) = 0.15$

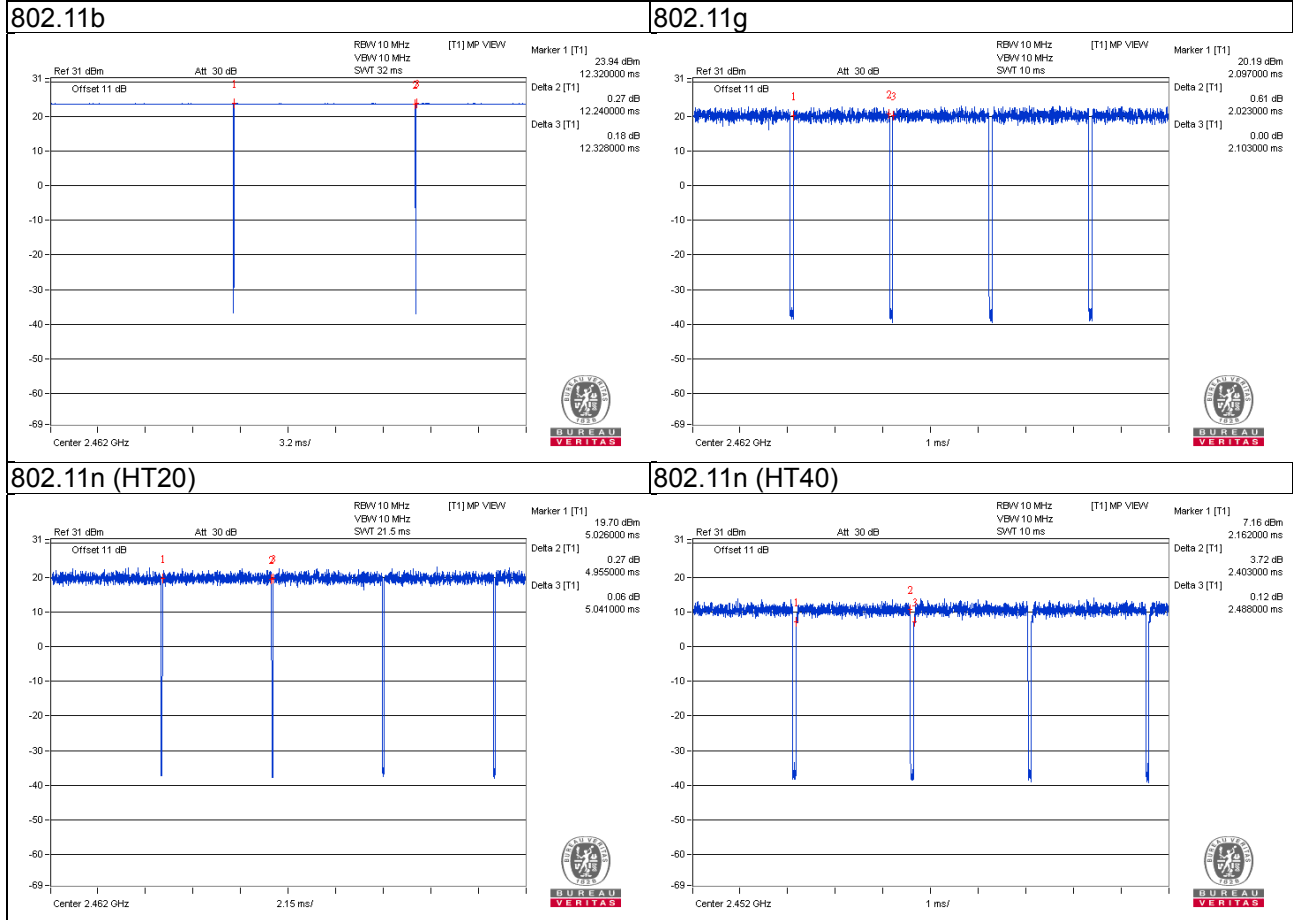

Test Mode B

802.11b: Duty cycle = $12.212/12.3 = 0.993$

802.11g: Duty cycle = $2.028/2.11 = 0.961$, Duty factor = $10 * \log(1/0.961) = 0.17$

802.11n (HT20): Duty cycle = $4.95/5.04 = 0.982$

802.11n (HT40): Duty cycle = $2.405/2.49 = 0.966$, Duty factor = $10 * \log(1/0.966) = 0.15$

802.11b

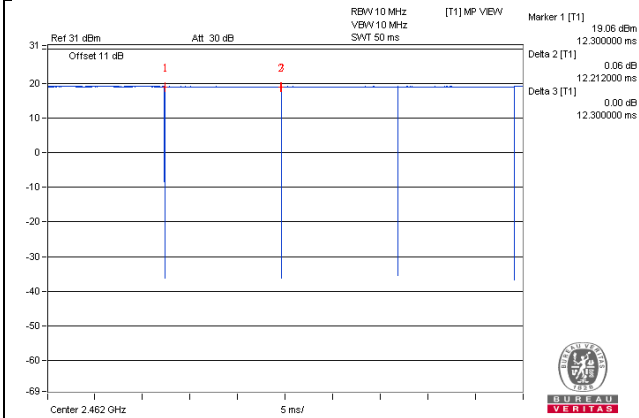

802.11g

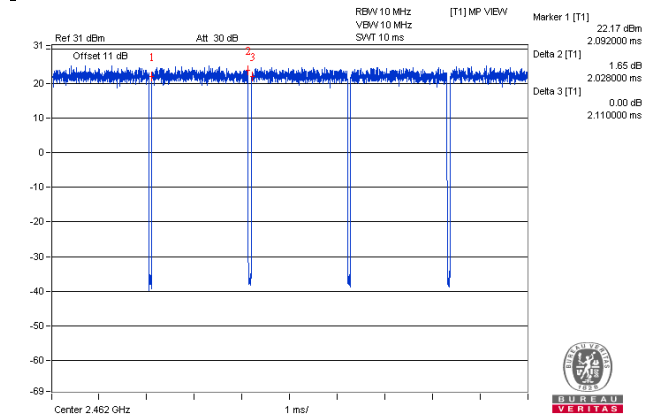

802.11n (HT20)

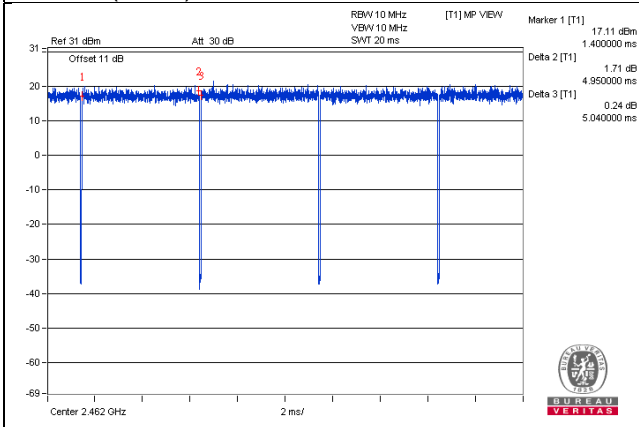

802.11n (HT40)

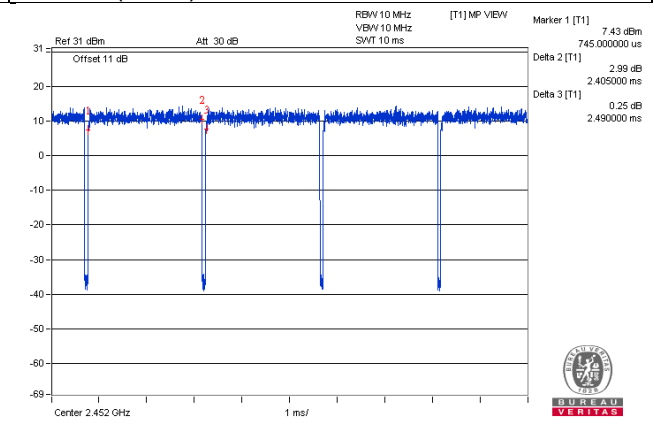

Test Mode C

802.11b: Duty cycle = $12.199/12.276 = 0.994$

802.11g: Duty cycle = $2.023/2.11 = 0.959$, Duty factor = $10 * \log(1/0.959) = 0.18$

802.11n (HT20): Duty cycle = $4.945/5.045 = 0.98$

802.11n (HT40): Duty cycle = $2.405/2.482 = 0.969$, Duty factor = $10 * \log(1/0.969) = 0.14$

802.11b

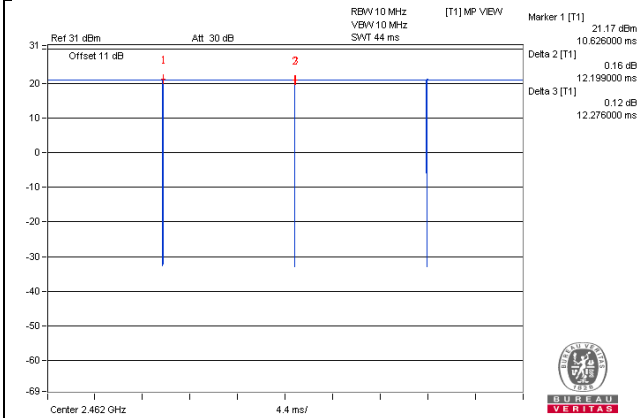

802.11g

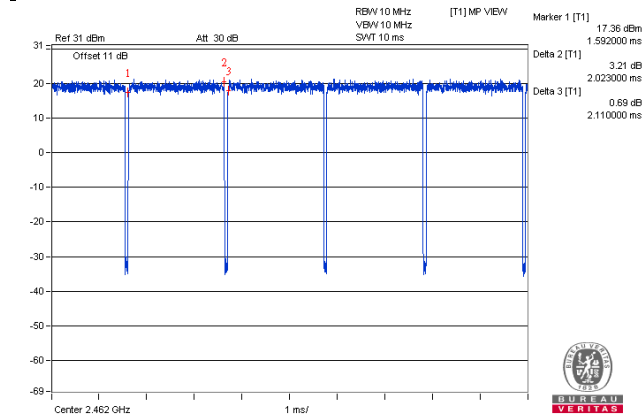

802.11n (HT20)

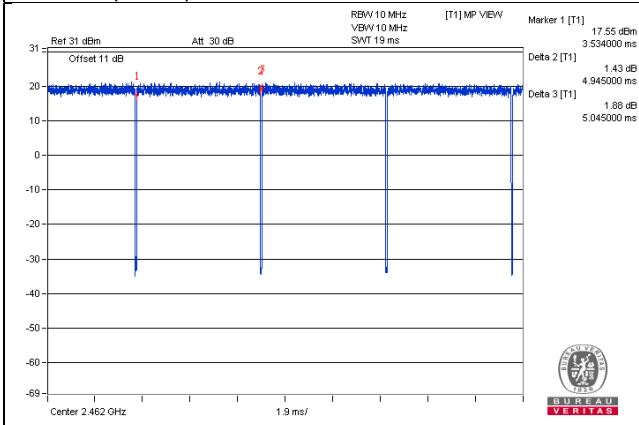

802.11n (HT40)

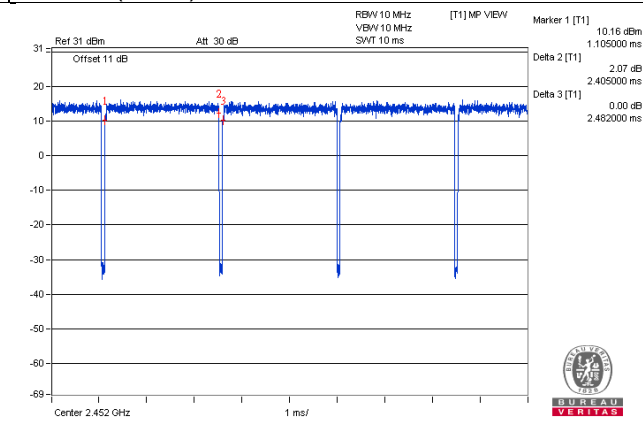

Test Mode D

802.11b: Duty cycle = $12.249/12.321 = 0.994$

802.11g: Duty cycle = $2.028/2.098 = 0.967$, Duty factor = $10 * \log(1/0.967) = 0.15$

802.11n (HT20): Duty cycle = $4.952/5.036 = 0.983$

802.11n (HT40): Duty cycle = $2.405/2.490 = 0.966$, Duty factor = $10 * \log(1/0.966) = 0.15$

802.11b

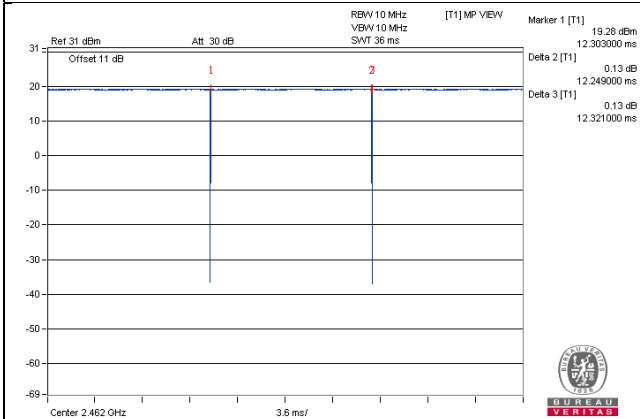

802.11g

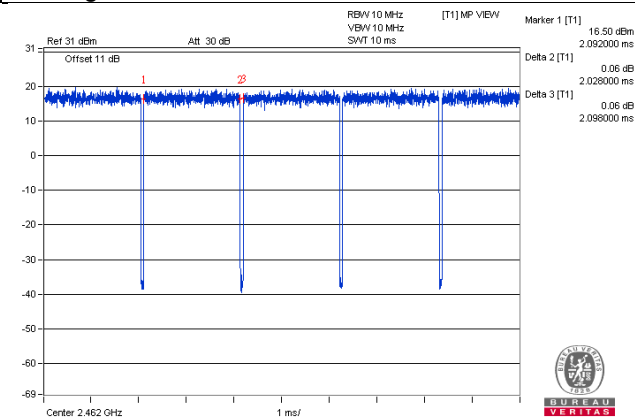

802.11n (HT20)

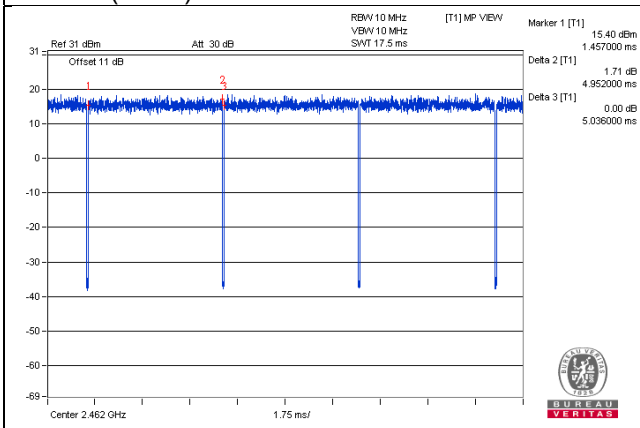

802.11n (HT40)

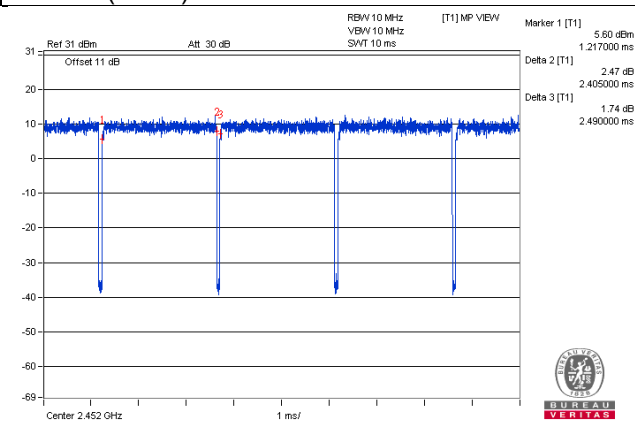

Test Mode E

802.11b: Duty cycle = $13.188/13.301 = 0.992$

802.11g: Duty cycle = $2.187/2.295 = 0.953$, Duty factor = $10 * \log(1/0.953) = 0.21$

802.11n (HT20): Duty cycle = $2.035/2.122 = 0.959$, Duty factor = $10 * \log(1/0.959) = 0.18$

802.11n (HT40): Duty cycle = $0.994/1.079 = 0.921$, Duty factor = $10 * \log(1/0.921) = 0.36$

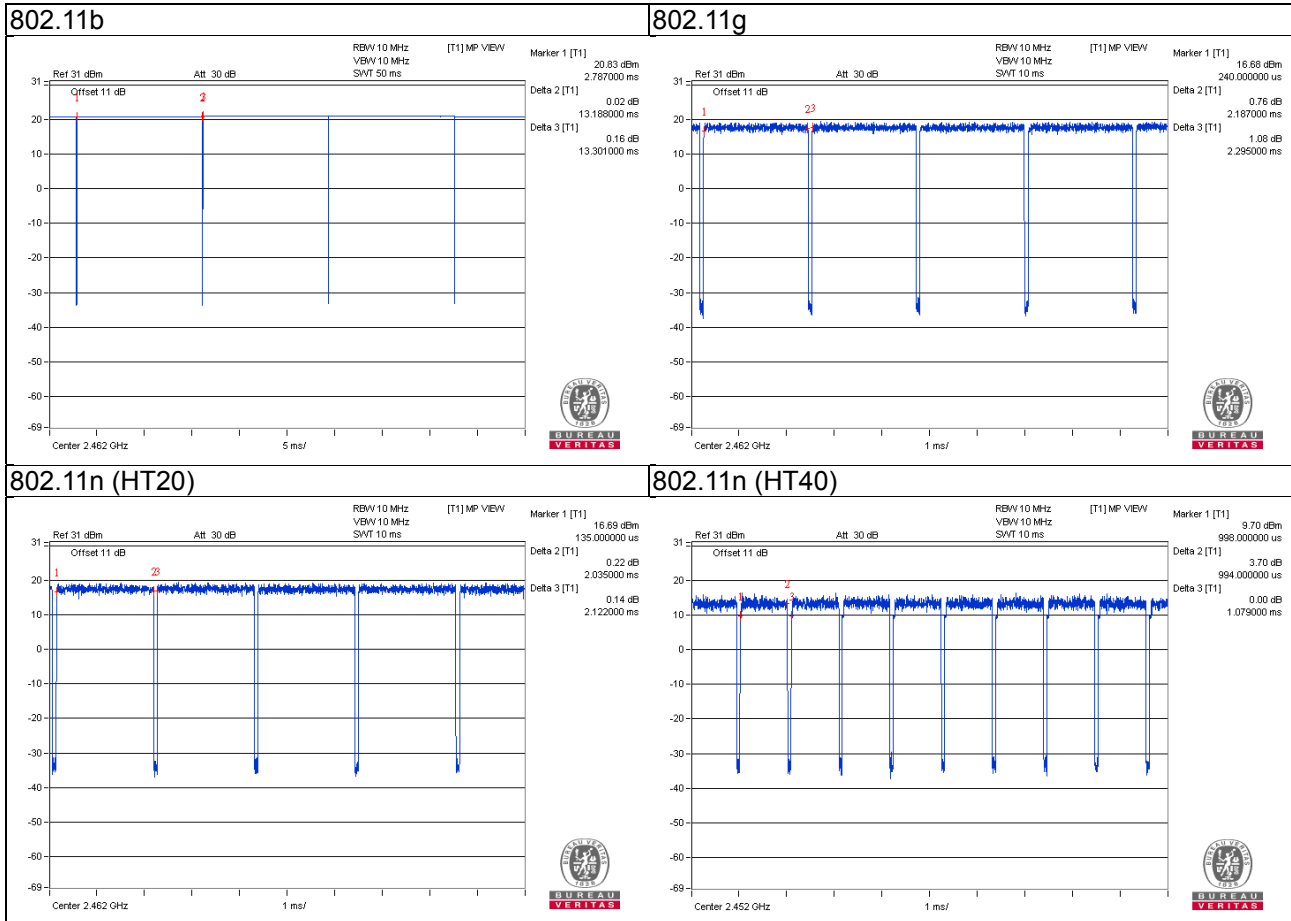

3.4 Description of Support Units

The EUT has been tested as an independent unit together with other necessary accessories or support units. The following support units or accessories were used to form a representative test configuration during the tests.

ID	Product	Brand	Model No.	Serial No.	FCC ID	Remarks
A.	Notebook	DELL	E5410	1HC2XM1	FCC DoC Approved	-
B.	Load	NA	NA	NA	NA	-
C.	PoE	EnGenius	EPE-48GR	NA	NA	Provided by manufacturer

Note:

1. All power cords of the above support units are non-shielded (1.8m).
2. Item A acted as communication partner to transfer data.

ID	Descriptions	Qty.	Length (m)	Shielding (Yes/No)	Cores (Qty.)	Remarks
1.	RJ45 cable	1	10	N	0	-
2.	RJ45 cable	1	3	N	0	-
3.	RJ45 cable	1	1.8	N	0	-
4.	Console cable	1	1.8	N	0	Accessory of EUT

3.4.1 Configuration of System under Test

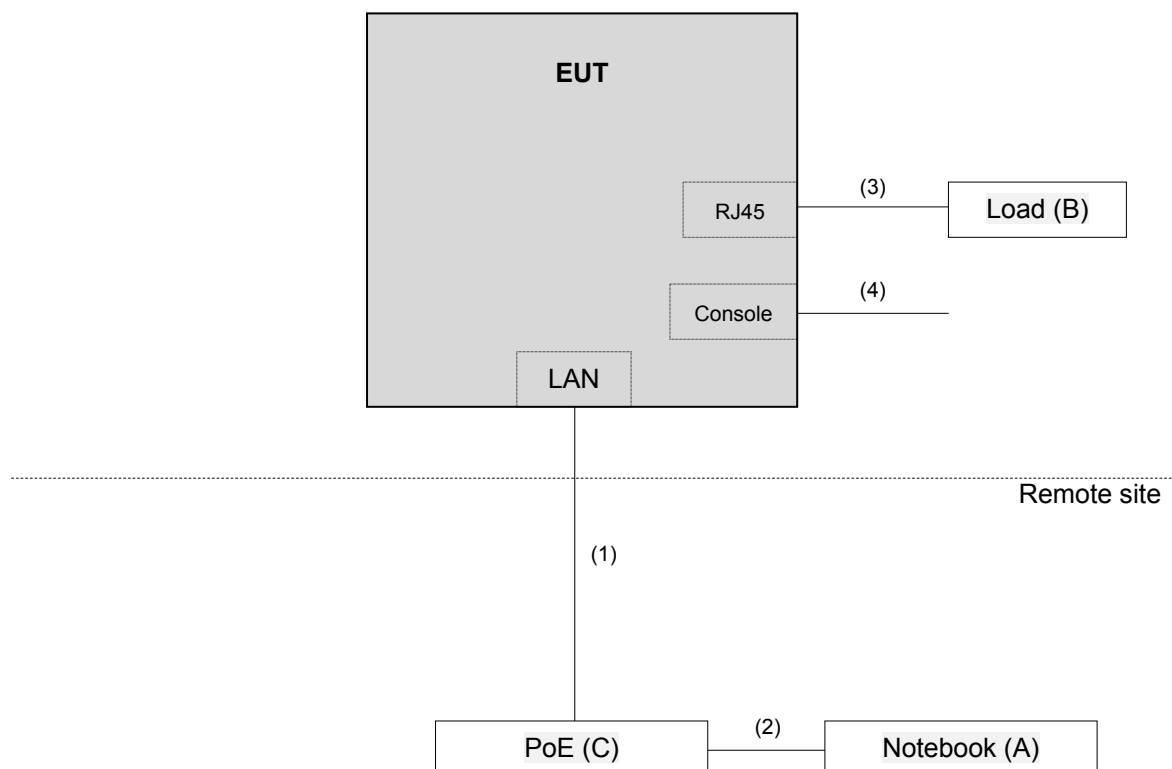

3.5 General Description of Applied Standards

The EUT is a RF Product. According to the specifications of the manufacturer, it must comply with the requirements of the following standards:

FCC Part 15, Subpart C (15.247)

KDB 558074 D01 DTS Meas Guidance v04

KDB 662911 D01 Multiple Transmitter Output v02r01

ANSI C63.10-2013

All test items have been performed and recorded as per the above standards.

Note: The EUT is also considered as a kind of computer peripheral, because the connection to computer is necessary for typical use. It has been verified to comply with the requirements of FCC Part 15, Subpart B, Class B (DoC). The test report has been issued separately.

4 Test Types and Results

4.1 Radiated Emission and Bandedge Measurement

4.1.1 Limits of Radiated Emission and Bandedge Measurement

Radiated emissions which fall in the restricted bands must comply with the radiated emission limits specified as below table. Other emissions shall be at least 30dB below the highest level of the desired power:

Frequencies (MHz)	Field Strength (microvolts/meter)	Measurement Distance (meters)
0.009 ~ 0.490	2400/F(kHz)	300
0.490 ~ 1.705	24000/F(kHz)	30
1.705 ~ 30.0	30	30
30 ~ 88	100	3
88 ~ 216	150	3
216 ~ 960	200	3
Above 960	500	3

Note:

1. The lower limit shall apply at the transition frequencies.
2. Emission level (dBuV/m) = 20 log Emission level (uV/m).
3. For frequencies above 1000MHz, the field strength limits are based on average detector, however, the peak field strength of any emission shall not exceed the maximum permitted average limits, specified above by more than 30dB under any condition of modulation.

4.1.2 Test Instruments

Description & Manufacturer	Model No.	Serial No.	Cal. Date	Cal. Due
Test Receiver ROHDE & SCHWARZ	ESCI	100424	Oct. 24, 2016	Oct. 23, 2017
Spectrum Analyzer ROHDE & SCHWARZ	FSP40	100041	Nov. 16, 2016	Nov. 15, 2017
BILOG Antenna SCHWARZBECK	VULB9168	9168-171	Dec. 28, 2016	Dec. 27, 2017
HORN Antenna SCHWARZBECK	9120D	209	Dec. 27, 2016	Dec. 26, 2017
HORN Antenna SCHWARZBECK	BBHA 9170	BBHA9170241	Dec. 14, 2016	Dec. 13, 2017
Loop Antenna	EM-6879	269	Aug. 11, 2016	Aug. 10, 2017
Preamplifier Agilent	8447D	2944A10738	Aug. 22, 2016	Aug. 21, 2017
Preamplifier Agilent	8449B	3008A01922	Sep. 18, 2016	Sep. 17, 2017
RF signal cable HUBER+SUHNER	SUCOFLEX 104	Cable-CH3-03 (214378)	Aug. 22, 2016	Aug. 21, 2017
RF signal cable HUBER+SUHNER	SUCOFLEX 106	Cable-CH3-03 (309224+12738)	Aug. 22, 2016	Aug. 21, 2017
Software BV ADT	ADT_Radiated_ V7.6.15.9.4	NA	NA	NA
Antenna Tower inn-co GmbH	MA 4000	013303	NA	NA
Antenna Tower Controller BV ADT	AT100	AT93021702	NA	NA
Turn Table BV ADT	TT100	TT93021702	NA	NA
Turn Table Controller BV ADT	SC100	SC93021702	NA	NA
High Speed Peak Power Meter	ML2495A	0824012	Aug. 11, 2016	Aug. 10, 2017
Power Sensor	MA2411B	0738171	Aug. 11, 2016	Aug. 10, 2017

- Note:
1. The calibration interval of the above test instruments is 12 months and the calibrations are traceable to NML/ROC and NIST/USA.
 2. The test was performed in HwaYa Chamber 3.
 3. The FCC Designation Number is TW0003. The number will be varied with the Lab location and scope as attached.
 4. The horn antenna and preamplifier (model: 8449B) are used only for the measurement of emission frequency above 1GHz if tested.
 5. The FCC Site Registration No. is 988962.
 6. The IC Site Registration No. is IC 7450F-3.

4.1.3 Test Procedures

For Radiated emission below 30MHz

- a. The EUT was placed on the top of a rotating table 0.8 meters above the ground at a 3 meter chamber room. The table was rotated 360 degrees to determine the position of the highest radiation.
- b. The EUT was set 3 meters away from the interference-receiving antenna, which was mounted on the top of a variable-height antenna tower.
- c. Both X and Y axes of the antenna are set to make the measurement.
- d. For each suspected emission, the EUT was arranged to its worst case and the rotatable table was turned from 0 degrees to 360 degrees to find the maximum reading.
- e. The test-receiver system was set to Quasi-Peak Detect Function and Specified Bandwidth with Maximum Hold Mode.

NOTE:

1. The resolution bandwidth and video bandwidth of test receiver/spectrum analyzer is 9kHz at frequency below 30MHz.

For Radiated emission above 30MHz

- a. The EUT was placed on the top of a rotating table 0.8 meters (for 30MHz ~ 1GHz) / 1.5 meters (for above 1GHz) above the ground at 3 meter chamber room for test. The table was rotated 360 degrees to determine the position of the highest radiation.
- b. The EUT was set 3 meters away from the interference-receiving antenna, which was mounted on the top of a variable-height antenna tower.
- c. The height of antenna is varied from one meter to four meters above the ground to determine the maximum value of the field strength. Both horizontal and vertical polarizations of the antenna are set to make the measurement.
- d. For each suspected emission, the EUT was arranged to its worst case and then the antenna was tuned to heights from 1 meter to 4 meters and the rotatable table was turned from 0 degrees to 360 degrees to find the maximum reading.
- e. The test-receiver system was set to quasi-peak detect function and specified bandwidth with maximum hold mode when the test frequency is below 1 GHz.
- f. The test-receiver system was set to peak and average detect function and specified bandwidth with maximum hold mode when the test frequency is above 1 GHz. If the peak reading value also meets average limit, measurement with the average detector is unnecessary.

Note:

1. The resolution bandwidth and video bandwidth of test receiver/spectrum analyzer is 120kHz for Quasi-peak detection (QP) at frequency below 1GHz.
2. The resolution bandwidth of test receiver/spectrum analyzer is 1 MHz and the video bandwidth is 3 MHz for Peak detection (PK) at frequency above 1GHz.
3. The resolution bandwidth of test receiver/spectrum analyzer is 1 MHz and the video bandwidth is $\geq 1/T$ (Duty cycle < 98%) or 3 x RBW (Duty cycle $\geq 98\%$) for Average detection (AV) at frequency above 1GHz.
4. All modes of operation were investigated and the worst-case emissions are reported.

4.1.4 Deviation from Test Standard

No deviation.

4.1.5 Test Set Up

For Radiated emission below 30MHz

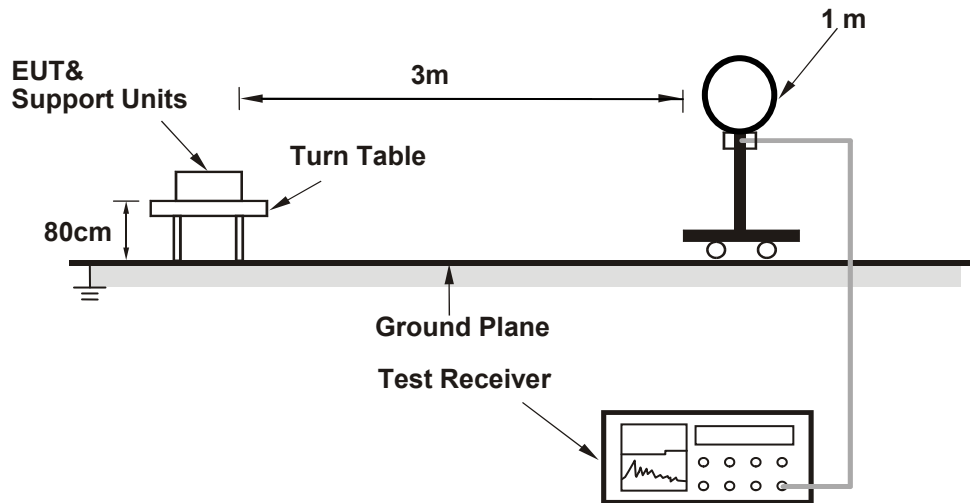

For Radiated emission 30MHz to 1GHz

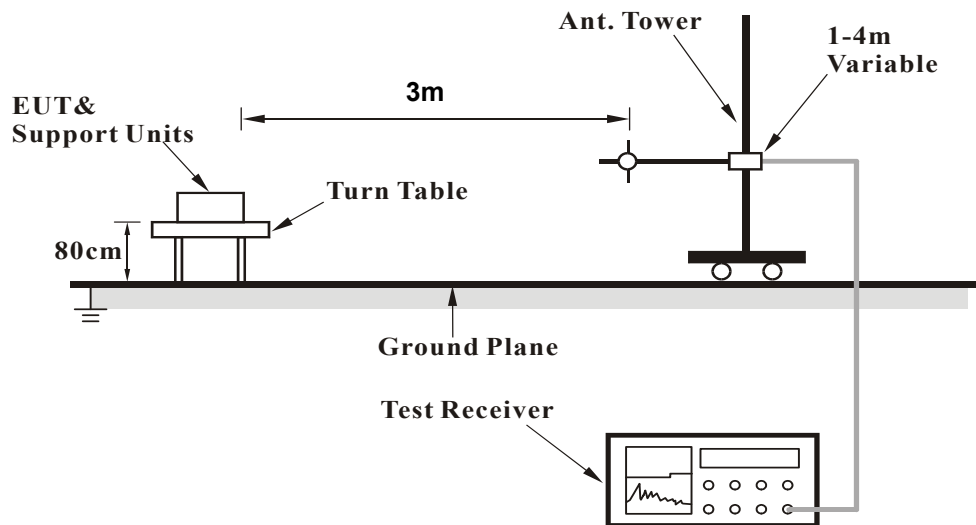

For Radiated emission above 1GHz

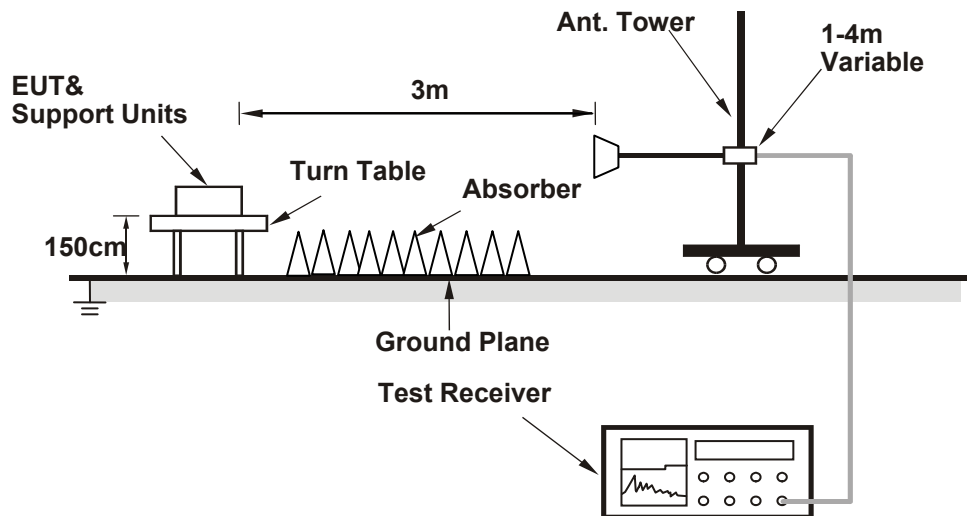

For the actual test configuration, please refer to the attached file (Test Setup Photo).

4.1.6 EUT Operating Conditions

- Placed the EUT on the testing table.
- Prepared a notebook to act as a communication partner and placed it outside of testing area.
- The communication partner connected with EUT via a RJ45 cable and ran a test program (QRCT) to enable EUT under transmission condition continuously at specific channel frequency.
- The communication partner sent data to EUT by command "PING".

4.1.7 Test Results

Test Mode A

Above 1GHz worst-Case data:

802.11b

CHANNEL	TX Channel 1	DETECTOR FUNCTION	Peak (PK)
FREQUENCY RANGE	1GHz ~ 25GHz		Average (AV)

ANTENNA POLARITY & TEST DISTANCE: HORIZONTAL AT 3 M								
NO.	FREQ. (MHz)	EMISSION LEVEL (dBuV/m)	LIMIT (dBuV/m)	MARGIN (dB)	ANTENNA HEIGHT (m)	TABLE ANGLE (Degree)	RAW VALUE (dBuV)	CORRECTION FACTOR (dB/m)
1	2390.00	54.8 PK	74.0	-19.2	1.77 H	116	23.8	31.0
2	2390.00	43.0 AV	54.0	-11.0	1.77 H	116	12.0	31.0
3	*2412.00	98.5 PK			1.79 H	120	67.3	31.2
4	*2412.00	95.5 AV			1.79 H	120	64.3	31.2
5	4824.00	52.8 PK	74.0	-21.2	1.75 H	47	52.3	0.5
6	4824.00	49.8 AV	54.0	-4.2	1.75 H	47	49.3	0.5

ANTENNA POLARITY & TEST DISTANCE: VERTICAL AT 3 M								
NO.	FREQ. (MHz)	EMISSION LEVEL (dBuV/m)	LIMIT (dBuV/m)	MARGIN (dB)	ANTENNA HEIGHT (m)	TABLE ANGLE (Degree)	RAW VALUE (dBuV)	CORRECTION FACTOR (dB/m)
1	2390.00	59.3 PK	74.0	-14.7	1.74 V	155	28.3	31.0
2	2390.00	52.4 AV	54.0	-1.6	1.74 V	155	21.4	31.0
3	*2412.00	116.6 PK			1.79 V	178	85.4	31.2
4	*2412.00	114.5 AV			1.79 V	178	83.3	31.2
5	4824.00	53.0 PK	74.0	-21.0	2.64 V	308	52.5	0.5
6	4824.00	49.8 AV	54.0	-4.2	2.64 V	308	49.3	0.5

REMARKS:

1. Emission Level(dBuV/m) = Raw Value(dBuV) + Correction Factor(dB/m)
2. Correction Factor(dB/m) = Antenna Factor(dB/m) + Cable Factor(dB)
3. The other emission levels were very low against the limit.
4. Margin value = Emission Level – Limit value
5. " * ": Fundamental frequency.

CHANNEL	TX Channel 6	DETECTOR FUNCTION	Peak (PK)
FREQUENCY RANGE	1GHz ~ 25GHz		Average (AV)

ANTENNA POLARITY & TEST DISTANCE: HORIZONTAL AT 3 M

NO.	FREQ. (MHz)	EMISSION LEVEL (dBuV/m)	LIMIT (dBuV/m)	MARGIN (dB)	ANTENNA HEIGHT (m)	TABLE ANGLE (Degree)	RAW VALUE (dBuV)	CORRECTION FACTOR (dB/m)
1	*2437.00	100.5 PK			1.19 H	196	69.2	31.3
2	*2437.00	96.6 AV			1.19 H	196	65.3	31.3
3	4874.00	51.7 PK	74.0	-22.3	1.85 H	52	51.1	0.6
4	4874.00	48.0 AV	54.0	-6.0	1.85 H	52	47.4	0.6

ANTENNA POLARITY & TEST DISTANCE: VERTICAL AT 3 M

NO.	FREQ. (MHz)	EMISSION LEVEL (dBuV/m)	LIMIT (dBuV/m)	MARGIN (dB)	ANTENNA HEIGHT (m)	TABLE ANGLE (Degree)	RAW VALUE (dBuV)	CORRECTION FACTOR (dB/m)
1	*2437.00	118.1 PK			1.13 V	340	86.8	31.3
2	*2437.00	114.1 AV			1.13 V	340	82.8	31.3
3	4874.00	50.8 PK	74.0	-23.2	2.70 V	303	50.2	0.6
4	4874.00	46.3 AV	54.0	-7.7	2.70 V	303	45.7	0.6

REMARKS:

1. Emission Level(dBuV/m) = Raw Value(dBuV) + Correction Factor(dB/m)
2. Correction Factor(dB/m) = Antenna Factor(dB/m) + Cable Factor(dB)
3. The other emission levels were very low against the limit.
4. Margin value = Emission Level – Limit value
5. " * ": Fundamental frequency.

CHANNEL	TX Channel 11	DETECTOR FUNCTION	Peak (PK)
FREQUENCY RANGE	1GHz ~ 25GHz		Average (AV)

ANTENNA POLARITY & TEST DISTANCE: HORIZONTAL AT 3 M

NO.	FREQ. (MHz)	EMISSION LEVEL (dBuV/m)	LIMIT (dBuV/m)	MARGIN (dB)	ANTENNA HEIGHT (m)	TABLE ANGLE (Degree)	RAW VALUE (dBuV)	CORRECTION FACTOR (dB/m)
1	*2462.00	98.8 PK			1.05 H	195	67.4	31.4
2	*2462.00	95.1 AV			1.05 H	195	63.7	31.4
3	2483.50	55.3 PK	74.0	-18.7	1.08 H	196	23.8	31.5
4	2483.50	43.4 AV	54.0	-10.6	1.08 H	196	11.9	31.5
5	4924.00	52.6 PK	74.0	-21.4	1.96 H	54	52.0	0.6
6	4924.00	48.0 AV	54.0	-6.0	1.96 H	54	47.4	0.6

ANTENNA POLARITY & TEST DISTANCE: VERTICAL AT 3 M

NO.	FREQ. (MHz)	EMISSION LEVEL (dBuV/m)	LIMIT (dBuV/m)	MARGIN (dB)	ANTENNA HEIGHT (m)	TABLE ANGLE (Degree)	RAW VALUE (dBuV)	CORRECTION FACTOR (dB/m)
1	*2462.00	116.9 PK			1.25 V	338	85.5	31.4
2	*2462.00	113.2 AV			1.25 V	338	81.8	31.4
3	2483.50	62.8 PK	74.0	-11.2	1.17 V	5	31.3	31.5
4	2483.50	52.8 AV	54.0	-1.2	1.17 V	5	21.3	31.5
5	4924.00	49.2 PK	74.0	-24.8	1.31 V	0	48.6	0.6
6	4924.00	42.7 AV	54.0	-11.3	1.31 V	0	42.1	0.6

REMARKS:

1. Emission Level(dBuV/m) = Raw Value(dBuV) + Correction Factor(dB/m)
2. Correction Factor(dB/m) = Antenna Factor(dB/m) + Cable Factor(dB)
3. The other emission levels were very low against the limit.
4. Margin value = Emission Level – Limit value
5. " * " : Fundamental frequency.

802.11g

CHANNEL	TX Channel 1	DETECTOR FUNCTION	Peak (PK)
FREQUENCY RANGE	1GHz ~ 25GHz		Average (AV)

ANTENNA POLARITY & TEST DISTANCE: HORIZONTAL AT 3 M								
NO.	FREQ. (MHz)	EMISSION LEVEL (dBuV/m)	LIMIT (dBuV/m)	MARGIN (dB)	ANTENNA HEIGHT (m)	TABLE ANGLE (Degree)	RAW VALUE (dBuV)	CORRECTION FACTOR (dB/m)
1	2390.00	54.9 PK	74.0	-19.1	1.34 H	196	23.9	31.0
2	2390.00	43.1 AV	54.0	-10.9	1.34 H	196	12.1	31.0
3	*2412.00	98.3 PK			1.14 H	109	67.1	31.2
4	*2412.00	87.8 AV			1.14 H	109	56.6	31.2
5	4824.00	49.4 PK	74.0	-24.6	2.03 H	53	48.9	0.5
6	4824.00	35.5 AV	54.0	-18.5	2.03 H	53	35.0	0.5
ANTENNA POLARITY & TEST DISTANCE: VERTICAL AT 3 M								
NO.	FREQ. (MHz)	EMISSION LEVEL (dBuV/m)	LIMIT (dBuV/m)	MARGIN (dB)	ANTENNA HEIGHT (m)	TABLE ANGLE (Degree)	RAW VALUE (dBuV)	CORRECTION FACTOR (dB/m)
1	2390.00	66.2 PK	74.0	-7.8	1.64 V	323	35.2	31.0
2	2390.00	52.5 AV	54.0	-1.5	1.64 V	323	21.5	31.0
3	*2412.00	116.4 PK			1.87 V	174	85.2	31.2
4	*2412.00	105.8 AV			1.87 V	174	74.6	31.2
5	4824.00	47.7 PK	74.0	-26.3	2.64 V	310	47.2	0.5
6	4824.00	34.4 AV	54.0	-19.6	2.64 V	310	33.9	0.5

REMARKS:

1. Emission Level(dBuV/m) = Raw Value(dBuV) + Correction Factor(dB/m)
2. Correction Factor(dB/m) = Antenna Factor(dB/m) + Cable Factor(dB)
3. The other emission levels were very low against the limit.
4. Margin value = Emission Level – Limit value
5. " * " : Fundamental frequency.

CHANNEL	TX Channel 6	DETECTOR FUNCTION	Peak (PK)
FREQUENCY RANGE	1GHz ~ 25GHz		Average (AV)

ANTENNA POLARITY & TEST DISTANCE: HORIZONTAL AT 3 M

NO.	FREQ. (MHz)	EMISSION LEVEL (dBuV/m)	LIMIT (dBuV/m)	MARGIN (dB)	ANTENNA HEIGHT (m)	TABLE ANGLE (Degree)	RAW VALUE (dBuV)	CORRECTION FACTOR (dB/m)
1	2390.00	54.9 PK	74.0	-19.1	1.26 H	107	23.9	31.0
2	2390.00	43.1 AV	54.0	-10.9	1.26 H	107	12.1	31.0
3	*2437.00	101.1 PK			1.24 H	113	69.8	31.3
4	*2437.00	90.6 AV			1.24 H	113	59.3	31.3
5	4874.00	50.8 PK	74.0	-23.2	1.97 H	55	50.2	0.6
6	4874.00	37.6 AV	54.0	-16.4	1.97 H	55	37.0	0.6

ANTENNA POLARITY & TEST DISTANCE: VERTICAL AT 3 M

NO.	FREQ. (MHz)	EMISSION LEVEL (dBuV/m)	LIMIT (dBuV/m)	MARGIN (dB)	ANTENNA HEIGHT (m)	TABLE ANGLE (Degree)	RAW VALUE (dBuV)	CORRECTION FACTOR (dB/m)
1	2390.00	65.4 PK	74.0	-8.6	1.70 V	161	34.4	31.0
2	2390.00	52.9 AV	54.0	-1.1	1.70 V	161	21.9	31.0
3	*2437.00	121.2 PK			1.65 V	342	89.9	31.3
4	*2437.00	109.8 AV			1.65 V	342	78.5	31.3
5	4874.00	50.7 PK	74.0	-23.3	2.68 V	307	50.1	0.6
6	4874.00	37.4 AV	54.0	-16.6	2.68 V	307	36.8	0.6

REMARKS:

1. Emission Level(dBuV/m) = Raw Value(dBuV) + Correction Factor(dB/m)
2. Correction Factor(dB/m) = Antenna Factor(dB/m) + Cable Factor(dB)
3. The other emission levels were very low against the limit.
4. Margin value = Emission Level – Limit value
5. " * " : Fundamental frequency.

CHANNEL	TX Channel 11	DETECTOR FUNCTION	Peak (PK)
FREQUENCY RANGE	1GHz ~ 25GHz		Average (AV)

ANTENNA POLARITY & TEST DISTANCE: HORIZONTAL AT 3 M

NO.	FREQ. (MHz)	EMISSION LEVEL (dBuV/m)	LIMIT (dBuV/m)	MARGIN (dB)	ANTENNA HEIGHT (m)	TABLE ANGLE (Degree)	RAW VALUE (dBuV)	CORRECTION FACTOR (dB/m)
1	*2462.00	98.5 PK			1.51 H	194	67.1	31.4
2	*2462.00	87.8 AV			1.51 H	194	56.4	31.4
3	2483.50	55.5 PK	74.0	-18.5	1.58 H	197	24.0	31.5
4	2483.50	43.5 AV	54.0	-10.5	1.58 H	197	12.0	31.5
5	4924.00	49.4 PK	74.0	-24.6	1.85 H	52	48.8	0.6
6	4924.00	36.2 AV	54.0	-17.8	1.85 H	52	35.6	0.6

ANTENNA POLARITY & TEST DISTANCE: VERTICAL AT 3 M

NO.	FREQ. (MHz)	EMISSION LEVEL (dBuV/m)	LIMIT (dBuV/m)	MARGIN (dB)	ANTENNA HEIGHT (m)	TABLE ANGLE (Degree)	RAW VALUE (dBuV)	CORRECTION FACTOR (dB/m)
1	*2462.00	116.7 PK			1.83 V	170	85.3	31.4
2	*2462.00	106.0 AV			1.83 V	170	74.6	31.4
3	2483.50	65.7 PK	74.0	-8.3	1.84 V	160	34.2	31.5
4	2483.50	52.6 AV	54.0	-1.4	1.84 V	160	21.1	31.5
5	4924.00	47.9 PK	74.0	-26.1	1.91 V	307	47.3	0.6
6	4924.00	34.8 AV	54.0	-19.2	1.91 V	307	34.2	0.6

REMARKS:

1. Emission Level(dBuV/m) = Raw Value(dBuV) + Correction Factor(dB/m)
2. Correction Factor(dB/m) = Antenna Factor(dB/m) + Cable Factor(dB)
3. The other emission levels were very low against the limit.
4. Margin value = Emission Level – Limit value
5. " * " : Fundamental frequency.

802.11n (HT20)

CHANNEL	TX Channel 1	DETECTOR FUNCTION	Peak (PK)
FREQUENCY RANGE	1GHz ~ 25GHz		Average (AV)

ANTENNA POLARITY & TEST DISTANCE: HORIZONTAL AT 3 M

NO.	FREQ. (MHz)	EMISSION LEVEL (dBuV/m)	LIMIT (dBuV/m)	MARGIN (dB)	ANTENNA HEIGHT (m)	TABLE ANGLE (Degree)	RAW VALUE (dBuV)	CORRECTION FACTOR (dB/m)
1	2390.00	55.0 PK	74.0	-19.0	1.52 H	108	24.0	31.0
2	2390.00	42.9 AV	54.0	-11.1	1.52 H	108	11.9	31.0
3	*2412.00	97.0 PK			1.50 H	111	65.8	31.2
4	*2412.00	86.5 AV			1.50 H	111	55.3	31.2
5	4824.00	48.8 PK	74.0	-25.2	2.33 H	23	48.3	0.5
6	4824.00	34.7 AV	54.0	-19.3	2.33 H	23	34.2	0.5

ANTENNA POLARITY & TEST DISTANCE: VERTICAL AT 3 M

NO.	FREQ. (MHz)	EMISSION LEVEL (dBuV/m)	LIMIT (dBuV/m)	MARGIN (dB)	ANTENNA HEIGHT (m)	TABLE ANGLE (Degree)	RAW VALUE (dBuV)	CORRECTION FACTOR (dB/m)
1	2390.00	65.1 PK	74.0	-8.9	1.54 V	178	34.1	31.0
2	2390.00	52.5 AV	54.0	-1.5	1.54 V	178	21.5	31.0
3	*2412.00	115.9 PK			1.87 V	170	84.7	31.2
4	*2412.00	104.8 AV			1.87 V	170	73.6	31.2
5	4824.00	44.8 PK	74.0	-29.2	2.04 V	324	44.3	0.5
6	4824.00	32.4 AV	54.0	-21.6	2.04 V	324	31.9	0.5

REMARKS:

1. Emission Level(dBuV/m) = Raw Value(dBuV) + Correction Factor(dB/m)
2. Correction Factor(dB/m) = Antenna Factor(dB/m) + Cable Factor(dB)
3. The other emission levels were very low against the limit.
4. Margin value = Emission Level – Limit value
5. " * " : Fundamental frequency.

CHANNEL	TX Channel 6	DETECTOR FUNCTION	Peak (PK)
FREQUENCY RANGE	1GHz ~ 25GHz		Average (AV)

ANTENNA POLARITY & TEST DISTANCE: HORIZONTAL AT 3 M

NO.	FREQ. (MHz)	EMISSION LEVEL (dBuV/m)	LIMIT (dBuV/m)	MARGIN (dB)	ANTENNA HEIGHT (m)	TABLE ANGLE (Degree)	RAW VALUE (dBuV)	CORRECTION FACTOR (dB/m)
1	2390.00	54.8 PK	74.0	-19.2	1.95 H	113	23.8	31.0
2	2390.00	42.7 AV	54.0	-11.3	1.95 H	113	11.7	31.0
3	*2437.00	101.0 PK			1.94 H	118	69.7	31.3
4	*2437.00	90.5 AV			1.94 H	118	59.2	31.3
5	4874.00	50.5 PK	74.0	-23.5	1.98 H	54	49.9	0.6
6	4874.00	37.0 AV	54.0	-17.0	1.98 H	54	36.4	0.6

ANTENNA POLARITY & TEST DISTANCE: VERTICAL AT 3 M

NO.	FREQ. (MHz)	EMISSION LEVEL (dBuV/m)	LIMIT (dBuV/m)	MARGIN (dB)	ANTENNA HEIGHT (m)	TABLE ANGLE (Degree)	RAW VALUE (dBuV)	CORRECTION FACTOR (dB/m)
1	2390.00	64.8 PK	74.0	-9.2	1.64 V	349	33.8	31.0
2	2390.00	52.4 AV	54.0	-1.6	1.64 V	349	21.4	31.0
3	*2437.00	119.4 PK			1.66 V	167	88.1	31.3
4	*2437.00	108.6 AV			1.66 V	167	77.3	31.3
5	4874.00	48.7 PK	74.0	-25.3	1.77 V	309	48.1	0.6
6	4874.00	35.5 AV	54.0	-18.5	1.77 V	309	34.9	0.6

REMARKS:

1. Emission Level(dBuV/m) = Raw Value(dBuV) + Correction Factor(dB/m)
2. Correction Factor(dB/m) = Antenna Factor(dB/m) + Cable Factor(dB)
3. The other emission levels were very low against the limit.
4. Margin value = Emission Level – Limit value
5. " * " : Fundamental frequency.

CHANNEL	TX Channel 11	DETECTOR FUNCTION	Peak (PK)
FREQUENCY RANGE	1GHz ~ 25GHz		Average (AV)

ANTENNA POLARITY & TEST DISTANCE: HORIZONTAL AT 3 M

NO.	FREQ. (MHz)	EMISSION LEVEL (dBuV/m)	LIMIT (dBuV/m)	MARGIN (dB)	ANTENNA HEIGHT (m)	TABLE ANGLE (Degree)	RAW VALUE (dBuV)	CORRECTION FACTOR (dB/m)
1	*2462.00	97.6 PK			1.37 H	196	66.2	31.4
2	*2462.00	86.4 AV			1.37 H	196	55.0	31.4
3	2483.50	55.2 PK	74.0	-18.8	1.40 H	199	23.7	31.5
4	2483.50	43.4 AV	54.0	-10.6	1.40 H	199	11.9	31.5
5	4924.00	49.5 PK	74.0	-24.5	1.97 H	49	48.9	0.6
6	4924.00	35.1 AV	54.0	-18.9	1.97 H	49	34.5	0.6

ANTENNA POLARITY & TEST DISTANCE: VERTICAL AT 3 M

NO.	FREQ. (MHz)	EMISSION LEVEL (dBuV/m)	LIMIT (dBuV/m)	MARGIN (dB)	ANTENNA HEIGHT (m)	TABLE ANGLE (Degree)	RAW VALUE (dBuV)	CORRECTION FACTOR (dB/m)
1	*2462.00	115.6 PK			1.60 V	338	84.2	31.4
2	*2462.00	104.7 AV			1.60 V	338	73.3	31.4
3	2483.50	66.9 PK	74.0	-7.1	1.59 V	165	35.4	31.5
4	2483.50	52.5 AV	54.0	-1.5	1.59 V	165	21.0	31.5
5	4924.00	45.8 PK	74.0	-28.2	2.16 V	118	45.2	0.6
6	4924.00	32.9 AV	54.0	-21.1	2.16 V	118	32.3	0.6

REMARKS:

1. Emission Level(dBuV/m) = Raw Value(dBuV) + Correction Factor(dB/m)
2. Correction Factor(dB/m) = Antenna Factor(dB/m) + Cable Factor(dB)
3. The other emission levels were very low against the limit.
4. Margin value = Emission Level – Limit value
5. " * " : Fundamental frequency.

802.11n (HT40)

CHANNEL	TX Channel 3	DETECTOR FUNCTION	Peak (PK)
FREQUENCY RANGE	1GHz ~ 25GHz		Average (AV)

ANTENNA POLARITY & TEST DISTANCE: HORIZONTAL AT 3 M

NO.	FREQ. (MHz)	EMISSION LEVEL (dBuV/m)	LIMIT (dBuV/m)	MARGIN (dB)	ANTENNA HEIGHT (m)	TABLE ANGLE (Degree)	RAW VALUE (dBuV)	CORRECTION FACTOR (dB/m)
1	2390.00	56.0 PK	74.0	-18.0	1.86 H	267	25.0	31.0
2	2390.00	43.4 AV	54.0	-10.6	1.86 H	267	12.4	31.0
3	*2422.00	92.9 PK			2.01 H	124	61.7	31.2
4	*2422.00	83.1 AV			2.01 H	124	51.9	31.2
5	4844.00	46.0 PK	74.0	-28.0	2.09 H	20	45.6	0.4
6	4844.00	32.8 AV	54.0	-21.2	2.09 H	20	32.4	0.4

ANTENNA POLARITY & TEST DISTANCE: VERTICAL AT 3 M

NO.	FREQ. (MHz)	EMISSION LEVEL (dBuV/m)	LIMIT (dBuV/m)	MARGIN (dB)	ANTENNA HEIGHT (m)	TABLE ANGLE (Degree)	RAW VALUE (dBuV)	CORRECTION FACTOR (dB/m)
1	2390.00	68.7 PK	74.0	-5.3	1.67 V	328	37.7	31.0
2	2390.00	52.5 AV	54.0	-1.5	1.67 V	328	21.5	31.0
3	*2422.00	114.3 PK			1.63 V	162	83.1	31.2
4	*2422.00	104.7 AV			1.63 V	162	73.5	31.2
5	4844.00	45.5 PK	74.0	-28.5	1.81 V	241	45.1	0.4
6	4844.00	32.4 AV	54.0	-21.6	1.81 V	241	32.0	0.4

REMARKS:

1. Emission Level(dBuV/m) = Raw Value(dBuV) + Correction Factor(dB/m)
2. Correction Factor(dB/m) = Antenna Factor(dB/m) + Cable Factor(dB)
3. The other emission levels were very low against the limit.
4. Margin value = Emission Level – Limit value
5. " * " : Fundamental frequency.

CHANNEL	TX Channel 6	DETECTOR FUNCTION	Peak (PK)
FREQUENCY RANGE	1GHz ~ 25GHz		Average (AV)

ANTENNA POLARITY & TEST DISTANCE: HORIZONTAL AT 3 M

NO.	FREQ. (MHz)	EMISSION LEVEL (dBuV/m)	LIMIT (dBuV/m)	MARGIN (dB)	ANTENNA HEIGHT (m)	TABLE ANGLE (Degree)	RAW VALUE (dBuV)	CORRECTION FACTOR (dB/m)
1	2390.00	55.2 PK	74.0	-18.8	1.79 H	286	24.2	31.0
2	2390.00	43.4 AV	54.0	-10.6	1.79 H	286	12.4	31.0
3	*2437.00	96.6 PK			1.54 H	131	65.3	31.3
4	*2437.00	86.9 AV			1.54 H	131	55.6	31.3
5	4874.00	46.8 PK	74.0	-27.2	1.92 H	20	46.2	0.6
6	4874.00	33.5 AV	54.0	-20.5	1.92 H	20	32.9	0.6

ANTENNA POLARITY & TEST DISTANCE: VERTICAL AT 3 M

NO.	FREQ. (MHz)	EMISSION LEVEL (dBuV/m)	LIMIT (dBuV/m)	MARGIN (dB)	ANTENNA HEIGHT (m)	TABLE ANGLE (Degree)	RAW VALUE (dBuV)	CORRECTION FACTOR (dB/m)
1	2390.00	64.0 PK	74.0	-10.0	2.11 V	158	33.0	31.0
2	2390.00	52.3 AV	54.0	-1.7	2.11 V	158	21.3	31.0
3	*2437.00	115.4 PK			2.13 V	341	84.1	31.3
4	*2437.00	105.9 AV			2.13 V	341	74.6	31.3
5	4874.00	46.3 PK	74.0	-27.7	2.11 V	162	45.7	0.6
6	4874.00	33.2 AV	54.0	-20.8	2.11 V	162	32.6	0.6

REMARKS:

1. Emission Level(dBuV/m) = Raw Value(dBuV) + Correction Factor(dB/m)
2. Correction Factor(dB/m) = Antenna Factor(dB/m) + Cable Factor(dB)
3. The other emission levels were very low against the limit.
4. Margin value = Emission Level – Limit value
5. " * " : Fundamental frequency.

CHANNEL	TX Channel 9	DETECTOR FUNCTION	Peak (PK)
FREQUENCY RANGE	1GHz ~ 25GHz		Average (AV)

ANTENNA POLARITY & TEST DISTANCE: HORIZONTAL AT 3 M

NO.	FREQ. (MHz)	EMISSION LEVEL (dBuV/m)	LIMIT (dBuV/m)	MARGIN (dB)	ANTENNA HEIGHT (m)	TABLE ANGLE (Degree)	RAW VALUE (dBuV)	CORRECTION FACTOR (dB/m)
1	*2452.00	91.4 PK			1.69 H	118	60.0	31.4
2	*2452.00	80.7 AV			1.69 H	118	49.3	31.4
3	2483.50	56.4 PK	74.0	-17.6	2.25 H	281	24.9	31.5
4	2483.50	44.2 AV	54.0	-9.8	2.25 H	281	12.7	31.5
5	4904.00	46.3 PK	74.0	-27.7	1.72 H	169	45.8	0.5
6	4904.00	32.6 AV	54.0	-21.4	1.72 H	169	32.1	0.5

ANTENNA POLARITY & TEST DISTANCE: VERTICAL AT 3 M

NO.	FREQ. (MHz)	EMISSION LEVEL (dBuV/m)	LIMIT (dBuV/m)	MARGIN (dB)	ANTENNA HEIGHT (m)	TABLE ANGLE (Degree)	RAW VALUE (dBuV)	CORRECTION FACTOR (dB/m)
1	*2452.00	111.4 PK			2.06 V	169	80.0	31.4
2	*2452.00	101.2 AV			2.06 V	169	69.8	31.4
3	2483.50	69.4 PK	74.0	-4.6	2.09 V	165	37.9	31.5
4	2483.50	52.5 AV	54.0	-1.5	2.09 V	165	21.0	31.5
5	4904.00	46.2 PK	74.0	-27.8	1.81 V	286	45.7	0.5
6	4904.00	32.7 AV	54.0	-21.3	1.81 V	286	32.2	0.5

REMARKS:

1. Emission Level(dBuV/m) = Raw Value(dBuV) + Correction Factor(dB/m)
2. Correction Factor(dB/m) = Antenna Factor(dB/m) + Cable Factor(dB)
3. The other emission levels were very low against the limit.
4. Margin value = Emission Level – Limit value
5. " * " : Fundamental frequency.

Below 1GHz worst-case data:

802.11b

CHANNEL	TX Channel 6	DETECTOR FUNCTION	Quasi-Peak (QP)
FREQUENCY RANGE	30MHz ~ 1GHz		

ANTENNA POLARITY & TEST DISTANCE: HORIZONTAL AT 3 M								
NO.	FREQ. (MHz)	EMISSION LEVEL (dBuV/m)	LIMIT (dBuV/m)	MARGIN (dB)	ANTENNA HEIGHT (m)	TABLE ANGLE (Degree)	RAW VALUE (dBuV)	CORRECTION FACTOR (dB/m)
1	101.84	32.4 QP	43.5	-11.1	2.00 H	234	50.6	-18.2
2	599.58	39.7 QP	46.0	-6.3	1.00 H	345	45.1	-5.4
3	624.85	39.7 QP	46.0	-6.3	1.00 H	342	44.5	-4.8
4	700.68	39.4 QP	46.0	-6.6	1.00 H	6	43.0	-3.6
5	731.79	41.1 QP	46.0	-4.9	1.51 H	191	43.8	-2.7
6	858.17	36.6 QP	46.0	-9.4	2.00 H	192	37.2	-0.6
ANTENNA POLARITY & TEST DISTANCE: VERTICAL AT 3 M								
NO.	FREQ. (MHz)	EMISSION LEVEL (dBuV/m)	LIMIT (dBuV/m)	MARGIN (dB)	ANTENNA HEIGHT (m)	TABLE ANGLE (Degree)	RAW VALUE (dBuV)	CORRECTION FACTOR (dB/m)
1	35.73	35.7 QP	40.0	-4.3	1.00 V	64	51.6	-15.9
2	169.89	28.5 QP	43.5	-15.0	1.00 V	175	42.4	-13.9
3	599.58	33.2 QP	46.0	-12.8	1.49 V	19	38.6	-5.4
4	727.90	39.6 QP	46.0	-6.4	1.49 V	104	42.5	-2.9
5	768.73	36.9 QP	46.0	-9.1	1.49 V	105	39.0	-2.1
6	809.56	35.6 QP	46.0	-10.4	1.00 V	77	36.9	-1.3

Remarks:

1. Emission Level(dBuV/m) = Raw Value(dBuV) + Correction Factor(dB/m)
2. Correction Factor(dB/m) = Antenna Factor(dB/m) + Cable Factor(dB)
3. The other emission levels were very low against the limit.
4. Margin value = Emission Level – Limit value

Test Mode B

Above 1GHz worst-Case data:

802.11b

CHANNEL	TX Channel 1	DETECTOR FUNCTION	Peak (PK)
FREQUENCY RANGE	1GHz ~ 25GHz		Average (AV)

ANTENNA POLARITY & TEST DISTANCE: HORIZONTAL AT 3 M

NO.	FREQ. (MHz)	EMISSION LEVEL (dBuV/m)	LIMIT (dBuV/m)	MARGIN (dB)	ANTENNA HEIGHT (m)	TABLE ANGLE (Degree)	RAW VALUE (dBuV)	CORRECTION FACTOR (dB/m)
1	2390.00	62.9 PK	74.0	-11.1	1.74 H	353	31.9	31.0
2	2390.00	48.9 AV	54.0	-5.1	1.74 H	353	17.9	31.0
3	*2412.00	118.1 PK			2.00 H	349	86.9	31.2
4	*2412.00	116.0 AV			2.00 H	349	84.8	31.2
5	4824.00	45.9 PK	74.0	-28.1	2.70 H	200	45.4	0.5
6	4824.00	33.2 AV	54.0	-20.8	2.70 H	200	32.7	0.5

ANTENNA POLARITY & TEST DISTANCE: VERTICAL AT 3 M

NO.	FREQ. (MHz)	EMISSION LEVEL (dBuV/m)	LIMIT (dBuV/m)	MARGIN (dB)	ANTENNA HEIGHT (m)	TABLE ANGLE (Degree)	RAW VALUE (dBuV)	CORRECTION FACTOR (dB/m)
1	2390.00	63.1 PK	74.0	-10.9	2.03 V	350	32.1	31.0
2	2390.00	49.0 AV	54.0	-5.0	2.03 V	350	18.0	31.0
3	*2412.00	116.4 PK			1.97 V	331	85.2	31.2
4	*2412.00	113.2 AV			1.97 V	331	82.0	31.2
5	4824.00	46.1 PK	74.0	-27.9	2.83 V	202	45.6	0.5
6	4824.00	34.8 AV	54.0	-19.2	2.83 V	202	34.3	0.5

REMARKS:

1. Emission Level(dBuV/m) = Raw Value(dBuV) + Correction Factor(dB/m)
2. Correction Factor(dB/m) = Antenna Factor(dB/m) + Cable Factor(dB)
3. The other emission levels were very low against the limit.
4. Margin value = Emission Level – Limit value
5. " * ": Fundamental frequency.

CHANNEL	TX Channel 6	DETECTOR FUNCTION	Peak (PK)
FREQUENCY RANGE	1GHz ~ 25GHz		Average (AV)

ANTENNA POLARITY & TEST DISTANCE: HORIZONTAL AT 3 M

NO.	FREQ. (MHz)	EMISSION LEVEL (dBuV/m)	LIMIT (dBuV/m)	MARGIN (dB)	ANTENNA HEIGHT (m)	TABLE ANGLE (Degree)	RAW VALUE (dBuV)	CORRECTION FACTOR (dB/m)
1	2390.00	61.8 PK	74.0	-12.2	1.85 H	346	30.8	31.0
2	2390.00	47.2 AV	54.0	-6.8	1.85 H	346	16.2	31.0
3	*2437.00	118.8 PK			2.02 H	348	87.5	31.3
4	*2437.00	116.6 AV			2.02 H	348	85.3	31.3
5	2483.50	62.7 PK	74.0	-11.3	2.03 H	347	31.2	31.5
6	2483.50	49.8 AV	54.0	-4.2	2.03 H	347	18.3	31.5
7	4874.00	47.8 PK	74.0	-26.2	2.30 H	230	47.2	0.6
8	4874.00	39.5 AV	54.0	-14.5	2.30 H	230	38.9	0.6

ANTENNA POLARITY & TEST DISTANCE: VERTICAL AT 3 M

NO.	FREQ. (MHz)	EMISSION LEVEL (dBuV/m)	LIMIT (dBuV/m)	MARGIN (dB)	ANTENNA HEIGHT (m)	TABLE ANGLE (Degree)	RAW VALUE (dBuV)	CORRECTION FACTOR (dB/m)
1	2390.00	59.7 PK	74.0	-14.3	1.85 V	346	28.7	31.0
2	2390.00	46.2 AV	54.0	-7.8	1.85 V	346	15.2	31.0
3	*2437.00	118.3 PK			1.90 V	348	87.0	31.3
4	*2437.00	116.1 AV			1.90 V	348	84.8	31.3
5	2483.50	63.4 PK	74.0	-10.6	1.91 V	349	31.9	31.5
6	2483.50	50.0 AV	54.0	-4.0	1.91 V	349	18.5	31.5
7	4874.00	51.2 PK	74.0	-22.8	2.58 V	172	50.6	0.6
8	4874.00	45.4 AV	54.0	-8.6	2.58 V	172	44.8	0.6

REMARKS:

1. Emission Level(dBuV/m) = Raw Value(dBuV) + Correction Factor(dB/m)
2. Correction Factor(dB/m) = Antenna Factor(dB/m) + Cable Factor(dB)
3. The other emission levels were very low against the limit.
4. Margin value = Emission Level – Limit value
5. " * ": Fundamental frequency.

CHANNEL	TX Channel 11	DETECTOR FUNCTION	Peak (PK)
FREQUENCY RANGE	1GHz ~ 25GHz		Average (AV)

ANTENNA POLARITY & TEST DISTANCE: HORIZONTAL AT 3 M

NO.	FREQ. (MHz)	EMISSION LEVEL (dBuV/m)	LIMIT (dBuV/m)	MARGIN (dB)	ANTENNA HEIGHT (m)	TABLE ANGLE (Degree)	RAW VALUE (dBuV)	CORRECTION FACTOR (dB/m)
1	*2462.00	118.3 PK			2.00 H	349	86.9	31.4
2	*2462.00	116.1 AV			2.00 H	349	84.7	31.4
3	2483.50	68.1 PK	74.0	-5.9	1.86 H	350	36.6	31.5
4	2483.50	48.8 AV	54.0	-5.2	1.86 H	350	17.3	31.5
5	4924.00	47.5 PK	74.0	-26.5	2.55 H	228	46.9	0.6
6	4924.00	37.4 AV	54.0	-16.6	2.55 H	228	36.8	0.6

ANTENNA POLARITY & TEST DISTANCE: VERTICAL AT 3 M

NO.	FREQ. (MHz)	EMISSION LEVEL (dBuV/m)	LIMIT (dBuV/m)	MARGIN (dB)	ANTENNA HEIGHT (m)	TABLE ANGLE (Degree)	RAW VALUE (dBuV)	CORRECTION FACTOR (dB/m)
1	*2462.00	115.7 PK			2.16 V	350	84.3	31.4
2	*2462.00	113.6 AV			2.16 V	350	82.2	31.4
3	2483.50	62.5 PK	74.0	-11.5	2.02 V	350	31.0	31.5
4	2483.50	49.3 AV	54.0	-4.7	2.02 V	350	17.8	31.5
5	4924.00	49.4 PK	74.0	-24.6	2.30 V	166	48.8	0.6
6	4924.00	41.8 AV	54.0	-12.2	2.30 V	166	41.2	0.6

REMARKS:

1. Emission Level(dBuV/m) = Raw Value(dBuV) + Correction Factor(dB/m)
2. Correction Factor(dB/m) = Antenna Factor(dB/m) + Cable Factor(dB)
3. The other emission levels were very low against the limit.
4. Margin value = Emission Level – Limit value
5. " * " : Fundamental frequency.

802.11g

CHANNEL	TX Channel 1	DETECTOR FUNCTION	Peak (PK)
FREQUENCY RANGE	1GHz ~ 25GHz		Average (AV)

ANTENNA POLARITY & TEST DISTANCE: HORIZONTAL AT 3 M

NO.	FREQ. (MHz)	EMISSION LEVEL (dBuV/m)	LIMIT (dBuV/m)	MARGIN (dB)	ANTENNA HEIGHT (m)	TABLE ANGLE (Degree)	RAW VALUE (dBuV)	CORRECTION FACTOR (dB/m)
1	2390.00	64.5 PK	74.0	-9.5	1.65 H	350	33.5	31.0
2	2390.00	52.3 AV	54.0	-1.7	1.65 H	350	21.3	31.0
3	*2412.00	119.2 PK			1.95 H	350	88.0	31.2
4	*2412.00	109.1 AV			1.95 H	350	77.9	31.2
5	4824.00	45.5 PK	74.0	-28.5	2.50 H	229	45.0	0.5
6	4824.00	32.5 AV	54.0	-21.5	2.50 H	229	32.0	0.5

ANTENNA POLARITY & TEST DISTANCE: VERTICAL AT 3 M

NO.	FREQ. (MHz)	EMISSION LEVEL (dBuV/m)	LIMIT (dBuV/m)	MARGIN (dB)	ANTENNA HEIGHT (m)	TABLE ANGLE (Degree)	RAW VALUE (dBuV)	CORRECTION FACTOR (dB/m)
1	2390.00	63.9 PK	74.0	-10.1	2.14 V	350	32.9	31.0
2	2390.00	50.2 AV	54.0	-3.8	2.14 V	350	19.2	31.0
3	*2412.00	119.1 PK			2.06 V	353	87.9	31.2
4	*2412.00	108.3 AV			2.06 V	353	77.1	31.2
5	4824.00	47.1 PK	74.0	-26.9	2.55 V	171	46.6	0.5
6	4824.00	33.4 AV	54.0	-20.6	2.55 V	171	32.9	0.5

REMARKS:

1. Emission Level(dBuV/m) = Raw Value(dBuV) + Correction Factor(dB/m)
2. Correction Factor(dB/m) = Antenna Factor(dB/m) + Cable Factor(dB)
3. The other emission levels were very low against the limit.
4. Margin value = Emission Level – Limit value
5. " * " : Fundamental frequency.

CHANNEL	TX Channel 6	DETECTOR FUNCTION	Peak (PK)
FREQUENCY RANGE	1GHz ~ 25GHz		Average (AV)

ANTENNA POLARITY & TEST DISTANCE: HORIZONTAL AT 3 M

NO.	FREQ. (MHz)	EMISSION LEVEL (dBuV/m)	LIMIT (dBuV/m)	MARGIN (dB)	ANTENNA HEIGHT (m)	TABLE ANGLE (Degree)	RAW VALUE (dBuV)	CORRECTION FACTOR (dB/m)
1	*2437.00	120.2 PK			1.84 H	356	88.9	31.3
2	*2437.00	110.1 AV			1.84 H	356	78.8	31.3
3	2483.50	66.4 PK	74.0	-7.6	1.80 H	342	34.9	31.5
4	2483.50	49.4 AV	54.0	-4.6	1.80 H	342	17.9	31.5
5	#3249.00	53.4 PK	74.0	-20.6	2.24 H	5	57.6	-4.2
6	#3249.00	50.6 AV	54.0	-3.4	2.24 H	5	54.8	-4.2
7	4874.00	46.9 PK	74.0	-27.1	2.50 H	227	46.3	0.6
8	4874.00	33.1 AV	54.0	-20.9	2.50 H	227	32.5	0.6

ANTENNA POLARITY & TEST DISTANCE: VERTICAL AT 3 M

NO.	FREQ. (MHz)	EMISSION LEVEL (dBuV/m)	LIMIT (dBuV/m)	MARGIN (dB)	ANTENNA HEIGHT (m)	TABLE ANGLE (Degree)	RAW VALUE (dBuV)	CORRECTION FACTOR (dB/m)
1	*2437.00	118.6 PK			2.12 V	350	87.3	31.3
2	*2437.00	107.9 AV			2.12 V	350	76.6	31.3
3	2483.50	63.8 PK	74.0	-10.2	1.79 V	343	32.3	31.5
4	2483.50	47.7 AV	54.0	-6.3	1.79 V	343	16.2	31.5
5	#3249.00	44.8 PK	74.0	-29.2	2.17 V	144	49.0	-4.2
6	#3249.00	34.5 AV	54.0	-19.5	2.17 V	144	38.7	-4.2
7	4874.00	46.1 PK	74.0	-27.9	2.18 V	217	45.5	0.6
8	4874.00	33.1 AV	54.0	-20.9	2.18 V	217	32.5	0.6

REMARKS:

1. Emission Level(dBuV/m) = Raw Value(dBuV) + Correction Factor(dB/m)
2. Correction Factor(dB/m) = Antenna Factor(dB/m) + Cable Factor(dB)
3. The other emission levels were very low against the limit.
4. Margin value = Emission Level – Limit value
5. " * ": Fundamental frequency.

CHANNEL	TX Channel 11	DETECTOR FUNCTION	Peak (PK)
FREQUENCY RANGE	1GHz ~ 25GHz		Average (AV)

ANTENNA POLARITY & TEST DISTANCE: HORIZONTAL AT 3 M

NO.	FREQ. (MHz)	EMISSION LEVEL (dBuV/m)	LIMIT (dBuV/m)	MARGIN (dB)	ANTENNA HEIGHT (m)	TABLE ANGLE (Degree)	RAW VALUE (dBuV)	CORRECTION FACTOR (dB/m)
1	*2462.00	118.2 PK			1.93 H	348	86.8	31.4
2	*2462.00	107.8 AV			1.93 H	348	76.4	31.4
3	2483.50	65.3 PK	74.0	-8.7	1.92 H	345	33.8	31.5
4	2483.50	52.4 AV	54.0	-1.6	1.92 H	345	20.9	31.5
5	4924.00	46.1 PK	74.0	-27.9	2.20 H	205	45.5	0.6
6	4924.00	32.3 AV	54.0	-21.7	2.20 H	205	31.7	0.6

ANTENNA POLARITY & TEST DISTANCE: VERTICAL AT 3 M

NO.	FREQ. (MHz)	EMISSION LEVEL (dBuV/m)	LIMIT (dBuV/m)	MARGIN (dB)	ANTENNA HEIGHT (m)	TABLE ANGLE (Degree)	RAW VALUE (dBuV)	CORRECTION FACTOR (dB/m)
1	*2462.00	118.8 PK			2.10 V	351	87.4	31.4
2	*2462.00	107.9 AV			2.10 V	351	76.5	31.4
3	2483.50	63.5 PK	74.0	-10.5	1.66 V	353	32.0	31.5
4	2483.50	50.9 AV	54.0	-3.1	1.66 V	353	19.4	31.5
5	4924.00	45.5 PK	74.0	-28.5	2.20 V	205	44.9	0.6
6	4924.00	32.5 AV	54.0	-21.5	2.20 V	205	31.9	0.6

REMARKS:

1. Emission Level(dBuV/m) = Raw Value(dBuV) + Correction Factor(dB/m)
2. Correction Factor(dB/m) = Antenna Factor(dB/m) + Cable Factor(dB)
3. The other emission levels were very low against the limit.
4. Margin value = Emission Level – Limit value
5. " * " : Fundamental frequency.

802.11n (HT20)

CHANNEL	TX Channel 1	DETECTOR FUNCTION	Peak (PK)
FREQUENCY RANGE	1GHz ~ 25GHz		Average (AV)

ANTENNA POLARITY & TEST DISTANCE: HORIZONTAL AT 3 M

NO.	FREQ. (MHz)	EMISSION LEVEL (dBuV/m)	LIMIT (dBuV/m)	MARGIN (dB)	ANTENNA HEIGHT (m)	TABLE ANGLE (Degree)	RAW VALUE (dBuV)	CORRECTION FACTOR (dB/m)
1	2390.00	67.3 PK	74.0	-6.7	1.66 H	348	36.3	31.0
2	2390.00	52.9 AV	54.0	-1.1	1.66 H	348	21.9	31.0
3	*2412.00	118.8 PK			1.99 H	0	87.6	31.2
4	*2412.00	108.3 AV			1.99 H	0	77.1	31.2
5	4824.00	44.9 PK	74.0	-29.1	1.57 H	341	44.4	0.5
6	4824.00	32.2 AV	54.0	-21.8	1.57 H	341	31.7	0.5

ANTENNA POLARITY & TEST DISTANCE: VERTICAL AT 3 M

NO.	FREQ. (MHz)	EMISSION LEVEL (dBuV/m)	LIMIT (dBuV/m)	MARGIN (dB)	ANTENNA HEIGHT (m)	TABLE ANGLE (Degree)	RAW VALUE (dBuV)	CORRECTION FACTOR (dB/m)
1	2390.00	62.7 PK	74.0	-11.3	2.10 V	351	31.7	31.0
2	2390.00	50.1 AV	54.0	-3.9	2.10 V	351	19.1	31.0
3	*2412.00	117.9 PK			1.56 V	348	86.7	31.2
4	*2412.00	106.9 AV			1.56 V	348	75.7	31.2
5	4824.00	41.7 PK	74.0	-32.3	1.60 V	301	41.2	0.5
6	4824.00	31.3 AV	54.0	-22.7	1.60 V	301	30.8	0.5

REMARKS:

1. Emission Level(dBuV/m) = Raw Value(dBuV) + Correction Factor(dB/m)
2. Correction Factor(dB/m) = Antenna Factor(dB/m) + Cable Factor(dB)
3. The other emission levels were very low against the limit.
4. Margin value = Emission Level – Limit value
5. " * " : Fundamental frequency.

CHANNEL	TX Channel 6	DETECTOR FUNCTION	Peak (PK)
FREQUENCY RANGE	1GHz ~ 25GHz		Average (AV)

ANTENNA POLARITY & TEST DISTANCE: HORIZONTAL AT 3 M

NO.	FREQ. (MHz)	EMISSION LEVEL (dBuV/m)	LIMIT (dBuV/m)	MARGIN (dB)	ANTENNA HEIGHT (m)	TABLE ANGLE (Degree)	RAW VALUE (dBuV)	CORRECTION FACTOR (dB/m)
1	2390.00	62.5 PK	74.0	-11.5	1.78 H	357	31.5	31.0
2	2390.00	48.9 AV	54.0	-5.1	1.78 H	357	17.9	31.0
3	*2437.00	119.1 PK			1.86 H	0	87.8	31.3
4	*2437.00	108.8 AV			1.86 H	0	77.5	31.3
5	2483.50	64.8 PK	74.0	-9.2	1.83 H	349	33.3	31.5
6	2483.50	49.3 AV	54.0	-4.7	1.83 H	349	17.8	31.5
7	4874.00	46.5 PK	74.0	-27.5	1.77 H	299	45.9	0.6
8	4874.00	33.2 AV	54.0	-20.8	1.77 H	299	32.6	0.6

ANTENNA POLARITY & TEST DISTANCE: VERTICAL AT 3 M

NO.	FREQ. (MHz)	EMISSION LEVEL (dBuV/m)	LIMIT (dBuV/m)	MARGIN (dB)	ANTENNA HEIGHT (m)	TABLE ANGLE (Degree)	RAW VALUE (dBuV)	CORRECTION FACTOR (dB/m)
1	2390.00	56.1 PK	74.0	-17.9	1.75 V	350	25.1	31.0
2	2390.00	45.6 AV	54.0	-8.4	1.75 V	350	14.6	31.0
3	*2437.00	118.5 PK			1.65 V	340	87.2	31.3
4	*2437.00	107.9 AV			1.65 V	340	76.6	31.3
5	2483.50	61.6 PK	74.0	-12.4	1.70 V	350	30.1	31.5
6	2483.50	48.3 AV	54.0	-5.7	1.70 V	350	16.8	31.5
7	4874.00	45.7 PK	74.0	-28.3	1.89 V	5	45.1	0.6
8	4874.00	33.2 AV	54.0	-20.8	1.89 V	5	32.6	0.6

REMARKS:

1. Emission Level(dBuV/m) = Raw Value(dBuV) + Correction Factor(dB/m)
2. Correction Factor(dB/m) = Antenna Factor(dB/m) + Cable Factor(dB)
3. The other emission levels were very low against the limit.
4. Margin value = Emission Level – Limit value
5. " * ": Fundamental frequency.

CHANNEL	TX Channel 11	DETECTOR FUNCTION	Peak (PK)
FREQUENCY RANGE	1GHz ~ 25GHz		Average (AV)

ANTENNA POLARITY & TEST DISTANCE: HORIZONTAL AT 3 M

NO.	FREQ. (MHz)	EMISSION LEVEL (dBuV/m)	LIMIT (dBuV/m)	MARGIN (dB)	ANTENNA HEIGHT (m)	TABLE ANGLE (Degree)	RAW VALUE (dBuV)	CORRECTION FACTOR (dB/m)
1	*2462.00	117.0 PK			2.10 H	344	85.6	31.4
2	*2462.00	106.4 AV			2.10 H	344	75.0	31.4
3	2483.50	65.4 PK	74.0	-8.6	1.92 H	346	33.9	31.5
4	2483.50	52.5 AV	54.0	-1.5	1.92 H	346	21.0	31.5
5	4924.00	45.1 PK	74.0	-28.9	1.68 H	330	44.5	0.6
6	4924.00	32.2 AV	54.0	-21.8	1.68 H	330	31.6	0.6

ANTENNA POLARITY & TEST DISTANCE: VERTICAL AT 3 M

NO.	FREQ. (MHz)	EMISSION LEVEL (dBuV/m)	LIMIT (dBuV/m)	MARGIN (dB)	ANTENNA HEIGHT (m)	TABLE ANGLE (Degree)	RAW VALUE (dBuV)	CORRECTION FACTOR (dB/m)
1	*2462.00	116.1 PK			2.10 V	339	84.7	31.4
2	*2462.00	105.6 AV			2.10 V	339	74.2	31.4
3	2483.50	61.4 PK	74.0	-12.6	1.57 V	350	29.9	31.5
4	2483.50	48.8 AV	54.0	-5.2	1.57 V	350	17.3	31.5
5	4924.00	44.6 PK	74.0	-29.4	1.99 V	39	44.0	0.6
6	4924.00	32.7 AV	54.0	-21.3	1.99 V	39	32.1	0.6

REMARKS:

1. Emission Level(dBuV/m) = Raw Value(dBuV) + Correction Factor(dB/m)
2. Correction Factor(dB/m) = Antenna Factor(dB/m) + Cable Factor(dB)
3. The other emission levels were very low against the limit.
4. Margin value = Emission Level – Limit value
5. " * " : Fundamental frequency.

802.11n (HT40)

CHANNEL	TX Channel 3	DETECTOR FUNCTION	Peak (PK)
FREQUENCY RANGE	1GHz ~ 25GHz		Average (AV)

ANTENNA POLARITY & TEST DISTANCE: HORIZONTAL AT 3 M

NO.	FREQ. (MHz)	EMISSION LEVEL (dBuV/m)	LIMIT (dBuV/m)	MARGIN (dB)	ANTENNA HEIGHT (m)	TABLE ANGLE (Degree)	RAW VALUE (dBuV)	CORRECTION FACTOR (dB/m)
1	2390.00	67.5 PK	74.0	-6.5	2.00 H	343	36.5	31.0
2	2390.00	52.4 AV	54.0	-1.6	2.00 H	343	21.4	31.0
3	*2422.00	113.1 PK			1.97 H	353	81.9	31.2
4	*2422.00	103.1 AV			1.97 H	353	71.9	31.2
5	4844.00	44.3 PK	74.0	-29.7	1.89 H	279	43.9	0.4
6	4844.00	31.5 AV	54.0	-22.5	1.89 H	279	31.1	0.4

ANTENNA POLARITY & TEST DISTANCE: VERTICAL AT 3 M

NO.	FREQ. (MHz)	EMISSION LEVEL (dBuV/m)	LIMIT (dBuV/m)	MARGIN (dB)	ANTENNA HEIGHT (m)	TABLE ANGLE (Degree)	RAW VALUE (dBuV)	CORRECTION FACTOR (dB/m)
1	2390.00	66.5 PK	74.0	-7.5	1.89 V	340	35.5	31.0
2	2390.00	52.0 AV	54.0	-2.0	1.89 V	340	21.0	31.0
3	*2422.00	111.8 PK			1.64 V	336	80.6	31.2
4	*2422.00	101.9 AV			1.64 V	336	70.7	31.2
5	4844.00	45.1 PK	74.0	-28.9	1.89 V	11	44.7	0.4
6	4844.00	32.4 AV	54.0	-21.6	1.89 V	11	32.0	0.4

REMARKS:

1. Emission Level(dBuV/m) = Raw Value(dBuV) + Correction Factor(dB/m)
2. Correction Factor(dB/m) = Antenna Factor(dB/m) + Cable Factor(dB)
3. The other emission levels were very low against the limit.
4. Margin value = Emission Level – Limit value
5. " * " : Fundamental frequency.

CHANNEL	TX Channel 6	DETECTOR FUNCTION	Peak (PK)
FREQUENCY RANGE	1GHz ~ 25GHz		Average (AV)

ANTENNA POLARITY & TEST DISTANCE: HORIZONTAL AT 3 M

NO.	FREQ. (MHz)	EMISSION LEVEL (dBuV/m)	LIMIT (dBuV/m)	MARGIN (dB)	ANTENNA HEIGHT (m)	TABLE ANGLE (Degree)	RAW VALUE (dBuV)	CORRECTION FACTOR (dB/m)
1	2390.00	65.2 PK	74.0	-8.8	1.70 H	351	34.2	31.0
2	2390.00	51.7 AV	54.0	-2.3	1.70 H	351	20.7	31.0
3	*2437.00	116.0 PK			2.04 H	344	84.7	31.3
4	*2437.00	106.3 AV			2.04 H	344	75.0	31.3
5	2483.50	66.6 PK	74.0	-7.4	1.79 H	350	35.1	31.5
6	2483.50	52.8 AV	54.0	-1.2	1.79 H	350	21.3	31.5
7	4874.00	44.8 PK	74.0	-29.2	1.99 H	19	44.2	0.6
8	4874.00	32.4 AV	54.0	-21.6	1.99 H	19	31.8	0.6

ANTENNA POLARITY & TEST DISTANCE: VERTICAL AT 3 M

NO.	FREQ. (MHz)	EMISSION LEVEL (dBuV/m)	LIMIT (dBuV/m)	MARGIN (dB)	ANTENNA HEIGHT (m)	TABLE ANGLE (Degree)	RAW VALUE (dBuV)	CORRECTION FACTOR (dB/m)
1	2390.00	64.3 PK	74.0	-9.7	1.75 V	348	33.3	31.0
2	2390.00	49.7 AV	54.0	-4.3	1.75 V	348	18.7	31.0
3	*2437.00	114.5 PK			1.62 V	337	83.2	31.3
4	*2437.00	105.2 AV			1.62 V	337	73.9	31.3
5	2483.50	68.0 PK	74.0	-6.0	1.79 V	337	36.5	31.5
6	2483.50	52.9 AV	54.0	-1.1	1.79 V	337	21.4	31.5
7	4874.00	44.8 PK	74.0	-29.2	1.60 V	20	44.2	0.6
8	4874.00	32.0 AV	54.0	-22.0	1.60 V	20	31.4	0.6

REMARKS:

1. Emission Level(dBuV/m) = Raw Value(dBuV) + Correction Factor(dB/m)
2. Correction Factor(dB/m) = Antenna Factor(dB/m) + Cable Factor(dB)
3. The other emission levels were very low against the limit.
4. Margin value = Emission Level – Limit value
5. " * ": Fundamental frequency.

CHANNEL	TX Channel 9	DETECTOR FUNCTION	Peak (PK)
FREQUENCY RANGE	1GHz ~ 25GHz		Average (AV)

ANTENNA POLARITY & TEST DISTANCE: HORIZONTAL AT 3 M

NO.	FREQ. (MHz)	EMISSION LEVEL (dBuV/m)	LIMIT (dBuV/m)	MARGIN (dB)	ANTENNA HEIGHT (m)	TABLE ANGLE (Degree)	RAW VALUE (dBuV)	CORRECTION FACTOR (dB/m)
1	*2452.00	111.4 PK			1.97 H	345	80.0	31.4
2	*2452.00	101.0 AV			1.97 H	345	69.6	31.4
3	2483.50	66.1 PK	74.0	-7.9	1.56 H	353	34.6	31.5
4	2483.50	52.7 AV	54.0	-1.3	1.56 H	353	21.2	31.5
5	4904.00	43.4 PK	74.0	-30.6	1.75 H	23	42.9	0.5
6	4904.00	31.1 AV	54.0	-22.9	1.75 H	23	30.6	0.5

ANTENNA POLARITY & TEST DISTANCE: VERTICAL AT 3 M

NO.	FREQ. (MHz)	EMISSION LEVEL (dBuV/m)	LIMIT (dBuV/m)	MARGIN (dB)	ANTENNA HEIGHT (m)	TABLE ANGLE (Degree)	RAW VALUE (dBuV)	CORRECTION FACTOR (dB/m)
1	*2452.00	109.9 PK			2.08 V	343	78.5	31.4
2	*2452.00	99.8 AV			2.08 V	343	68.4	31.4
3	2483.50	66.7 PK	74.0	-7.3	1.88 V	339	35.2	31.5
4	2483.50	50.8 AV	54.0	-3.2	1.88 V	339	19.3	31.5
5	4904.00	43.6 PK	74.0	-30.4	1.70 V	26	43.1	0.5
6	4904.00	31.0 AV	54.0	-23.0	1.70 V	26	30.5	0.5

REMARKS:

1. Emission Level(dBuV/m) = Raw Value(dBuV) + Correction Factor(dB/m)
2. Correction Factor(dB/m) = Antenna Factor(dB/m) + Cable Factor(dB)
3. The other emission levels were very low against the limit.
4. Margin value = Emission Level – Limit value
5. " * " : Fundamental frequency.

Below 1GHz worst-case data:

802.11b

CHANNEL	TX Channel 6	DETECTOR FUNCTION	Quasi-Peak (QP)
FREQUENCY RANGE	30MHz ~ 1GHz		

ANTENNA POLARITY & TEST DISTANCE: HORIZONTAL AT 3 M								
NO.	FREQ. (MHz)	EMISSION LEVEL (dBuV/m)	LIMIT (dBuV/m)	MARGIN (dB)	ANTENNA HEIGHT (m)	TABLE ANGLE (Degree)	RAW VALUE (dBuV)	CORRECTION FACTOR (dB/m)
1	181.55	33.9 QP	43.5	-9.6	2.00 H	187	49.0	-15.1
2	253.49	32.3 QP	46.0	-13.7	1.00 H	313	46.2	-13.9
3	652.07	35.0 QP	46.0	-11.0	1.51 H	276	39.6	-4.6
4	731.79	41.0 QP	46.0	-5.0	1.00 H	98	43.7	-2.7
5	768.73	38.1 QP	46.0	-7.9	1.00 H	90	40.2	-2.1
6	858.17	35.2 QP	46.0	-10.8	2.00 H	255	35.8	-0.6
ANTENNA POLARITY & TEST DISTANCE: VERTICAL AT 3 M								
NO.	FREQ. (MHz)	EMISSION LEVEL (dBuV/m)	LIMIT (dBuV/m)	MARGIN (dB)	ANTENNA HEIGHT (m)	TABLE ANGLE (Degree)	RAW VALUE (dBuV)	CORRECTION FACTOR (dB/m)
1	33.79	36.0 QP	40.0	-4.0	1.00 V	220	51.9	-15.9
2	150.45	31.9 QP	43.5	-11.6	1.00 V	287	45.8	-13.9
3	245.72	30.0 QP	46.0	-16.0	1.49 V	246	44.1	-14.1
4	644.30	35.1 QP	46.0	-10.9	1.49 V	183	39.7	-4.6
5	731.79	36.9 QP	46.0	-9.1	1.49 V	254	39.6	-2.7
6	770.67	35.0 QP	46.0	-11.0	1.00 V	95	37.0	-2.0

Remarks:

1. Emission Level(dBuV/m) = Raw Value(dBuV) + Correction Factor(dB/m)
2. Correction Factor(dB/m) = Antenna Factor(dB/m) + Cable Factor(dB)
3. The other emission levels were very low against the limit.
4. Margin value = Emission Level – Limit value

Test Mode C

Above 1GHz worst-Case data:

802.11b

CHANNEL	TX Channel 1	DETECTOR FUNCTION	Peak (PK)
FREQUENCY RANGE	1GHz ~ 25GHz		Average (AV)

ANTENNA POLARITY & TEST DISTANCE: HORIZONTAL AT 3 M								
NO.	FREQ. (MHz)	EMISSION LEVEL (dBuV/m)	LIMIT (dBuV/m)	MARGIN (dB)	ANTENNA HEIGHT (m)	TABLE ANGLE (Degree)	RAW VALUE (dBuV)	CORRECTION FACTOR (dB/m)
1	2390.00	58.8 PK	74.0	-15.2	2.56 H	0	27.8	31.0
2	2390.00	49.1 AV	54.0	-4.9	2.56 H	0	18.1	31.0
3	*2412.00	116.6 PK			2.21 H	356	85.4	31.2
4	*2412.00	114.5 AV			2.21 H	356	83.3	31.2
5	4824.00	48.9 PK	74.0	-25.1	2.43 H	159	48.4	0.5
6	4824.00	41.7 AV	54.0	-12.3	2.43 H	159	41.2	0.5
ANTENNA POLARITY & TEST DISTANCE: VERTICAL AT 3 M								
NO.	FREQ. (MHz)	EMISSION LEVEL (dBuV/m)	LIMIT (dBuV/m)	MARGIN (dB)	ANTENNA HEIGHT (m)	TABLE ANGLE (Degree)	RAW VALUE (dBuV)	CORRECTION FACTOR (dB/m)
1	2390.00	59.6 PK	74.0	-14.4	1.95 V	350	28.6	31.0
2	2390.00	52.3 AV	54.0	-1.7	1.95 V	350	21.3	31.0
3	*2412.00	116.7 PK			2.12 V	4	85.5	31.2
4	*2412.00	114.5 AV			2.12 V	4	83.3	31.2
5	4824.00	50.0 PK	74.0	-24.0	2.76 V	172	49.5	0.5
6	4824.00	46.4 AV	54.0	-7.6	2.76 V	172	45.9	0.5

REMARKS:

1. Emission Level(dBuV/m) = Raw Value(dBuV) + Correction Factor(dB/m)
2. Correction Factor(dB/m) = Antenna Factor(dB/m) + Cable Factor(dB)
3. The other emission levels were very low against the limit.
4. Margin value = Emission Level – Limit value
5. " * " : Fundamental frequency.

CHANNEL	TX Channel 6	DETECTOR FUNCTION	Peak (PK)
FREQUENCY RANGE	1GHz ~ 25GHz		Average (AV)

ANTENNA POLARITY & TEST DISTANCE: HORIZONTAL AT 3 M

NO.	FREQ. (MHz)	EMISSION LEVEL (dBuV/m)	LIMIT (dBuV/m)	MARGIN (dB)	ANTENNA HEIGHT (m)	TABLE ANGLE (Degree)	RAW VALUE (dBuV)	CORRECTION FACTOR (dB/m)
1	2390.00	58.5 PK	74.0	-15.5	2.30 H	10	27.5	31.0
2	2390.00	46.3 AV	54.0	-7.7	2.30 H	10	15.3	31.0
3	*2437.00	118.4 PK			1.90 H	347	87.1	31.3
4	*2437.00	116.3 AV			1.90 H	347	85.0	31.3
5	2483.50	60.5 PK	74.0	-13.5	2.13 H	355	29.0	31.5
6	2483.50	49.5 AV	54.0	-4.5	2.13 H	355	18.0	31.5
7	4874.00	48.4 PK	74.0	-25.6	2.19 H	223	47.8	0.6
8	4874.00	40.4 AV	54.0	-13.6	2.19 H	223	39.8	0.6

ANTENNA POLARITY & TEST DISTANCE: VERTICAL AT 3 M

NO.	FREQ. (MHz)	EMISSION LEVEL (dBuV/m)	LIMIT (dBuV/m)	MARGIN (dB)	ANTENNA HEIGHT (m)	TABLE ANGLE (Degree)	RAW VALUE (dBuV)	CORRECTION FACTOR (dB/m)
1	2390.00	60.1 PK	74.0	-13.9	1.82 V	20	29.1	31.0
2	2390.00	49.7 AV	54.0	-4.3	1.82 V	20	18.7	31.0
3	*2437.00	113.1 PK			2.34 V	324	81.8	31.3
4	*2437.00	111.0 AV			2.34 V	324	79.7	31.3
5	2483.50	59.3 PK	74.0	-14.7	1.40 V	20	27.8	31.5
6	2483.50	50.9 AV	54.0	-3.1	1.40 V	20	19.4	31.5
7	4874.00	52.7 PK	74.0	-21.3	2.41 V	168	52.1	0.6
8	4874.00	48.0 AV	54.0	-6.0	2.41 V	168	47.4	0.6

REMARKS:

1. Emission Level(dBuV/m) = Raw Value(dBuV) + Correction Factor(dB/m)
2. Correction Factor(dB/m) = Antenna Factor(dB/m) + Cable Factor(dB)
3. The other emission levels were very low against the limit.
4. Margin value = Emission Level – Limit value
5. " * ": Fundamental frequency.

CHANNEL	TX Channel 11	DETECTOR FUNCTION	Peak (PK)
FREQUENCY RANGE	1GHz ~ 25GHz		Average (AV)

ANTENNA POLARITY & TEST DISTANCE: HORIZONTAL AT 3 M

NO.	FREQ. (MHz)	EMISSION LEVEL (dBuV/m)	LIMIT (dBuV/m)	MARGIN (dB)	ANTENNA HEIGHT (m)	TABLE ANGLE (Degree)	RAW VALUE (dBuV)	CORRECTION FACTOR (dB/m)
1	*2462.00	114.1 PK			2.70 H	360	82.7	31.4
2	*2462.00	112.4 AV			2.70 H	360	81.0	31.4
3	2483.50	62.1 PK	74.0	-11.9	1.48 H	355	30.6	31.5
4	2483.50	48.0 AV	54.0	-6.0	1.48 H	355	16.5	31.5
5	4924.00	45.7 PK	74.0	-28.3	2.75 H	221	45.1	0.6
6	4924.00	34.0 AV	54.0	-20.0	2.75 H	221	33.4	0.6

ANTENNA POLARITY & TEST DISTANCE: VERTICAL AT 3 M

NO.	FREQ. (MHz)	EMISSION LEVEL (dBuV/m)	LIMIT (dBuV/m)	MARGIN (dB)	ANTENNA HEIGHT (m)	TABLE ANGLE (Degree)	RAW VALUE (dBuV)	CORRECTION FACTOR (dB/m)
1	*2462.00	114.2 PK			3.57 V	20	82.8	31.4
2	*2462.00	112.0 AV			3.57 V	20	80.6	31.4
3	2483.50	59.5 PK	74.0	-14.5	2.38 V	311	28.0	31.5
4	2483.50	52.3 AV	54.0	-1.7	2.38 V	311	20.8	31.5
5	4924.00	47.5 PK	74.0	-26.5	3.70 V	214	46.9	0.6
6	4924.00	37.7 AV	54.0	-16.3	3.70 V	214	37.1	0.6

REMARKS:

1. Emission Level(dBuV/m) = Raw Value(dBuV) + Correction Factor(dB/m)
2. Correction Factor(dB/m) = Antenna Factor(dB/m) + Cable Factor(dB)
3. The other emission levels were very low against the limit.
4. Margin value = Emission Level – Limit value
5. " * " : Fundamental frequency.

802.11g

CHANNEL	TX Channel 1	DETECTOR FUNCTION	Peak (PK)
FREQUENCY RANGE	1GHz ~ 25GHz		Average (AV)

ANTENNA POLARITY & TEST DISTANCE: HORIZONTAL AT 3 M

NO.	FREQ. (MHz)	EMISSION LEVEL (dBuV/m)	LIMIT (dBuV/m)	MARGIN (dB)	ANTENNA HEIGHT (m)	TABLE ANGLE (Degree)	RAW VALUE (dBuV)	CORRECTION FACTOR (dB/m)
1	2390.00	64.8 PK	74.0	-9.2	1.60 H	0	33.8	31.0
2	2390.00	52.4 AV	54.0	-1.6	1.60 H	0	21.4	31.0
3	*2412.00	117.6 PK			1.71 H	349	86.4	31.2
4	*2412.00	107.3 AV			1.71 H	349	76.1	31.2
5	4824.00	46.5 PK	74.0	-27.5	1.51 H	277	46.0	0.5
6	4824.00	36.0 AV	54.0	-18.0	1.51 H	277	35.5	0.5

ANTENNA POLARITY & TEST DISTANCE: VERTICAL AT 3 M

NO.	FREQ. (MHz)	EMISSION LEVEL (dBuV/m)	LIMIT (dBuV/m)	MARGIN (dB)	ANTENNA HEIGHT (m)	TABLE ANGLE (Degree)	RAW VALUE (dBuV)	CORRECTION FACTOR (dB/m)
1	2390.00	66.5 PK	74.0	-7.5	1.86 V	352	35.5	31.0
2	2390.00	53.0 AV	54.0	-1.0	1.86 V	352	22.0	31.0
3	*2412.00	118.7 PK			1.72 V	345	87.5	31.2
4	*2412.00	108.1 AV			1.72 V	345	76.9	31.2
5	4824.00	45.6 PK	74.0	-28.4	1.99 V	0	45.1	0.5
6	4824.00	34.1 AV	54.0	-19.9	1.99 V	0	33.6	0.5

REMARKS:

1. Emission Level(dBuV/m) = Raw Value(dBuV) + Correction Factor(dB/m)
2. Correction Factor(dB/m) = Antenna Factor(dB/m) + Cable Factor(dB)
3. The other emission levels were very low against the limit.
4. Margin value = Emission Level – Limit value
5. " * " : Fundamental frequency.

CHANNEL	TX Channel 6	DETECTOR FUNCTION	Peak (PK)
FREQUENCY RANGE	1GHz ~ 25GHz		Average (AV)

ANTENNA POLARITY & TEST DISTANCE: HORIZONTAL AT 3 M

NO.	FREQ. (MHz)	EMISSION LEVEL (dBuV/m)	LIMIT (dBuV/m)	MARGIN (dB)	ANTENNA HEIGHT (m)	TABLE ANGLE (Degree)	RAW VALUE (dBuV)	CORRECTION FACTOR (dB/m)
1	2390.00	61.6 PK	74.0	-12.4	1.44 H	325	30.6	31.0
2	2390.00	49.2 AV	54.0	-4.8	1.44 H	325	18.2	31.0
3	*2437.00	121.2 PK			1.74 H	351	89.9	31.3
4	*2437.00	111.6 AV			1.74 H	351	80.3	31.3
5	2483.50	63.1 PK	74.0	-10.9	1.51 H	321	31.6	31.5
6	2483.50	50.8 AV	54.0	-3.2	1.51 H	321	19.3	31.5
7	4874.00	44.7 PK	74.0	-29.3	1.98 H	24	44.1	0.6
8	4874.00	34.5 AV	54.0	-19.5	1.98 H	24	33.9	0.6

ANTENNA POLARITY & TEST DISTANCE: VERTICAL AT 3 M

NO.	FREQ. (MHz)	EMISSION LEVEL (dBuV/m)	LIMIT (dBuV/m)	MARGIN (dB)	ANTENNA HEIGHT (m)	TABLE ANGLE (Degree)	RAW VALUE (dBuV)	CORRECTION FACTOR (dB/m)
1	2390.00	65.9 PK	74.0	-8.1	1.86 V	327	34.9	31.0
2	2390.00	52.4 AV	54.0	-1.6	1.86 V	327	21.4	31.0
3	*2437.00	122.1 PK			1.89 V	340	90.8	31.3
4	*2437.00	111.9 AV			1.89 V	340	80.6	31.3
5	2483.50	65.2 PK	74.0	-8.8	1.78 V	4	33.7	31.5
6	2483.50	52.2 AV	54.0	-1.8	1.78 V	4	20.7	31.5
7	4874.00	48.3 PK	74.0	-25.7	2.30 V	257	47.7	0.6
8	4874.00	36.1 AV	54.0	-17.9	2.30 V	257	35.5	0.6

REMARKS:

1. Emission Level(dBuV/m) = Raw Value(dBuV) + Correction Factor(dB/m)
2. Correction Factor(dB/m) = Antenna Factor(dB/m) + Cable Factor(dB)
3. The other emission levels were very low against the limit.
4. Margin value = Emission Level – Limit value
5. " * ": Fundamental frequency.

CHANNEL	TX Channel 11	DETECTOR FUNCTION	Peak (PK)
FREQUENCY RANGE	1GHz ~ 25GHz		Average (AV)

ANTENNA POLARITY & TEST DISTANCE: HORIZONTAL AT 3 M

NO.	FREQ. (MHz)	EMISSION LEVEL (dBuV/m)	LIMIT (dBuV/m)	MARGIN (dB)	ANTENNA HEIGHT (m)	TABLE ANGLE (Degree)	RAW VALUE (dBuV)	CORRECTION FACTOR (dB/m)
1	*2462.00	117.0 PK			1.71 H	351	85.6	31.4
2	*2462.00	106.6 AV			1.71 H	351	75.2	31.4
3	2483.50	66.4 PK	74.0	-7.6	1.59 H	333	34.9	31.5
4	2483.50	52.5 AV	54.0	-1.5	1.59 H	333	21.0	31.5
5	4924.00	42.8 PK	74.0	-31.2	2.00 H	268	42.2	0.6
6	4924.00	32.8 AV	54.0	-21.2	2.00 H	268	32.2	0.6

ANTENNA POLARITY & TEST DISTANCE: VERTICAL AT 3 M

NO.	FREQ. (MHz)	EMISSION LEVEL (dBuV/m)	LIMIT (dBuV/m)	MARGIN (dB)	ANTENNA HEIGHT (m)	TABLE ANGLE (Degree)	RAW VALUE (dBuV)	CORRECTION FACTOR (dB/m)
1	*2462.00	117.7 PK			1.70 V	350	86.3	31.4
2	*2462.00	106.9 AV			1.70 V	350	75.5	31.4
3	2483.50	66.2 PK	74.0	-7.8	1.64 V	354	34.7	31.5
4	2483.50	52.5 AV	54.0	-1.5	1.64 V	354	21.0	31.5
5	4924.00	46.7 PK	74.0	-27.3	2.02 V	320	46.1	0.6
6	4924.00	34.3 AV	54.0	-19.7	2.02 V	320	33.7	0.6

REMARKS:

1. Emission Level(dBuV/m) = Raw Value(dBuV) + Correction Factor(dB/m)
2. Correction Factor(dB/m) = Antenna Factor(dB/m) + Cable Factor(dB)
3. The other emission levels were very low against the limit.
4. Margin value = Emission Level – Limit value
5. " * " : Fundamental frequency.

802.11n (HT20)

CHANNEL	TX Channel 1	DETECTOR FUNCTION	Peak (PK)
FREQUENCY RANGE	1GHz ~ 25GHz		Average (AV)

ANTENNA POLARITY & TEST DISTANCE: HORIZONTAL AT 3 M

NO.	FREQ. (MHz)	EMISSION LEVEL (dBuV/m)	LIMIT (dBuV/m)	MARGIN (dB)	ANTENNA HEIGHT (m)	TABLE ANGLE (Degree)	RAW VALUE (dBuV)	CORRECTION FACTOR (dB/m)
1	2390.00	64.6 PK	74.0	-9.4	1.85 H	354	33.6	31.0
2	2390.00	50.5 AV	54.0	-3.5	1.85 H	354	19.5	31.0
3	*2412.00	117.1 PK			1.74 H	348	85.9	31.2
4	*2412.00	107.6 AV			1.74 H	348	76.4	31.2
5	4824.00	45.1 PK	74.0	-28.9	1.86 H	230	44.6	0.5
6	4824.00	34.8 AV	54.0	-19.2	1.86 H	230	34.3	0.5

ANTENNA POLARITY & TEST DISTANCE: VERTICAL AT 3 M

NO.	FREQ. (MHz)	EMISSION LEVEL (dBuV/m)	LIMIT (dBuV/m)	MARGIN (dB)	ANTENNA HEIGHT (m)	TABLE ANGLE (Degree)	RAW VALUE (dBuV)	CORRECTION FACTOR (dB/m)
1	2390.00	65.8 PK	74.0	-8.2	1.86 V	341	34.8	31.0
2	2390.00	52.5 AV	54.0	-1.5	1.86 V	341	21.5	31.0
3	*2412.00	119.0 PK			1.73 V	346	87.8	31.2
4	*2412.00	107.9 AV			1.73 V	346	76.7	31.2
5	4824.00	45.4 PK	74.0	-28.6	1.89 V	123	44.9	0.5
6	4824.00	34.4 AV	54.0	-19.6	1.89 V	123	33.9	0.5

REMARKS:

1. Emission Level(dBuV/m) = Raw Value(dBuV) + Correction Factor(dB/m)
2. Correction Factor(dB/m) = Antenna Factor(dB/m) + Cable Factor(dB)
3. The other emission levels were very low against the limit.
4. Margin value = Emission Level – Limit value
5. " * " : Fundamental frequency.

CHANNEL	TX Channel 6	DETECTOR FUNCTION	Peak (PK)
FREQUENCY RANGE	1GHz ~ 25GHz		Average (AV)

ANTENNA POLARITY & TEST DISTANCE: HORIZONTAL AT 3 M

NO.	FREQ. (MHz)	EMISSION LEVEL (dBuV/m)	LIMIT (dBuV/m)	MARGIN (dB)	ANTENNA HEIGHT (m)	TABLE ANGLE (Degree)	RAW VALUE (dBuV)	CORRECTION FACTOR (dB/m)
1	2390.00	62.2 PK	74.0	-11.8	2.05 H	354	31.2	31.0
2	2390.00	49.8 AV	54.0	-4.2	2.05 H	354	18.8	31.0
3	*2437.00	121.0 PK			1.84 H	349	89.7	31.3
4	*2437.00	111.2 AV			1.84 H	349	79.9	31.3
5	2483.50	64.9 PK	74.0	-9.1	1.59 H	335	33.4	31.5
6	2483.50	51.3 AV	54.0	-2.7	1.59 H	335	19.8	31.5
7	4874.00	45.8 PK	74.0	-28.2	1.95 H	222	45.2	0.6
8	4874.00	35.5 AV	54.0	-18.5	1.95 H	222	34.9	0.6

ANTENNA POLARITY & TEST DISTANCE: VERTICAL AT 3 M

NO.	FREQ. (MHz)	EMISSION LEVEL (dBuV/m)	LIMIT (dBuV/m)	MARGIN (dB)	ANTENNA HEIGHT (m)	TABLE ANGLE (Degree)	RAW VALUE (dBuV)	CORRECTION FACTOR (dB/m)
1	2390.00	64.6 PK	74.0	-9.4	1.87 V	328	33.6	31.0
2	2390.00	52.3 AV	54.0	-1.7	1.87 V	328	21.3	31.0
3	*2437.00	120.9 PK			1.89 V	340	89.6	31.3
4	*2437.00	111.1 AV			1.89 V	340	79.8	31.3
5	2483.50	64.0 PK	74.0	-10.0	1.81 V	10	32.5	31.5
6	2483.50	50.0 AV	54.0	-4.0	1.81 V	10	18.5	31.5
7	4874.00	48.6 PK	74.0	-25.4	2.31 V	260	48.0	0.6
8	4874.00	36.7 AV	54.0	-17.3	2.31 V	260	36.1	0.6

REMARKS:

1. Emission Level(dBuV/m) = Raw Value(dBuV) + Correction Factor(dB/m)
2. Correction Factor(dB/m) = Antenna Factor(dB/m) + Cable Factor(dB)
3. The other emission levels were very low against the limit.
4. Margin value = Emission Level – Limit value
5. " * ": Fundamental frequency.

CHANNEL	TX Channel 11	DETECTOR FUNCTION	Peak (PK)
FREQUENCY RANGE	1GHz ~ 25GHz		Average (AV)

ANTENNA POLARITY & TEST DISTANCE: HORIZONTAL AT 3 M

NO.	FREQ. (MHz)	EMISSION LEVEL (dBuV/m)	LIMIT (dBuV/m)	MARGIN (dB)	ANTENNA HEIGHT (m)	TABLE ANGLE (Degree)	RAW VALUE (dBuV)	CORRECTION FACTOR (dB/m)
1	*2462.00	116.1 PK			1.73 H	348	84.7	31.4
2	*2462.00	106.3 AV			1.73 H	348	74.9	31.4
3	2483.50	65.4 PK	74.0	-8.6	1.57 H	337	33.9	31.5
4	2483.50	52.4 AV	54.0	-1.6	1.57 H	337	20.9	31.5
5	4924.00	43.7 PK	74.0	-30.3	2.00 H	190	43.1	0.6
6	4924.00	33.7 AV	54.0	-20.3	2.00 H	190	33.1	0.6

ANTENNA POLARITY & TEST DISTANCE: VERTICAL AT 3 M

NO.	FREQ. (MHz)	EMISSION LEVEL (dBuV/m)	LIMIT (dBuV/m)	MARGIN (dB)	ANTENNA HEIGHT (m)	TABLE ANGLE (Degree)	RAW VALUE (dBuV)	CORRECTION FACTOR (dB/m)
1	*2462.00	118.1 PK			1.69 V	342	86.7	31.4
2	*2462.00	107.1 AV			1.69 V	342	75.7	31.4
3	2483.50	65.3 PK	74.0	-8.7	1.68 V	357	33.8	31.5
4	2483.50	51.0 AV	54.0	-3.0	1.68 V	357	19.5	31.5
5	4924.00	48.0 PK	74.0	-26.0	2.11 V	315	47.4	0.6
6	4924.00	36.0 AV	54.0	-18.0	2.11 V	315	35.4	0.6

REMARKS:

1. Emission Level(dBuV/m) = Raw Value(dBuV) + Correction Factor(dB/m)
2. Correction Factor(dB/m) = Antenna Factor(dB/m) + Cable Factor(dB)
3. The other emission levels were very low against the limit.
4. Margin value = Emission Level – Limit value
5. " * " : Fundamental frequency.

802.11n (HT40)

CHANNEL	TX Channel 3	DETECTOR FUNCTION	Peak (PK)
FREQUENCY RANGE	1GHz ~ 25GHz		Average (AV)

ANTENNA POLARITY & TEST DISTANCE: HORIZONTAL AT 3 M

NO.	FREQ. (MHz)	EMISSION LEVEL (dBuV/m)	LIMIT (dBuV/m)	MARGIN (dB)	ANTENNA HEIGHT (m)	TABLE ANGLE (Degree)	RAW VALUE (dBuV)	CORRECTION FACTOR (dB/m)
1	2390.00	68.3 PK	74.0	-5.7	1.45 H	343	37.3	31.0
2	2390.00	52.4 AV	54.0	-1.6	1.45 H	343	21.4	31.0
3	*2422.00	111.5 PK			1.92 H	350	80.3	31.2
4	*2422.00	101.5 AV			1.92 H	350	70.3	31.2
5	4844.00	44.4 PK	74.0	-29.6	2.08 H	236	44.0	0.4
6	4844.00	33.1 AV	54.0	-20.9	2.08 H	236	32.7	0.4

ANTENNA POLARITY & TEST DISTANCE: VERTICAL AT 3 M

NO.	FREQ. (MHz)	EMISSION LEVEL (dBuV/m)	LIMIT (dBuV/m)	MARGIN (dB)	ANTENNA HEIGHT (m)	TABLE ANGLE (Degree)	RAW VALUE (dBuV)	CORRECTION FACTOR (dB/m)
1	2390.00	62.3 PK	74.0	-11.7	1.79 V	310	31.3	31.0
2	2390.00	50.6 AV	54.0	-3.4	1.79 V	310	19.6	31.0
3	*2422.00	111.9 PK			1.88 V	338	80.7	31.2
4	*2422.00	102.1 AV			1.88 V	338	70.9	31.2
5	4844.00	44.1 PK	74.0	-29.9	2.42 V	255	43.7	0.4
6	4844.00	32.7 AV	54.0	-21.3	2.42 V	255	32.3	0.4

REMARKS:

1. Emission Level(dBuV/m) = Raw Value(dBuV) + Correction Factor(dB/m)
2. Correction Factor(dB/m) = Antenna Factor(dB/m) + Cable Factor(dB)
3. The other emission levels were very low against the limit.
4. Margin value = Emission Level – Limit value
5. " * " : Fundamental frequency.

CHANNEL	TX Channel 6	DETECTOR FUNCTION	Peak (PK)
FREQUENCY RANGE	1GHz ~ 25GHz		Average (AV)

ANTENNA POLARITY & TEST DISTANCE: HORIZONTAL AT 3 M

NO.	FREQ. (MHz)	EMISSION LEVEL (dBuV/m)	LIMIT (dBuV/m)	MARGIN (dB)	ANTENNA HEIGHT (m)	TABLE ANGLE (Degree)	RAW VALUE (dBuV)	CORRECTION FACTOR (dB/m)
1	2390.00	61.4 PK	74.0	-12.6	2.07 H	7	30.4	31.0
2	2390.00	50.4 AV	54.0	-3.6	2.07 H	7	19.4	31.0
3	*2437.00	114.1 PK			1.80 H	351	82.8	31.3
4	*2437.00	104.2 AV			1.80 H	351	72.9	31.3
5	2483.50	63.6 PK	74.0	-10.4	1.84 H	7	32.1	31.5
6	2483.50	52.1 AV	54.0	-1.9	1.84 H	7	20.6	31.5
7	4874.00	43.5 PK	74.0	-30.5	1.48 H	255	42.9	0.6
8	4874.00	34.3 AV	54.0	-19.7	1.48 H	255	33.7	0.6

ANTENNA POLARITY & TEST DISTANCE: VERTICAL AT 3 M

NO.	FREQ. (MHz)	EMISSION LEVEL (dBuV/m)	LIMIT (dBuV/m)	MARGIN (dB)	ANTENNA HEIGHT (m)	TABLE ANGLE (Degree)	RAW VALUE (dBuV)	CORRECTION FACTOR (dB/m)
1	2390.00	62.7 PK	74.0	-11.3	1.90 V	322	31.7	31.0
2	2390.00	49.5 AV	54.0	-4.5	1.90 V	322	18.5	31.0
3	*2437.00	114.4 PK			1.87 V	336	83.1	31.3
4	*2437.00	104.6 AV			1.87 V	336	73.3	31.3
5	2483.50	67.0 PK	74.0	-7.0	1.76 V	13	35.5	31.5
6	2483.50	52.3 AV	54.0	-1.7	1.76 V	13	20.8	31.5
7	4874.00	44.1 PK	74.0	-29.9	2.22 V	229	43.5	0.6
8	4874.00	32.9 AV	54.0	-21.1	2.22 V	229	32.3	0.6

REMARKS:

1. Emission Level(dBuV/m) = Raw Value(dBuV) + Correction Factor(dB/m)
2. Correction Factor(dB/m) = Antenna Factor(dB/m) + Cable Factor(dB)
3. The other emission levels were very low against the limit.
4. Margin value = Emission Level – Limit value
5. " * ": Fundamental frequency.

CHANNEL	TX Channel 9	DETECTOR FUNCTION	Peak (PK)
FREQUENCY RANGE	1GHz ~ 25GHz		Average (AV)

ANTENNA POLARITY & TEST DISTANCE: HORIZONTAL AT 3 M

NO.	FREQ. (MHz)	EMISSION LEVEL (dBuV/m)	LIMIT (dBuV/m)	MARGIN (dB)	ANTENNA HEIGHT (m)	TABLE ANGLE (Degree)	RAW VALUE (dBuV)	CORRECTION FACTOR (dB/m)
1	*2452.00	110.9 PK			1.76 H	348	79.5	31.4
2	*2452.00	101.1 AV			1.76 H	348	69.7	31.4
3	2483.50	65.2 PK	74.0	-8.8	1.71 H	359	33.7	31.5
4	2483.50	51.9 AV	54.0	-2.1	1.71 H	359	20.4	31.5
5	4904.00	43.4 PK	74.0	-30.6	1.50 H	320	42.9	0.5
6	4904.00	32.4 AV	54.0	-21.6	1.50 H	320	31.9	0.5

ANTENNA POLARITY & TEST DISTANCE: VERTICAL AT 3 M

NO.	FREQ. (MHz)	EMISSION LEVEL (dBuV/m)	LIMIT (dBuV/m)	MARGIN (dB)	ANTENNA HEIGHT (m)	TABLE ANGLE (Degree)	RAW VALUE (dBuV)	CORRECTION FACTOR (dB/m)
1	*2452.00	111.2 PK			2.04 V	329	79.8	31.4
2	*2452.00	101.0 AV			2.04 V	329	69.6	31.4
3	2483.50	68.6 PK	74.0	-5.4	1.96 V	324	37.1	31.5
4	2483.50	52.3 AV	54.0	-1.7	1.96 V	324	20.8	31.5
5	4904.00	43.9 PK	74.0	-30.1	1.90 V	240	43.4	0.5
6	4904.00	33.3 AV	54.0	-20.7	1.90 V	240	32.8	0.5

REMARKS:

1. Emission Level(dBuV/m) = Raw Value(dBuV) + Correction Factor(dB/m)
2. Correction Factor(dB/m) = Antenna Factor(dB/m) + Cable Factor(dB)
3. The other emission levels were very low against the limit.
4. Margin value = Emission Level – Limit value
5. " * " : Fundamental frequency.

Below 1GHz worst-case data:

802.11b

CHANNEL	TX Channel 6	DETECTOR FUNCTION	Quasi-Peak (QP)
FREQUENCY RANGE	30MHz ~ 1GHz		

ANTENNA POLARITY & TEST DISTANCE: HORIZONTAL AT 3 M

NO.	FREQ. (MHz)	EMISSION LEVEL (dBuV/m)	LIMIT (dBuV/m)	MARGIN (dB)	ANTENNA HEIGHT (m)	TABLE ANGLE (Degree)	RAW VALUE (dBuV)	CORRECTION FACTOR (dB/m)
1	57.12	26.3 QP	40.0	-13.7	2.00 H	87	40.9	-14.6
2	179.61	34.4 QP	43.5	-9.1	2.00 H	201	49.3	-14.9
3	259.33	32.6 QP	46.0	-13.4	1.00 H	304	46.2	-13.6
4	729.84	40.5 QP	46.0	-5.5	1.00 H	93	43.3	-2.8
5	776.51	37.1 QP	46.0	-8.9	1.00 H	79	38.8	-1.7
6	817.34	35.5 QP	46.0	-10.5	1.00 H	38	36.6	-1.1

ANTENNA POLARITY & TEST DISTANCE: VERTICAL AT 3 M

NO.	FREQ. (MHz)	EMISSION LEVEL (dBuV/m)	LIMIT (dBuV/m)	MARGIN (dB)	ANTENNA HEIGHT (m)	TABLE ANGLE (Degree)	RAW VALUE (dBuV)	CORRECTION FACTOR (dB/m)
1	33.79	35.5 QP	40.0	-4.5	1.00 V	191	51.4	-15.9
2	152.39	31.3 QP	43.5	-12.2	1.00 V	302	45.1	-13.8
3	251.55	29.4 QP	46.0	-16.6	1.00 V	258	43.3	-13.9
4	690.96	35.4 QP	46.0	-10.6	1.50 V	82	39.1	-3.7
5	727.90	35.3 QP	46.0	-10.7	1.50 V	82	38.2	-2.9
6	830.95	33.7 QP	46.0	-12.3	1.00 V	91	34.7	-1.0

Remarks:

1. Emission Level(dBuV/m) = Raw Value(dBuV) + Correction Factor(dB/m)
2. Correction Factor(dB/m) = Antenna Factor(dB/m) + Cable Factor(dB)
3. The other emission levels were very low against the limit.
4. Margin value = Emission Level – Limit value

Test Mode D

Above 1GHz worst-Case data:

802.11b

CHANNEL	TX Channel 1	DETECTOR FUNCTION	Peak (PK)
FREQUENCY RANGE	1GHz ~ 25GHz		Average (AV)

ANTENNA POLARITY & TEST DISTANCE: HORIZONTAL AT 3 M								
NO.	FREQ. (MHz)	EMISSION LEVEL (dBuV/m)	LIMIT (dBuV/m)	MARGIN (dB)	ANTENNA HEIGHT (m)	TABLE ANGLE (Degree)	RAW VALUE (dBuV)	CORRECTION FACTOR (dB/m)
1	2390.00	59.1 PK	74.0	-14.9	1.61 H	344	28.1	31.0
2	2390.00	49.0 AV	54.0	-5.0	1.61 H	344	18.0	31.0
3	*2412.00	118.5 PK			1.61 H	345	87.3	31.2
4	*2412.00	116.2 AV			1.61 H	345	85.0	31.2
5	4824.00	45.9 PK	74.0	-28.1	2.74 H	158	45.4	0.5
6	4824.00	36.3 AV	54.0	-17.7	2.74 H	158	35.8	0.5
ANTENNA POLARITY & TEST DISTANCE: VERTICAL AT 3 M								
NO.	FREQ. (MHz)	EMISSION LEVEL (dBuV/m)	LIMIT (dBuV/m)	MARGIN (dB)	ANTENNA HEIGHT (m)	TABLE ANGLE (Degree)	RAW VALUE (dBuV)	CORRECTION FACTOR (dB/m)
1	2390.00	64.1 PK	74.0	-9.9	1.76 V	339	33.1	31.0
2	2390.00	48.9 AV	54.0	-5.1	1.76 V	339	17.9	31.0
3	*2412.00	119.3 PK			1.76 V	342	88.1	31.2
4	*2412.00	117.3 AV			1.76 V	342	86.1	31.2
5	4824.00	47.6 PK	74.0	-26.4	2.66 V	89	47.1	0.5
6	4824.00	39.7 AV	54.0	-14.3	2.66 V	89	39.2	0.5

REMARKS:

1. Emission Level(dBuV/m) = Raw Value(dBuV) + Correction Factor(dB/m)
2. Correction Factor(dB/m) = Antenna Factor(dB/m) + Cable Factor(dB)
3. The other emission levels were very low against the limit.
4. Margin value = Emission Level – Limit value
5. " * " : Fundamental frequency.

CHANNEL	TX Channel 6	DETECTOR FUNCTION	Peak (PK)
FREQUENCY RANGE	1GHz ~ 25GHz		Average (AV)

ANTENNA POLARITY & TEST DISTANCE: HORIZONTAL AT 3 M

NO.	FREQ. (MHz)	EMISSION LEVEL (dBuV/m)	LIMIT (dBuV/m)	MARGIN (dB)	ANTENNA HEIGHT (m)	TABLE ANGLE (Degree)	RAW VALUE (dBuV)	CORRECTION FACTOR (dB/m)
1	*2437.00	118.1 PK			1.56 H	345	86.8	31.3
2	*2437.00	116.2 AV			1.56 H	345	84.9	31.3
3	2483.50	58.9 PK	74.0	-15.1	1.71 H	350	27.4	31.5
4	2483.50	48.3 AV	54.0	-5.7	1.71 H	350	16.8	31.5
5	4874.00	45.6 PK	74.0	-28.4	2.52 H	123	45.0	0.6
6	4874.00	35.6 AV	54.0	-18.4	2.52 H	123	35.0	0.6

ANTENNA POLARITY & TEST DISTANCE: VERTICAL AT 3 M

NO.	FREQ. (MHz)	EMISSION LEVEL (dBuV/m)	LIMIT (dBuV/m)	MARGIN (dB)	ANTENNA HEIGHT (m)	TABLE ANGLE (Degree)	RAW VALUE (dBuV)	CORRECTION FACTOR (dB/m)
1	*2437.00	119.4 PK			1.80 V	342	88.1	31.3
2	*2437.00	117.1 AV			1.80 V	342	85.8	31.3
3	2483.50	64.3 PK	74.0	-9.7	1.72 V	347	32.8	31.5
4	2483.50	50.6 AV	54.0	-3.4	1.72 V	347	19.1	31.5
5	4874.00	48.1 PK	74.0	-25.9	2.87 V	90	47.5	0.6
6	4874.00	40.5 AV	54.0	-13.5	2.87 V	90	39.9	0.6

REMARKS:

1. Emission Level(dBuV/m) = Raw Value(dBuV) + Correction Factor(dB/m)
2. Correction Factor(dB/m) = Antenna Factor(dB/m) + Cable Factor(dB)
3. The other emission levels were very low against the limit.
4. Margin value = Emission Level – Limit value
5. " * " : Fundamental frequency.

CHANNEL	TX Channel 11	DETECTOR FUNCTION	Peak (PK)
FREQUENCY RANGE	1GHz ~ 25GHz		Average (AV)

ANTENNA POLARITY & TEST DISTANCE: HORIZONTAL AT 3 M

NO.	FREQ. (MHz)	EMISSION LEVEL (dBuV/m)	LIMIT (dBuV/m)	MARGIN (dB)	ANTENNA HEIGHT (m)	TABLE ANGLE (Degree)	RAW VALUE (dBuV)	CORRECTION FACTOR (dB/m)
1	*2462.00	117.8 PK			1.70 H	350	86.4	31.4
2	*2462.00	115.8 AV			1.70 H	350	84.4	31.4
3	2483.50	59.4 PK	74.0	-14.6	1.52 H	352	27.9	31.5
4	2483.50	49.7 AV	54.0	-4.3	1.52 H	352	18.2	31.5
5	4924.00	45.1 PK	74.0	-28.9	2.73 H	120	44.5	0.6
6	4924.00	34.0 AV	54.0	-20.0	2.73 H	120	33.4	0.6

ANTENNA POLARITY & TEST DISTANCE: VERTICAL AT 3 M

NO.	FREQ. (MHz)	EMISSION LEVEL (dBuV/m)	LIMIT (dBuV/m)	MARGIN (dB)	ANTENNA HEIGHT (m)	TABLE ANGLE (Degree)	RAW VALUE (dBuV)	CORRECTION FACTOR (dB/m)
1	*2462.00	120.2 PK			1.82 V	345	88.8	31.4
2	*2462.00	117.8 AV			1.82 V	345	86.4	31.4
3	2483.50	67.0 PK	74.0	-7.0	1.91 V	353	35.5	31.5
4	2483.50	51.7 AV	54.0	-2.3	1.91 V	353	20.2	31.5
5	4924.00	50.7 PK	74.0	-23.3	2.96 V	86	50.1	0.6
6	4924.00	36.5 AV	54.0	-17.5	2.96 V	86	35.9	0.6

REMARKS:

1. Emission Level(dBuV/m) = Raw Value(dBuV) + Correction Factor(dB/m)
2. Correction Factor(dB/m) = Antenna Factor(dB/m) + Cable Factor(dB)
3. The other emission levels were very low against the limit.
4. Margin value = Emission Level – Limit value
5. " * " : Fundamental frequency.

802.11g

CHANNEL	TX Channel 1	DETECTOR FUNCTION	Peak (PK)
FREQUENCY RANGE	1GHz ~ 25GHz		Average (AV)

ANTENNA POLARITY & TEST DISTANCE: HORIZONTAL AT 3 M

NO.	FREQ. (MHz)	EMISSION LEVEL (dBuV/m)	LIMIT (dBuV/m)	MARGIN (dB)	ANTENNA HEIGHT (m)	TABLE ANGLE (Degree)	RAW VALUE (dBuV)	CORRECTION FACTOR (dB/m)
1	2390.00	64.6 PK	74.0	-9.4	1.64 H	345	33.6	31.0
2	2390.00	52.1 AV	54.0	-1.9	1.64 H	345	21.1	31.0
3	*2412.00	117.6 PK			1.56 H	350	86.4	31.2
4	*2412.00	107.1 AV			1.56 H	350	75.9	31.2
5	4824.00	44.0 PK	74.0	-30.0	1.57 H	273	43.5	0.5
6	4824.00	30.9 AV	54.0	-23.1	1.57 H	273	30.4	0.5

ANTENNA POLARITY & TEST DISTANCE: VERTICAL AT 3 M

NO.	FREQ. (MHz)	EMISSION LEVEL (dBuV/m)	LIMIT (dBuV/m)	MARGIN (dB)	ANTENNA HEIGHT (m)	TABLE ANGLE (Degree)	RAW VALUE (dBuV)	CORRECTION FACTOR (dB/m)
1	2390.00	65.1 PK	74.0	-8.9	1.52 V	347	34.1	31.0
2	2390.00	51.1 AV	54.0	-2.9	1.52 V	347	20.1	31.0
3	*2412.00	119.9 PK			1.75 V	349	88.7	31.2
4	*2412.00	109.0 AV			1.75 V	349	77.8	31.2
5	4824.00	44.1 PK	74.0	-29.9	1.57 V	257	43.6	0.5
6	4824.00	31.3 AV	54.0	-22.7	1.57 V	257	30.8	0.5

REMARKS:

1. Emission Level(dBuV/m) = Raw Value(dBuV) + Correction Factor(dB/m)
2. Correction Factor(dB/m) = Antenna Factor(dB/m) + Cable Factor(dB)
3. The other emission levels were very low against the limit.
4. Margin value = Emission Level – Limit value
5. " * " : Fundamental frequency.

CHANNEL	TX Channel 6	DETECTOR FUNCTION	Peak (PK)
FREQUENCY RANGE	1GHz ~ 25GHz		Average (AV)

ANTENNA POLARITY & TEST DISTANCE: HORIZONTAL AT 3 M

NO.	FREQ. (MHz)	EMISSION LEVEL (dBuV/m)	LIMIT (dBuV/m)	MARGIN (dB)	ANTENNA HEIGHT (m)	TABLE ANGLE (Degree)	RAW VALUE (dBuV)	CORRECTION FACTOR (dB/m)
1	*2437.00	120.1 PK			1.50 H	345	88.8	31.3
2	*2437.00	109.9 AV			1.50 H	345	78.6	31.3
3	2483.50	62.2 PK	74.0	-11.8	1.56 H	339	30.7	31.5
4	2483.50	51.3 AV	54.0	-2.7	1.56 H	339	19.8	31.5
5	4874.00	49.4 PK	74.0	-24.6	1.60 H	299	48.8	0.6
6	4874.00	40.1 AV	54.0	-13.9	1.60 H	299	39.5	0.6

ANTENNA POLARITY & TEST DISTANCE: VERTICAL AT 3 M

NO.	FREQ. (MHz)	EMISSION LEVEL (dBuV/m)	LIMIT (dBuV/m)	MARGIN (dB)	ANTENNA HEIGHT (m)	TABLE ANGLE (Degree)	RAW VALUE (dBuV)	CORRECTION FACTOR (dB/m)
1	*2437.00	120.4 PK			1.42 V	338	89.1	31.3
2	*2437.00	109.5 AV			1.42 V	338	78.2	31.3
3	2483.50	62.9 PK	74.0	-11.1	1.96 V	338	31.4	31.5
4	2483.50	48.7 AV	54.0	-5.3	1.96 V	338	17.2	31.5
5	4874.00	44.4 PK	74.0	-29.6	1.53 V	267	43.8	0.6
6	4874.00	31.2 AV	54.0	-22.8	1.53 V	267	30.6	0.6

REMARKS:

1. Emission Level(dBuV/m) = Raw Value(dBuV) + Correction Factor(dB/m)
2. Correction Factor(dB/m) = Antenna Factor(dB/m) + Cable Factor(dB)
3. The other emission levels were very low against the limit.
4. Margin value = Emission Level – Limit value
5. " * " : Fundamental frequency.

CHANNEL	TX Channel 11	DETECTOR FUNCTION	Peak (PK)
FREQUENCY RANGE	1GHz ~ 25GHz		Average (AV)

ANTENNA POLARITY & TEST DISTANCE: HORIZONTAL AT 3 M

NO.	FREQ. (MHz)	EMISSION LEVEL (dBuV/m)	LIMIT (dBuV/m)	MARGIN (dB)	ANTENNA HEIGHT (m)	TABLE ANGLE (Degree)	RAW VALUE (dBuV)	CORRECTION FACTOR (dB/m)
1	*2462.00	117.0 PK			1.58 H	349	85.6	31.4
2	*2462.00	107.0 AV			1.58 H	349	75.6	31.4
3	2483.50	70.0 PK	74.0	-4.0	1.60 H	5	38.5	31.5
4	2483.50	53.0 AV	54.0	-1.0	1.60 H	5	21.5	31.5
5	4924.00	45.7 PK	74.0	-28.3	1.70 H	23	45.1	0.6
6	4924.00	36.1 AV	54.0	-17.9	1.70 H	23	35.5	0.6

ANTENNA POLARITY & TEST DISTANCE: VERTICAL AT 3 M

NO.	FREQ. (MHz)	EMISSION LEVEL (dBuV/m)	LIMIT (dBuV/m)	MARGIN (dB)	ANTENNA HEIGHT (m)	TABLE ANGLE (Degree)	RAW VALUE (dBuV)	CORRECTION FACTOR (dB/m)
1	*2462.00	118.2 PK			1.96 V	355	86.8	31.4
2	*2462.00	107.3 AV			1.96 V	355	75.9	31.4
3	2483.50	62.6 PK	74.0	-11.4	2.21 V	345	31.1	31.5
4	2483.50	51.6 AV	54.0	-2.4	2.21 V	345	20.1	31.5
5	4924.00	44.3 PK	74.0	-29.7	1.96 V	255	43.7	0.6
6	4924.00	31.2 AV	54.0	-22.8	1.96 V	255	30.6	0.6

REMARKS:

1. Emission Level(dBuV/m) = Raw Value(dBuV) + Correction Factor(dB/m)
2. Correction Factor(dB/m) = Antenna Factor(dB/m) + Cable Factor(dB)
3. The other emission levels were very low against the limit.
4. Margin value = Emission Level – Limit value
5. " * " : Fundamental frequency.

802.11n (HT20)

CHANNEL	TX Channel 1	DETECTOR FUNCTION	Peak (PK)
FREQUENCY RANGE	1GHz ~ 25GHz		Average (AV)

ANTENNA POLARITY & TEST DISTANCE: HORIZONTAL AT 3 M

NO.	FREQ. (MHz)	EMISSION LEVEL (dBuV/m)	LIMIT (dBuV/m)	MARGIN (dB)	ANTENNA HEIGHT (m)	TABLE ANGLE (Degree)	RAW VALUE (dBuV)	CORRECTION FACTOR (dB/m)
1	2390.00	65.1 PK	74.0	-8.9	1.58 H	347	34.1	31.0
2	2390.00	52.3 AV	54.0	-1.7	1.58 H	347	21.3	31.0
3	*2412.00	115.7 PK			1.56 H	352	84.5	31.2
4	*2412.00	105.5 AV			1.56 H	352	74.3	31.2
5	4824.00	43.6 PK	74.0	-30.4	1.77 H	36	43.1	0.5
6	4824.00	33.8 AV	54.0	-20.2	1.77 H	36	33.3	0.5

ANTENNA POLARITY & TEST DISTANCE: VERTICAL AT 3 M

NO.	FREQ. (MHz)	EMISSION LEVEL (dBuV/m)	LIMIT (dBuV/m)	MARGIN (dB)	ANTENNA HEIGHT (m)	TABLE ANGLE (Degree)	RAW VALUE (dBuV)	CORRECTION FACTOR (dB/m)
1	2390.00	64.4 PK	74.0	-9.6	2.05 V	349	33.4	31.0
2	2390.00	51.5 AV	54.0	-2.5	2.05 V	349	20.5	31.0
3	*2412.00	118.1 PK			1.75 V	347	86.9	31.2
4	*2412.00	105.7 AV			1.75 V	347	74.5	31.2
5	4824.00	44.3 PK	74.0	-29.7	1.64 V	277	43.8	0.5
6	4824.00	30.8 AV	54.0	-23.2	1.64 V	277	30.3	0.5

REMARKS:

1. Emission Level(dBuV/m) = Raw Value(dBuV) + Correction Factor(dB/m)
2. Correction Factor(dB/m) = Antenna Factor(dB/m) + Cable Factor(dB)
3. The other emission levels were very low against the limit.
4. Margin value = Emission Level – Limit value
5. " * " : Fundamental frequency.

CHANNEL	TX Channel 6	DETECTOR FUNCTION	Peak (PK)
FREQUENCY RANGE	1GHz ~ 25GHz		Average (AV)

ANTENNA POLARITY & TEST DISTANCE: HORIZONTAL AT 3 M

NO.	FREQ. (MHz)	EMISSION LEVEL (dBuV/m)	LIMIT (dBuV/m)	MARGIN (dB)	ANTENNA HEIGHT (m)	TABLE ANGLE (Degree)	RAW VALUE (dBuV)	CORRECTION FACTOR (dB/m)
1	*2437.00	119.1 PK			1.52 H	347	87.8	31.3
2	*2437.00	109.4 AV			1.52 H	347	78.1	31.3
3	2483.50	63.9 PK	74.0	-10.1	1.83 H	338	32.4	31.5
4	2483.50	49.5 AV	54.0	-4.5	1.83 H	338	18.0	31.5
5	4874.00	48.5 PK	74.0	-25.5	1.62 H	21	47.9	0.6
6	4874.00	39.4 AV	54.0	-14.6	1.62 H	21	38.8	0.6

ANTENNA POLARITY & TEST DISTANCE: VERTICAL AT 3 M

NO.	FREQ. (MHz)	EMISSION LEVEL (dBuV/m)	LIMIT (dBuV/m)	MARGIN (dB)	ANTENNA HEIGHT (m)	TABLE ANGLE (Degree)	RAW VALUE (dBuV)	CORRECTION FACTOR (dB/m)
1	*2437.00	119.1 PK			1.52 H	347	87.8	31.3
2	*2437.00	109.4 AV			1.52 H	347	78.1	31.3
3	2483.50	63.9 PK	74.0	-10.1	1.83 H	338	32.4	31.5
4	2483.50	49.5 AV	54.0	-4.5	1.83 H	338	18.0	31.5
5	4874.00	48.5 PK	74.0	-25.5	1.62 H	21	47.9	0.6
6	4874.00	39.4 AV	54.0	-14.6	1.62 H	21	38.8	0.6

REMARKS:

1. Emission Level(dBuV/m) = Raw Value(dBuV) + Correction Factor(dB/m)
2. Correction Factor(dB/m) = Antenna Factor(dB/m) + Cable Factor(dB)
3. The other emission levels were very low against the limit.
4. Margin value = Emission Level – Limit value
5. " * " : Fundamental frequency.

CHANNEL	TX Channel 11	DETECTOR FUNCTION	Peak (PK)
FREQUENCY RANGE	1GHz ~ 25GHz		Average (AV)

ANTENNA POLARITY & TEST DISTANCE: HORIZONTAL AT 3 M

NO.	FREQ. (MHz)	EMISSION LEVEL (dBuV/m)	LIMIT (dBuV/m)	MARGIN (dB)	ANTENNA HEIGHT (m)	TABLE ANGLE (Degree)	RAW VALUE (dBuV)	CORRECTION FACTOR (dB/m)
1	*2462.00	115.4 PK			1.40 H	347	84.0	31.4
2	*2462.00	105.4 AV			1.40 H	347	74.0	31.4
3	2483.50	64.6 PK	74.0	-9.4	1.11 H	0	33.1	31.5
4	2483.50	51.5 AV	54.0	-2.5	1.11 H	0	20.0	31.5
5	4924.00	44.1 PK	74.0	-29.9	1.80 H	19	43.5	0.6
6	4924.00	34.1 AV	54.0	-19.9	1.80 H	19	33.5	0.6

ANTENNA POLARITY & TEST DISTANCE: VERTICAL AT 3 M

NO.	FREQ. (MHz)	EMISSION LEVEL (dBuV/m)	LIMIT (dBuV/m)	MARGIN (dB)	ANTENNA HEIGHT (m)	TABLE ANGLE (Degree)	RAW VALUE (dBuV)	CORRECTION FACTOR (dB/m)
1	*2462.00	118.7 PK			1.57 V	347	87.3	31.4
2	*2462.00	107.7 AV			1.57 V	347	76.3	31.4
3	2483.50	65.8 PK	74.0	-8.2	1.73 V	343	34.3	31.5
4	2483.50	52.5 AV	54.0	-1.5	1.73 V	343	21.0	31.5
5	4924.00	44.1 PK	74.0	-29.9	1.67 V	323	43.5	0.6
6	4924.00	30.6 AV	54.0	-23.4	1.67 V	323	30.0	0.6

REMARKS:

1. Emission Level(dBuV/m) = Raw Value(dBuV) + Correction Factor(dB/m)
2. Correction Factor(dB/m) = Antenna Factor(dB/m) + Cable Factor(dB)
3. The other emission levels were very low against the limit.
4. Margin value = Emission Level – Limit value
5. " * " : Fundamental frequency.

802.11n (HT40)

CHANNEL	TX Channel 3	DETECTOR FUNCTION	Peak (PK)
FREQUENCY RANGE	1GHz ~ 25GHz		Average (AV)

ANTENNA POLARITY & TEST DISTANCE: HORIZONTAL AT 3 M

NO.	FREQ. (MHz)	EMISSION LEVEL (dBuV/m)	LIMIT (dBuV/m)	MARGIN (dB)	ANTENNA HEIGHT (m)	TABLE ANGLE (Degree)	RAW VALUE (dBuV)	CORRECTION FACTOR (dB/m)
1	2390.00	65.0 PK	74.0	-9.0	1.45 H	348	34.0	31.0
2	2390.00	51.8 AV	54.0	-2.2	1.45 H	348	20.8	31.0
3	*2422.00	110.8 PK			1.75 H	348	79.6	31.2
4	*2422.00	101.2 AV			1.75 H	348	70.0	31.2
5	4844.00	42.5 PK	74.0	-31.5	1.90 H	40	42.1	0.4
6	4844.00	32.9 AV	54.0	-21.1	1.90 H	40	32.5	0.4

ANTENNA POLARITY & TEST DISTANCE: VERTICAL AT 3 M

NO.	FREQ. (MHz)	EMISSION LEVEL (dBuV/m)	LIMIT (dBuV/m)	MARGIN (dB)	ANTENNA HEIGHT (m)	TABLE ANGLE (Degree)	RAW VALUE (dBuV)	CORRECTION FACTOR (dB/m)
1	2390.00	64.7 PK	74.0	-9.3	1.03 V	356	33.7	31.0
2	2390.00	52.4 AV	54.0	-1.6	1.03 V	356	21.4	31.0
3	*2422.00	111.8 PK			1.80 V	349	80.6	31.2
4	*2422.00	101.8 AV			1.80 V	349	70.6	31.2
5	4844.00	41.4 PK	74.0	-32.6	2.03 V	55	41.0	0.4
6	4844.00	30.7 AV	54.0	-23.3	2.03 V	55	30.3	0.4

REMARKS:

1. Emission Level(dBuV/m) = Raw Value(dBuV) + Correction Factor(dB/m)
2. Correction Factor(dB/m) = Antenna Factor(dB/m) + Cable Factor(dB)
3. The other emission levels were very low against the limit.
4. Margin value = Emission Level – Limit value
5. " * " : Fundamental frequency.

CHANNEL	TX Channel 6	DETECTOR FUNCTION	Peak (PK)
FREQUENCY RANGE	1GHz ~ 25GHz		Average (AV)

ANTENNA POLARITY & TEST DISTANCE: HORIZONTAL AT 3 M

NO.	FREQ. (MHz)	EMISSION LEVEL (dBuV/m)	LIMIT (dBuV/m)	MARGIN (dB)	ANTENNA HEIGHT (m)	TABLE ANGLE (Degree)	RAW VALUE (dBuV)	CORRECTION FACTOR (dB/m)
1	2390.00	61.9 PK	74.0	-12.1	1.65 H	334	30.9	31.0
2	2390.00	49.7 AV	54.0	-4.3	1.65 H	334	18.7	31.0
3	*2437.00	113.6 PK			1.55 H	343	82.3	31.3
4	*2437.00	104.4 AV			1.55 H	343	73.1	31.3
5	2483.50	64.6 PK	74.0	-9.4	2.13 H	339	33.1	31.5
6	2483.50	52.3 AV	54.0	-1.7	2.13 H	339	20.8	31.5
7	4874.00	44.1 PK	74.0	-29.9	1.66 H	43	43.5	0.6
8	4874.00	33.9 AV	54.0	-20.1	1.66 H	43	33.3	0.6

ANTENNA POLARITY & TEST DISTANCE: VERTICAL AT 3 M

NO.	FREQ. (MHz)	EMISSION LEVEL (dBuV/m)	LIMIT (dBuV/m)	MARGIN (dB)	ANTENNA HEIGHT (m)	TABLE ANGLE (Degree)	RAW VALUE (dBuV)	CORRECTION FACTOR (dB/m)
1	2390.00	63.0 PK	74.0	-11.0	1.52 V	350	32.0	31.0
2	2390.00	51.0 AV	54.0	-3.0	1.52 V	350	20.0	31.0
3	*2437.00	114.1 PK			1.09 V	355	82.8	31.3
4	*2437.00	104.1 AV			1.09 V	355	72.8	31.3
5	2483.50	65.0 PK	74.0	-9.0	1.43 V	6	33.5	31.5
6	2483.50	51.6 AV	54.0	-2.4	1.43 V	6	20.1	31.5
7	4874.00	43.6 PK	74.0	-30.4	1.51 V	78	43.0	0.6
8	4874.00	33.4 AV	54.0	-20.6	1.51 V	78	32.8	0.6

REMARKS:

1. Emission Level(dBuV/m) = Raw Value(dBuV) + Correction Factor(dB/m)
2. Correction Factor(dB/m) = Antenna Factor(dB/m) + Cable Factor(dB)
3. The other emission levels were very low against the limit.
4. Margin value = Emission Level – Limit value
5. " * ": Fundamental frequency.

CHANNEL	TX Channel 9	DETECTOR FUNCTION	Peak (PK)
FREQUENCY RANGE	1GHz ~ 25GHz		Average (AV)

ANTENNA POLARITY & TEST DISTANCE: HORIZONTAL AT 3 M

NO.	FREQ. (MHz)	EMISSION LEVEL (dBuV/m)	LIMIT (dBuV/m)	MARGIN (dB)	ANTENNA HEIGHT (m)	TABLE ANGLE (Degree)	RAW VALUE (dBuV)	CORRECTION FACTOR (dB/m)
1	*2452.00	109.5 PK			1.54 H	346	78.1	31.4
2	*2452.00	100.1 AV			1.54 H	346	68.7	31.4
3	2483.50	64.8 PK	74.0	-9.2	1.72 H	343	33.3	31.5
4	2483.50	52.8 AV	54.0	-1.2	1.72 H	343	21.3	31.5
5	4904.00	42.3 PK	74.0	-31.7	1.34 H	44	41.8	0.5
6	4904.00	32.1 AV	54.0	-21.9	1.34 H	44	31.6	0.5

ANTENNA POLARITY & TEST DISTANCE: VERTICAL AT 3 M

NO.	FREQ. (MHz)	EMISSION LEVEL (dBuV/m)	LIMIT (dBuV/m)	MARGIN (dB)	ANTENNA HEIGHT (m)	TABLE ANGLE (Degree)	RAW VALUE (dBuV)	CORRECTION FACTOR (dB/m)
1	*2452.00	111.4 PK			1.63 V	343	80.0	31.4
2	*2452.00	101.8 AV			1.63 V	343	70.4	31.4
3	2483.50	67.0 PK	74.0	-7.0	1.63 V	356	35.5	31.5
4	2483.50	52.3 AV	54.0	-1.7	1.63 V	356	20.8	31.5
5	4904.00	41.6 PK	74.0	-32.4	1.80 V	286	41.1	0.5
6	4904.00	30.8 AV	54.0	-23.2	1.80 V	286	30.3	0.5

REMARKS:

1. Emission Level(dBuV/m) = Raw Value(dBuV) + Correction Factor(dB/m)
2. Correction Factor(dB/m) = Antenna Factor(dB/m) + Cable Factor(dB)
3. The other emission levels were very low against the limit.
4. Margin value = Emission Level – Limit value
5. " * " : Fundamental frequency.

Below 1GHz worst-case data:

802.11b

CHANNEL	TX Channel 6	DETECTOR FUNCTION	Quasi-Peak (QP)
FREQUENCY RANGE	30MHz ~ 1GHz		

ANTENNA POLARITY & TEST DISTANCE: HORIZONTAL AT 3 M								
NO.	FREQ. (MHz)	EMISSION LEVEL (dBuV/m)	LIMIT (dBuV/m)	MARGIN (dB)	ANTENNA HEIGHT (m)	TABLE ANGLE (Degree)	RAW VALUE (dBuV)	CORRECTION FACTOR (dB/m)
1	57.12	26.4 QP	40.0	-13.6	2.00 H	189	41.0	-14.6
2	177.67	33.4 QP	43.5	-10.1	2.00 H	215	48.0	-14.6
3	261.27	34.9 QP	46.0	-11.1	1.00 H	315	48.5	-13.6
4	733.73	40.2 QP	46.0	-5.8	1.00 H	104	42.9	-2.7
5	809.56	36.3 QP	46.0	-9.7	1.50 H	34	37.6	-1.3
6	852.33	34.6 QP	46.0	-11.4	2.00 H	248	35.3	-0.7
ANTENNA POLARITY & TEST DISTANCE: VERTICAL AT 3 M								
NO.	FREQ. (MHz)	EMISSION LEVEL (dBuV/m)	LIMIT (dBuV/m)	MARGIN (dB)	ANTENNA HEIGHT (m)	TABLE ANGLE (Degree)	RAW VALUE (dBuV)	CORRECTION FACTOR (dB/m)
1	33.79	35.0 QP	40.0	-5.0	1.00 V	222	50.9	-15.9
2	150.45	33.8 QP	43.5	-9.7	1.00 V	274	47.7	-13.9
3	261.27	35.3 QP	46.0	-10.7	1.49 V	266	48.9	-13.6
4	727.90	36.5 QP	46.0	-9.5	1.49 V	251	39.4	-2.9
5	776.51	35.6 QP	46.0	-10.4	1.00 V	113	37.3	-1.7
6	827.06	34.1 QP	46.0	-11.9	1.00 V	97	35.2	-1.1

Remarks:

1. Emission Level(dBuV/m) = Raw Value(dBuV) + Correction Factor(dB/m)
2. Correction Factor(dB/m) = Antenna Factor(dB/m) + Cable Factor(dB)
3. The other emission levels were very low against the limit.
4. Margin value = Emission Level – Limit value

Test Mode E

Above 1GHz worst-Case data:

802.11b

CHANNEL	TX Channel 1	DETECTOR FUNCTION	Peak (PK)
FREQUENCY RANGE	1GHz ~ 25GHz		Average (AV)

ANTENNA POLARITY & TEST DISTANCE: HORIZONTAL AT 3 M								
NO.	FREQ. (MHz)	EMISSION LEVEL (dBuV/m)	LIMIT (dBuV/m)	MARGIN (dB)	ANTENNA HEIGHT (m)	TABLE ANGLE (Degree)	RAW VALUE (dBuV)	CORRECTION FACTOR (dB/m)
1	2390.00	57.5 PK	74.0	-16.5	1.90 H	311	26.5	31.0
2	2390.00	45.3 AV	54.0	-8.7	1.90 H	311	14.3	31.0
3	*2412.00	106.8 PK			1.92 H	303	75.6	31.2
4	*2412.00	103.0 AV			1.92 H	303	71.8	31.2
5	4824.00	53.4 PK	74.0	-20.6	1.83 H	328	52.9	0.5
6	4824.00	50.8 AV	54.0	-3.2	1.83 H	328	50.3	0.5

ANTENNA POLARITY & TEST DISTANCE: VERTICAL AT 3 M								
NO.	FREQ. (MHz)	EMISSION LEVEL (dBuV/m)	LIMIT (dBuV/m)	MARGIN (dB)	ANTENNA HEIGHT (m)	TABLE ANGLE (Degree)	RAW VALUE (dBuV)	CORRECTION FACTOR (dB/m)
1	2390.00	53.7 PK	74.0	-20.3	1.65 V	357	22.7	31.0
2	2390.00	43.3 AV	54.0	-10.7	1.65 V	357	12.3	31.0
3	*2412.00	103.5 PK			1.65 V	357	72.3	31.2
4	*2412.00	99.4 AV			1.65 V	357	68.2	31.2
5	4824.00	55.3 PK	74.0	-18.7	2.48 V	41	54.8	0.5
6	4824.00	52.7 AV	54.0	-1.3	2.48 V	41	52.2	0.5

REMARKS:

1. Emission Level(dBuV/m) = Raw Value(dBuV) + Correction Factor(dB/m)
2. Correction Factor(dB/m) = Antenna Factor(dB/m) + Cable Factor(dB)
3. The other emission levels were very low against the limit.
4. Margin value = Emission Level – Limit value
5. " * " : Fundamental frequency.

CHANNEL	TX Channel 6	DETECTOR FUNCTION	Peak (PK)
FREQUENCY RANGE	1GHz ~ 25GHz		Average (AV)

ANTENNA POLARITY & TEST DISTANCE: HORIZONTAL AT 3 M

NO.	FREQ. (MHz)	EMISSION LEVEL (dBuV/m)	LIMIT (dBuV/m)	MARGIN (dB)	ANTENNA HEIGHT (m)	TABLE ANGLE (Degree)	RAW VALUE (dBuV)	CORRECTION FACTOR (dB/m)
1	*2437.00	104.8 PK			1.85 H	294	73.5	31.3
2	*2437.00	101.0 AV			1.85 H	294	69.7	31.3
3	4874.00	54.4 PK	74.0	-19.6	2.05 H	347	53.8	0.6
4	4874.00	52.2 AV	54.0	-1.8	2.05 H	347	51.6	0.6

ANTENNA POLARITY & TEST DISTANCE: VERTICAL AT 3 M

NO.	FREQ. (MHz)	EMISSION LEVEL (dBuV/m)	LIMIT (dBuV/m)	MARGIN (dB)	ANTENNA HEIGHT (m)	TABLE ANGLE (Degree)	RAW VALUE (dBuV)	CORRECTION FACTOR (dB/m)
1	*2437.00	102.2 PK			1.61 V	355	70.9	31.3
2	*2437.00	98.5 AV			1.61 V	355	67.2	31.3
3	4874.00	54.7 PK	74.0	-19.3	2.59 V	43	54.1	0.6
4	4874.00	52.3 AV	54.0	-1.7	2.59 V	43	51.7	0.6

REMARKS:

1. Emission Level(dBuV/m) = Raw Value(dBuV) + Correction Factor(dB/m)
2. Correction Factor(dB/m) = Antenna Factor(dB/m) + Cable Factor(dB)
3. The other emission levels were very low against the limit.
4. Margin value = Emission Level – Limit value
5. " * " : Fundamental frequency.

CHANNEL	TX Channel 11	DETECTOR FUNCTION	Peak (PK)
FREQUENCY RANGE	1GHz ~ 25GHz		Average (AV)

ANTENNA POLARITY & TEST DISTANCE: HORIZONTAL AT 3 M

NO.	FREQ. (MHz)	EMISSION LEVEL (dBuV/m)	LIMIT (dBuV/m)	MARGIN (dB)	ANTENNA HEIGHT (m)	TABLE ANGLE (Degree)	RAW VALUE (dBuV)	CORRECTION FACTOR (dB/m)
1	*2462.00	107.0 PK			1.90 H	300	75.6	31.4
2	*2462.00	103.2 AV			1.90 H	300	71.8	31.4
3	2483.50	58.8 PK	74.0	-15.2	1.90 H	300	27.3	31.5
4	2483.50	45.6 AV	54.0	-8.4	1.90 H	300	14.1	31.5
5	4924.00	53.3 PK	74.0	-20.7	1.89 H	52	52.7	0.6
6	4924.00	50.7 AV	54.0	-3.3	1.89 H	52	50.1	0.6

ANTENNA POLARITY & TEST DISTANCE: VERTICAL AT 3 M

NO.	FREQ. (MHz)	EMISSION LEVEL (dBuV/m)	LIMIT (dBuV/m)	MARGIN (dB)	ANTENNA HEIGHT (m)	TABLE ANGLE (Degree)	RAW VALUE (dBuV)	CORRECTION FACTOR (dB/m)
1	*2462.00	105.0 PK			1.80 V	5	73.6	31.4
2	*2462.00	101.2 AV			1.80 V	5	69.8	31.4
3	2483.50	56.1 PK	74.0	-17.9	1.80 V	5	24.6	31.5
4	2483.50	44.6 AV	54.0	-9.4	1.80 V	5	13.1	31.5
5	4924.00	54.6 PK	74.0	-19.4	2.46 V	41	54.0	0.6
6	4924.00	52.6 AV	54.0	-1.4	2.46 V	41	52.0	0.6

REMARKS:

1. Emission Level(dBuV/m) = Raw Value(dBuV) + Correction Factor(dB/m)
2. Correction Factor(dB/m) = Antenna Factor(dB/m) + Cable Factor(dB)
3. The other emission levels were very low against the limit.
4. Margin value = Emission Level – Limit value
5. " * " : Fundamental frequency.

802.11g

CHANNEL	TX Channel 1	DETECTOR FUNCTION	Peak (PK)
FREQUENCY RANGE	1GHz ~ 25GHz		Average (AV)

ANTENNA POLARITY & TEST DISTANCE: HORIZONTAL AT 3 M

NO.	FREQ. (MHz)	EMISSION LEVEL (dBuV/m)	LIMIT (dBuV/m)	MARGIN (dB)	ANTENNA HEIGHT (m)	TABLE ANGLE (Degree)	RAW VALUE (dBuV)	CORRECTION FACTOR (dB/m)
1	2390.00	66.6 PK	74.0	-7.4	2.33 H	302	35.6	31.0
2	2390.00	52.6 AV	54.0	-1.4	2.33 H	302	21.6	31.0
3	*2412.00	102.9 PK			2.09 H	306	71.7	31.2
4	*2412.00	93.7 AV			2.09 H	306	62.5	31.2
5	4824.00	46.2 PK	74.0	-27.8	2.35 H	322	45.7	0.5
6	4824.00	33.5 AV	54.0	-20.5	2.35 H	322	33.0	0.5

ANTENNA POLARITY & TEST DISTANCE: VERTICAL AT 3 M

NO.	FREQ. (MHz)	EMISSION LEVEL (dBuV/m)	LIMIT (dBuV/m)	MARGIN (dB)	ANTENNA HEIGHT (m)	TABLE ANGLE (Degree)	RAW VALUE (dBuV)	CORRECTION FACTOR (dB/m)
1	2390.00	63.0 PK	74.0	-11.0	1.50 V	3	32.0	31.0
2	2390.00	49.2 AV	54.0	-4.8	1.50 V	3	18.2	31.0
3	*2412.00	100.5 PK			1.65 V	5	69.3	31.2
4	*2412.00	90.9 AV			1.65 V	5	59.7	31.2
5	4824.00	47.6 PK	74.0	-26.4	1.70 V	329	47.1	0.5
6	4824.00	35.8 AV	54.0	-18.2	1.70 V	329	35.3	0.5

REMARKS:

1. Emission Level(dBuV/m) = Raw Value(dBuV) + Correction Factor(dB/m)
2. Correction Factor(dB/m) = Antenna Factor(dB/m) + Cable Factor(dB)
3. The other emission levels were very low against the limit.
4. Margin value = Emission Level – Limit value
5. " * " : Fundamental frequency.

CHANNEL	TX Channel 6	DETECTOR FUNCTION	Peak (PK)
FREQUENCY RANGE	1GHz ~ 25GHz		Average (AV)

ANTENNA POLARITY & TEST DISTANCE: HORIZONTAL AT 3 M

NO.	FREQ. (MHz)	EMISSION LEVEL (dBuV/m)	LIMIT (dBuV/m)	MARGIN (dB)	ANTENNA HEIGHT (m)	TABLE ANGLE (Degree)	RAW VALUE (dBuV)	CORRECTION FACTOR (dB/m)
1	2390.00	67.5 PK	74.0	-6.5	2.39 H	300	36.5	31.0
2	2390.00	52.3 AV	54.0	-1.7	2.39 H	300	21.3	31.0
3	*2437.00	112.2 PK			2.30 H	301	80.9	31.3
4	*2437.00	102.4 AV			2.30 H	301	71.1	31.3
5	2483.50	58.6 PK	74.0	-15.4	2.00 H	304	27.1	31.5
6	2483.50	46.9 AV	54.0	-7.1	2.00 H	304	15.4	31.5
7	4874.00	54.5 PK	74.0	-19.5	2.01 H	350	53.9	0.6
8	4874.00	42.5 AV	54.0	-11.5	2.01 H	350	41.9	0.6

ANTENNA POLARITY & TEST DISTANCE: VERTICAL AT 3 M

NO.	FREQ. (MHz)	EMISSION LEVEL (dBuV/m)	LIMIT (dBuV/m)	MARGIN (dB)	ANTENNA HEIGHT (m)	TABLE ANGLE (Degree)	RAW VALUE (dBuV)	CORRECTION FACTOR (dB/m)
1	2390.00	63.9 PK	74.0	-10.1	1.48 V	7	32.9	31.0
2	2390.00	49.7 AV	54.0	-4.3	1.48 V	7	18.7	31.0
3	*2437.00	110.0 PK			1.58 V	6	78.7	31.3
4	*2437.00	99.7 AV			1.58 V	6	68.4	31.3
5	2483.50	57.0 PK	74.0	-17.0	1.77 V	345	25.5	31.5
6	2483.50	46.4 AV	54.0	-7.6	1.77 V	345	14.9	31.5
7	4874.00	54.1 PK	74.0	-19.9	1.56 V	19	53.5	0.6
8	4874.00	41.3 AV	54.0	-12.7	1.56 V	19	40.7	0.6

REMARKS:

1. Emission Level(dBuV/m) = Raw Value(dBuV) + Correction Factor(dB/m)
2. Correction Factor(dB/m) = Antenna Factor(dB/m) + Cable Factor(dB)
3. The other emission levels were very low against the limit.
4. Margin value = Emission Level – Limit value
5. " * ": Fundamental frequency.

CHANNEL	TX Channel 11	DETECTOR FUNCTION	Peak (PK)
FREQUENCY RANGE	1GHz ~ 25GHz		Average (AV)

ANTENNA POLARITY & TEST DISTANCE: HORIZONTAL AT 3 M

NO.	FREQ. (MHz)	EMISSION LEVEL (dBuV/m)	LIMIT (dBuV/m)	MARGIN (dB)	ANTENNA HEIGHT (m)	TABLE ANGLE (Degree)	RAW VALUE (dBuV)	CORRECTION FACTOR (dB/m)
1	*2462.00	105.6 PK			2.25 H	299	74.2	31.4
2	*2462.00	95.8 AV			2.25 H	299	64.4	31.4
3	2483.50	65.0 PK	74.0	-9.0	2.22 H	305	33.5	31.5
4	2483.50	52.3 AV	54.0	-1.7	2.22 H	305	20.8	31.5
5	4924.00	49.5 PK	74.0	-24.5	2.33 H	12	48.9	0.6
6	4924.00	36.1 AV	54.0	-17.9	2.33 H	12	35.5	0.6

ANTENNA POLARITY & TEST DISTANCE: VERTICAL AT 3 M

NO.	FREQ. (MHz)	EMISSION LEVEL (dBuV/m)	LIMIT (dBuV/m)	MARGIN (dB)	ANTENNA HEIGHT (m)	TABLE ANGLE (Degree)	RAW VALUE (dBuV)	CORRECTION FACTOR (dB/m)
1	*2462.00	101.9 PK			1.46 V	352	70.5	31.4
2	*2462.00	92.8 AV			1.46 V	352	61.4	31.4
3	2483.50	63.6 PK	74.0	-10.4	1.40 V	343	32.1	31.5
4	2483.50	50.3 AV	54.0	-3.7	1.40 V	343	18.8	31.5
5	4924.00	48.4 PK	74.0	-25.6	1.65 V	22	47.8	0.6
6	4924.00	36.1 AV	54.0	-17.9	1.65 V	22	35.5	0.6

REMARKS:

1. Emission Level(dBuV/m) = Raw Value(dBuV) + Correction Factor(dB/m)
2. Correction Factor(dB/m) = Antenna Factor(dB/m) + Cable Factor(dB)
3. The other emission levels were very low against the limit.
4. Margin value = Emission Level – Limit value
5. " * " : Fundamental frequency.

802.11n (HT20)

CHANNEL	TX Channel 1	DETECTOR FUNCTION	Peak (PK)
FREQUENCY RANGE	1GHz ~ 25GHz		Average (AV)

ANTENNA POLARITY & TEST DISTANCE: HORIZONTAL AT 3 M

NO.	FREQ. (MHz)	EMISSION LEVEL (dBuV/m)	LIMIT (dBuV/m)	MARGIN (dB)	ANTENNA HEIGHT (m)	TABLE ANGLE (Degree)	RAW VALUE (dBuV)	CORRECTION FACTOR (dB/m)
1	2390.00	68.6 PK	74.0	-5.4	2.08 H	299	37.6	31.0
2	2390.00	52.2 AV	54.0	-1.8	2.08 H	299	21.2	31.0
3	*2412.00	101.5 PK			2.05 H	302	70.3	31.2
4	*2412.00	91.5 AV			2.05 H	302	60.3	31.2
5	4824.00	45.2 PK	74.0	-28.8	2.00 H	350	44.7	0.5
6	4824.00	33.3 AV	54.0	-20.7	2.00 H	350	32.8	0.5

ANTENNA POLARITY & TEST DISTANCE: VERTICAL AT 3 M

NO.	FREQ. (MHz)	EMISSION LEVEL (dBuV/m)	LIMIT (dBuV/m)	MARGIN (dB)	ANTENNA HEIGHT (m)	TABLE ANGLE (Degree)	RAW VALUE (dBuV)	CORRECTION FACTOR (dB/m)
1	2390.00	60.2 PK	74.0	-13.8	1.42 V	7	29.2	31.0
2	2390.00	49.6 AV	54.0	-4.4	1.42 V	7	18.6	31.0
3	*2412.00	98.4 PK			1.66 V	6	67.2	31.2
4	*2412.00	88.9 AV			1.66 V	6	57.7	31.2
5	4824.00	45.5 PK	74.0	-28.5	1.84 V	329	45.0	0.5
6	4824.00	33.8 AV	54.0	-20.2	1.84 V	329	33.3	0.5

REMARKS:

1. Emission Level(dBuV/m) = Raw Value(dBuV) + Correction Factor(dB/m)
2. Correction Factor(dB/m) = Antenna Factor(dB/m) + Cable Factor(dB)
3. The other emission levels were very low against the limit.
4. Margin value = Emission Level – Limit value
5. " * " : Fundamental frequency.

CHANNEL	TX Channel 6	DETECTOR FUNCTION	Peak (PK)
FREQUENCY RANGE	1GHz ~ 25GHz		Average (AV)

ANTENNA POLARITY & TEST DISTANCE: HORIZONTAL AT 3 M

NO.	FREQ. (MHz)	EMISSION LEVEL (dBuV/m)	LIMIT (dBuV/m)	MARGIN (dB)	ANTENNA HEIGHT (m)	TABLE ANGLE (Degree)	RAW VALUE (dBuV)	CORRECTION FACTOR (dB/m)
1	2390.00	69.1 PK	74.0	-4.9	2.37 H	299	38.1	31.0
2	2390.00	53.0 AV	54.0	-1.0	2.37 H	299	22.0	31.0
3	*2437.00	111.9 PK			2.27 H	305	80.6	31.3
4	*2437.00	102.4 AV			2.27 H	305	71.1	31.3
5	2483.50	58.7 PK	74.0	-15.3	2.27 H	305	27.2	31.5
6	2483.50	47.8 AV	54.0	-6.2	2.27 H	305	16.3	31.5
7	4874.00	55.4 PK	74.0	-18.6	2.14 H	349	54.8	0.6
8	4874.00	42.8 AV	54.0	-11.2	2.14 H	349	42.2	0.6

ANTENNA POLARITY & TEST DISTANCE: VERTICAL AT 3 M

NO.	FREQ. (MHz)	EMISSION LEVEL (dBuV/m)	LIMIT (dBuV/m)	MARGIN (dB)	ANTENNA HEIGHT (m)	TABLE ANGLE (Degree)	RAW VALUE (dBuV)	CORRECTION FACTOR (dB/m)
1	2390.00	67.2 PK	74.0	-6.8	1.21 V	3	36.2	31.0
2	2390.00	50.2 AV	54.0	-3.8	1.21 V	3	19.2	31.0
3	*2437.00	108.8 PK			1.86 V	357	77.5	31.3
4	*2437.00	99.0 AV			1.86 V	357	67.7	31.3
5	2483.50	58.3 PK	74.0	-15.7	1.56 V	0	26.8	31.5
6	2483.50	45.6 AV	54.0	-8.4	1.56 V	0	14.1	31.5
7	4874.00	53.9 PK	74.0	-20.1	1.64 V	20	53.3	0.6
8	4874.00	41.1 AV	54.0	-12.9	1.64 V	20	40.5	0.6

REMARKS:

1. Emission Level(dBuV/m) = Raw Value(dBuV) + Correction Factor(dB/m)
2. Correction Factor(dB/m) = Antenna Factor(dB/m) + Cable Factor(dB)
3. The other emission levels were very low against the limit.
4. Margin value = Emission Level – Limit value
5. " * ": Fundamental frequency.

CHANNEL	TX Channel 11	DETECTOR FUNCTION	Peak (PK)
FREQUENCY RANGE	1GHz ~ 25GHz		Average (AV)

ANTENNA POLARITY & TEST DISTANCE: HORIZONTAL AT 3 M

NO.	FREQ. (MHz)	EMISSION LEVEL (dBuV/m)	LIMIT (dBuV/m)	MARGIN (dB)	ANTENNA HEIGHT (m)	TABLE ANGLE (Degree)	RAW VALUE (dBuV)	CORRECTION FACTOR (dB/m)
1	*2462.00	105.3 PK			2.26 H	300	73.9	31.4
2	*2462.00	95.5 AV			2.26 H	300	64.1	31.4
3	2483.50	66.0 PK	74.0	-8.0	2.20 H	308	34.5	31.5
4	2483.50	53.0 AV	54.0	-1.0	2.20 H	308	21.5	31.5
5	4924.00	49.3 PK	74.0	-24.7	2.03 H	349	48.7	0.6
6	4924.00	35.9 AV	54.0	-18.1	2.03 H	349	35.3	0.6

ANTENNA POLARITY & TEST DISTANCE: VERTICAL AT 3 M

NO.	FREQ. (MHz)	EMISSION LEVEL (dBuV/m)	LIMIT (dBuV/m)	MARGIN (dB)	ANTENNA HEIGHT (m)	TABLE ANGLE (Degree)	RAW VALUE (dBuV)	CORRECTION FACTOR (dB/m)
1	*2462.00	104.7 PK			3.18 V	348	73.3	31.4
2	*2462.00	95.0 AV			3.18 V	348	63.6	31.4
3	2483.50	65.0 PK	74.0	-9.0	2.56 V	354	33.5	31.5
4	2483.50	51.6 AV	54.0	-2.4	2.56 V	354	20.1	31.5
5	4924.00	47.4 PK	74.0	-26.6	1.66 V	26	46.8	0.6
6	4924.00	35.4 AV	54.0	-18.6	1.66 V	26	34.8	0.6

REMARKS:

1. Emission Level(dBuV/m) = Raw Value(dBuV) + Correction Factor(dB/m)
2. Correction Factor(dB/m) = Antenna Factor(dB/m) + Cable Factor(dB)
3. The other emission levels were very low against the limit.
4. Margin value = Emission Level – Limit value
5. " * " : Fundamental frequency.

802.11n (HT40)

CHANNEL	TX Channel 3	DETECTOR FUNCTION	Peak (PK)
FREQUENCY RANGE	1GHz ~ 25GHz		Average (AV)

ANTENNA POLARITY & TEST DISTANCE: HORIZONTAL AT 3 M

NO.	FREQ. (MHz)	EMISSION LEVEL (dBuV/m)	LIMIT (dBuV/m)	MARGIN (dB)	ANTENNA HEIGHT (m)	TABLE ANGLE (Degree)	RAW VALUE (dBuV)	CORRECTION FACTOR (dB/m)
1	2390.00	64.5 PK	74.0	-9.5	2.36 H	300	33.5	31.0
2	2390.00	52.5 AV	54.0	-1.5	2.36 H	300	21.5	31.0
3	*2422.00	96.7 PK			2.31 H	302	65.5	31.2
4	*2422.00	87.5 AV			2.31 H	302	56.3	31.2
5	4844.00	43.7 PK	74.0	-30.3	2.00 H	359	43.3	0.4
6	4844.00	32.2 AV	54.0	-21.8	2.00 H	359	31.8	0.4

ANTENNA POLARITY & TEST DISTANCE: VERTICAL AT 3 M

NO.	FREQ. (MHz)	EMISSION LEVEL (dBuV/m)	LIMIT (dBuV/m)	MARGIN (dB)	ANTENNA HEIGHT (m)	TABLE ANGLE (Degree)	RAW VALUE (dBuV)	CORRECTION FACTOR (dB/m)
1	2390.00	60.5 PK	74.0	-13.5	1.48 V	7	29.5	31.0
2	2390.00	50.1 AV	54.0	-3.9	1.48 V	7	19.1	31.0
3	*2422.00	93.5 PK			1.61 V	3	62.3	31.2
4	*2422.00	84.2 AV			1.61 V	3	53.0	31.2
5	4844.00	43.3 PK	74.0	-30.7	1.36 V	321	42.9	0.4
6	4844.00	31.7 AV	54.0	-22.3	1.36 V	321	31.3	0.4

REMARKS:

1. Emission Level(dBuV/m) = Raw Value(dBuV) + Correction Factor(dB/m)
2. Correction Factor(dB/m) = Antenna Factor(dB/m) + Cable Factor(dB)
3. The other emission levels were very low against the limit.
4. Margin value = Emission Level – Limit value
5. " * " : Fundamental frequency.

CHANNEL	TX Channel 6	DETECTOR FUNCTION	Peak (PK)
FREQUENCY RANGE	1GHz ~ 25GHz		Average (AV)

ANTENNA POLARITY & TEST DISTANCE: HORIZONTAL AT 3 M

NO.	FREQ. (MHz)	EMISSION LEVEL (dBuV/m)	LIMIT (dBuV/m)	MARGIN (dB)	ANTENNA HEIGHT (m)	TABLE ANGLE (Degree)	RAW VALUE (dBuV)	CORRECTION FACTOR (dB/m)
1	2390.00	66.3 PK	74.0	-7.7	2.35 H	300	35.3	31.0
2	2390.00	53.0 AV	54.0	-1.0	2.35 H	300	22.0	31.0
3	*2437.00	101.2 PK			2.35 H	297	69.9	31.3
4	*2437.00	91.6 AV			2.35 H	297	60.3	31.3
5	2483.50	58.4 PK	74.0	-15.6	2.35 H	297	26.9	31.5
6	2483.50	47.1 AV	54.0	-6.9	2.35 H	297	15.6	31.5
7	4874.00	46.3 PK	74.0	-27.7	1.90 H	23	45.7	0.6
8	4874.00	34.8 AV	54.0	-19.2	1.90 H	23	34.2	0.6

ANTENNA POLARITY & TEST DISTANCE: VERTICAL AT 3 M

NO.	FREQ. (MHz)	EMISSION LEVEL (dBuV/m)	LIMIT (dBuV/m)	MARGIN (dB)	ANTENNA HEIGHT (m)	TABLE ANGLE (Degree)	RAW VALUE (dBuV)	CORRECTION FACTOR (dB/m)
1	2390.00	61.3 PK	74.0	-12.7	1.26 V	1	30.3	31.0
2	2390.00	49.5 AV	54.0	-4.5	1.26 V	1	18.5	31.0
3	*2437.00	97.8 PK			1.85 V	357	66.5	31.3
4	*2437.00	87.9 AV			1.85 V	357	56.6	31.3
5	2483.50	56.4 PK	74.0	-17.6	1.85 V	359	24.9	31.5
6	2483.50	45.0 AV	54.0	-9.0	1.85 V	359	13.5	31.5
7	4874.00	45.9 PK	74.0	-28.1	1.77 V	334	45.3	0.6
8	4874.00	33.2 AV	54.0	-20.8	1.77 V	334	32.6	0.6

REMARKS:

1. Emission Level(dBuV/m) = Raw Value(dBuV) + Correction Factor(dB/m)
2. Correction Factor(dB/m) = Antenna Factor(dB/m) + Cable Factor(dB)
3. The other emission levels were very low against the limit.
4. Margin value = Emission Level – Limit value
5. " * ": Fundamental frequency.

CHANNEL	TX Channel 9	DETECTOR FUNCTION	Peak (PK)
FREQUENCY RANGE	1GHz ~ 25GHz		Average (AV)

ANTENNA POLARITY & TEST DISTANCE: HORIZONTAL AT 3 M

NO.	FREQ. (MHz)	EMISSION LEVEL (dBuV/m)	LIMIT (dBuV/m)	MARGIN (dB)	ANTENNA HEIGHT (m)	TABLE ANGLE (Degree)	RAW VALUE (dBuV)	CORRECTION FACTOR (dB/m)
1	*2452.00	99.8 PK			1.85 H	304	68.4	31.4
2	*2452.00	90.3 AV			1.85 H	304	58.9	31.4
3	2483.50	63.0 PK	74.0	-11.0	2.24 H	306	31.5	31.5
4	2483.50	52.4 AV	54.0	-1.6	2.24 H	306	20.9	31.5
5	4904.00	44.4 PK	74.0	-29.6	1.99 H	19	43.9	0.5
6	4904.00	32.7 AV	54.0	-21.3	1.99 H	19	32.2	0.5

ANTENNA POLARITY & TEST DISTANCE: VERTICAL AT 3 M

NO.	FREQ. (MHz)	EMISSION LEVEL (dBuV/m)	LIMIT (dBuV/m)	MARGIN (dB)	ANTENNA HEIGHT (m)	TABLE ANGLE (Degree)	RAW VALUE (dBuV)	CORRECTION FACTOR (dB/m)
1	*2452.00	97.5 PK			1.79 V	7	66.1	31.4
2	*2452.00	87.9 AV			1.79 V	7	56.5	31.4
3	2483.50	57.9 PK	74.0	-16.1	1.70 V	359	26.4	31.5
4	2483.50	45.6 AV	54.0	-8.4	1.70 V	359	14.1	31.5
5	4904.00	46.3 PK	74.0	-27.7	1.40 V	333	45.8	0.5
6	4904.00	33.6 AV	54.0	-20.4	1.40 V	333	33.1	0.5

REMARKS:

1. Emission Level(dBuV/m) = Raw Value(dBuV) + Correction Factor(dB/m)
2. Correction Factor(dB/m) = Antenna Factor(dB/m) + Cable Factor(dB)
3. The other emission levels were very low against the limit.
4. Margin value = Emission Level – Limit value
5. " * " : Fundamental frequency.

Below 1GHz worst-case data:

802.11b

CHANNEL	TX Channel 6	DETECTOR FUNCTION	Quasi-Peak (QP)
FREQUENCY RANGE	30MHz ~ 1GHz		

ANTENNA POLARITY & TEST DISTANCE: HORIZONTAL AT 3 M

NO.	FREQ. (MHz)	EMISSION LEVEL (dBuV/m)	LIMIT (dBuV/m)	MARGIN (dB)	ANTENNA HEIGHT (m)	TABLE ANGLE (Degree)	RAW VALUE (dBuV)	CORRECTION FACTOR (dB/m)
1	101.84	32.1 QP	43.5	-11.4	2.00 H	66	50.3	-18.2
2	599.58	39.7 QP	46.0	-6.3	1.00 H	352	45.1	-5.4
3	624.85	39.5 QP	46.0	-6.5	1.00 H	349	44.3	-4.8
4	700.68	38.9 QP	46.0	-7.1	1.00 H	16	42.5	-3.6
5	799.84	35.7 QP	46.0	-10.3	2.00 H	328	37.2	-1.5
6	860.11	34.9 QP	46.0	-11.1	2.00 H	190	35.5	-0.6

ANTENNA POLARITY & TEST DISTANCE: VERTICAL AT 3 M

NO.	FREQ. (MHz)	EMISSION LEVEL (dBuV/m)	LIMIT (dBuV/m)	MARGIN (dB)	ANTENNA HEIGHT (m)	TABLE ANGLE (Degree)	RAW VALUE (dBuV)	CORRECTION FACTOR (dB/m)
1	35.73	36.8 QP	40.0	-3.2	1.00 V	180	52.7	-15.9
2	169.89	29.3 QP	43.5	-14.2	1.00 V	163	43.2	-13.9
3	683.18	36.8 QP	46.0	-9.2	1.00 V	113	40.7	-3.9
4	727.90	39.9 QP	46.0	-6.1	1.00 V	145	42.8	-2.9
5	799.84	35.8 QP	46.0	-10.2	1.00 V	18	37.3	-1.5
6	844.56	34.9 QP	46.0	-11.1	1.00 V	26	35.8	-0.9

Remarks:

1. Emission Level(dBuV/m) = Raw Value(dBuV) + Correction Factor(dB/m)
2. Correction Factor(dB/m) = Antenna Factor(dB/m) + Cable Factor(dB)
3. The other emission levels were very low against the limit.
4. Margin value = Emission Level – Limit value

4.2 Conducted Emission Measurement

4.2.1 Limits of Conducted Emission Measurement

Frequency (MHz)	Conducted Limit (dBuV)	
	Quasi-peak	Average
0.15 - 0.5	66 - 56	56 - 46
0.50 - 5.0	56	46
5.0 - 30.0	60	50

- Note:** 1. The lower limit shall apply at the transition frequencies.
2. The limit decreases in line with the logarithm of the frequency in the range of 0.15 to 0.50MHz.

4.2.2 Test Instruments

Description & Manufacturer	Model No.	Serial No.	Cal. Date	Cal. Due
Test Receiver ROHDE & SCHWARZ	ESCI	100613	Nov. 21, 2016	Nov. 20, 2017
RF signal cable (with 10dB PAD) Woken	5D-FB	Cable-cond1-01	Dec. 22, 2016	Dec. 21, 2017
LISN ROHDE & SCHWARZ (EUT)	ESH3-Z5	835239/001	Mar. 10, 2017	Mar. 09, 2018
LISN ROHDE & SCHWARZ (Peripheral)	ESH3-Z5	100311	Jul. 28, 2016	Jul. 27, 2017
Software ADT	BV ADT_Cond_ V7.3.7.3	NA	NA	NA

- Note:** 1. The calibration interval of the above test instruments is 12 months and the calibrations are traceable to NML/ROC and NIST/USA.
2. The test was performed in HwaYa Shielded Room 1.
3. The VCCI Site Registration No. is C-2040.

4.2.3 Test Procedures

- The EUT was placed 0.4 meters from the conducting wall of the shielded room with EUT being connected to the power mains through a line impedance stabilization network (LISN). Other support units were connected to the power mains through another LISN. The two LISNs provide 50 ohm/ 50uH of coupling impedance for the measuring instrument.
- Both lines of the power mains connected to the EUT were checked for maximum conducted interference.
- The frequency range from 150kHz to 30MHz was searched. Emission levels under (Limit - 20dB) was not recorded.

Note: The resolution bandwidth and video bandwidth of test receiver is 9kHz for quasi-peak detection (QP) and average detection (AV) at frequency 0.15MHz-30MHz.

4.2.4 Deviation from Test Standard

No deviation.

4.2.5 Test Setup

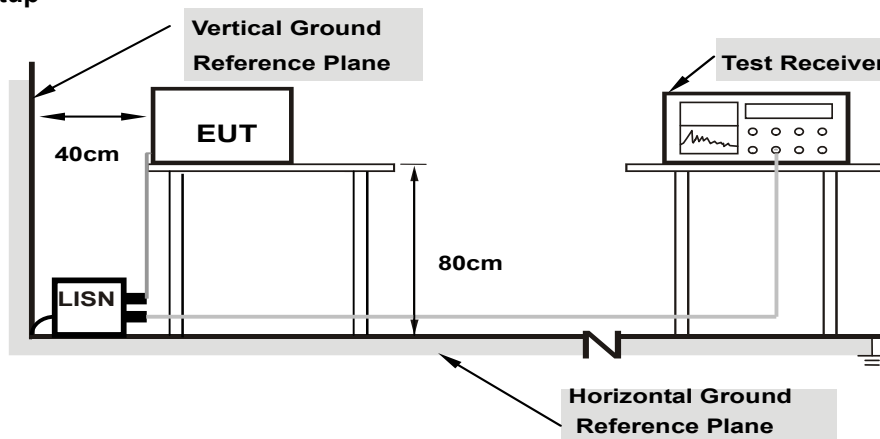

Note: 1.Support units were connected to second LISN.

For the actual test configuration, please refer to the attached file (Test Setup Photo).

4.2.6 EUT Operating Conditions

Same as 4.1.6.

4.2.7 Test Results

Test Mode A

Phase	Line (L)	Detector Function	Quasi-Peak (QP) / Average (AV)
-------	----------	-------------------	--------------------------------

No	Freq. [MHz]	Corr. Factor (dB)	Reading Value [dB (uV)]		Emission Level [dB (uV)]		Limit [dB (uV)]		Margin (dB)	
			Q.P.	AV.	Q.P.	AV.	Q.P.	AV.	Q.P.	AV.
			1	0.19380	10.37	46.83	35.19	57.20	45.56	63.87
2	0.25800	10.38	39.29	27.27	49.67	37.65	61.50	51.50	-11.83	-13.85
3	0.33000	10.39	36.05	26.70	46.44	37.09	59.45	49.45	-13.01	-12.36
4	0.43829	10.40	23.81	7.28	34.21	17.68	57.09	47.09	-22.88	-29.41
5	0.51800	10.40	23.53	12.33	33.93	22.73	56.00	46.00	-22.07	-23.27
6	9.09400	10.79	21.03	12.13	31.82	22.92	60.00	50.00	-28.18	-27.08

Remarks:

1. Q.P. and AV. are abbreviations of quasi-peak and average individually.
2. The emission levels of other frequencies were very low against the limit.
3. Margin value = Emission level - Limit value
4. Correction factor = Insertion loss + Cable loss
5. Emission Level = Correction Factor + Reading Value.

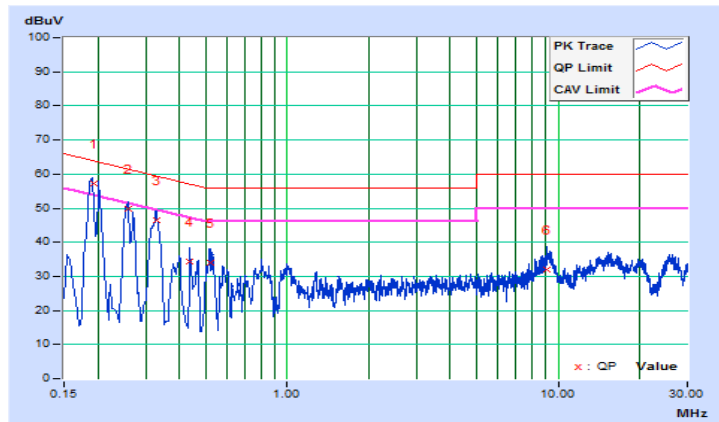

Phase	Neutral (N)	Detector Function	Quasi-Peak (QP) / Average (AV)
-------	-------------	-------------------	--------------------------------

No	Freq. [MHz]	Corr. Factor (dB)	Reading Value [dB (uV)]		Emission Level [dB (uV)]		Limit [dB (uV)]		Margin (dB)	
			Q.P.	AV.	Q.P.	AV.	Q.P.	AV.	Q.P.	AV.
			1	0.19000	10.13	44.87	30.72	55.00	40.85	64.04
2	0.26083	10.15	35.89	23.62	46.04	33.77	61.40	51.40	-15.36	-17.63
3	0.32975	10.15	33.58	22.81	43.73	32.96	59.46	49.46	-15.73	-16.50
4	0.51800	10.16	23.05	11.26	33.21	21.42	56.00	46.00	-22.79	-24.58
5	1.00503	10.17	22.76	12.79	32.93	22.96	56.00	46.00	-23.07	-23.04
6	15.41800	10.77	23.27	15.89	34.04	26.66	60.00	50.00	-25.96	-23.34

Remarks:

1. Q.P. and AV. are abbreviations of quasi-peak and average individually.
2. The emission levels of other frequencies were very low against the limit.
3. Margin value = Emission level - Limit value
4. Correction factor = Insertion loss + Cable loss
5. Emission Level = Correction Factor + Reading Value.

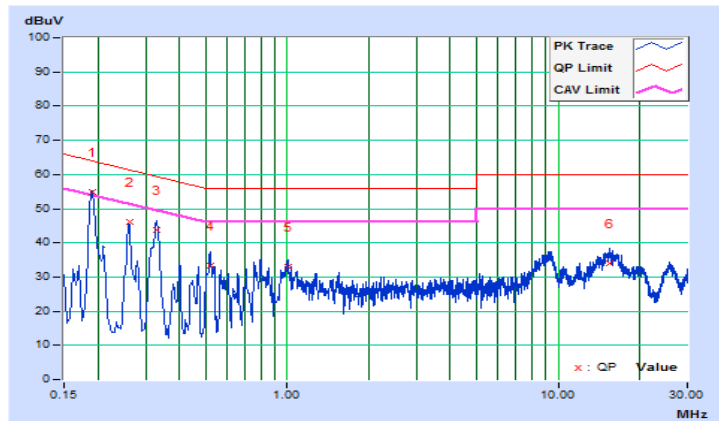

Test Mode B

Phase	Line (L)	Detector Function	Quasi-Peak (QP) / Average (AV)
-------	----------	-------------------	--------------------------------

No	Freq. [MHz]	Corr. Factor (dB)	Reading Value [dB (uV)]		Emission Level [dB (uV)]		Limit [dB (uV)]		Margin (dB)	
			Q.P.	AV.	Q.P.	AV.	Q.P.	AV.	Q.P.	AV.
			1	0.19000	10.36	45.04	31.43	55.40	41.79	64.04
2	0.25810	10.38	37.65	26.33	48.03	36.71	61.49	51.49	-13.46	-14.78
3	0.32802	10.39	35.04	26.61	45.43	37.00	59.50	49.50	-14.07	-12.50
4	0.51800	10.40	22.53	11.84	32.93	22.24	56.00	46.00	-23.07	-23.76
5	9.32600	10.80	22.05	14.83	32.85	25.63	60.00	50.00	-27.15	-24.37
6	16.44600	11.16	22.95	18.78	34.11	29.94	60.00	50.00	-25.89	-20.06

Remarks:

1. Q.P. and AV. are abbreviations of quasi-peak and average individually.
2. The emission levels of other frequencies were very low against the limit.
3. Margin value = Emission level - Limit value
4. Correction factor = Insertion loss + Cable loss
5. Emission Level = Correction Factor + Reading Value.

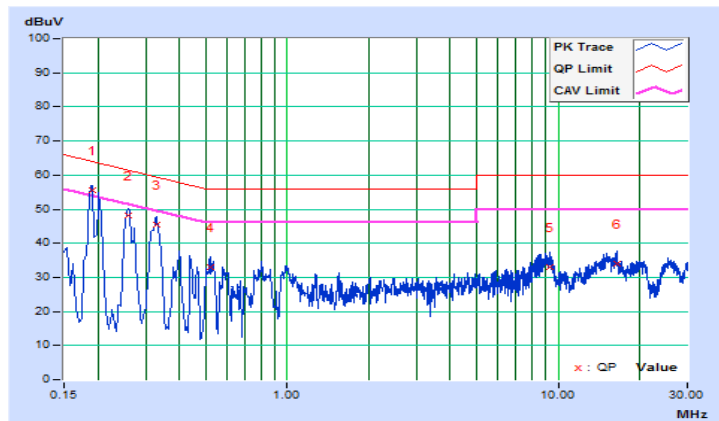

Phase	Neutral (N)	Detector Function	Quasi-Peak (QP) / Average (AV)
-------	-------------	-------------------	--------------------------------

No	Freq. [MHz]	Corr. Factor (dB)	Reading Value [dB (uV)]		Emission Level [dB (uV)]		Limit [dB (uV)]		Margin (dB)	
			Q.P.	AV.	Q.P.	AV.	Q.P.	AV.	Q.P.	AV.
			1	0.19000	10.13	44.95	31.08	55.08	41.21	64.04
2	0.25810	10.15	36.79	23.99	46.94	34.14	61.49	51.49	-14.55	-17.35
3	0.33000	10.15	33.63	23.75	43.78	33.90	59.45	49.45	-15.67	-15.55
4	0.40200	10.16	24.95	9.07	35.11	19.23	57.81	47.81	-22.70	-28.58
5	0.51800	10.16	23.35	12.03	33.51	22.19	56.00	46.00	-22.49	-23.81
6	9.32600	10.53	23.61	15.36	34.14	25.89	60.00	50.00	-25.86	-24.11

Remarks:

1. Q.P. and AV. are abbreviations of quasi-peak and average individually.
2. The emission levels of other frequencies were very low against the limit.
3. Margin value = Emission level - Limit value
4. Correction factor = Insertion loss + Cable loss
5. Emission Level = Correction Factor + Reading Value.

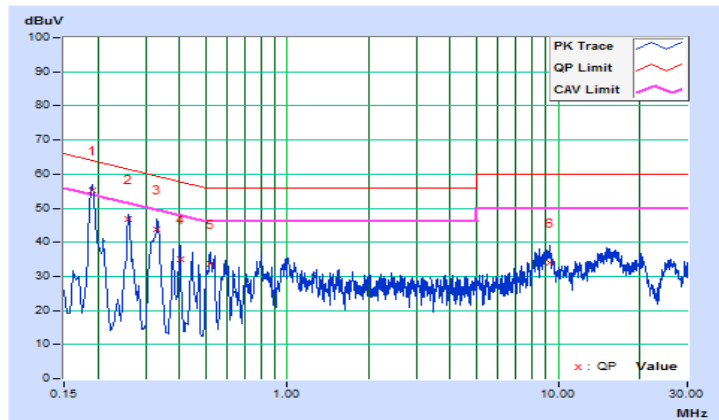

Test Mode C

Phase	Line (L)	Detector Function	Quasi-Peak (QP) / Average (AV)
-------	----------	-------------------	--------------------------------

No	Freq. [MHz]	Corr. Factor (dB)	Reading Value [dB (uV)]		Emission Level [dB (uV)]		Limit [dB (uV)]		Margin (dB)	
			Q.P.	AV.	Q.P.	AV.	Q.P.	AV.	Q.P.	AV.
			1	0.19832	10.37	42.89	31.60	53.26	41.97	63.68
2	0.27000	10.38	35.30	20.92	45.68	31.30	61.12	51.12	-15.44	-19.82
3	0.32600	10.39	34.41	26.38	44.80	36.77	59.55	49.55	-14.75	-12.78
4	0.39445	10.40	24.34	13.50	34.74	23.90	57.97	47.97	-23.23	-24.07
5	0.80551	10.40	23.44	10.66	33.84	21.06	56.00	46.00	-22.16	-24.94
6	9.12600	10.79	21.97	14.57	32.76	25.36	60.00	50.00	-27.24	-24.64

Remarks:

1. Q.P. and AV. are abbreviations of quasi-peak and average individually.
2. The emission levels of other frequencies were very low against the limit.
3. Margin value = Emission level - Limit value
4. Correction factor = Insertion loss + Cable loss
5. Emission Level = Correction Factor + Reading Value.

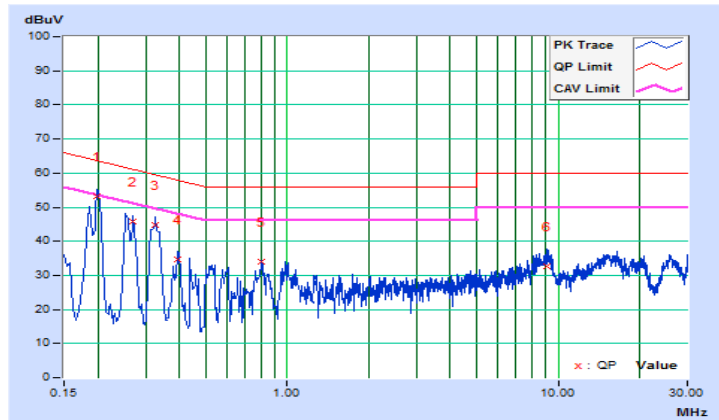

Phase	Neutral (N)	Detector Function	Quasi-Peak (QP) / Average (AV)
-------	-------------	-------------------	--------------------------------

No	Freq. [MHz]	Corr. Factor (dB)	Reading Value [dB (uV)]		Emission Level [dB (uV)]		Limit [dB (uV)]		Margin (dB)	
			Q.P.	AV.	Q.P.	AV.	Q.P.	AV.	Q.P.	AV.
			1	0.20201	10.14	41.41	26.85	51.55	36.99	63.53
2	0.25338	10.15	35.08	20.72	45.23	30.87	61.65	51.65	-16.42	-20.78
3	0.32203	10.15	33.64	24.05	43.79	34.20	59.65	49.65	-15.86	-15.45
4	0.60603	10.16	21.98	8.50	32.14	18.66	56.00	46.00	-23.86	-27.34
5	1.00239	10.17	22.49	11.75	32.66	21.92	56.00	46.00	-23.34	-24.08
6	9.12600	10.52	23.68	16.29	34.20	26.81	60.00	50.00	-25.80	-23.19

Remarks:

1. Q.P. and AV. are abbreviations of quasi-peak and average individually.
2. The emission levels of other frequencies were very low against the limit.
3. Margin value = Emission level - Limit value
4. Correction factor = Insertion loss + Cable loss
5. Emission Level = Correction Factor + Reading Value.

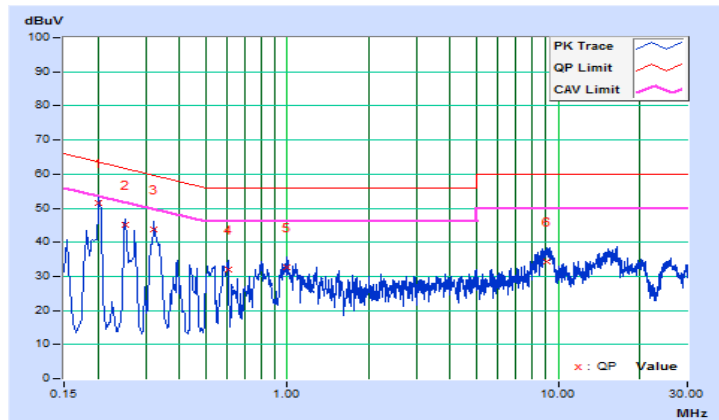

Test Mode D

Phase	Line (L)	Detector Function	Quasi-Peak (QP) / Average (AV)
-------	----------	-------------------	--------------------------------

No	Freq. [MHz]	Corr. Factor (dB)	Reading Value [dB (uV)]		Emission Level [dB (uV)]		Limit [dB (uV)]		Margin (dB)	
			Q.P.	AV.	Q.P.	AV.	Q.P.	AV.	Q.P.	AV.
			1	0.19000	10.36	43.64	30.28	54.00	40.64	64.04
2	0.25742	10.38	36.49	25.63	46.87	36.01	61.51	51.51	-14.64	-15.50
3	0.32802	10.39	34.14	26.29	44.53	36.68	59.50	49.50	-14.97	-12.82
4	0.51800	10.40	21.84	11.63	32.24	22.03	56.00	46.00	-23.76	-23.97
5	9.12200	10.79	21.19	14.21	31.98	25.00	60.00	50.00	-28.02	-25.00
6	15.23400	11.10	23.47	16.70	34.57	27.80	60.00	50.00	-25.43	-22.20

Remarks:

1. Q.P. and AV. are abbreviations of quasi-peak and average individually.
2. The emission levels of other frequencies were very low against the limit.
3. Margin value = Emission level - Limit value
4. Correction factor = Insertion loss + Cable loss
5. Emission Level = Correction Factor + Reading Value.

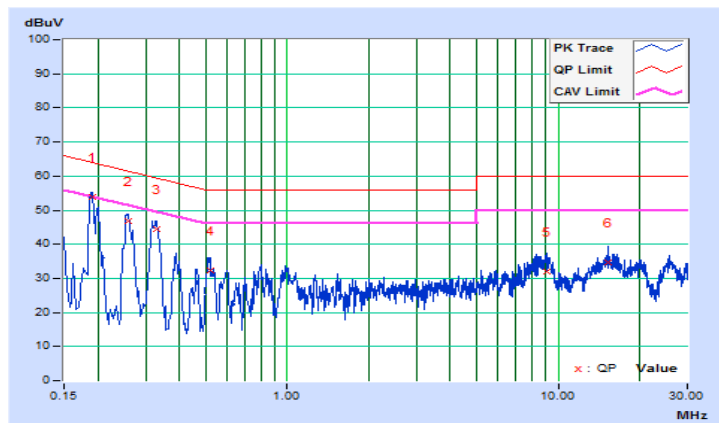

Phase	Neutral (N)	Detector Function	Quasi-Peak (QP) / Average (AV)
-------	-------------	-------------------	--------------------------------

No	Freq. [MHz]	Corr. Factor (dB)	Reading Value [dB (uV)]		Emission Level [dB (uV)]		Limit [dB (uV)]		Margin (dB)	
			Q.P.	AV.	Q.P.	AV.	Q.P.	AV.	Q.P.	AV.
			1	0.19832	10.14	42.32	31.22	52.46	41.36	63.68
2	0.26992	10.15	35.08	18.65	45.23	28.80	61.12	51.12	-15.89	-22.32
3	0.31800	10.15	33.54	23.22	43.69	33.37	59.76	49.76	-16.07	-16.39
4	0.50600	10.16	23.38	10.66	33.54	20.82	56.00	46.00	-22.46	-25.18
5	0.78600	10.17	21.97	9.84	32.14	20.01	56.00	46.00	-23.86	-25.99
6	9.08600	10.52	23.82	15.24	34.34	25.76	60.00	50.00	-25.66	-24.24

Remarks:

1. Q.P. and AV. are abbreviations of quasi-peak and average individually.
2. The emission levels of other frequencies were very low against the limit.
3. Margin value = Emission level - Limit value
4. Correction factor = Insertion loss + Cable loss
5. Emission Level = Correction Factor + Reading Value.

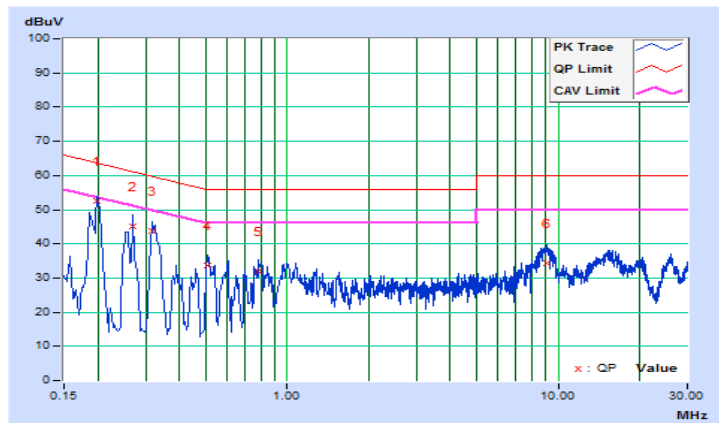

Test Mode E

Phase	Line (L)	Detector Function	Quasi-Peak (QP) / Average (AV)
-------	----------	-------------------	--------------------------------

No	Freq. [MHz]	Corr. Factor (dB)	Reading Value [dB (uV)]		Emission Level [dB (uV)]		Limit [dB (uV)]		Margin (dB)	
			Q.P.	AV.	Q.P.	AV.	Q.P.	AV.	Q.P.	AV.
			1	0.20201	10.37	46.19	31.13	56.56	41.50	63.53
2	0.25400	10.38	37.79	23.15	48.17	33.53	61.63	51.63	-13.46	-18.10
3	0.32203	10.39	36.48	24.11	46.87	34.50	59.65	49.65	-12.78	-15.15
4	0.53404	10.40	23.48	9.34	33.88	19.74	56.00	46.00	-22.12	-26.26
5	9.10600	10.79	23.83	15.17	34.62	25.96	60.00	50.00	-25.38	-24.04
6	15.11800	11.09	23.69	17.29	34.78	28.38	60.00	50.00	-25.22	-21.62

Remarks:

1. Q.P. and AV. are abbreviations of quasi-peak and average individually.
2. The emission levels of other frequencies were very low against the limit.
3. Margin value = Emission level - Limit value
4. Correction factor = Insertion loss + Cable loss
5. Emission Level = Correction Factor + Reading Value.

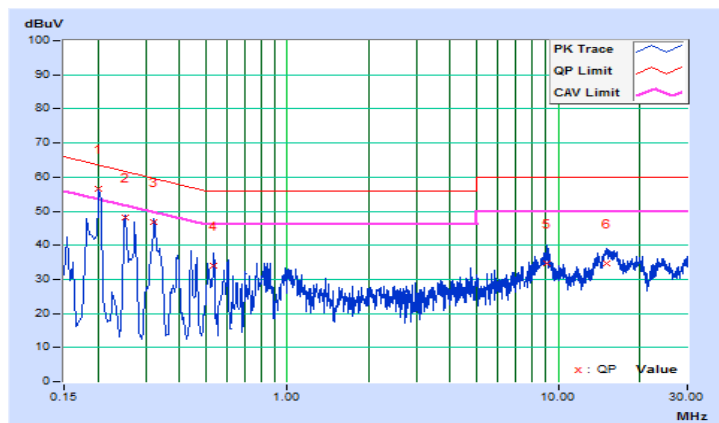

Phase	Neutral (N)	Detector Function	Quasi-Peak (QP) / Average (AV)
-------	-------------	-------------------	--------------------------------

No	Freq. [MHz]	Corr. Factor (dB)	Reading Value [dB (uV)]		Emission Level [dB (uV)]		Limit [dB (uV)]		Margin (dB)	
			Q.P.	AV.	Q.P.	AV.	Q.P.	AV.	Q.P.	AV.
			1	0.19418	10.14	47.56	35.87	57.70	46.01	63.86
2	0.26569	10.15	39.62	26.51	49.77	36.66	61.25	51.25	-11.48	-14.59
3	0.33413	10.15	35.16	23.99	45.31	34.14	59.35	49.35	-14.04	-15.21
4	0.52600	10.16	22.32	9.78	32.48	19.94	56.00	46.00	-23.52	-26.06
5	8.92600	10.51	20.02	11.71	30.53	22.22	60.00	50.00	-29.47	-27.78
6	15.25800	10.76	21.56	14.53	32.32	25.29	60.00	50.00	-27.68	-24.71

Remarks:

1. Q.P. and AV. are abbreviations of quasi-peak and average individually.
2. The emission levels of other frequencies were very low against the limit.
3. Margin value = Emission level - Limit value
4. Correction factor = Insertion loss + Cable loss
5. Emission Level = Correction Factor + Reading Value.

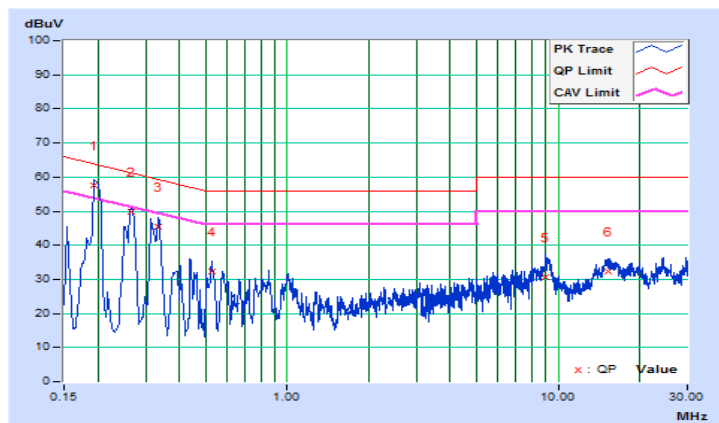

4.3 6dB Bandwidth Measurement

4.3.1 Limits of 6dB Bandwidth Measurement

The minimum of 6dB Bandwidth Measurement is 0.5 MHz.

4.3.2 Test Setup

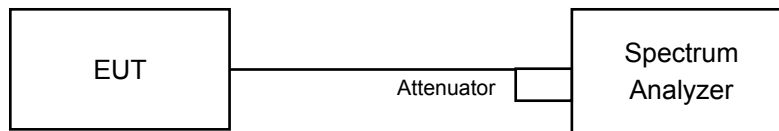

4.3.3 Test Instruments

Refer to section 4.1.2 to get information of above instrument.

4.3.4 Test Procedure

- Set resolution bandwidth (RBW) = 100kHz
- Set the video bandwidth (VBW) $\geq 3 \times$ RBW, Detector = average.
- Trace mode = max hold.
- Sweep = auto couple.
- Measure the maximum width of the emission that is constrained by the frequencies associated with the two amplitude points (upper and lower) that are attenuated by 6 dB relative to the maximum level measured in the fundamental emission

4.3.5 Deviation from Test Standard

No deviation.

4.3.6 EUT Operating Conditions

The software provided by client to enable the EUT under transmission condition continuously at lowest, middle and highest channel frequencies individually.

4.3.7 Test Result

Test Mode A

802.11b

Channel	Frequency (MHz)	6dB Bandwidth (MHz)				Minimum Limit (MHz)	Pass / Fail
		Chain 0	Chain 1	Chain 2	Chain 3		
1	2412	8.58	8.09	8.59	9.09	0.5	Pass
6	2437	9.05	9.56	9.07	9.03	0.5	Pass
11	2462	8.60	9.58	8.59	8.09	0.5	Pass

802.11g

Channel	Frequency (MHz)	6dB Bandwidth (MHz)				Minimum Limit (MHz)	Pass / Fail
		Chain 0	Chain 1	Chain 2	Chain 3		
1	2412	16.37	16.36	16.35	16.38	0.5	Pass
6	2437	16.35	16.32	16.39	16.37	0.5	Pass
11	2462	16.35	15.36	16.38	16.37	0.5	Pass

802.11n (HT20)

Channel	Frequency (MHz)	6dB Bandwidth (MHz)				Minimum Limit (MHz)	Pass / Fail
		Chain 0	Chain 1	Chain 2	Chain 3		
1	2412	16.95	16.61	17.56	17.61	0.5	Pass
6	2437	16.95	16.57	17.59	17.58	0.5	Pass
11	2462	16.93	16.30	17.35	17.58	0.5	Pass

802.11n (HT40)

Channel	Frequency (MHz)	6dB Bandwidth (MHz)				Minimum Limit (MHz)	Pass / Fail
		Chain 0	Chain 1	Chain 2	Chain 3		
3	2422	33.95	35.28	35.23	35.20	0.5	Pass
6	2437	35.19	35.15	35.08	35.12	0.5	Pass
9	2452	35.19	35.11	35.18	35.05	0.5	Pass

Spectrum Plot of Worst Value

802.11b

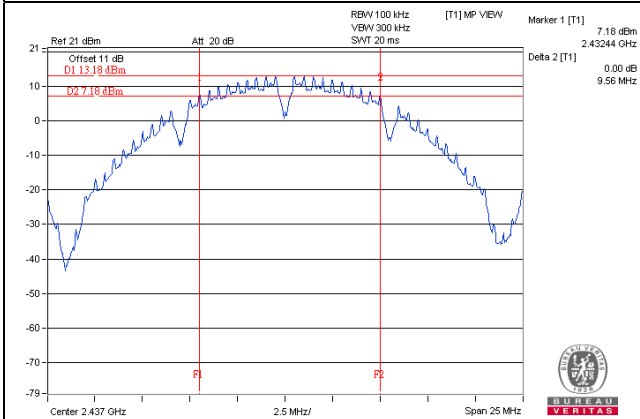

802.11g

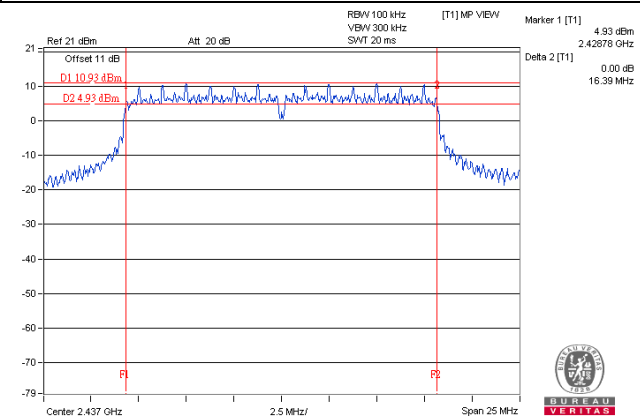

802.11n (HT20)

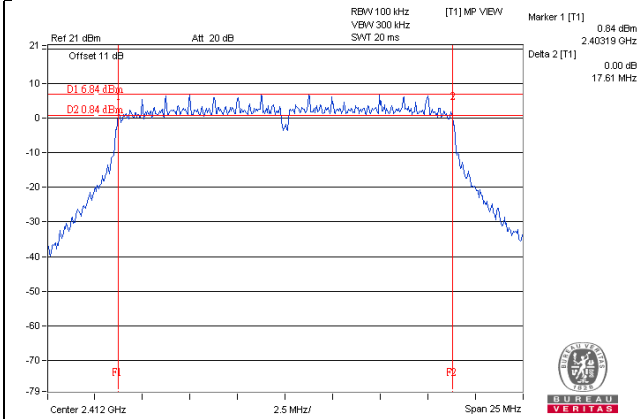

802.11n (HT40)

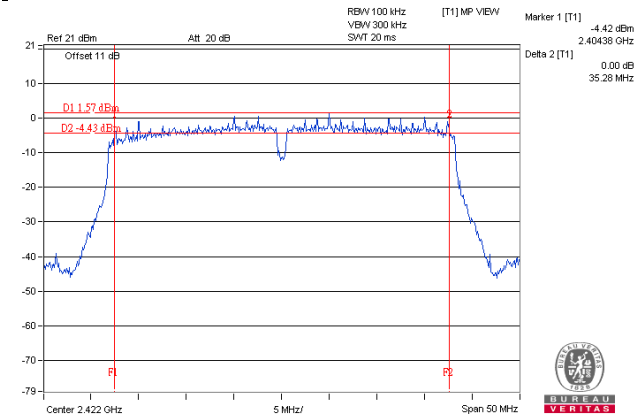

Test Mode B

802.11b

Channel	Frequency (MHz)	6dB Bandwidth (MHz)				Minimum Limit (MHz)	Pass / Fail
		Chain 0	Chain 1	Chain 2	Chain 3		
1	2412	8.11	8.09	8.58	8.08	0.5	Pass
6	2437	8.10	7.59	9.05	8.09	0.5	Pass
11	2462	8.57	7.62	8.60	8.10	0.5	Pass

802.11g

Channel	Frequency (MHz)	6dB Bandwidth (MHz)				Minimum Limit (MHz)	Pass / Fail
		Chain 0	Chain 1	Chain 2	Chain 3		
1	2412	16.34	15.92	16.07	16.33	0.5	Pass
6	2437	16.35	15.33	16.31	16.35	0.5	Pass
11	2462	16.37	15.35	15.45	16.39	0.5	Pass

802.11n (HT20)

Channel	Frequency (MHz)	6dB Bandwidth (MHz)				Minimum Limit (MHz)	Pass / Fail
		Chain 0	Chain 1	Chain 2	Chain 3		
1	2412	16.59	16.33	16.96	16.98	0.5	Pass
6	2437	16.92	15.16	16.53	17.20	0.5	Pass
11	2462	17.19	15.18	16.32	17.61	0.5	Pass

802.11n (HT40)

Channel	Frequency (MHz)	6dB Bandwidth (MHz)				Minimum Limit (MHz)	Pass / Fail
		Chain 0	Chain 1	Chain 2	Chain 3		
3	2422	35.28	35.17	35.26	33.89	0.5	Pass
6	2437	35.21	33.93	35.11	35.12	0.5	Pass
9	2452	35.16	35.17	33.94	35.11	0.5	Pass

Spectrum Plot of Worst Value

802.11b

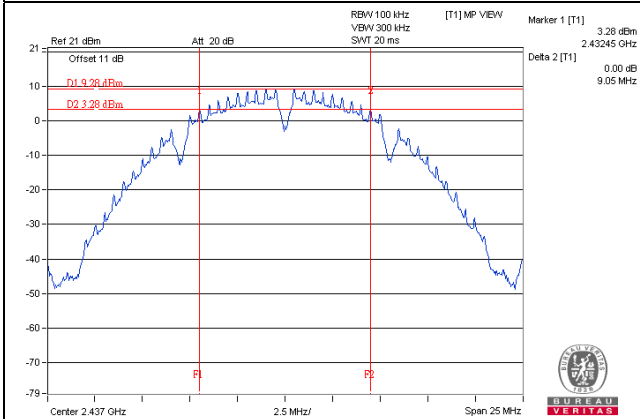

802.11g

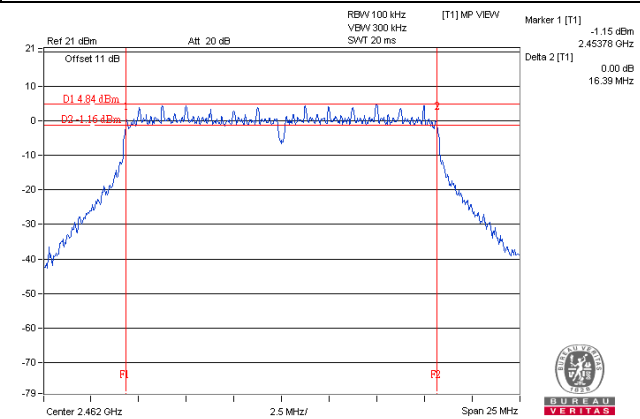

802.11n (HT20)

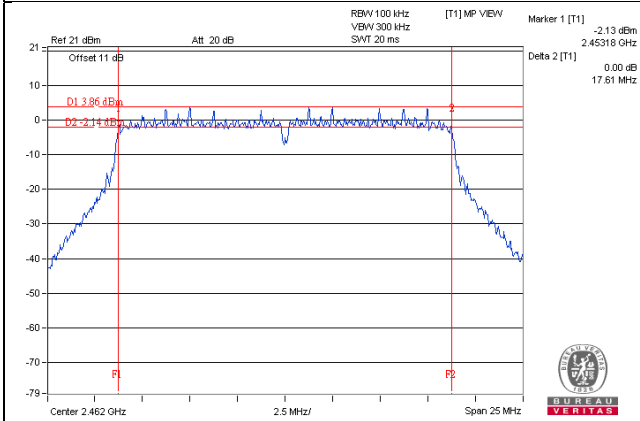

802.11n (HT40)

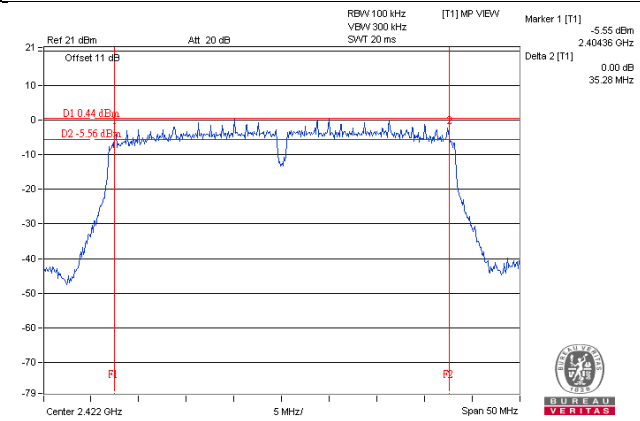

Test Mode C

802.11b

Channel	Frequency (MHz)	6dB Bandwidth (MHz)				Minimum Limit (MHz)	Pass / Fail
		Chain 0	Chain 1	Chain 2	Chain 3		
1	2412	8.07	9.06	9.08	9.05	0.5	Pass
6	2437	8.10	9.08	8.61	8.59	0.5	Pass
11	2462	8.09	7.60	9.09	8.10	0.5	Pass

802.11g

Channel	Frequency (MHz)	6dB Bandwidth (MHz)				Minimum Limit (MHz)	Pass / Fail
		Chain 0	Chain 1	Chain 2	Chain 3		
1	2412	16.36	15.98	16.08	16.35	0.5	Pass
6	2437	16.33	15.92	16.33	16.35	0.5	Pass
11	2462	16.32	15.14	15.36	16.38	0.5	Pass

802.11n (HT20)

Channel	Frequency (MHz)	6dB Bandwidth (MHz)				Minimum Limit (MHz)	Pass / Fail
		Chain 0	Chain 1	Chain 2	Chain 3		
1	2412	17.22	16.36	16.57	16.62	0.5	Pass
6	2437	17.19	15.73	16.32	17.19	0.5	Pass
11	2462	17.18	15.33	16.34	17.58	0.5	Pass

802.11n (HT40)

Channel	Frequency (MHz)	6dB Bandwidth (MHz)				Minimum Limit (MHz)	Pass / Fail
		Chain 0	Chain 1	Chain 2	Chain 3		
3	2422	35.18	33.93	35.19	35.12	0.5	Pass
6	2437	35.15	35.16	32.69	35.16	0.5	Pass
9	2452	35.15	35.23	35.17	33.81	0.5	Pass

Spectrum Plot of Worst Value

802.11b

802.11g

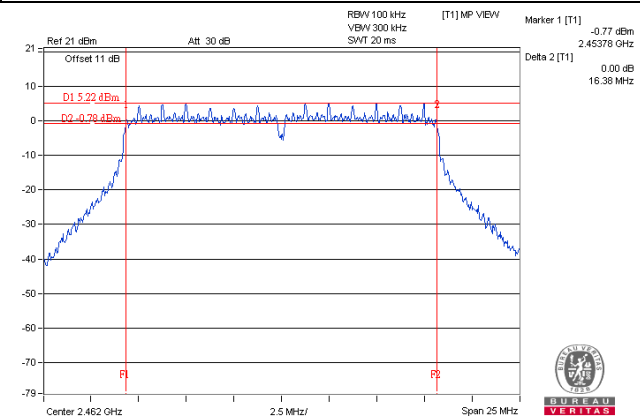
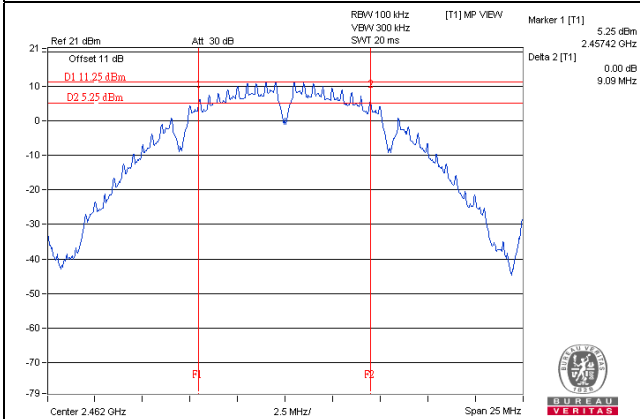

802.11n (HT20)

802.11n (HT40)

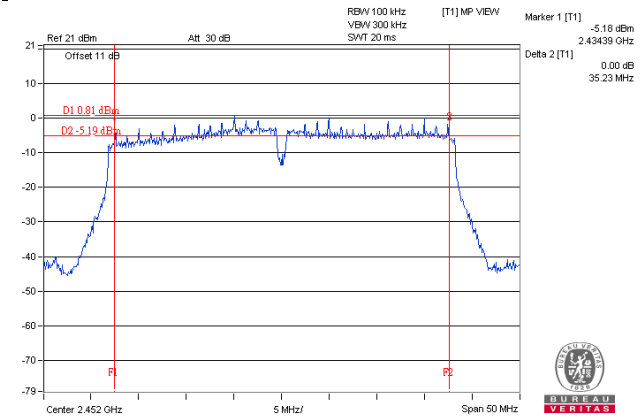
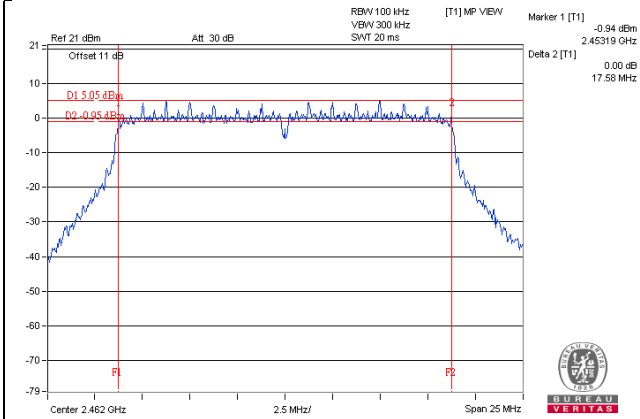

Test Mode D

802.11b

Channel	Frequency (MHz)	6dB Bandwidth (MHz)				Minimum Limit (MHz)	Pass / Fail
		Chain 0	Chain 1	Chain 2	Chain 3		
1	2412	8.11	8.07	8.07	9.07	0.5	Pass
6	2437	8.10	8.56	7.12	8.57	0.5	Pass
11	2462	8.11	8.59	8.61	8.07	0.5	Pass

802.11g

Channel	Frequency (MHz)	6dB Bandwidth (MHz)				Minimum Limit (MHz)	Pass / Fail
		Chain 0	Chain 1	Chain 2	Chain 3		
1	2412	16.35	16.32	15.93	16.36	0.5	Pass
6	2437	16.35	16.34	15.66	16.38	0.5	Pass
11	2462	16.33	15.19	15.19	16.38	0.5	Pass

802.11n (HT20)

Channel	Frequency (MHz)	6dB Bandwidth (MHz)				Minimum Limit (MHz)	Pass / Fail
		Chain 0	Chain 1	Chain 2	Chain 3		
1	2412	17.18	16.95	15.96	17.21	0.5	Pass
6	2437	17.17	16.56	15.70	17.19	0.5	Pass
11	2462	17.15	16.32	15.74	17.31	0.5	Pass

802.11n (HT40)

Channel	Frequency (MHz)	6dB Bandwidth (MHz)				Minimum Limit (MHz)	Pass / Fail
		Chain 0	Chain 1	Chain 2	Chain 3		
3	2422	35.22	35.31	35.23	35.14	0.5	Pass
6	2437	35.14	33.94	35.10	35.09	0.5	Pass
9	2452	35.15	33.94	35.16	35.12	0.5	Pass

Spectrum Plot of Worst Value

802.11b

802.11g

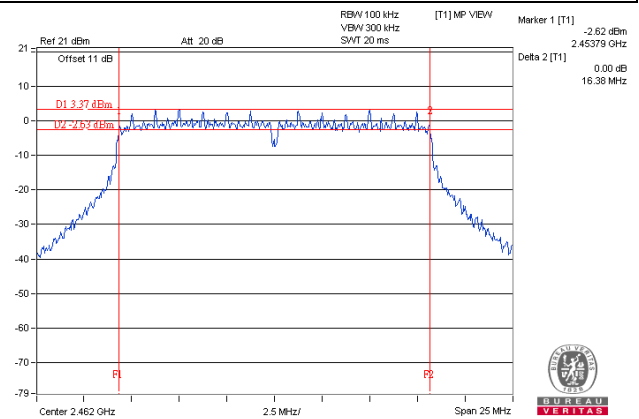
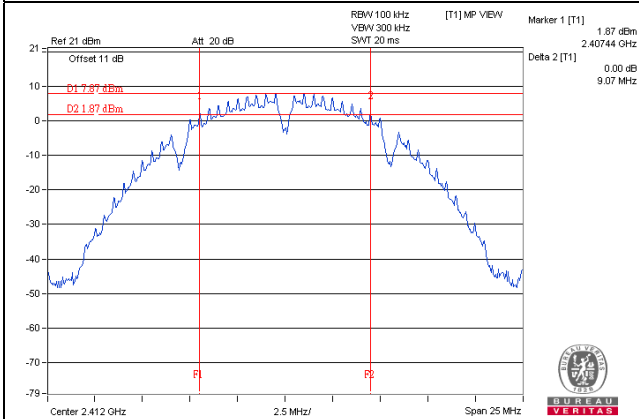

802.11n (HT20)

802.11n (HT40)

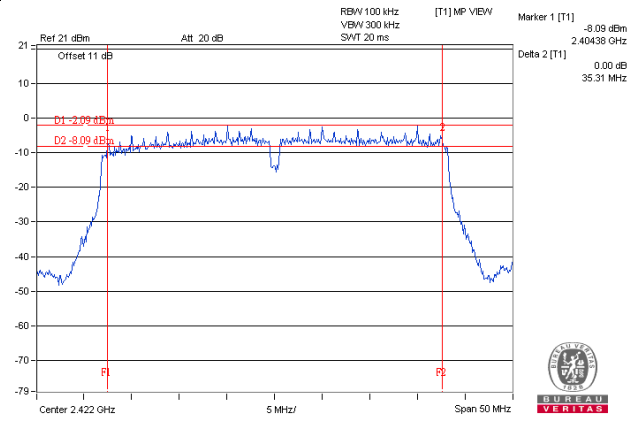
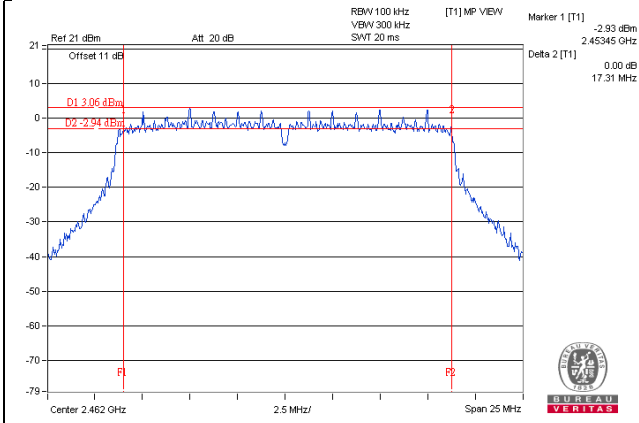

Test Mode E

802.11b

Channel	Frequency (MHz)	6dB Bandwidth (MHz)	Minimum Limit (MHz)	Pass / Fail
1	2412	7.09	0.5	Pass
6	2437	7.09	0.5	Pass
11	2462	7.07	0.5	Pass

802.11g

Channel	Frequency (MHz)	6dB Bandwidth (MHz)	Minimum Limit (MHz)	Pass / Fail
1	2412	16.35	0.5	Pass
6	2437	16.36	0.5	Pass
11	2462	16.32	0.5	Pass

802.11n (HT20)

Channel	Frequency (MHz)	6dB Bandwidth (MHz)	Minimum Limit (MHz)	Pass / Fail
1	2412	17.29	0.5	Pass
6	2437	17.56	0.5	Pass
11	2462	16.69	0.5	Pass

802.11n (HT40)

Channel	Frequency (MHz)	6dB Bandwidth (MHz)	Minimum Limit (MHz)	Pass / Fail
3	2422	35.34	0.5	Pass
6	2437	35.39	0.5	Pass
9	2452	35.41	0.5	Pass

Spectrum Plot of Worst Value

802.11b

802.11g

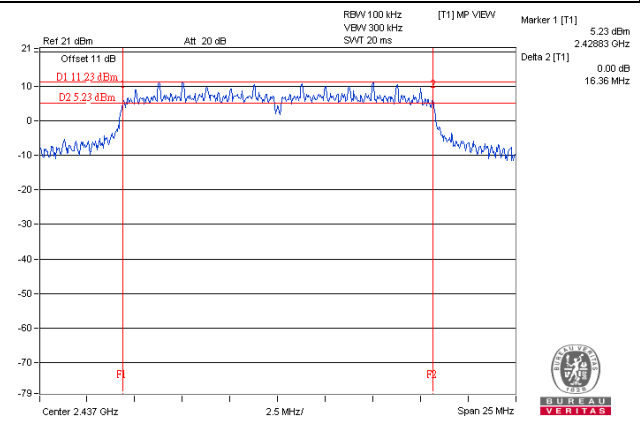
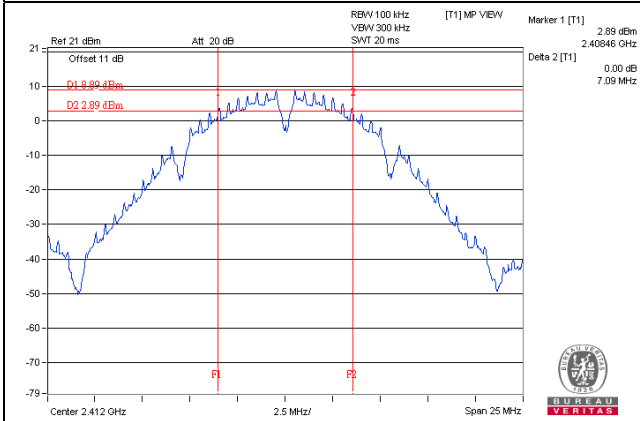

802.11n (HT20)

802.11n (HT40)

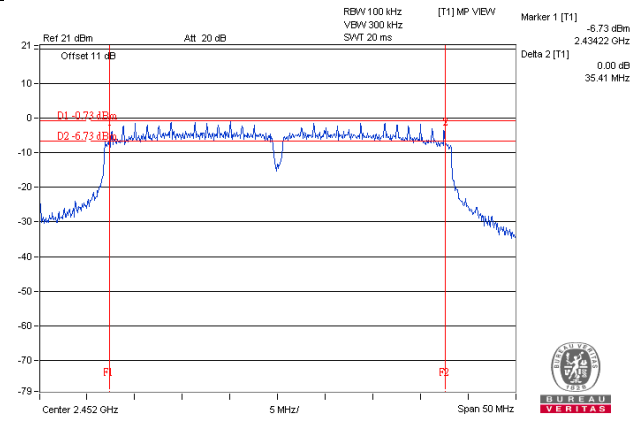
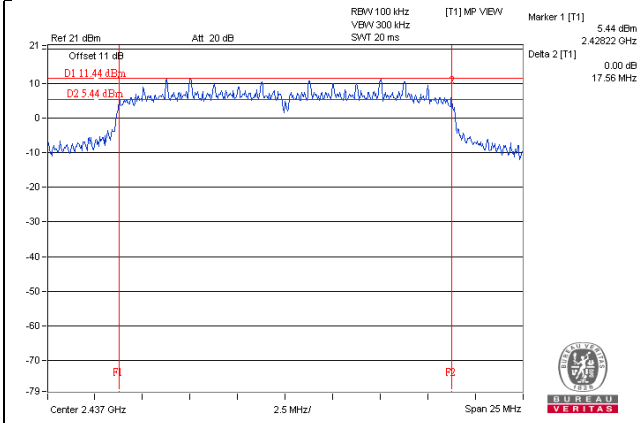

4.4 Conducted Output Power Measurement

4.4.1 Limits of Conducted Output Power Measurement

For systems using digital modulation in the 2400–2483.5 MHz bands: 1 Watt (30dBm)

Per KDB 662911 D01 Multiple Transmitter Output Method of conducted output power measurement on IEEE 802.11 devices,

Array Gain = 0 dB (i.e., no array gain) for $N_{ANT} \leq 4$;

Array Gain = 0 dB (i.e., no array gain) for channel widths ≥ 40 MHz for any N_{ANT} ;

Array Gain = $5 \log(N_{ANT}/N_{SS})$ dB or 3 dB, whichever is less for 20-MHz channel widths with $N_{ANT} \geq 5$.

For power measurements on all other devices: Array Gain = $10 \log(N_{ANT}/N_{SS})$ dB.

4.4.2 Test Setup

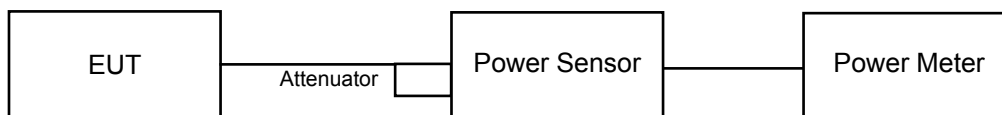

4.4.3 Test Instruments

Refer to section 4.1.2 to get information of above instrument.

4.4.4 Test Procedures

An average power sensor was used on the output port of the EUT. A power meter was used to read the response of the average power sensor. Record the power level.

4.4.5 Deviation from Test Standard

No deviation.

4.4.6 EUT Operating Conditions

Same as Item 4.3.6.

4.4.7 Test Results

Test Mode A

CDD Mode:

802.11b

Channel	Frequency (MHz)	Average Power (dBm)				Total Power (mW)	Total Power (dBm)	Limit (dBm)	Pass / Fail
		Chain 0	Chain 1	Chain 2	Chain 3				
1	2412	21.11	20.47	19.88	21.05	465.176	26.68	30	Pass
6	2437	22.09	21.91	22.12	22.36	652.164	28.14	30	Pass
11	2462	20.49	21.51	21.30	20.89	511.163	27.09	30	Pass

802.11g

Channel	Frequency (MHz)	Average Power (dBm)				Total Power (mW)	Total Power (dBm)	Limit (dBm)	Pass / Fail
		Chain 0	Chain 1	Chain 2	Chain 3				
1	2412	17.66	18.01	17.05	17.78	232.264	23.66	30	Pass
6	2437	21.85	22.12	21.66	21.84	615.351	27.89	30	Pass
11	2462	17.93	18.38	17.23	17.72	242.953	23.86	30	Pass

802.11n (HT20)

Channel	Frequency (MHz)	Average Power (dBm)				Total Power (mW)	Total Power (dBm)	Limit (dBm)	Pass / Fail
		Chain 0	Chain 1	Chain 2	Chain 3				
1	2412	17.16	17.37	16.74	17.40	208.736	23.20	30	Pass
6	2437	21.17	21.33	20.98	21.17	522.981	27.18	30	Pass
11	2462	17.05	17.46	16.47	16.85	199.196	22.99	30	Pass

802.11n (HT40)

Channel	Frequency (MHz)	Average Power (dBm)				Total Power (mW)	Total Power (dBm)	Limit (dBm)	Pass / Fail
		Chain 0	Chain 1	Chain 2	Chain 3				
3	2422	14.90	14.72	14.76	14.59	119.248	20.76	30	Pass
6	2437	17.02	16.75	16.49	16.92	191.435	22.82	30	Pass
9	2452	11.81	11.88	11.51	11.59	59.167	17.72	30	Pass

Beamforming Mode:

802.11n (HT20)

Channel	Frequency (MHz)	Average Power (dBm)				Total Power (mW)	Total Power (dBm)	Limit (dBm)	Pass / Fail
		Chain 0	Chain 1	Chain 2	Chain 3				
1	2412	11.14	11.35	10.72	11.38	52.191	17.18	25.48	Pass
6	2437	15.15	15.31	14.96	15.15	130.764	21.16	25.48	Pass
11	2462	11.03	11.44	10.45	10.83	49.806	16.97	25.48	Pass

* Directional gain = $4.5\text{dBi} + 10\log(4) = 10.52\text{dBi} > 6\text{dBi}$, so the power limit shall be reduced to $30 - (10.52 - 6) = 25.48\text{dBm}$.

802.11n (HT40)

Channel	Frequency (MHz)	Average Power (dBm)				Total Power (mW)	Total Power (dBm)	Limit (dBm)	Pass / Fail
		Chain 0	Chain 1	Chain 2	Chain 3				
3	2422	8.88	8.70	8.74	8.57	29.816	14.74	25.48	Pass
6	2437	11.00	10.73	10.47	10.90	47.865	16.80	25.48	Pass
9	2452	5.79	5.86	5.49	5.57	14.794	11.70	25.48	Pass

* Directional gain = $4.5\text{dBi} + 10\log(4) = 10.52\text{dBi} > 6\text{dBi}$, so the power limit shall be reduced to $30 - (10.52 - 6) = 25.48\text{dBm}$.

Test Mode B

CDD Mode:

802.11b

Channel	Frequency (MHz)	Average Power (dBm)				Total Power (mW)	Total Power (dBm)	Limit (dBm)	Pass / Fail
		Chain 0	Chain 1	Chain 2	Chain 3				
1	2412	16.63	17.71	17.50	16.73	208.378	23.19	23.40	Pass
6	2437	16.93	17.71	16.38	17.52	208.282	23.19	23.40	Pass
11	2462	16.44	17.16	16.94	16.65	191.724	22.83	23.40	Pass

*Max. Gain: 12.60dBi, so the power limit shall be reduced to $30-(12.60-6) = 23.40$ dBm.

802.11g

Channel	Frequency (MHz)	Average Power (dBm)				Total Power (mW)	Total Power (dBm)	Limit (dBm)	Pass / Fail
		Chain 0	Chain 1	Chain 2	Chain 3				
1	2412	16.64	16.95	16.26	16.70	184.718	22.67	23.40	Pass
6	2437	17.15	17.57	16.93	17.27	211.678	23.26	23.40	Pass
11	2462	15.34	15.78	15.15	15.11	137.210	21.37	23.40	Pass

*Max. Gain: 12.60dBi, so the power limit shall be reduced to $30-(12.60-6) = 23.40$ dBm.

802.11n (HT20)

Channel	Frequency (MHz)	Average Power (dBm)				Total Power (mW)	Total Power (dBm)	Limit (dBm)	Pass / Fail
		Chain 0	Chain 1	Chain 2	Chain 3				
1	2412	16.37	16.54	16.00	16.45	172.401	22.37	23.40	Pass
6	2437	17.36	17.42	16.95	17.41	214.284	23.31	23.40	Pass
11	2462	14.52	14.92	14.40	14.32	113.942	20.57	23.40	Pass

*Max. Gain: 12.60dBi, so the power limit shall be reduced to $30-(12.60-6) = 23.40$ dBm.

802.11n (HT40)

Channel	Frequency (MHz)	Average Power (dBm)				Total Power (mW)	Total Power (dBm)	Limit (dBm)	Pass / Fail
		Chain 0	Chain 1	Chain 2	Chain 3				
3	2422	13.84	13.57	13.85	13.60	94.136	19.74	23.40	Pass
6	2437	16.46	16.17	16.26	16.24	169.999	22.30	23.40	Pass
9	2452	11.84	11.89	11.57	11.69	59.841	17.77	23.40	Pass

*Max. Gain: 12.60dBi, so the power limit shall be reduced to $30-(12.60-6) = 23.40$ dBm.

Beamforming Mode:

802.11n (HT20)

Channel	Frequency (MHz)	Average Power (dBm)				Total Power (mW)	Total Power (dBm)	Limit (dBm)	Pass / Fail
		Chain 0	Chain 1	Chain 2	Chain 3				
1	2412	10.35	10.52	9.98	10.43	43.106	16.35	17.73	Pass
6	2437	11.34	11.40	10.93	11.39	53.578	17.29	17.73	Pass
11	2462	8.50	8.90	8.38	8.30	28.489	14.55	17.73	Pass

*Directional gain = $10 \log[(10^{G1/20} + 10^{G2/20} + \dots + 10^{GN/20})^2/4]$ = 18.27dBi > 6dBi, so the power limit shall be reduced to $30-(18.27-6) = 17.73$ dBm.

802.11n (HT40)

Channel	Frequency (MHz)	Average Power (dBm)				Total Power (mW)	Total Power (dBm)	Limit (dBm)	Pass / Fail
		Chain 0	Chain 1	Chain 2	Chain 3				
3	2422	7.82	7.55	7.83	7.58	23.537	13.72	17.73	Pass
6	2437	10.44	10.15	10.24	10.22	42.505	16.28	17.73	Pass
9	2452	5.82	5.87	5.55	5.67	14.962	11.75	17.73	Pass

*Directional gain = $10 \log[(10^{G1/20} + 10^{G2/20} + \dots + 10^{GN/20})^2/4]$ = 18.27dBi > 6dBi, so the power limit shall be reduced to $30-(18.27-6) = 17.73$ dBm.

Test Mode C

CDD Mode:

802.11b

Channel	Frequency (MHz)	Average Power (dBm)				Total Power (mW)	Total Power (dBm)	Limit (dBm)	Pass / Fail
		Chain 0	Chain 1	Chain 2	Chain 3				
1	2412	19.85	20.44	20.78	20.12	429.743	26.33	27.38	Pass
6	2437	21.58	21.11	21.09	20.72	519.563	27.16	27.38	Pass
11	2462	19.13	20.09	19.94	19.01	362.184	25.59	27.38	Pass

*Max. Gain: 8.62dBi, so the power limit shall be reduced to $30-(8.62-6) = 27.38\text{dBm}$.

802.11g

Channel	Frequency (MHz)	Average Power (dBm)				Total Power (mW)	Total Power (dBm)	Limit (dBm)	Pass / Fail
		Chain 0	Chain 1	Chain 2	Chain 3				
1	2412	17.30	17.48	16.83	17.23	210.719	23.24	27.38	Pass
6	2437	20.86	21.19	20.75	21.13	501.989	27.01	27.38	Pass
11	2462	15.88	16.39	15.53	15.81	156.111	21.93	27.38	Pass

*Max. Gain: 8.62dBi, so the power limit shall be reduced to $30-(8.62-6) = 27.38\text{dBm}$.

802.11n (HT20)

Channel	Frequency (MHz)	Average Power (dBm)				Total Power (mW)	Total Power (dBm)	Limit (dBm)	Pass / Fail
		Chain 0	Chain 1	Chain 2	Chain 3				
1	2412	16.94	17.20	16.56	17.08	198.252	22.97	27.38	Pass
6	2437	20.67	20.95	20.46	20.96	477.043	26.79	27.38	Pass
11	2462	15.67	16.06	15.21	15.53	146.179	21.65	27.38	Pass

*Max. Gain: 8.62dBi, so the power limit shall be reduced to $30-(8.62-6) = 27.38\text{dBm}$.

802.11n (HT40)

Channel	Frequency (MHz)	Average Power (dBm)				Total Power (mW)	Total Power (dBm)	Limit (dBm)	Pass / Fail
		Chain 0	Chain 1	Chain 2	Chain 3				
3	2422	14.36	14.22	14.22	14.11	105.901	20.25	27.38	Pass
6	2437	17.09	16.91	16.86	16.88	197.541	22.96	27.38	Pass
9	2452	13.51	13.49	13.12	13.12	85.799	19.33	27.38	Pass

*Max. Gain: 8.62dBi, so the power limit shall be reduced to $30-(8.62-6) = 27.38\text{dBm}$.

Beamforming Mode:

802.11n (HT20)

Channel	Frequency (MHz)	Average Power (dBm)				Total Power (mW)	Total Power (dBm)	Limit (dBm)	Pass / Fail
		Chain 0	Chain 1	Chain 2	Chain 3				
1	2412	10.92	11.18	10.54	11.06	49.570	16.95	22.13	Pass
6	2437	14.65	14.93	14.44	14.94	119.277	20.77	22.13	Pass
11	2462	9.65	10.04	9.19	9.51	36.550	15.63	22.13	Pass

*Directional gain = $10 \log[(10^{G1/20} + 10^{G2/20} + \dots + 10^{GN/20})^2/4] = 13.87\text{dBi} > 6\text{dBi}$, so the power limit shall be reduced to $30 - (13.87 - 6) = 22.13\text{dBm}$.

802.11n (HT40)

Channel	Frequency (MHz)	Average Power (dBm)				Total Power (mW)	Total Power (dBm)	Limit (dBm)	Pass / Fail
		Chain 0	Chain 1	Chain 2	Chain 3				
3	2422	8.34	8.20	8.20	8.09	26.479	14.23	22.13	Pass
6	2437	11.07	10.89	10.84	10.86	49.392	16.94	22.13	Pass
9	2452	7.49	7.47	7.10	7.10	21.452	13.31	22.13	Pass

*Directional gain = $10 \log[(10^{G1/20} + 10^{G2/20} + \dots + 10^{GN/20})^2/4] = 13.87\text{dBi} > 6\text{dBi}$, so the power limit shall be reduced to $30 - (13.87 - 6) = 22.13\text{dBm}$.

Test Mode D

CDD Mode:

802.11b

Channel	Frequency (MHz)	Average Power (dBm)				Total Power (mW)	Total Power (dBm)	Limit (dBm)	Pass / Fail
		Chain 0	Chain 1	Chain 2	Chain 3				
1	2412	16.50	16.67	16.63	16.01	177.048	22.48	23.09	Pass
6	2437	16.34	17.00	16.82	16.11	182.088	22.60	23.09	Pass
11	2462	16.44	17.16	16.94	16.65	191.724	22.83	23.09	Pass

*Max. Gain: 12.91dBi, so the power limit shall be reduced to $30-(12.91-6) = 23.09\text{dBm}$.

802.11g

Channel	Frequency (MHz)	Average Power (dBm)				Total Power (mW)	Total Power (dBm)	Limit (dBm)	Pass / Fail
		Chain 0	Chain 1	Chain 2	Chain 3				
1	2412	13.96	14.11	13.48	14.00	98.055	19.91	23.09	Pass
6	2437	16.73	16.77	16.21	16.66	182.760	22.62	23.09	Pass
11	2462	14.27	14.59	13.95	14.04	105.686	20.24	23.09	Pass

*Max. Gain: 12.91dBi, so the power limit shall be reduced to $30-(12.91-6) = 23.09\text{dBm}$.

802.11n (HT20)

Channel	Frequency (MHz)	Average Power (dBm)				Total Power (mW)	Total Power (dBm)	Limit (dBm)	Pass / Fail
		Chain 0	Chain 1	Chain 2	Chain 3				
1	2412	13.25	13.40	12.73	13.23	82.801	19.18	23.09	Pass
6	2437	16.87	16.94	16.54	16.97	192.928	22.85	23.09	Pass
11	2462	12.92	13.24	12.56	12.69	77.282	18.88	23.09	Pass

*Max. Gain: 12.91dBi, so the power limit shall be reduced to $30-(12.91-6) = 23.09\text{dBm}$.

802.11n (HT40)

Channel	Frequency (MHz)	Average Power (dBm)				Total Power (mW)	Total Power (dBm)	Limit (dBm)	Pass / Fail
		Chain 0	Chain 1	Chain 2	Chain 3				
3	2422	11.82	11.57	11.64	11.59	58.569	17.68	23.09	Pass
6	2437	14.97	14.69	14.74	14.52	118.948	20.75	23.09	Pass
9	2452	10.73	10.89	10.46	10.35	46.060	16.63	23.09	Pass

*Max. Gain: 12.91dBi, so the power limit shall be reduced to $30-(12.91-6) = 23.09\text{dBm}$.

Beamforming Mode:

802.11n (HT20)

Channel	Frequency (MHz)	Average Power (dBm)				Total Power (mW)	Total Power (dBm)	Limit (dBm)	Pass / Fail
		Chain 0	Chain 1	Chain 2	Chain 3				
1	2412	7.23	7.38	6.71	7.21	20.703	13.16	17.63	Pass
6	2437	10.85	10.92	10.52	10.95	48.238	16.83	17.63	Pass
11	2462	6.90	7.22	6.54	6.67	19.323	12.86	17.63	Pass

* Directional gain = $10 \log[(10^{G1/20} + 10^{G2/20} + \dots + 10^{GN/20})^2/4]$ = 18.37dBi > 6dBi, so the power limit shall be reduced to $30-(18.37-6) = 17.63$ dBm.

802.11n (HT40)

Channel	Frequency (MHz)	Average Power (dBm)				Total Power (mW)	Total Power (dBm)	Limit (dBm)	Pass / Fail
		Chain 0	Chain 1	Chain 2	Chain 3				
3	2422	5.80	5.55	5.62	5.57	14.644	11.66	17.63	Pass
6	2437	8.95	8.67	8.72	8.50	29.741	14.73	17.63	Pass
9	2452	4.71	4.87	4.44	4.33	11.517	10.61	17.63	Pass

* Directional gain = $10 \log[(10^{G1/20} + 10^{G2/20} + \dots + 10^{GN/20})^2/4]$ = 18.37dBi > 6dBi, so the power limit shall be reduced to $30-(18.37-6) = 17.63$ dBm.

Test Mode E

802.11b

Channel	Frequency (MHz)	Avg. Power (mW)	Avg. Power (dBm)	Limit (dBm)	Pass / Fail
1	2412	44.361	16.47	30	Pass
6	2437	45.082	16.54	30	Pass
11	2462	47.863	16.80	30	Pass

802.11g

Channel	Frequency (MHz)	Avg. Power (mW)	Avg. Power (dBm)	Limit (dBm)	Pass / Fail
1	2412	19.409	12.88	30	Pass
6	2437	129.420	21.12	30	Pass
11	2462	31.915	15.04	30	Pass

802.11n (HT20)

Channel	Frequency (MHz)	Avg. Power (mW)	Avg. Power (dBm)	Limit (dBm)	Pass / Fail
1	2412	14.158	11.51	30	Pass
6	2437	129.122	21.11	30	Pass
11	2462	30.479	14.84	30	Pass

802.11n (HT40)

Channel	Frequency (MHz)	Avg. Power (mW)	Avg. Power (dBm)	Limit (dBm)	Pass / Fail
3	2422	8.453	9.27	30	Pass
6	2437	23.227	13.66	30	Pass
9	2452	21.135	13.25	30	Pass

4.5 Power Spectral Density Measurement

4.5.1 Limits of Power Spectral Density Measurement

The Maximum of Power Spectral Density Measurement is 8dBm.

4.5.2 Test Setup

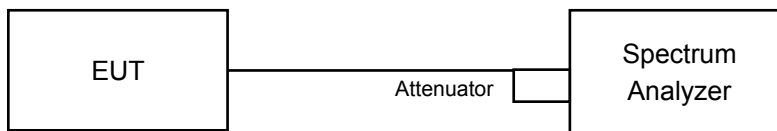

4.5.3 Test Instruments

Refer to section 4.1.2 to get information of above instrument.

4.5.4 Test Procedure

For duty cycle $\geq 98\%$

- Set instrument center frequency to DTS channel center frequency.
- Set span to at least 1.5 times the OBW.
- Set RBW to: $3 \text{ kHz} \leq \text{RBW} \leq 100 \text{ kHz}$.
- Set VBW $\geq 3 \times \text{RBW}$.
- Detector = power averaging (RMS) or sample detector (when RMS not available).
- Ensure that the number of measurement points in the sweep $\geq 2 \times \text{span}/\text{RBW}$.
- Sweep time = auto couple.
- Employ trace averaging (RMS) mode over a minimum of 100 traces.
- Use the peak marker function to determine the maximum amplitude level.

For duty cycle $< 98\%$

- Measure the duty cycle (x).
- Set instrument center frequency to DTS channel center frequency.
- Set span to at least 1.5 times the OBW.
- Set RBW to: $3 \text{ kHz} \leq \text{RBW} \leq 100 \text{ kHz}$.
- Set VBW $\geq 3 \times \text{RBW}$.
- Detector = power averaging (RMS) or sample detector (when RMS not available).
- Ensure that the number of measurement points in the sweep $\geq 2 \times \text{span}/\text{RBW}$.
- Sweep time = auto couple.
- Do not use sweep triggering. Allow sweep to "free run".
- Employ trace averaging (RMS) mode over a minimum of 100 traces.
- Use the peak marker function to determine the maximum amplitude level.
- Add $10 \log (1/x)$, where x is the duty cycle measured in step (a), to the measured PSD to compute the average PSD during the actual transmission time.

4.5.5 Deviation from Test Standard

No deviation.

4.5.6 EUT Operating Condition

Same as Item 4.3.6

4.5.7 Test Results

Test Mode A

802.11b

TX chain	Channel	Frequency (MHz)	PSD (dBm/3kHz)	10 log (N=4) dB	Total PSD (dBm/3kHz)	Limit (dBm/3kHz)	Pass / Fail
0	1	2412	-7.49	6.02	-1.47	3.48	Pass
	6	2437	-6.47	6.02	-0.45	3.48	Pass
	11	2462	-7.04	6.02	-1.02	3.48	Pass
1	1	2412	-7.76	6.02	-1.74	3.48	Pass
	6	2437	-6.76	6.02	-0.74	3.48	Pass
	11	2462	-7.60	6.02	-1.58	3.48	Pass
2	1	2412	-7.23	6.02	-1.21	3.48	Pass
	6	2437	-6.33	6.02	-0.31	3.48	Pass
	11	2462	-7.75	6.02	-1.73	3.48	Pass
3	1	2412	-7.41	6.02	-1.39	3.48	Pass
	6	2437	-6.43	6.02	-0.41	3.48	Pass
	11	2462	-7.93	6.02	-1.91	3.48	Pass

Note:

- Method 1 of power density measurement of KDB 662911 is using for calculating total power density. Total power density is summing entire spectra across corresponding frequency bins on the various outputs by computer.
- Directional gain = $4.5\text{dBi} + 10\log(4) = 10.52\text{dBi} > 6\text{dBi}$, so the power density limit shall be reduced to $8 - (10.52 - 6) = 3.48\text{dBm}$.

802.11g

TX chain	Channel	Frequency (MHz)	PSD (dBm/3kHz)	10 log (N=4) dB	Duty Factor	Total PSD with Duty Factor (dBm/3kHz)	Limit (dBm/3kHz)	Pass / Fail
0	1	2412	-13.67	6.02	0.17	-7.48	3.48	Pass
	6	2437	-9.71	6.02	0.17	-3.52	3.48	Pass
	11	2462	-13.43	6.02	0.17	-7.24	3.48	Pass
1	1	2412	-14.21	6.02	0.17	-8.02	3.48	Pass
	6	2437	-9.77	6.02	0.17	-3.58	3.48	Pass
	11	2462	-13.71	6.02	0.17	-7.52	3.48	Pass
2	1	2412	-13.75	6.02	0.17	-7.56	3.48	Pass
	6	2437	-9.99	6.02	0.17	-3.80	3.48	Pass
	11	2462	-13.72	6.02	0.17	-7.53	3.48	Pass
3	1	2412	-13.95	6.02	0.17	-7.76	3.48	Pass
	6	2437	-10.34	6.02	0.17	-4.15	3.48	Pass
	11	2462	-13.75	6.02	0.17	-7.56	3.48	Pass

Note:

1. Method 1 of power density measurement of KDB 662911 is using for calculating total power density. Total power density is summing entire spectra across corresponding frequency bins on the various outputs by computer.
2. Directional gain = $4.5\text{dBi} + 10\log(4) = 10.52\text{dBi} > 6\text{dBi}$, so the power density limit shall be reduced to $8 - (10.52 - 6) = 3.48\text{dBm}$.
3. Refer to section 3.3 for duty cycle spectrum plot.

802.11n (HT20)

TX chain	Channel	Frequency (MHz)	PSD (dBm/3kHz)	10 log (N=4) dB	Total PSD (dBm/3kHz)	Limit (dBm /3kHz)	Pass / Fail
0	1	2412	-14.23	6.02	-8.21	3.48	Pass
	6	2437	-10.26	6.02	-4.24	3.48	Pass
	11	2462	-14.68	6.02	-8.66	3.48	Pass
1	1	2412	-14.33	6.02	-8.31	3.48	Pass
	6	2437	-10.84	6.02	-4.82	3.48	Pass
	11	2462	-14.10	6.02	-8.08	3.48	Pass
2	1	2412	-14.47	6.02	-8.45	3.48	Pass
	6	2437	-10.66	6.02	-4.64	3.48	Pass
	11	2462	-14.84	6.02	-8.82	3.48	Pass
3	1	2412	-14.41	6.02	-8.39	3.48	Pass
	6	2437	-10.83	6.02	-4.81	3.48	Pass
	11	2462	-14.75	6.02	-8.73	3.48	Pass

Note:

- Method 1 of power density measurement of KDB 662911 is using for calculating total power density. Total power density is summing entire spectra across corresponding frequency bins on the various outputs by computer.
- Directional gain = $4.5\text{dBi} + 10\log(4) = 10.52\text{dBi} > 6\text{dBi}$, so the power density limit shall be reduced to $8 - (10.52 - 6) = 3.48\text{dBm}$.

802.11n (HT40)

TX chain	Channel	Frequency (MHz)	PSD (dBm/3kHz)	10 log (N=4) dB	Duty Factor	Total PSD with Duty Factor (dBm/3kHz)	Limit (dBm/3kHz)	Pass / Fail
0	3	2422	-19.50	6.02	0.15	-13.33	3.48	Pass
	6	2437	-17.59	6.02	0.15	-11.42	3.48	Pass
	9	2452	-22.86	6.02	0.15	-16.69	3.48	Pass
1	3	2422	-19.98	6.02	0.15	-13.81	3.48	Pass
	6	2437	-17.29	6.02	0.15	-11.12	3.48	Pass
	9	2452	-22.75	6.02	0.15	-16.58	3.48	Pass
2	3	2422	-19.93	6.02	0.15	-13.76	3.48	Pass
	6	2437	-17.57	6.02	0.15	-11.40	3.48	Pass
	9	2452	-23.15	6.02	0.15	-16.98	3.48	Pass
3	3	2422	-19.67	6.02	0.15	-13.50	3.48	Pass
	6	2437	-17.24	6.02	0.15	-11.07	3.48	Pass
	9	2452	-22.71	6.02	0.15	-16.54	3.48	Pass

Note:

1. Method 1 of power density measurement of KDB 662911 is using for calculating total power density. Total power density is summing entire spectra across corresponding frequency bins on the various outputs by computer.
2. Directional gain = $4.5\text{dBi} + 10\log(4) = 10.52\text{dBi} > 6\text{dBi}$, so the power density limit shall be reduced to $8 - (10.52 - 6) = 3.48\text{dBm}$.
3. Refer to section 3.3 for duty cycle spectrum plot.

Spectrum Plot of Worst Value

802.11b

802.11g

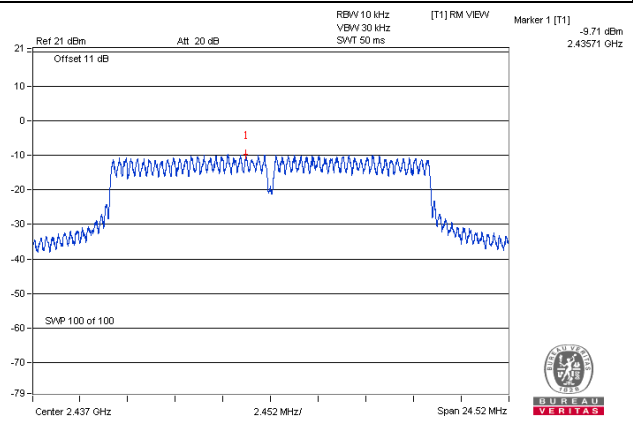
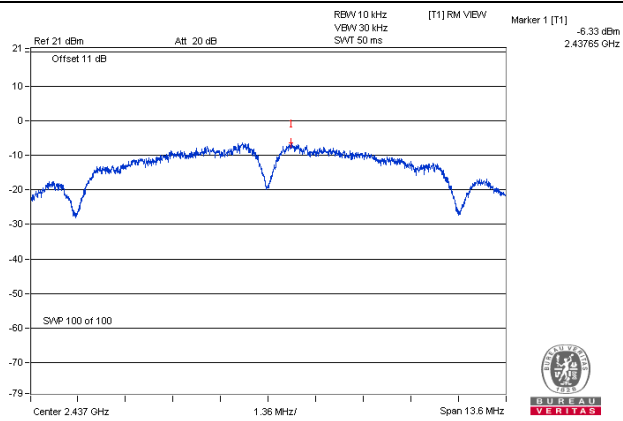

802.11n (HT20)

802.11n (HT40)

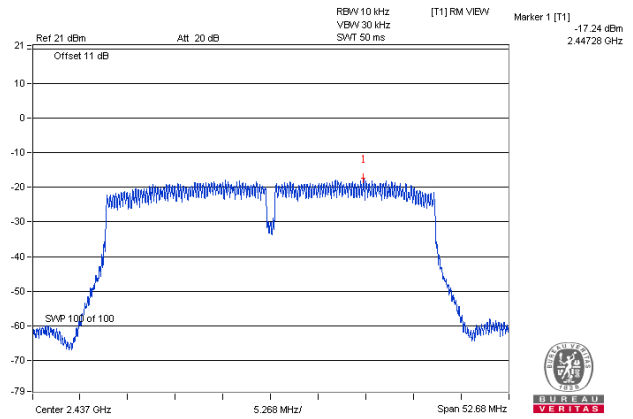
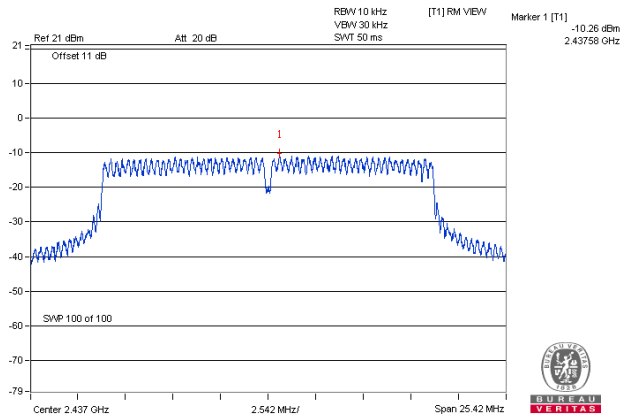

Test Mode B

802.11b

TX chain	Channel	Frequency (MHz)	PSD (dBm/3kHz)	10 log (N=4) dB	Total PSD (dBm/3kHz)	Limit (dBm /3kHz)	Pass / Fail
0	1	2412	-11.57	6.02	-5.55	-4.27	Pass
	6	2437	-11.25	6.02	-5.23	-4.27	Pass
	11	2462	-12.10	6.02	-6.08	-4.27	Pass
1	1	2412	-10.74	6.02	-4.72	-4.27	Pass
	6	2437	-10.90	6.02	-4.88	-4.27	Pass
	11	2462	-10.66	6.02	-4.64	-4.27	Pass
2	1	2412	-11.03	6.02	-5.01	-4.27	Pass
	6	2437	-10.67	6.02	-4.65	-4.27	Pass
	11	2462	-11.51	6.02	-5.49	-4.27	Pass
3	1	2412	-11.22	6.02	-5.20	-4.27	Pass
	6	2437	-10.90	6.02	-4.88	-4.27	Pass
	11	2462	-11.90	6.02	-5.88	-4.27	Pass

Note:

- Method 1 of power density measurement of KDB 662911 is using for calculating total power density. Total power density is summing entire spectra across corresponding frequency bins on the various outputs by computer.
- Directional gain = $10 \log[(10^{G1/20} + 10^{G2/20} + \dots + 10^{GN/20})^2/4] = 18.27\text{dBi} > 6\text{dBi}$, so the power density limit shall be reduced to $8 - (18.27 - 6) = -4.27\text{dBm}$.

802.11g

TX chain	Channel	Frequency (MHz)	PSD (dBm/3kHz)	10 log (N=4) dB	Duty Factor	Total PSD with Duty Factor (dBm/3kHz)	Limit (dBm/3kHz)	Pass / Fail
0	1	2412	-14.37	6.02	0.17	-8.18	-4.27	Pass
	6	2437	-13.60	6.02	0.17	-7.41	-4.27	Pass
	11	2462	-15.65	6.02	0.17	-9.46	-4.27	Pass
1	1	2412	-13.92	6.02	0.17	-7.73	-4.27	Pass
	6	2437	-12.94	6.02	0.17	-6.75	-4.27	Pass
	11	2462	-14.53	6.02	0.17	-8.34	-4.27	Pass
2	1	2412	-14.44	6.02	0.17	-8.25	-4.27	Pass
	6	2437	-13.77	6.02	0.17	-7.58	-4.27	Pass
	11	2462	-15.70	6.02	0.17	-9.51	-4.27	Pass
3	1	2412	-14.08	6.02	0.17	-7.89	-4.27	Pass
	6	2437	-14.49	6.02	0.17	-8.30	-4.27	Pass
	11	2462	-16.36	6.02	0.17	-10.17	-4.27	Pass

Note:

- Method 1 of power density measurement of KDB 662911 is using for calculating total power density. Total power density is summing entire spectra across corresponding frequency bins on the various outputs by computer.
- Directional gain = $10 \log[(10^{G1/20} + 10^{G2/20} + \dots + 10^{GN/20})^2/4] = 18.27\text{dBi} > 6\text{dBi}$, so the power density limit shall be reduced to $8 - (18.27 - 6) = -4.27\text{dBm}$.
- Refer to section 3.3 for duty cycle spectrum plot.

802.11n (HT20)

TX chain	Channel	Frequency (MHz)	PSD (dBm/3kHz)	10 log (N=4) dB	Total PSD (dBm/3kHz)	Limit (dBm/3kHz)	Pass / Fail
0	1	2412	-15.14	6.02	-9.12	-4.27	Pass
	6	2437	-14.41	6.02	-8.39	-4.27	Pass
	11	2462	-17.05	6.02	-11.03	-4.27	Pass
1	1	2412	-14.29	6.02	-8.27	-4.27	Pass
	6	2437	-13.30	6.02	-7.28	-4.27	Pass
	11	2462	-15.73	6.02	-9.71	-4.27	Pass
2	1	2412	-15.28	6.02	-9.26	-4.27	Pass
	6	2437	-14.55	6.02	-8.53	-4.27	Pass
	11	2462	-16.38	6.02	-10.36	-4.27	Pass
3	1	2412	-15.50	6.02	-9.48	-4.27	Pass
	6	2437	-14.41	6.02	-8.39	-4.27	Pass
	11	2462	-17.47	6.02	-11.45	-4.27	Pass

Note:

1. Method 1 of power density measurement of KDB 662911 is using for calculating total power density. Total power density is summing entire spectra across corresponding frequency bins on the various outputs by computer.
2. Directional gain = $10 \log[(10^{G1/20} + 10^{G2/20} + \dots + 10^{GN/20})^2/4] = 18.27\text{dBi} > 6\text{dBi}$, so the power density limit shall be reduced to $8 - (18.27 - 6) = -4.27\text{dBm}$.
3. Refer to section 3.3 for duty cycle spectrum plot.

802.11n (HT40)

TX chain	Channel	Frequency (MHz)	PSD (dBm/3kHz)	10 log (N=4) dB	Duty Factor	Total PSD with Duty Factor (dBm/3kHz)	Limit (dBm/3kHz)	Pass / Fail
0	3	2422	-20.70	6.02	0.15	-14.53	-4.27	Pass
	6	2437	-17.85	6.02	0.15	-11.68	-4.27	Pass
	9	2452	-23.23	6.02	0.15	-17.06	-4.27	Pass
1	3	2422	-19.93	6.02	0.15	-13.76	-4.27	Pass
	6	2437	-17.23	6.02	0.15	-11.06	-4.27	Pass
	9	2452	-21.68	6.02	0.15	-15.51	-4.27	Pass
2	3	2422	-20.77	6.02	0.15	-14.60	-4.27	Pass
	6	2437	-18.07	6.02	0.15	-11.90	-4.27	Pass
	9	2452	-22.29	6.02	0.15	-16.12	-4.27	Pass
3	3	2422	-20.53	6.02	0.15	-14.36	-4.27	Pass
	6	2437	-18.25	6.02	0.15	-12.08	-4.27	Pass
	9	2452	-22.94	6.02	0.15	-16.77	-4.27	Pass

Note:

- Method 1 of power density measurement of KDB 662911 is using for calculating total power density. Total power density is summing entire spectra across corresponding frequency bins on the various outputs by computer.
- Directional gain = $10 \log[(10^{G1/20} + 10^{G2/20} + \dots + 10^{GN/20})^2/4] = 18.27\text{dBi} > 6\text{dBi}$, so the power density limit shall be reduced to $8 - (18.27 - 6) = -4.27\text{dBm}$.
- Refer to section 3.3 for duty cycle spectrum plot.

Spectrum Plot of Worst Value

802.11b

802.11g

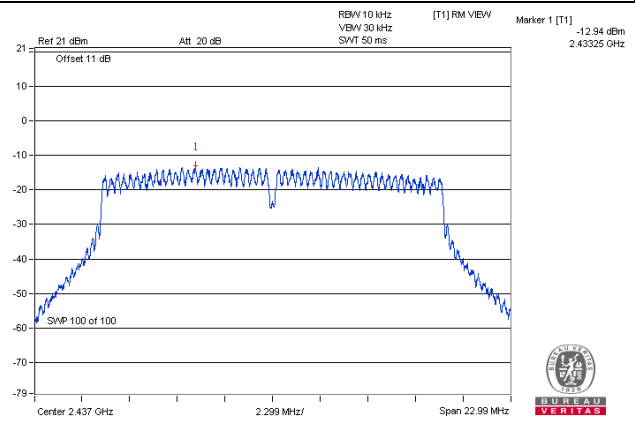
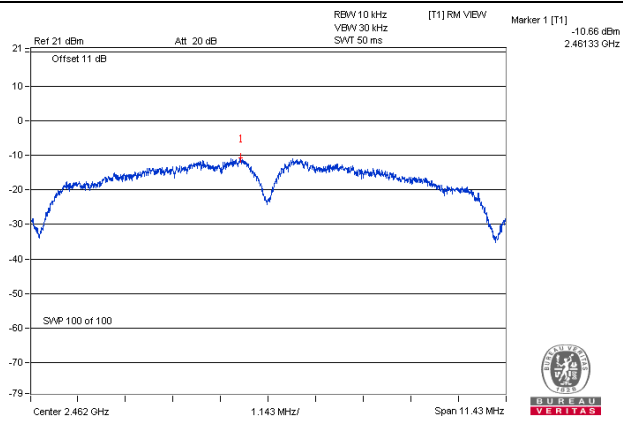

802.11n (HT20)

802.11n (HT40)

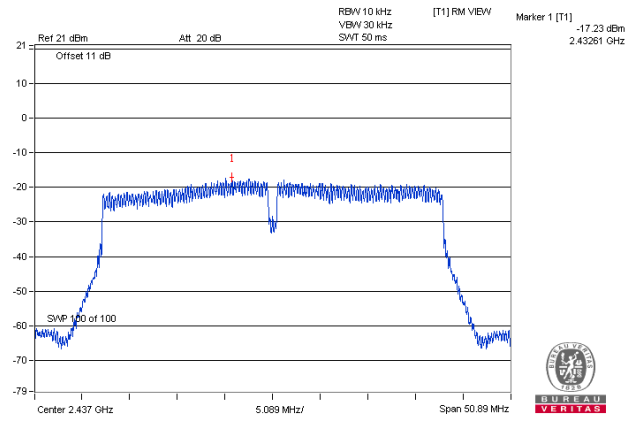
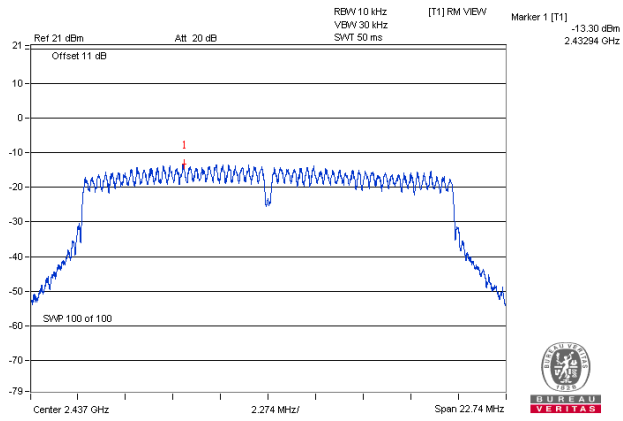

Test Mode C

802.11b

TX chain	Channel	Frequency (MHz)	PSD (dBm/3kHz)	10 log (N=4) dB	Total PSD (dBm/3kHz)	Limit (dBm /3kHz)	Pass / Fail
0	1	2412	-8.31	6.02	-2.29	0.13	Pass
	6	2437	-7.99	6.02	-1.97	0.13	Pass
	11	2462	-9.09	6.02	-3.07	0.13	Pass
1	1	2412	-7.68	6.02	-1.66	0.13	Pass
	6	2437	-8.59	6.02	-2.57	0.13	Pass
	11	2462	-7.66	6.02	-1.64	0.13	Pass
2	1	2412	-7.15	6.02	-1.13	0.13	Pass
	6	2437	-7.47	6.02	-1.45	0.13	Pass
	11	2462	-8.49	6.02	-2.47	0.13	Pass
3	1	2412	-8.00	6.02	-1.98	0.13	Pass
	6	2437	-8.17	6.02	-2.15	0.13	Pass
	11	2462	-8.96	6.02	-2.94	0.13	Pass

Note:

1. Method 1 of power density measurement of KDB 662911 is using for calculating total power density. Total power density is summing entire spectra across corresponding frequency bins on the various outputs by computer.
2. Directional gain = $10 \log[(10^{G1/20} + 10^{G2/20} + \dots + 10^{GN/20})^2/4] = 13.87\text{dBi} > 6\text{dBi}$, so the power density limit shall be reduced to $8 - (13.87 - 6) = 0.13\text{dBm}$.

802.11g

TX chain	Channel	Frequency (MHz)	PSD (dBm/3kHz)	10 log (N=4) dB	Duty Factor	Total PSD with Duty Factor (dBm/3kHz)	Limit (dBm/3kHz)	Pass / Fail
0	1	2412	-13.49	6.02	0.18	-7.29	0.13	Pass
	6	2437	-9.69	6.02	0.18	-3.49	0.13	Pass
	11	2462	-14.82	6.02	0.18	-8.62	0.13	Pass
1	1	2412	-13.02	6.02	0.18	-6.82	0.13	Pass
	6	2437	-9.16	6.02	0.18	-2.96	0.13	Pass
	11	2462	-13.74	6.02	0.18	-7.54	0.13	Pass
2	1	2412	-13.67	6.02	0.18	-7.47	0.13	Pass
	6	2437	-9.80	6.02	0.18	-3.60	0.13	Pass
	11	2462	-15.07	6.02	0.18	-8.87	0.13	Pass
3	1	2412	-13.54	6.02	0.18	-7.34	0.13	Pass
	6	2437	-9.64	6.02	0.18	-3.44	0.13	Pass
	11	2462	-15.10	6.02	0.18	-8.90	0.13	Pass

Note:

- Method 1 of power density measurement of KDB 662911 is using for calculating total power density. Total power density is summing entire spectra across corresponding frequency bins on the various outputs by computer.
- Directional gain = $10 \log[(10^{G1/20} + 10^{G2/20} + \dots + 10^{GN/20})^2/4] = 13.87\text{dBi} > 6\text{dBi}$, so the power density limit shall be reduced to $8 - (13.87 - 6) = 0.13\text{dBm}$.
- Refer to section 3.3 for duty cycle spectrum plot.

802.11n (HT20)

TX chain	Channel	Frequency (MHz)	PSD (dBm/3kHz)	10 log (N=4) dB	Total PSD (dBm/3kHz)	Limit (dBm/3kHz)	Pass / Fail
0	1	2412	-13.77	6.02	-7.75	0.13	Pass
	6	2437	-10.79	6.02	-4.77	0.13	Pass
	11	2462	-15.32	6.02	-9.30	0.13	Pass
1	1	2412	-13.63	6.02	-7.61	0.13	Pass
	6	2437	-9.76	6.02	-3.74	0.13	Pass
	11	2462	-14.10	6.02	-8.08	0.13	Pass
2	1	2412	-14.38	6.02	-8.36	0.13	Pass
	6	2437	-10.38	6.02	-4.36	0.13	Pass
	11	2462	-15.44	6.02	-9.42	0.13	Pass
3	1	2412	-14.30	6.02	-8.28	0.13	Pass
	6	2437	-10.63	6.02	-4.61	0.13	Pass
	11	2462	-15.28	6.02	-9.26	0.13	Pass

Note:

1. Method 1 of power density measurement of KDB 662911 is using for calculating total power density. Total power density is summing entire spectra across corresponding frequency bins on the various outputs by computer.
2. Directional gain = $10 \log[(10^{G1/20} + 10^{G2/20} + \dots + 10^{GN/20})^2/4] = 13.87\text{dBi} > 6\text{dBi}$, so the power density limit shall be reduced to $8 - (13.87 - 6) = 0.13\text{dBm}$.
3. Refer to section 3.3 for duty cycle spectrum plot.

802.11n (HT40)

TX chain	Channel	Frequency (MHz)	PSD (dBm/3kHz)	10 log (N=4) dB	Duty Factor	Total PSD with Duty Factor (dBm/3kHz)	Limit (dBm/3kHz)	Pass / Fail
0	3	2422	-19.11	6.02	0.14	-12.95	0.13	Pass
	6	2437	-16.54	6.02	0.14	-10.38	0.13	Pass
	9	2452	-20.18	6.02	0.14	-14.02	0.13	Pass
1	3	2422	-18.57	6.02	0.14	-12.41	0.13	Pass
	6	2437	-16.00	6.02	0.14	-9.84	0.13	Pass
	9	2452	-19.25	6.02	0.14	-13.09	0.13	Pass
2	3	2422	-19.23	6.02	0.14	-13.07	0.13	Pass
	6	2437	-16.54	6.02	0.14	-10.38	0.13	Pass
	9	2452	-20.10	6.02	0.14	-13.94	0.13	Pass
3	3	2422	-19.29	6.02	0.14	-13.13	0.13	Pass
	6	2437	-16.65	6.02	0.14	-10.49	0.13	Pass
	9	2452	-20.37	6.02	0.14	-14.21	0.13	Pass

Note:

- Method 1 of power density measurement of KDB 662911 is using for calculating total power density. Total power density is summing entire spectra across corresponding frequency bins on the various outputs by computer.
- Directional gain = $10 \log[(10^{G1/20} + 10^{G2/20} + \dots + 10^{GN/20})^2/4] = 13.87\text{dBi} > 6\text{dBi}$, so the power density limit shall be reduced to $8 - (13.87 - 6) = 0.13\text{dBm}$.
- Refer to section 3.3 for duty cycle spectrum plot.

Spectrum Plot of Worst Value

802.11b

802.11g

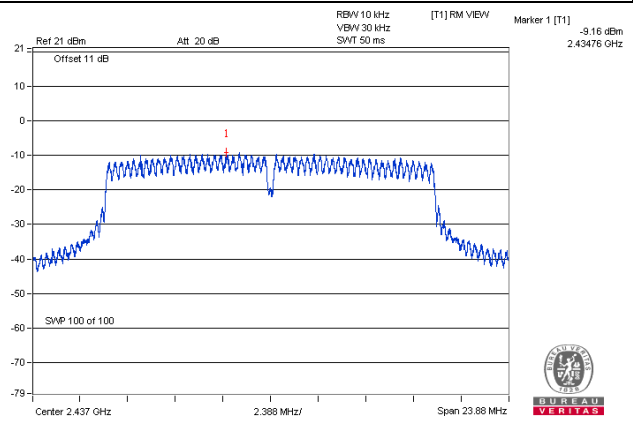
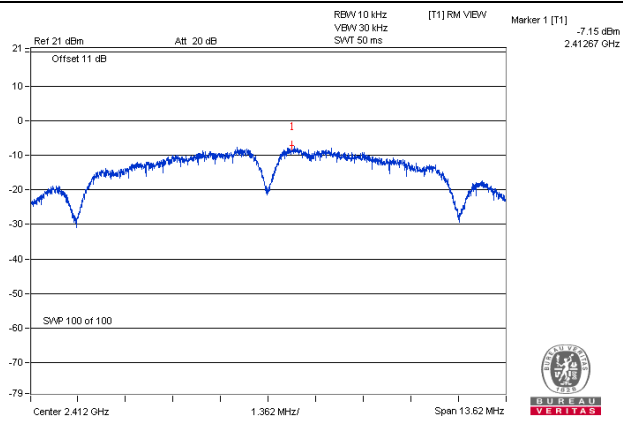

802.11n (HT20)

802.11n (HT40)

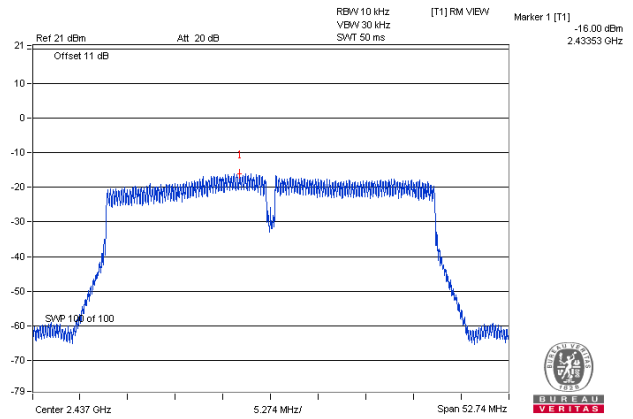
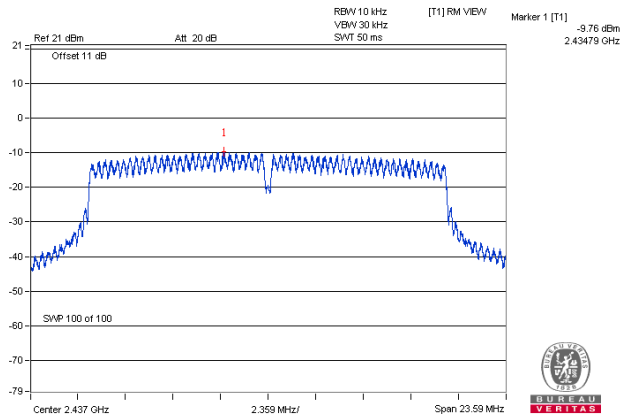

Test Mode D

802.11b

TX chain	Channel	Frequency (MHz)	PSD (dBm/3kHz)	10 log (N=4) dB	Total PSD (dBm/3kHz)	Limit (dBm /3kHz)	Pass / Fail
0	1	2412	-11.66	6.02	-5.64	-4.37	Pass
	6	2437	-11.42	6.02	-5.40	-4.37	Pass
	11	2462	-11.58	6.02	-5.56	-4.37	Pass
1	1	2412	-12.54	6.02	-6.52	-4.37	Pass
	6	2437	-11.07	6.02	-5.05	-4.37	Pass
	11	2462	-11.02	6.02	-5.00	-4.37	Pass
2	1	2412	-11.57	6.02	-5.55	-4.37	Pass
	6	2437	-10.96	6.02	-4.94	-4.37	Pass
	11	2462	-11.50	6.02	-5.48	-4.37	Pass
3	1	2412	-11.61	6.02	-5.59	-4.37	Pass
	6	2437	-11.63	6.02	-5.61	-4.37	Pass
	11	2462	-11.74	6.02	-5.72	-4.37	Pass

Note:

- Method 1 of power density measurement of KDB 662911 is using for calculating total power density. Total power density is summing entire spectra across corresponding frequency bins on the various outputs by computer.
- Directional gain = $10 \log[(10^{G1/20} + 10^{G2/20} + \dots + 10^{GN/20})^2/4] = 18.37\text{dBi} > 6\text{dBi}$, so the power density limit shall be reduced to $8 - (18.37 - 6) = -4.37\text{dBm}$.

802.11g

TX chain	Channel	Frequency (MHz)	PSD (dBm/3kHz)	10 log (N=4) dB	Duty Factor	Total PSD with Duty Factor (dBm/3kHz)	Limit (dBm/3kHz)	Pass / Fail
0	1	2412	-17.22	6.02	0.15	-11.05	-4.37	Pass
	6	2437	-13.96	6.02	0.15	-7.79	-4.37	Pass
	11	2462	-16.69	6.02	0.15	-10.52	-4.37	Pass
1	1	2412	-17.67	6.02	0.15	-11.50	-4.37	Pass
	6	2437	-14.81	6.02	0.15	-8.64	-4.37	Pass
	11	2462	-17.24	6.02	0.15	-11.07	-4.37	Pass
2	1	2412	-16.19	6.02	0.15	-10.02	-4.37	Pass
	6	2437	-14.00	6.02	0.15	-7.83	-4.37	Pass
	11	2462	-15.75	6.02	0.15	-9.58	-4.37	Pass
3	1	2412	-17.52	6.02	0.15	-11.35	-4.37	Pass
	6	2437	-14.84	6.02	0.15	-8.67	-4.37	Pass
	11	2462	-17.59	6.02	0.15	-11.42	-4.37	Pass

Note:

- Method 1 of power density measurement of KDB 662911 is using for calculating total power density. Total power density is summing entire spectra across corresponding frequency bins on the various outputs by computer.
- Directional gain = $10 \log[(10^{G1/20} + 10^{G2/20} + \dots + 10^{GN/20})^2/4] = 18.37\text{dBi} > 6\text{dBi}$, so the power density limit shall be reduced to $8-(18.37-6) = -4.37\text{dBm}$.
- Refer to section 3.3 for duty cycle spectrum plot.

802.11n (HT20)

TX chain	Channel	Frequency (MHz)	PSD (dBm/3kHz)	10 log (N=4) dB	Total PSD (dBm/3kHz)	Limit (dBm /3kHz)	Pass / Fail
0	1	2412	-18.00	6.02	-11.98	-4.37	Pass
	6	2437	-14.59	6.02	-8.57	-4.37	Pass
	11	2462	-18.64	6.02	-12.62	-4.37	Pass
1	1	2412	-18.61	6.02	-12.59	-4.37	Pass
	6	2437	-14.67	6.02	-8.65	-4.37	Pass
	11	2462	-18.96	6.02	-12.94	-4.37	Pass
2	1	2412	-17.58	6.02	-11.56	-4.37	Pass
	6	2437	-14.15	6.02	-8.13	-4.37	Pass
	11	2462	-17.08	6.02	-11.06	-4.37	Pass
3	1	2412	-18.46	6.02	-12.44	-4.37	Pass
	6	2437	-15.04	6.02	-9.02	-4.37	Pass
	11	2462	-18.71	6.02	-12.69	-4.37	Pass

Note:

1. Method 1 of power density measurement of KDB 662911 is using for calculating total power density. Total power density is summing entire spectra across corresponding frequency bins on the various outputs by computer.
2. Directional gain = $10 \log[(10^{G1/20} + 10^{G2/20} + \dots + 10^{GN/20})^2/4] = 18.37\text{dBi} > 6\text{dBi}$, so the power density limit shall be reduced to $8 - (18.37 - 6) = -4.37\text{dBm}$.
3. Refer to section 3.3 for duty cycle spectrum plot.

802.11n (HT40)

TX chain	Channel	Frequency (MHz)	PSD (dBm/3kHz)	10 log (N=4) dB	Duty Factor	Total PSD with Duty Factor (dBm/3kHz)	Limit (dBm/3kHz)	Pass / Fail
0	3	2422	-23.26	6.02	0.15	-17.09	-4.37	Pass
	6	2437	-20.18	6.02	0.15	-14.01	-4.37	Pass
	9	2452	-24.65	6.02	0.15	-18.48	-4.37	Pass
1	3	2422	-23.36	6.02	0.15	-17.19	-4.37	Pass
	6	2437	-19.73	6.02	0.15	-13.56	-4.37	Pass
	9	2452	-24.30	6.02	0.15	-18.13	-4.37	Pass
2	3	2422	-22.85	6.02	0.15	-16.68	-4.37	Pass
	6	2437	-19.32	6.02	0.15	-13.15	-4.37	Pass
	9	2452	-23.46	6.02	0.15	-17.29	-4.37	Pass
3	3	2422	-22.87	6.02	0.15	-16.70	-4.37	Pass
	6	2437	-20.05	6.02	0.15	-13.88	-4.37	Pass
	9	2452	-24.50	6.02	0.15	-18.33	-4.37	Pass

Note:

- Method 1 of power density measurement of KDB 662911 is using for calculating total power density. Total power density is summing entire spectra across corresponding frequency bins on the various outputs by computer.
- Directional gain = $10 \log[(10^{G1/20} + 10^{G2/20} + \dots + 10^{GN/20})^2/4] = 18.37\text{dBi} > 6\text{dBi}$, so the power density limit shall be reduced to $8 - (18.37 - 6) = -4.37\text{dBm}$.
- Refer to section 3.3 for duty cycle spectrum plot.

Spectrum Plot of Worst Value

802.11b

802.11g

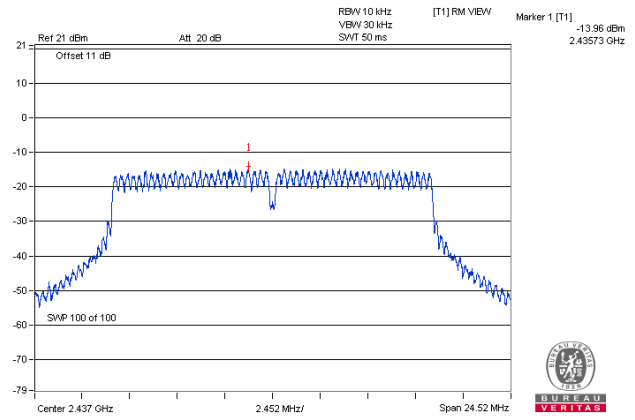
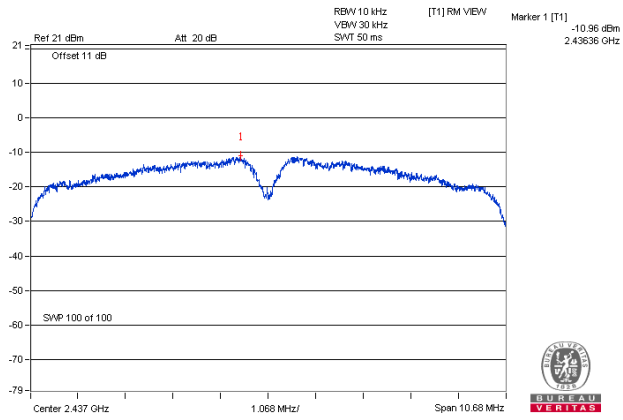

802.11n (HT20)

802.11n (HT40)

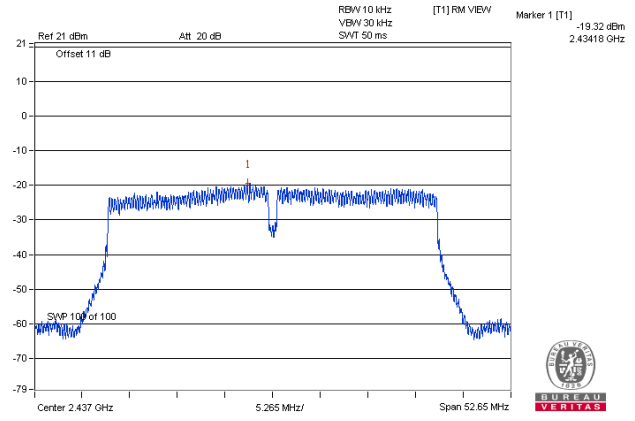
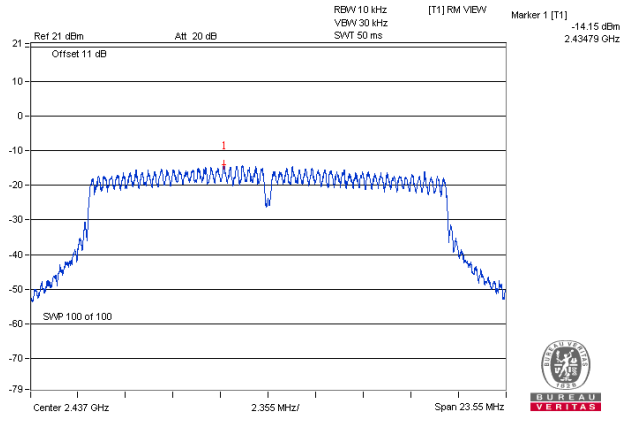

Test Mode E

802.11b

Channel	Freq. (MHz)	PSD (dBm/3kHz)	Limit (dBm/3kHz)	Pass /Fail
1	2412	-10.60	8	Pass
6	2437	-11.03	8	Pass
11	2462	-9.42	8	Pass

802.11g

Channel	Freq. (MHz)	PSD (dBm/3kHz)	Duty Factor	PSD (dBm/3kHz)	Limit (dBm/3kHz)	Pass /Fail
1	2412	-18.43	0.21	-18.22	8	Pass
6	2437	-4.44	0.21	-4.23	8	Pass
11	2462	-15.95	0.21	-15.74	8	Pass

802.11n (HT20)

Channel	Freq. (MHz)	PSD (dBm/3kHz)	Duty Factor	PSD (dBm/3kHz)	Limit (dBm/3kHz)	Pass /Fail
1	2412	-20.12	0.18	-19.94	8	Pass
6	2437	-5.12	0.18	-4.94	8	Pass
11	2462	-16.36	0.18	-16.18	8	Pass

802.11n (HT40)

Channel	Freq. (MHz)	PSD (dBm/3kHz)	Duty Factor	PSD (dBm/3kHz)	Limit (dBm/3kHz)	Pass /Fail
3	2422	-25.00	0.36	-24.64	8	Pass
6	2437	-20.16	0.36	-19.80	8	Pass
9	2452	-20.93	0.36	-20.57	8	Pass

Spectrum Plot of Worst Value

802.11b

802.11g

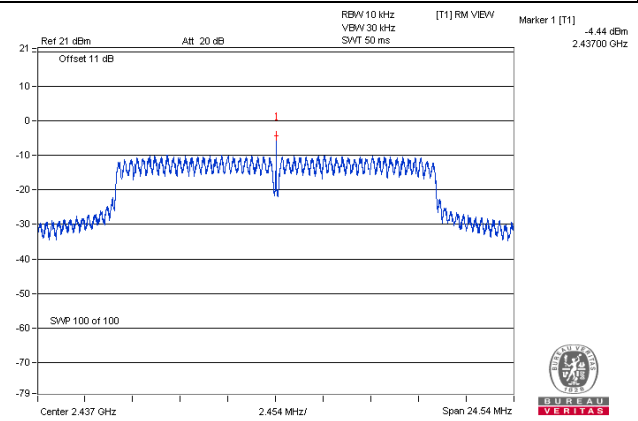
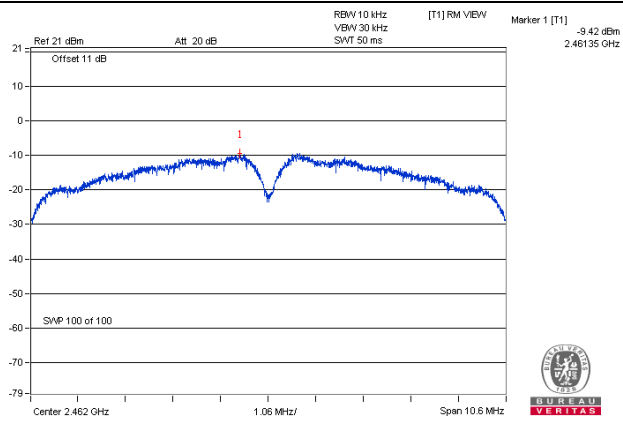

802.11n (HT20)

802.11n (HT40)

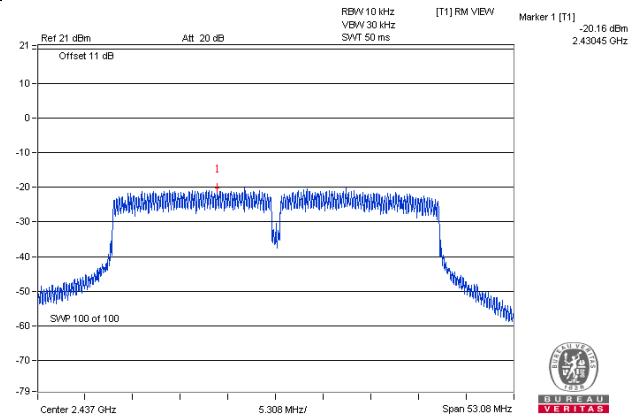
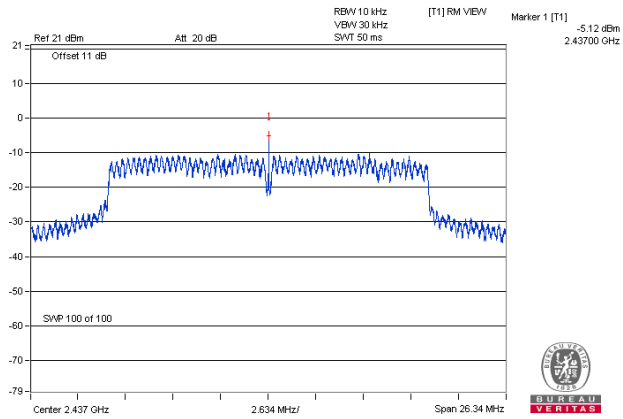

4.6 Conducted Out of Band Emission Measurement

4.6.1 Limits of Conducted Out of Band Emission Measurement

Below 30dB of the highest emission level of operating band (in 100kHz Resolution Bandwidth).

4.6.2 Test Setup

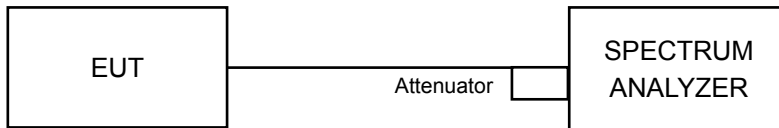

4.6.3 Test Instruments

Refer to section 4.1.2 to get information of above instrument.

4.6.4 Test Procedure

MEASUREMENT PROCEDURE REF

- Set the RBW = 100 kHz.
- Set the VBW \geq 300 kHz.
- Detector = average.
- Sweep time = auto couple.
- Trace mode = max hold.
- Allow trace to fully stabilize.
- Use the peak marker function to determine the maximum power level in any 100 kHz band segment within the fundamental EBW.

MEASUREMENT PROCEDURE OOBE

- Set RBW = 100 kHz.
- Set VBW \geq 300 kHz.
- Ensure that the number of measurement points \geq span/RBW
- According to measurement points to set differ measurement span.
- Detector = average.
- Trace Mode = max hold.
- Sweep = auto couple.

4.6.5 Deviation from Test Standard

No deviation.

4.6.6 EUT Operating Condition

Same as Item 4.3.6

4.6.7 Test Results

The spectrum plots are attached on the following pages. D1 line indicates the highest level, and D2 line indicates the 30dB offset below D1. It shows compliance with the requirement.

Test Mode A
802.11b_Chain 0

CH 1

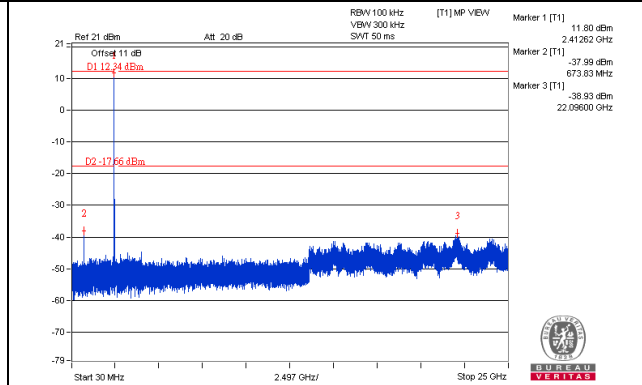
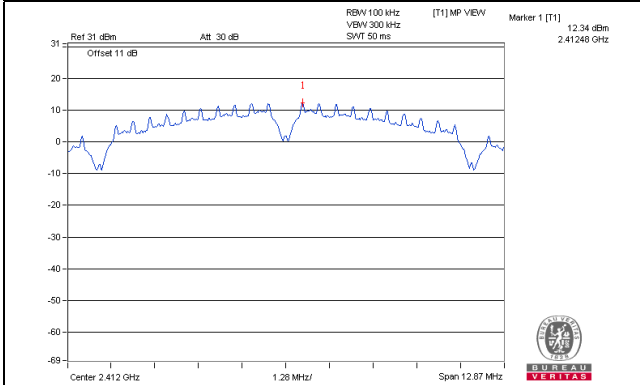

CH 6

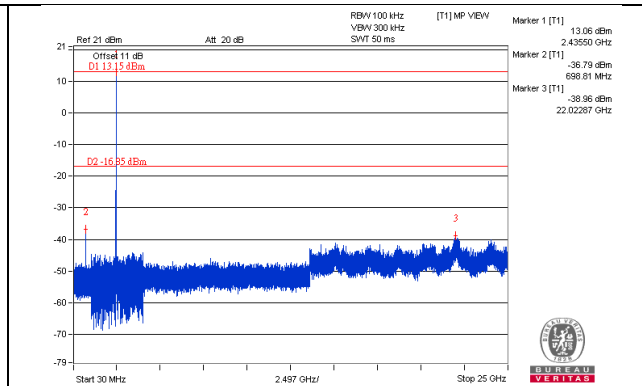
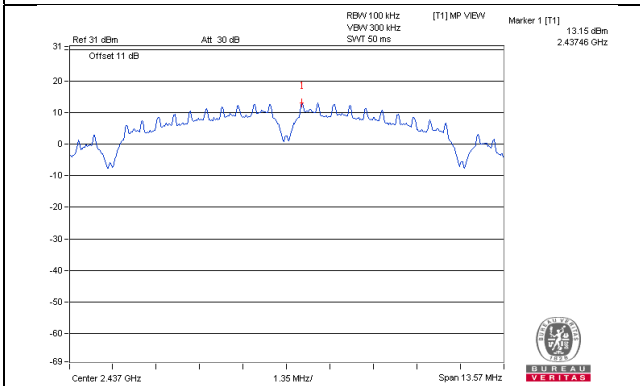

CH 11

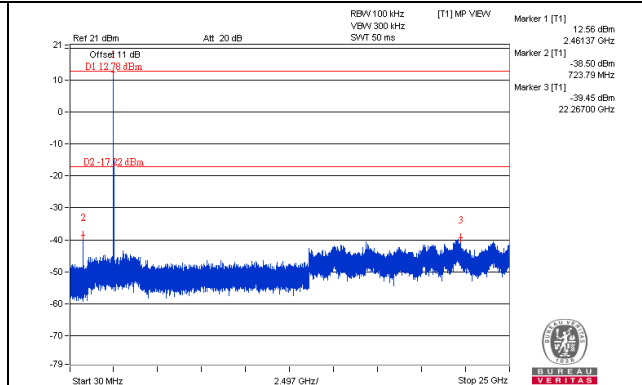
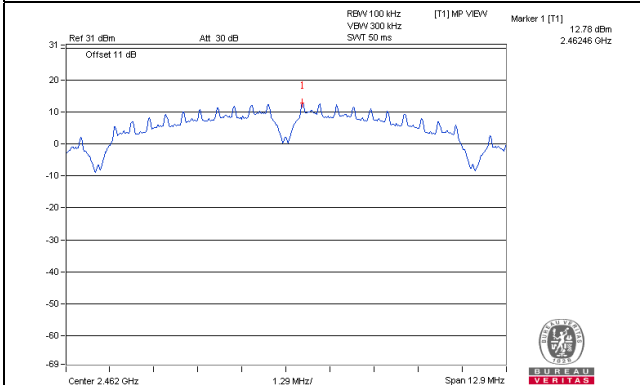

CH 1 Band edge

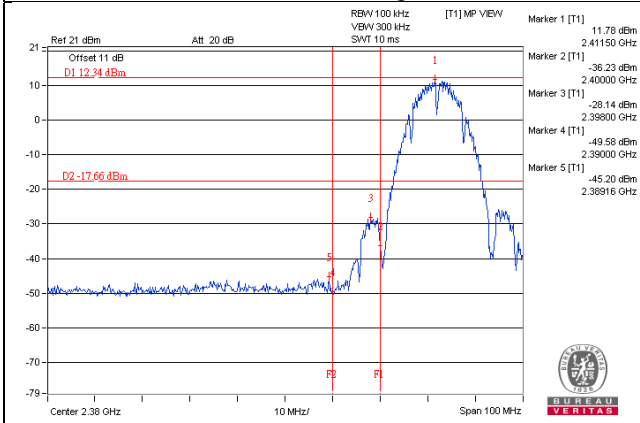

CH 11 Band edge

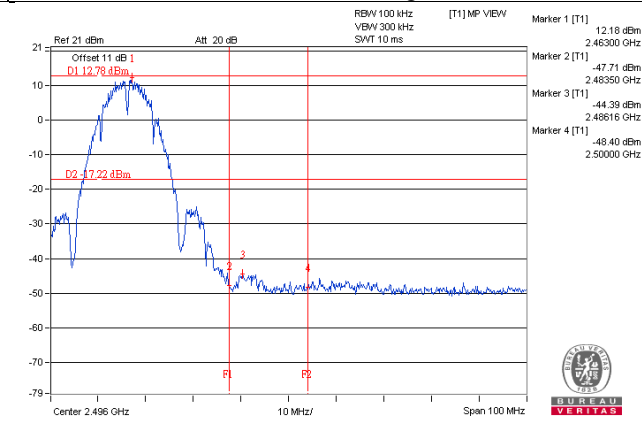

802.11b_Chain 1

CH 1

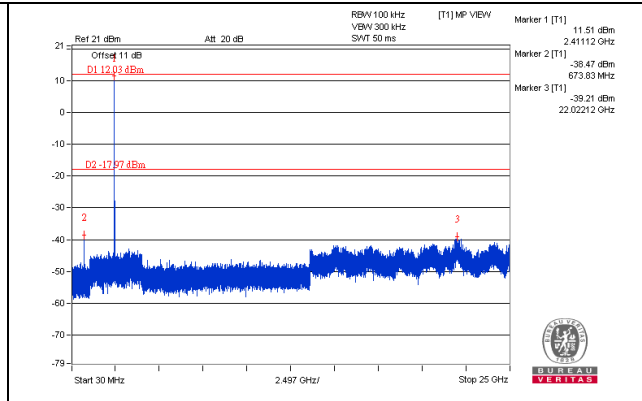
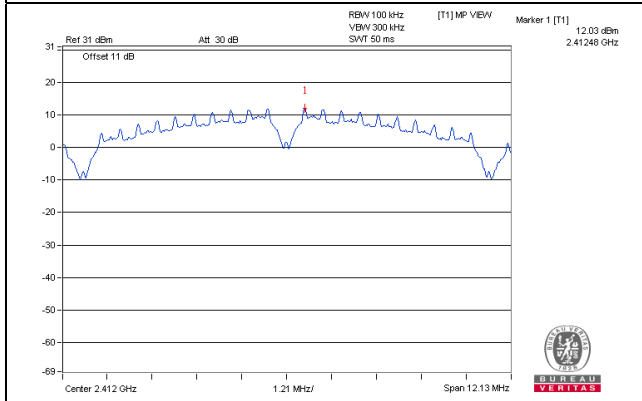

CH 6

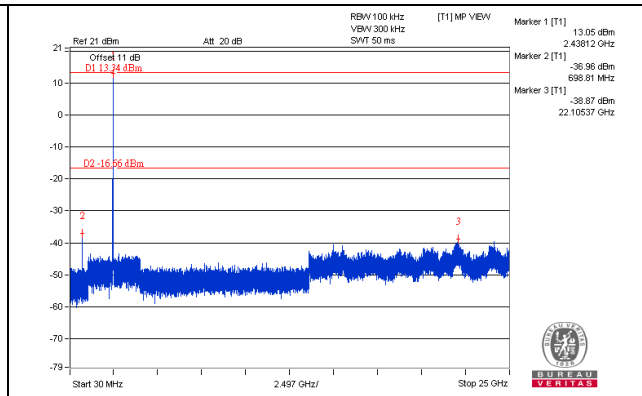
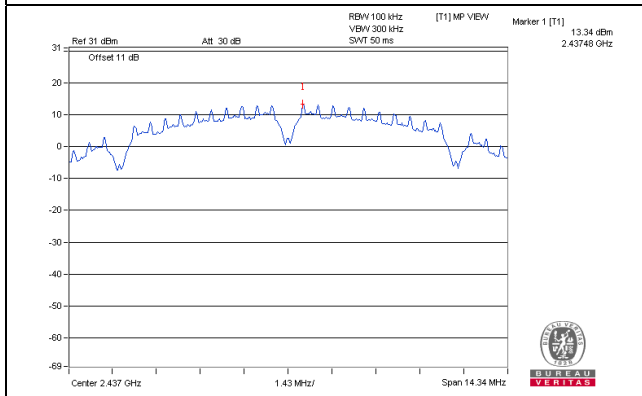

CH 11

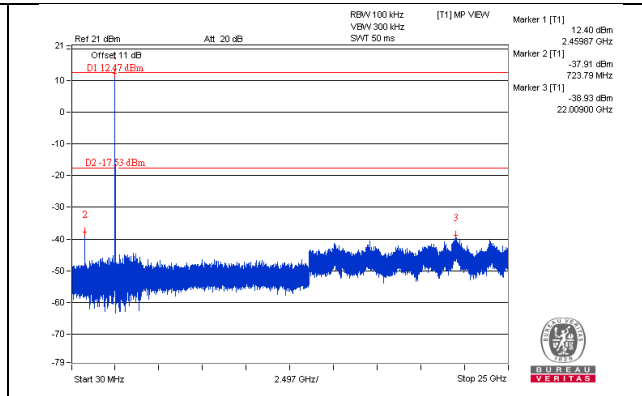
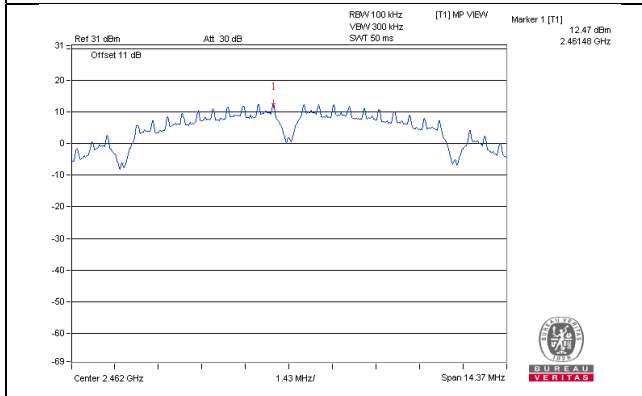

CH 1 Band edge

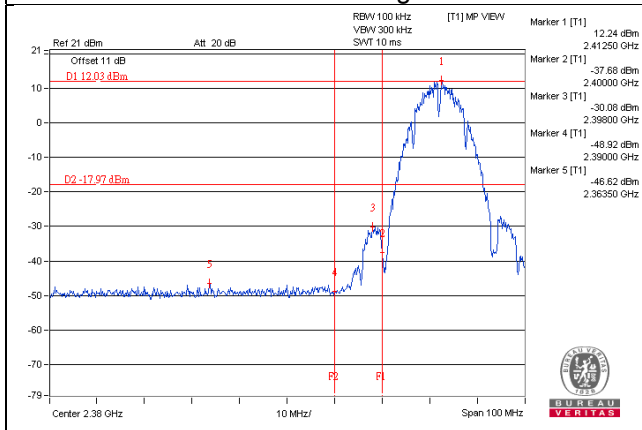

CH 11 Band edge

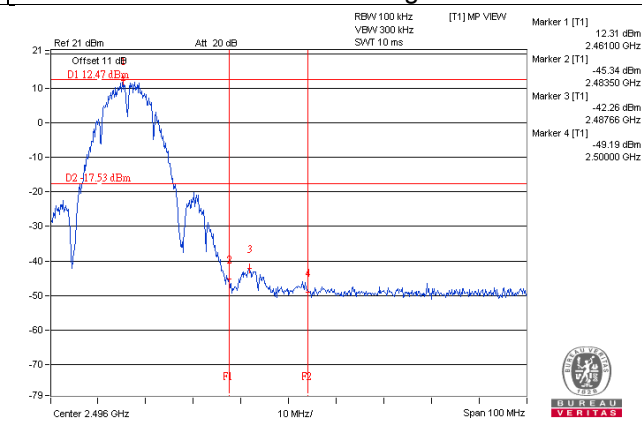

802.11b_Chain 2

CH 1

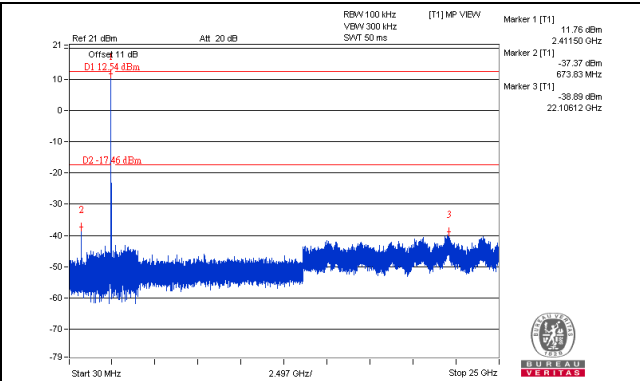
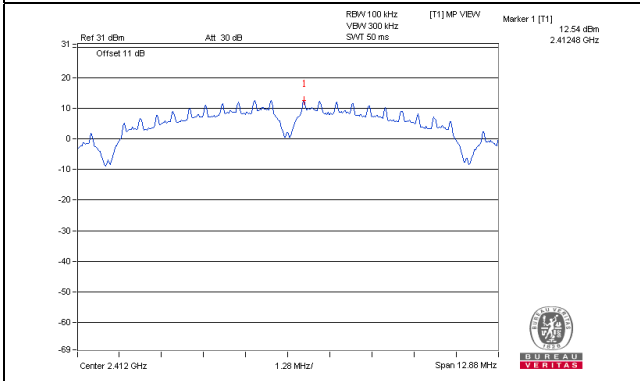

CH 6

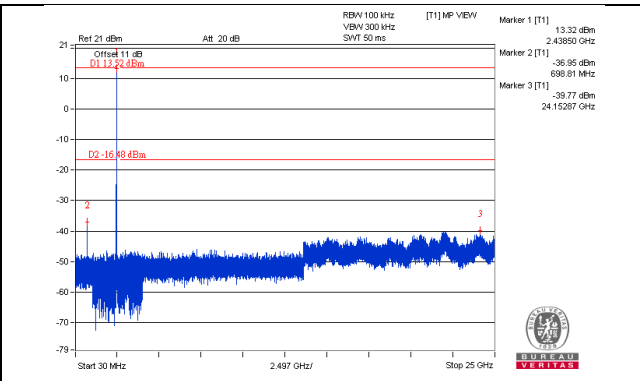
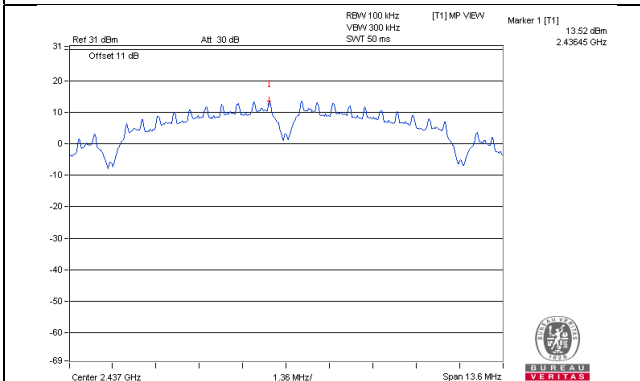

CH 11

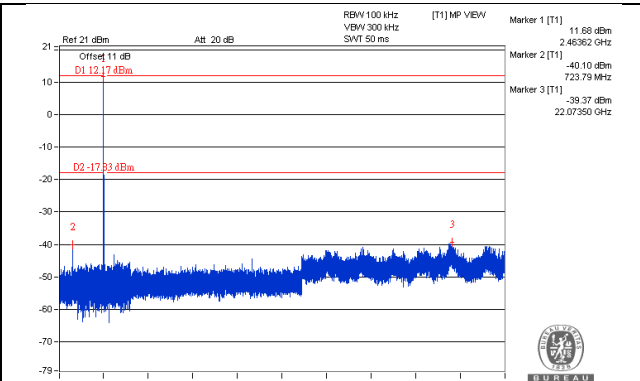
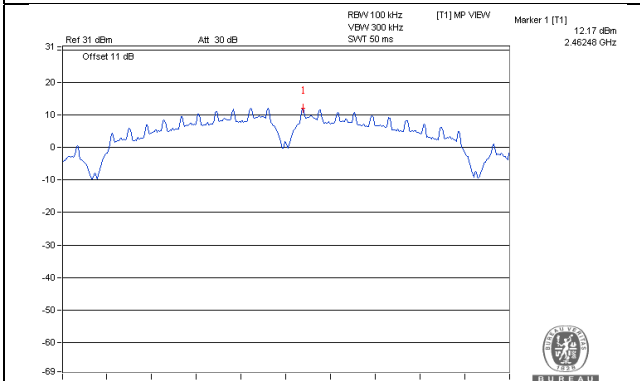

CH 1 Band edge

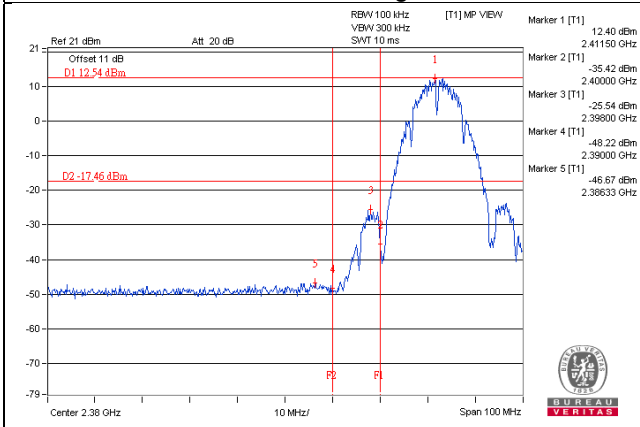

CH 11 Band edge

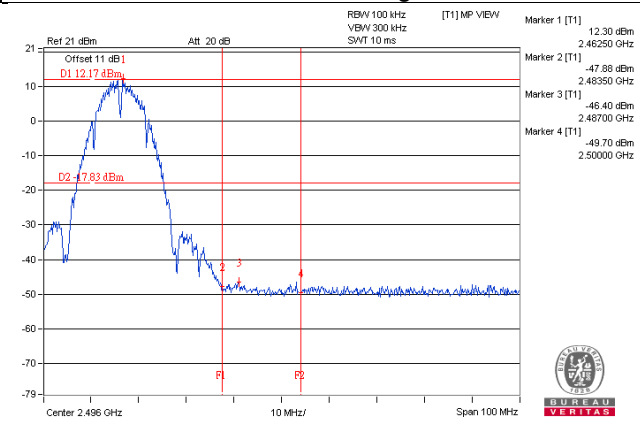

802.11b_Chain 3

CH 1

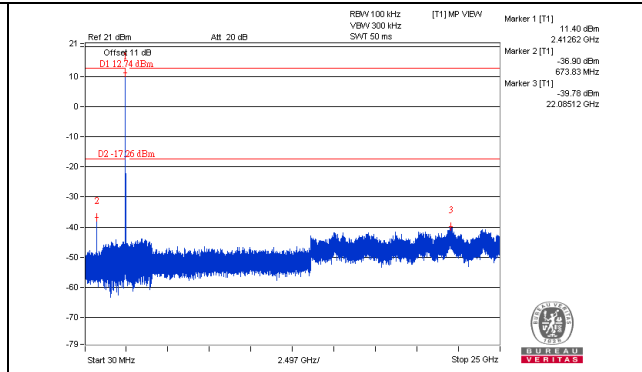
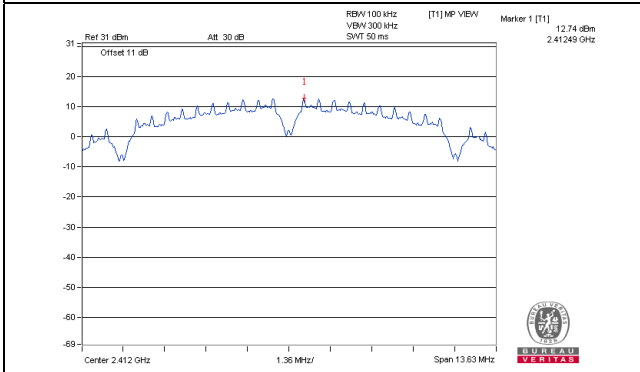

CH 6

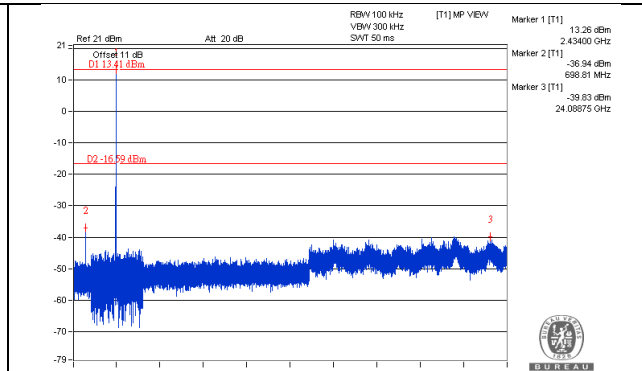
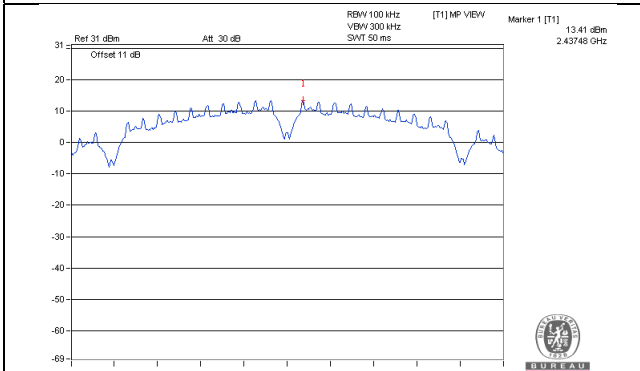

CH 11

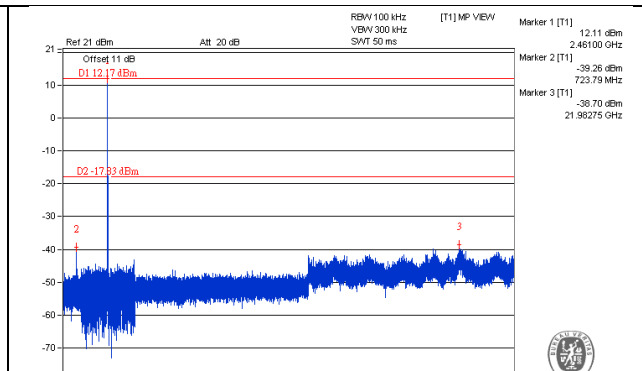
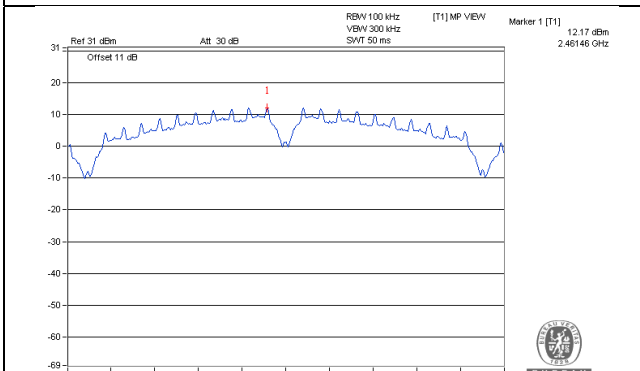

CH 1 Band edge

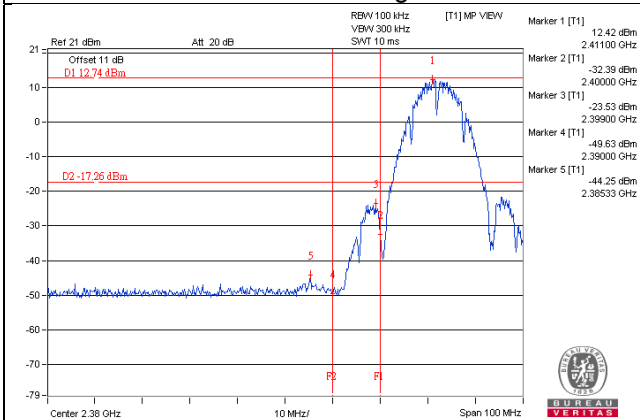

CH 11 Band edge

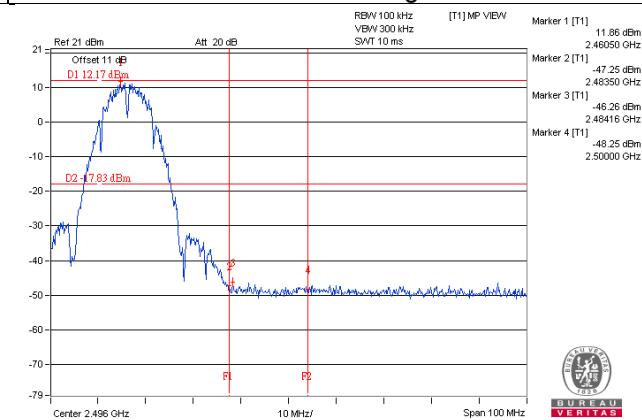

802.11g_Chain 0

CH 1

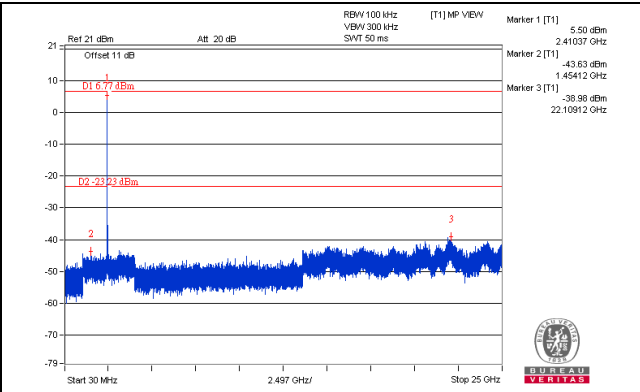
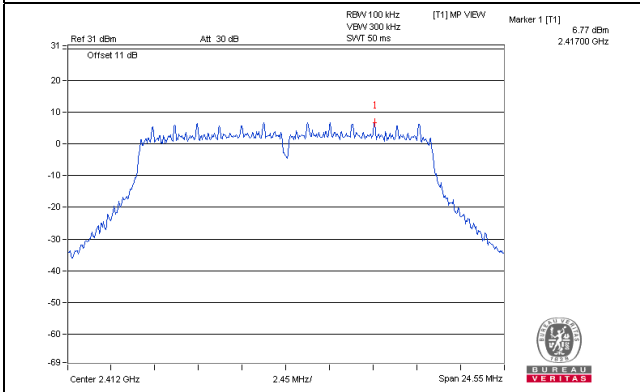

CH 6

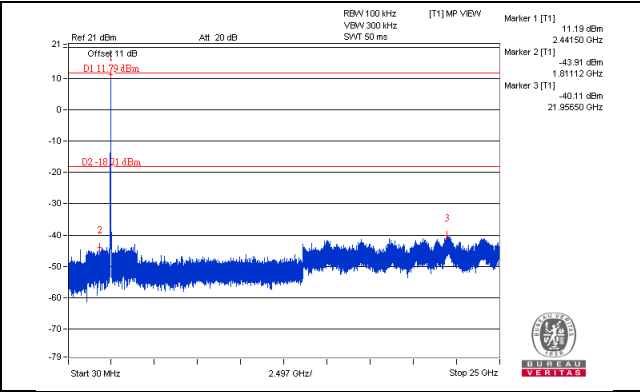
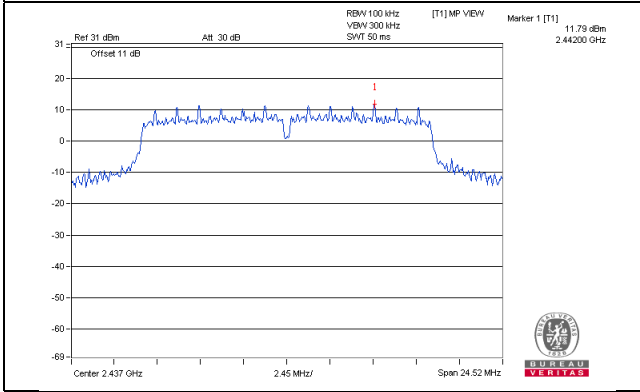

CH 11

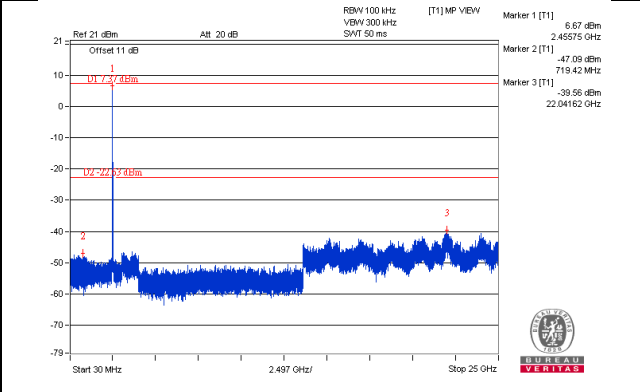
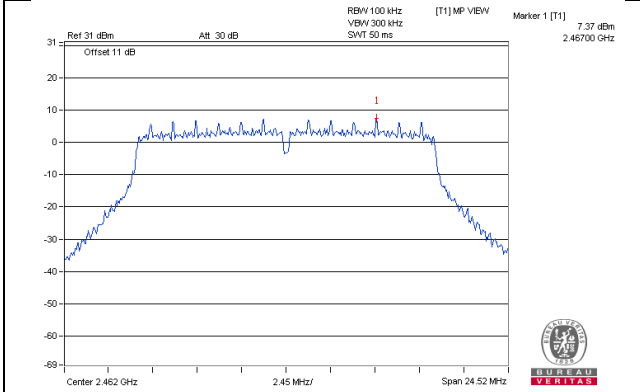

CH 1 Band edge

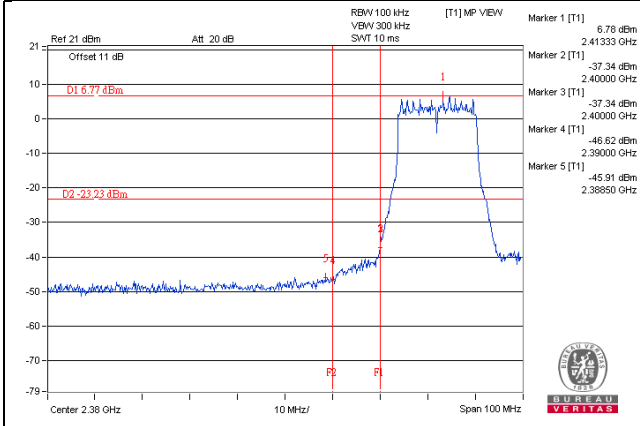

CH 11 Band edge

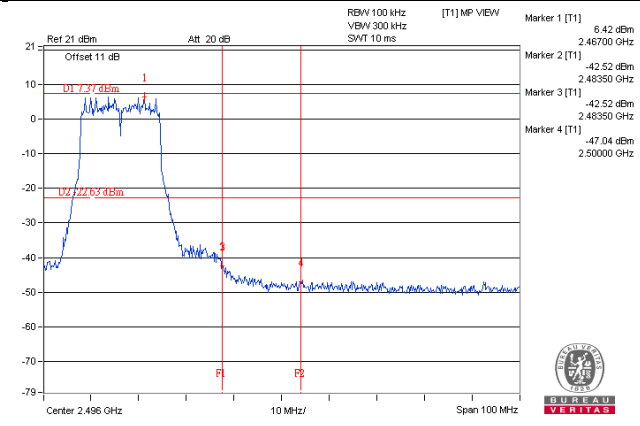

802.11g_Chain 1

CH 1

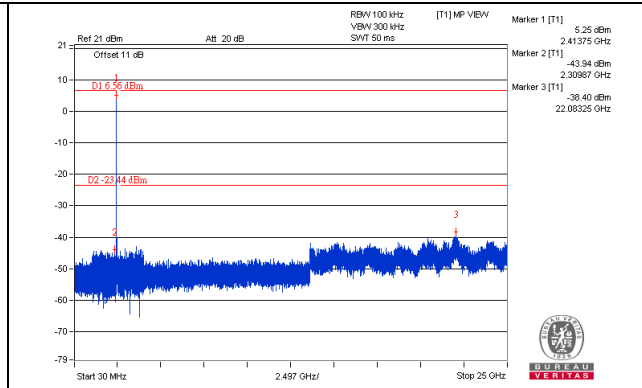
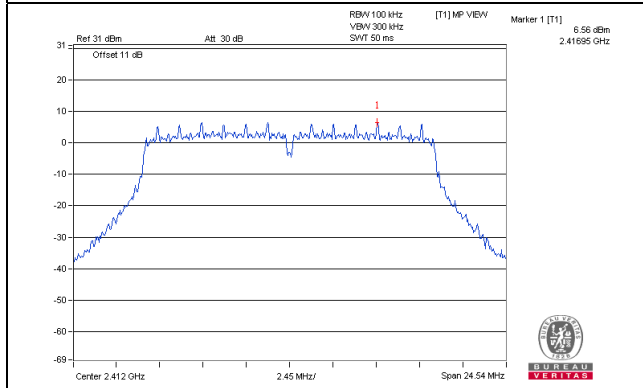

CH 6

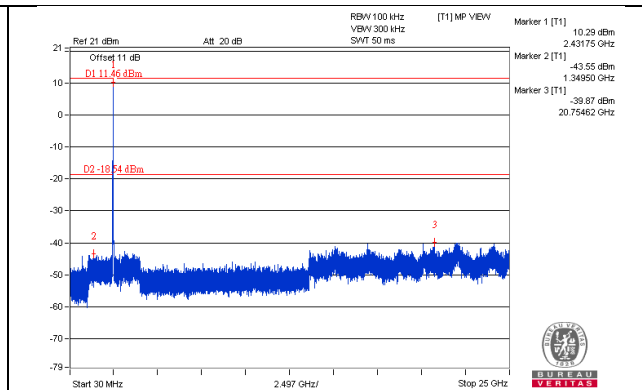
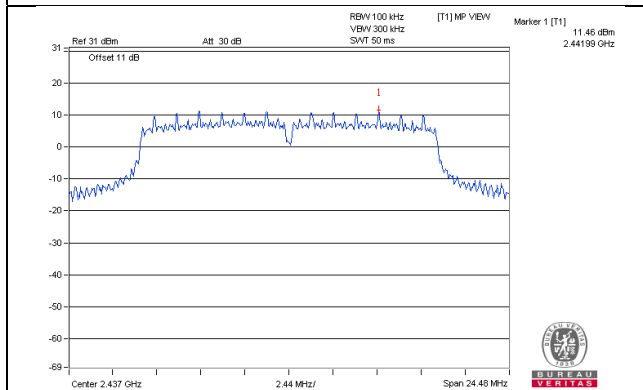

CH 11

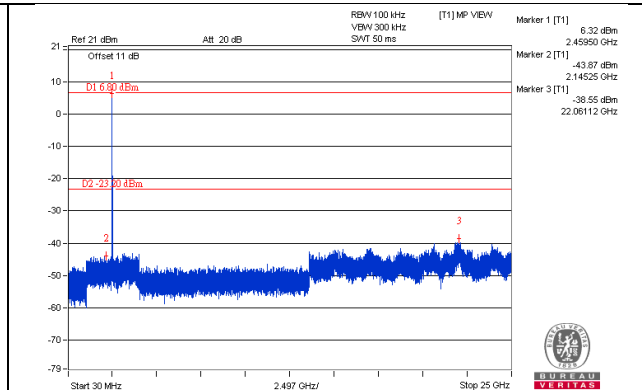
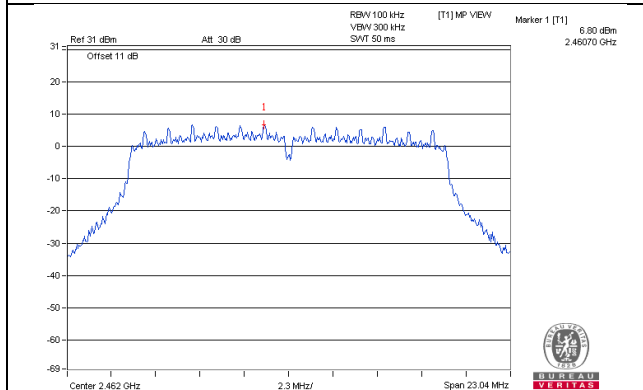

CH 1 Band edge

CH 11 Band edge

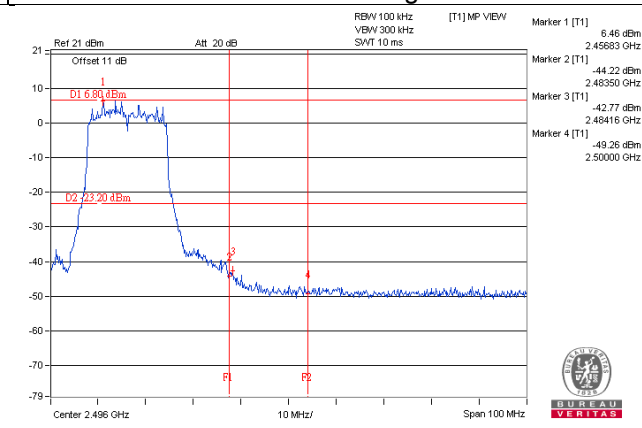
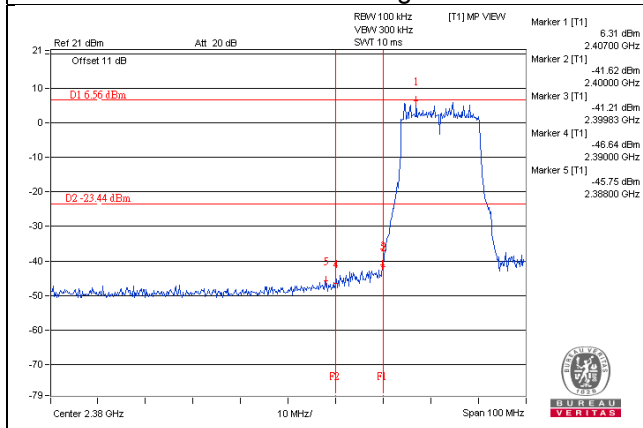

802.11g_Chain 2

CH 1

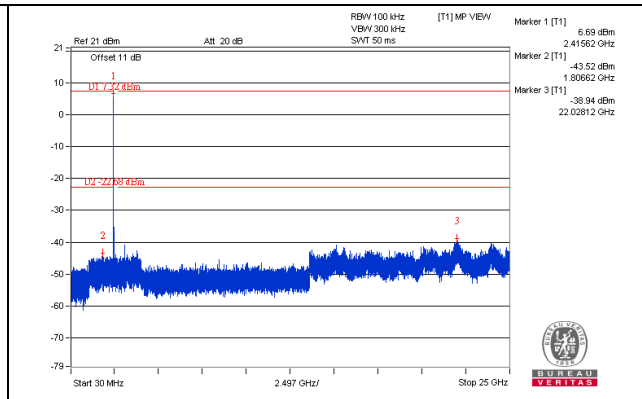
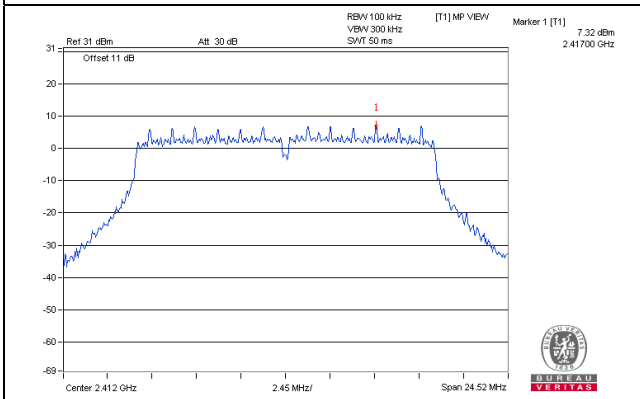

CH 6

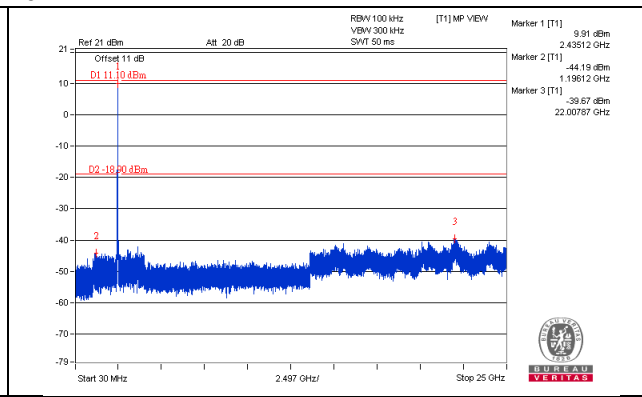
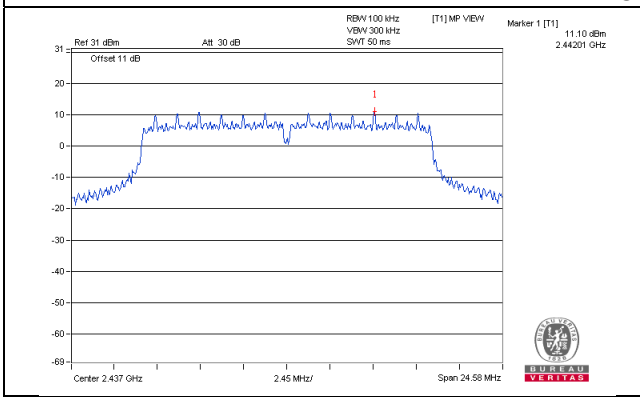

CH 11

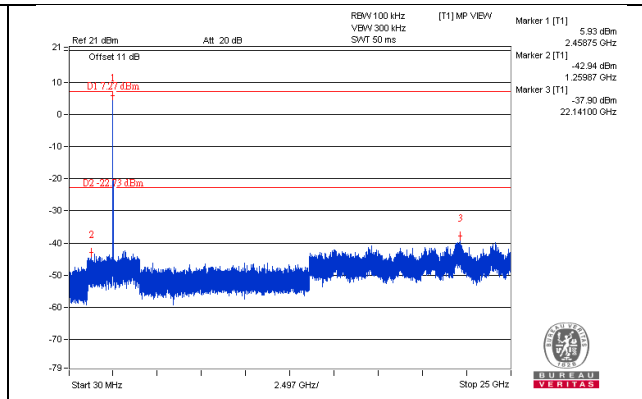
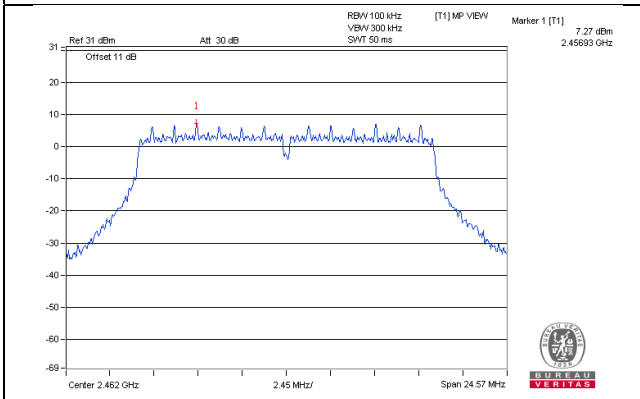

CH 1 Band edge

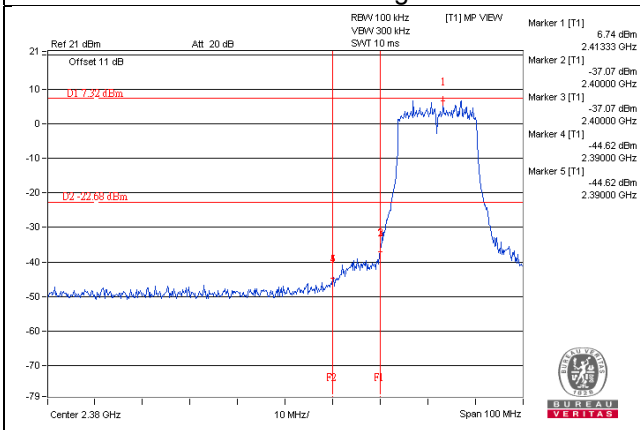

CH 11 Band edge

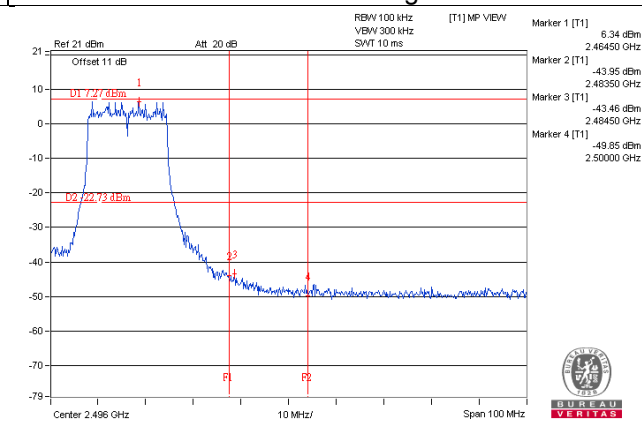

802.11g_Chain 3

CH 1

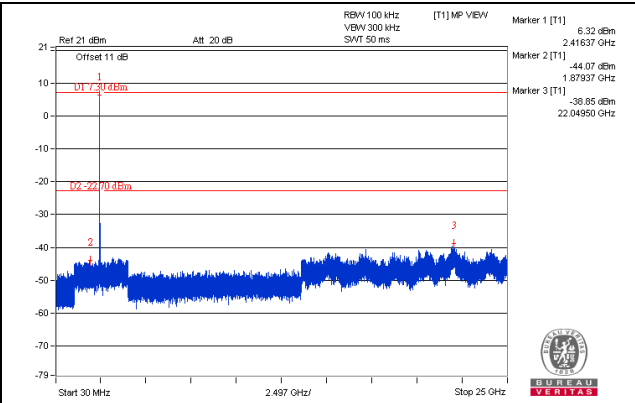
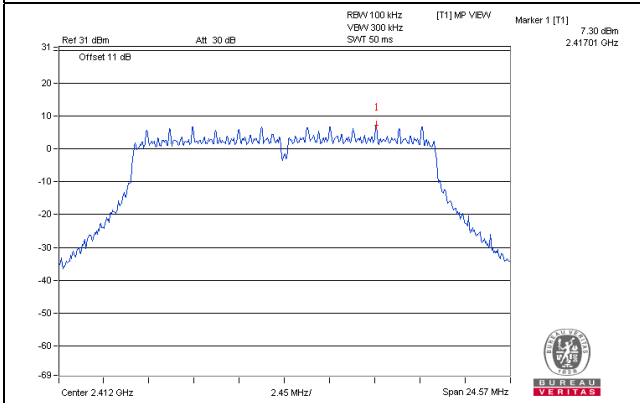

CH 6

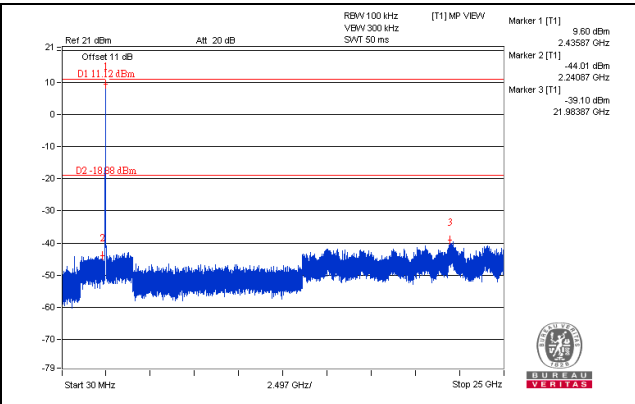
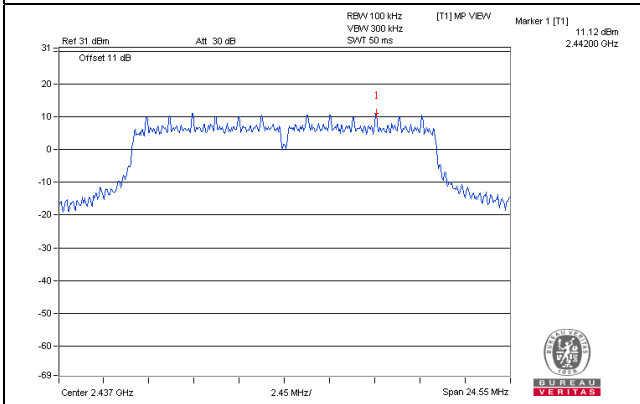

CH 11

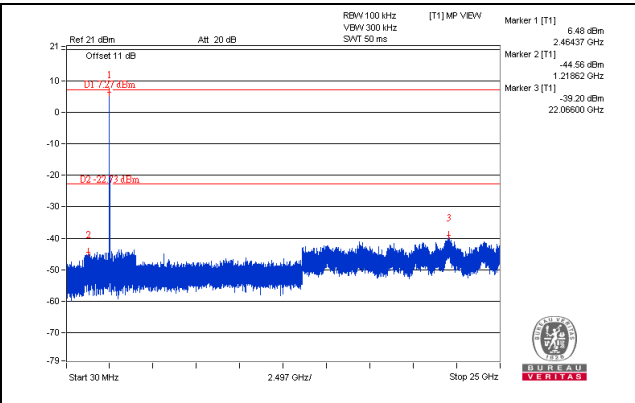
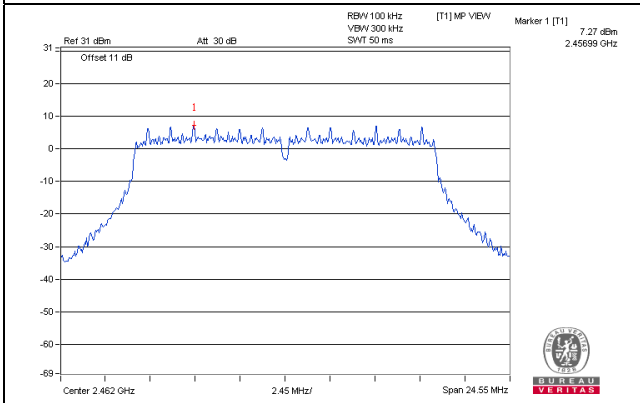

CH 1 Band edge

CH 11 Band edge

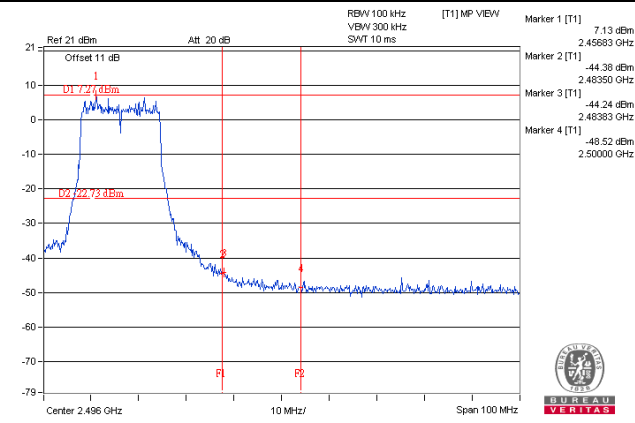
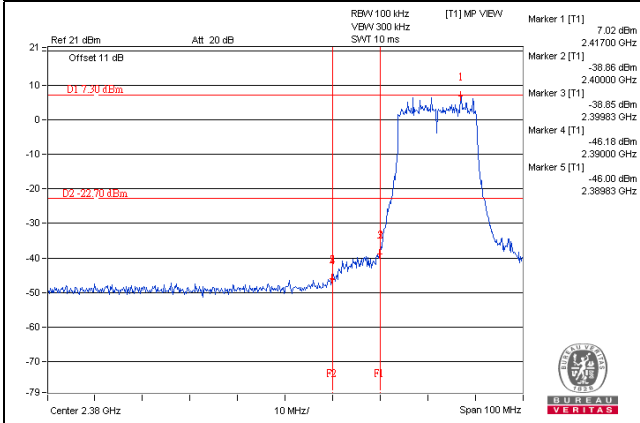

802.11n (HT20)_Chain 0

CH 1

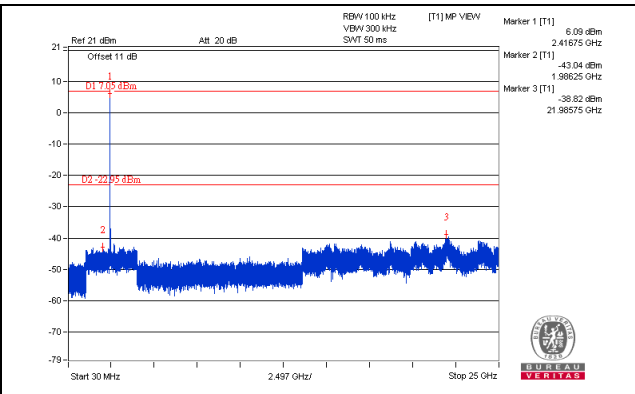
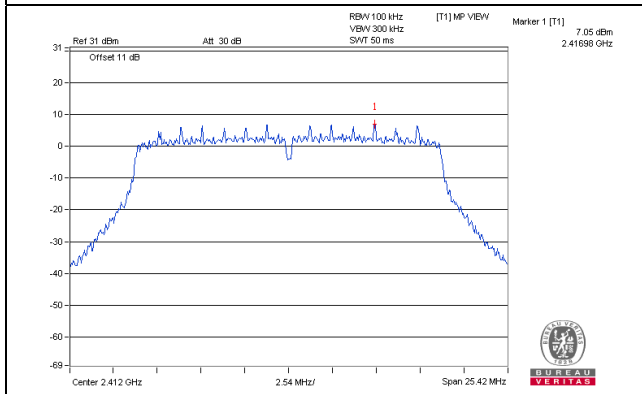

CH 6

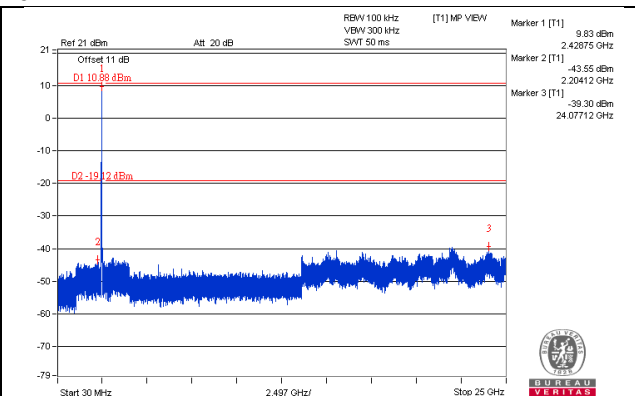
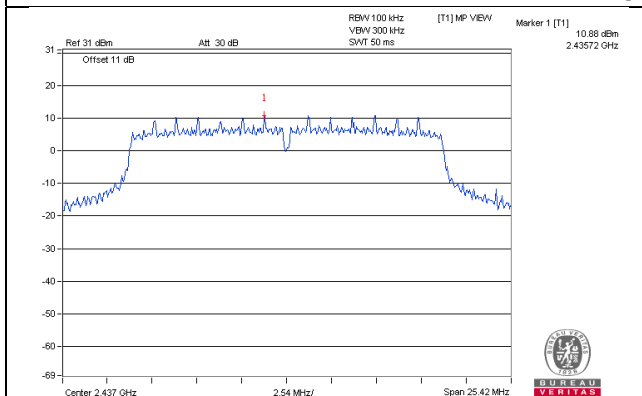

CH 11

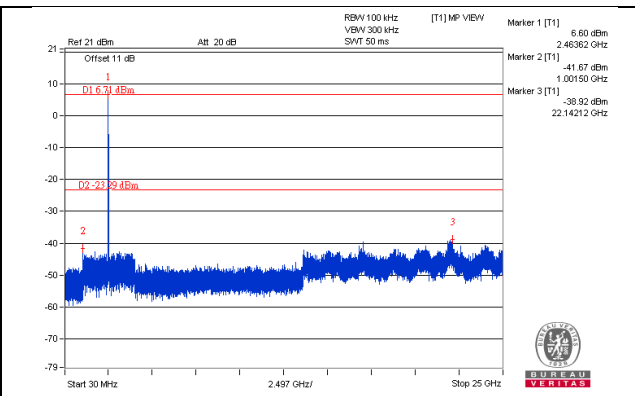
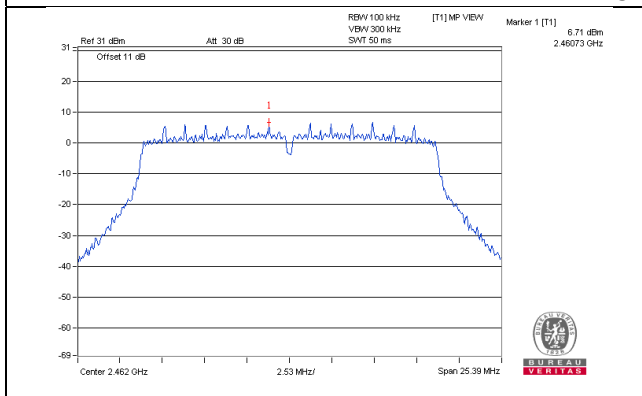

CH 1 Band edge

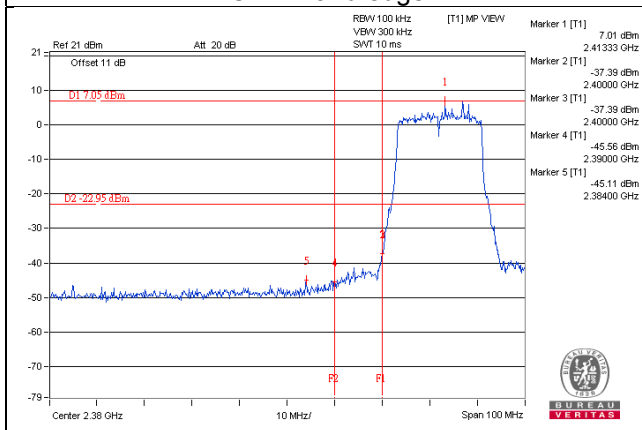

CH 11 Band edge

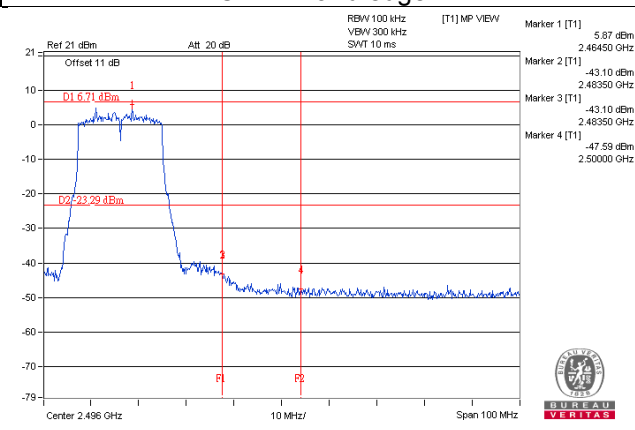

802.11n (HT20)_Chain 1

CH 1

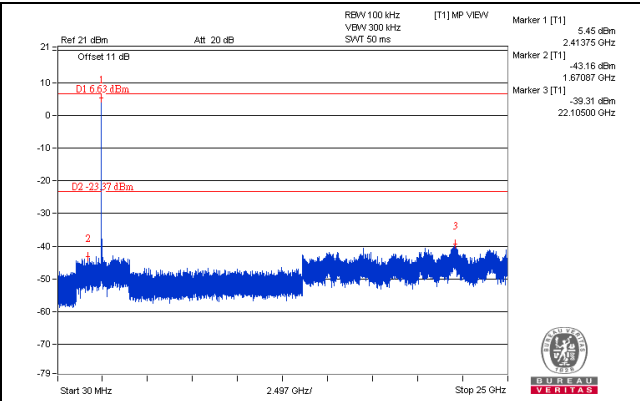
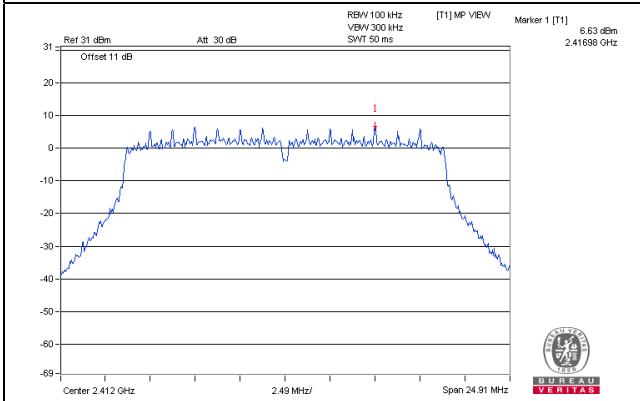

CH 6

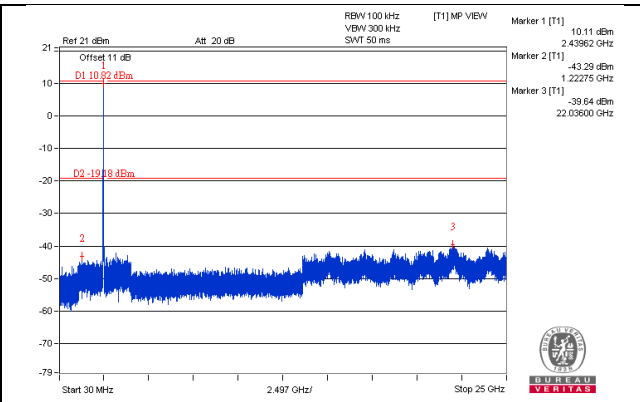
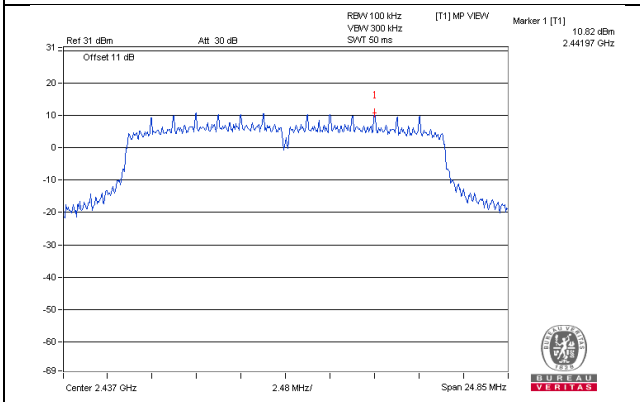

CH 11

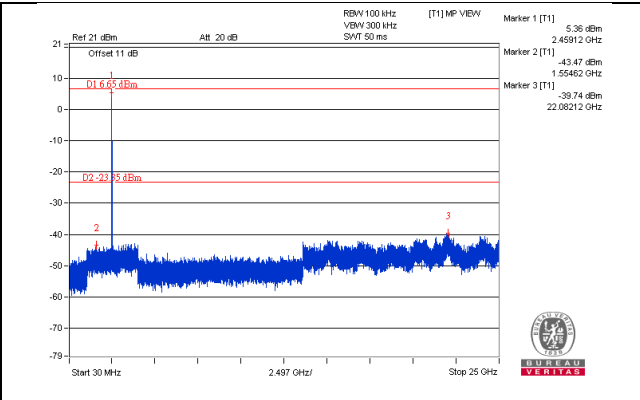
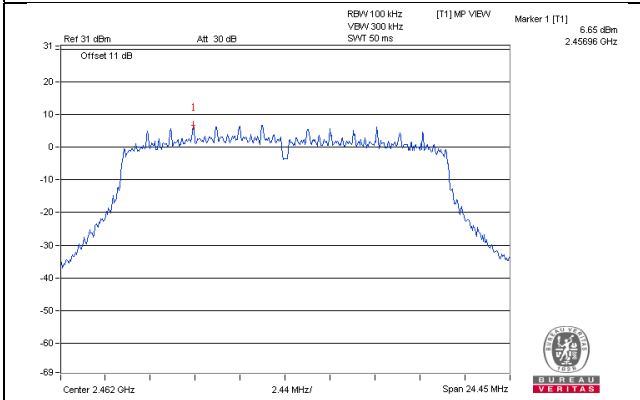

CH 1 Band edge

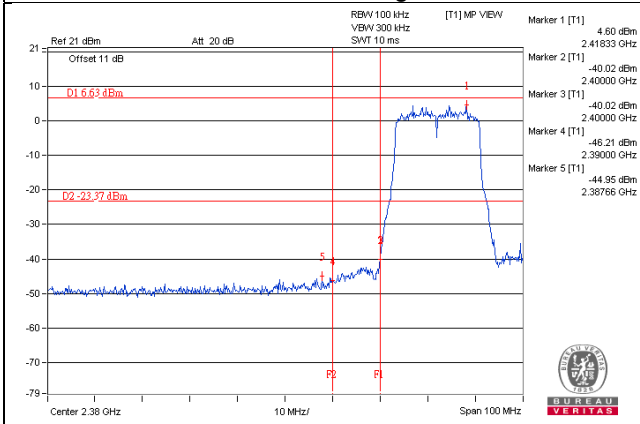

CH 11 Band edge

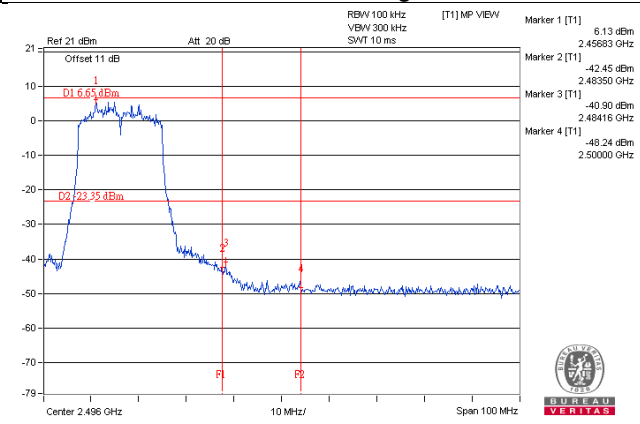

802.11n (HT20)_Chain 2

CH 1

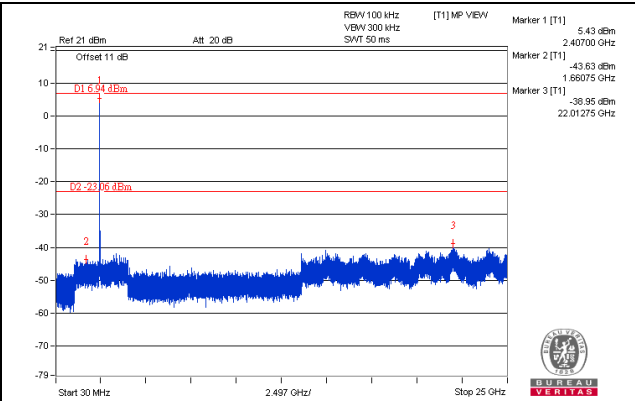
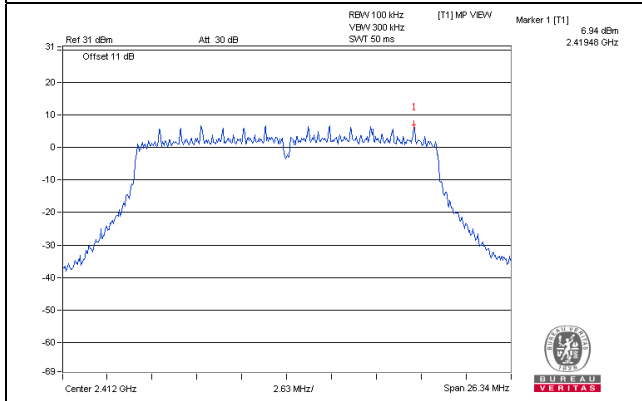

CH 6

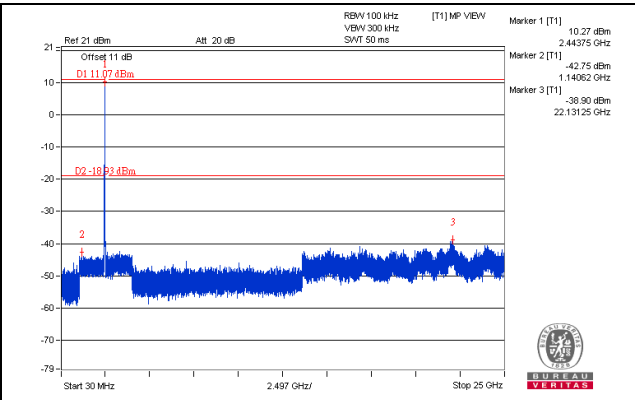
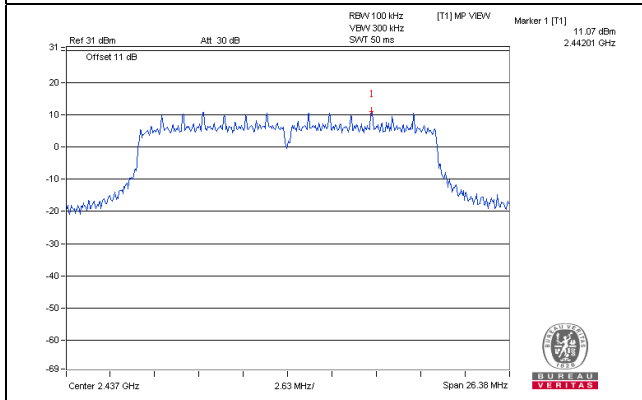

CH 11

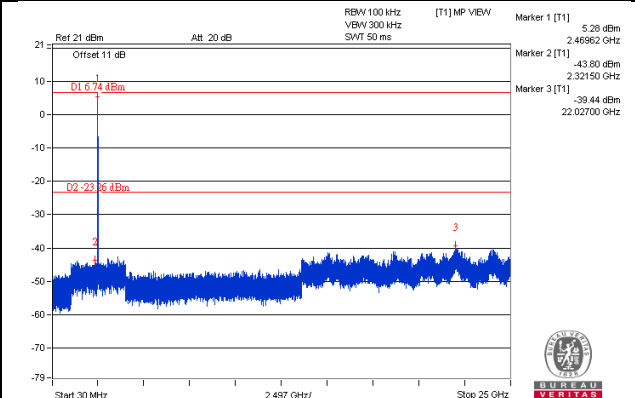
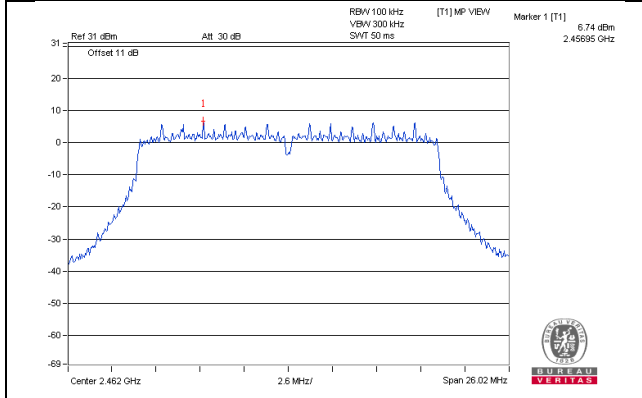

CH 1 Band edge

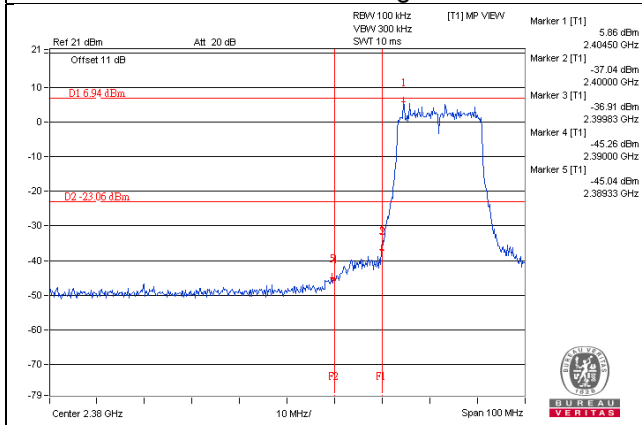

CH 11 Band edge

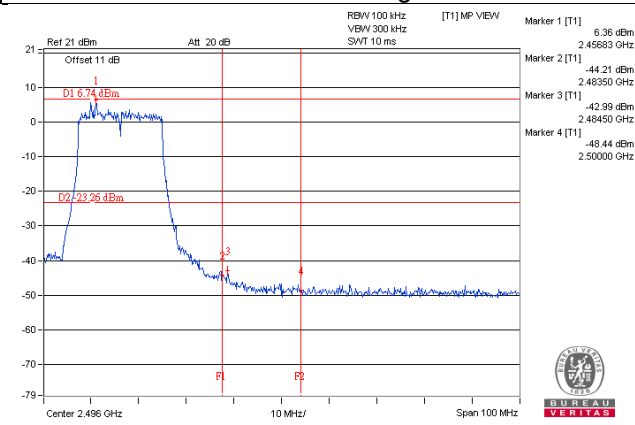

802.11n (HT20)_Chain 3

CH 1

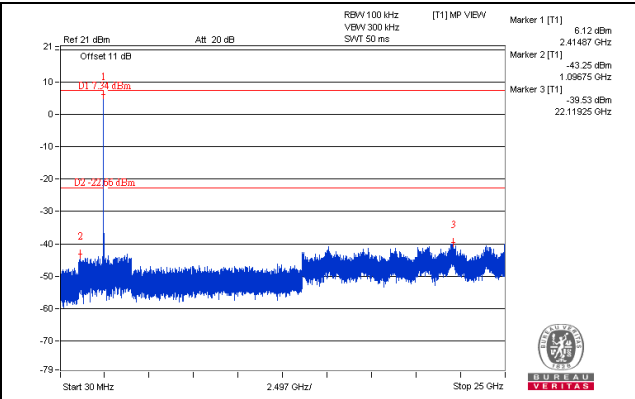
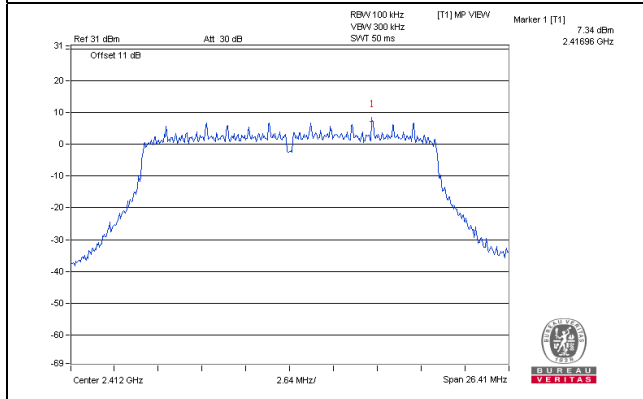

CH 6

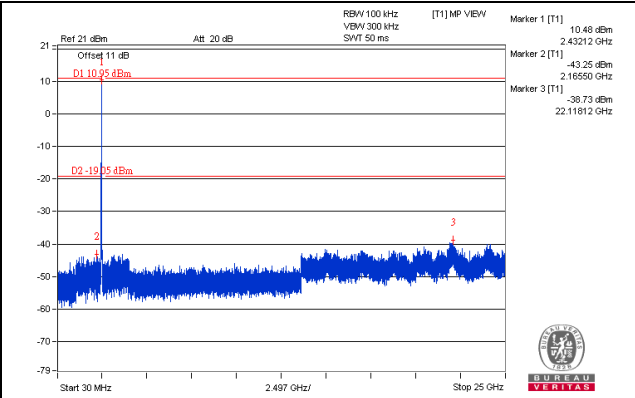
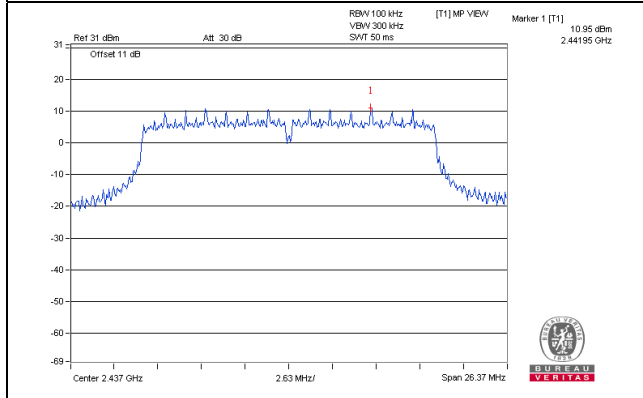

CH 11

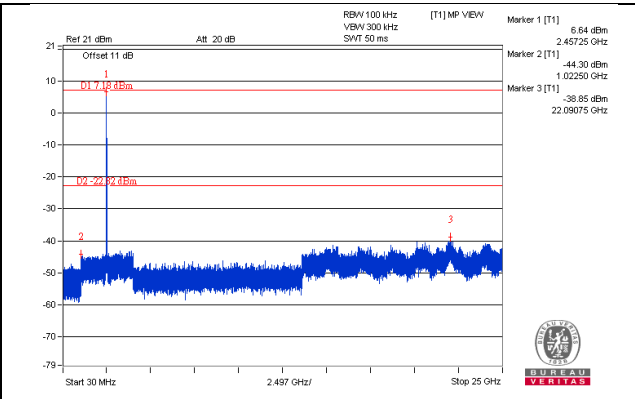
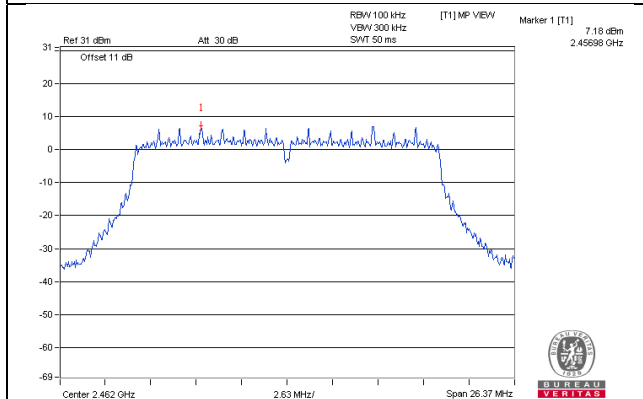

CH 1 Band edge

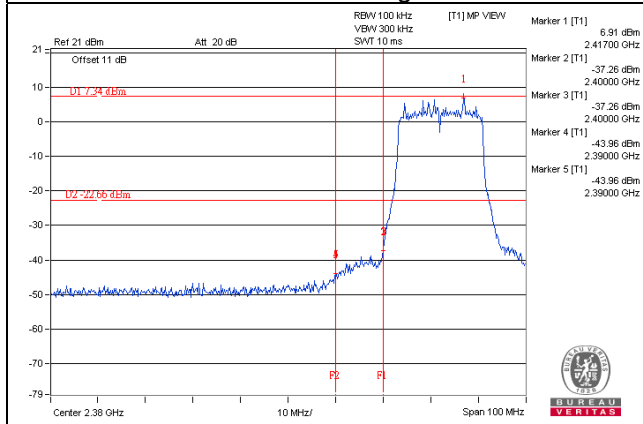

CH 11 Band edge

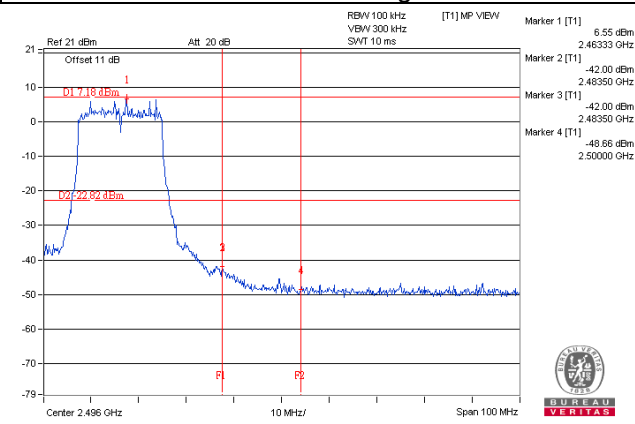

802.11n (HT40)_Chain 0

CH 3

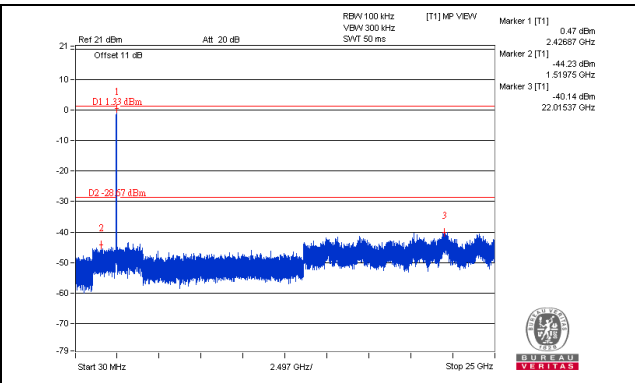
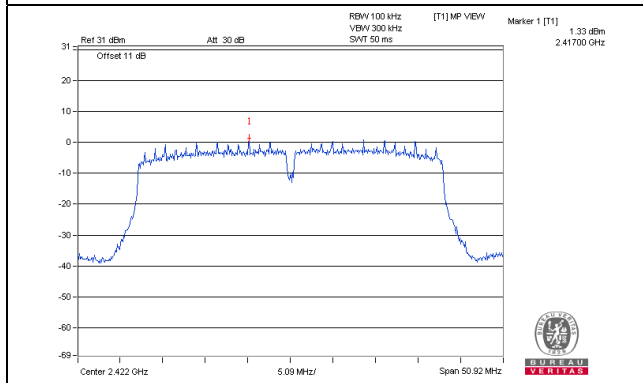

CH 6

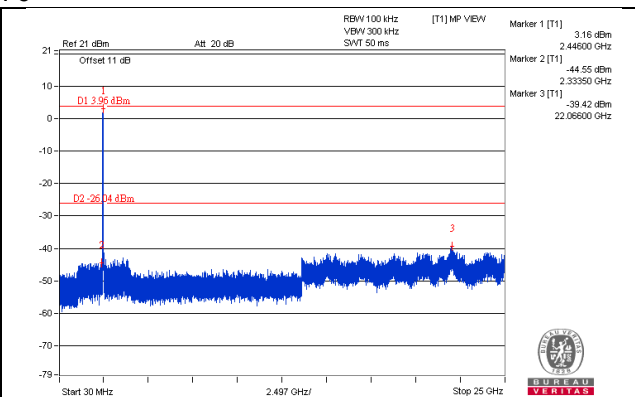
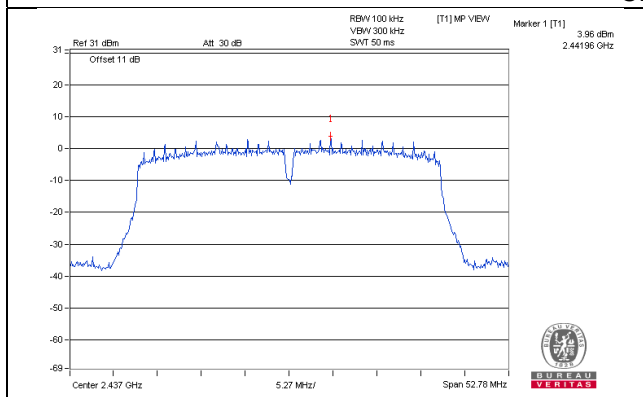

CH 9

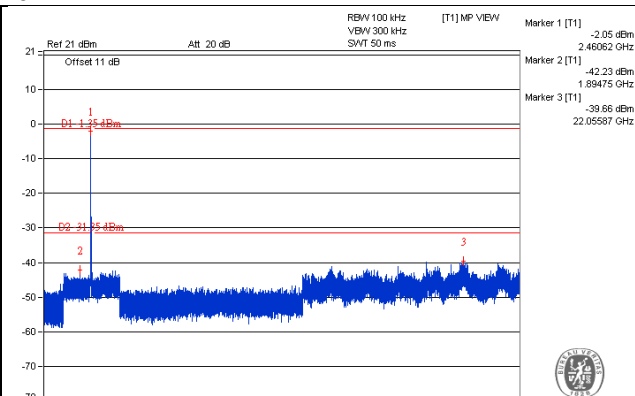
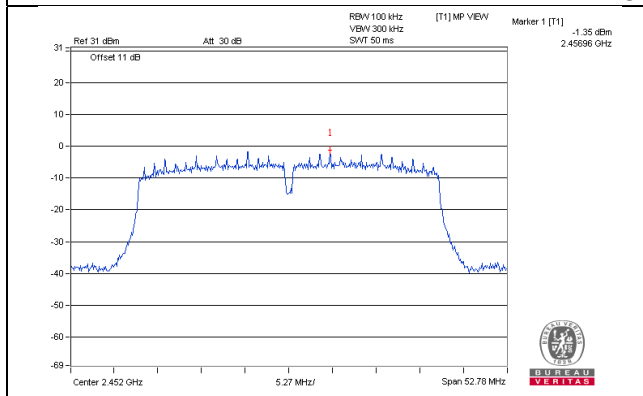

CH 3 Band edge

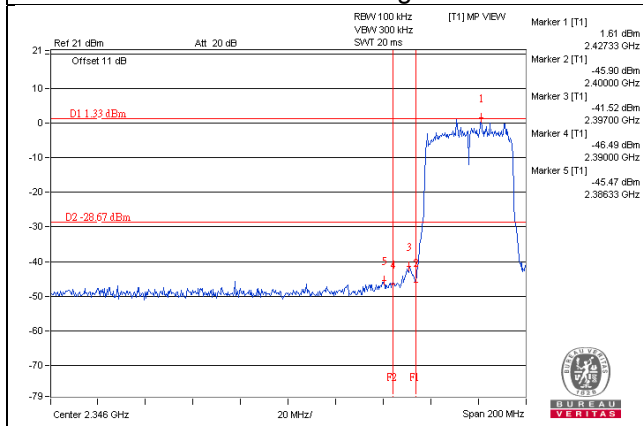

CH 9 Band edge

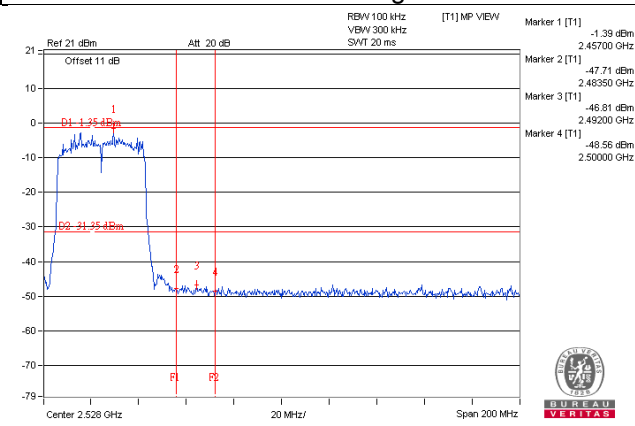

802.11n (HT40)_Chain 1

CH 3

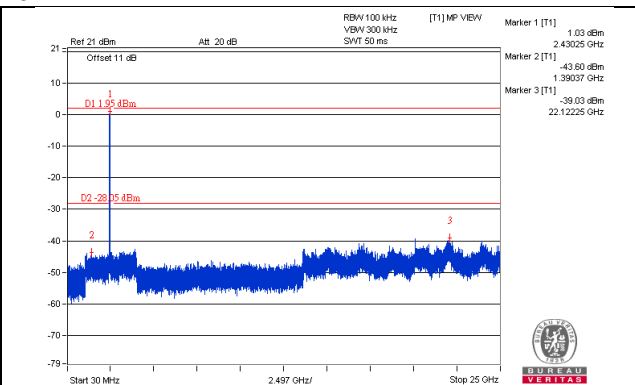
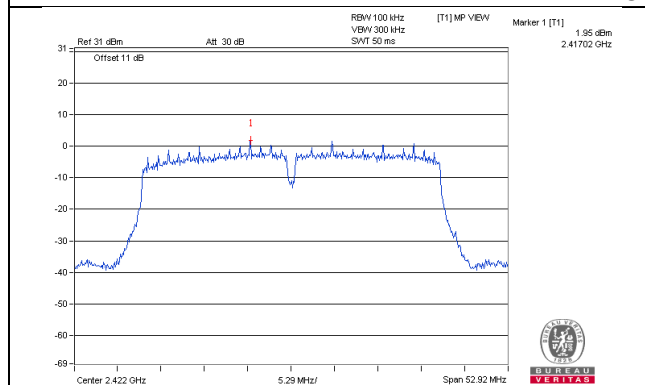

CH 6

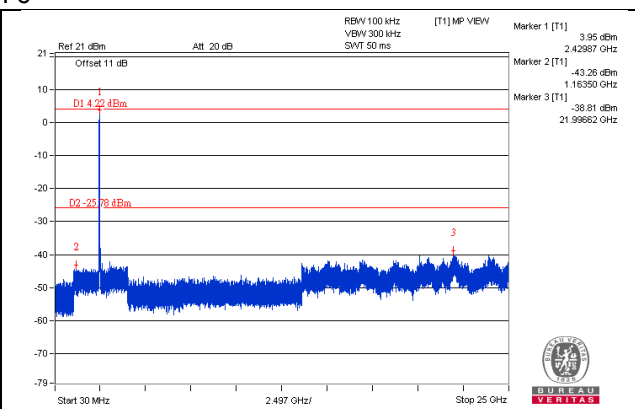
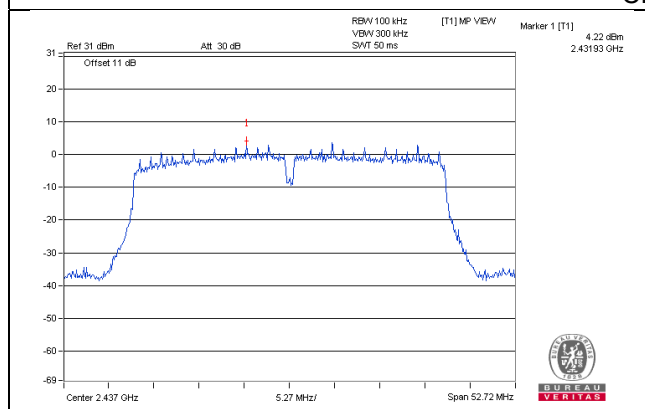

CH 9

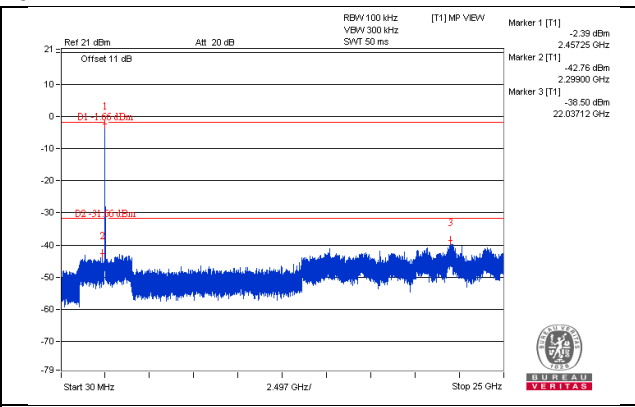
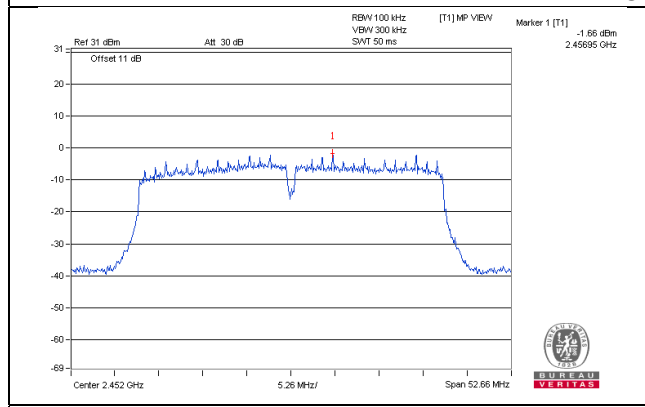

CH 3 Band edge

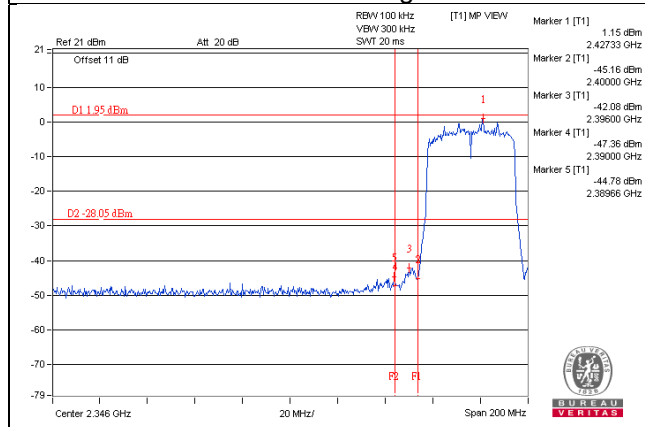

CH 9 Band edge

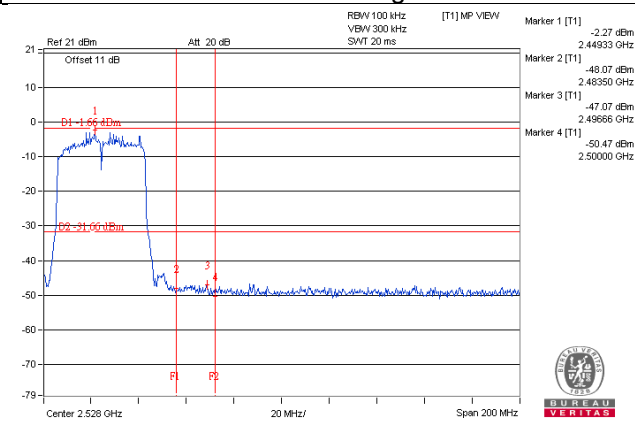

802.11n (HT40)_Chain 2

CH 3

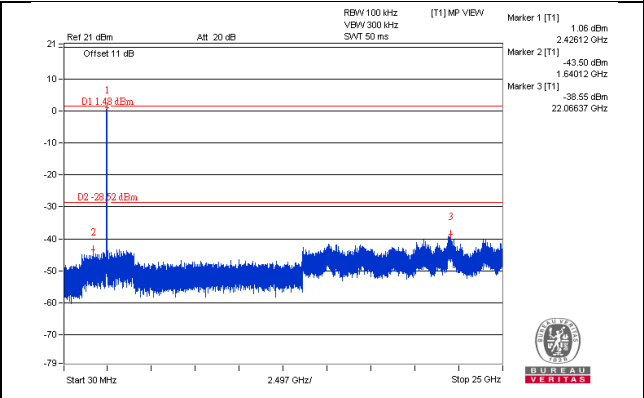
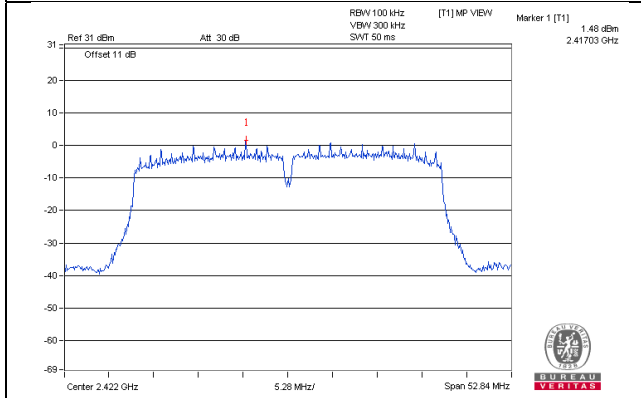

CH 6

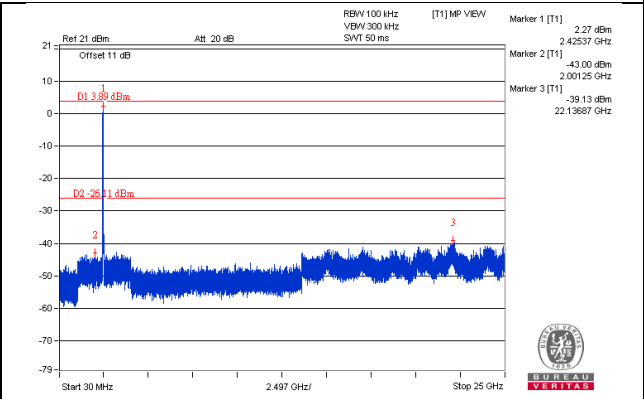
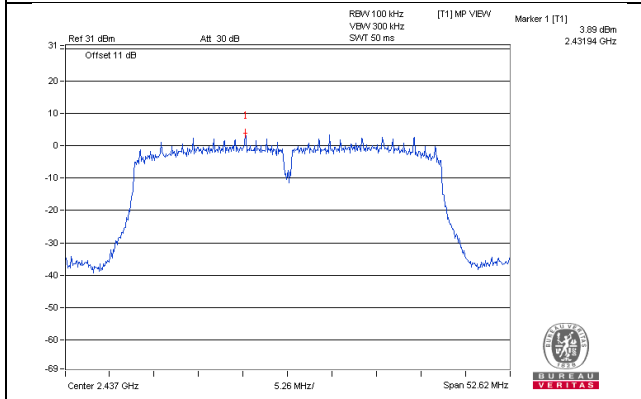

CH 9

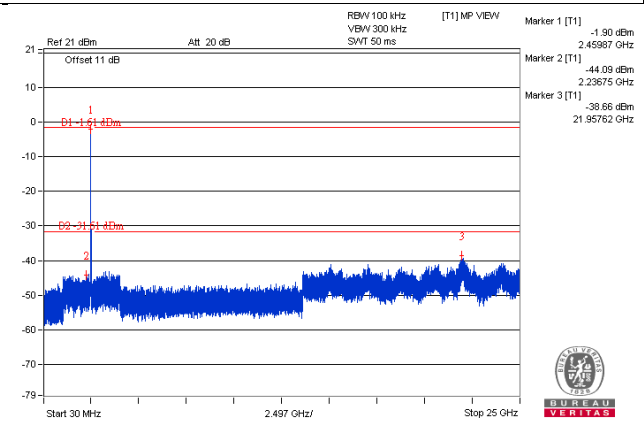
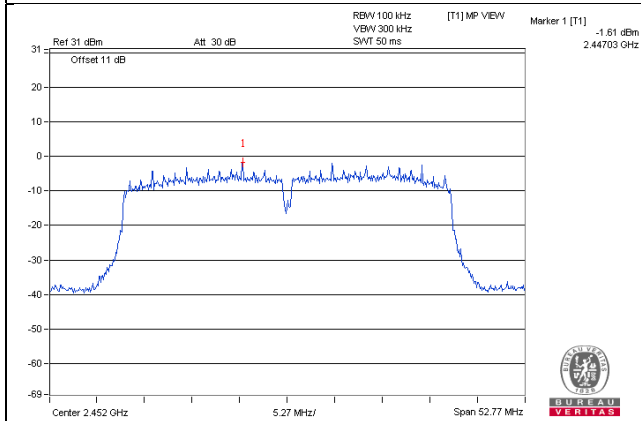

CH 3 Band edge

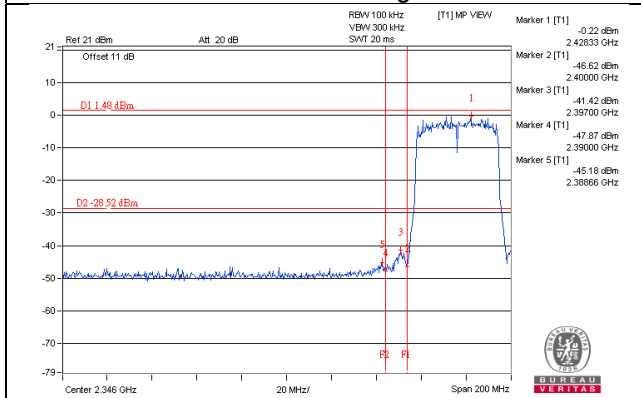

CH 9 Band edge

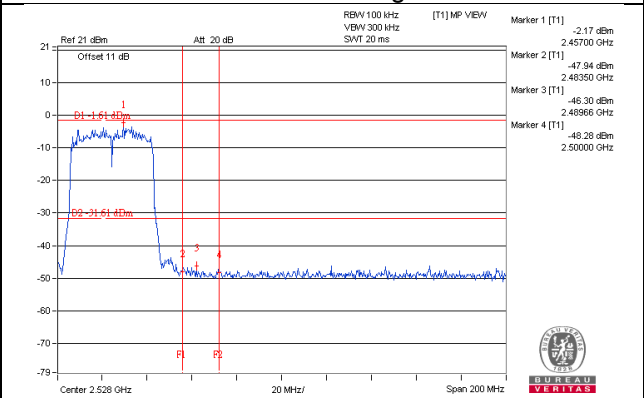

802.11n (HT40)_Chain 3

CH 3

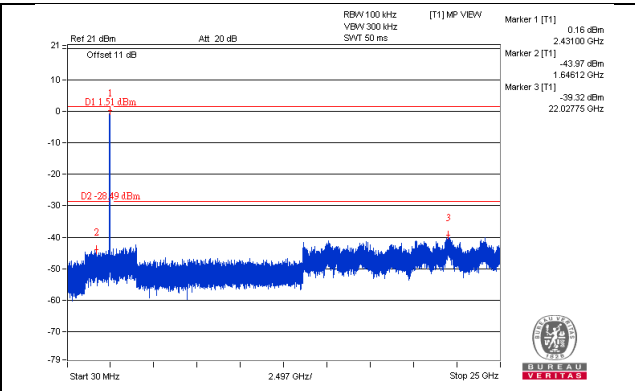
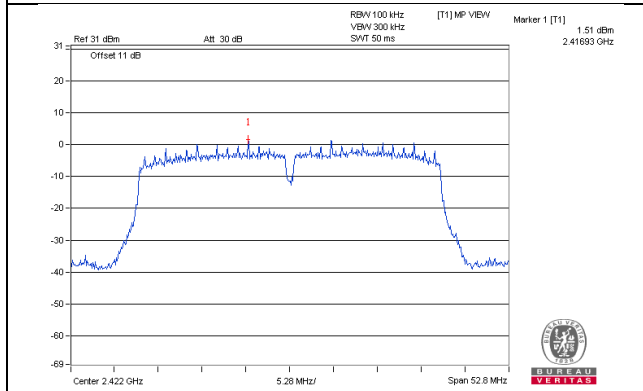

CH 6

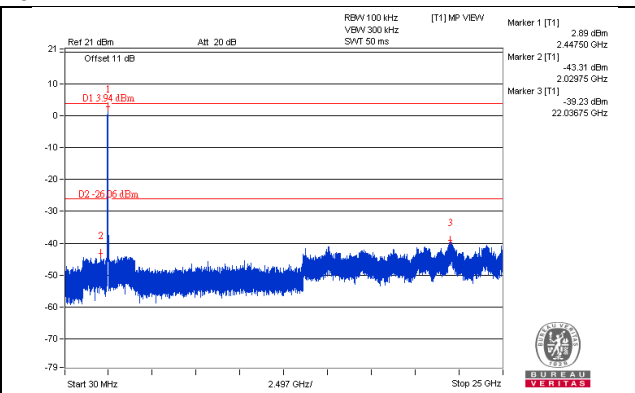
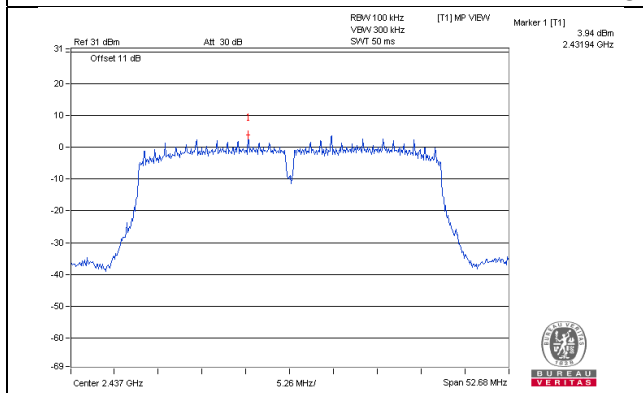

CH 9

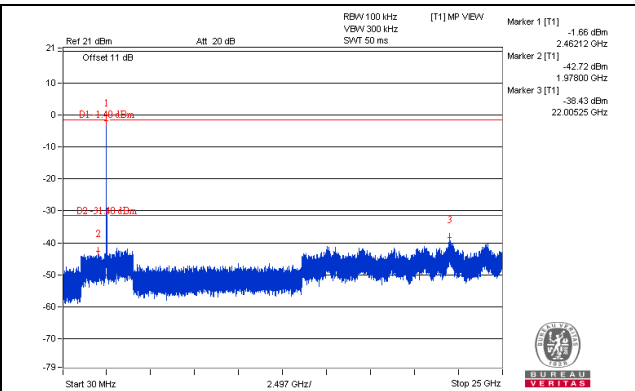
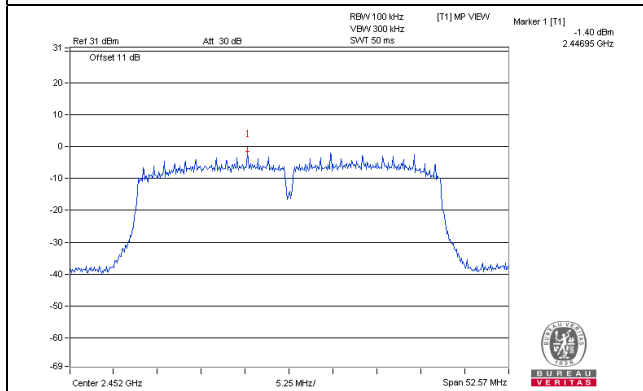

CH 3 Band edge

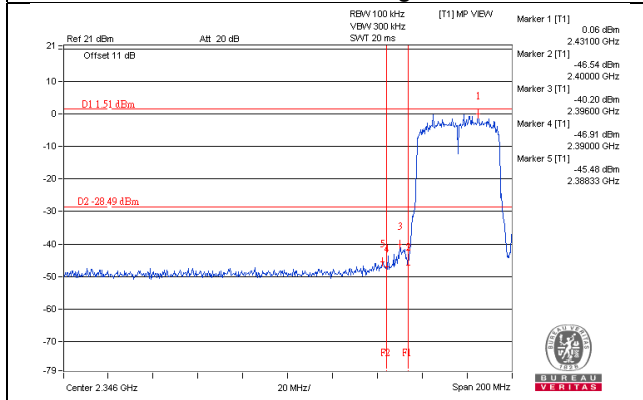

CH 9 Band edge

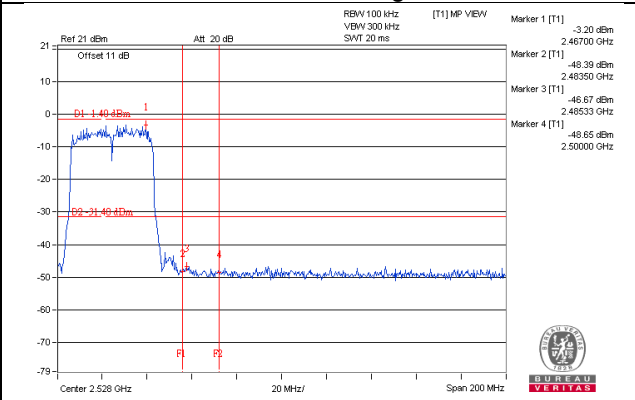



BUREAU VERITAS

Test Mode B 802.11b_Chain 0

CH 1

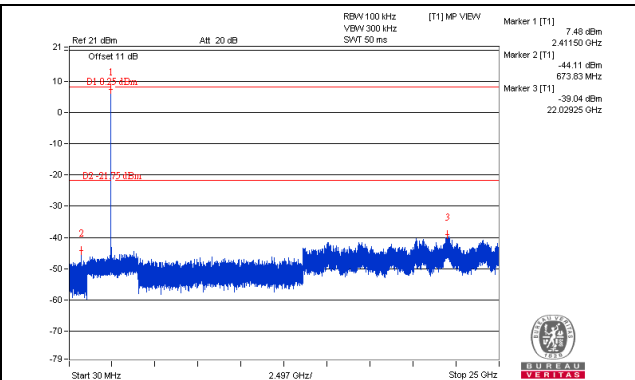
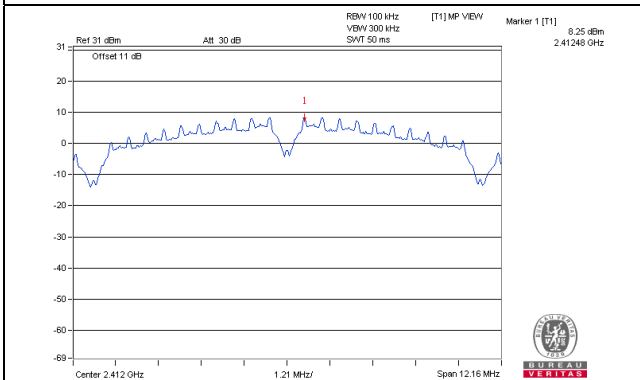

CH 6

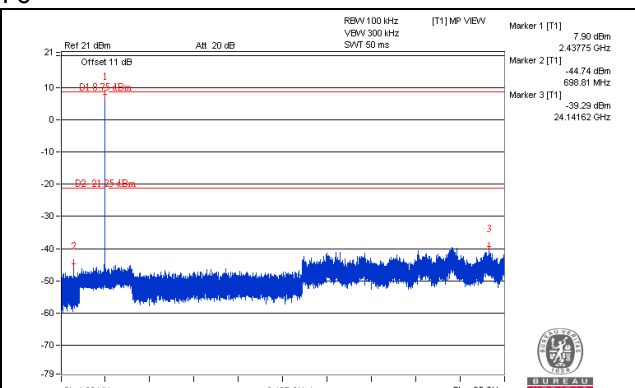
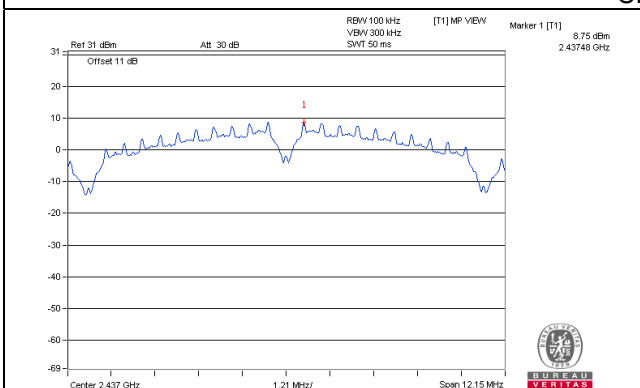

CH 11

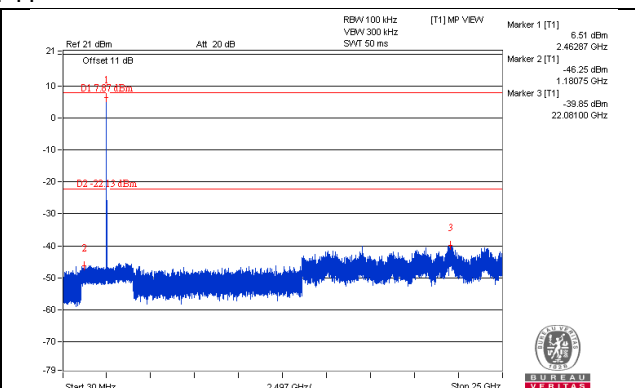
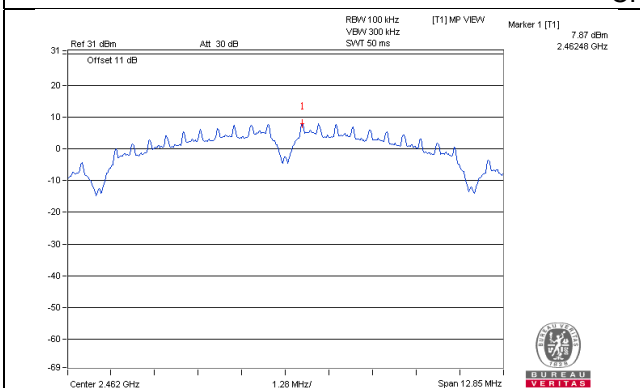

CH 1 Band edge

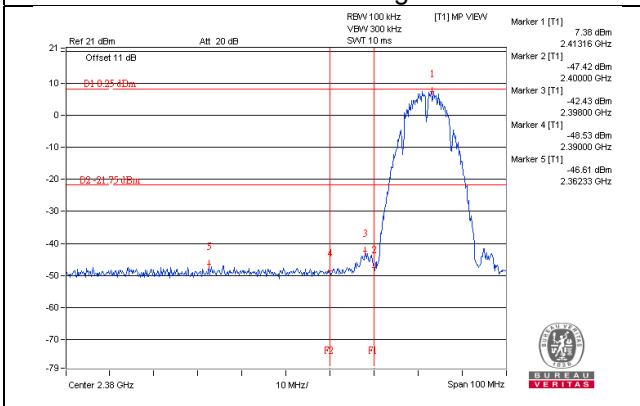

CH 11 Band edge

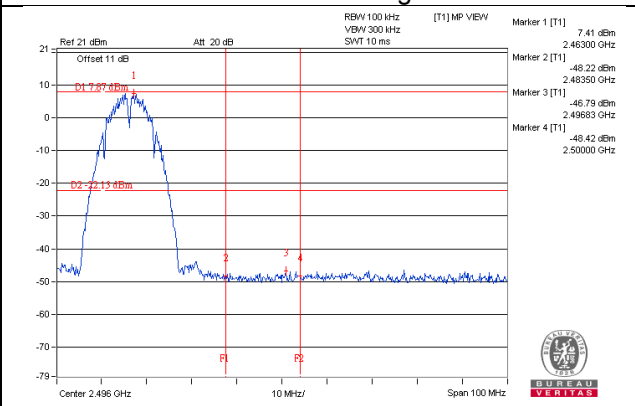

802.11b_Chain 1

CH 1

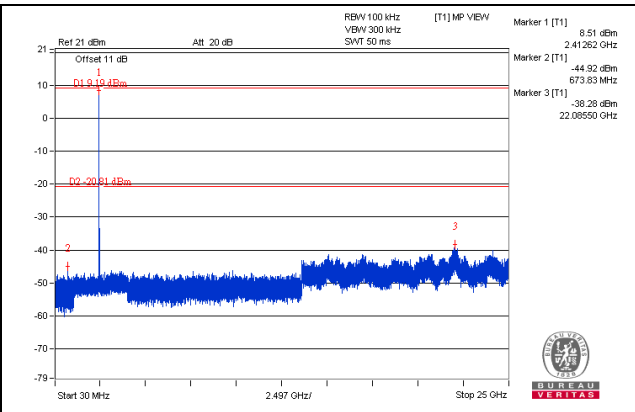
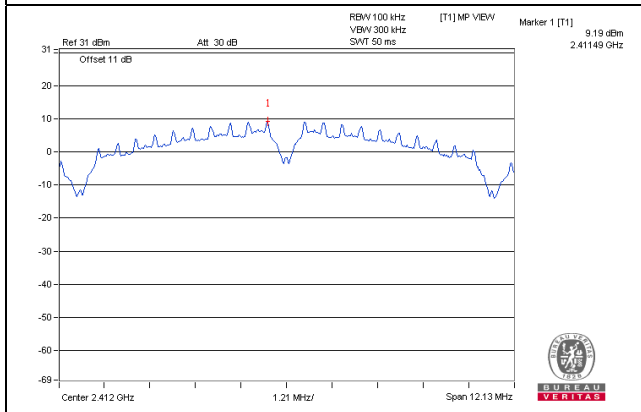

CH 6

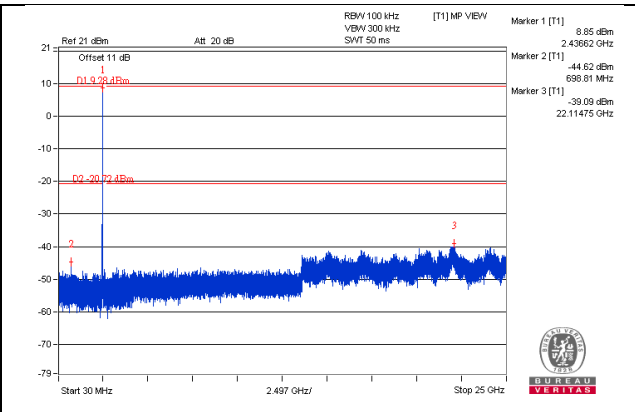
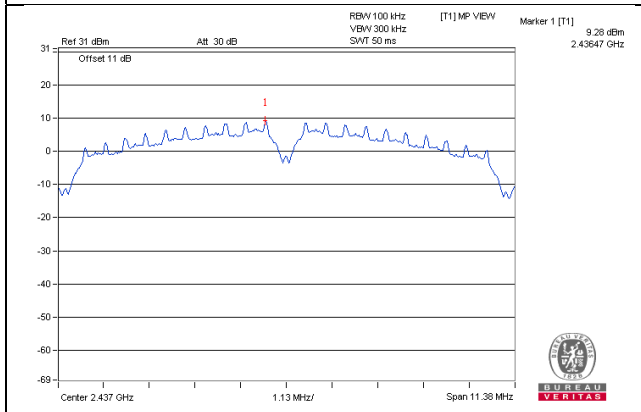

CH 11

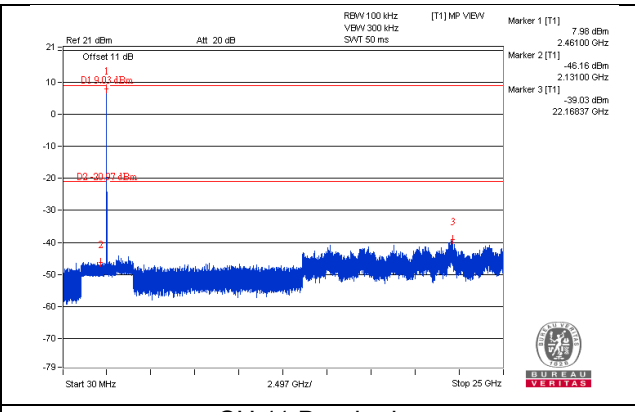
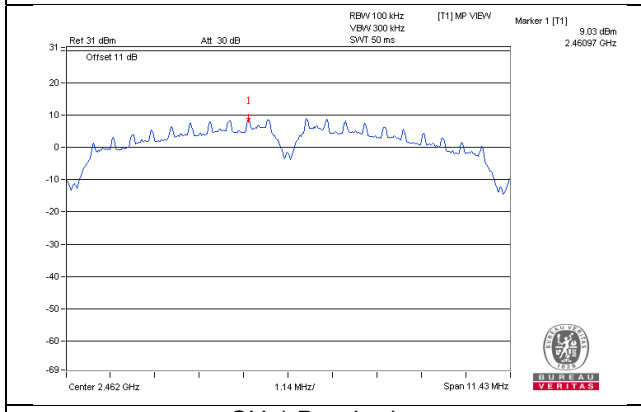

CH 1 Band edge

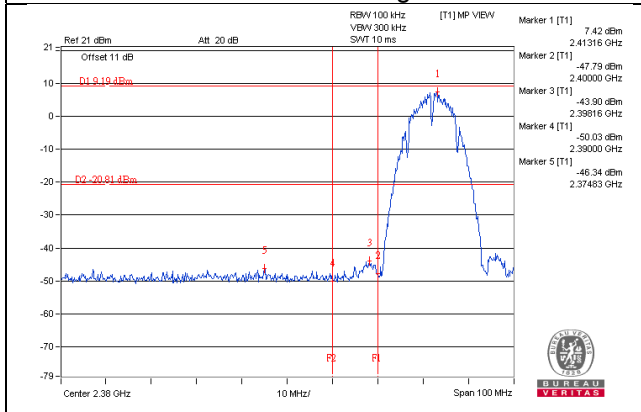

CH 11 Band edge

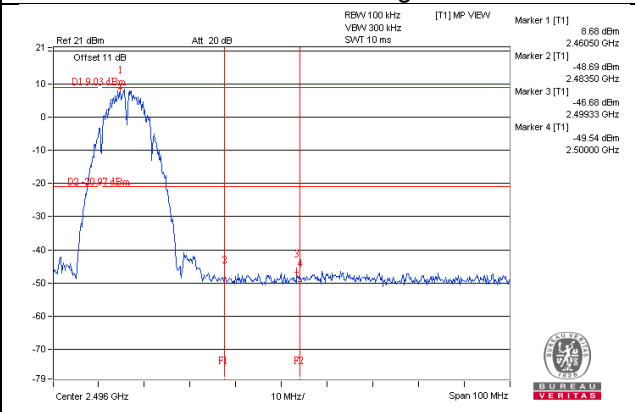

802.11b_Chain 2

CH 1

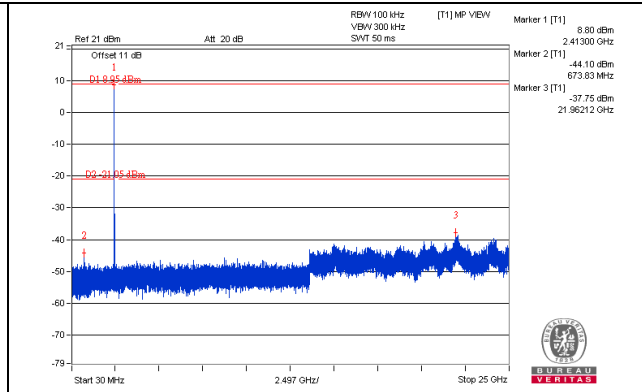
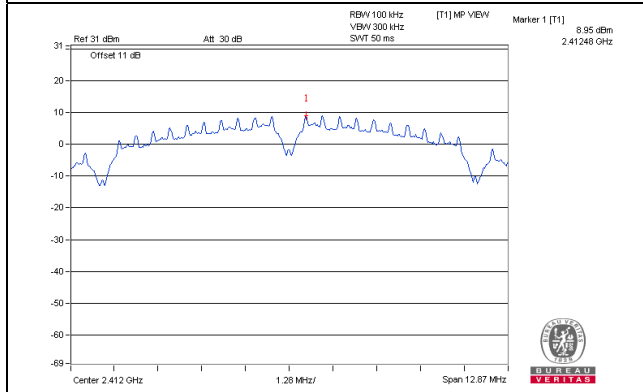

CH 6

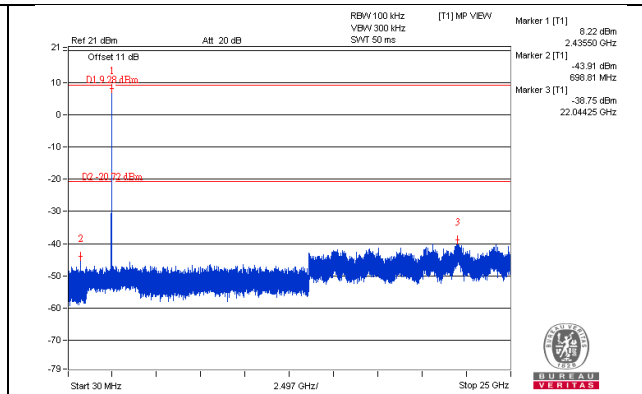
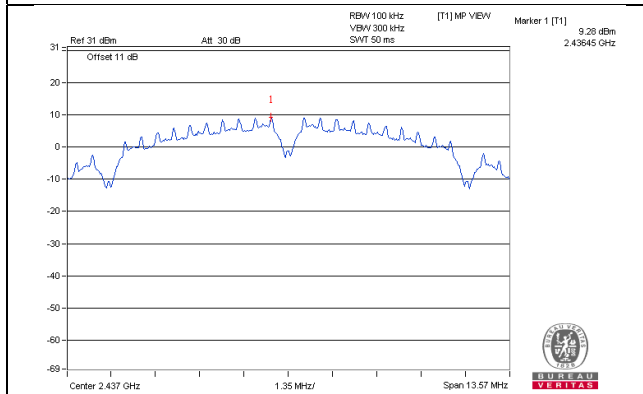

CH 11

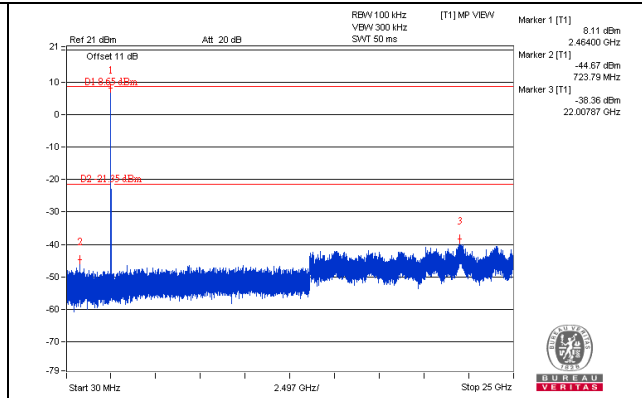
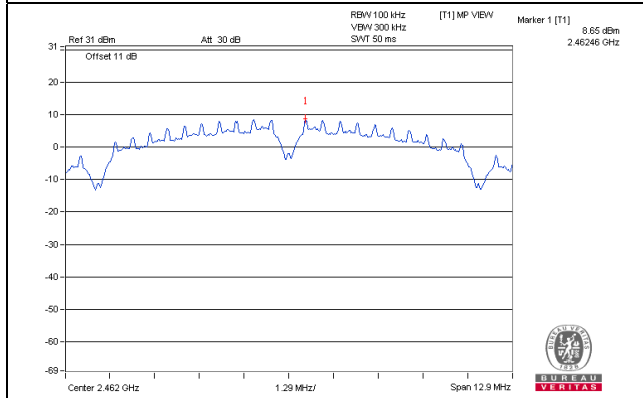

CH 1 Band edge

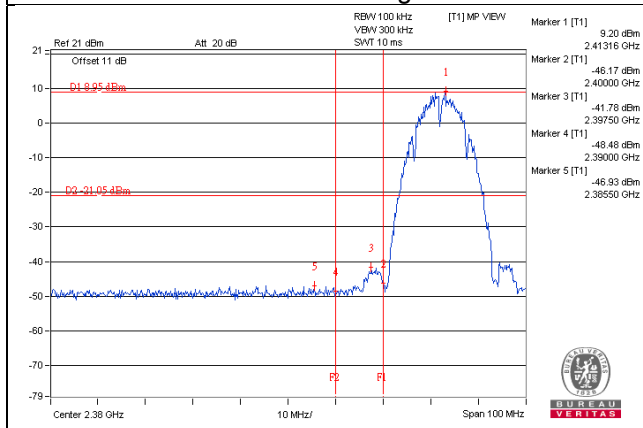

CH 11 Band edge

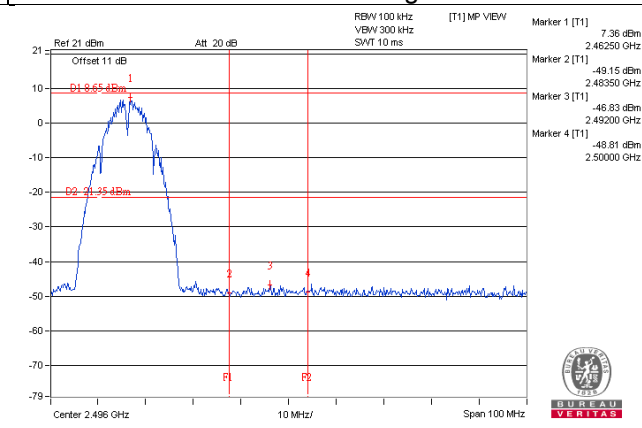

802.11b_Chain 3

CH 1

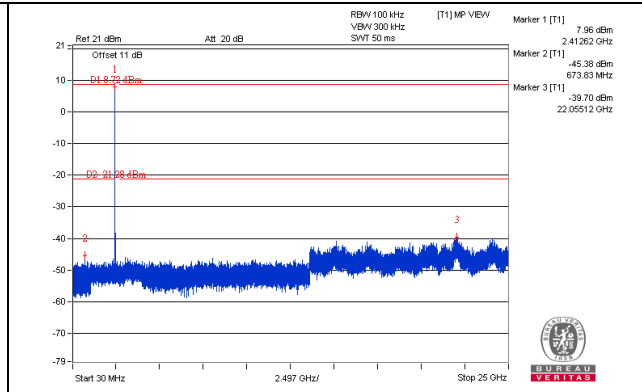
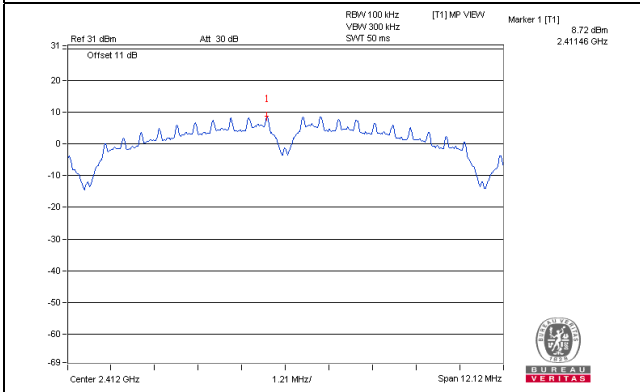

CH 6

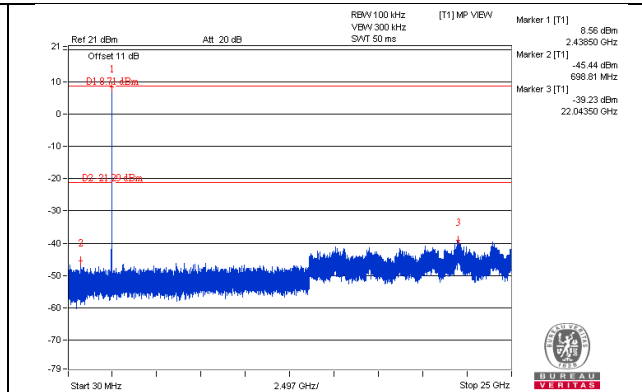
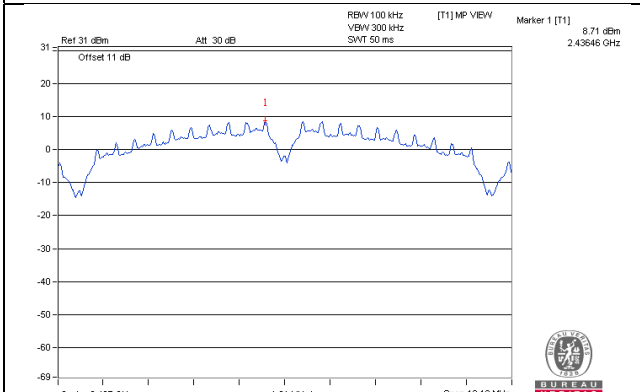

CH 11

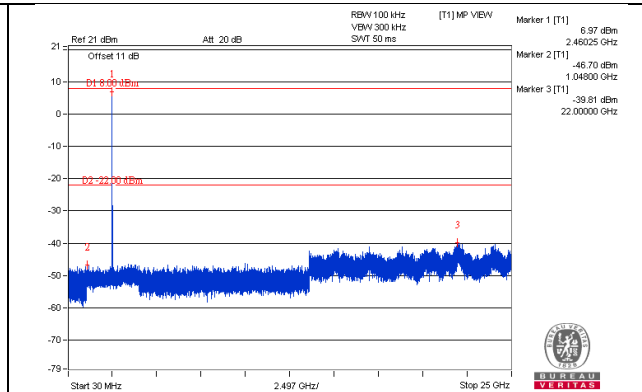
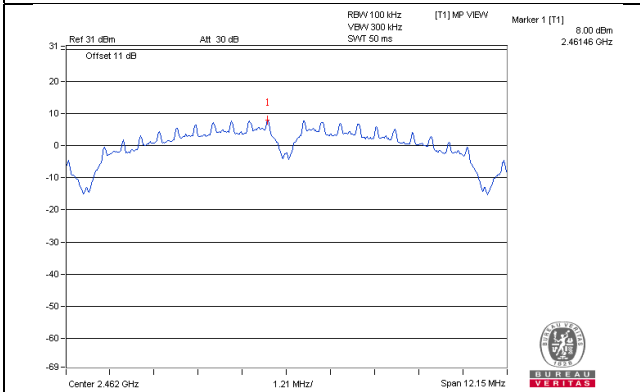

CH 1 Band edge

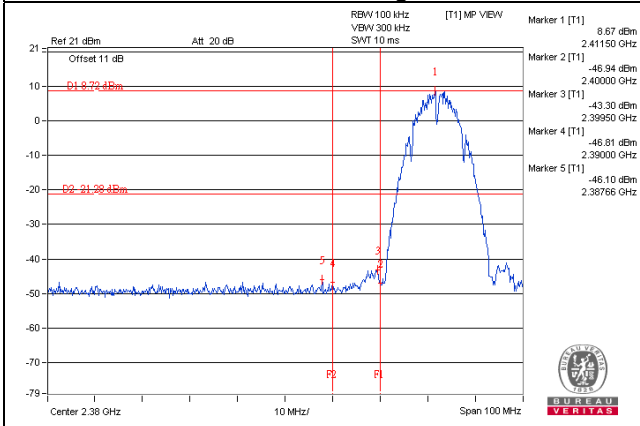

CH 11 Band edge

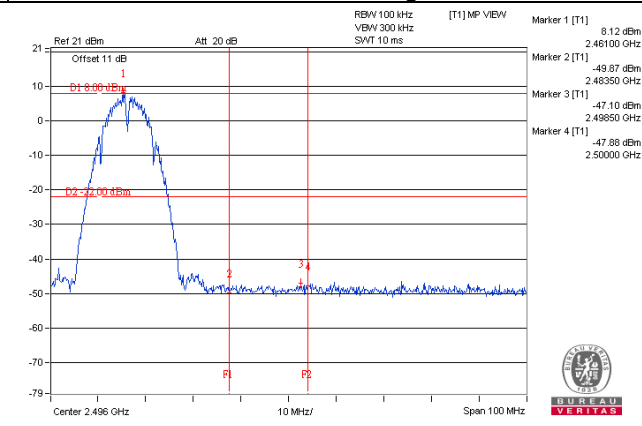

802.11g_Chain 0

CH 1

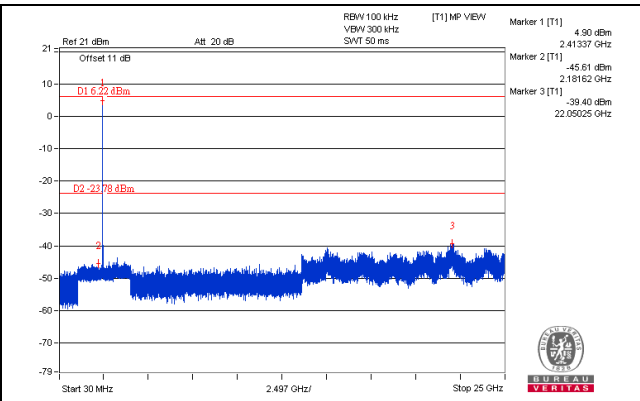
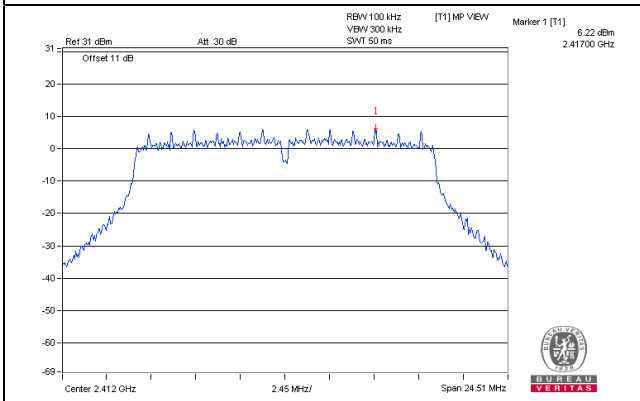

CH 6

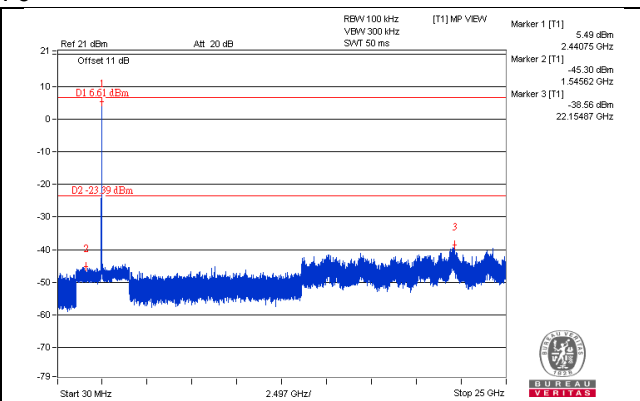
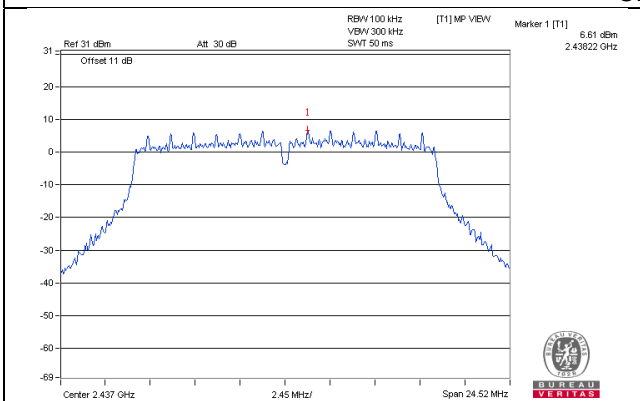

CH 11

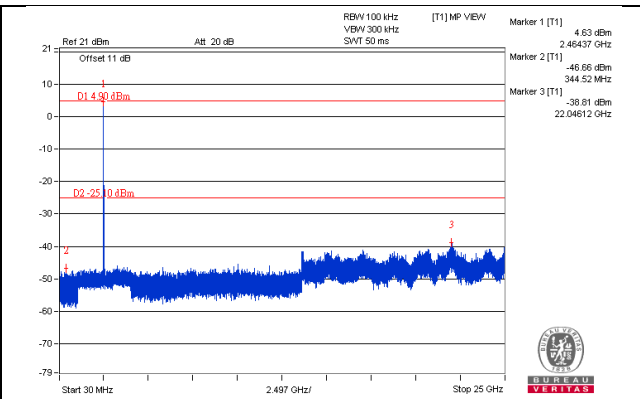
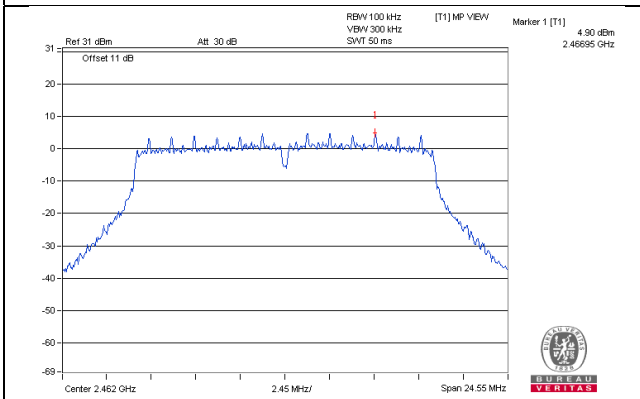

CH 1 Band edge

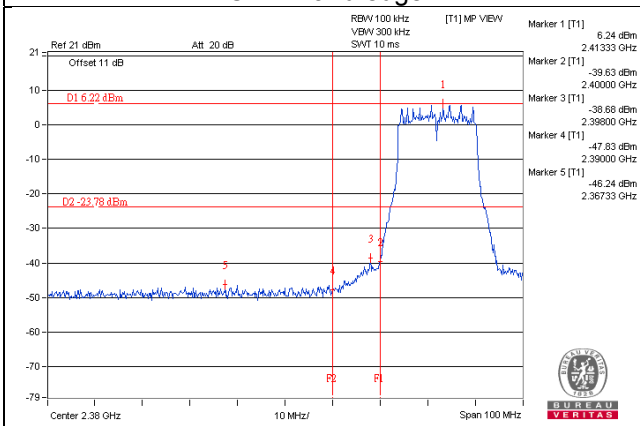

CH 11 Band edge

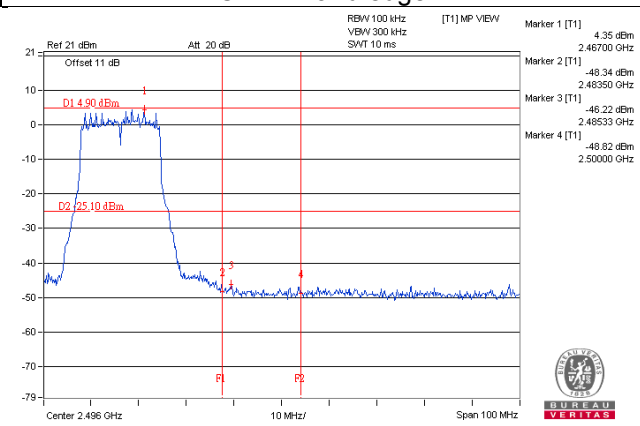

802.11g_Chain 1

CH 1

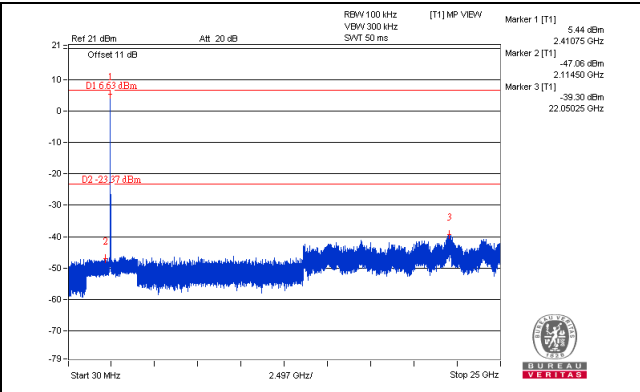
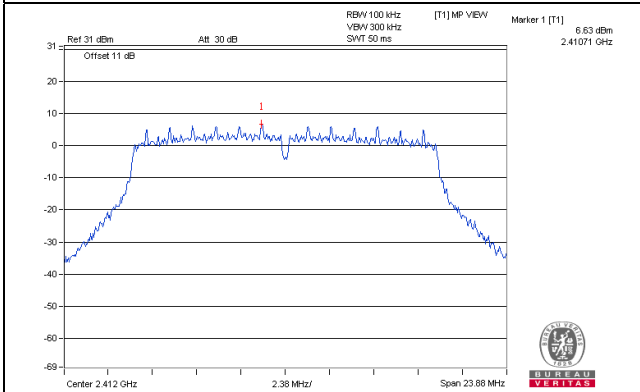

CH 6

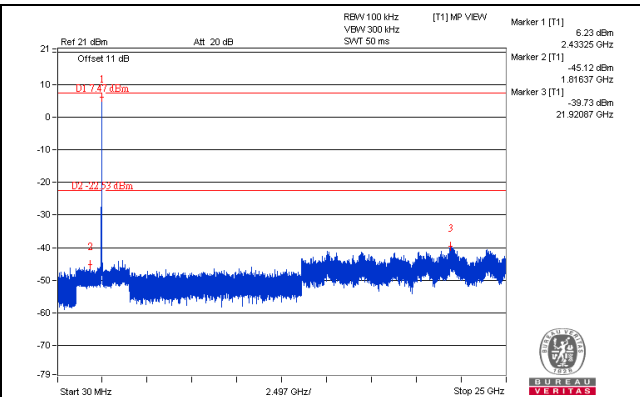
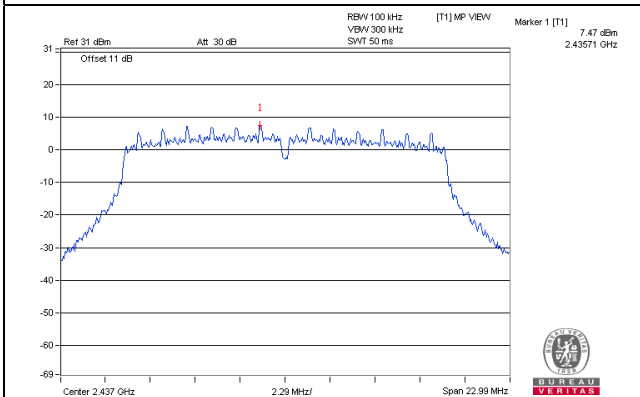

CH 11

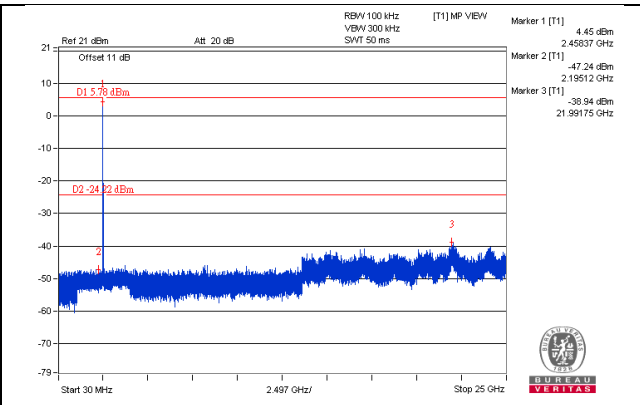
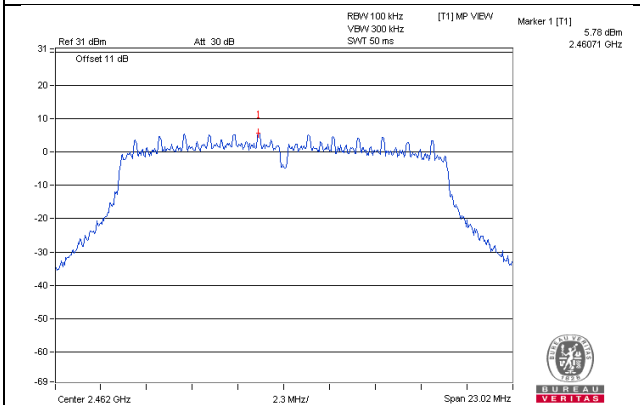

CH 1 Band edge

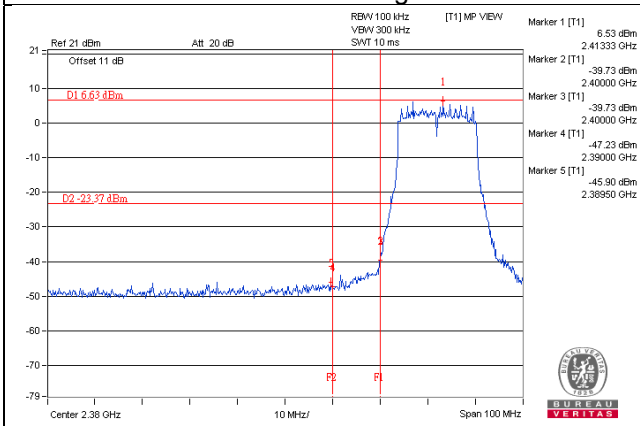

CH 11 Band edge

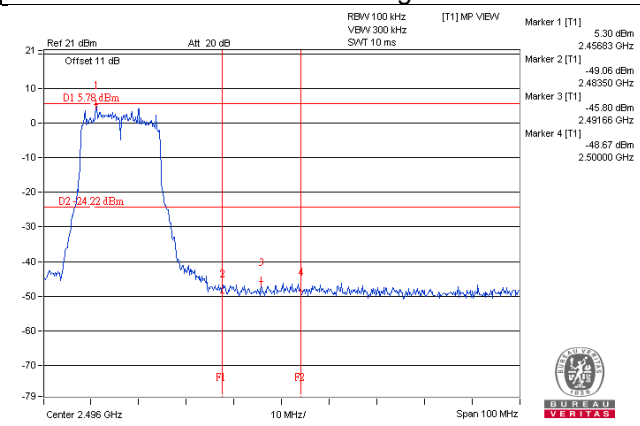

802.11g_Chain 2

CH 1

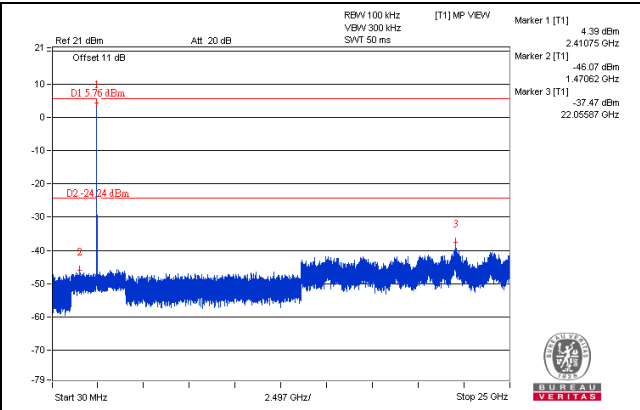
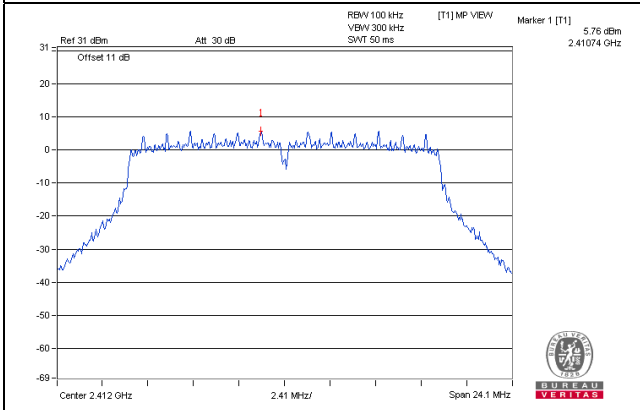

CH 6

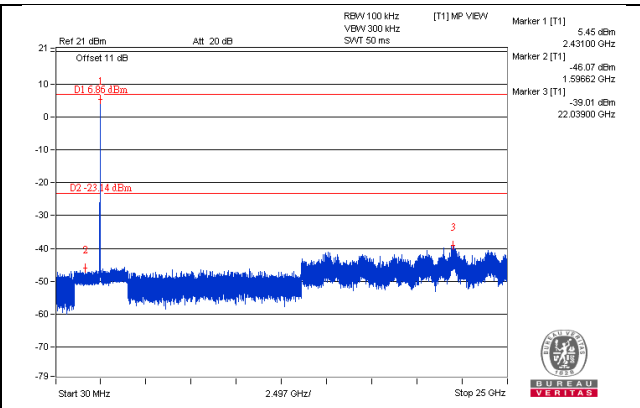
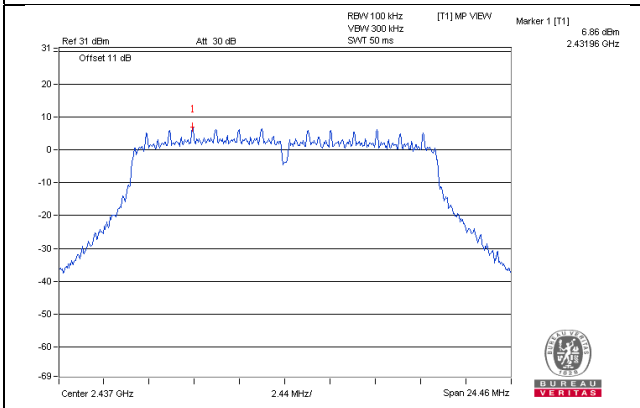

CH 11

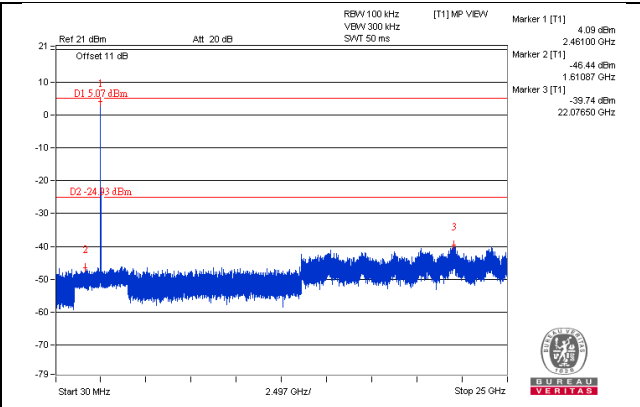
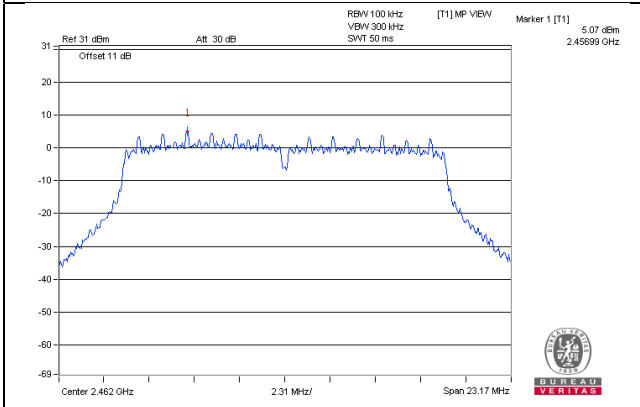

CH 1 Band edge

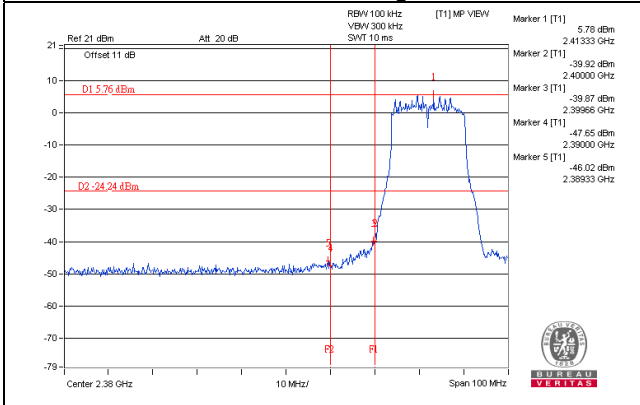

CH 11 Band edge

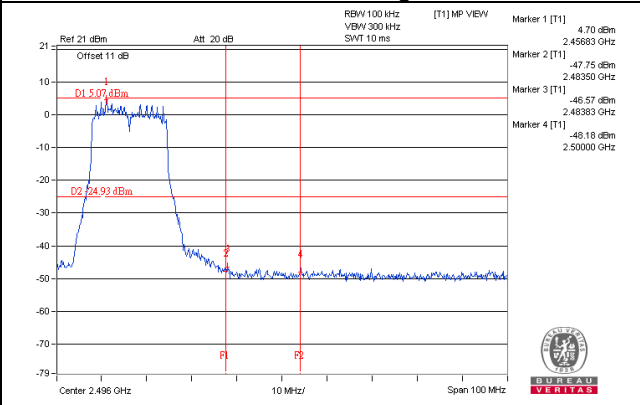

802.11g_Chain 3

CH 1

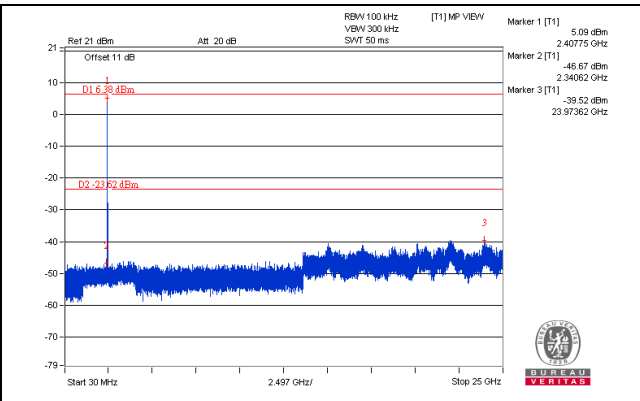
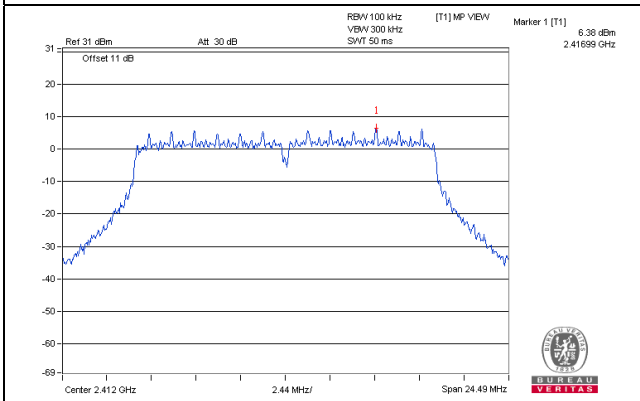

CH 6

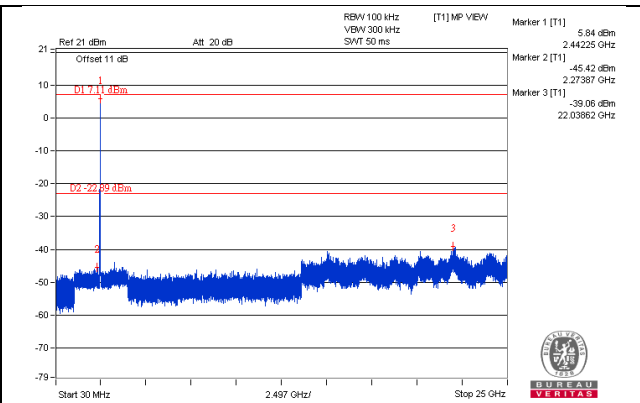
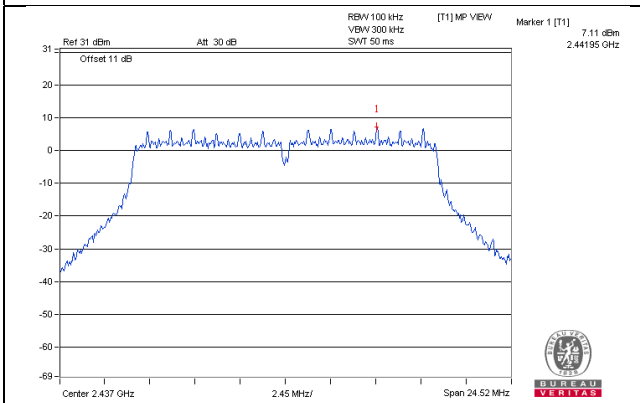

CH 11

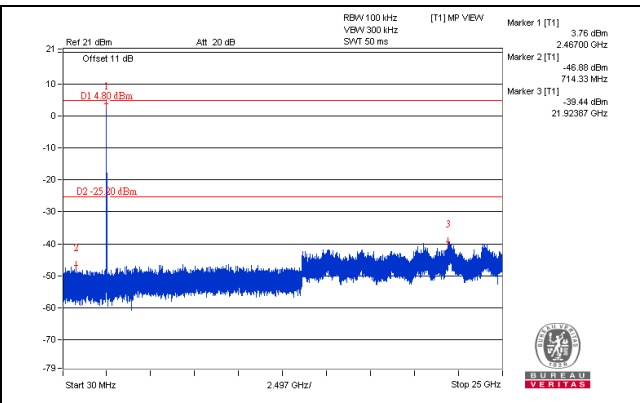
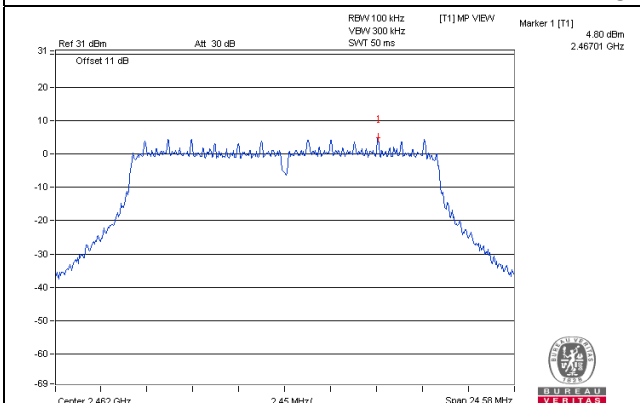

CH 1 Band edge

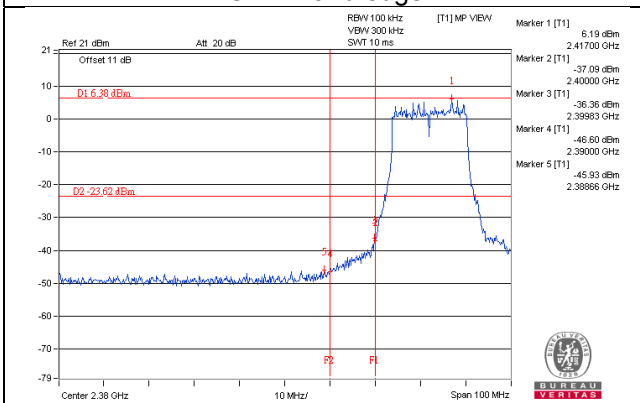

CH 11 Band edge

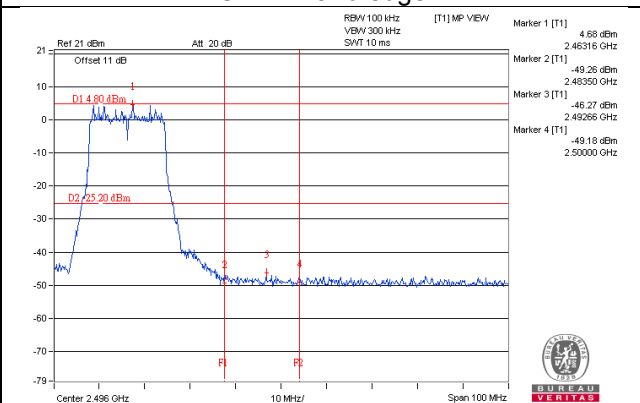

802.11n (HT20)_Chain 0

CH 1

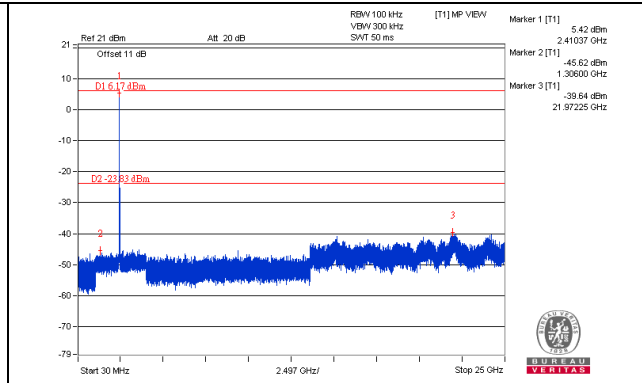
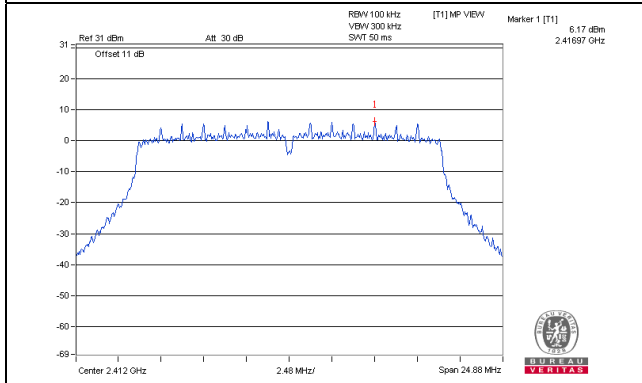

CH 6

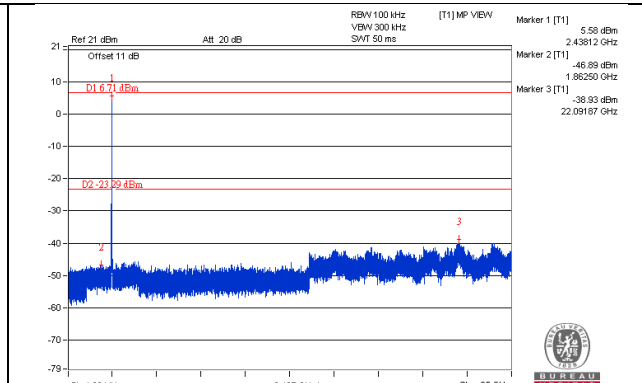
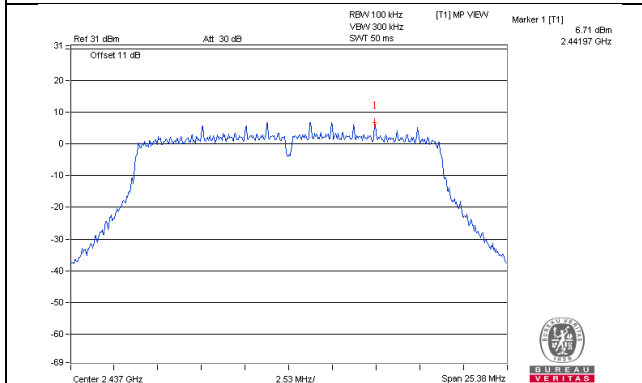

CH 11

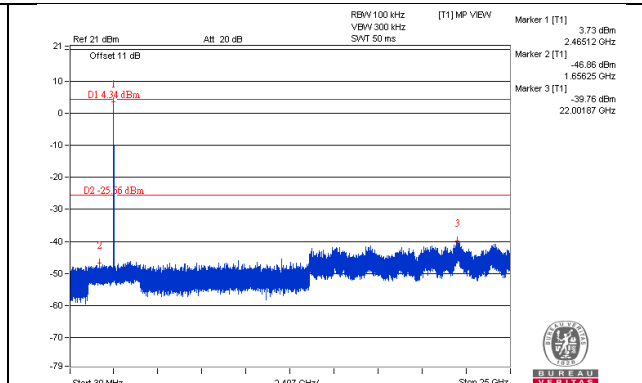
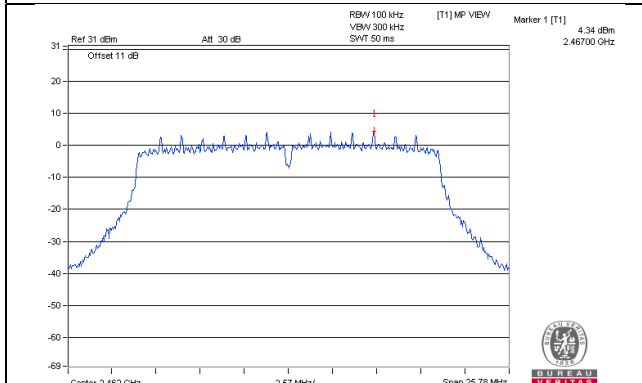

CH 1 Band edge

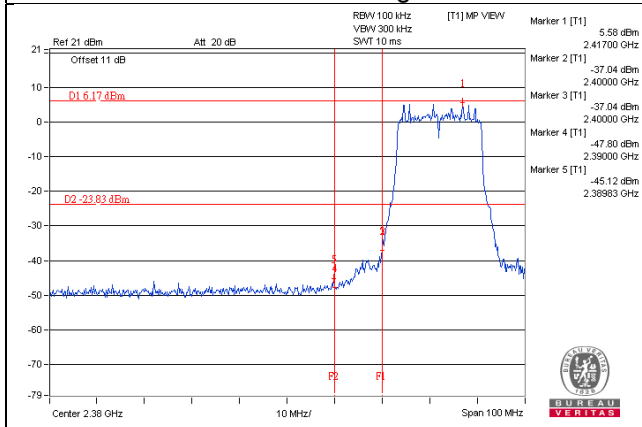

CH 11 Band edge

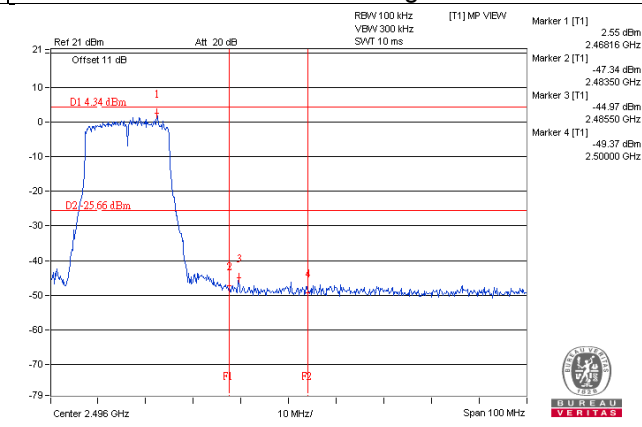

802.11n (HT20)_Chain 1

CH 1

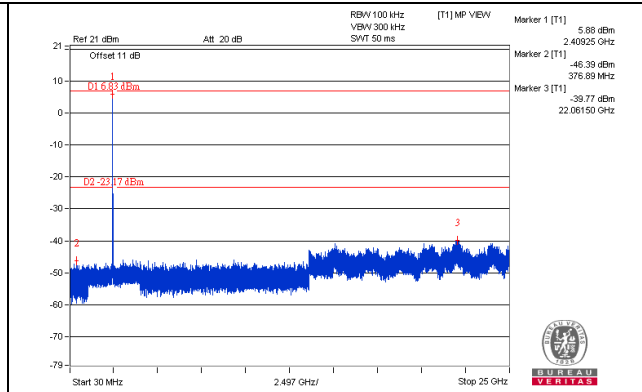
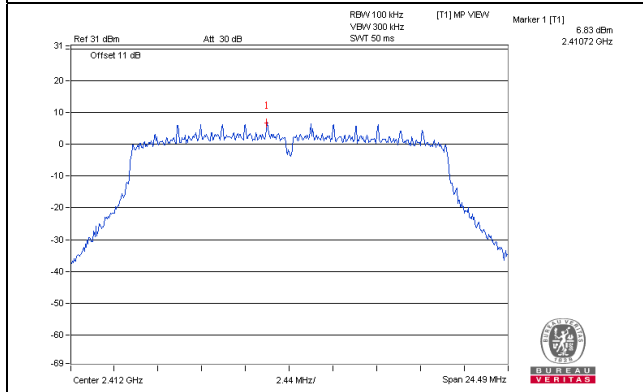

CH 6

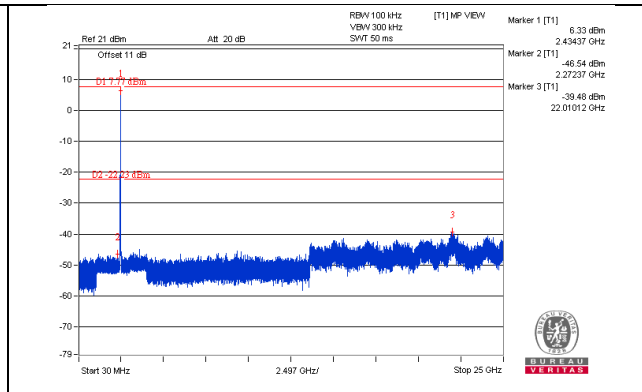
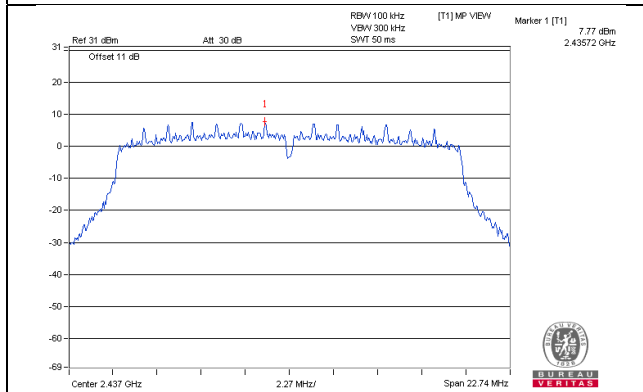

CH 11

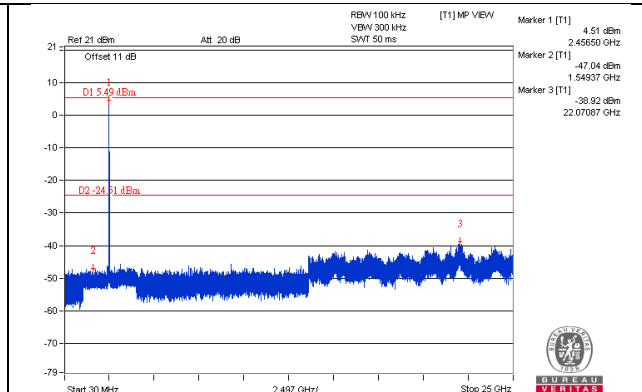
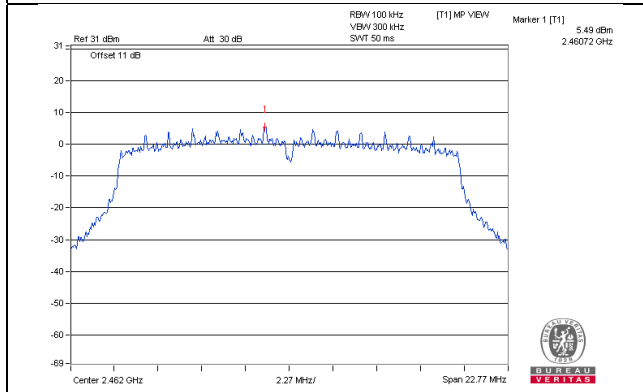

CH 1 Band edge

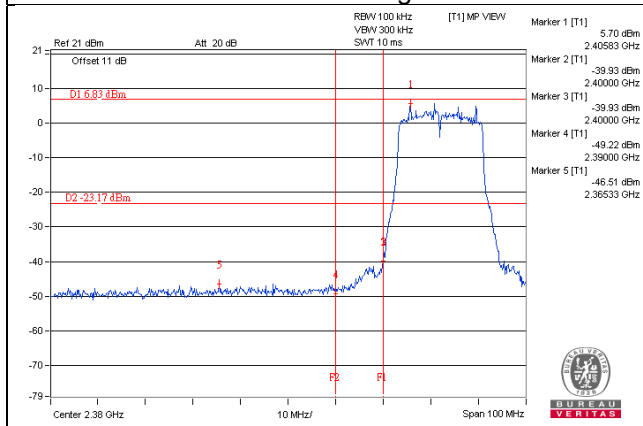

CH 11 Band edge

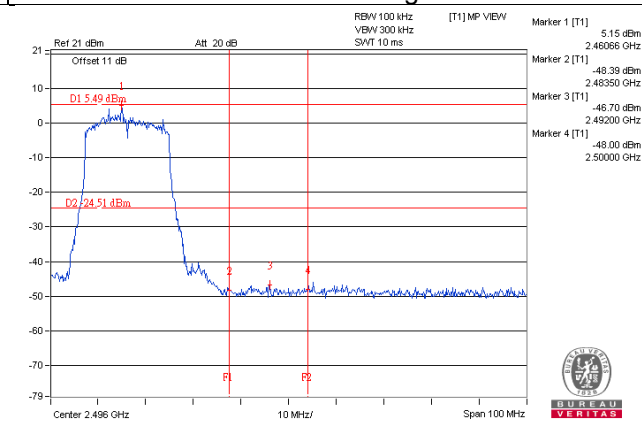

802.11n (HT20)_Chain 2

CH 1

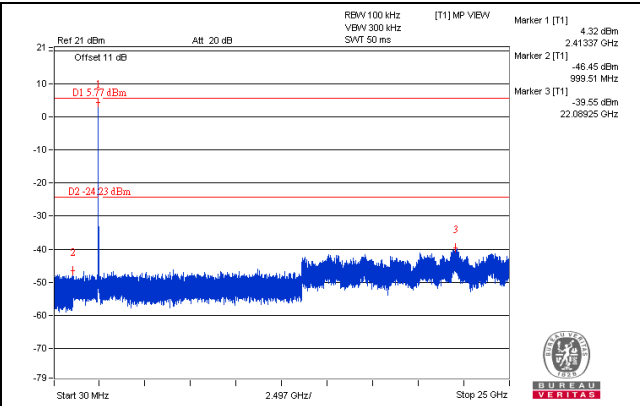
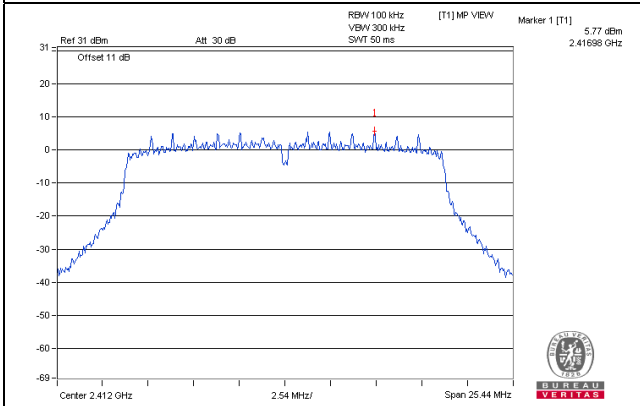

CH 6

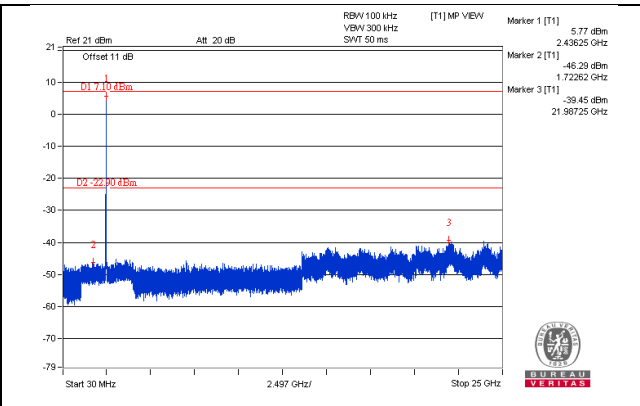
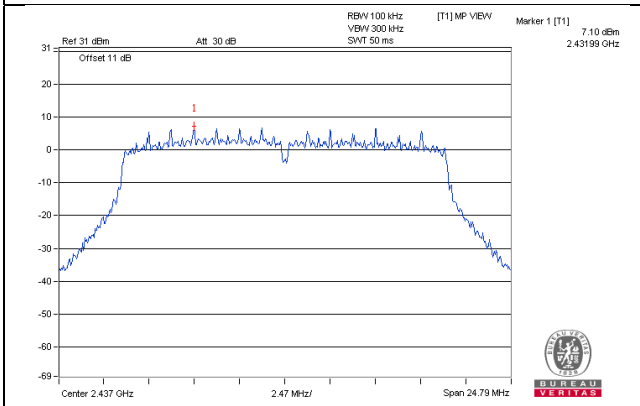

CH 11

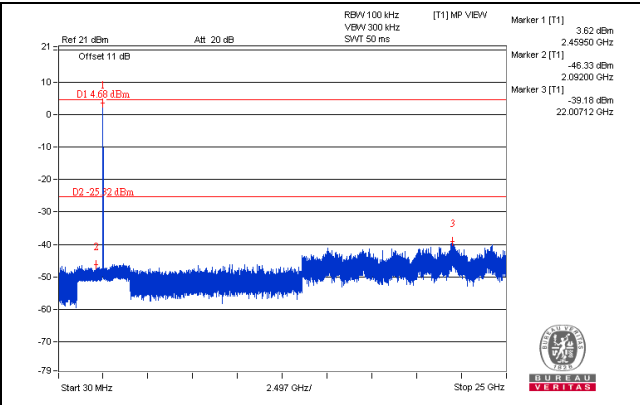
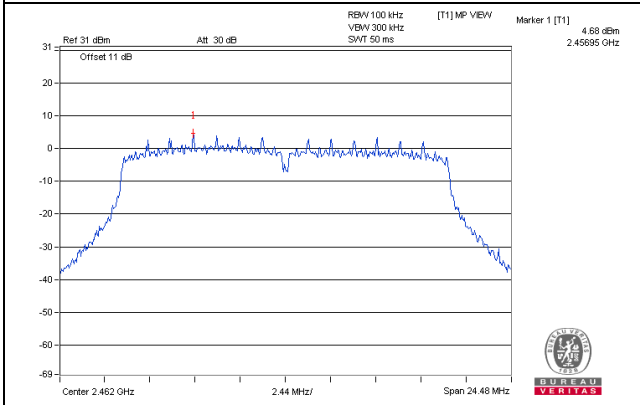

CH 1 Band edge

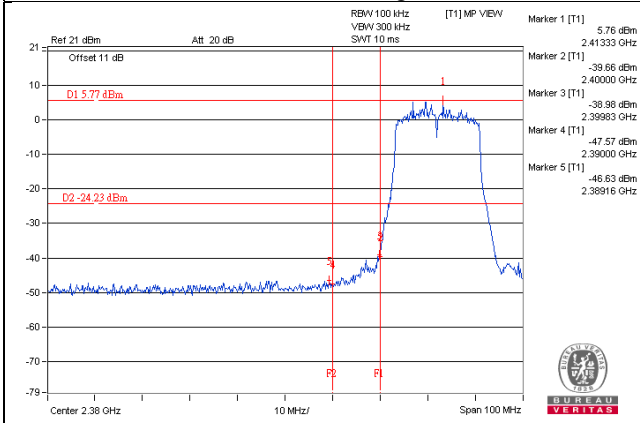

CH 11 Band edge

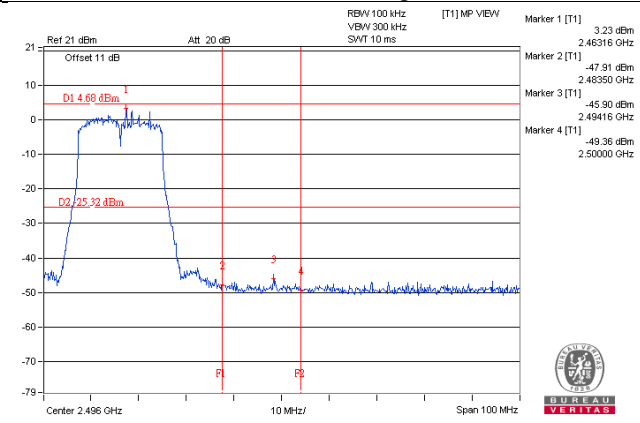

802.11n (HT20)_Chain 3

CH 1

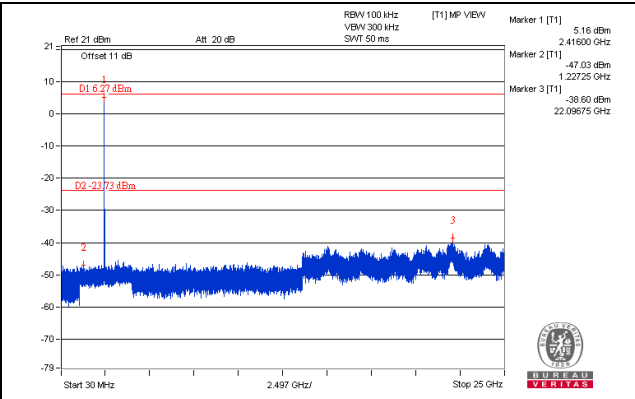
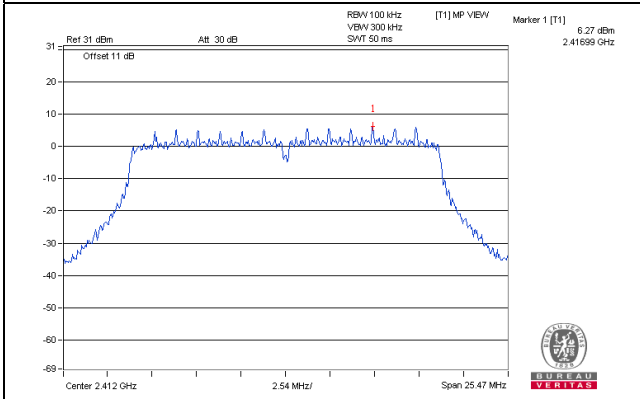

CH 6

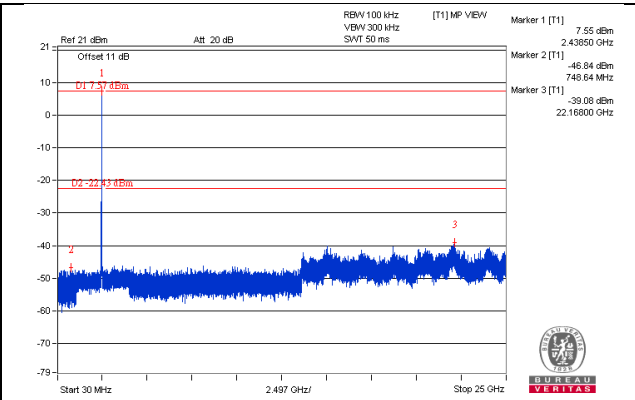
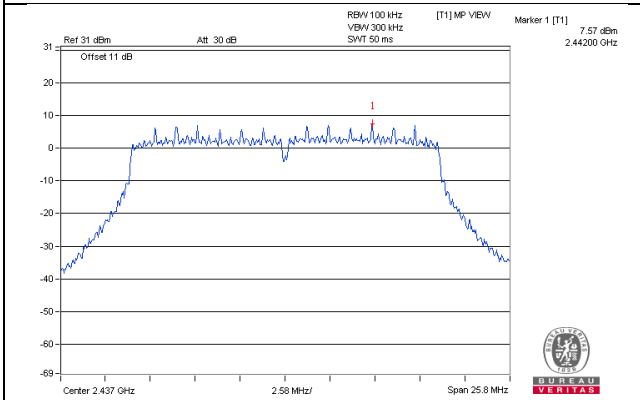

CH 11

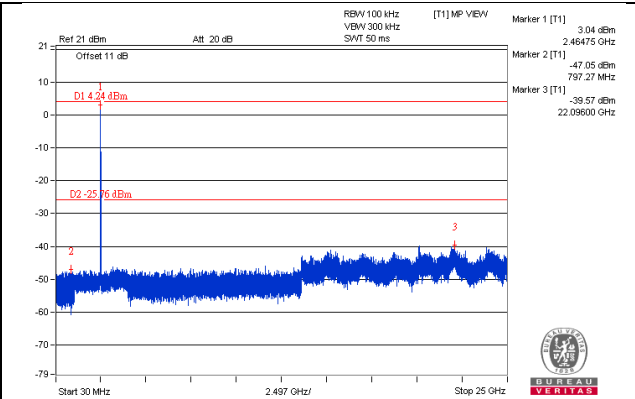
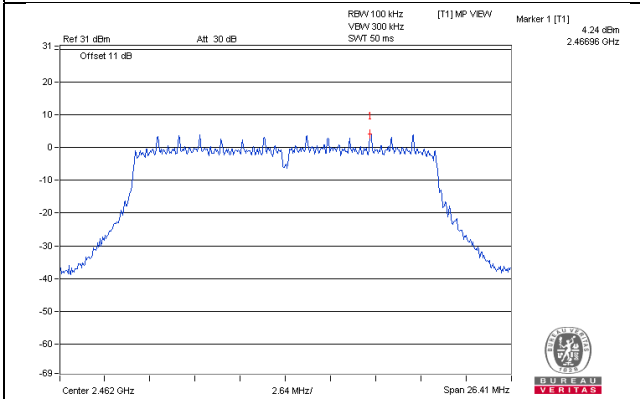

CH 1 Band edge

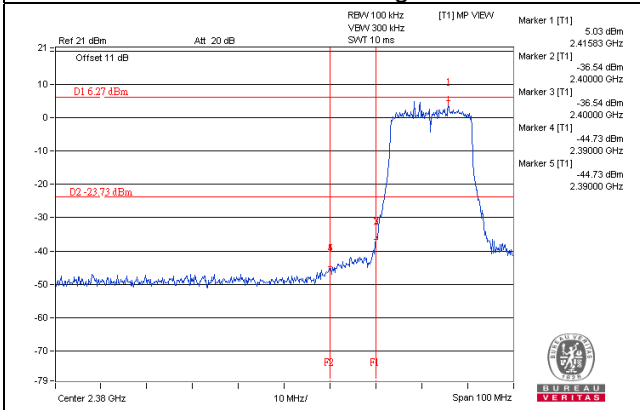

CH 11 Band edge

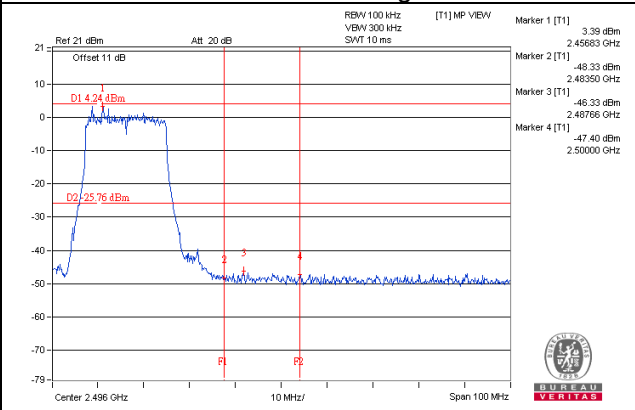

802.11n (HT40)_Chain 0

CH 3

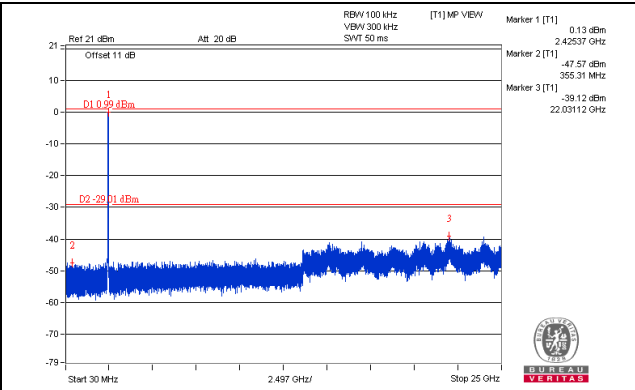
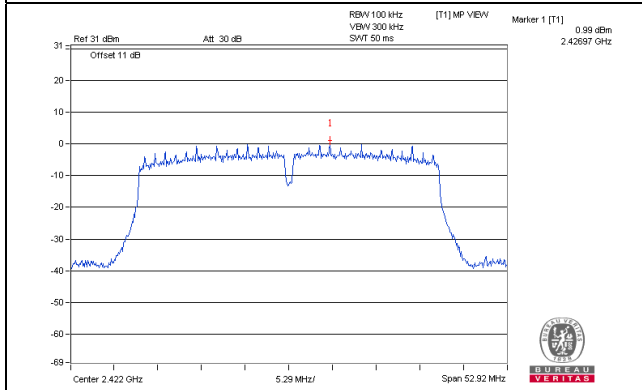

CH 6

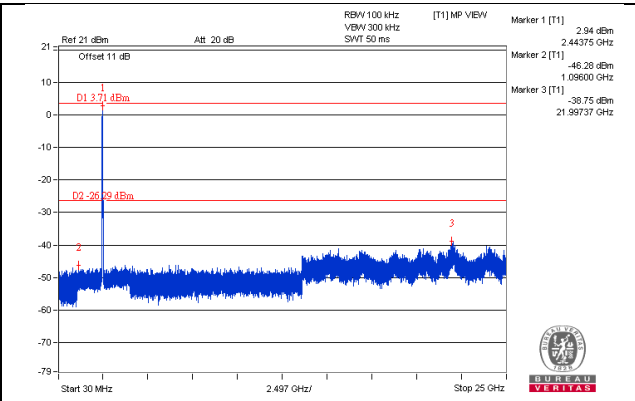
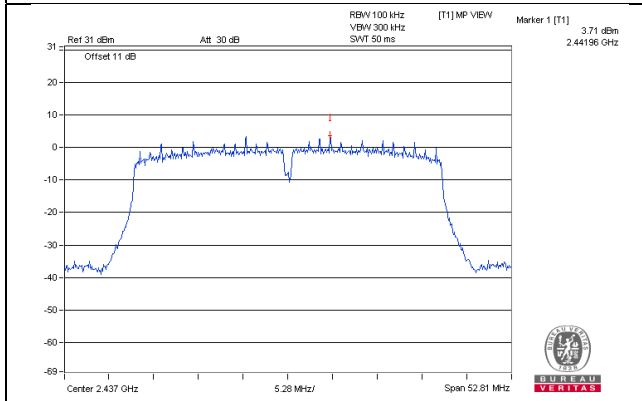

CH 9

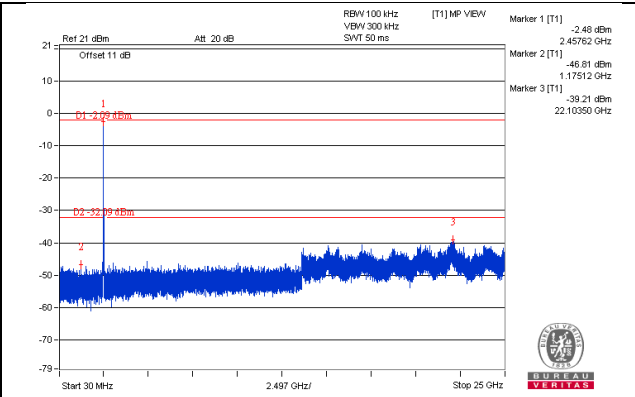
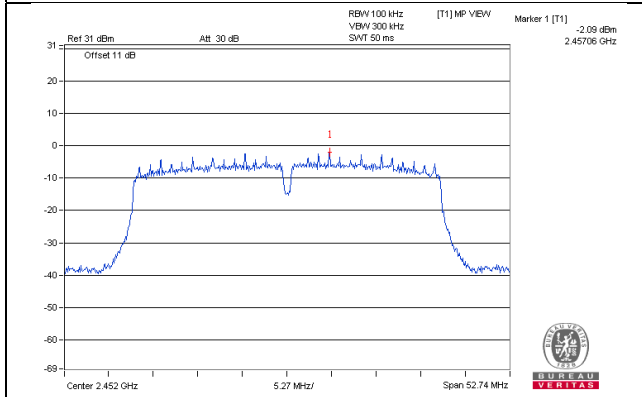

CH 3 Band edge

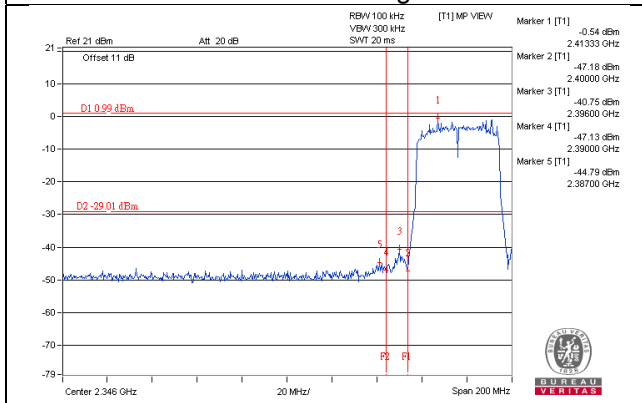

CH 9 Band edge

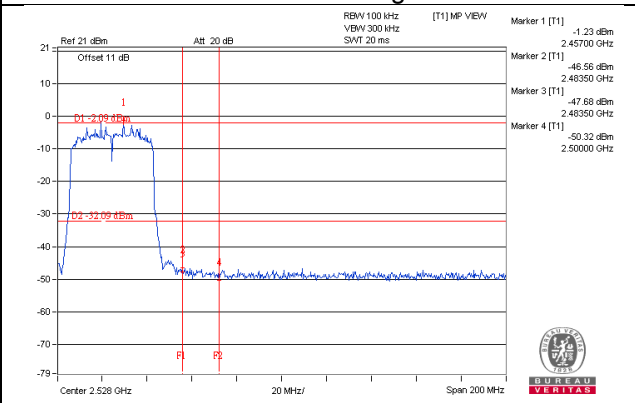

802.11n (HT40)_Chain 1

CH 3

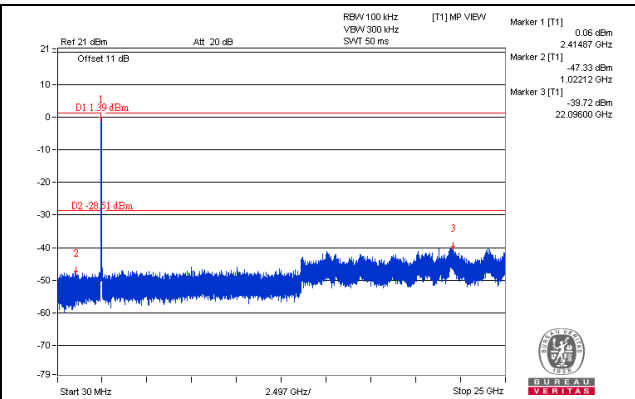
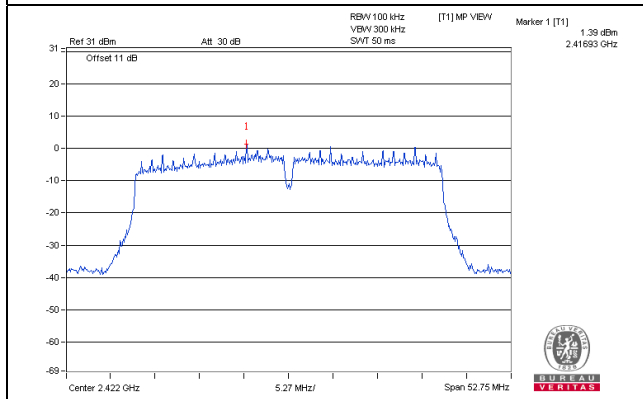

CH 6

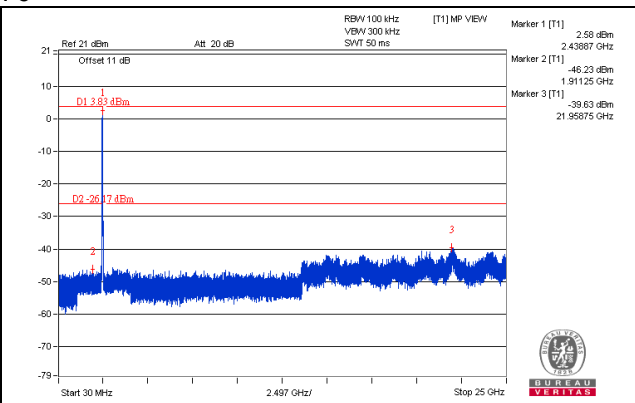
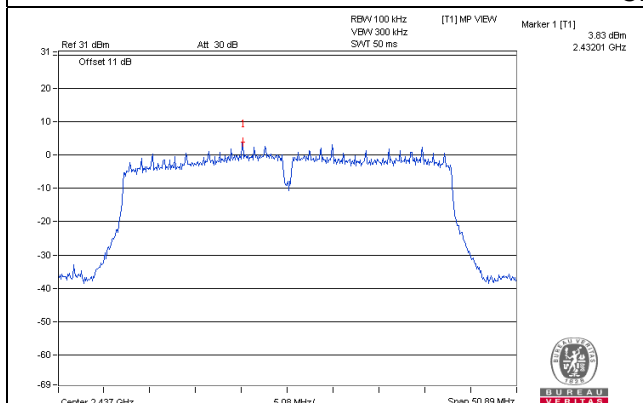

CH 9

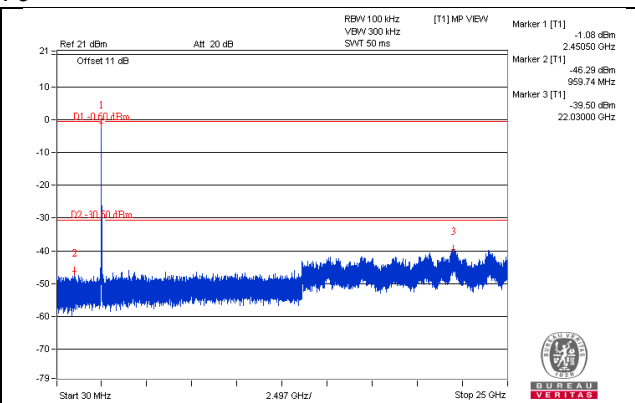
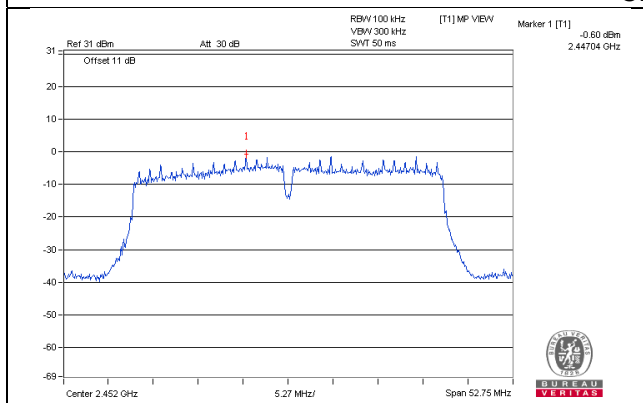

CH 3 Band edge

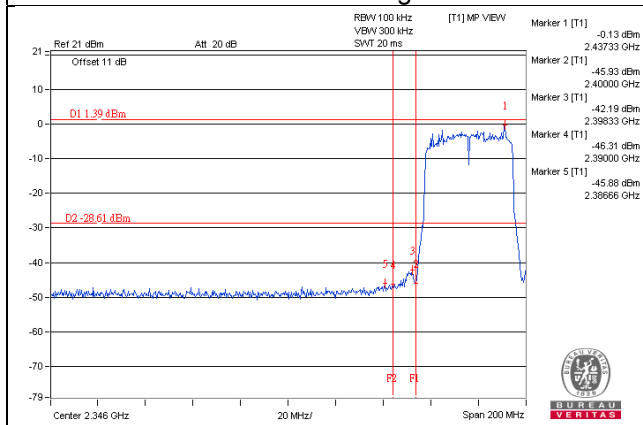

CH 9 Band edge

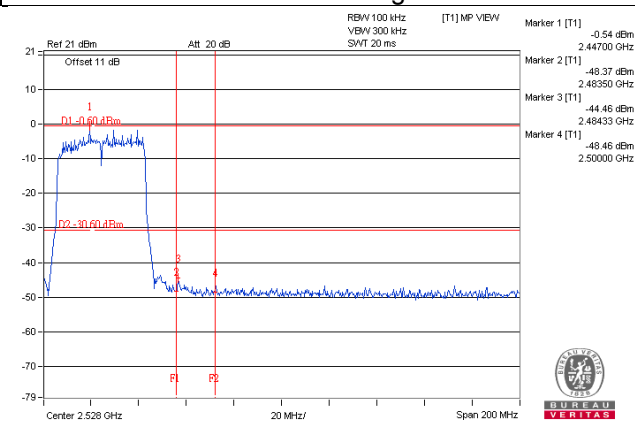

802.11n (HT40)_Chain 2

CH 3

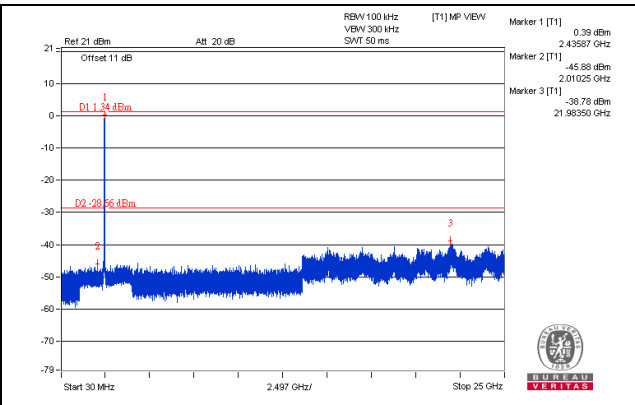
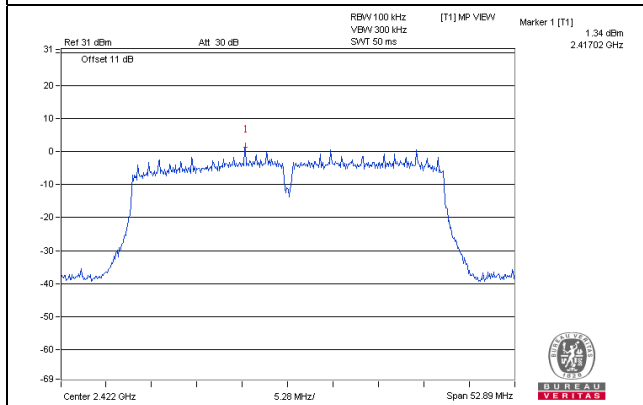

CH 6

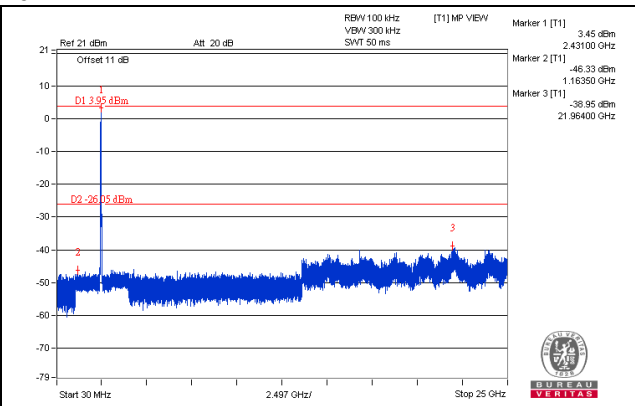
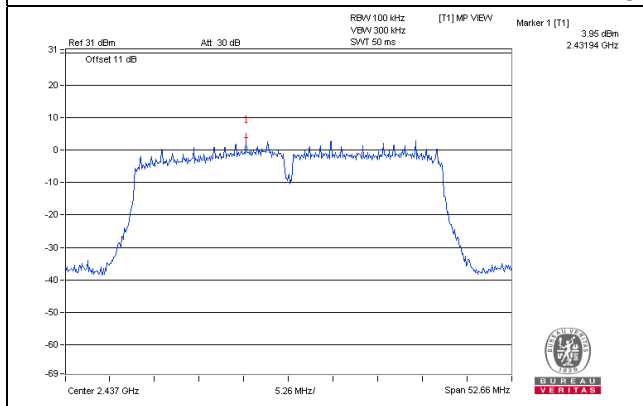

CH 9

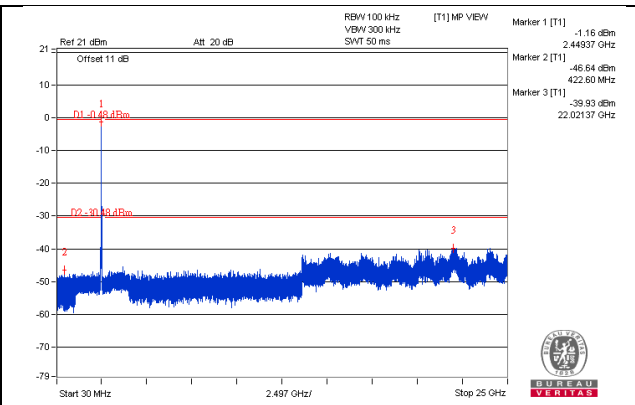
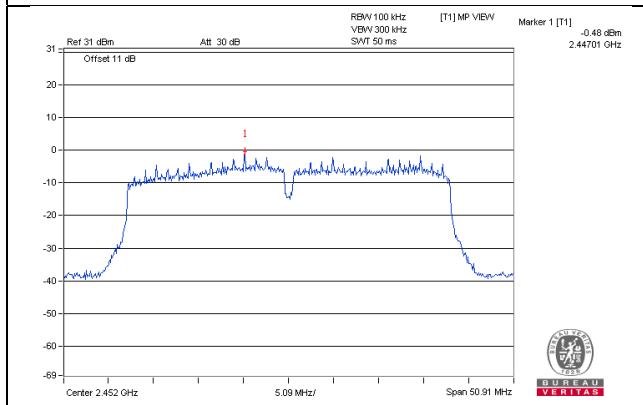

CH 3 Band edge

CH 9 Band edge

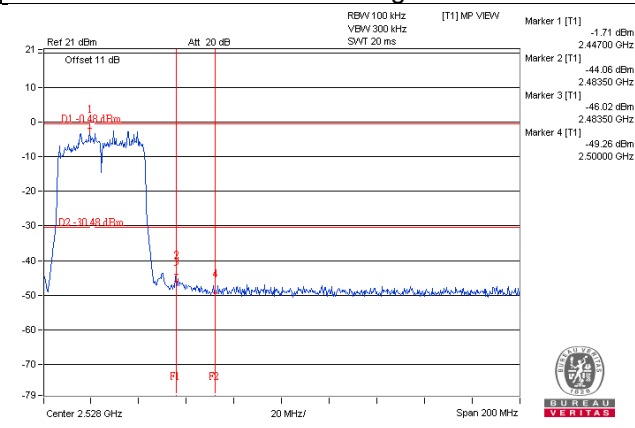
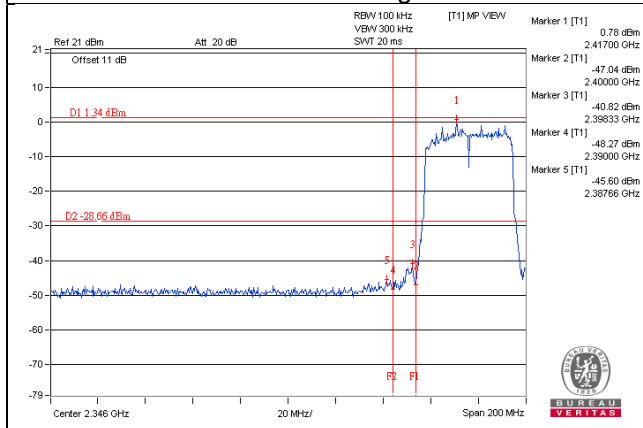

802.11n (HT40)_Chain 3

CH 3

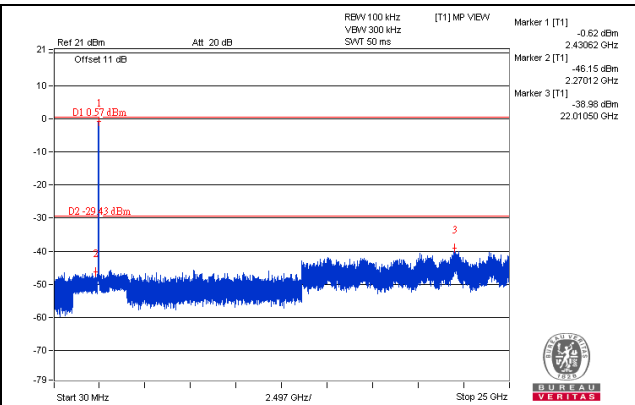
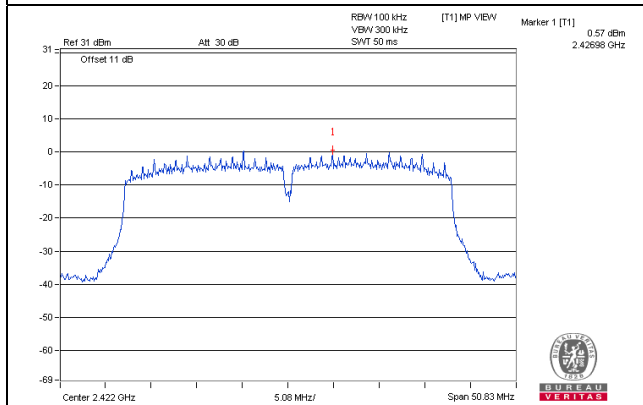

CH 6

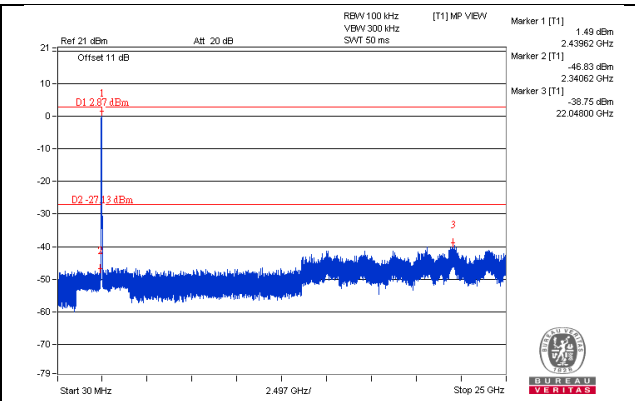
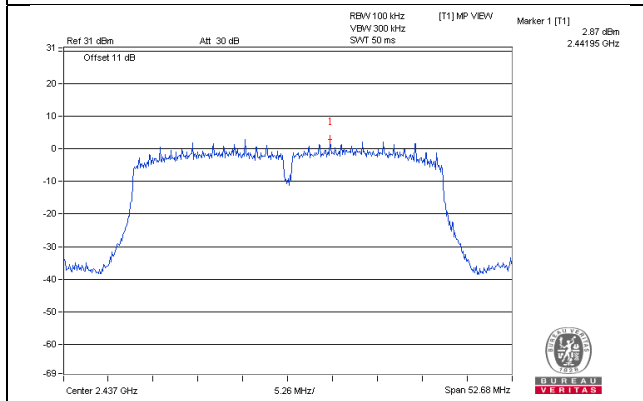

CH 9

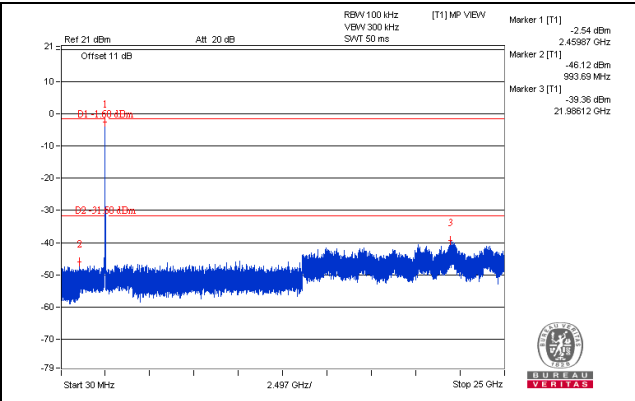
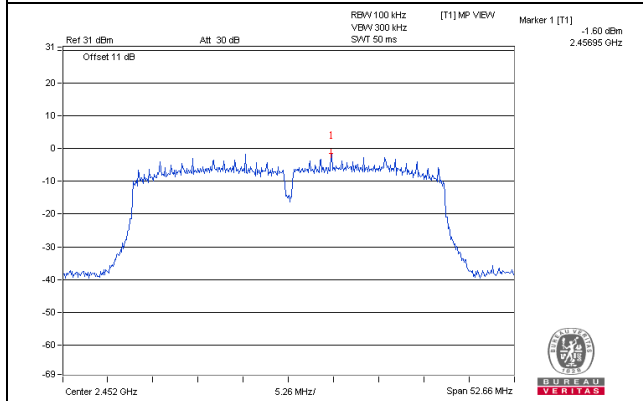

CH 3 Band edge

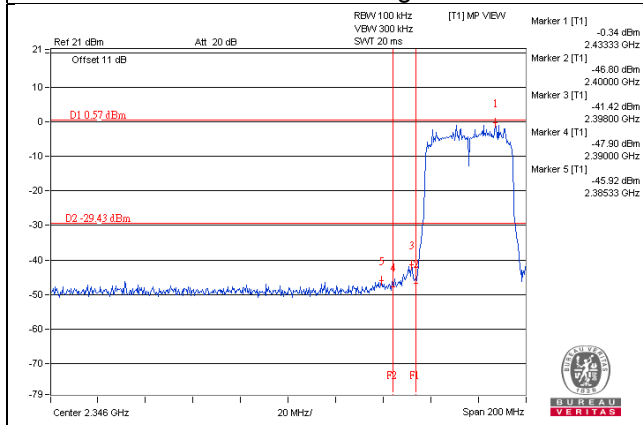

CH 9 Band edge

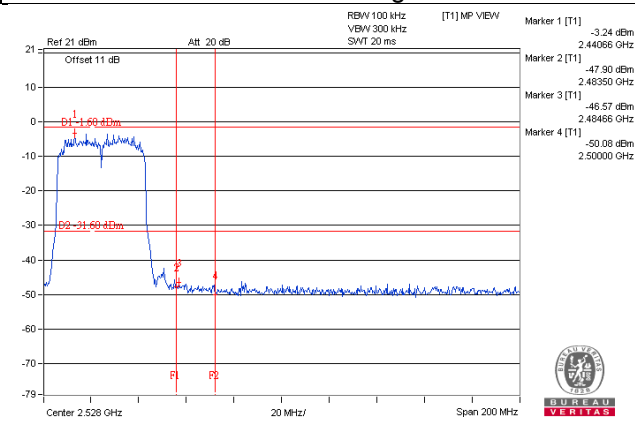

Test Mode C
802.11b_Chain 0

CH 1

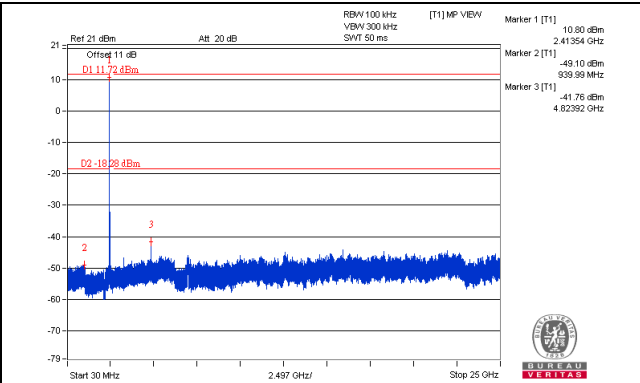
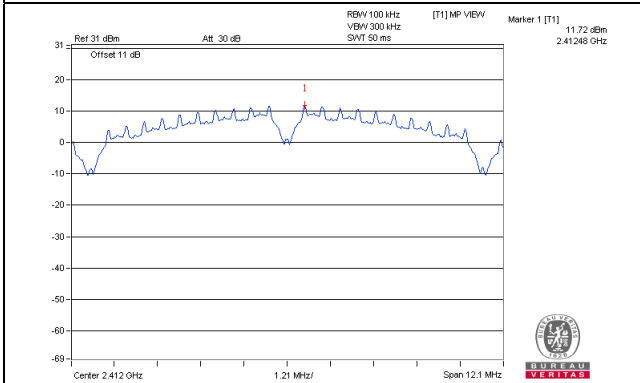

CH 6

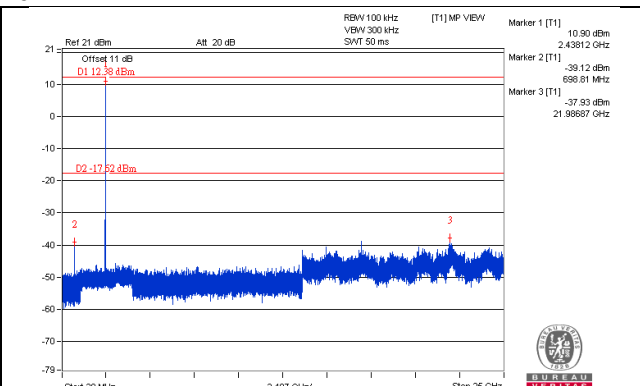
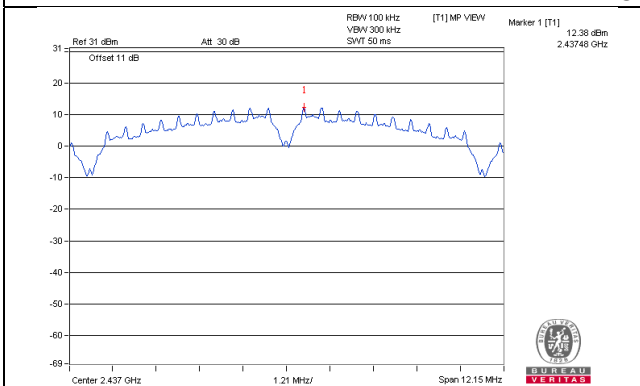

CH 11

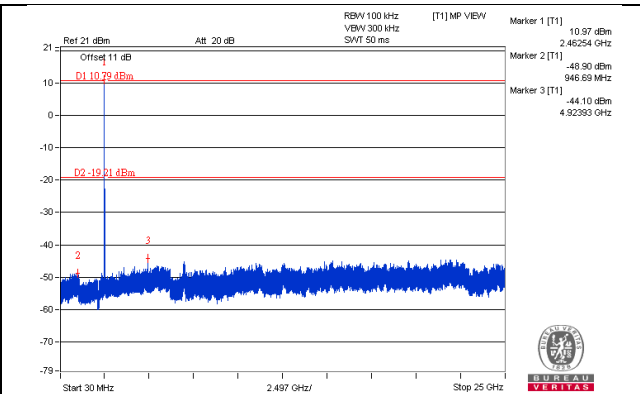
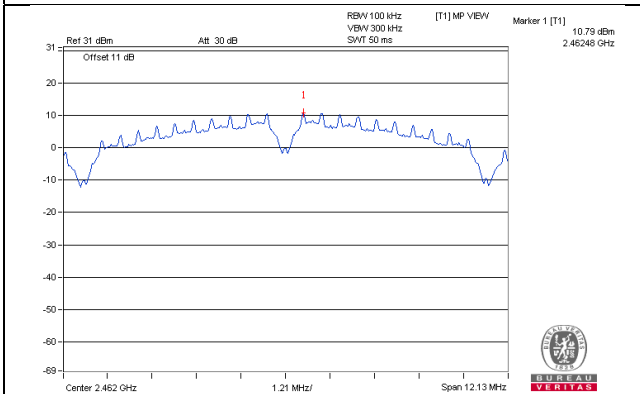

CH 1 Band edge

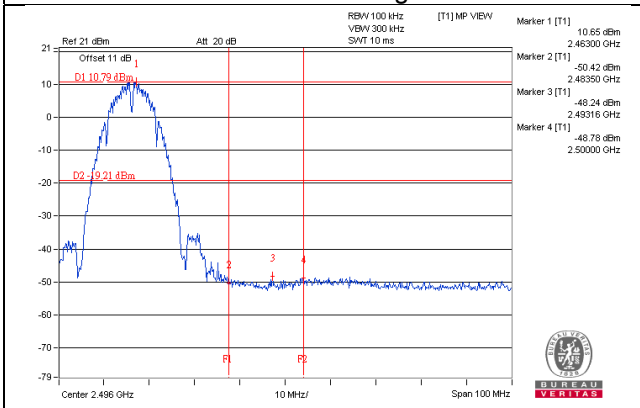

CH 11 Band edge

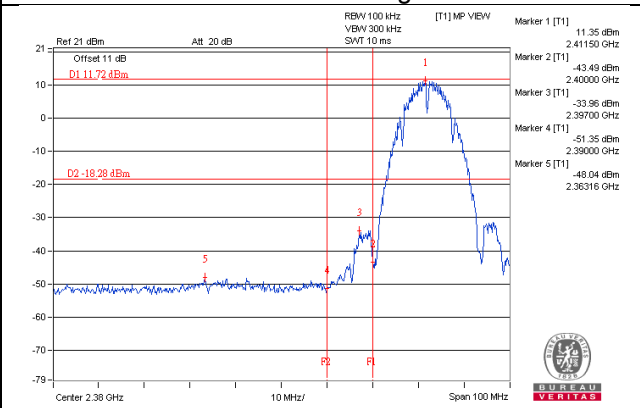

802.11b_Chain 1

CH 1

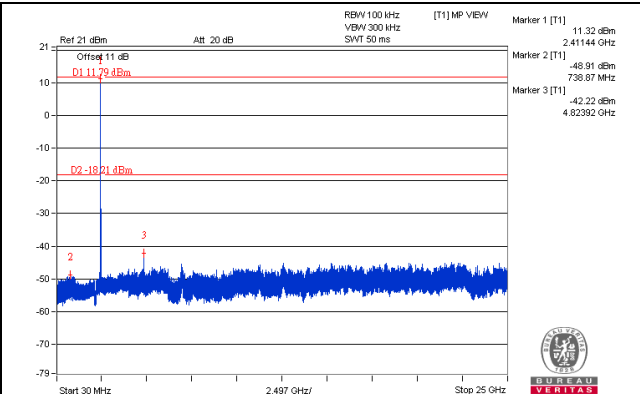
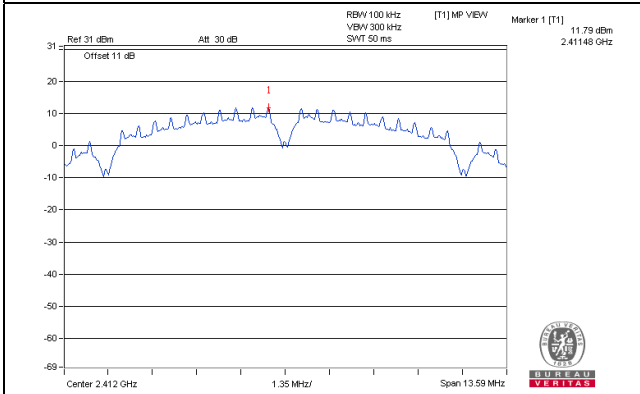

CH 6

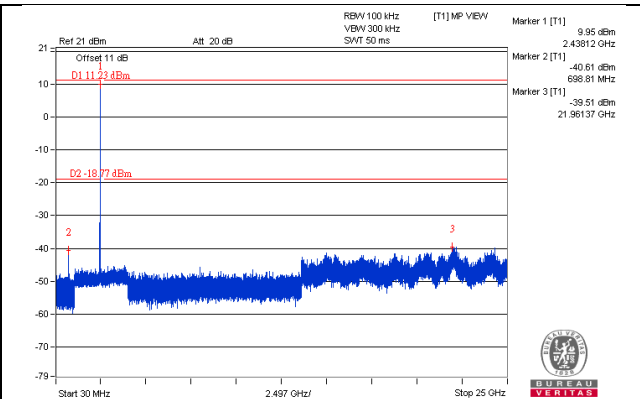
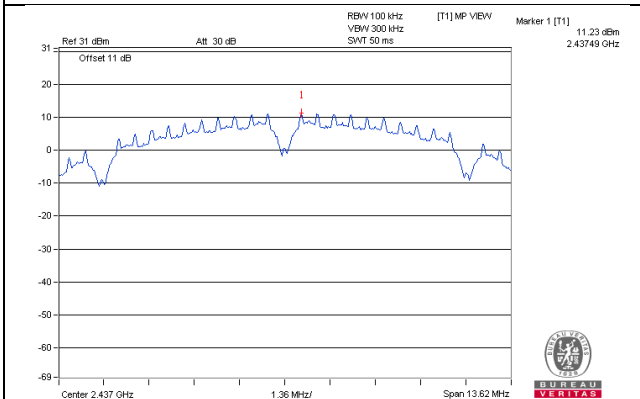

CH 11

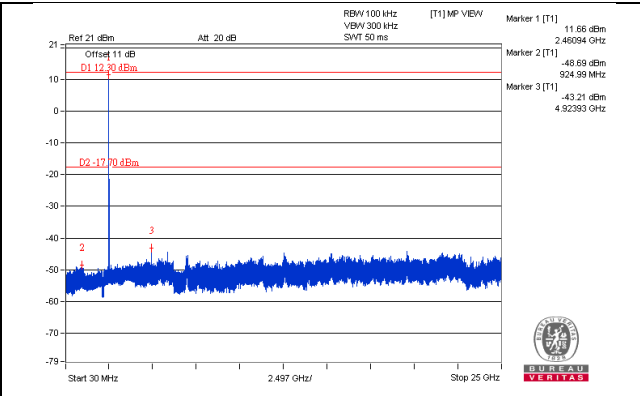
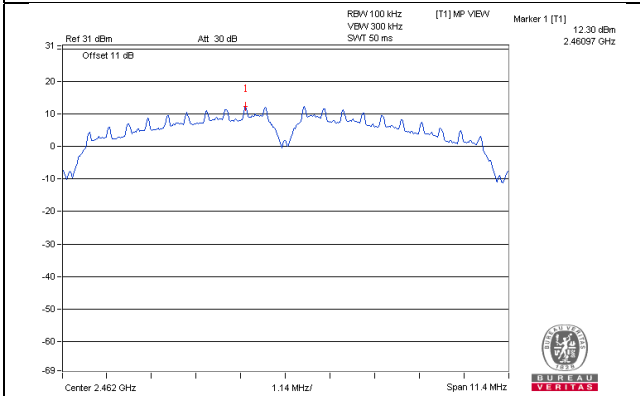

CH 1 Band edge

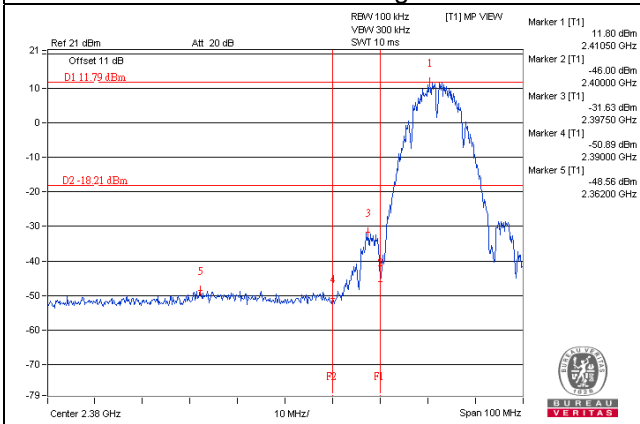

CH 11 Band edge

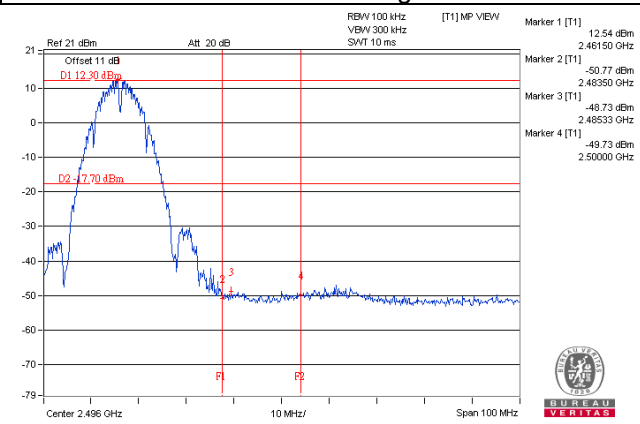

802.11b_Chain 2

CH 1

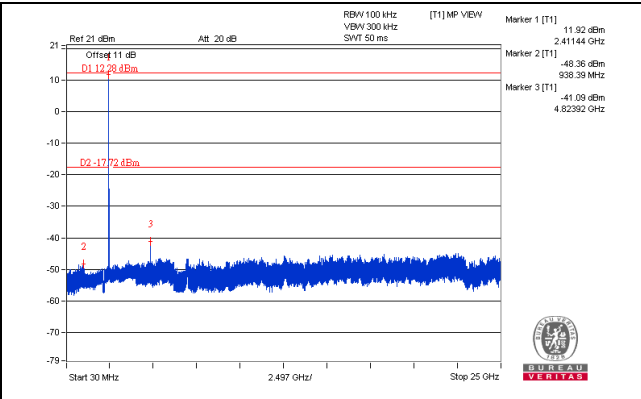
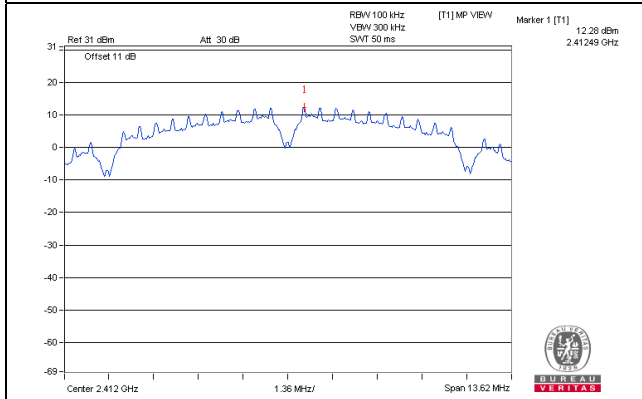

CH 6

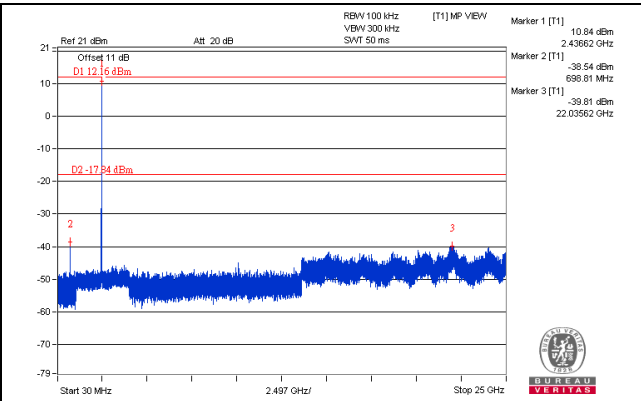
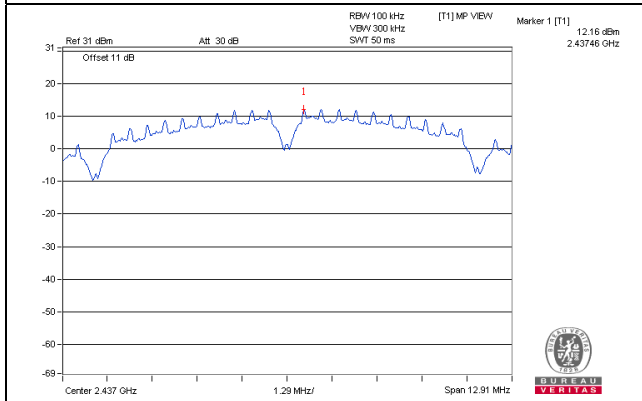

CH 11

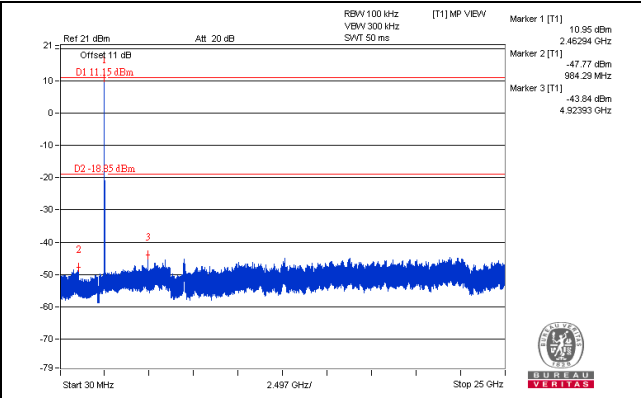
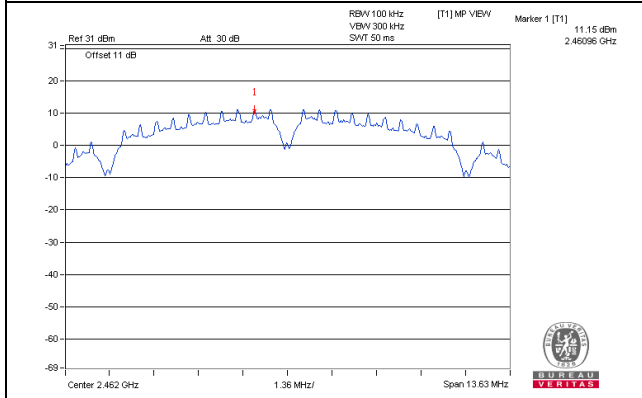

CH 1 Band edge

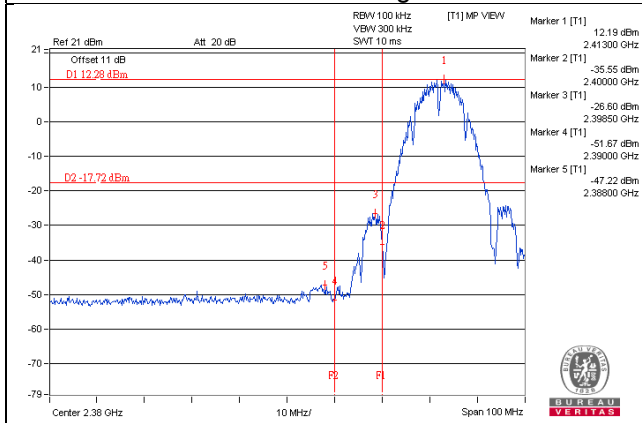

CH 11 Band edge

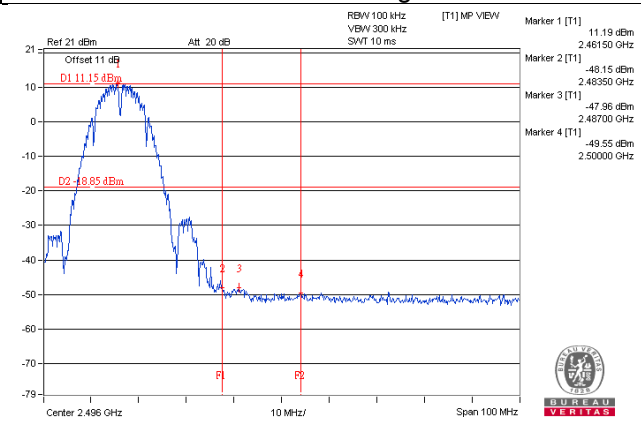

802.11b_Chain 3

CH 1

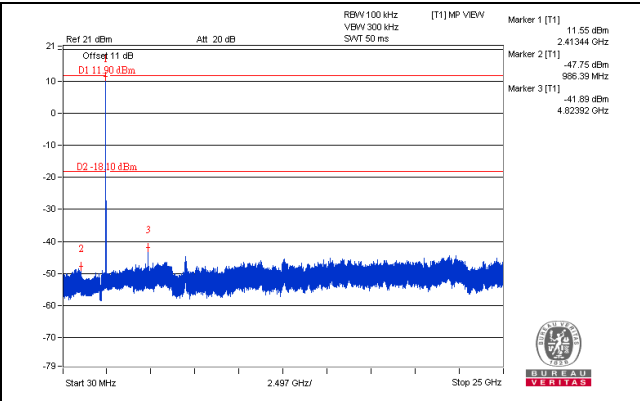
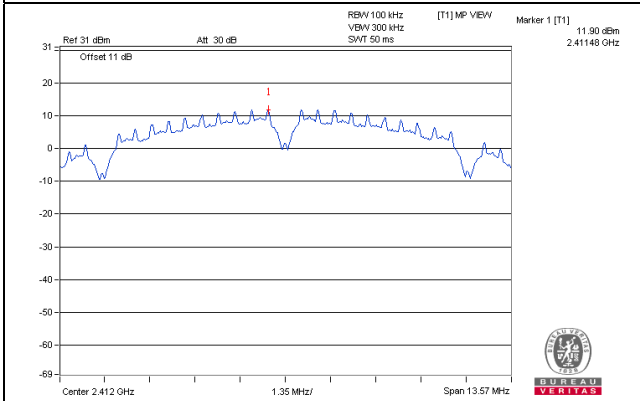

CH 6

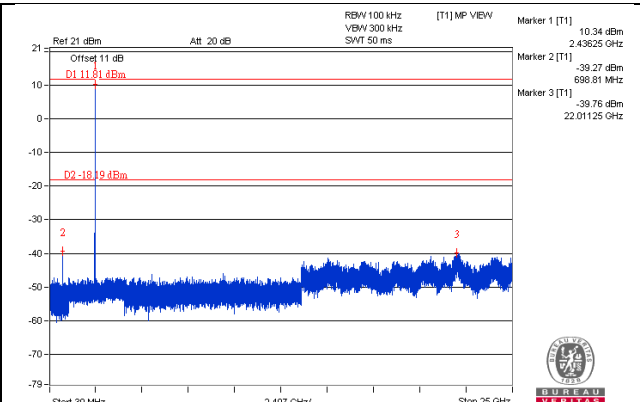
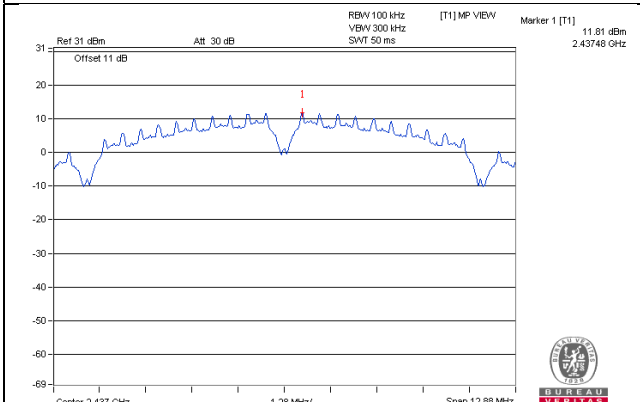

CH 11

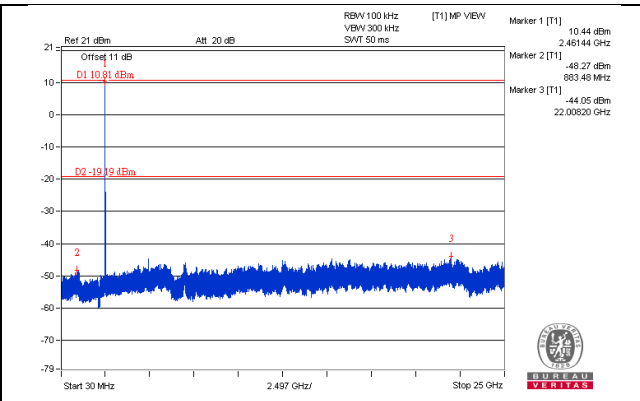
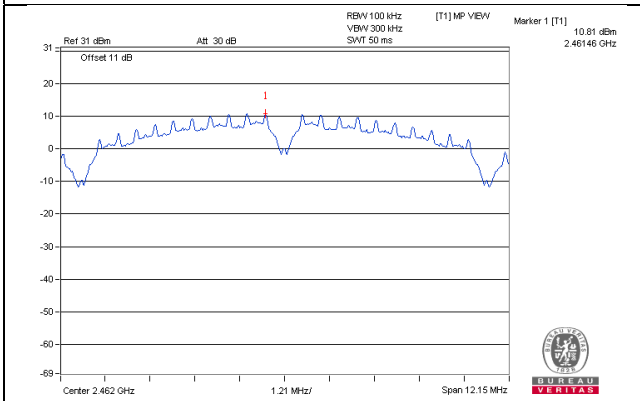

CH 1 Band edge

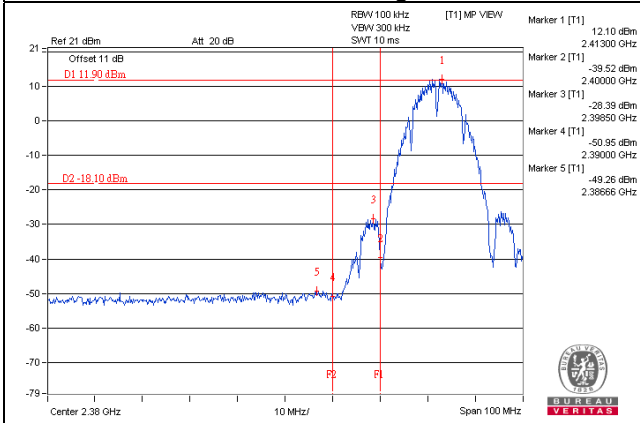

CH 11 Band edge

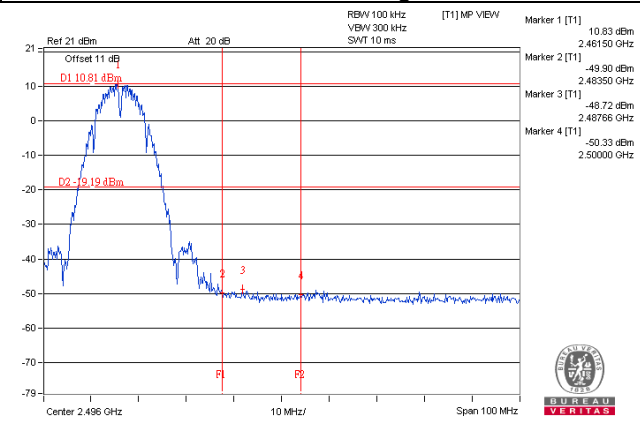

802.11g_Chain 0

CH 1

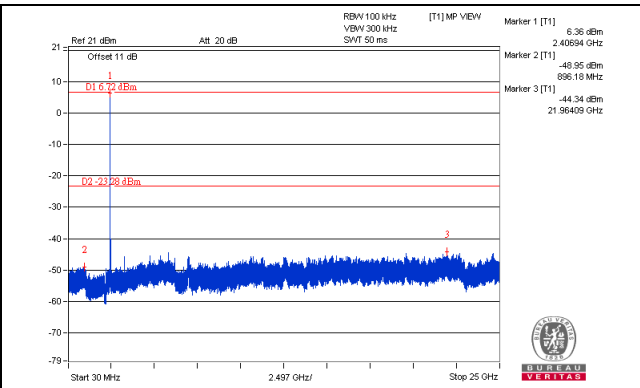
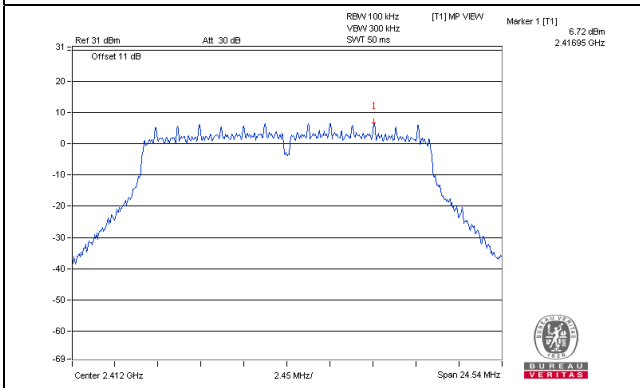

CH 6

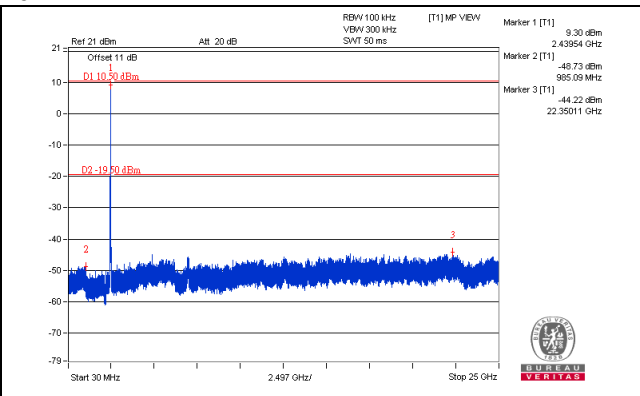
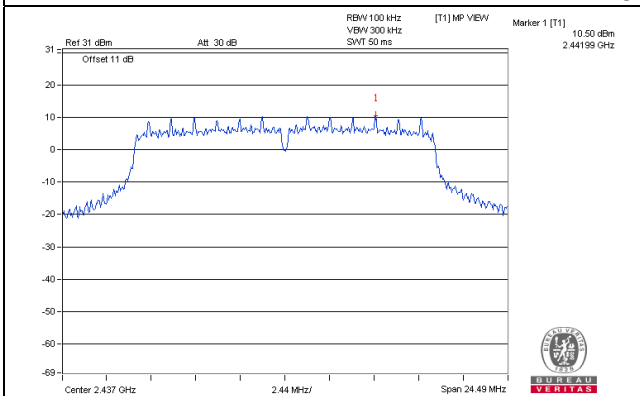

CH 11

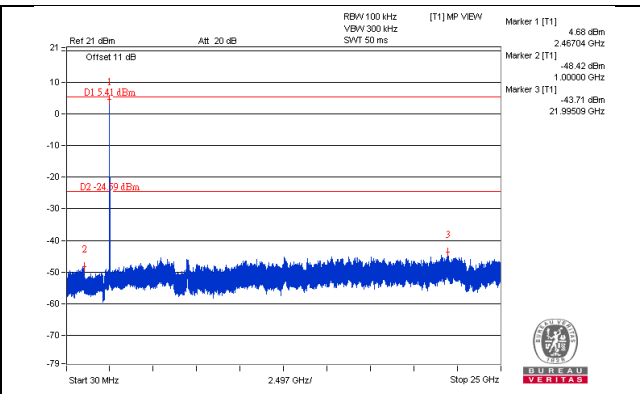
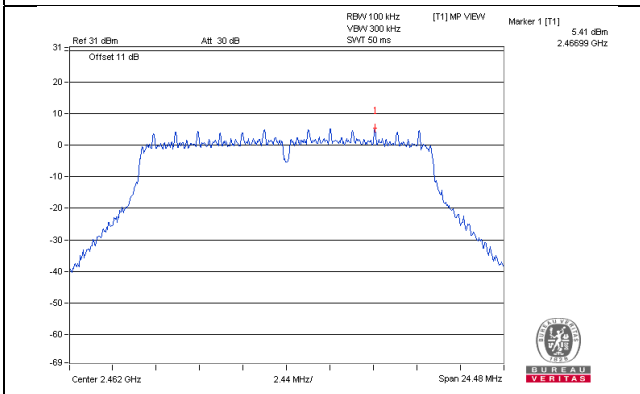

CH 1 Band edge

CH 11 Band edge

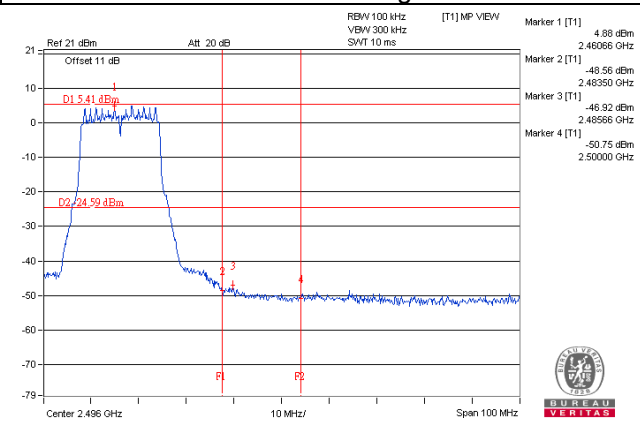
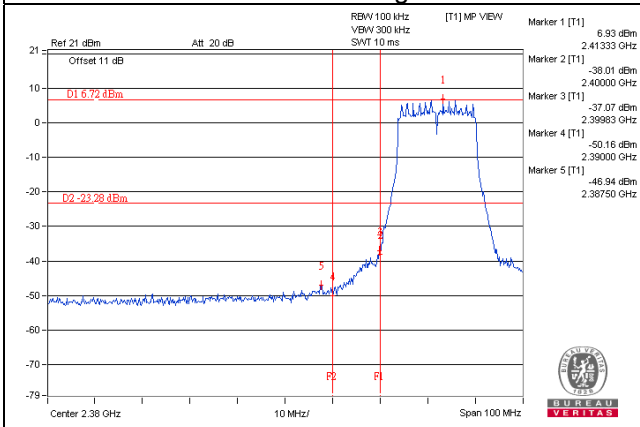

802.11g_Chain 1

CH 1

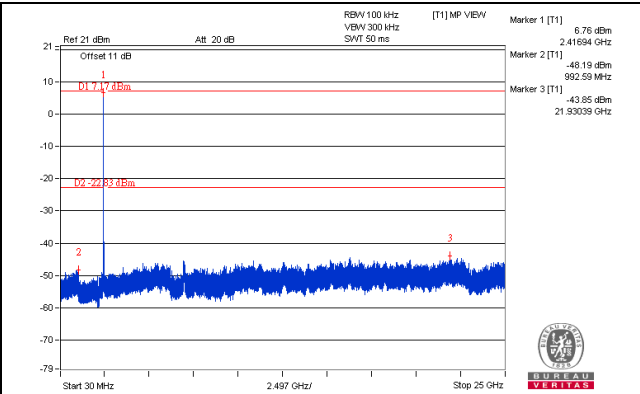
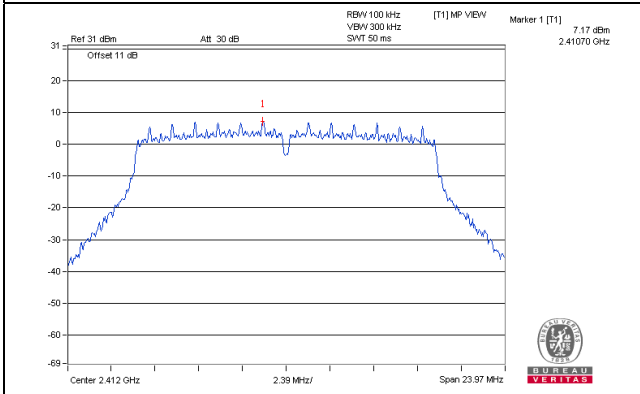

CH 6

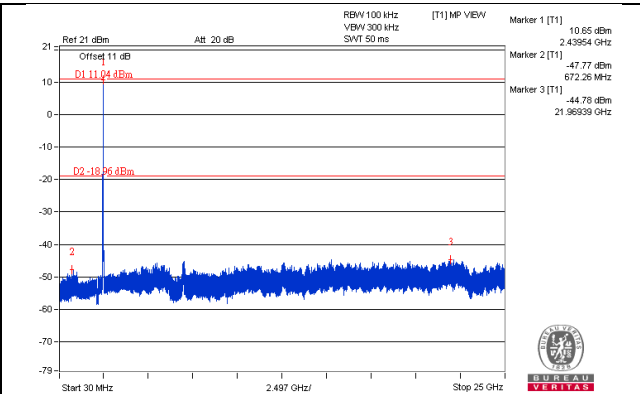
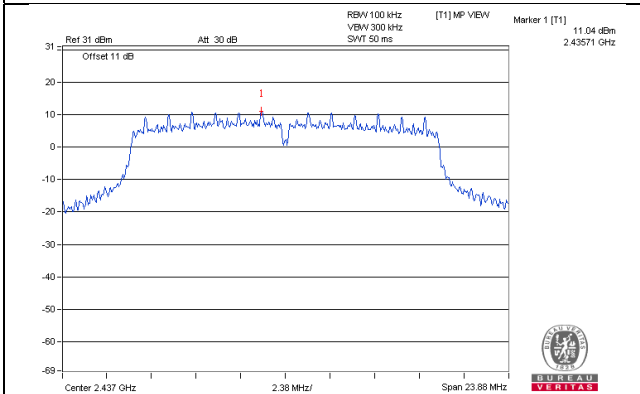

CH 11

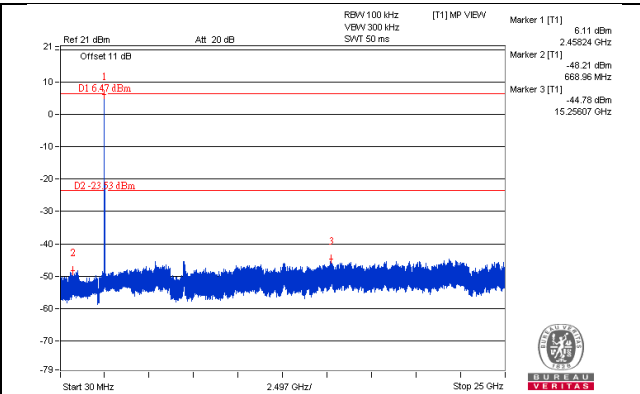
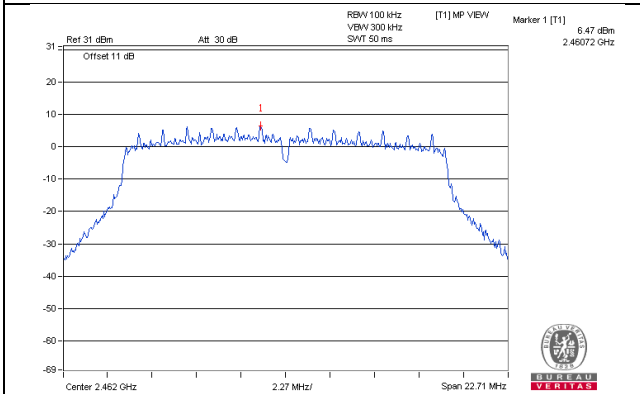

CH 1 Band edge

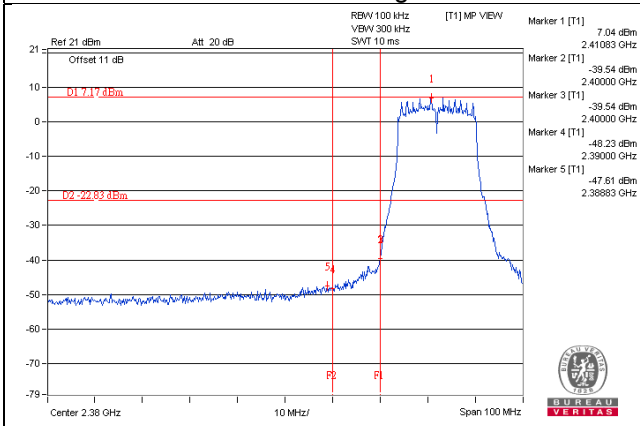

CH 11 Band edge

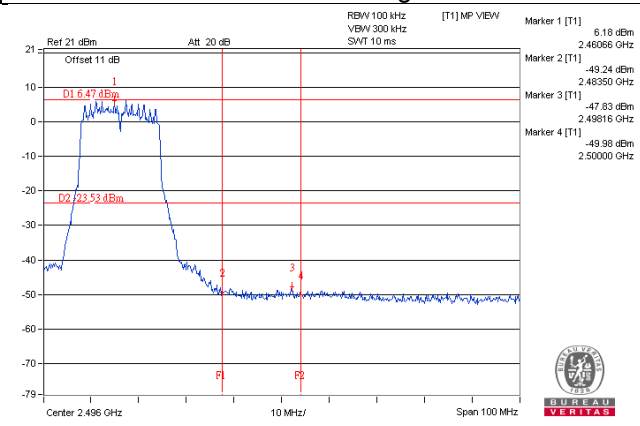

802.11g_Chain 2

CH 1

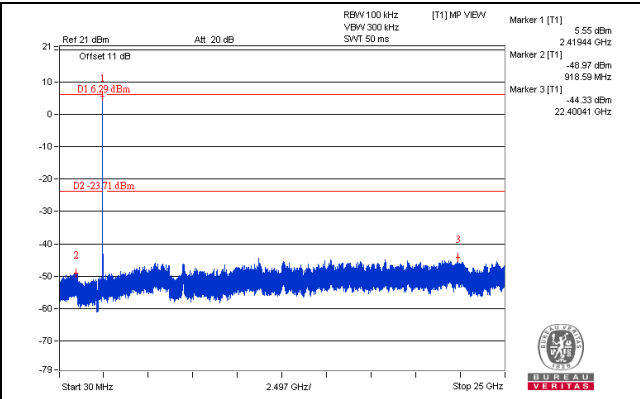
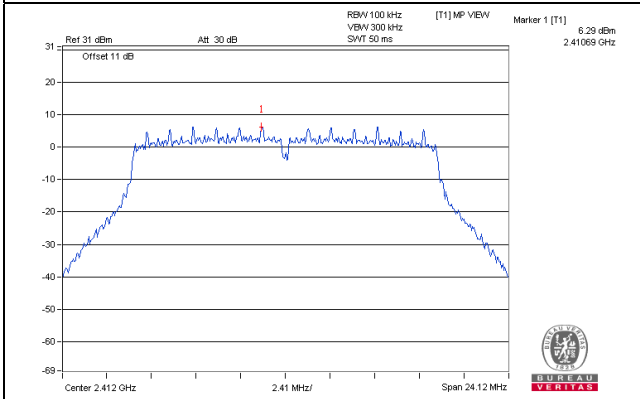

CH 6

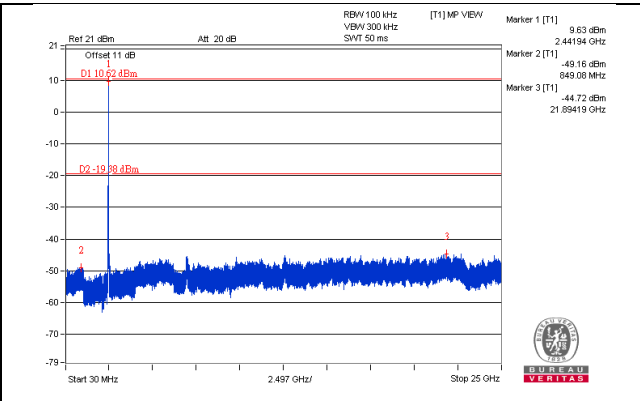
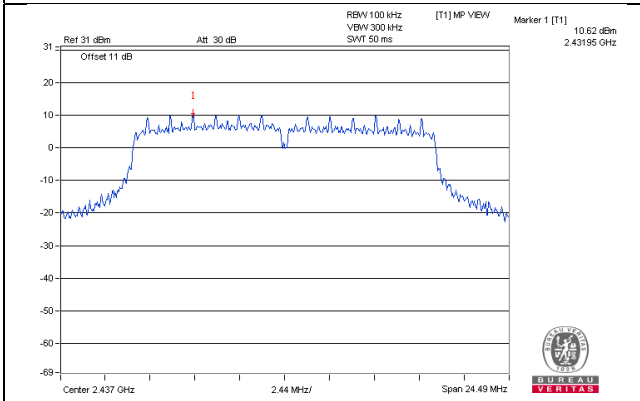

CH 11

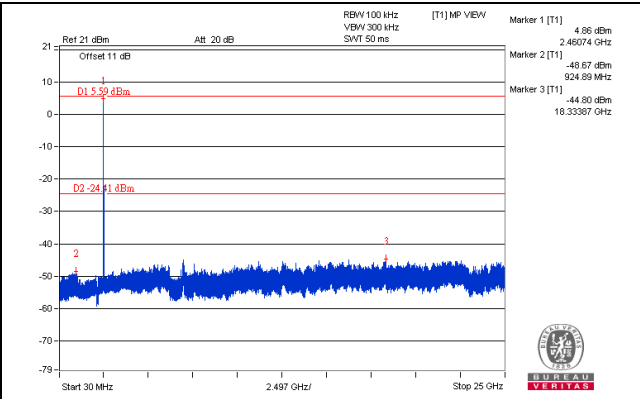
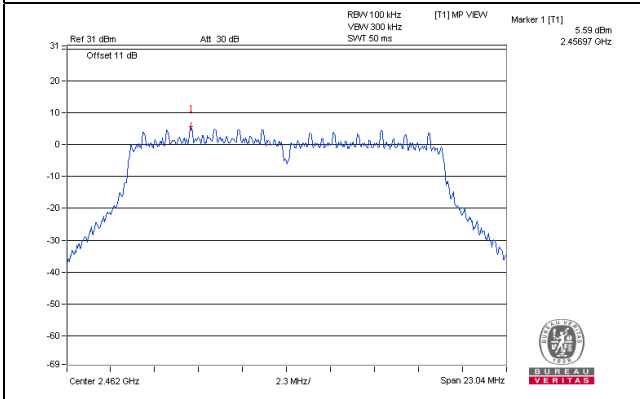

CH 1 Band edge

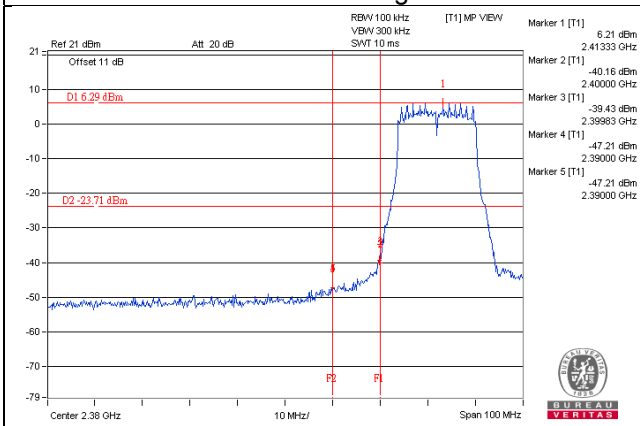

CH 11 Band edge

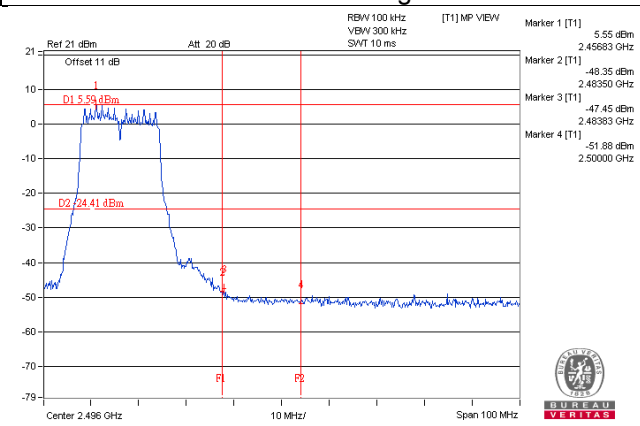

802.11g_Chain 3

CH 1

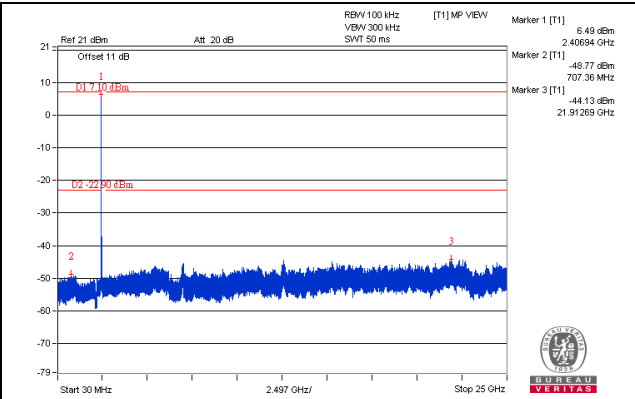
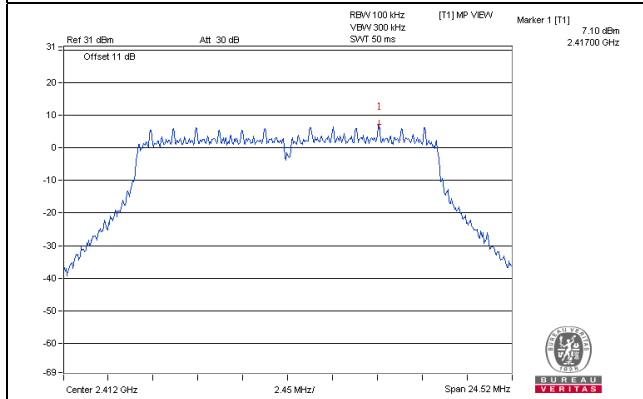

CH 6

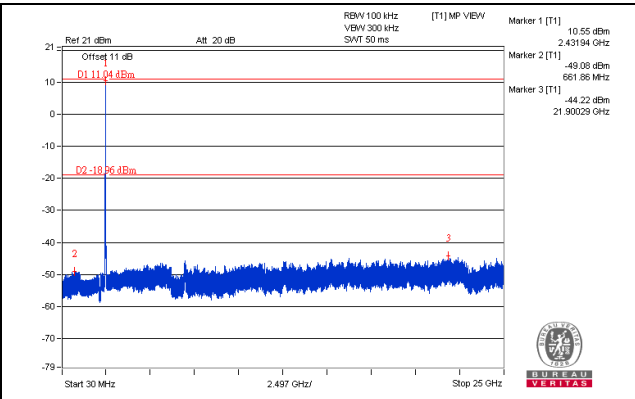
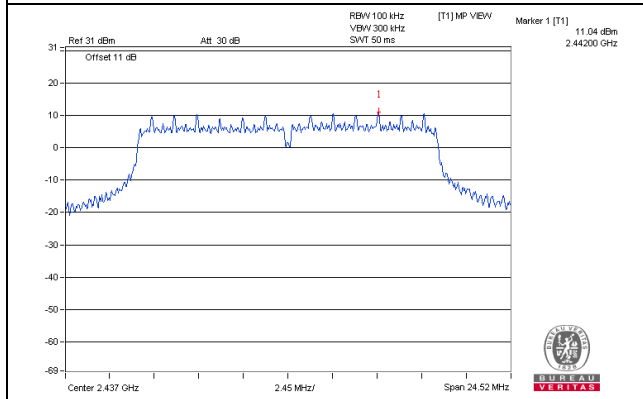

CH 11

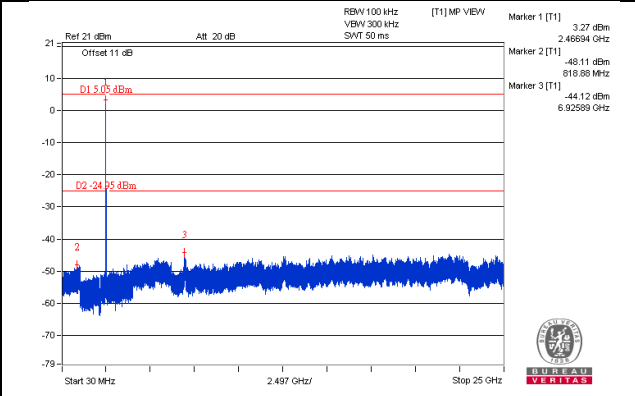
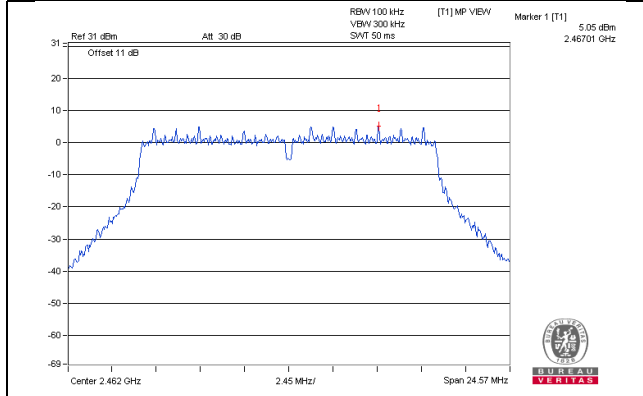

CH 1 Band edge

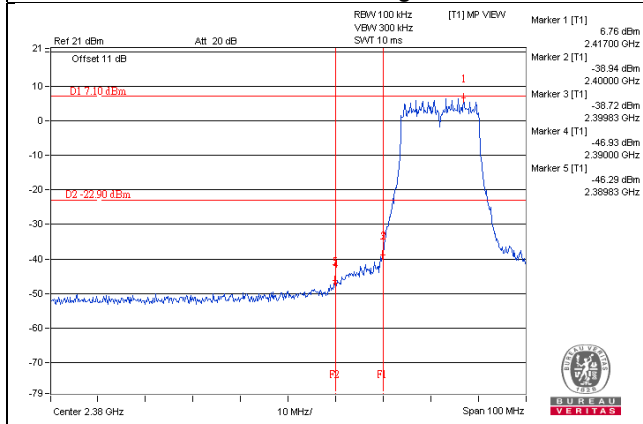

CH 11 Band edge

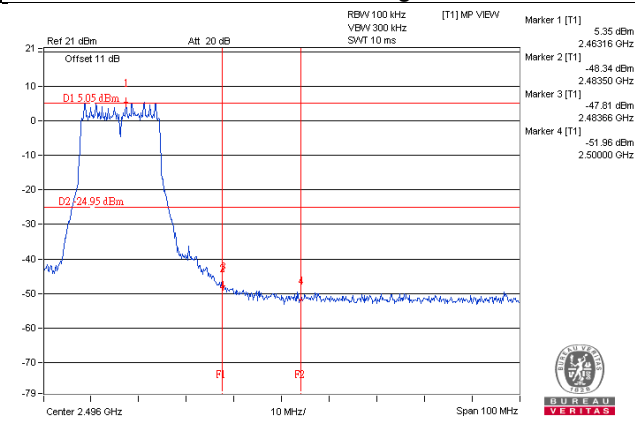

802.11n (HT20)_Chain 0

CH 1

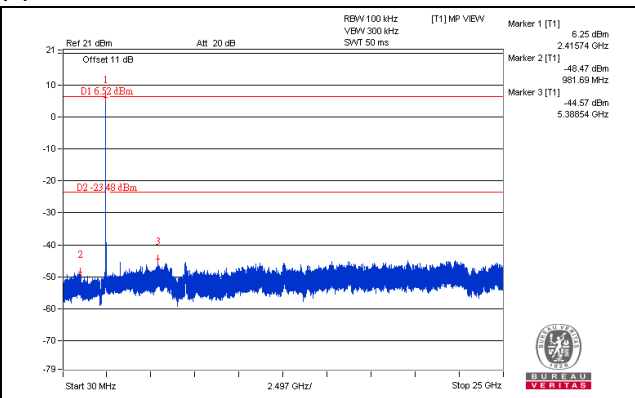
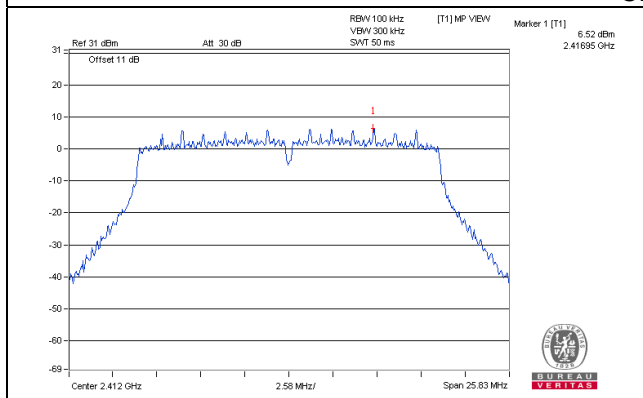

CH 6

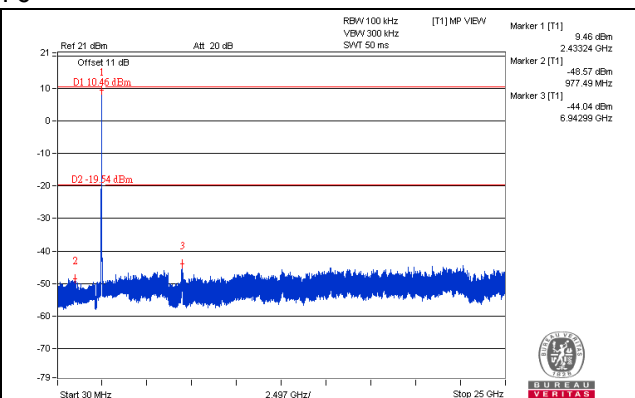
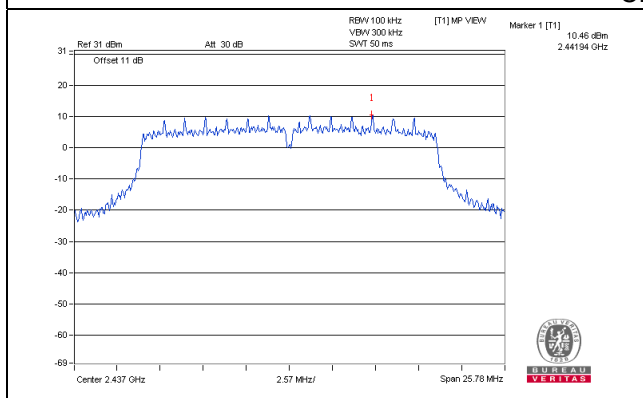

CH 11

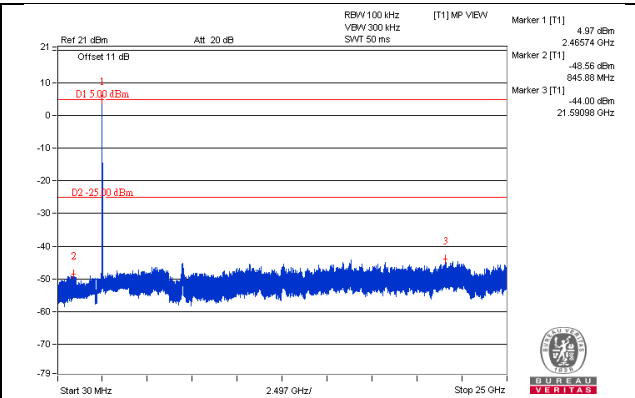
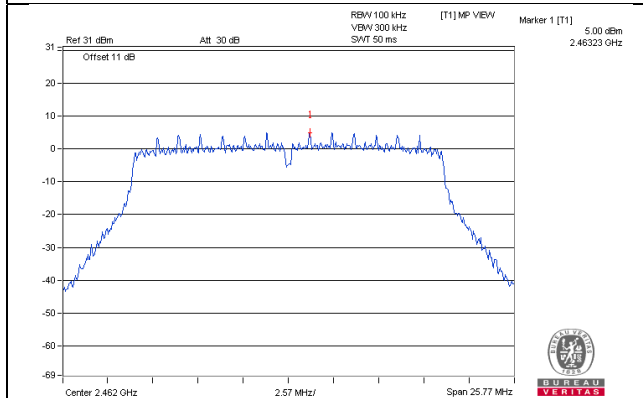

CH 1 Band edge

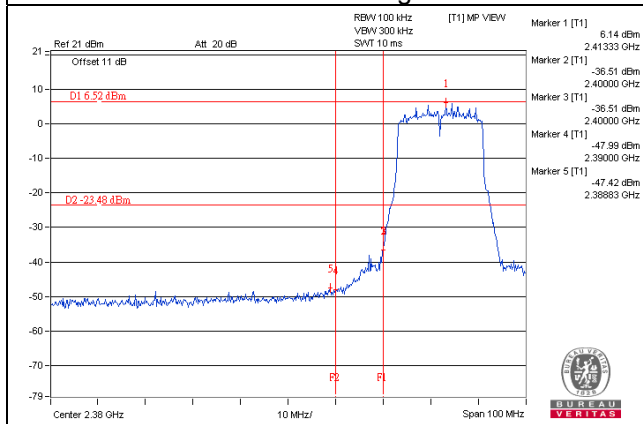

CH 11 Band edge

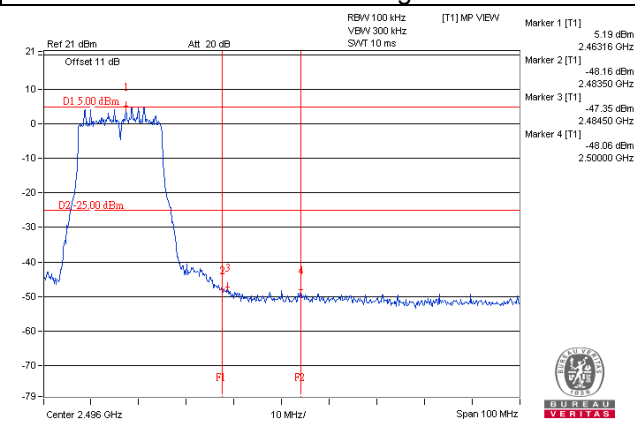

802.11n (HT20)_Chain 1

CH 1

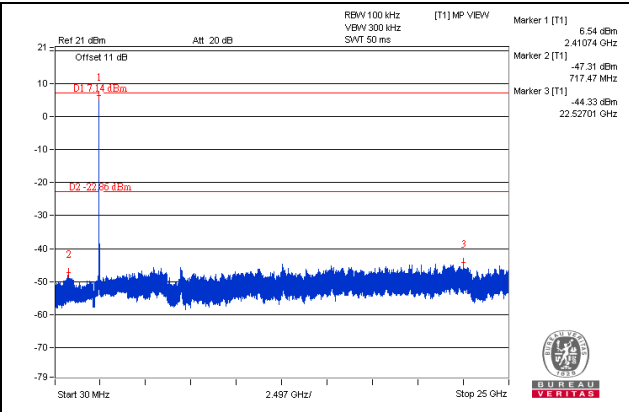
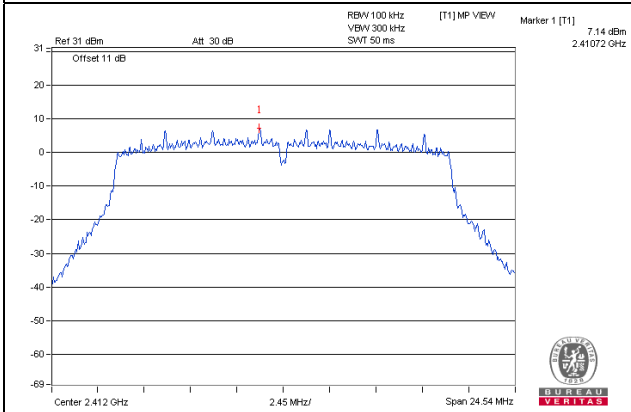

CH 6

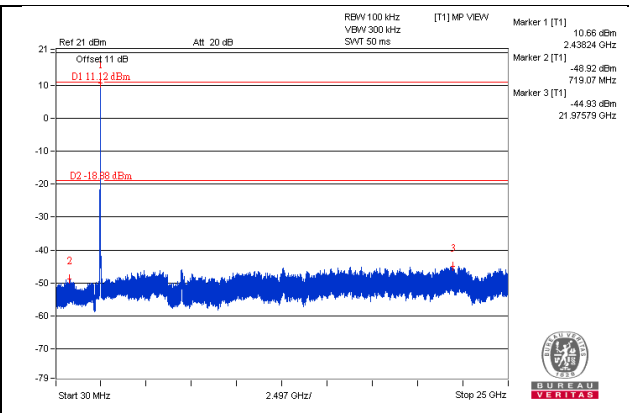
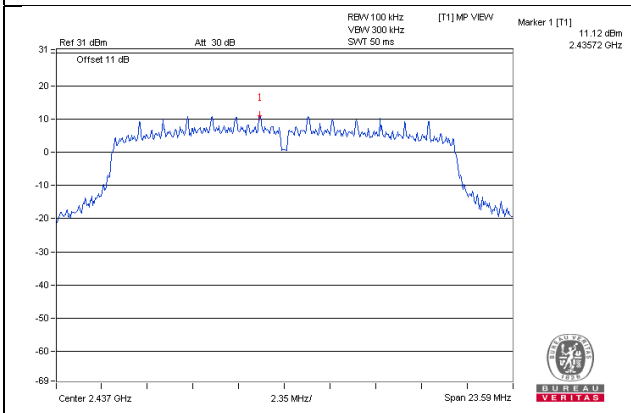

CH 11

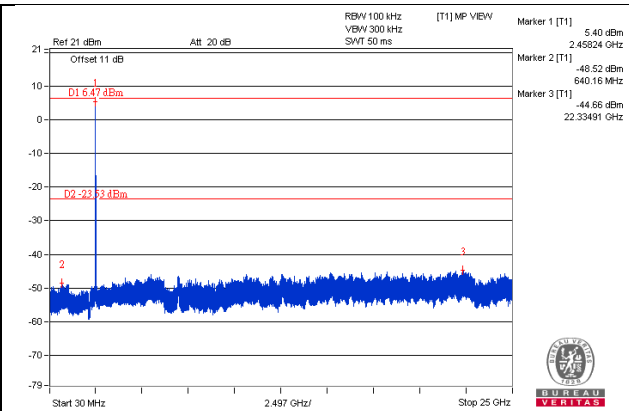
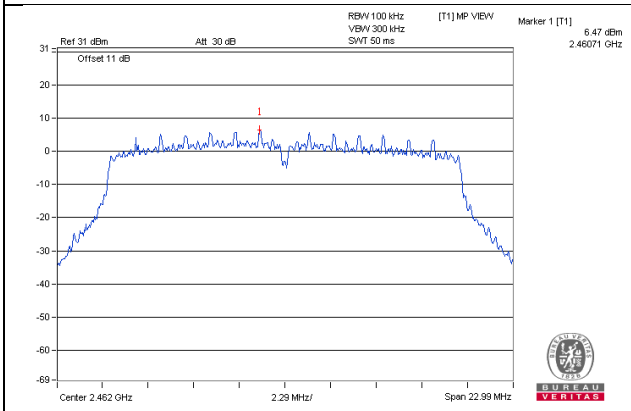

CH 1 Band edge

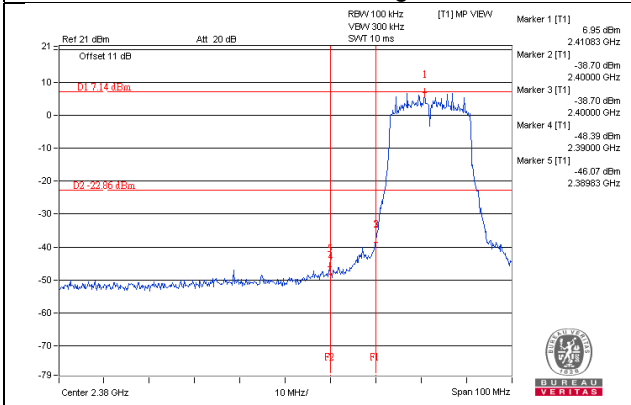

CH 11 Band edge

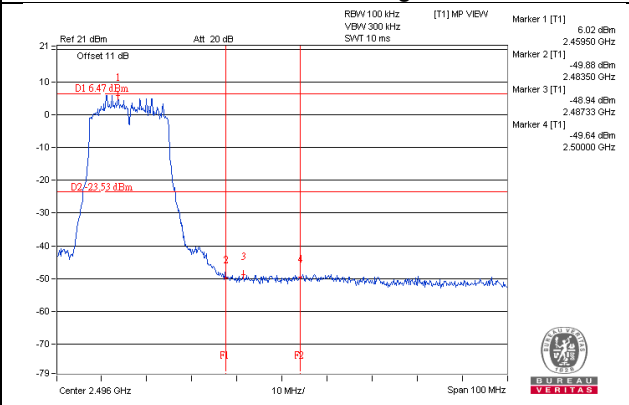

802.11n (HT20)_Chain 2

CH 1

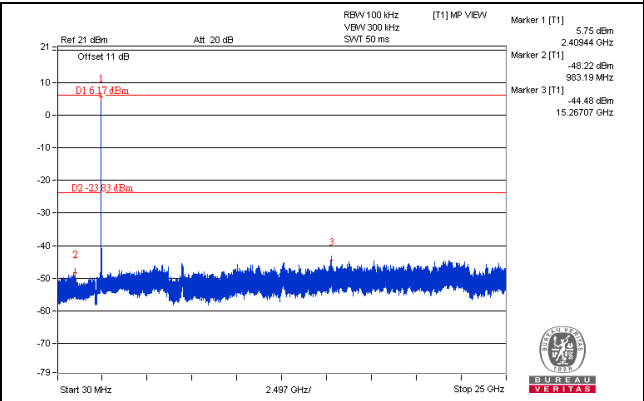
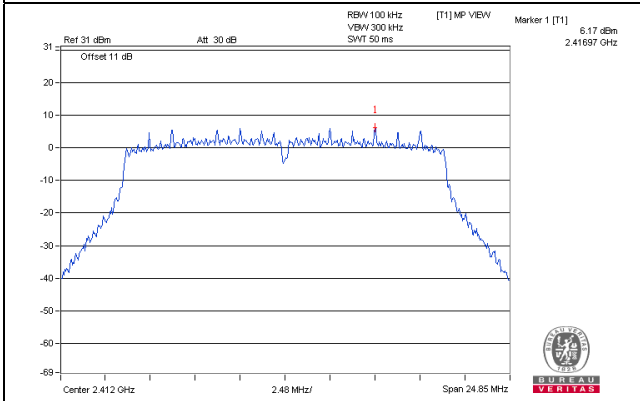

CH 6

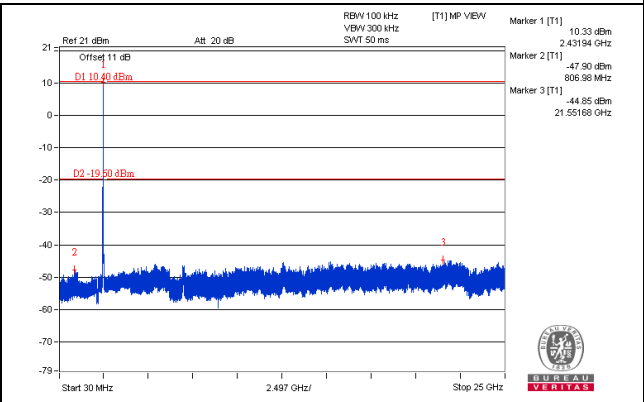
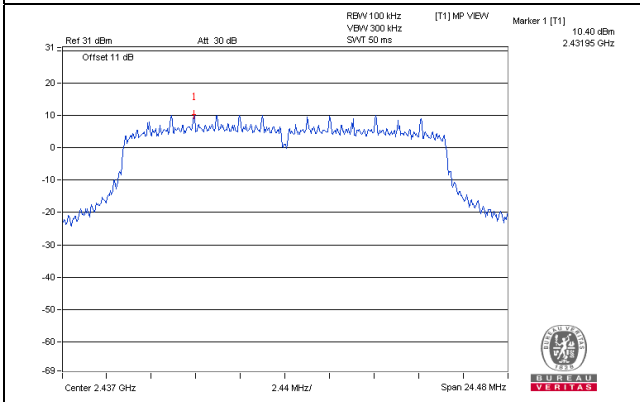

CH 11

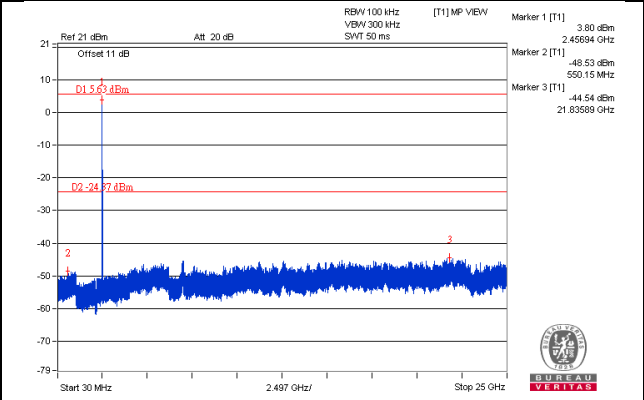
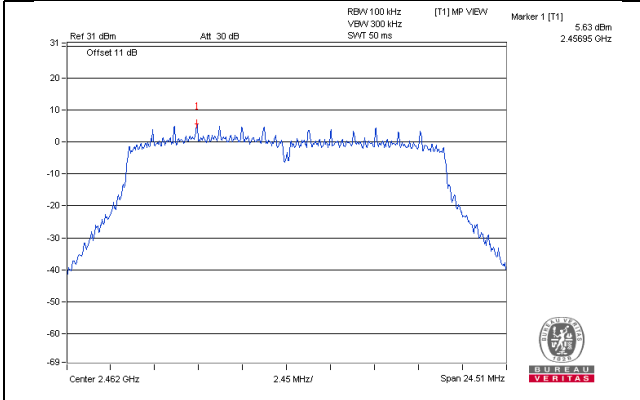

CH 1 Band edge

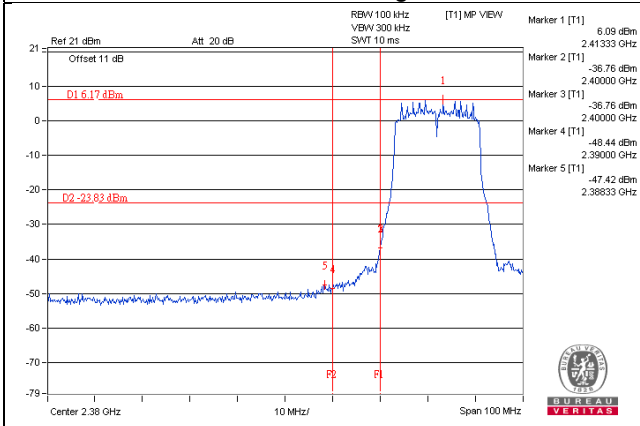

CH 11 Band edge

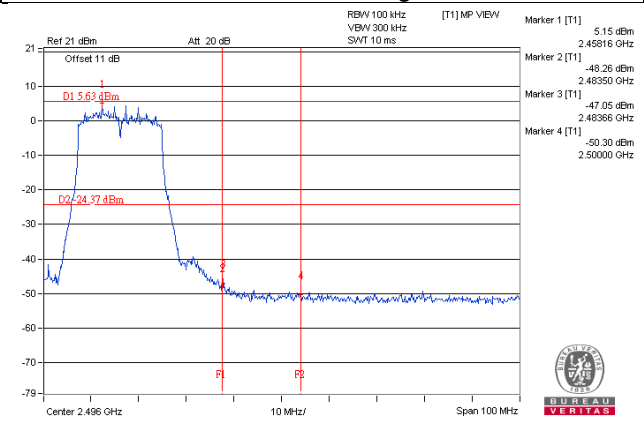

802.11n (HT20)_Chain 3

CH 1

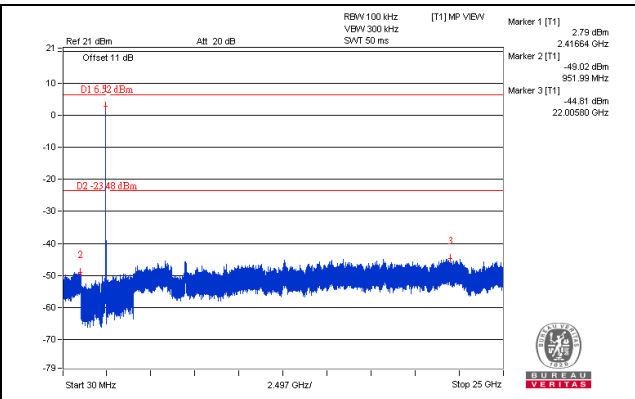
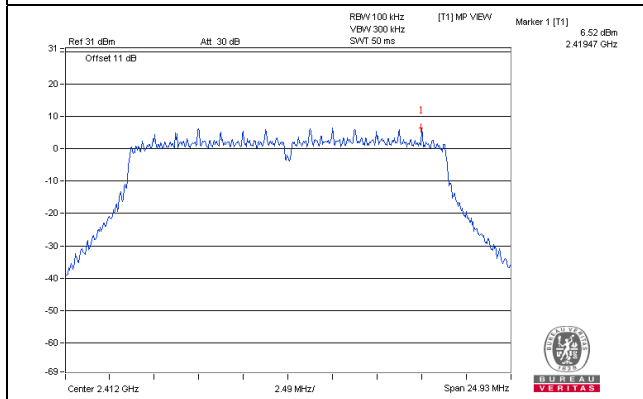

CH 6

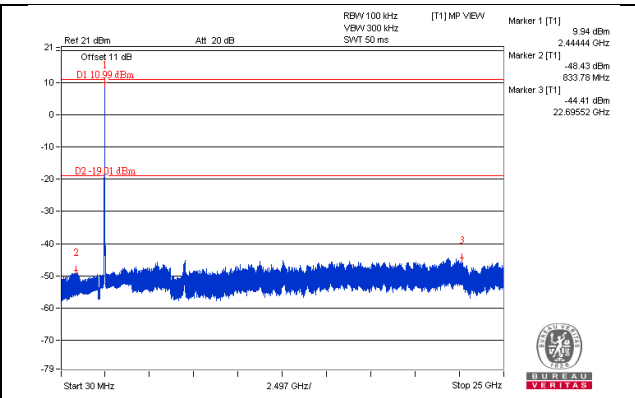
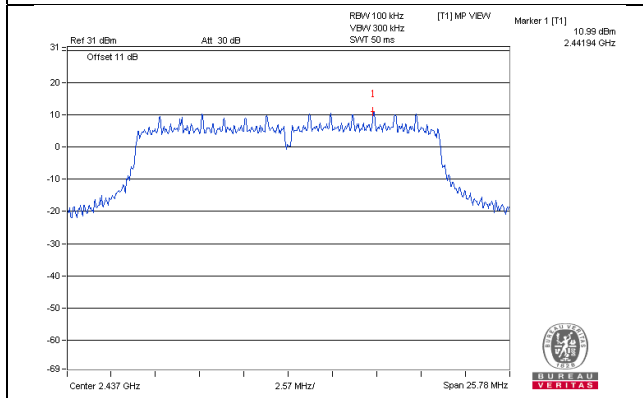

CH 11

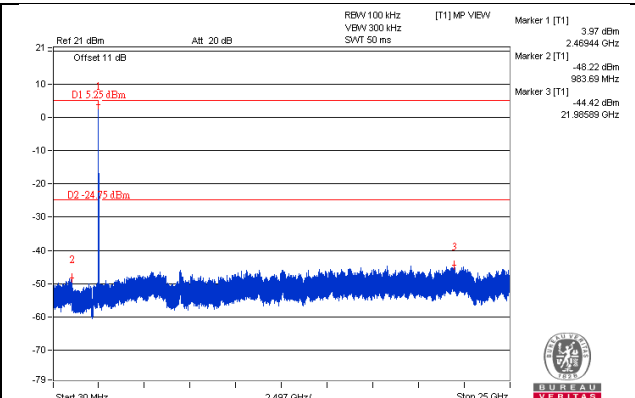
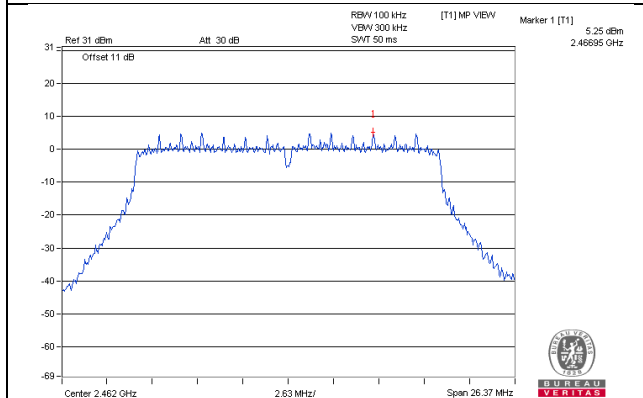

CH 1 Band edge

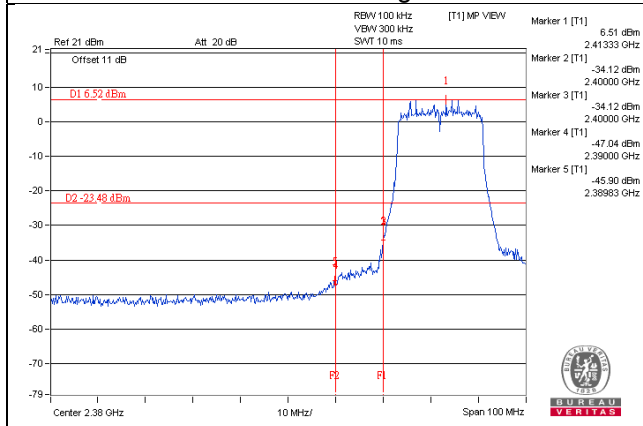

CH 11 Band edge

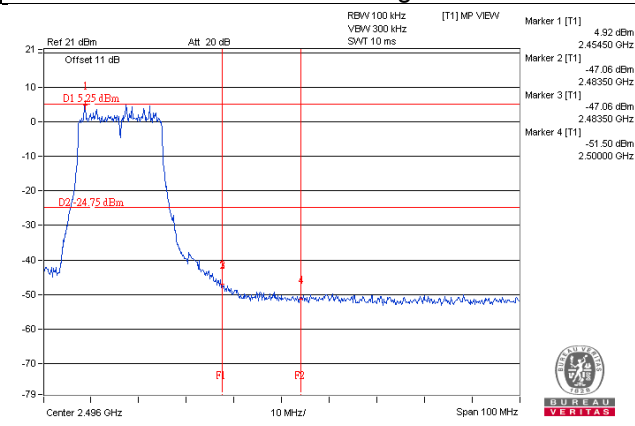

802.11n (HT40)_Chain 0

CH 3

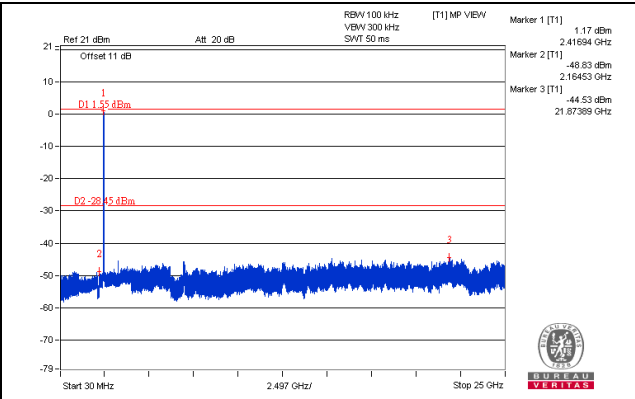
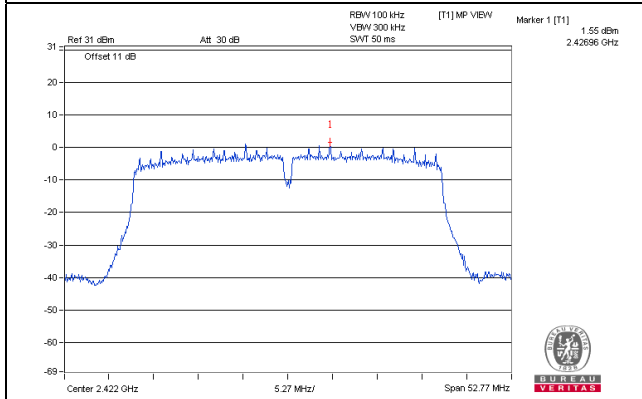

CH 6

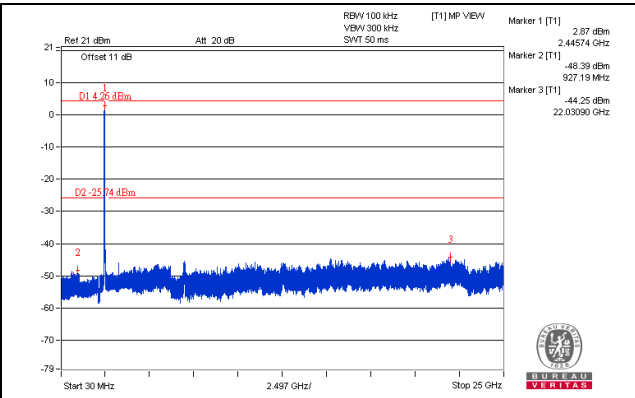
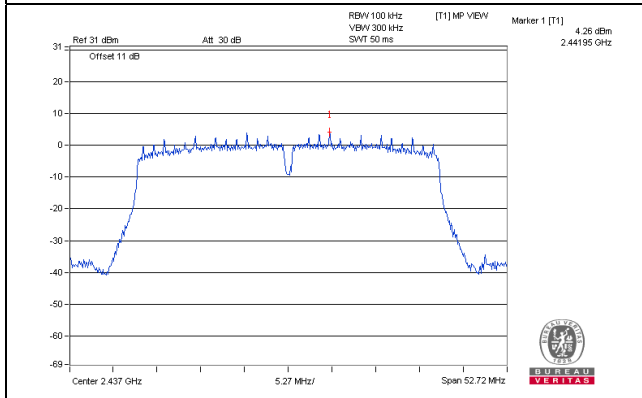

CH 9

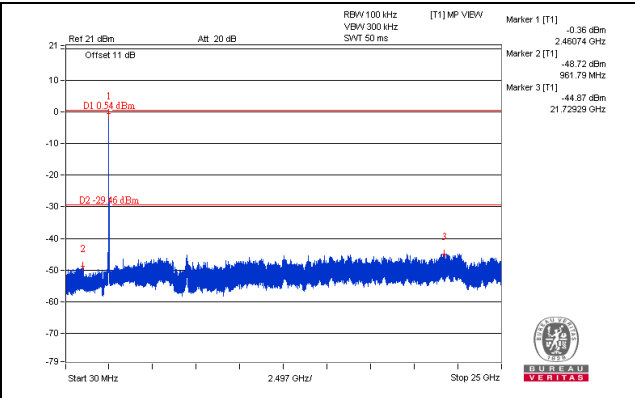
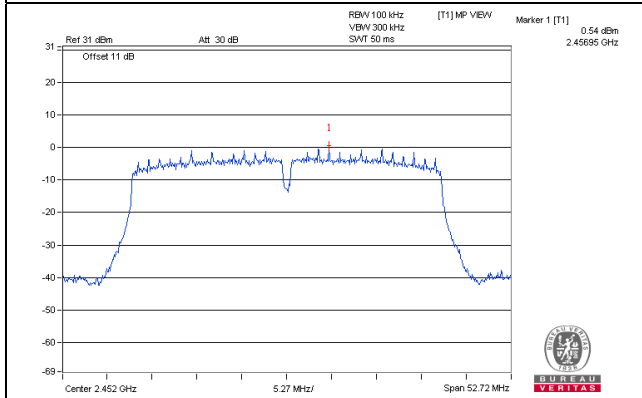

CH 3 Band edge

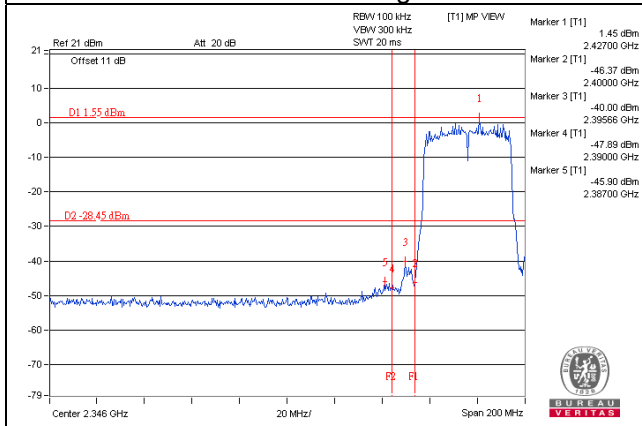

CH 9 Band edge

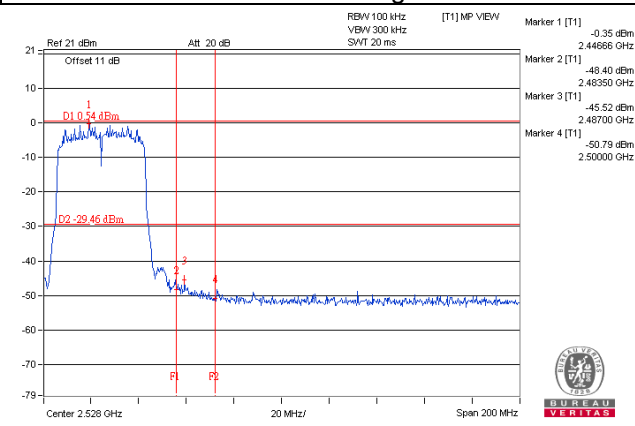

802.11n (HT40)_Chain 1

CH 3

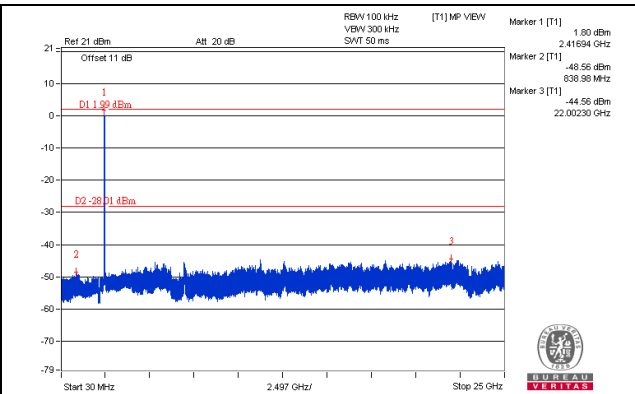
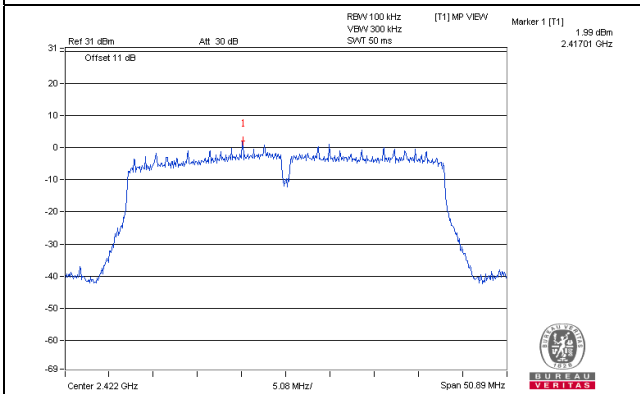

CH 6

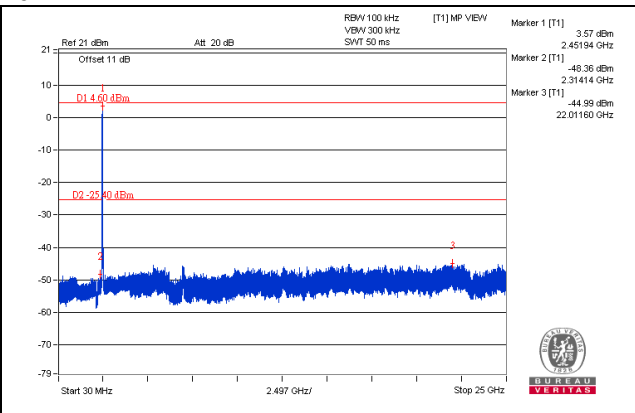
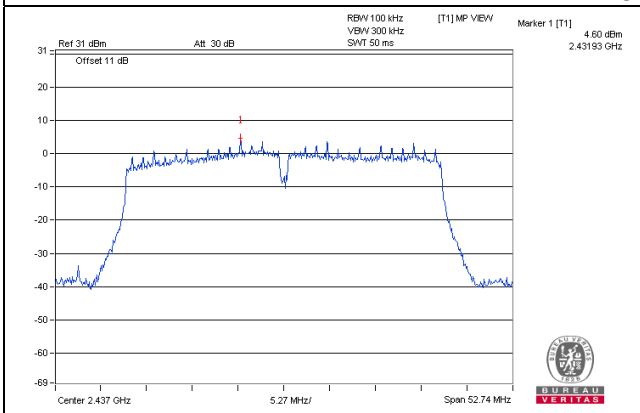

CH 9

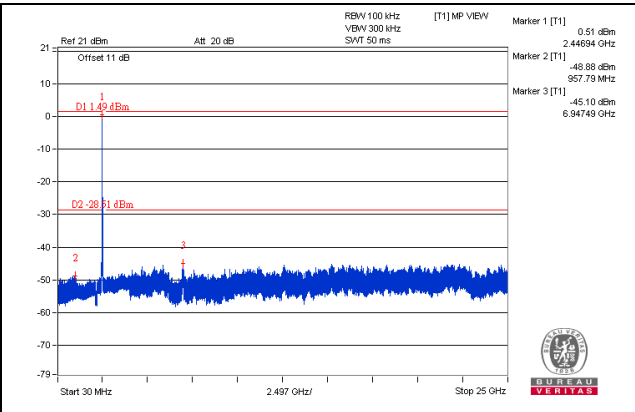
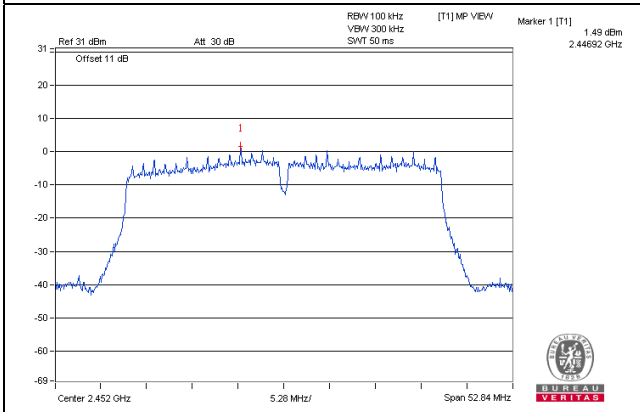

CH 3 Band edge

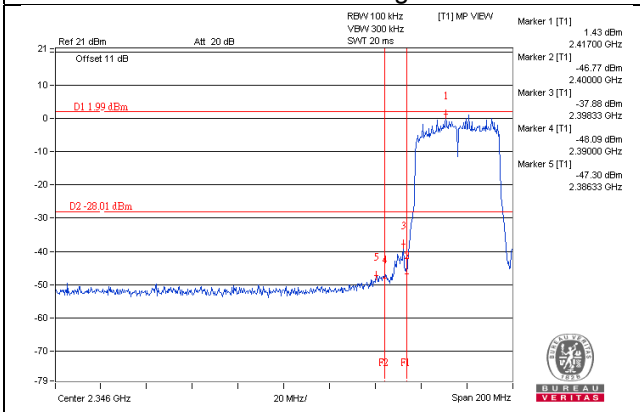

CH 9 Band edge

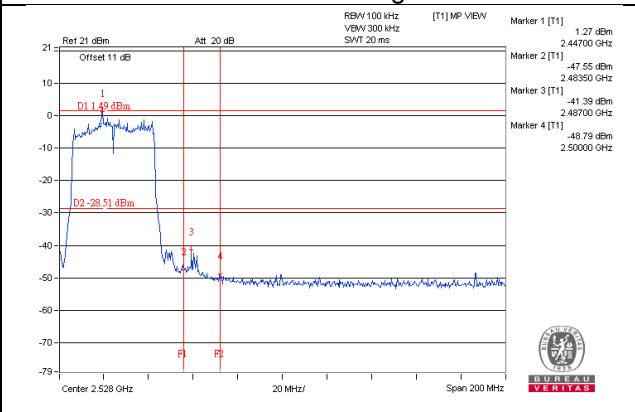

802.11n (HT40)_Chain 2

CH 3

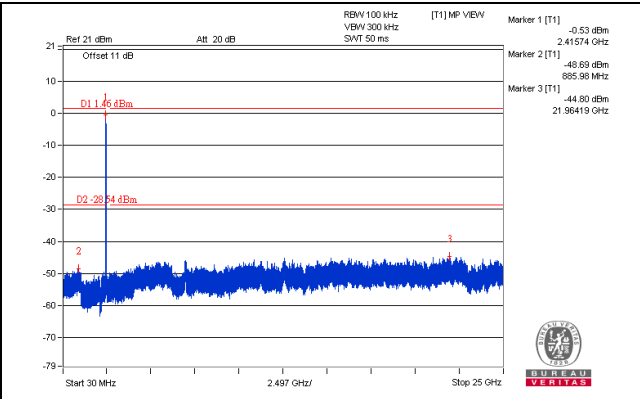
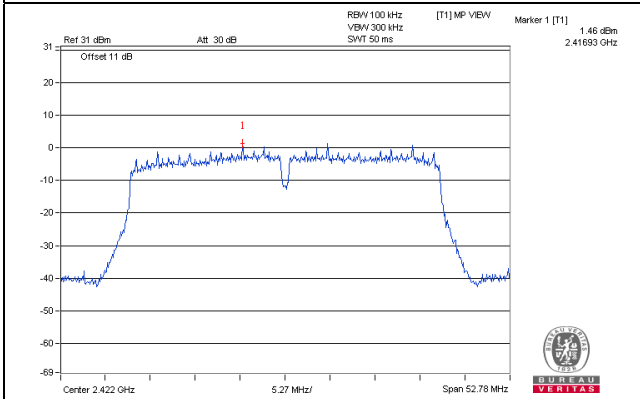

CH 6

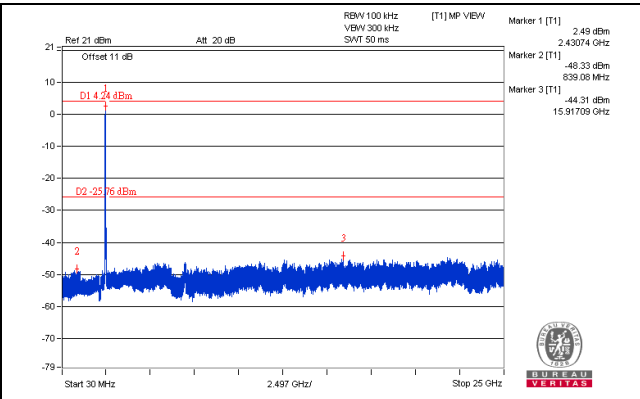
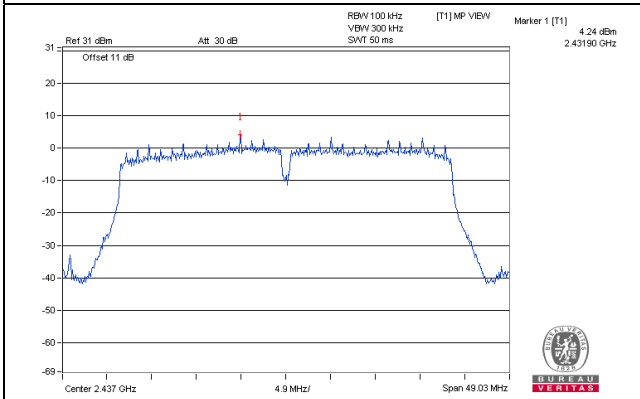

CH 9

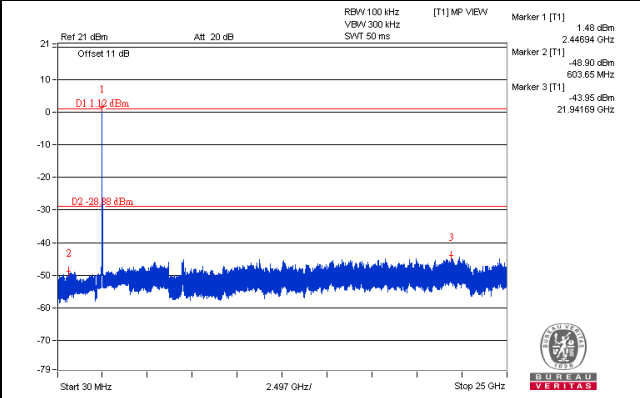
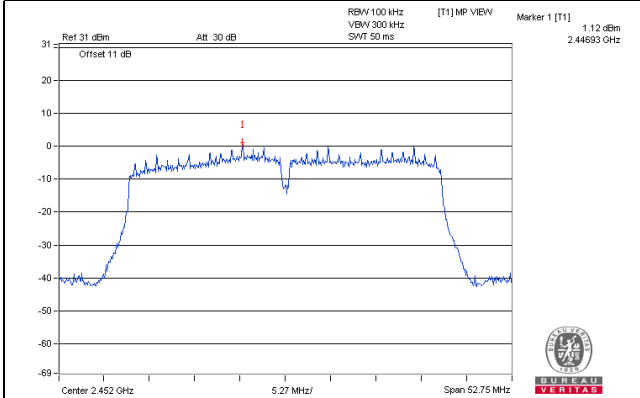

CH 3 Band edge

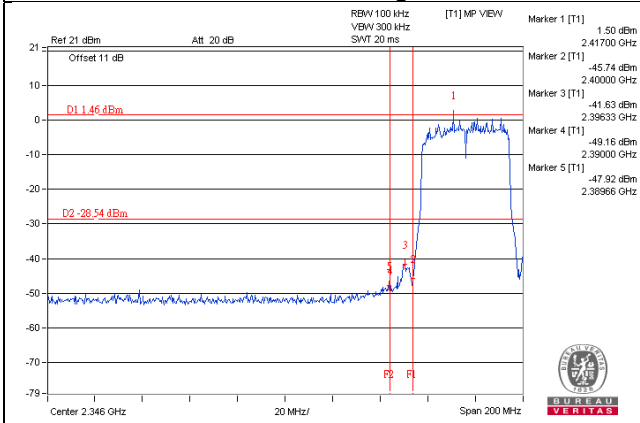

CH 9 Band edge

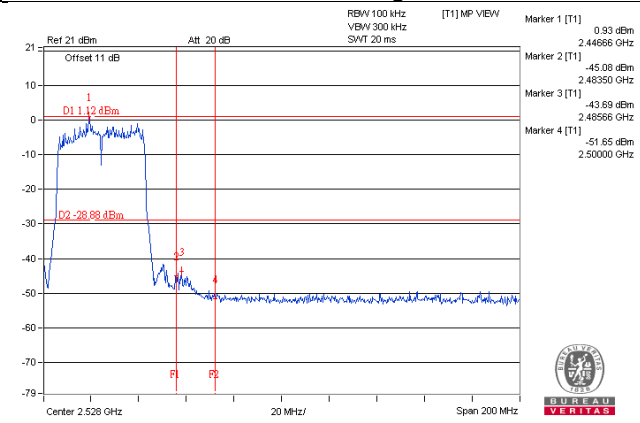

802.11n (HT40)_Chain 3

CH 3

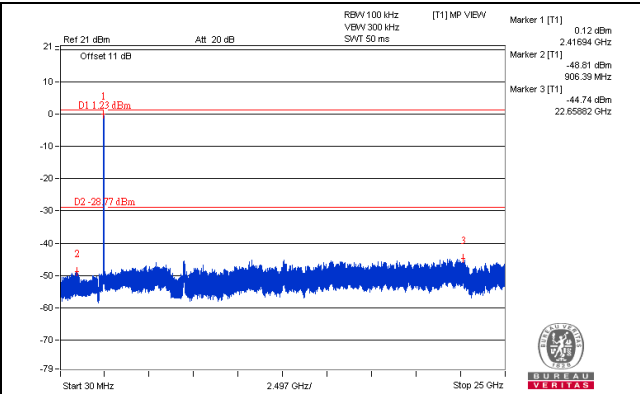
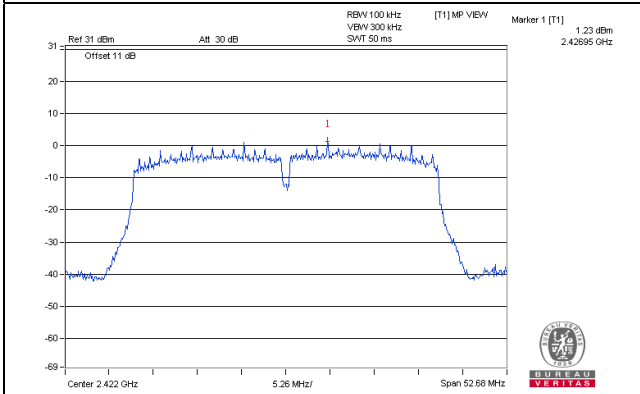

CH 6

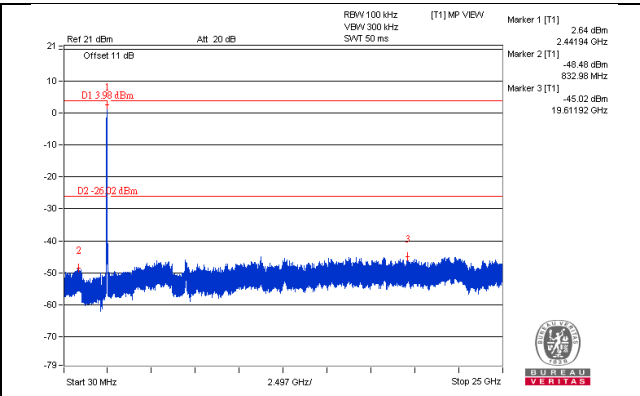
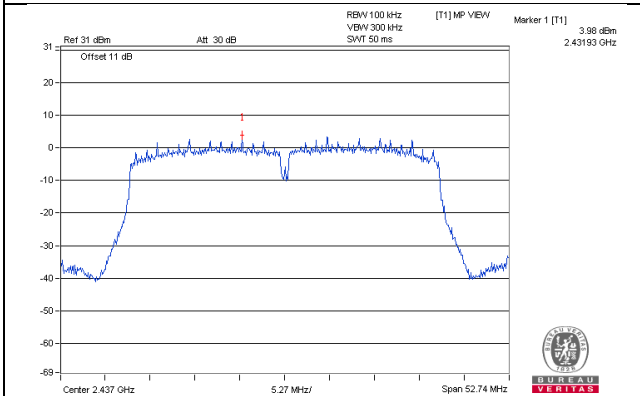

CH 9

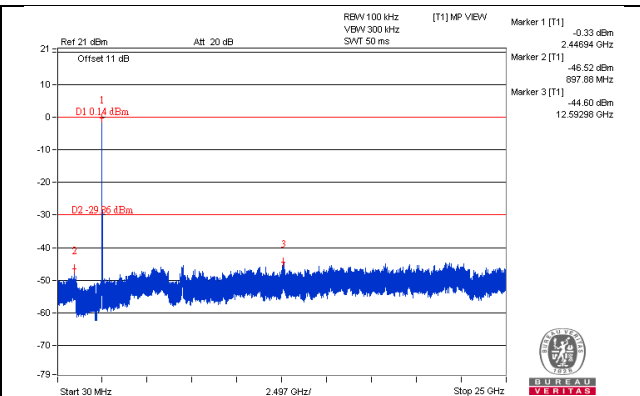
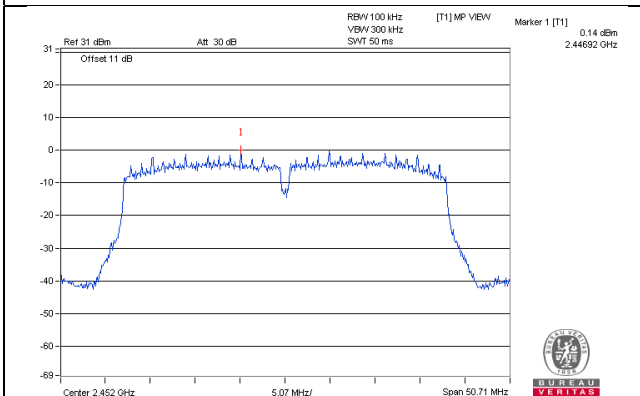

CH 3 Band edge

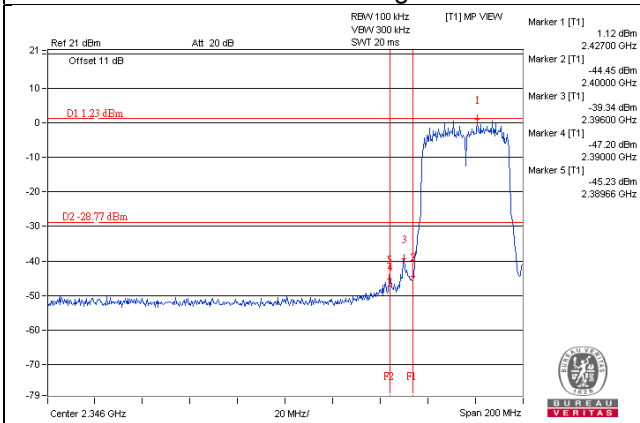

CH 9 Band edge

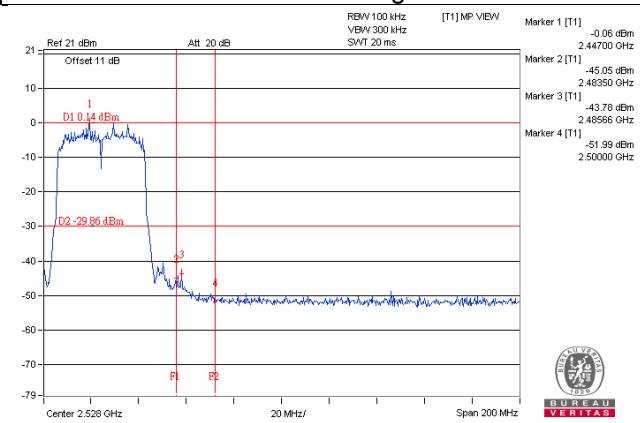

Test Mode D
802.11b_Chain 0

CH 1

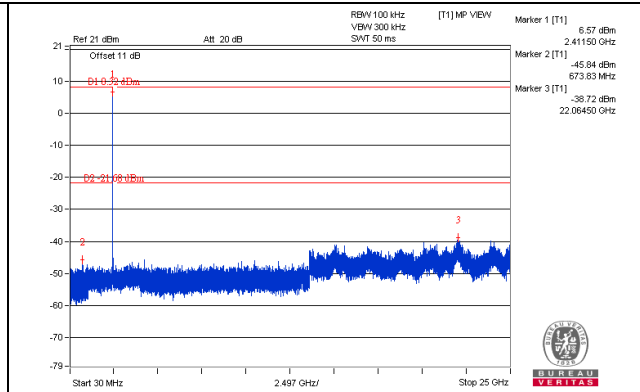
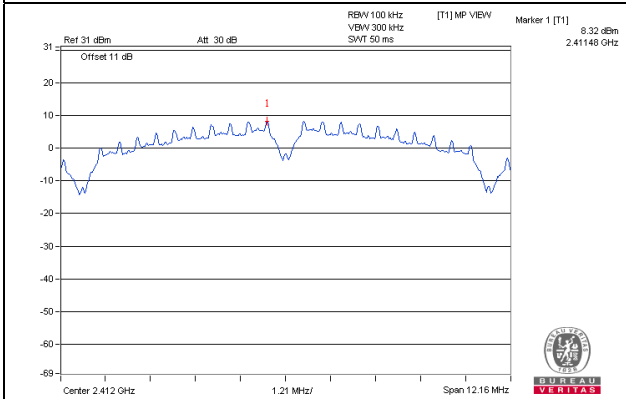

CH 6

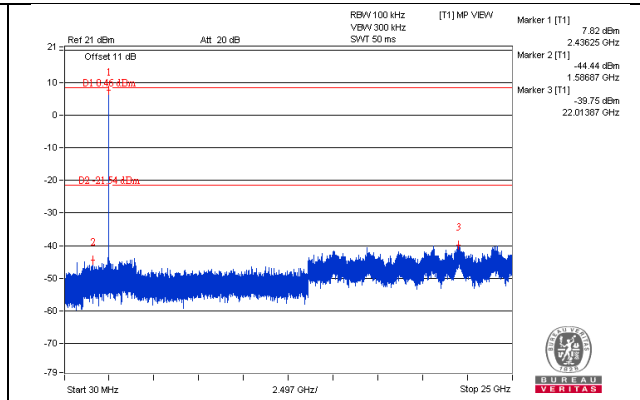
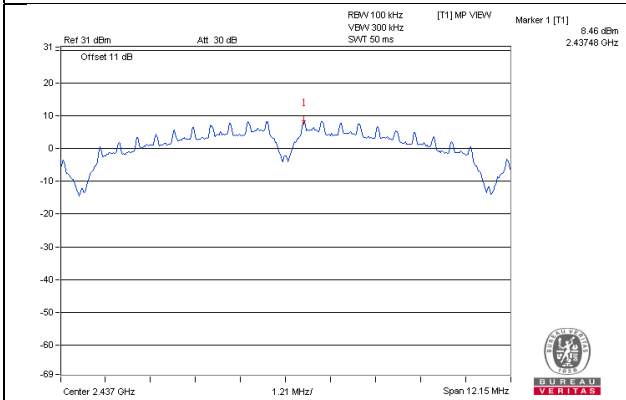

CH 11

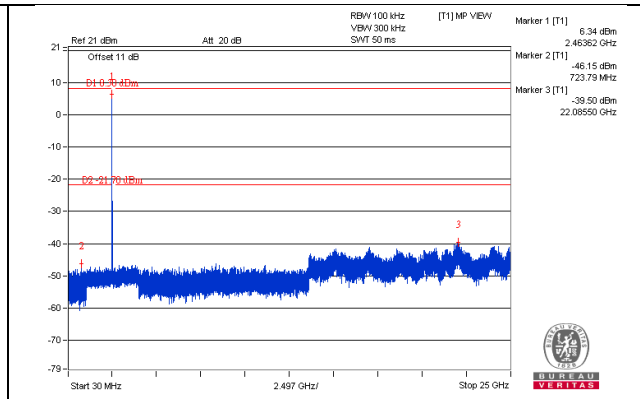
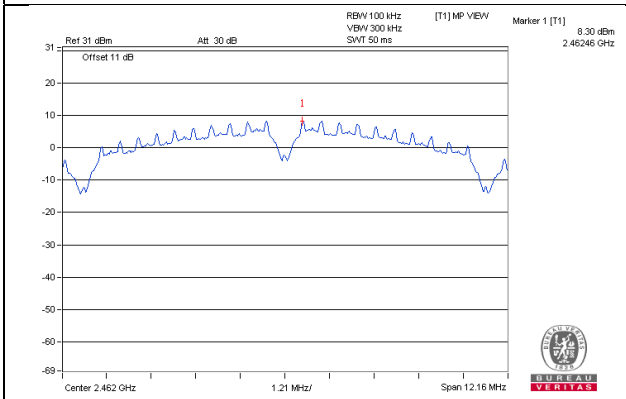

CH 1 Band edge

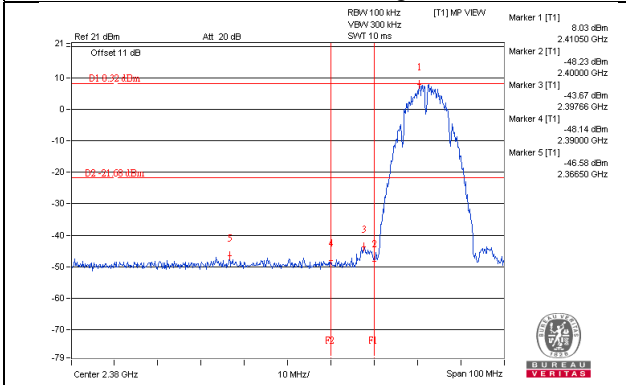

CH 11 Band edge

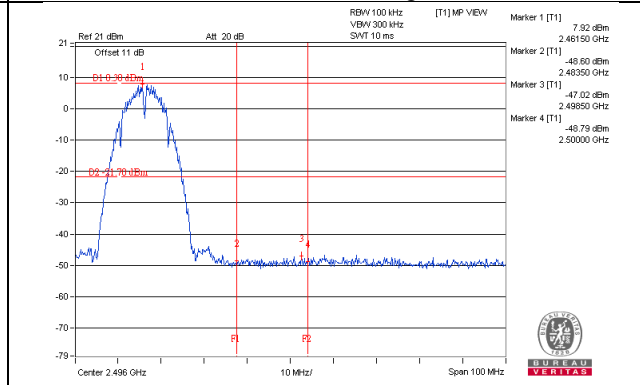

802.11b_Chain 1

CH 1

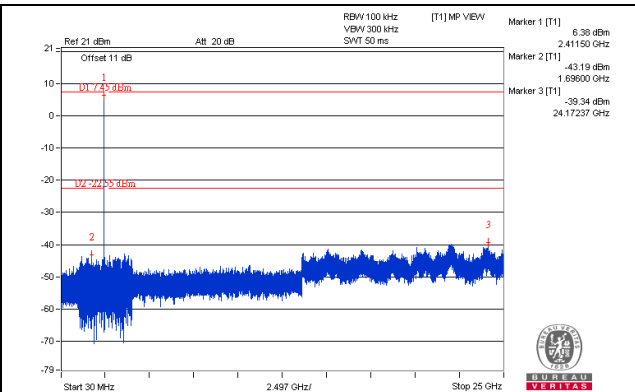
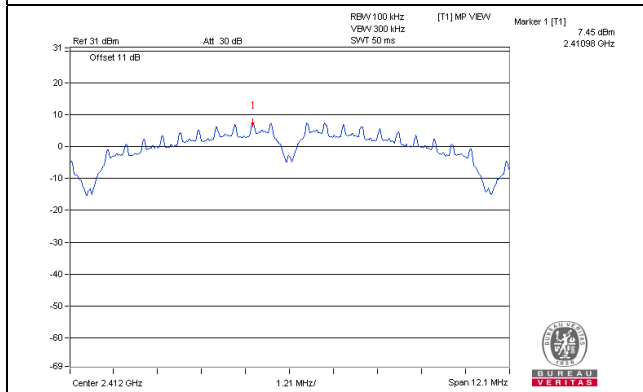

CH 6

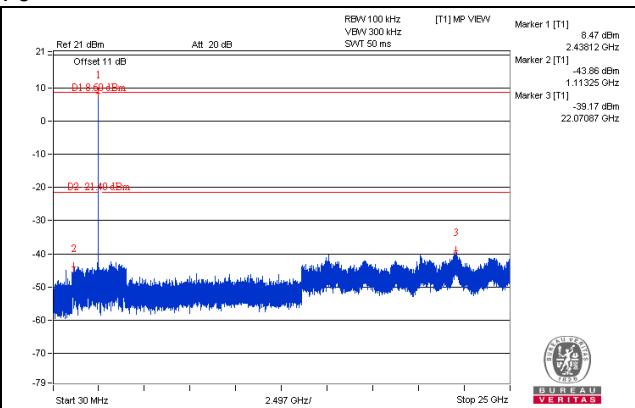
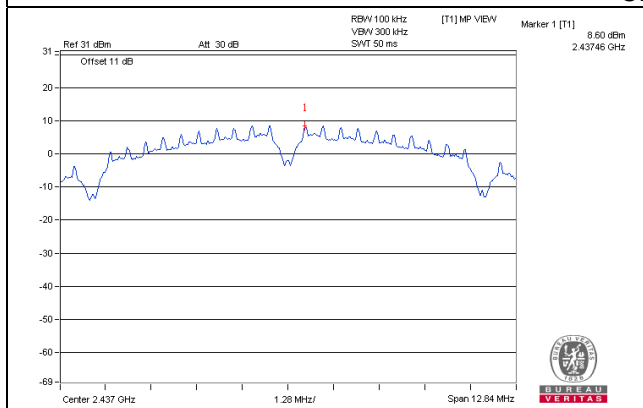

CH 11

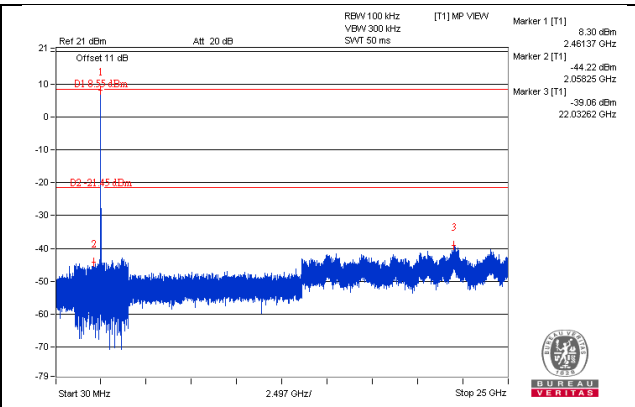
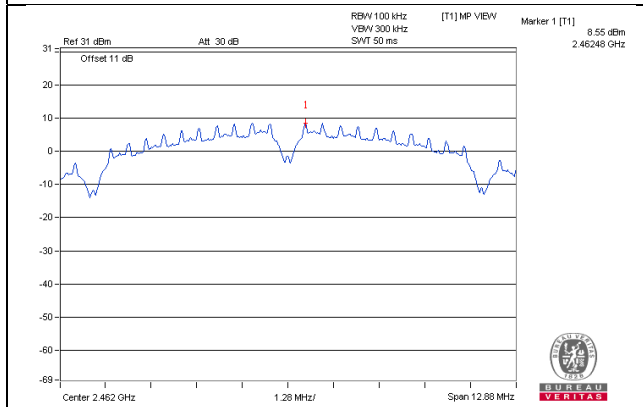

CH 1 Band edge

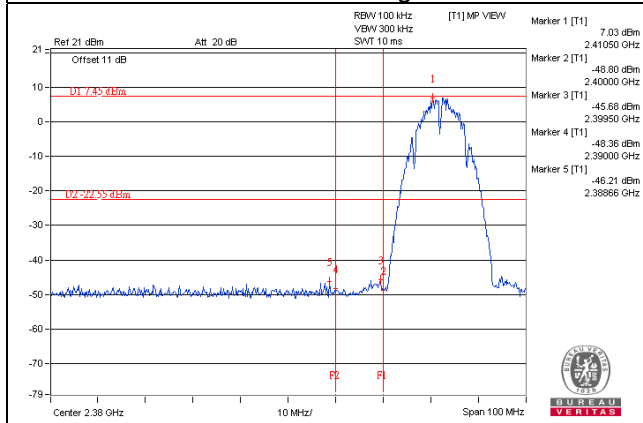

CH 11 Band edge

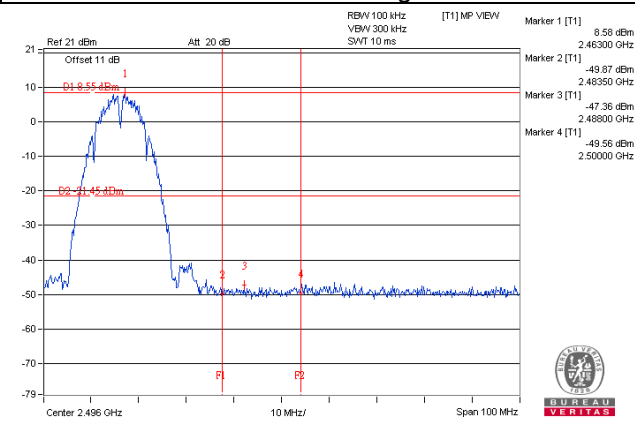

802.11b_Chain 2

CH 1

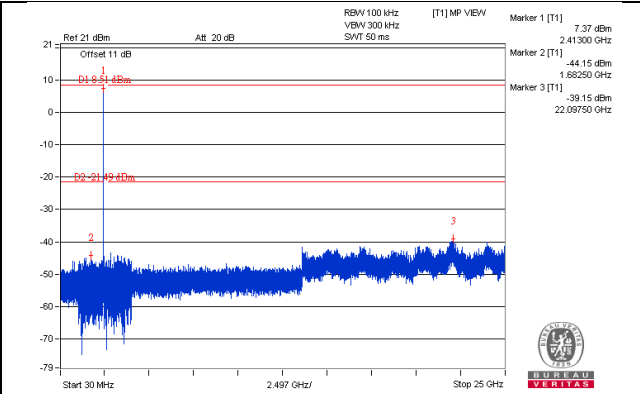
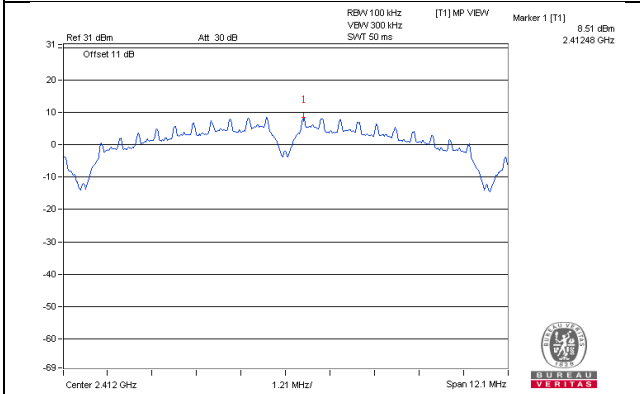

CH 6

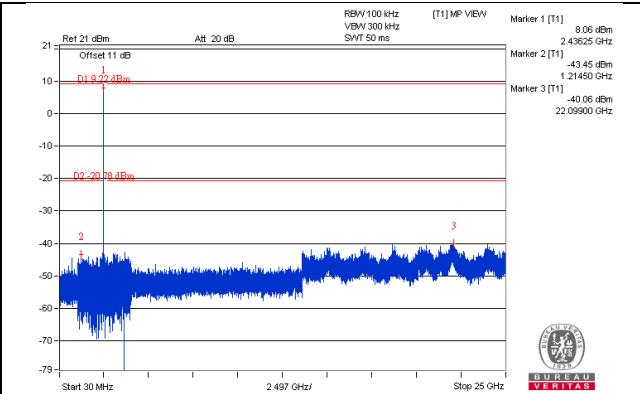
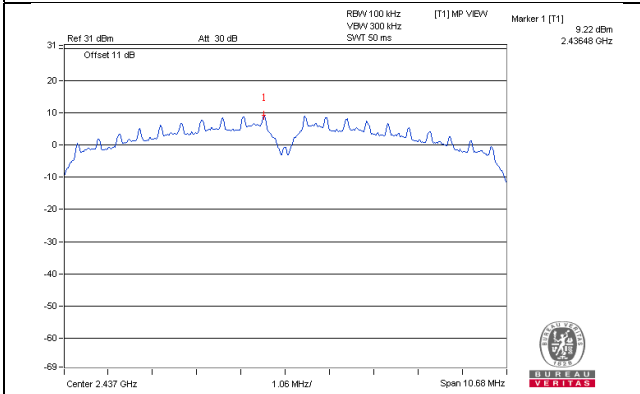

CH 11

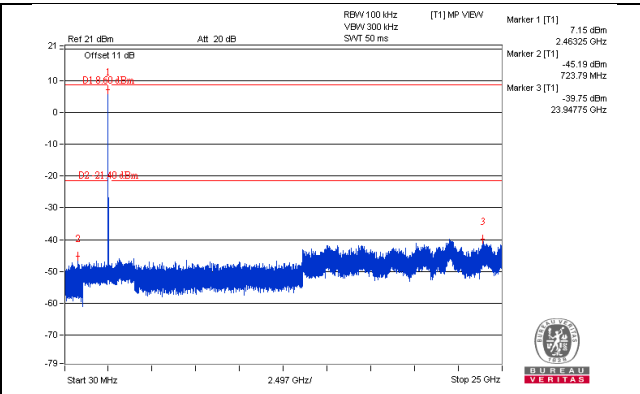
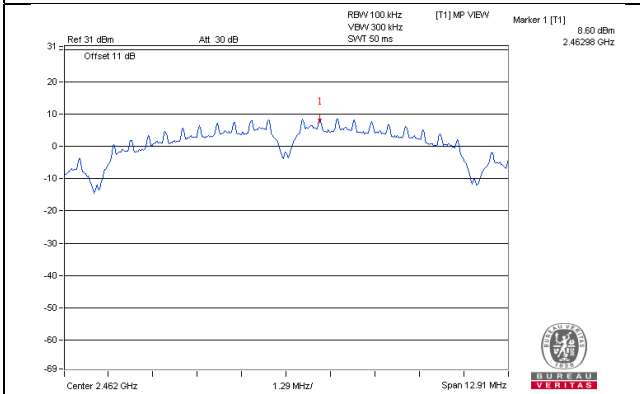

CH 1 Band edge

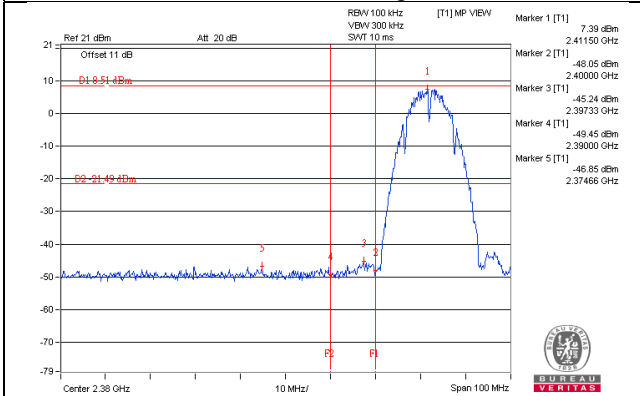

CH 11 Band edge

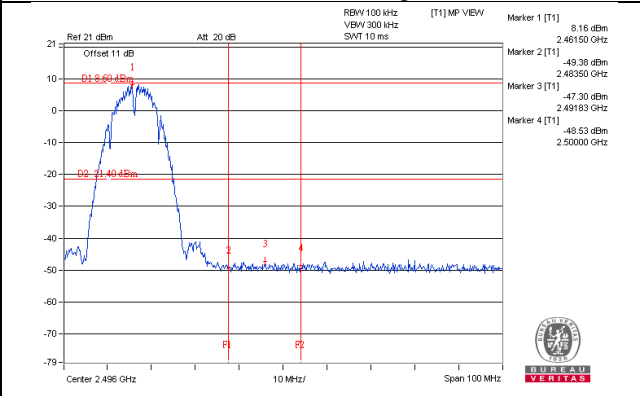

802.11b_Chain 3

CH 1

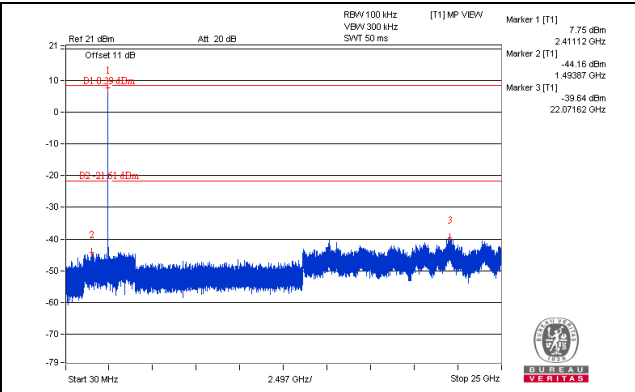
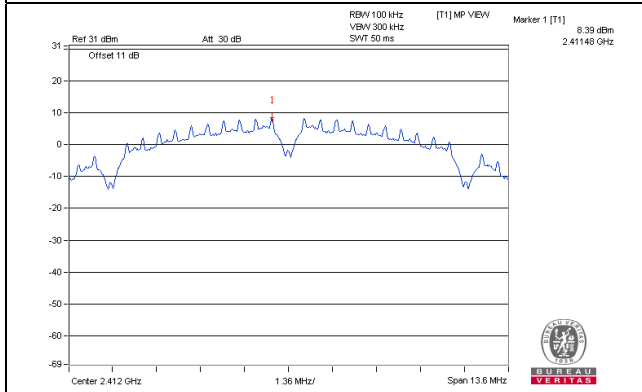

CH 6

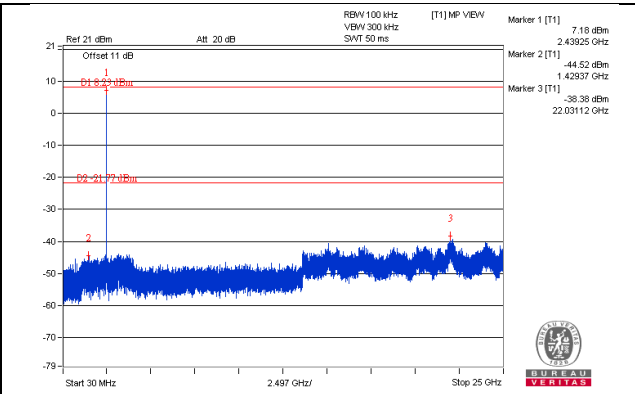
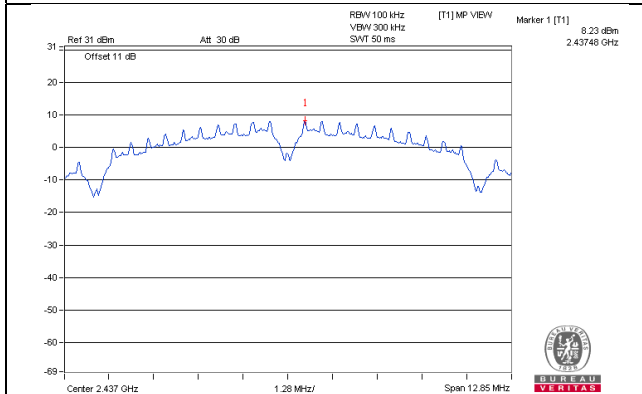

CH 11

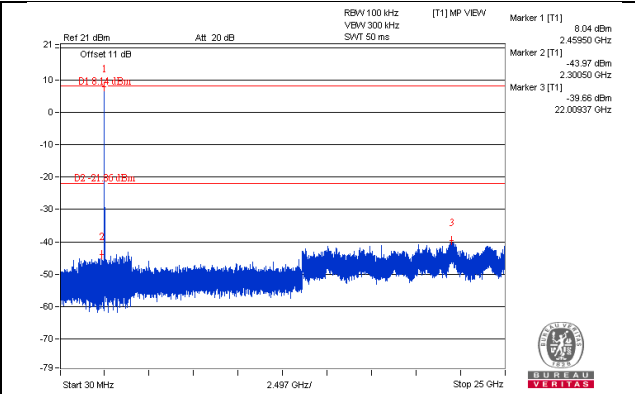
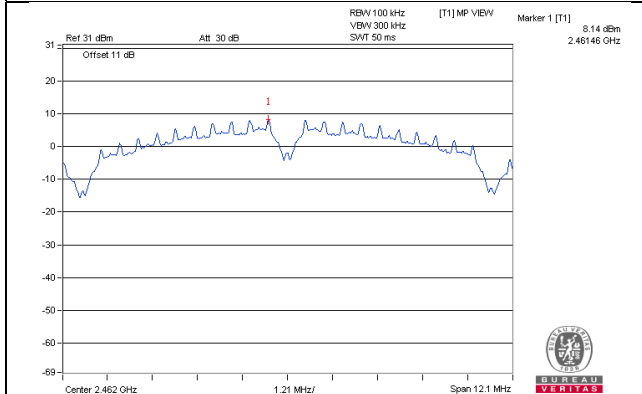

CH 1 Band edge

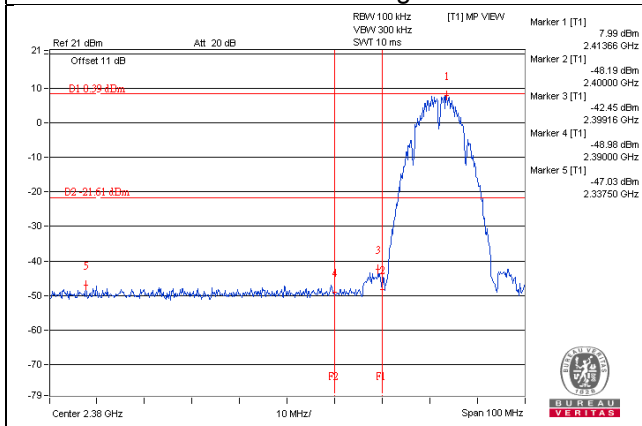

CH 11 Band edge

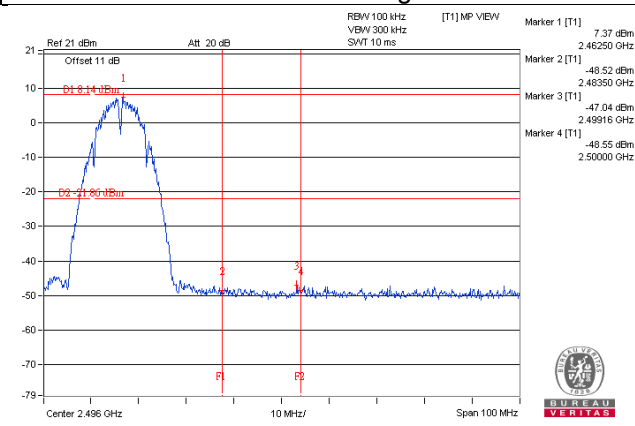

802.11g_Chain 0

CH 1

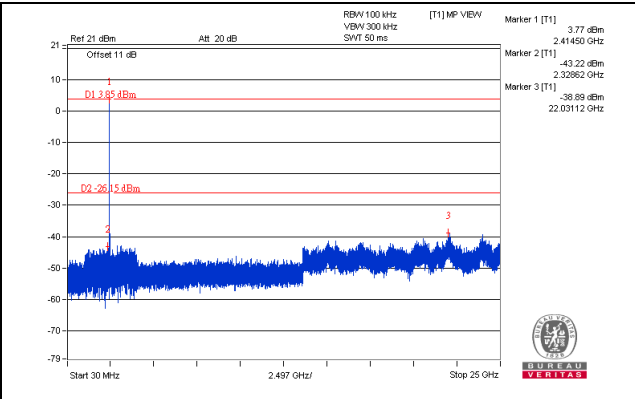
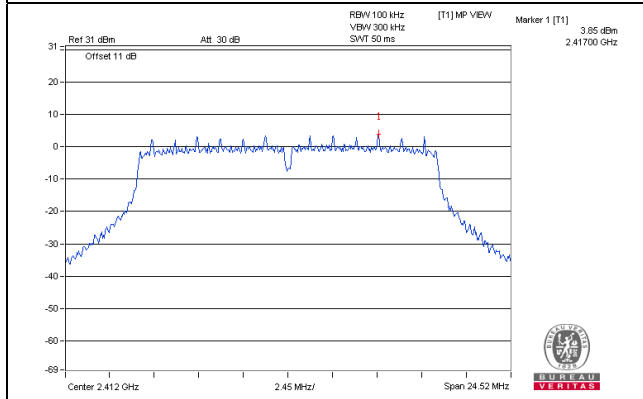

CH 6

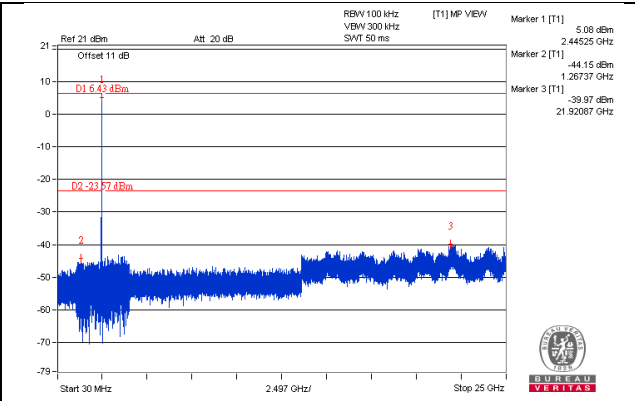
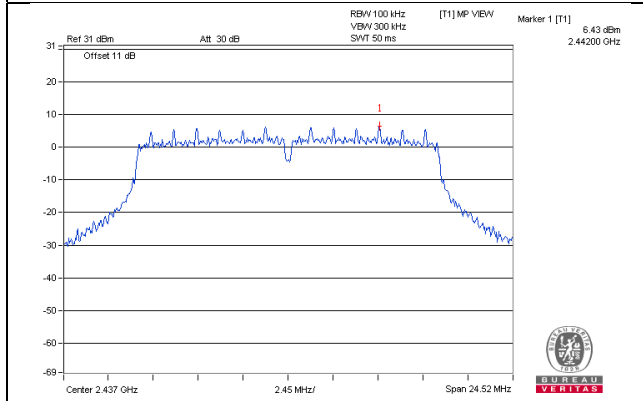

CH 11

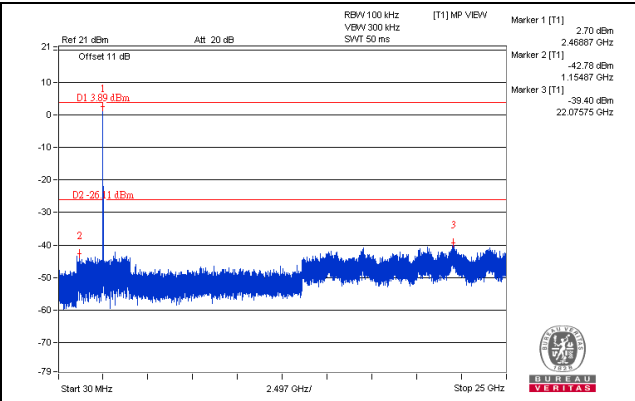
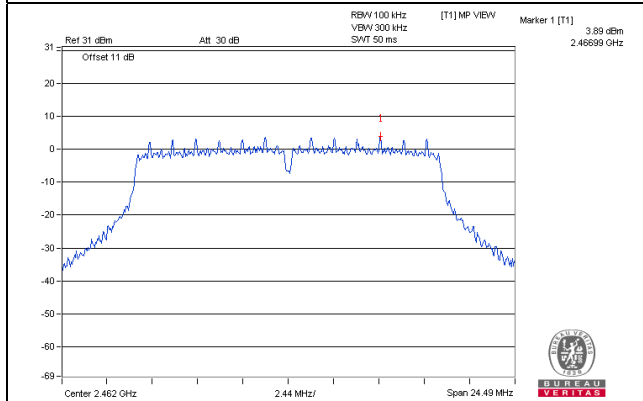

CH 1 Band edge

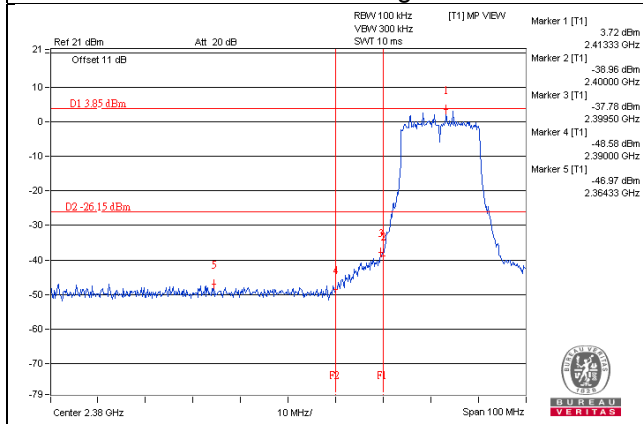

CH 11 Band edge

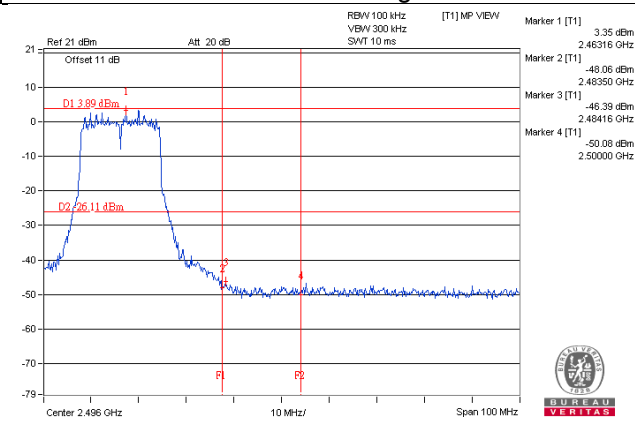

802.11g_Chain 1

CH 1

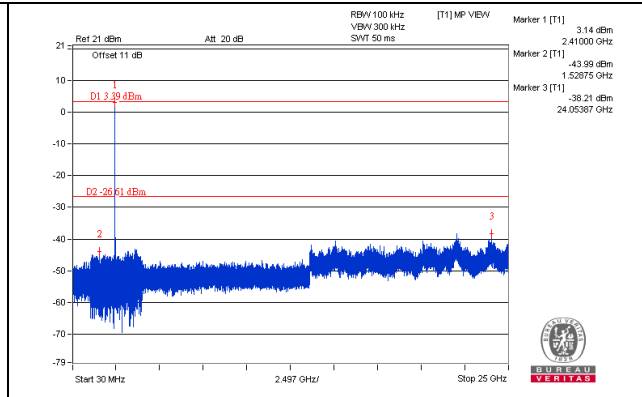
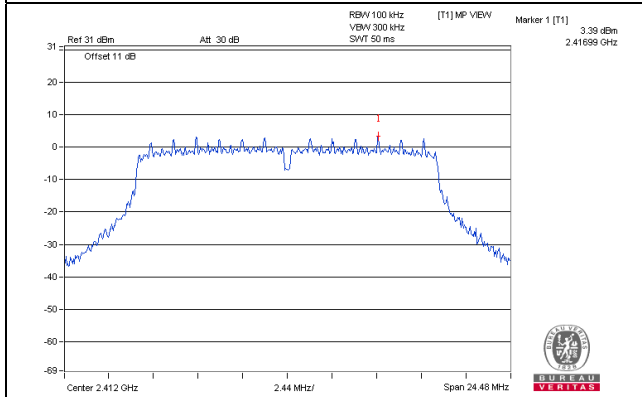

CH 6

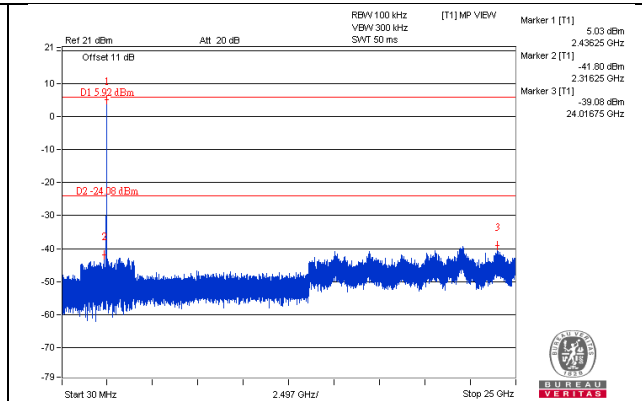
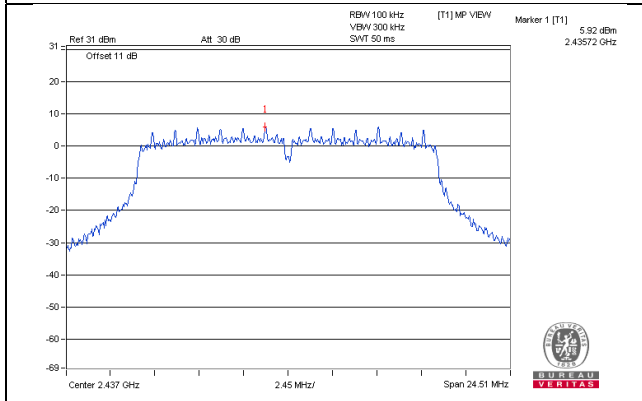

CH 11

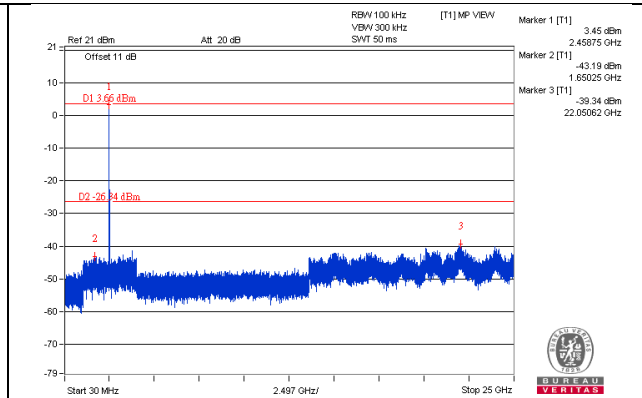
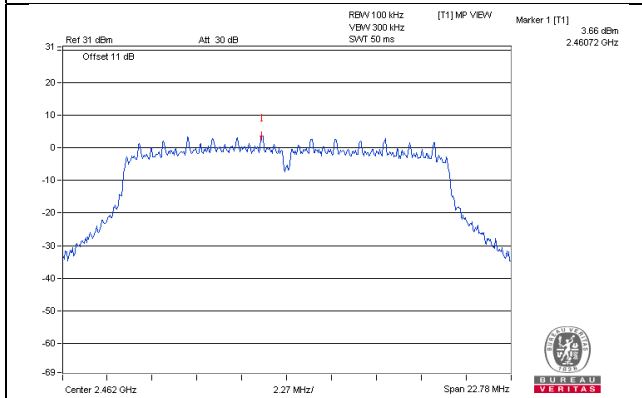

CH 1 Band edge

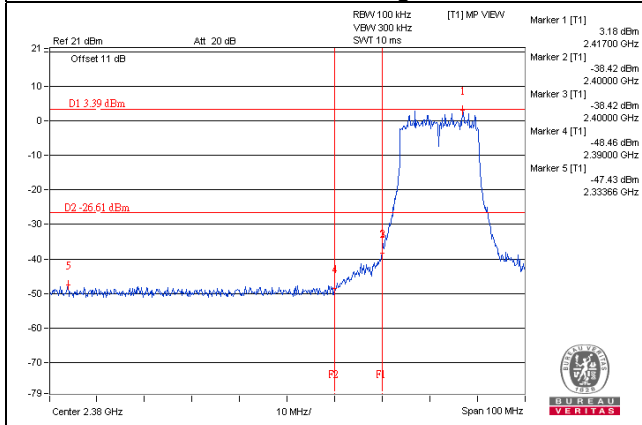

CH 11 Band edge

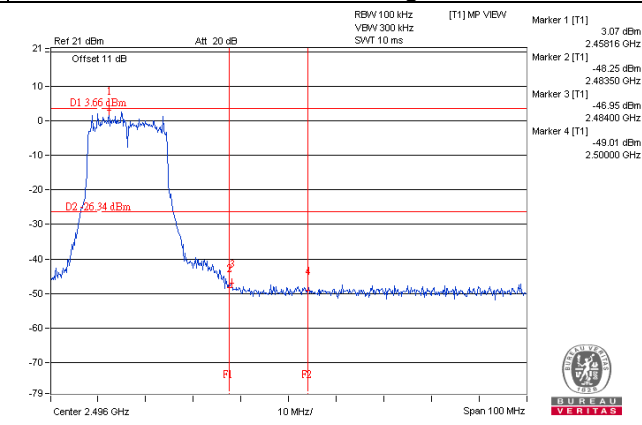

802.11g_Chain 2

CH 1

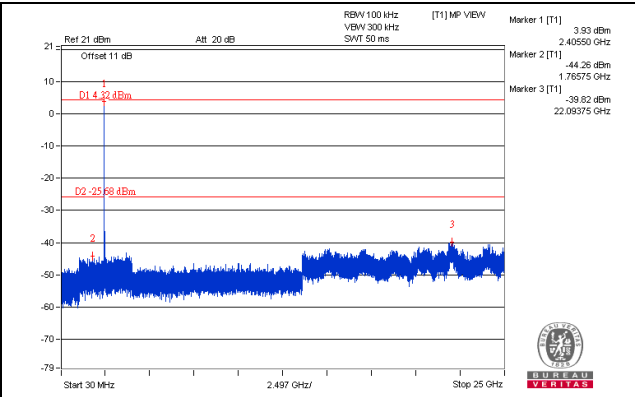
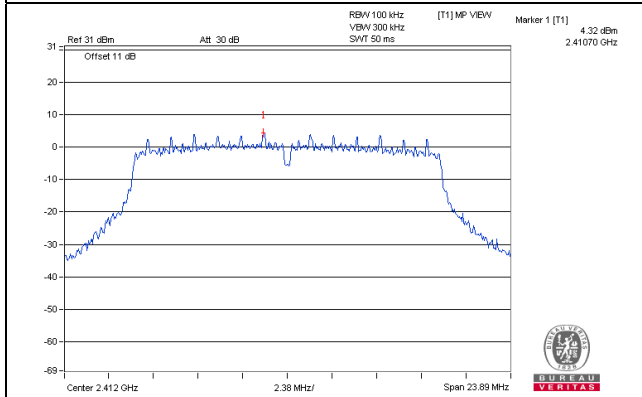

CH 6

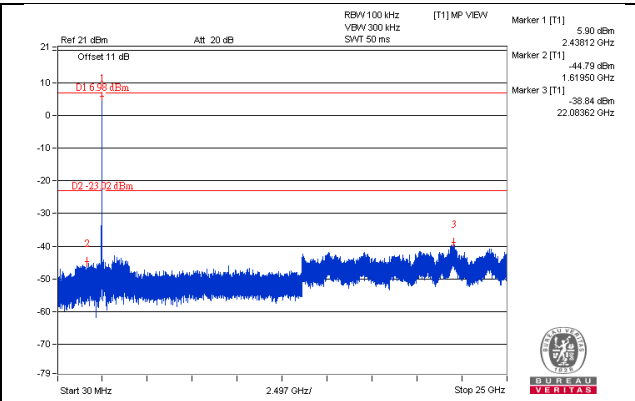
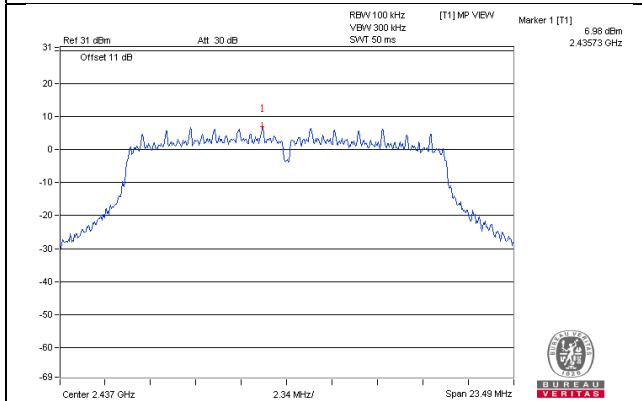

CH 11

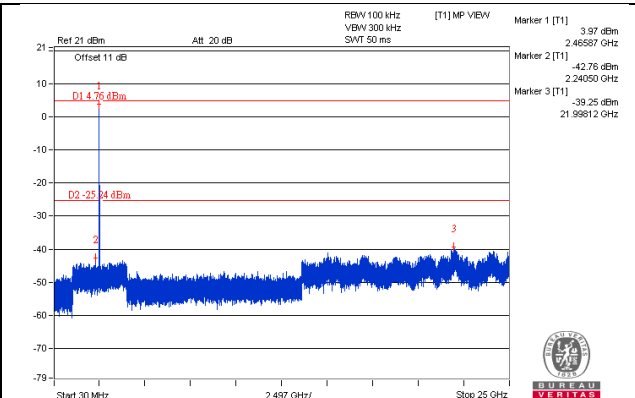
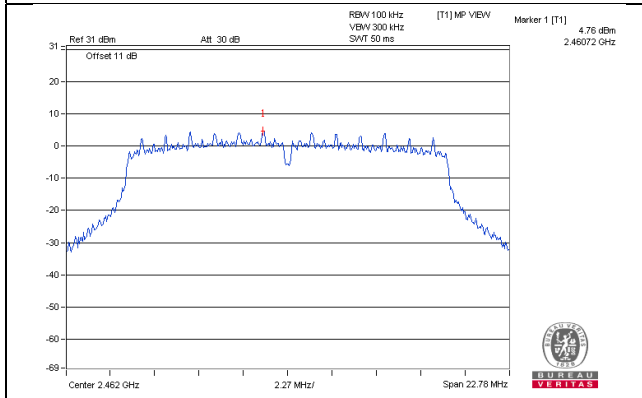

CH 1 Band edge

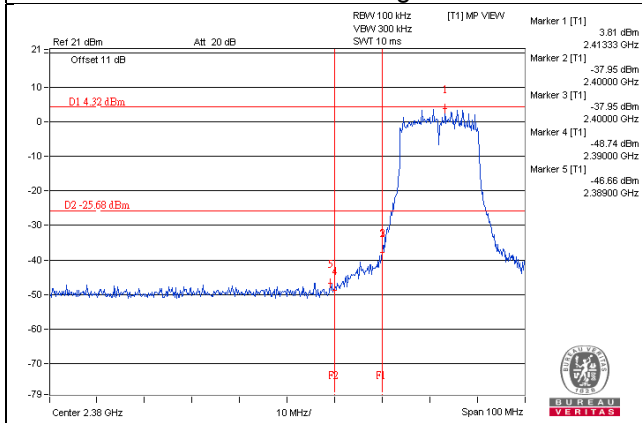

CH 11 Band edge

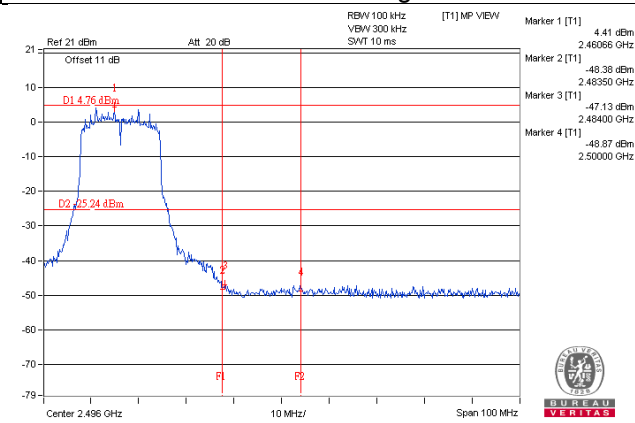

802.11g_Chain 3

CH 1

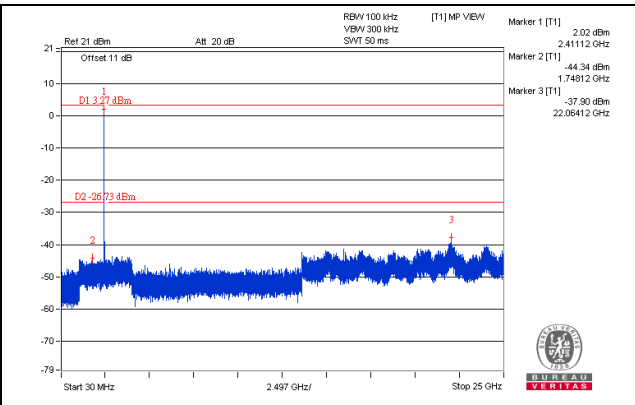
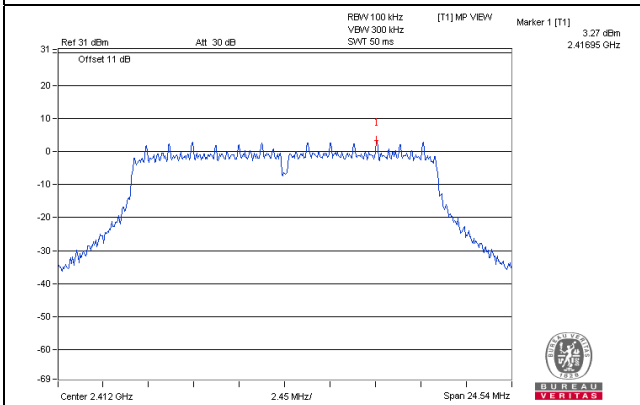

CH 6

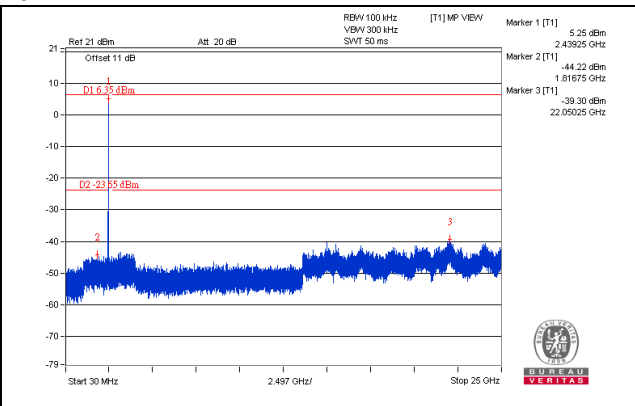
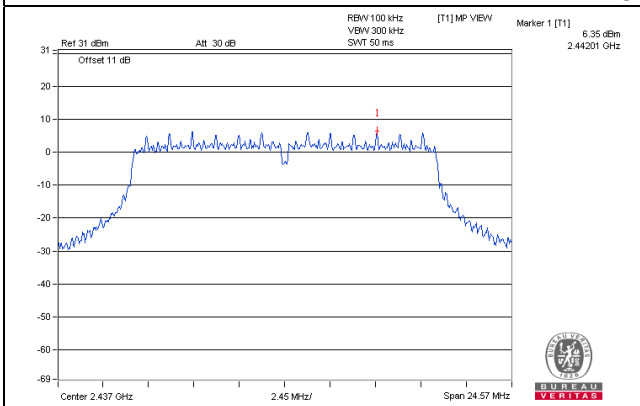

CH 11

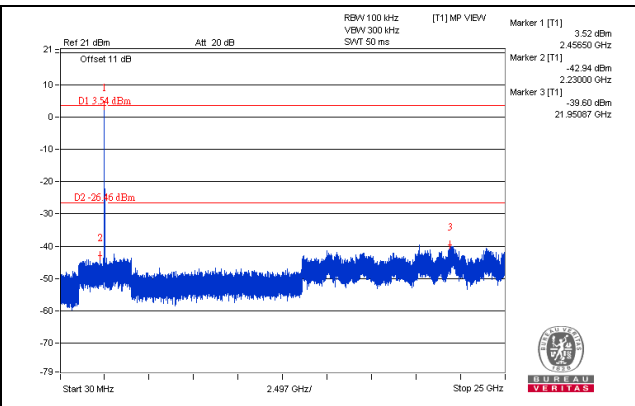
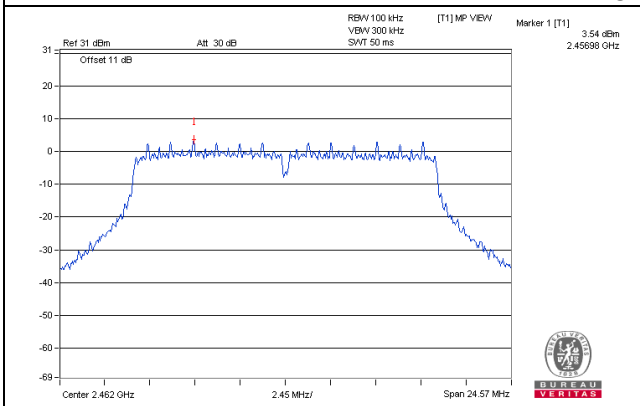

CH 1 Band edge

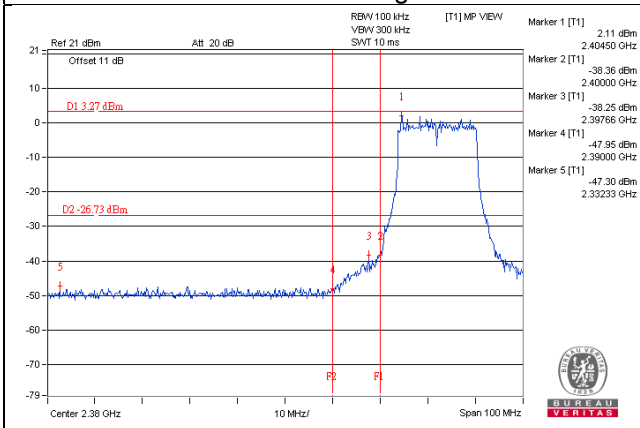

CH 11 Band edge

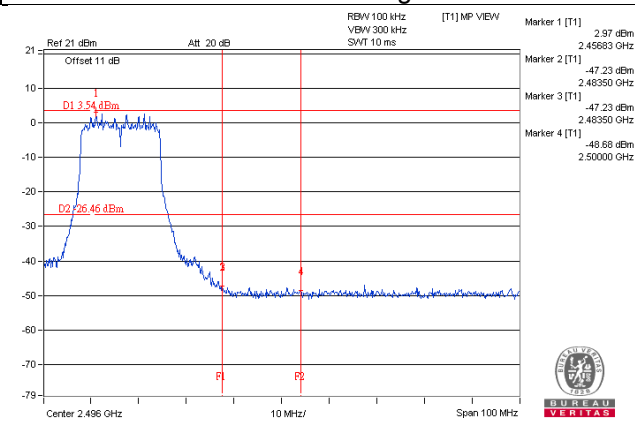

802.11n (HT20)_Chain 0

CH 1

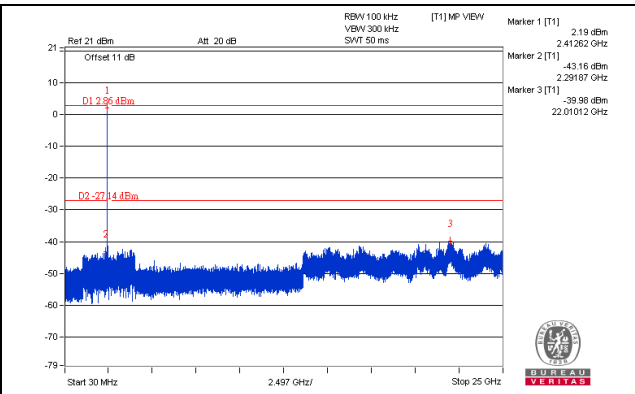
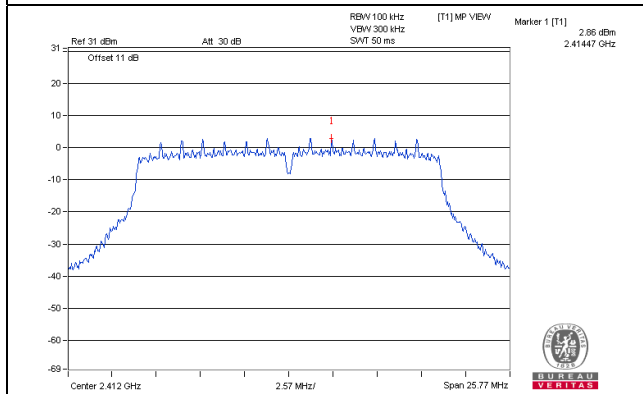

CH 6

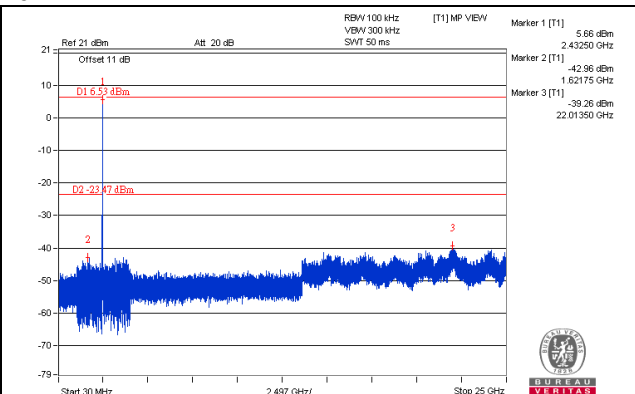
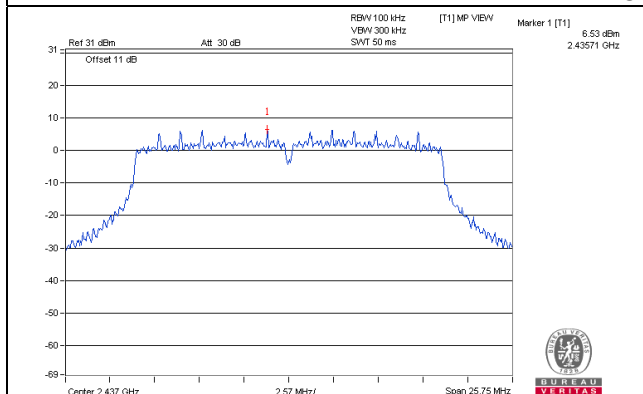

CH 11

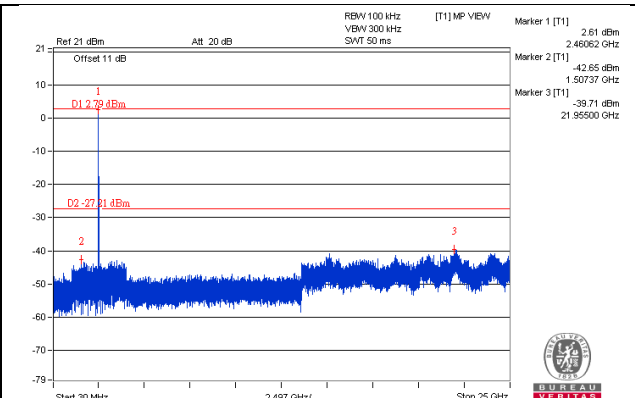
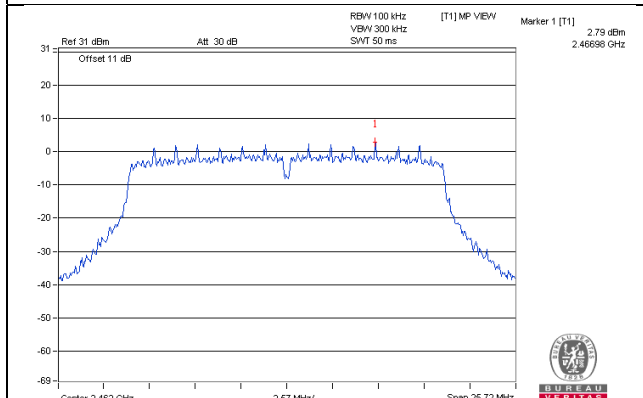

CH 1 Band edge

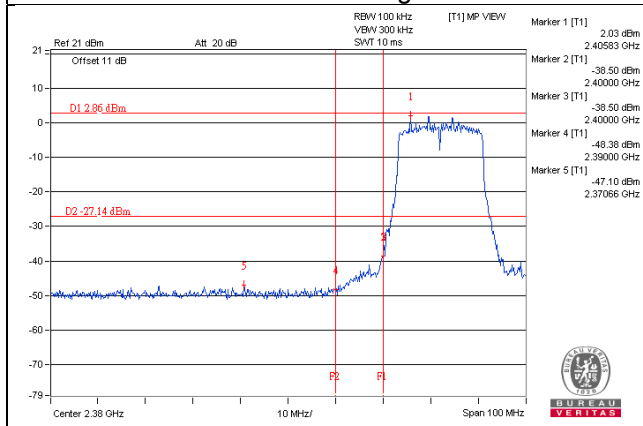

CH 11 Band edge

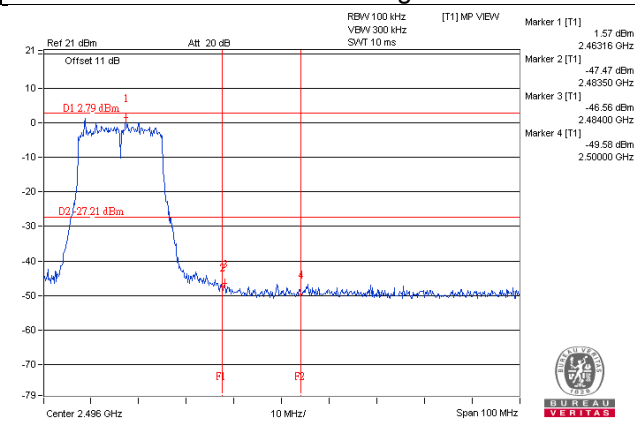

802.11n (HT20)_Chain 1

CH 1

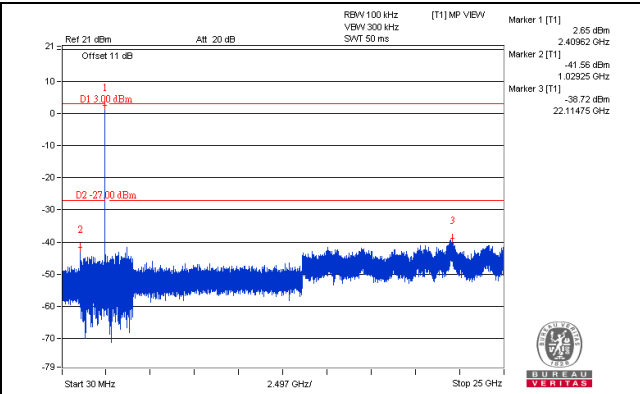
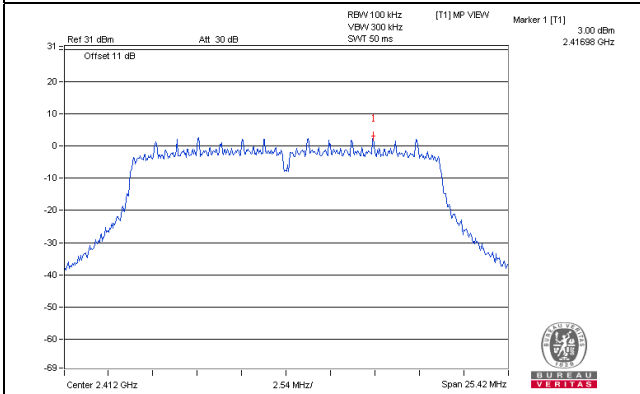

CH 6

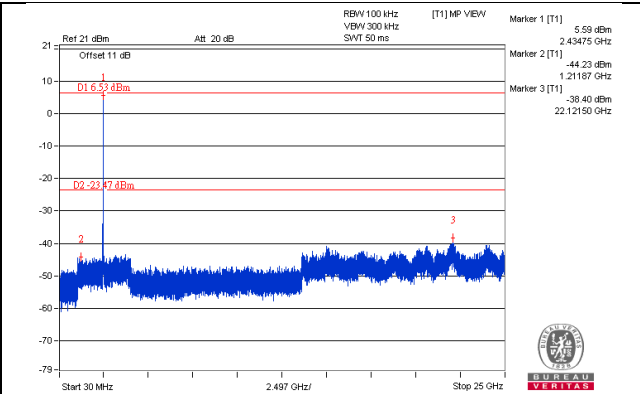
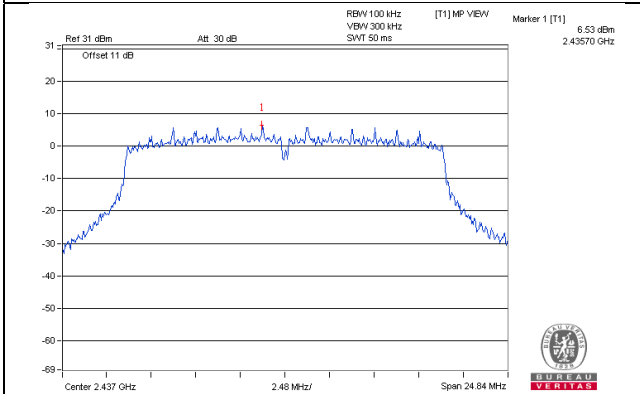

CH 11

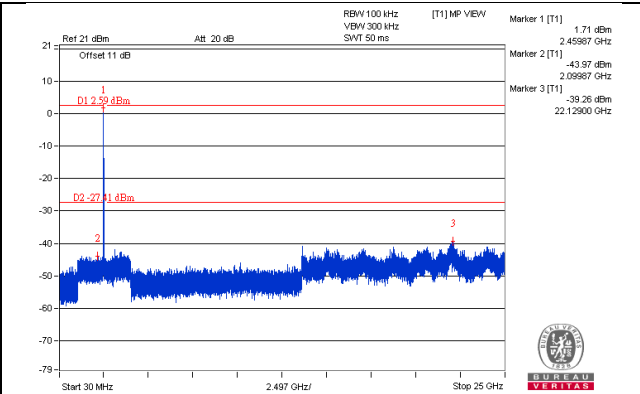
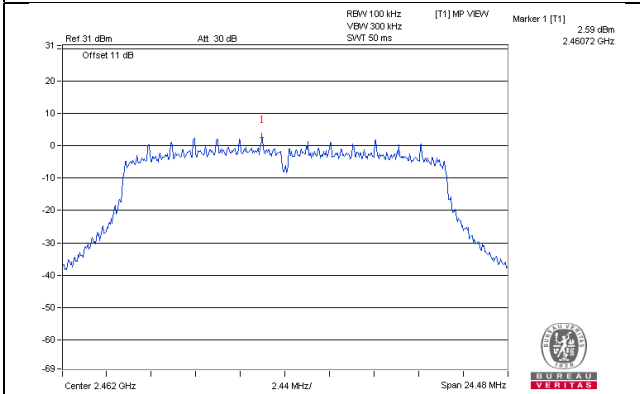

CH 1 Band edge

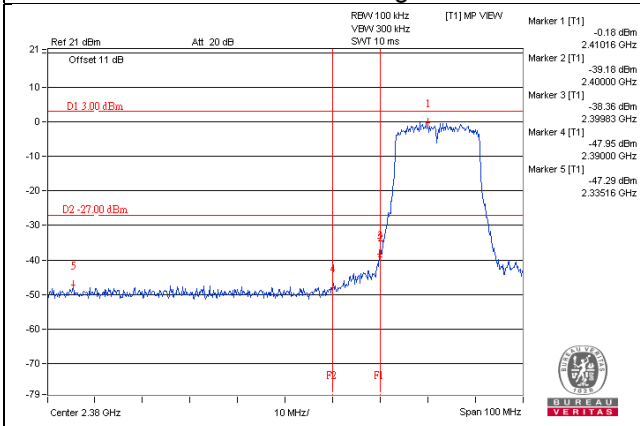

CH 11 Band edge

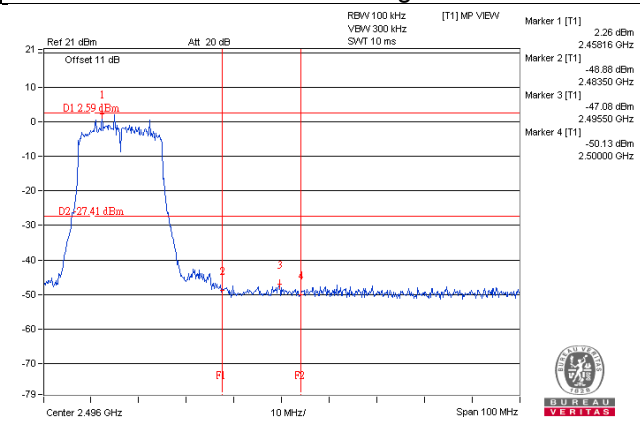

802.11n (HT20)_Chain 2

CH 1

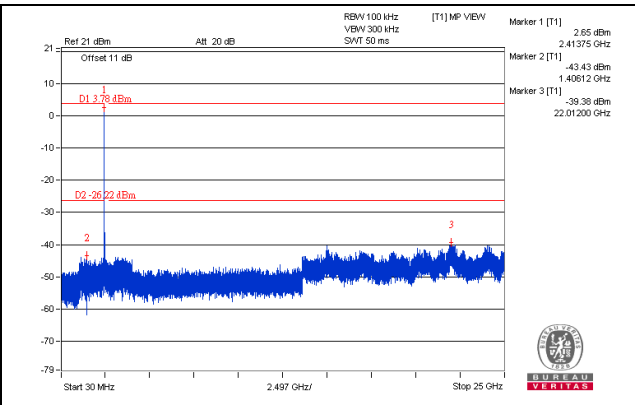
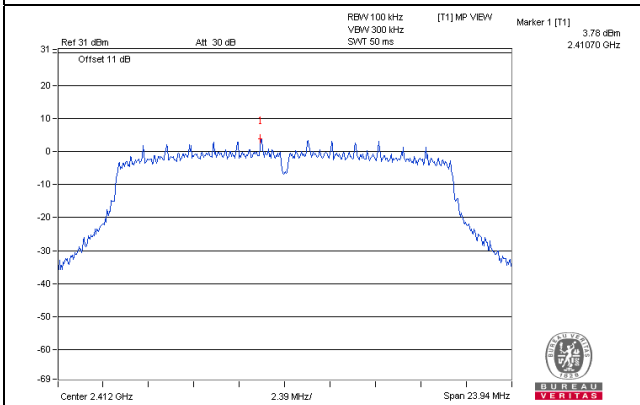

CH 6

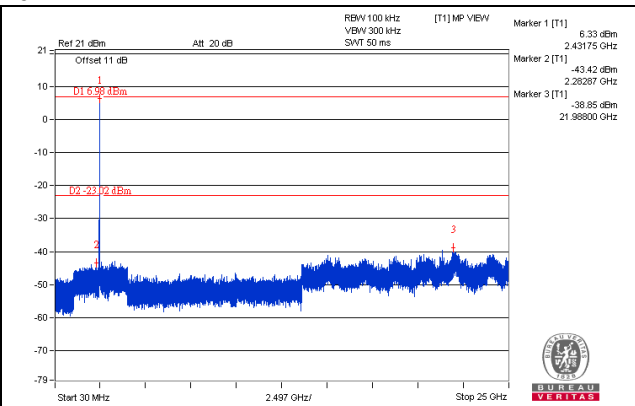
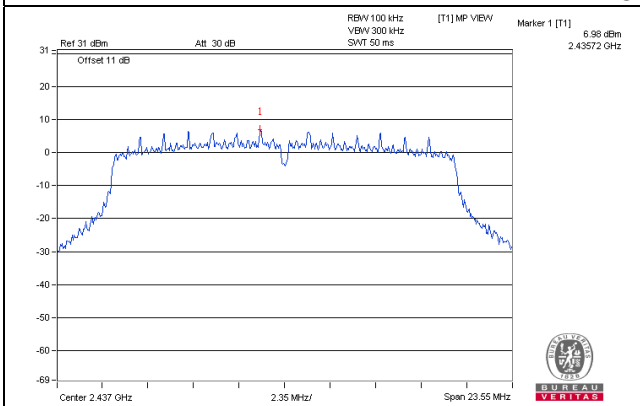

CH 11

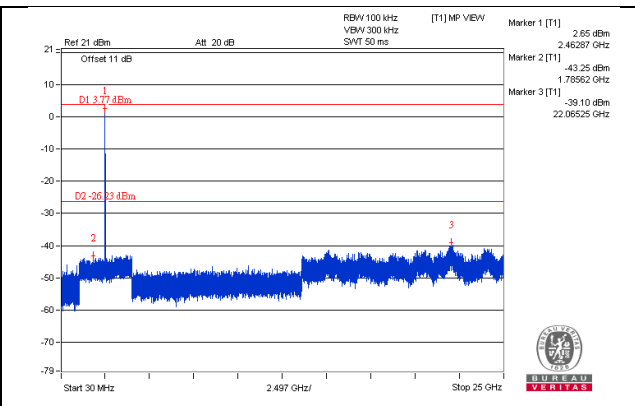
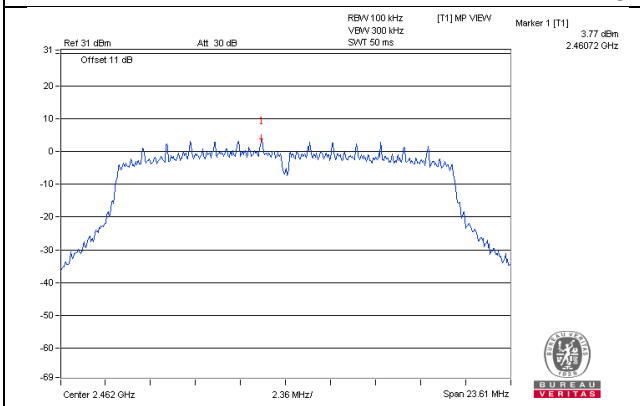

CH 1 Band edge

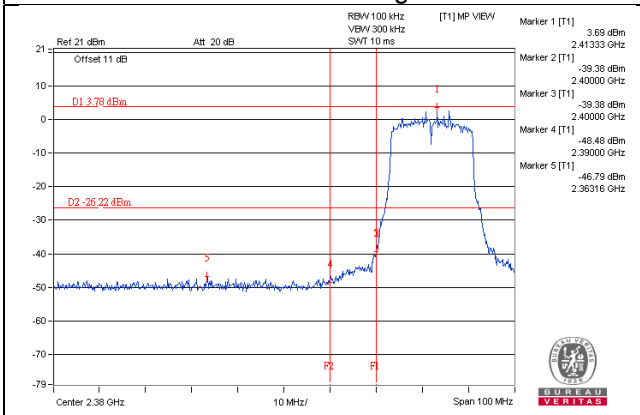

CH 11 Band edge

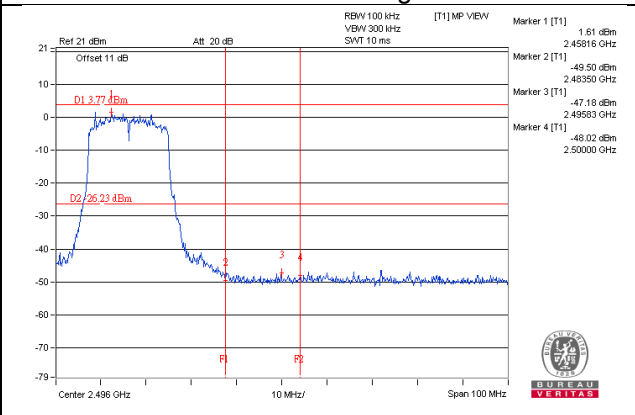

802.11n (HT20)_Chain 3

CH 1

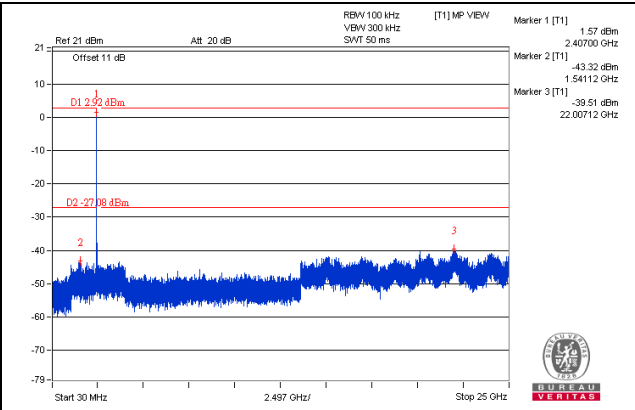
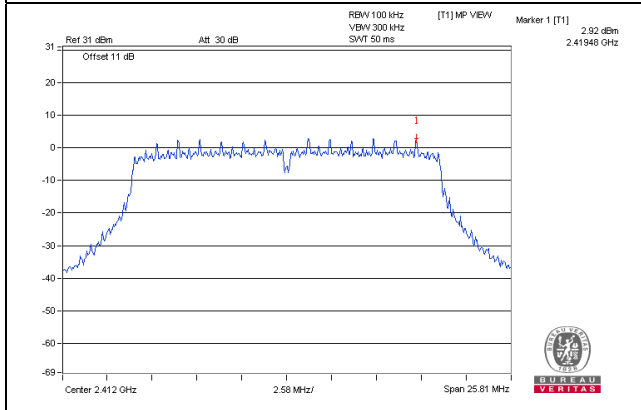

CH 6

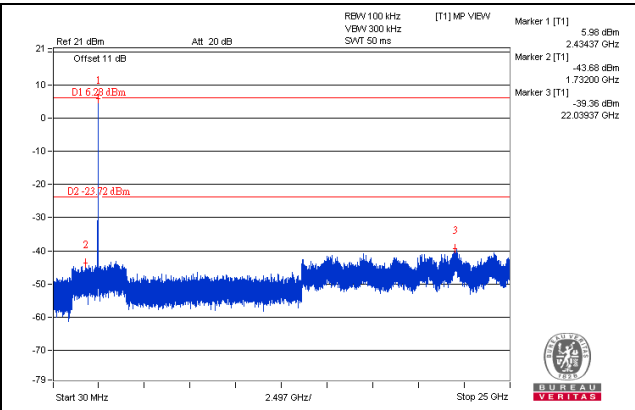
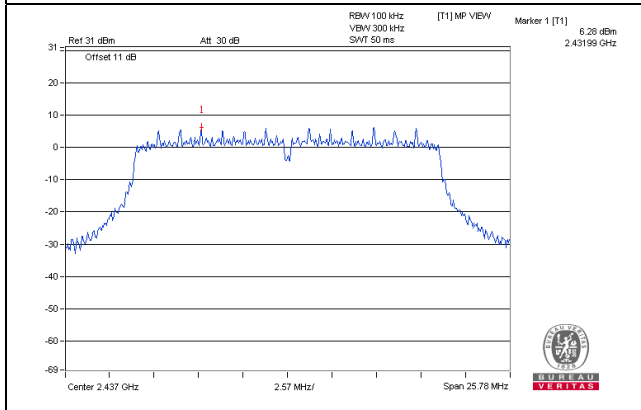

CH 11

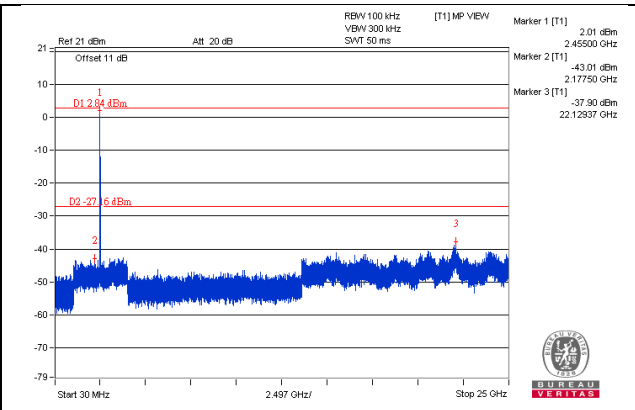
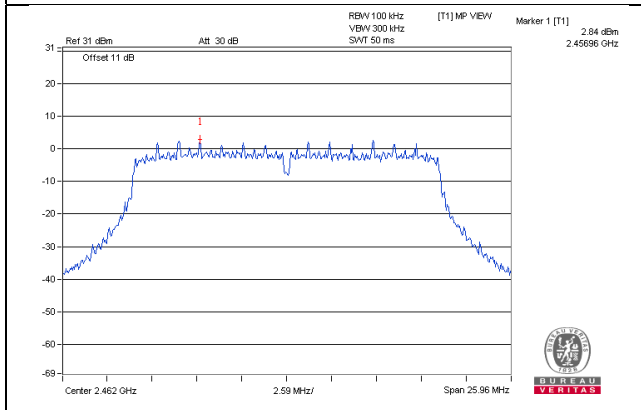

CH 1 Band edge

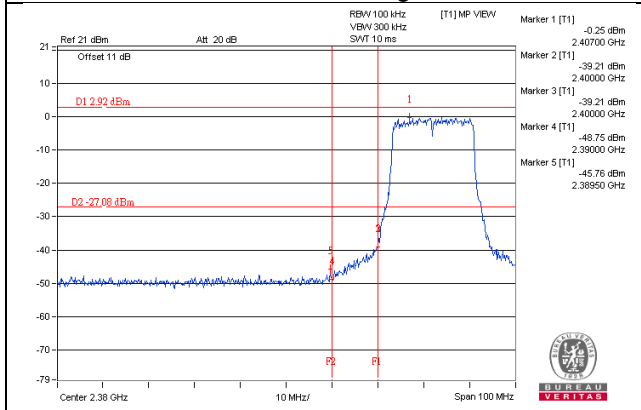

CH 11 Band edge

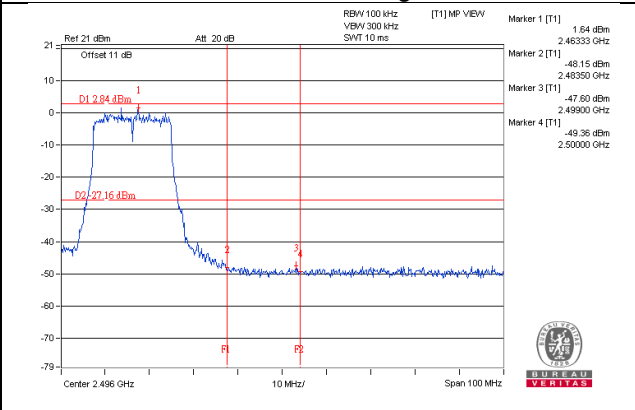

802.11n (HT40) Chain 0

CH 3

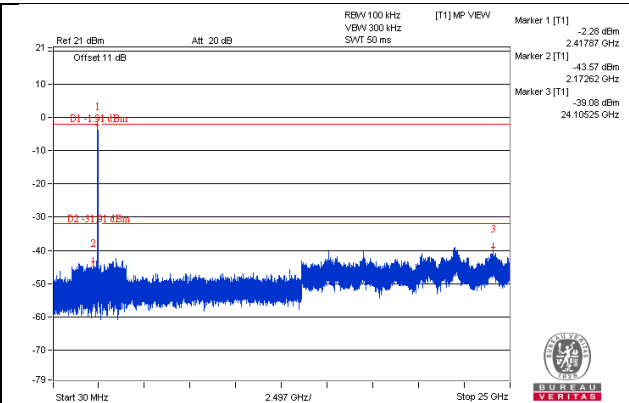
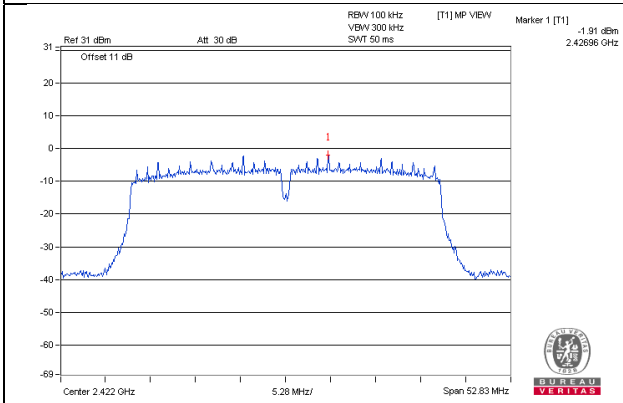

CH 6

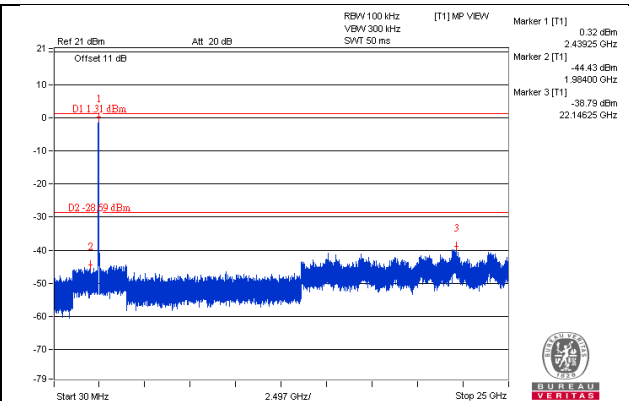
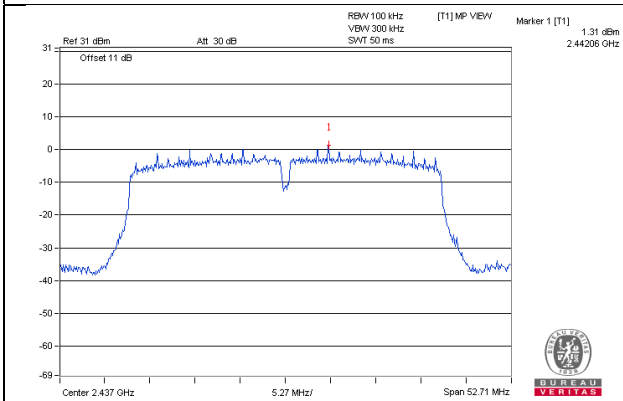

CH 9

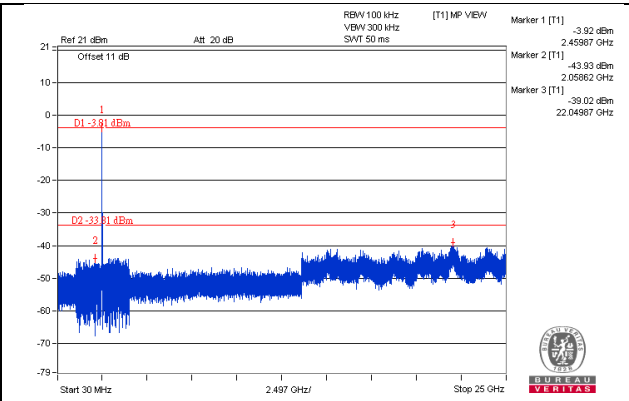
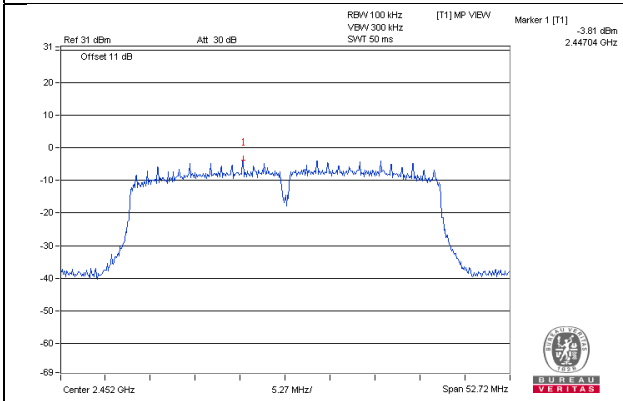

CH 3 Band edge

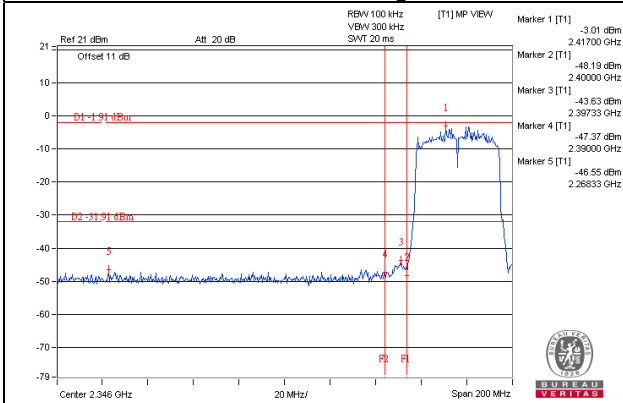

CH 9 Band edge

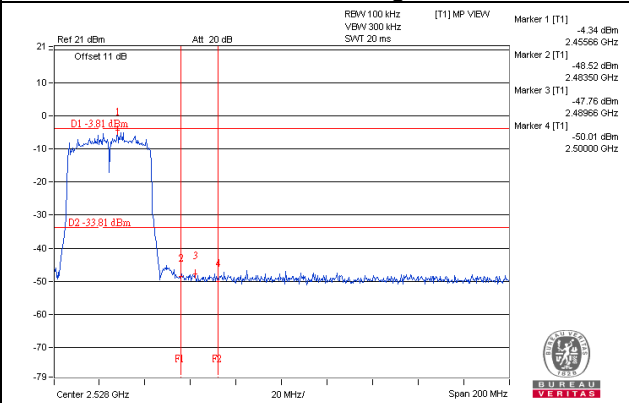

802.11n (HT40)_Chain 1

CH 3

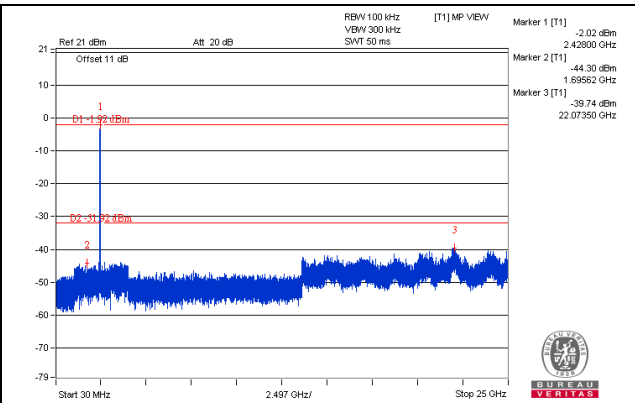
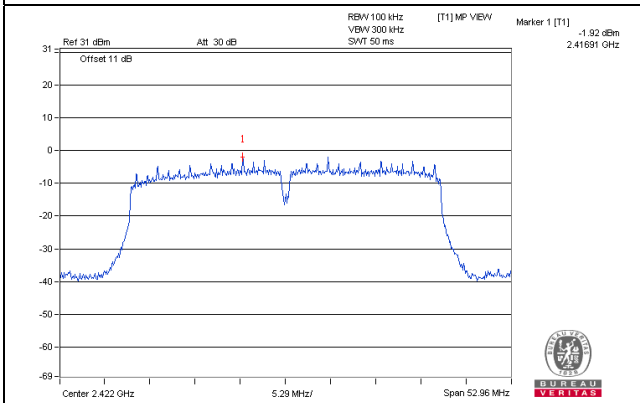

CH 6

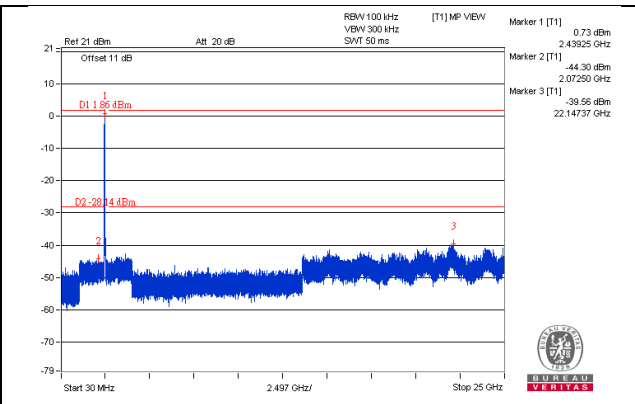
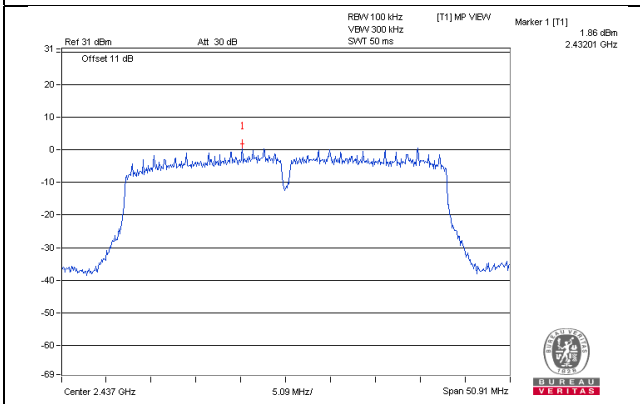

CH 9

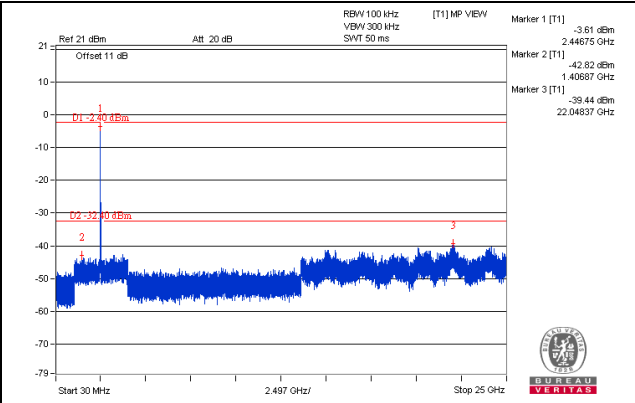
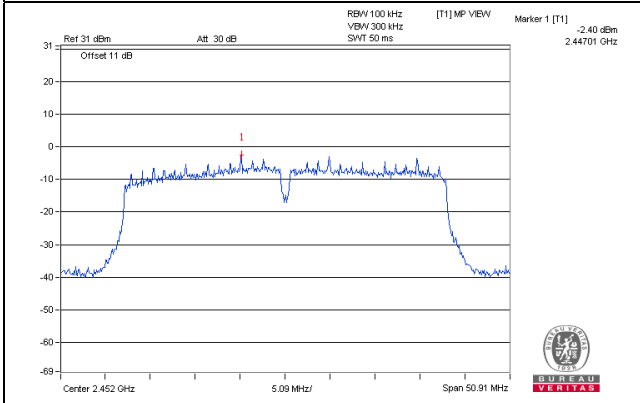

CH 3 Band edge

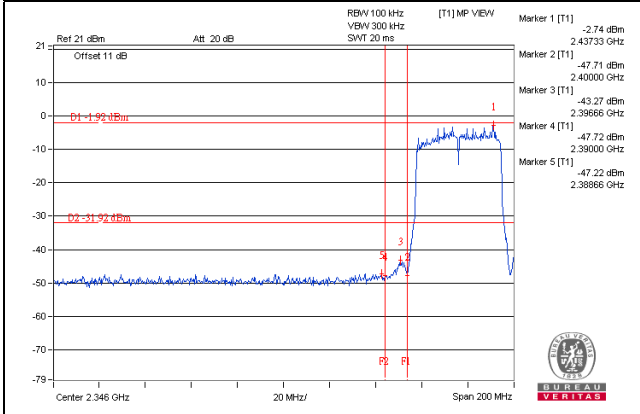

CH 9 Band edge

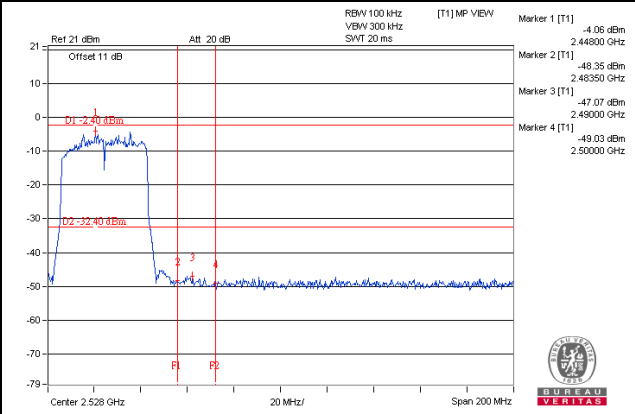

802.11n (HT40)_Chain 2

CH 3

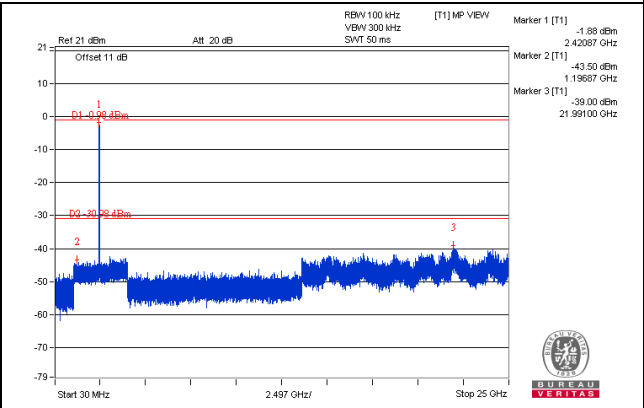
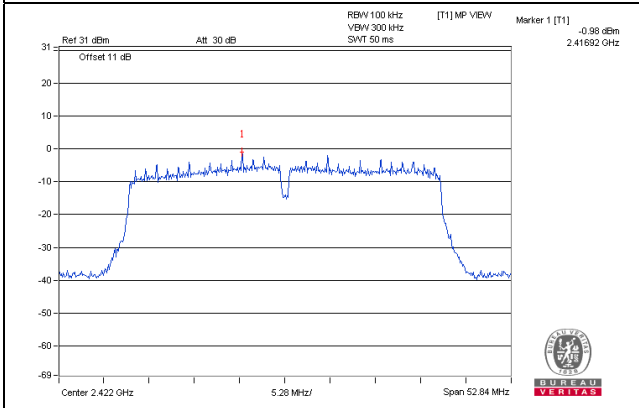

CH 6

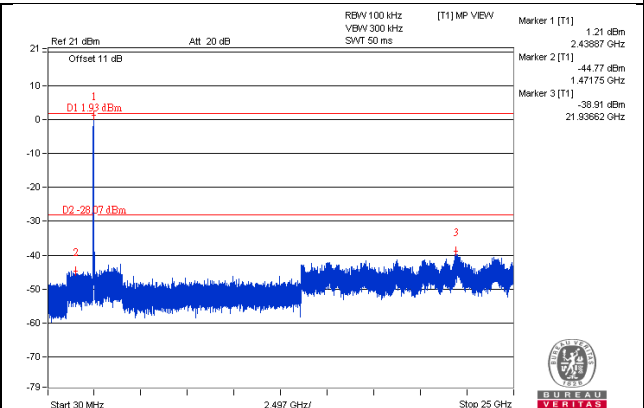
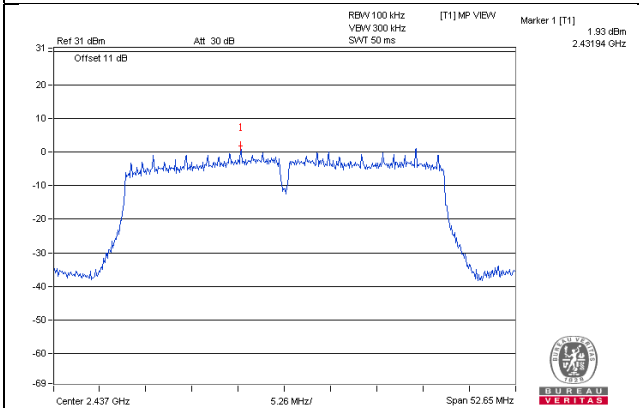

CH 9

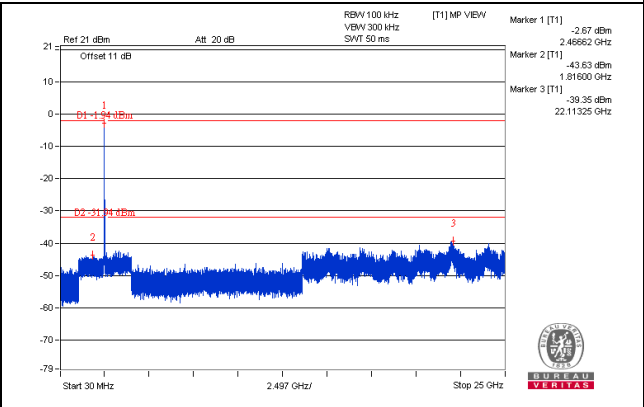
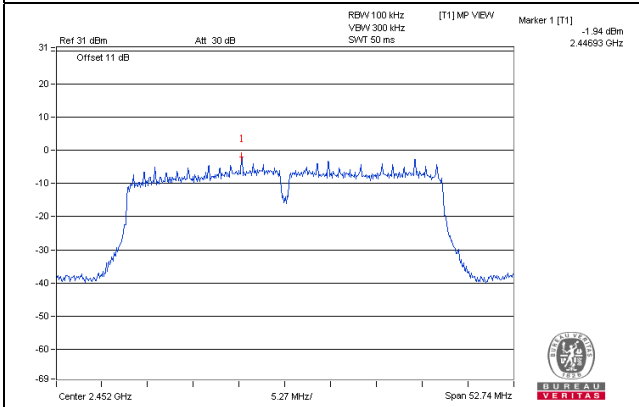

CH 3 Band edge

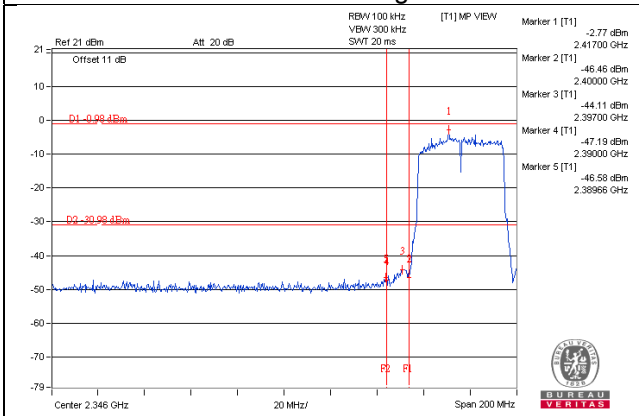

CH 9 Band edge

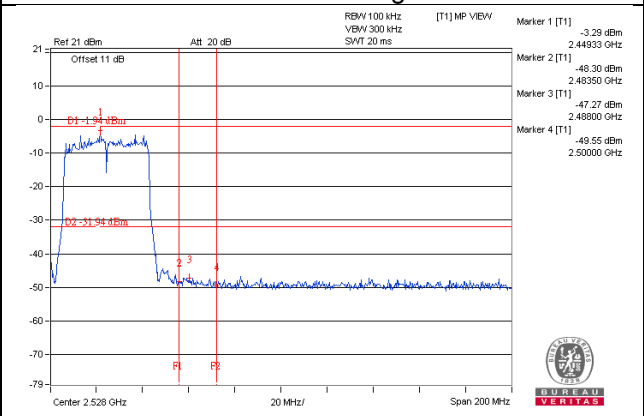

802.11n (HT40)_Chain 3

CH 3

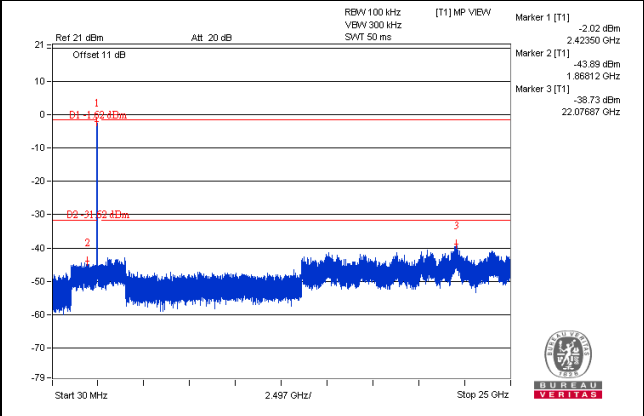
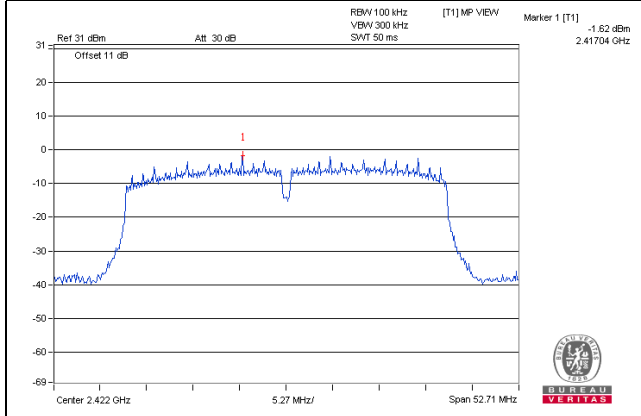

CH 6

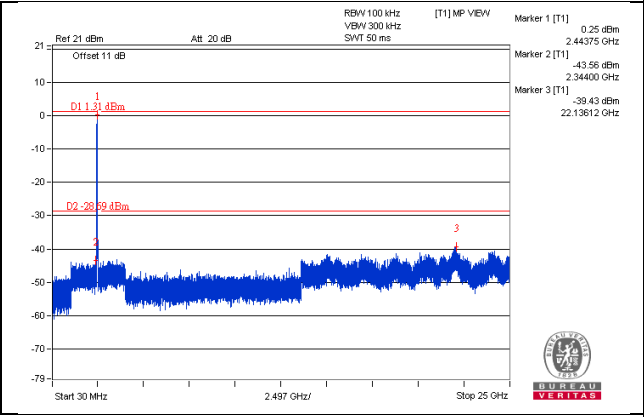
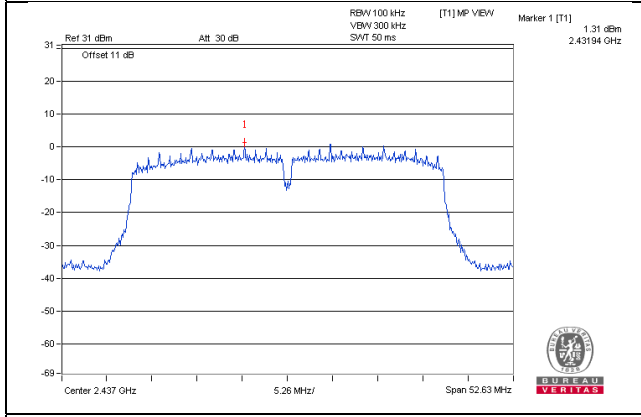

CH 9

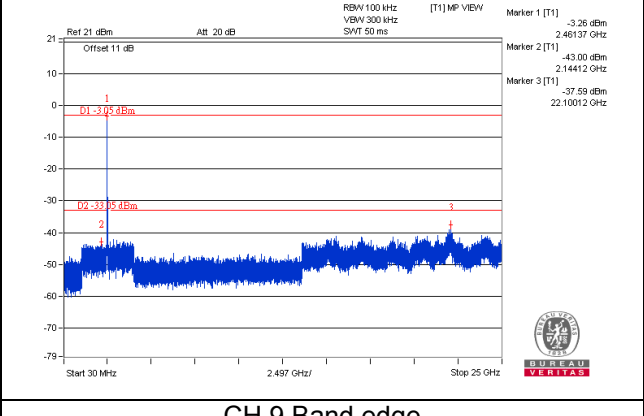
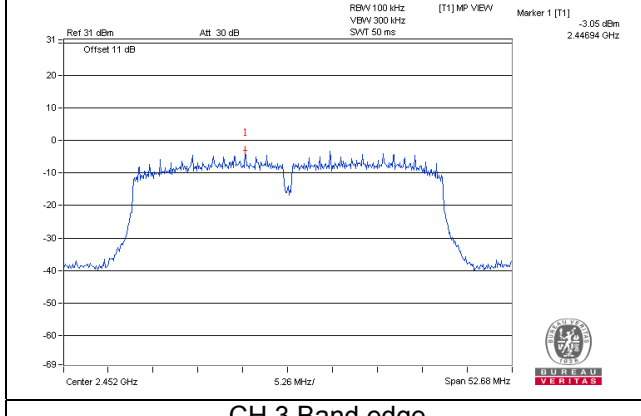

CH 3 Band edge

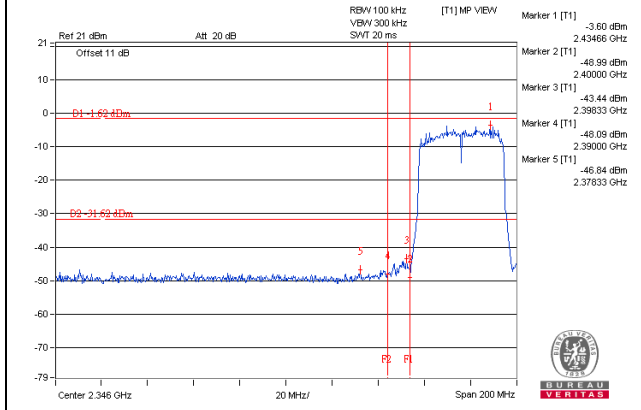

CH 9 Band edge

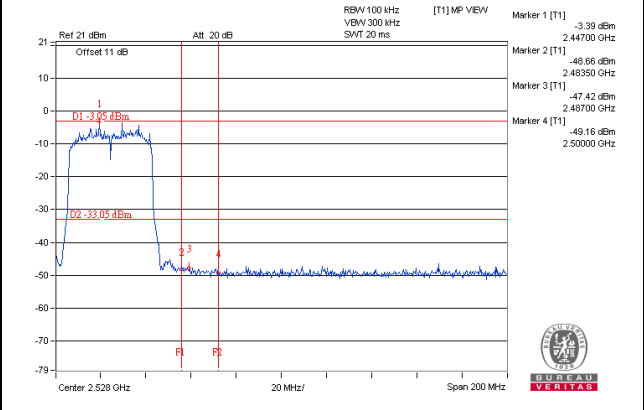

Test Mode E
802.11b

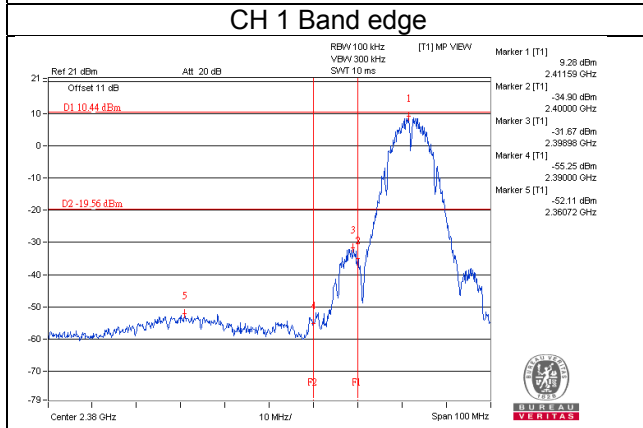
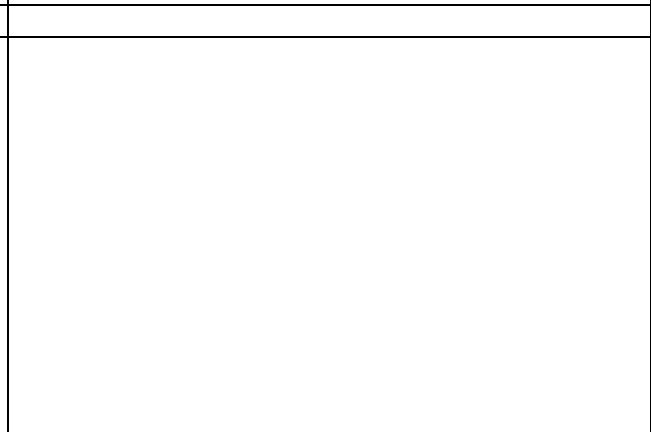
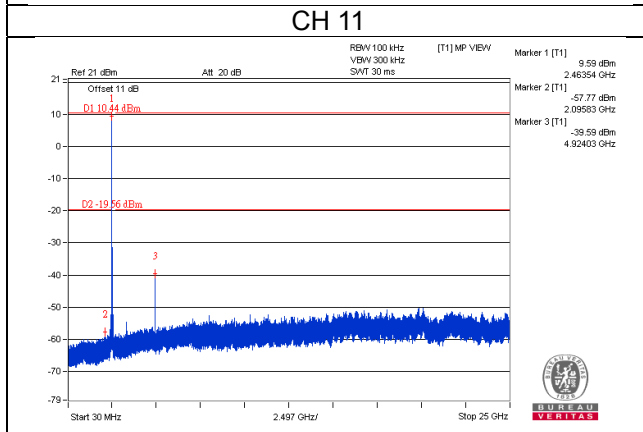
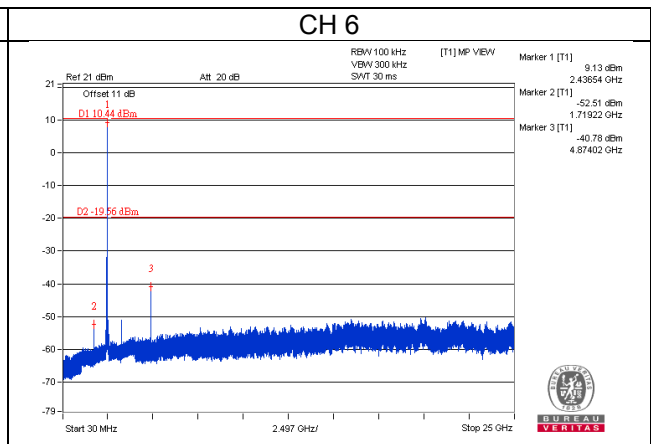
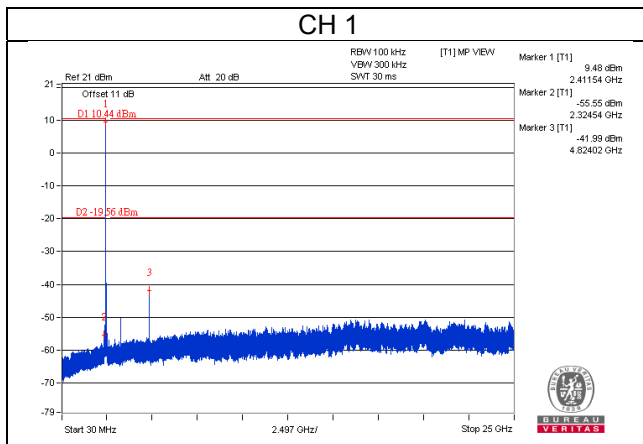
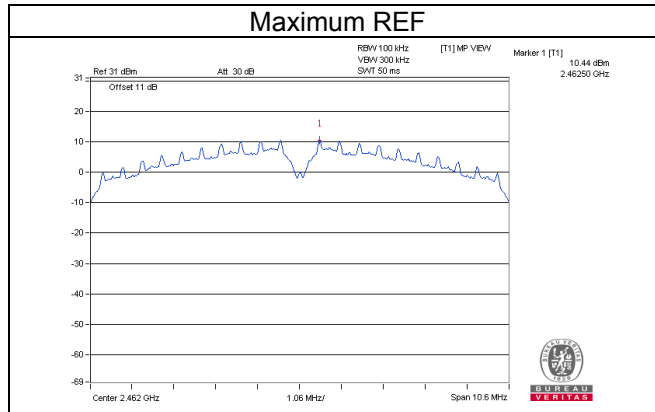

802.11g

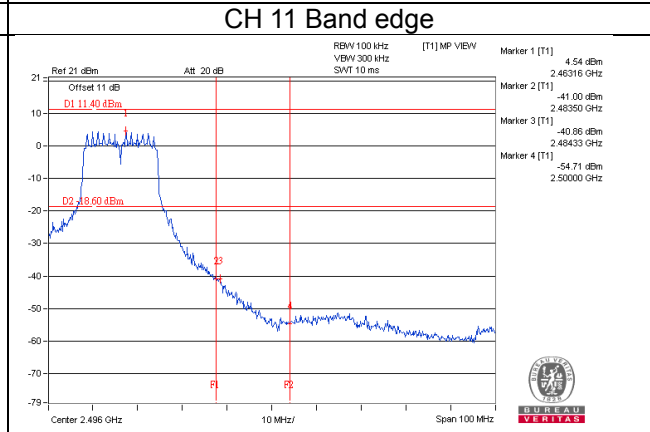
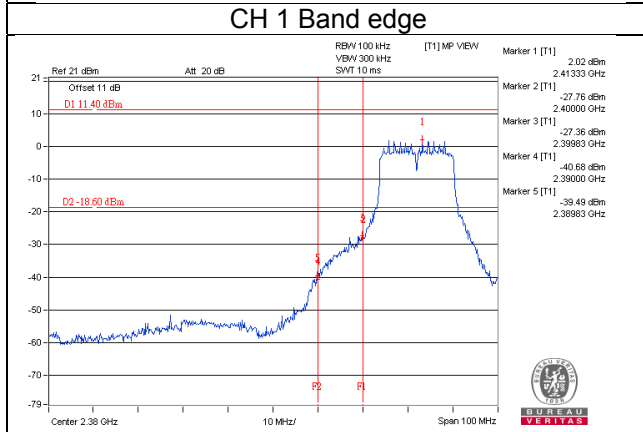
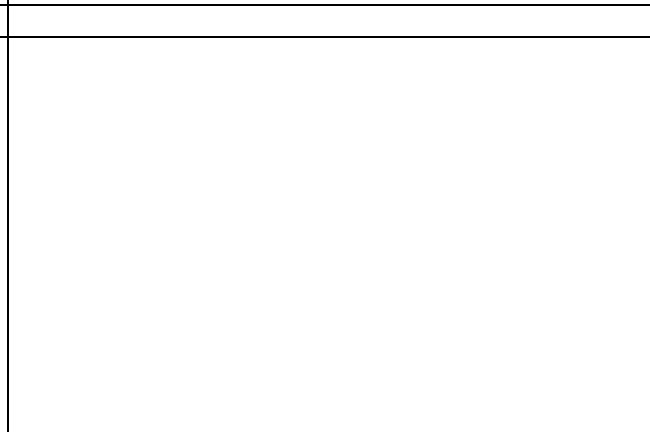
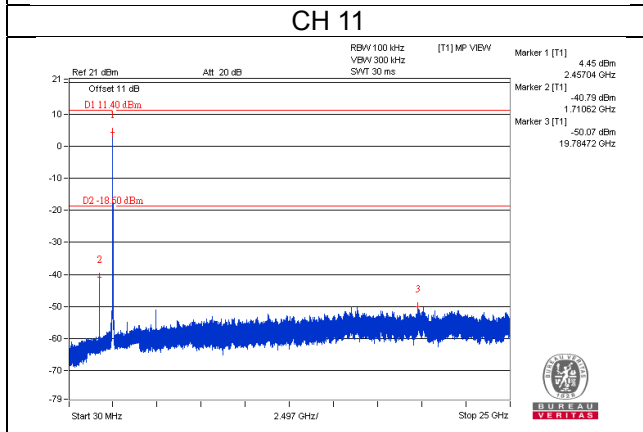
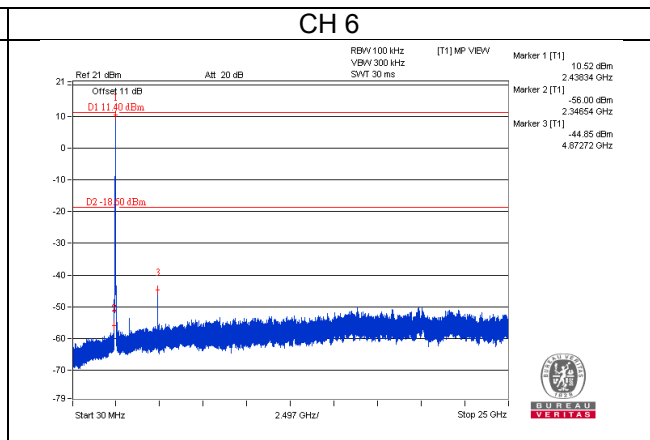
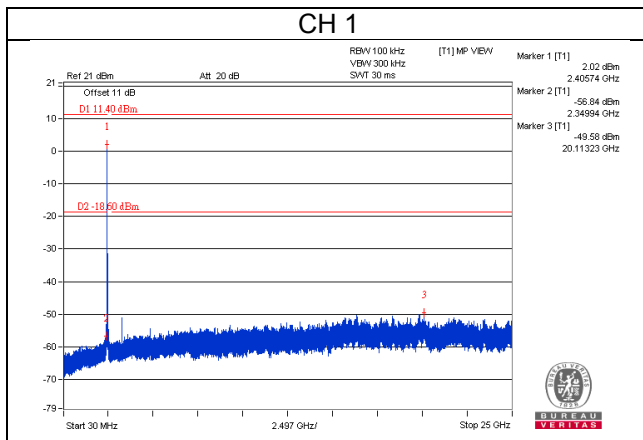
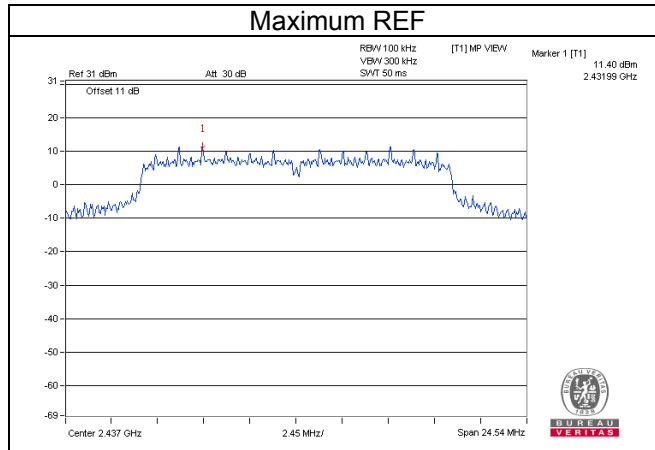

802.11n (HT20)

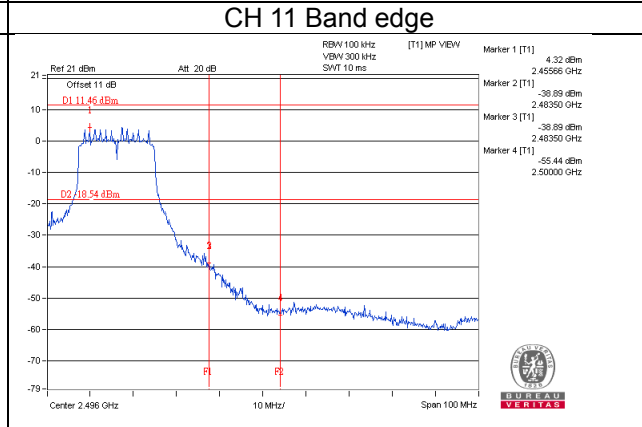
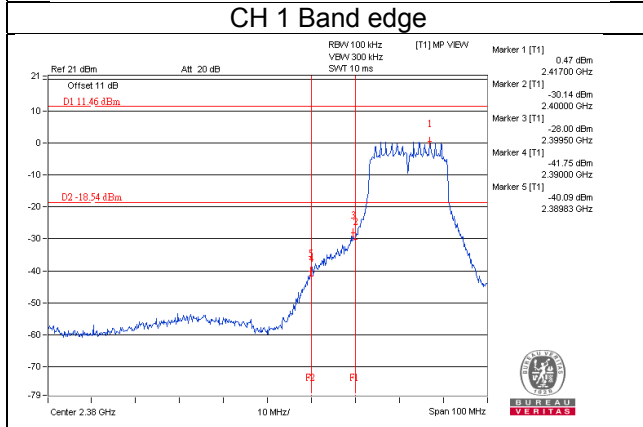
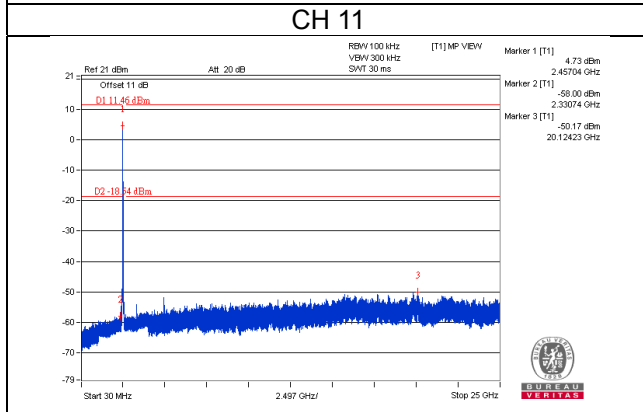
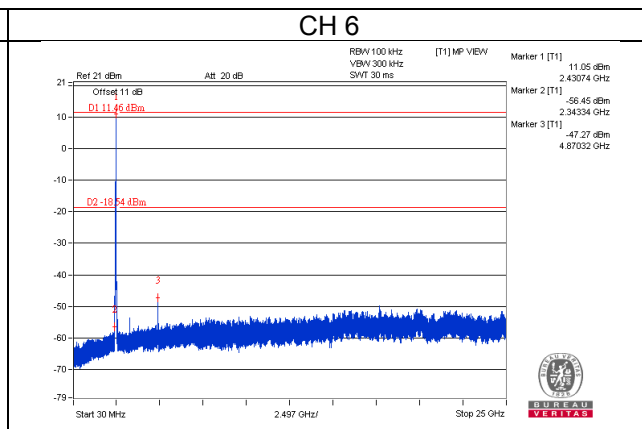
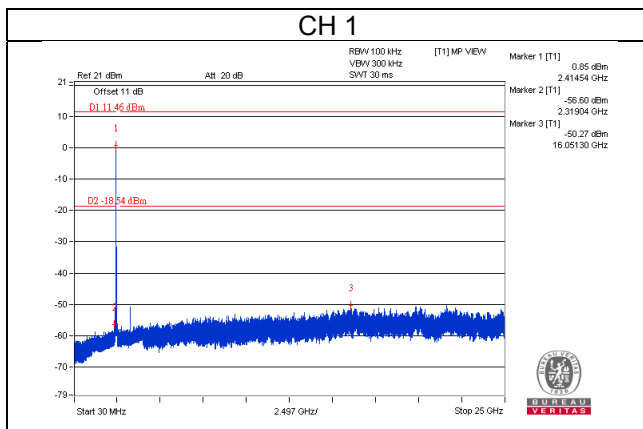
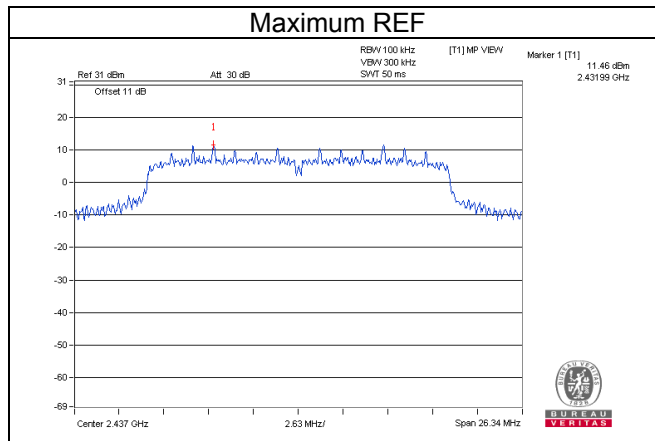

802.11n (HT40)

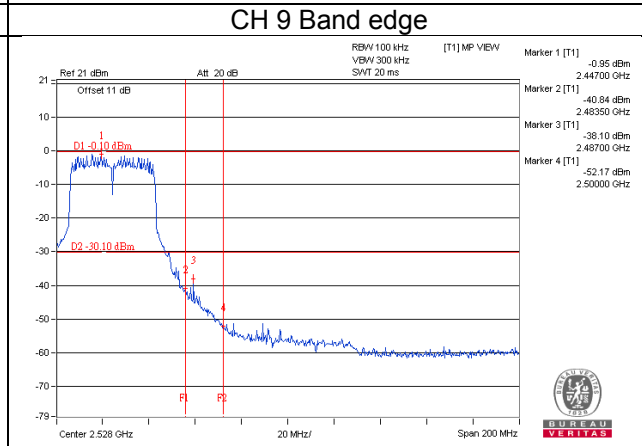
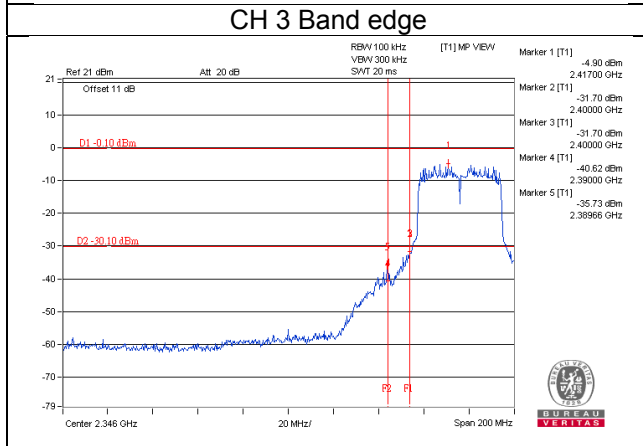
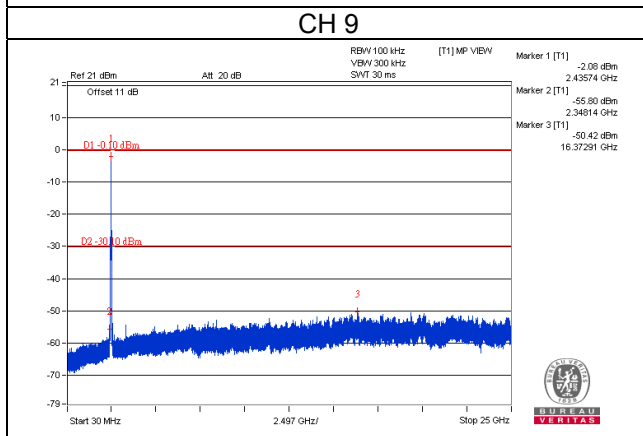
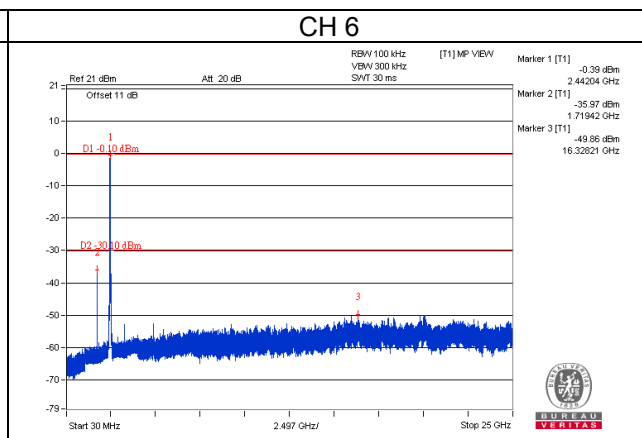
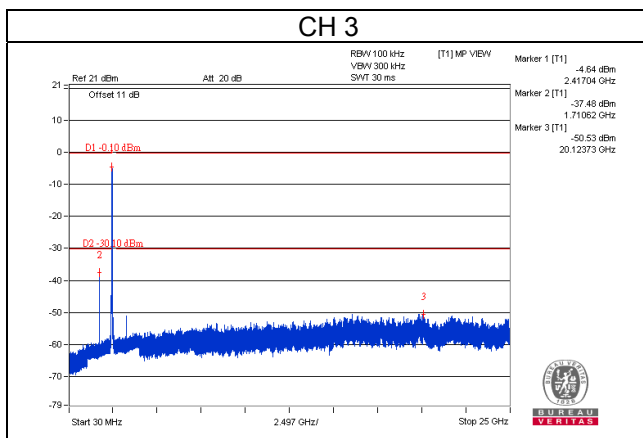
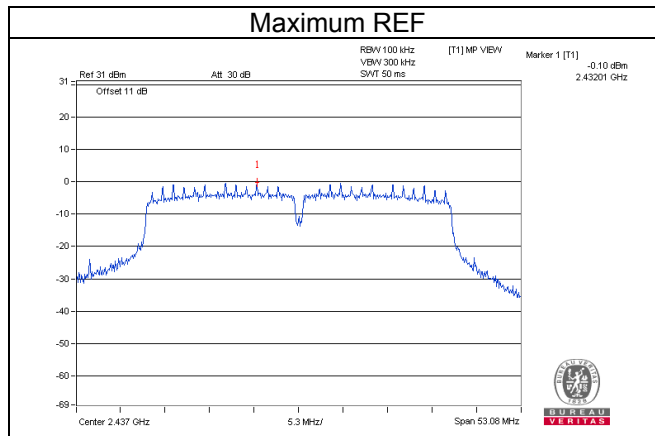

5 Pictures of Test Arrangements

Please refer to the attached file (Test Setup Photo).

Appendix – Information on the Testing Laboratories

We, Bureau Veritas Consumer Products Services (H.K.) Ltd., Taoyuan Branch, were founded in 1988 to provide our best service in EMC, Radio, Telecom and Safety consultation. Our laboratories are FCC recognized accredited test firms and accredited and approved according to ISO/IEC 17025.

If you have any comments, please feel free to contact us at the following:

Linko EMC/RF Lab

Tel: 886-2-26052180

Fax: 886-2-26051924

Hsin Chu EMC/RF/Telecom Lab

Tel: 886-3-6668565

Fax: 886-3-6668323

Hwa Ya EMC/RF/Safety Lab

Tel: 886-3-3183232

Fax: 886-3-3270892

Email: service.adt@tw.bureauveritas.com

Web Site: www.bureauveritas-adt.com

The address and road map of all our labs can be found in our web site also.

--- END ---