

# Report on the FCC and ISED Testing of the

Cooper Lighting LLC  
SWPD01-DC

In accordance with FCC 47 CFR Part 15.247 &  
ISED Canada's Radio Standards Specifications  
RSS-247

Prepared for: Cooper Lighting LLC  
1121 Highway 74 South  
Peachtree City, GA 30269

FCC ID: 2AKCY-SWPD01DC IC: 4706A-SWPD01DC

## COMMERCIAL-IN-CONFIDENCE

Document Number: BO72141372.200 | Issue: 01

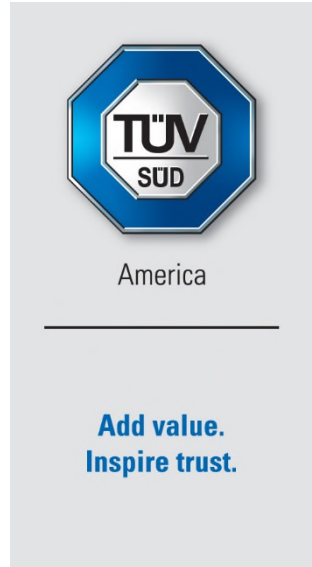

### SIGNATURE

NAME	JOB TITLE	RESPONSIBLE FOR	ISSUE DATE
Pete Walsh	Service Line Manager	Authorized Signatory	2019-Apr-30

Signatures in this approval box have checked this document in line with the requirements of TÜV SÜD America, Inc. document control rules.

FCC Accreditation  
Designation Number US1063 Tampa, FL Test Laboratory

Innovation, Science, and Economic Development Canada  
Accreditation  
Main Site Number 2087A-2 Tampa, FL Test Laboratory  
Satellite Site Number: 4175C Boca Raton, FL Test Laboratory

### EXECUTIVE SUMMARY

A sample of this product was tested and found to be compliant with FCC Part 15.247, ISED Canada's RSS-247



### DISCLAIMER AND COPYRIGHT

This non-binding report has been prepared by TÜV SÜD America with all reasonable skill and care. The document is confidential to the potential Client and TÜV SÜD America. No part of this document may be reproduced without the prior written approval of TÜV SÜD America. © TÜV SÜD.

### ACCREDITATION

Our A2LA Accreditation does not cover opinions and interpretations and any expressed are outside the scope of our A2LA Accreditation.

TÜV SÜD America  
5610 West Sligh Ave., Suite 100  
Tampa, FL 33634

Phone: 813-284-2715  
[www.tuv-sud-america.com](http://www.tuv-sud-america.com)

## TABLE OF CONTENTS

1	GENERAL .....	3
1.1	Purpose .....	3
1.2	Applicant Information .....	3
1.3	Product Description .....	3
1.4	Test Methodology and Considerations .....	3
2	TEST FACILITIES .....	4
2.1	Location .....	4
2.2	Laboratory Accreditations/Recognitions/Certifications.....	4
2.3	Radiated & Conducted Emissions Test Site Description .....	5
2.3.1	Semi-Anechoic Chamber Test Site .....	5
2.3.2	Conducted Emissions Test Site Description.....	6
3	APPLICABLE STANDARD REFERENCES .....	7
4	LIST OF TEST EQUIPMENT .....	8
5	SUPPORT EQUIPMENT .....	9
6	EQUIPMENT UNDER TEST SETUP BLOCK DIAGRAM.....	9
7	SUMMARY OF TESTS.....	10
7.1	Antenna Requirement – FCC: Section 15.203.....	10
7.2	6 dB Bandwidth - FCC: Section 15.247(a)(2); ISED Canada: RSS-247 5.2(a); 99% Bandwidth ISED Canada: RSS-GEN 6.6.....	10
7.2.1	Measurement Procedure.....	10
7.2.2	Measurement Results .....	10
7.3	Peak Output Power – FCC: Section 15.247(b)(3); ISED Canada: RSS-247 5.4(d) .....	14
7.3.1	Measurement Procedure (Conducted Method) .....	14
7.3.2	Measurement Results .....	14
7.4	Band-Edge Compliance and Spurious Emissions .....	16
7.4.1	Band-Edge Compliance of RF Conducted Emissions – FCC: Section 15.247(d); ISED Canada: RSS-247 5.5.....	16
7.4.2	RF Conducted Spurious Emissions – FCC: Section 15.247(d); ISED Canada: RSS-247 5.5... ..	18
7.4.3	Radiated Spurious Emissions into Restricted Frequency Bands – FCC: Sections 15.205, 15.209; ISED Canada: RSS-Gen 8.9, 8.10 .....	22
7.4.4	Sample Calculation: .....	24
7.5	Power Spectral Density – FCC: Section 15.247(e); ISED Canada: RSS-247 5.2(b) .....	25
7.5.1	PSD Measurement Procedure (Conducted Method).....	25
7.5.2	Measurement Results .....	25
7.6	Power Line Conducted Emissions – FCC: Section 15.207; ISED Canada: RSS-Gen 8.8 .....	27
7.6.1	Measurement Procedure.....	27
7.6.2	Measurement Results .....	27
8	MEASUREMENT UNCERTAINTIES .....	29
9	CONCLUSION.....	30

## **1 GENERAL**

### **1.1 Purpose**

The purpose of this report is to demonstrate compliance with Part 15 Subpart C of the FCC's Code of Federal Regulations Section 15.247 and Innovation Science and Economic Development Canada's Radio Standards Specification RSS-247 for the tests documented herein.

### **1.2 Applicant Information**

Cooper Lighting LLC  
1121 Highway 74 South  
Peachtree City, GA 30269

### **1.3 Product Description**

The EUT is a Sensor to be integrated into light fixtures. The device includes a Zigbee+BLE transceiver as well as a low power BLE transceiver. The transceivers are not capable of transmitting simultaneously. The test report documents the compliance of the BLE Class 1 radio of the Zigbee/BLE transceiver.

#### Technical Details

Mode of Operation:	Bluetooth Low Energy
Frequency Range:	2402 MHz - 2480 MHz
Number of Channels:	40
Channel Separation:	2 MHz
Data Rate:	1 Mbps
Modulations:	GFSK
Antenna Type/Gain:	PCB Antenna, 2.6 dBi
Input Power:	12 VDC

Model Number: SWPD01-DC

Test Sample Serial Number(s): 195 Radiated Emissions, 191 RF Conducted Emissions

Test Sample Condition: The test samples were in good operating condition without any physical damages.

### **1.4 Test Methodology and Considerations**

The EUT was evaluated for radiated, RF Conducted and Power Line Conducted Emissions.

For the radiated emissions evaluation, the EUT was set in three orthogonal orientations. The EUT flat on the table top led to the highest emissions at the band-edges. The highest radiated spurious emissions were observed for the EUT set sideways on the table top. The test results reported correspond to the worst case.

Test Power Setting:  
Channels 0 - 39: 127

The EUT was also evaluated for unintentional emissions. The results are documented in a Supplier's Declaration of Conformity test report.

## **2 TEST FACILITIES**

### **2.1 Location**

The radiated and conducted emissions test sites are located at the following address:

TÜV SÜD America, Inc.  
3998 FAU Blvd, Suite 310  
Boca Raton, Florida 33431  
Phone: (561) 961-5585  
Fax: (561) 961-5587  
<http://www.tuv-sud-america.com>

Innovation, Science and Economic Development Canada Lab Code: 4175C

TÜV SÜD America, Inc.  
5610 West Sligh Ave., Suite 100  
Tampa, FL 33634  
Phone: 813-284-2715  
[www.tuv-sud-america.com](http://www.tuv-sud-america.com)

FCC Designation Number US1063  
FCC Test Firm Registration #: 160606  
Innovation, Science, and Economic Development Canada Lab Code: 2087A-2

### **2.2 Laboratory Accreditations/Recognitions/Certifications**

TÜV SÜD America, Inc. is accredited to ISO/IEC 17025 by American Association for Laboratory Accreditation (A2LA) and has been issued certificate number 2955.15 in recognition of this accreditation. Unless otherwise specified, all test methods described within this report are covered under the ISO/IEC 17025 scope of accreditation.

Main Site Information:

TÜV SÜD America, Inc.  
5610 West Sligh Ave., Suite 100  
Tampa, FL 33634  
Phone: 813-284-2715  
[www.tuv-sud-america.com](http://www.tuv-sud-america.com)

FCC Designation Number US1063  
FCC Test Firm Registration #: 160606  
Innovation, Science, and Economic Development Canada Lab Code: 2087A-2

**2.3 Radiated & Conducted Emissions Test Site Description**

**2.3.1 Semi-Anechoic Chamber Test Site**

The EMC radiated test facility consists of an RF-shielded enclosure. The interior dimensions of the indoor semi-anechoic chamber are approximately 48 feet (14.6 m) long by 36 feet (10.8 m) wide by 24 feet (7.3 m) high and consist of rigid, 1/8 inch (0.32 cm) steel-clad, wood core modular panels with steel framing. In the shielded enclosure, the faces of the panels are galvanized, and the chamber is self-supporting. 8-foot RF absorbing cones are installed on 4 walls and the ceiling. The steel-clad ground plane is covered with vinyl flooring.

The turntable is driven by pneumatic motor, which can support a 2000 lb. load. The turntable is flush with the chamber floor which it is connected to, around its circumference, with a continuous metallic loaded spring. An EMCO Model 1060 Multi-device controller controls the turntable position.

A pneumatic motor is used to control antenna polarizations and height relative to the ground. The height information is displayed on the control unit EMCO Model 1050.

The control room is an RF shielded enclosure attached to the semi-anechoic chamber with two bulkhead panels for connecting RF, and control cables. The dimension of the room is 7.3 m x 4.9 m x 3 m high and the entrance doors of both control and conducted rooms are 3 feet (0.91 m) by 7 feet (2.13 m).

A diagram of the Semi-Anechoic Chamber Test Site is shown in Figure 2.3.1-1 below:

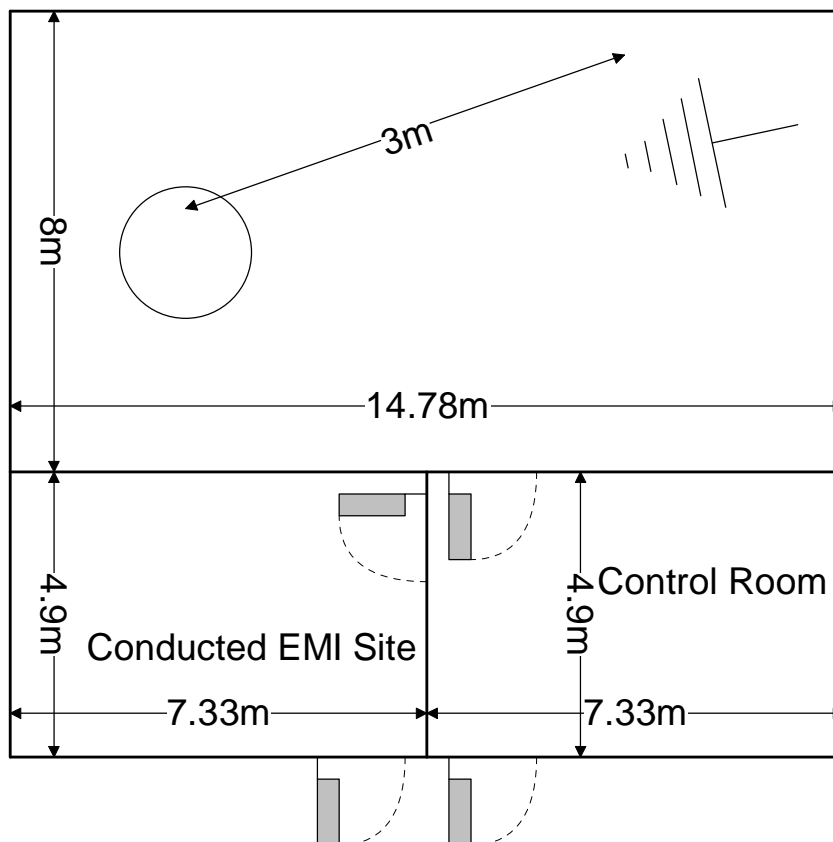

**Figure 2.3.1-1: Semi-Anechoic Chamber Test Site**

### 2.3.2 Conducted Emissions Test Site Description

The dimensions of the shielded conducted room are 7.3 x 4.9 x 3 m<sup>3</sup>. The power line conducted emission site includes two LISNs: a Solar Model 8028-50 50 Ω/50 μH and an EMCO Model 3825/2R, which are installed as shown in the figure below. For evaluations requiring 230 V, 50 Hz AC input, a Polarad LISN (S/N 879341/048) is used in conjunction with a California Instruments signal generator Model 2001RP-OP1.

A diagram of the room is shown below in figure 2.3.2-1:

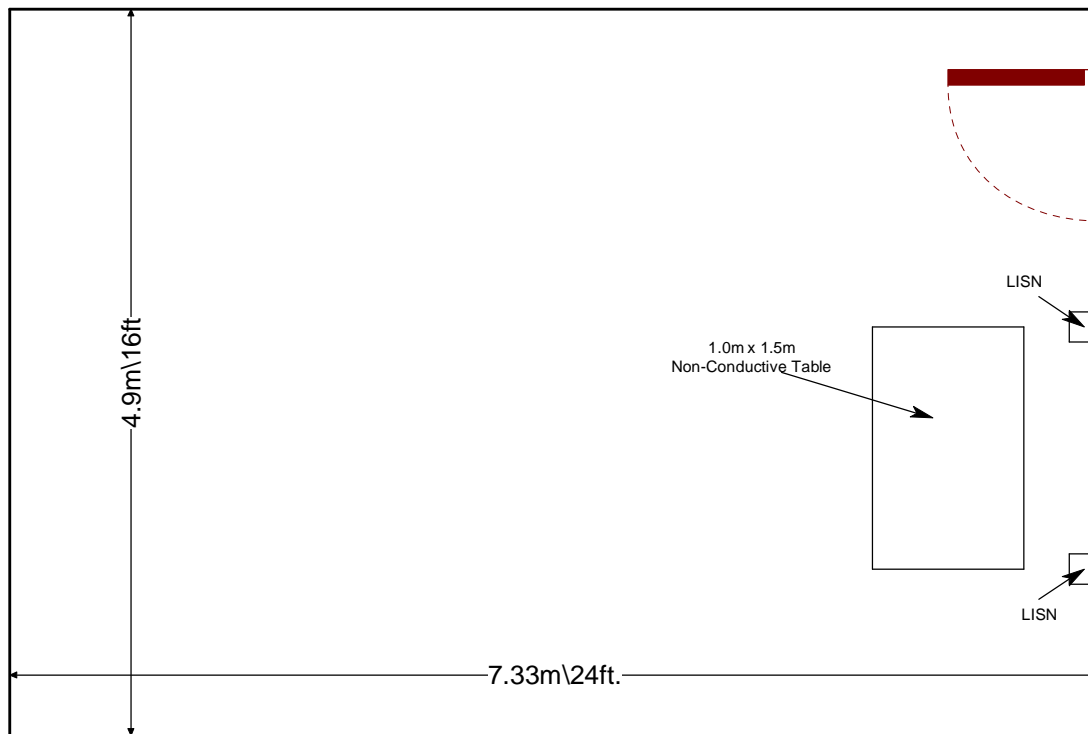

Figure 2.3.2-1: AC Mains Conducted EMI Site

### **3 APPLICABLE STANDARD REFERENCES**

The following standards were used:

- ❖ ANSI C63.10-2013: American National Standard of Procedures for Compliance Testing of Unlicensed Wireless Devices
- ❖ US Code of Federal Regulations (CFR): Title 47, Part 2, Subpart J: Equipment Authorization Procedures, 2018.
- ❖ US Code of Federal Regulations (CFR): Title 47, Part 15, Subpart C: Radio Frequency Devices, Intentional Radiators, 2018
- ❖ FCC KDB 558074 D01 DTS Meas Guidance v05 - Guidance for Performing Compliance Measurements on Digital Transmission System, Frequency Hopping Spread Spectrum System, and Hybrid System Devices Operating Under Section 15.257 of the FCC Rules, August 24, 2018.
- ❖ Innovation, Science and Economic Development Canada Radio Standards Specification: RSS-247 — Digital Transmission Systems (DTSs), Frequency Hopping Systems (FHSs) and Licence-Exempt Local Area Network (LE-LAN) Devices, Issue 2, February 2017.
- ❖ Innovation, Science and Economic Development Canada Radio Standards Specification: RSS-GEN – General Requirements for Compliance of Radio Apparatus, Issue 4, Amendment 1, March 2018.

#### 4 LIST OF TEST EQUIPMENT

The calibration interval of test equipment is annually or the manufacturer's recommendations. Where the calibration interval deviates from the annual cycle based on the instrument manufacturer's recommendations, it shall be stated below.

**Table 4-1: Test Equipment List**

AssetID	Manufacturer	Model #	Equipment Type	Serial #	Calibration Performed Date	Calibration Due Date
346	Aeroflex/Weinschel	54A-10	Attenuator	T1362	7/10/2018	7/10/2019
BEMC00078	EMCO	6502	Active Loop Antenna	9104-2608	5/9/2018	5/9/2020
BEMC00282	Microwave Circuits	H3G020G4	2-20GHz Band Pass Filter	74541	5/17/2018	5/17/2019
BEMC00283	Rohde & Schwarz	FSP40	Spectrum Analyzer	1000033	11/28/2017	11/28/2019
BEMC00523	Agilent	E7405A	9kHz-26.5GHz EMC analyzer/HYZ	MY45103293	11/27/2018	11/27/2020
BEMC00653	Suhner	SF-102A	Cable (40GHz)	0944/2A	10/9/2018	10/9/2019
BEMC02002	EMCO	3108	30 MHz to 200 MHz Biconical Antenna	2147	11/28/2017	11/30/2019
BEMC02004	EMCO	3146	200 MHz to 1 GHz Log Periodic Antenna	1385	12/27/2017	12/27/2019
BEMC02008	COM-power	AH-826	Horn Antenna (18 GHz to 26.5 GHz)	81009	NCR	NCR
BEMC02011	Hewlett-Packard	HP 8447D	100 kHz to 1.3 GHz low-noise, high gain amplifier	2443A03952	10/18/2018	10/18/2019
BEMC02067	ACS Boca	Conducted Cable Set	Conducted Emissions Cable Set	2067	8/14/2018	8/14/2019
BEMC02086	Merrimac	FAN-6-10K	10dB Attenuator	23148-83-1	10/17/2018	10/17/2019
BEMC02095	ETS Lindgren	TILE4! - Version 4.2.A	Tile Automation Software	85242	NCR	NCR
BEMC02110	Aeroflex Inmet	40AH2W-10	Attenuator 10dB, 2.9 mm-M/F, DC-40GHz 2 W	2110	8/5/2018	8/5/2019
BEMC02121	Teledyne Storm Products	A81-0303	Radiated Cable Set	2121	7/26/2018	7/26/2019
BEMC02138	Hewlett Packard	8449B	Pre-Amplifier	3008A00320	11/26/2018	11/26/2019
BEMC03004	Teseq	CFL 9206A	Transient Filter Limiter 9kHz - 30MHz	34720	8/10/2018	8/10/2019
TEMC00012	Agilent	E7405A	EMC Analyzer	MY42000055	3/29/2018	3/29/2020
TEMC00044	Rohde & Schwarz	ESHS 30	EMI Receiver	839667/006	11/16/2017	11/16/2019
TEMC00061	ETS Lindgren	3117	Double Ridge Guide Horn	109296	2/13/2018	2/13/2020
TEMC00128	Rohde & Schwarz	ESIB 40	EMI Test Receiver	100255	11/16/2017	11/16/2019
TEMC00153	Rhode & Schwarz Vertrieb München	ESH3-Z5	Voltage Network	894785/012	10/19/2018	10/19/2019
TEMC00160	Com-Power Corporatio	PAM-118A	PAM-118A	18040042	2/7/2018	2/7/2020
TEMC00171	MegaPhase, LLC	1GVT4	4A & 4B Test Cables	NC12-K1K1-59, 394	5/30/2018	5/30/2020
N/A	Rohde & Schwarz	EMC32 Version 10.20.01	Control Software	N/A	NCR	NCR

**Notes:**

- **NCR=No Calibration Required**
- **The assets were only used during the active period of the calibration cycle.**



5 SUPPORT EQUIPMENT

Table 5-1: EUT and Support Equipment Description

Item #	Type Device	Manufacturer	Model/Part #	Serial #
1	EUT	Eaton Cooper Lighting	SWPD01-DC	195
2	50W LED Driver	Eaton	ELX-PCD-UNV-A-050-1200-AMB-S AUX-00	XELUA5001812000127
3	Junction Box	Eaton	N/A	N/A

Table 5-2: Cable Description – Radiated Emissions

Cable #	Cable Type	Length	Shield	Termination
A	Modular Cable	300cm	No	Junction Box to EUT
B	Modular Cable	300cm	No	Junction Box to LED Driver
C	Power Cable	175cm	No	Led Driver to AC Mains
D	USB Cable	170cm	No	Not Terminated
E	USB Cable	170cm	No	Not Terminated

6 EQUIPMENT UNDER TEST SETUP BLOCK DIAGRAM

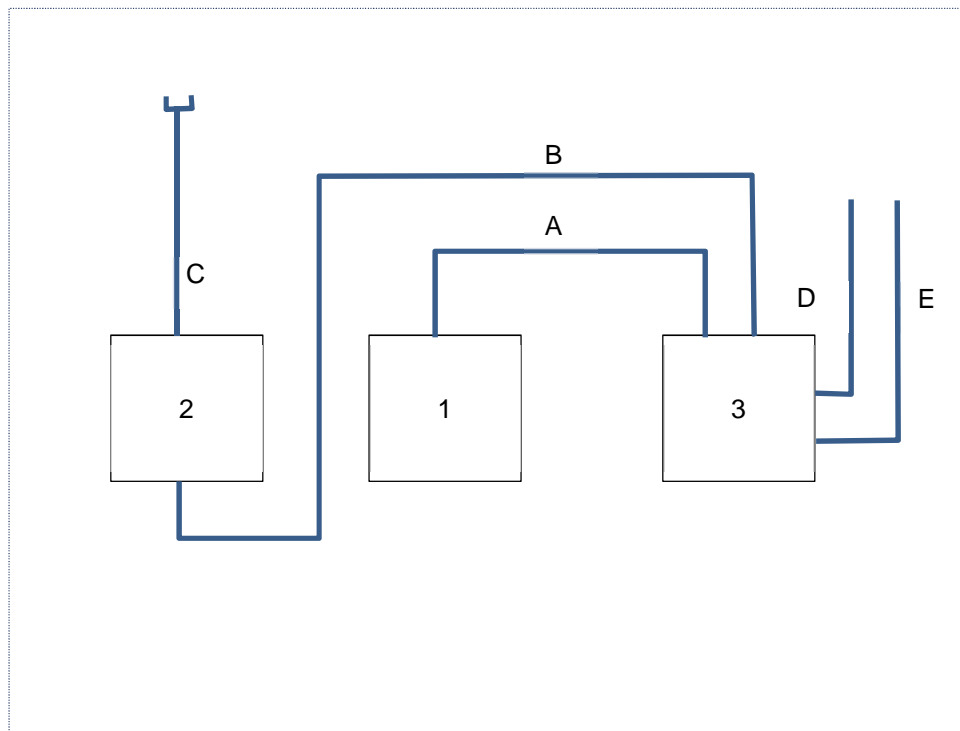

Figure 6-1: EUT and Support Equipment Block Diagram

## 7 SUMMARY OF TESTS

Along with the tabular data shown below, plots were taken of all signals deemed important enough to document.

Test Begin Date: August 2, 2018

Test End Date: April 26, 2019

**Table 7-1: Summary of Tests**

Requirements	FCC Rule Part	ISED Canada	Test Results
Antenna Requirement	FCC: Section 15.203		Pass
6 dB Bandwidth	FCC: Section 15.247(a)(2)	ISED Canada: RSS-247 5.2(a)	Pass
99% Bandwidth		ISED Canada: RSS-GEN 6.6	Pass
Peak Output Power	FCC: Section 15.247(b)(3)	ISED Canada: RSS-247 5.4(d)	Pass
Band-Edge Compliance of RF Conducted Emissions	FCC: Section 15.247(d)	ISED Canada: RSS-247 5.5	Pass
RF Conducted Spurious Emissions	FCC: Section 15.247(d)	ISED Canada: RSS-247 5.5	Pass
Radiated Spurious Emissions into Restricted Frequency Bands	FCC: Sections 15.205, 15.209	ISED Canada: RSS-Gen 8.9, 8.10	Pass
Power Spectral Density	FCC: Section 15.247(e)	ISED Canada: RSS-247 5.2(b)	Pass
Power Line Conducted Emissions	FCC: Section 15.207	ISED Canada: RSS-Gen 8.8	Pass

### 7.1 Antenna Requirement – FCC: Section 15.203

The EUT uses a 2.6 dBi PCB antenna that is integral to the PCB. The antenna permanently attached and is not readily removable. Therefore meets the requirements of FCC Section 15.203.

### 7.2 6 dB Bandwidth - FCC: Section 15.247(a)(2); ISED Canada: RSS-247 5.2(a); 99% Bandwidth ISED Canada: RSS-GEN 6.6

#### 7.2.1 Measurement Procedure

The 6dB bandwidth was measured in accordance with Subclause 11.8 of ANSI C63.10. The RBW of the spectrum analyzer was set to 100 kHz and VBW 300 kHz. Span was set large enough to capture the emissions and >> RBW. A peak detector was used for the measurements.

The 99% occupied bandwidth was measured with the spectrum analyzer span set to fully display the emission. The RBW was set to 1% to 5% of the approximated bandwidth. The occupied 99% bandwidth was measured by using 99% bandwidth equipment function of the spectrum analyzer using a peak detector.

#### 7.2.2 Measurement Results

Performed by: Thierry Jean-Charles

Table 7.2.2-1: 6dB / 99% Bandwidth

Frequency (MHz)	6dB Bandwidth (kHz)	99% Bandwidth (kHz)
2402	712.75	1040.667
2440	713.50	1040.000
2480	710.00	1040.000

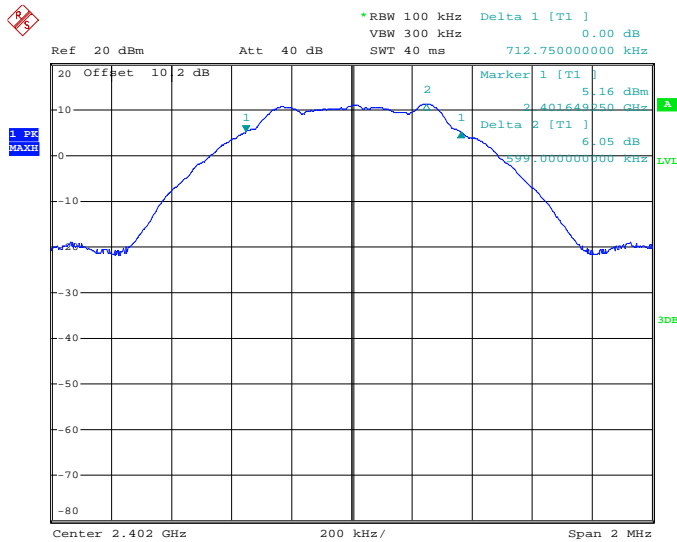

Date: 3.AUG.2018 14:30:34

Figure 7.2.2-1: 6dB BW - Low Channel

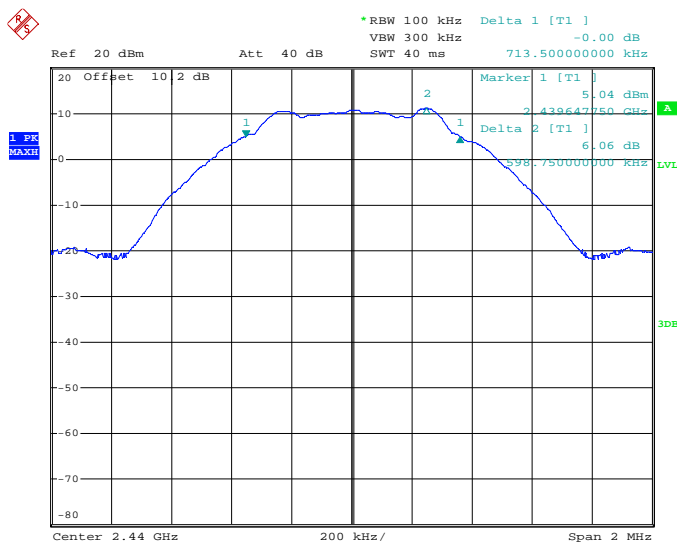

Date: 3.AUG.2018 14:57:56

Figure 7.2.2-2: 6dB BW - Middle Channel

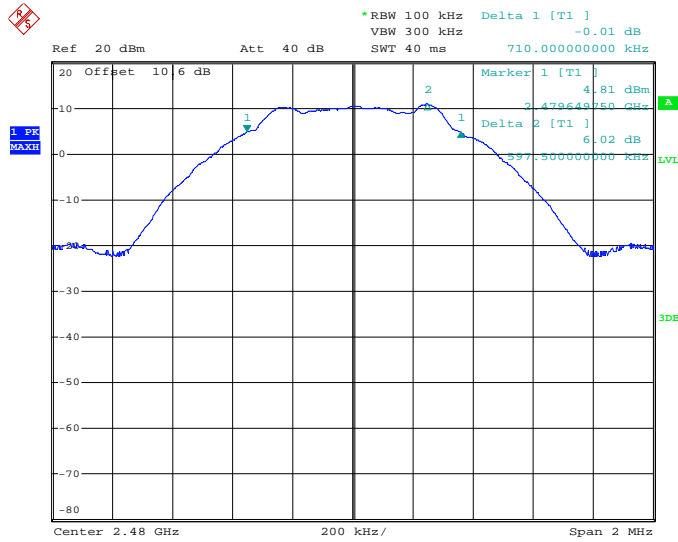

Date: 26.APR.2019 15:23:06

Figure 7.2.2-3: 6dB BW - High Channel

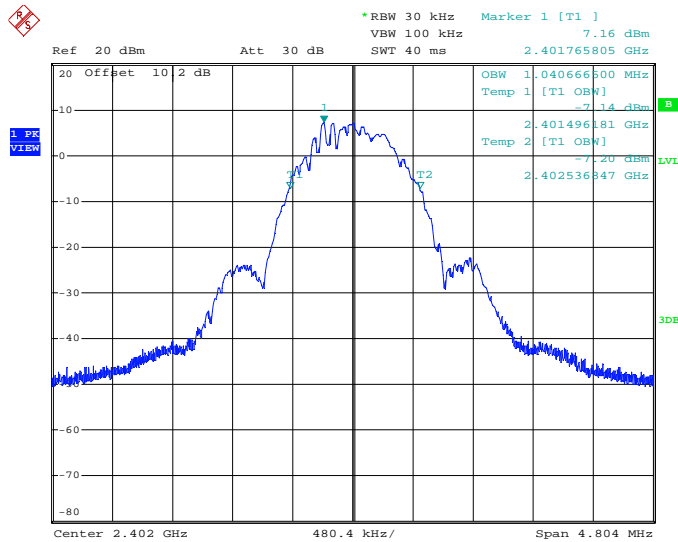

Date: 3.AUG.2018 14:23:30

Figure 7.2.2-4: 99% OBW - Low Channel

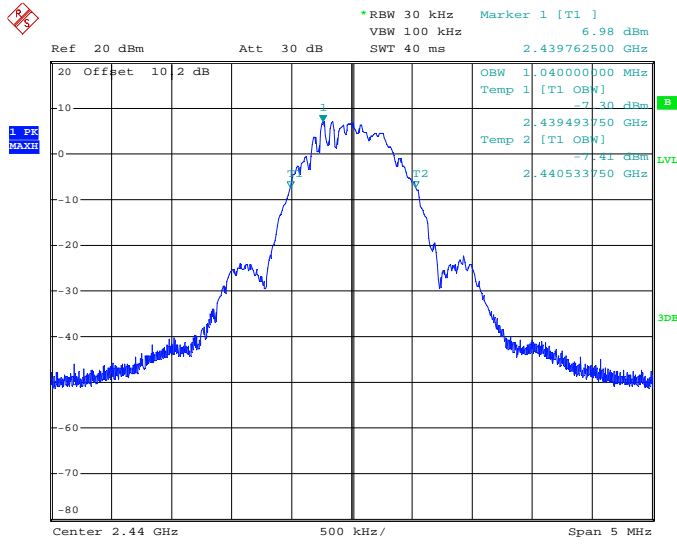

Date: 3.AUG.2018 14:51:05

Figure 7.2.2-5: 99% OBW - Middle Channel

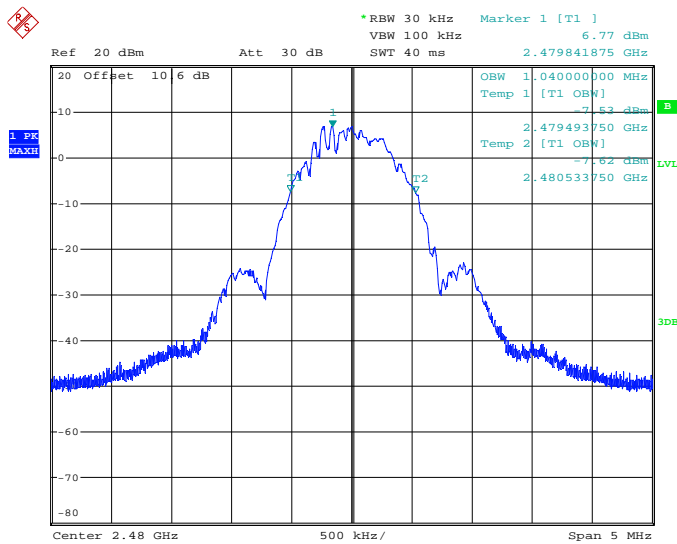

Date: 26.APR.2019 15:18:45

Figure 7.2.2-6 99% OBW - High Channel

**7.3 Peak Output Power – FCC: Section 15.247(b)(3); ISED Canada: RSS-247 5.4(d)**

**7.3.1 Measurement Procedure (Conducted Method)**

The fundamental emission output power was measured in accordance with Subclause 11.9.1.1 of ANSI C63.10. The RF output of the equipment under test was directly connected to the input of the spectrum analyzer through suitable attenuation.

The Maximum Output Power allowed is 1 Watt (30 dBm)

**7.3.2 Measurement Results**

Performed by: Thierry Jean-Charles

**Table 7.3.2-1: RF Output Power**

Frequency (MHz)	Power (dBm)
2402	12.34
2440	12.19
2480	11.83

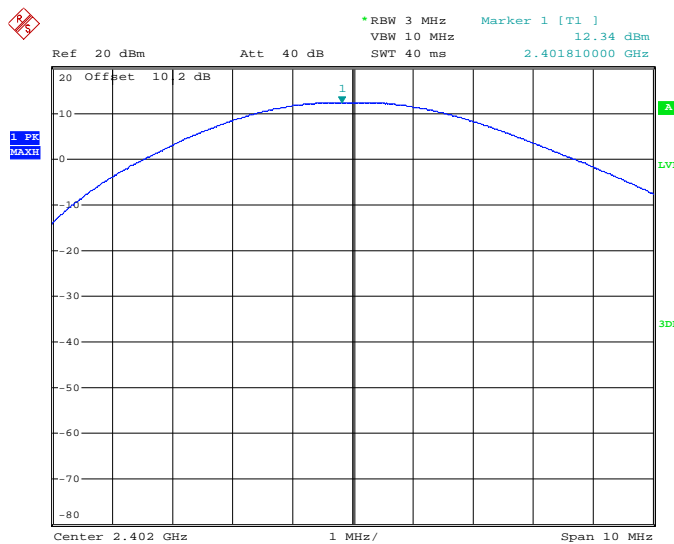

Date: 3.AUG.2018 14:26:13

**Figure 7.3.2-1: RF Output Power - Low Channel**

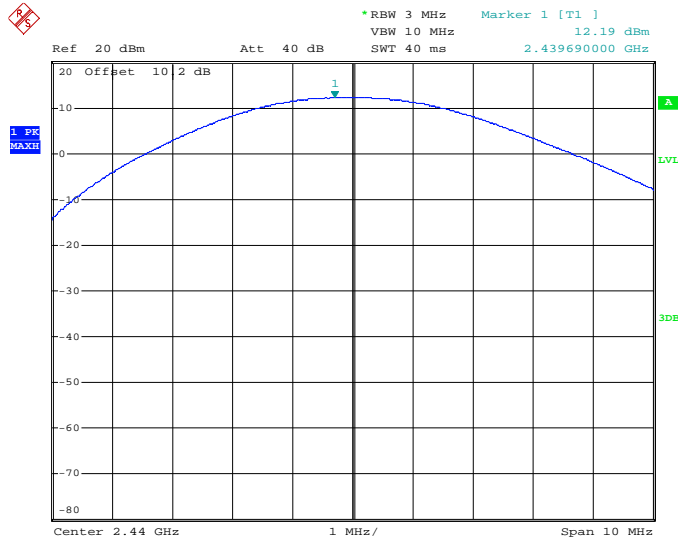

Date: 3.AUG.2018 14:53:38

Figure 7.3.2-2: RF Output Power - Middle Channel

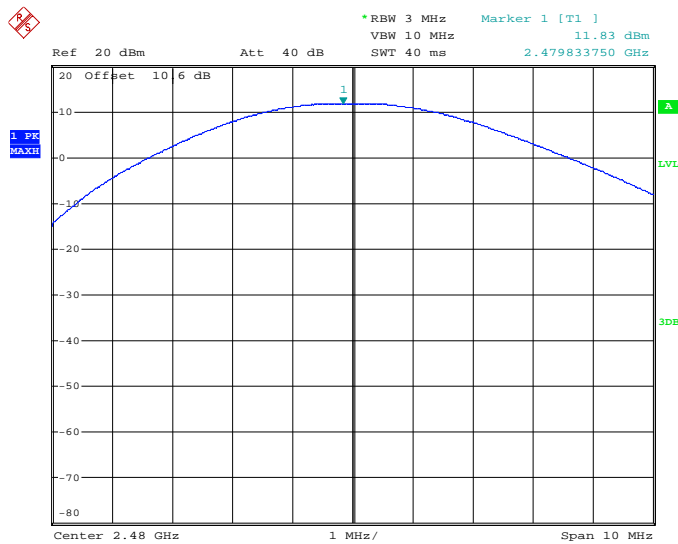

Date: 26.APR.2019 15:27:18

Figure 7.3.2-3: RF Output Power - High Channel

7.4 Band-Edge Compliance and Spurious Emissions

7.4.1 Band-Edge Compliance of RF Conducted Emissions – FCC: Section 15.247(d); ISED Canada: RSS-247 5.5

7.4.1.1 Measurement Procedure

The RF Conducted Emissions at the Band-Edges were measured in accordance with Subclause 11.11 of ANSI C63.10. The RF output port of the EUT was connected to the input of the spectrum analyzer through suitable attenuation. The EUT was investigated at the lowest and highest channel available to determine band-edge compliance. For each measurement the spectrum analyzer’s RBW was set to 100 kHz, and the VBW was set to >= 300 kHz.

7.4.1.2 Measurement Results

Performed by: Thierry Jean-Charles

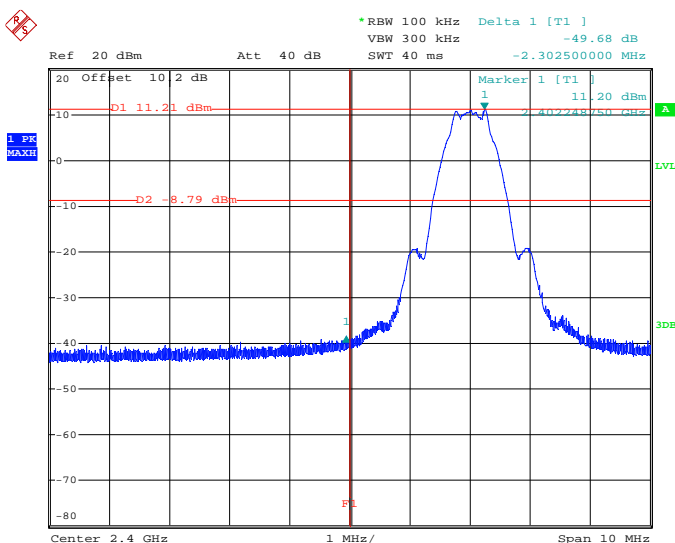

Date: 3.AUG.2018 14:45:29

Figure 7.4.1.2-1: Lower Band-Edge



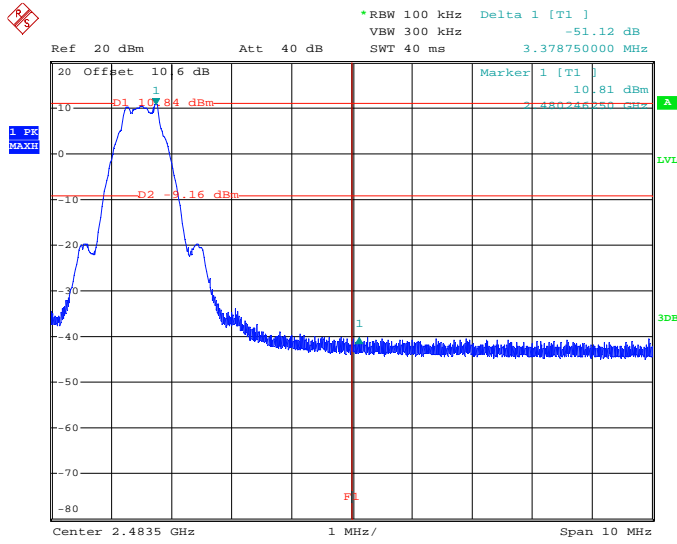

Date: 26.APR.2019 15:30:47

Figure 7.4.1.2-2: Upper Band-Edge

7.4.2 RF Conducted Spurious Emissions – FCC: Section 15.247(d); ISED Canada: RSS-247 5.5

7.4.2.1 Measurement Procedure

The RF Conducted Spurious Emissions were measured in accordance with Subclause 11.11 of ANSI C63.10. The RF output port of the equipment under test was directly connected to the input of the spectrum analyzer. The EUT was investigated for conducted spurious emissions from 30 MHz to 26 GHz, 10 times the highest fundamental frequency. Measurements were made at the low, center and high channels of the EUT. For each measurement, the spectrum analyzer’s RBW was set to 100 kHz and the VBW was set to 300 kHz. The peak Max Hold function of the analyzer was utilized.

7.4.2.2 Measurement Results

Performed by: Thierry Jean-Charles

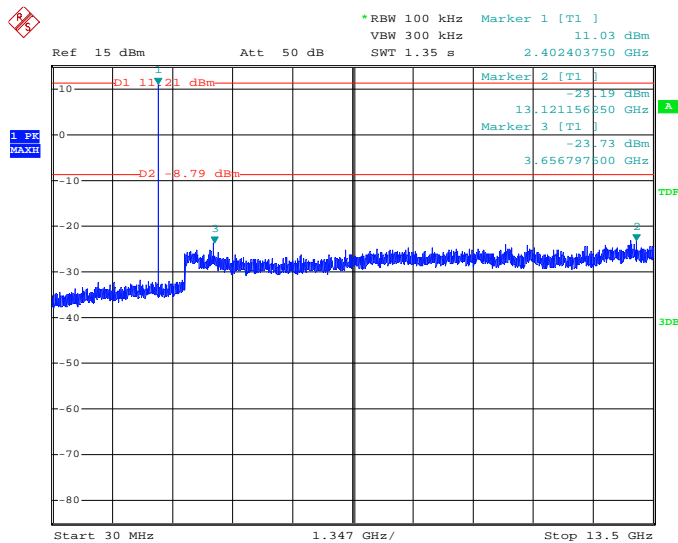

Date: 3.AUG.2018 19:16:01

Figure 7.4.2.2-1: 30 MHz – 13.5 GHz – Low Channel

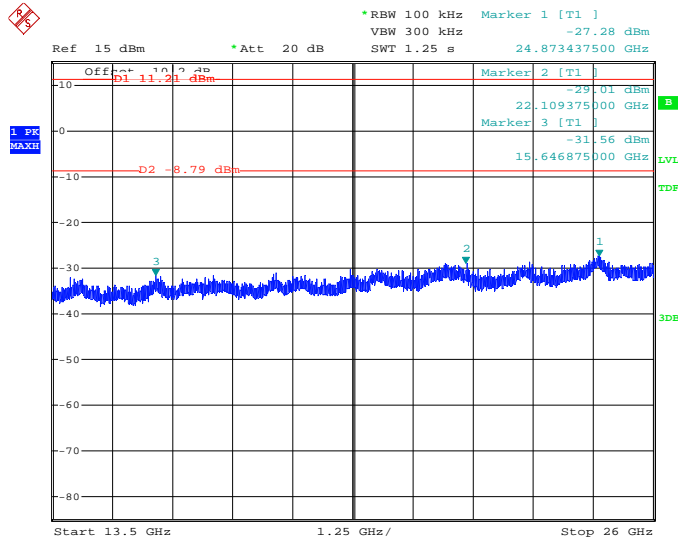

Date: 3.AUG.2018 19:18:26

Figure 7.4.2.2-2: 13.5 GHz – 26 GHz – Low Channel

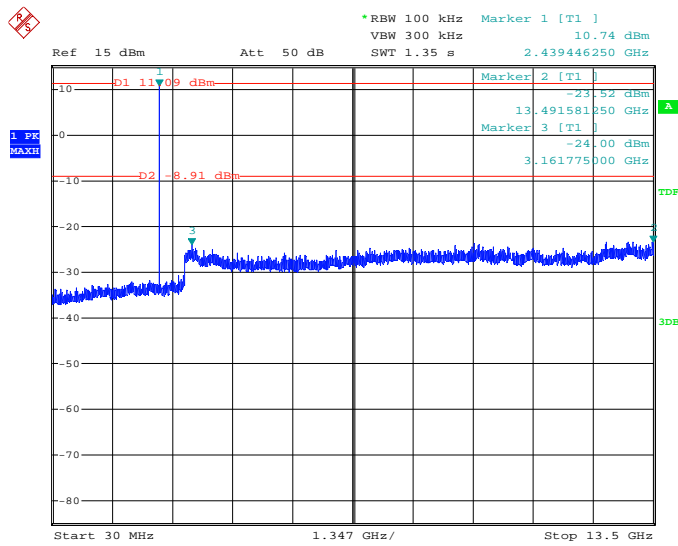

Date: 3.AUG.2018 19:29:22

Figure 7.4.2.2-3: 30 MHz – 13.5 GHz – Middle Channel

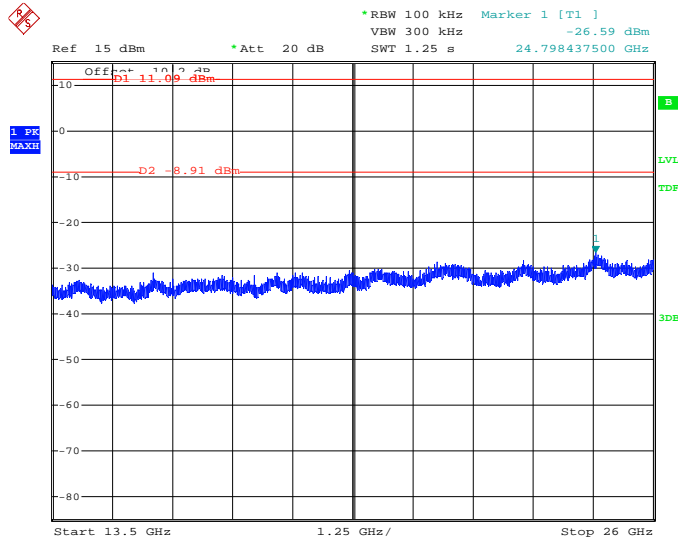

Date: 3.AUG.2018 19:32:18

Figure 7.4.2.2-4: 13.5 GHz – 26 GHz – Middle Channel

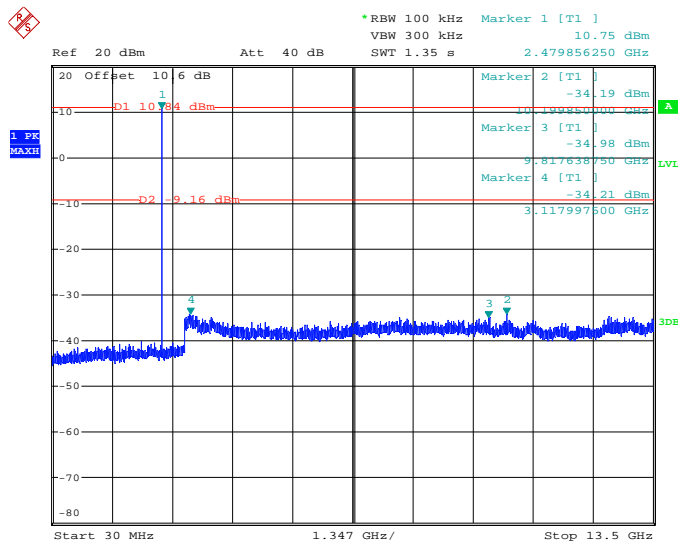

Date: 26.APR.2019 15:37:37

Figure 7.4.2.2-5: 30 MHz – 13.5 GHz – High Channel

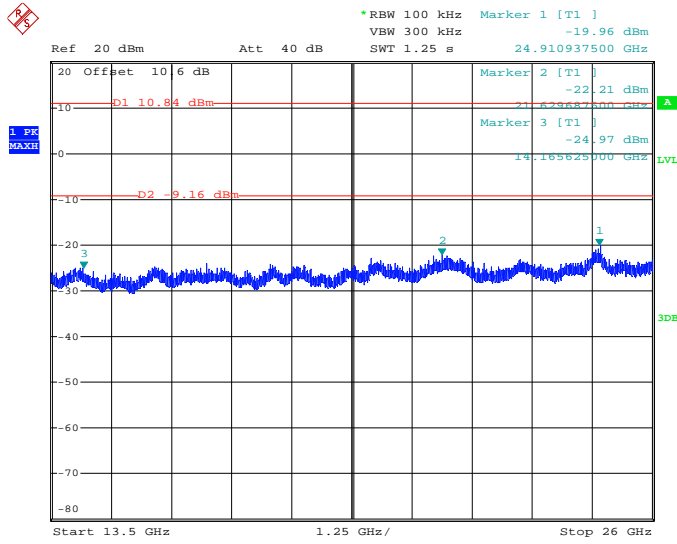

Date: 26.APR.2019 15:40:26

Figure 7.4.2.2-6: 13.5 GHz – 26 GHz – High Channel

**7.4.3 Radiated Spurious Emissions into Restricted Frequency Bands – FCC: Sections 15.205, 15.209; ISED Canada: RSS-Gen 8.9, 8.10****7.4.3.1 Measurement Procedure**

Radiated emissions tests were made over the frequency range of 9 kHz to 26 GHz, 10 times the highest fundamental frequency. Each emission found to be in a restricted band as defined by section 15.205, including any emission at the operational band-edge, was compared to the radiated emission limits as defined in Section 15.209.

For measurements below 30 MHz, the receive antenna height was set to 1 m and the EUT was rotated through 360 degrees. The resolution bandwidth was set to 200 Hz below 150 kHz and to 9 kHz above 150 kHz.

The EUT was rotated through 360° and the receive antenna height was varied from 1m to 4m so that the maximum radiated emissions level would be detected. For frequencies below 1000 MHz, quasi-peak measurements were made using a resolution bandwidth RBW of 120 kHz and a video bandwidth VBW of 300 kHz. For frequencies above 1000 MHz, peak measurements are made with RBW of 1 MHz and VBW of 3 MHz. Average measurements are performed in the linear scale using VBW of 30 Hz.

**7.4.3.2 Duty Cycle Correction**

The EUT was configured to transmit at 100% duty cycle during the evaluation. A Duty Cycle Correction of 34.22% corresponding to  $20 \cdot \log(34.22/100) = -9.31$  dB was applied to the average measurements for the corrected average results.

Per the equipment manufacturer the maximum duty cycle of the EUT is inherent to the IEEE 802.15.1 protocol and is not accessible to the end user.

The duty cycle correction factor is calculated as such:

Worst Cast Transmission time: 1.232 ms

Transmission Period: 3.6 ms

Duty Cycle =  $1.232 / 3.6 = 34.22\%$

**7.4.3.3 Measurement Results**

Performed by: Jean Rene, Thierry Jean-Charles

Radiated band-edge and spurious emissions found in the restricted frequency bands of 9 kHz to 26 GHz are reported in the tables below.

Table 7.4.3.3-1: Radiated Spurious Emissions Tabulated Data

Frequency (MHz)	Level (dBuV)		Antenna Polarity (H/V)	Correction Factors (dB)	Corrected Level (dBuV/m)		Limit (dBuV/m)		Margin (dB)	
	pk	Qpk/Avg			pk	Qpk/Avg	pk	Qpk/Avg	pk	Qpk/Avg
<b>Low Channel</b>										
2390	50.89	37.52	H	0.69	51.58	28.89	74.0	54.0	22.4	25.1
4804	39.52	28.01	H	8.03	47.55	26.73	74.0	54.0	26.4	27.3
4804	38.76	26.26	V	8.03	46.79	24.98	74.0	54.0	27.2	29.0
<b>Middle Channel</b>										
4880	40.77	30.28	H	8.35	49.12	29.32	74.0	54.0	24.9	24.7
4880	39.17	26.31	V	8.35	47.52	25.35	74.0	54.0	26.5	28.7
<b>High Channel</b>										
2483.5	65.80	51.57	H	-2.29	63.51	39.97	74.0	54.0	10.5	14.0
2483.5	61.23	47.22	V	-2.29	58.94	35.62	74.0	54.0	15.1	18.4
4960	48.19	36.86	H	4.33	52.52	31.87	74.0	54.0	21.5	22.1
4960	47.13	33.99	V	4.33	51.46	29.00	74.0	54.0	22.5	25.0

**Notes:**

All emissions above 4.96 GHz were attenuated below the limits and the noise floor of the measurement equipment.

A duty cycle correction factor corresponding to  $20 \log(34.22/100)$  was used for the average measurements.

**7.4.4 Sample Calculation:**

$$R_C = R_U + CF_T$$

Where:

CF<sub>T</sub> = Total Correction Factor (AF+CA+AG)-DC (Average Measurements Only)R<sub>U</sub> = Uncorrected ReadingR<sub>C</sub> = Corrected Level

AF = Antenna Factor

CA = Cable Attenuation

AG = Amplifier Gain

DC = Duty Cycle Correction Factor

**Example Calculation: Peak**Corrected Level:  $50.89 + 0.69 = 51.58 \text{ dB}\mu\text{V/m}$ Margin:  $74 \text{ dB}\mu\text{V/m} - 51.58 \text{ dB}\mu\text{V/m} = 22.42 \text{ dB}$ **Example Calculation: Average**Corrected Level:  $37.52 + 0.69 - 9.31 = 28.90 \text{ dB}\mu\text{V/m}$ Margin:  $54 \text{ dB}\mu\text{V/m} - 28.90 \text{ dB}\mu\text{V/m} = 25.10 \text{ dB}$



7.5 Power Spectral Density – FCC: Section 15.247(e); ISED Canada: RSS-247 5.2(b)

7.5.1 PSD Measurement Procedure (Conducted Method)

The power spectral density was measured in accordance with ANSI C63.10:2013 Section 11.10.2 Method PKPSD (peak PSD). The RF output port of the EUT was directly connected to the input of the spectrum analyzer. Offset values were input for cable and external attenuation. The spectrum analyzer RBW was set to 3 kHz and VBW to 10 kHz. The Span was adjusted to 1.5 times the DTS bandwidth and the sweep time was set to auto. The measurements were performed using a peak detector.

7.5.2 Measurement Results

Performed by: Thierry Jean-Charles

Results are shown below.

Table 7.5.2-1: Power Spectral Density

Frequency (MHz)	PSD (dBm)	Limit (dBm)	Margin (dB)
2402	-3.90	8.0	11.90
2440	-4.03	8.0	12.03
2480	-4.23	8.0	12.23

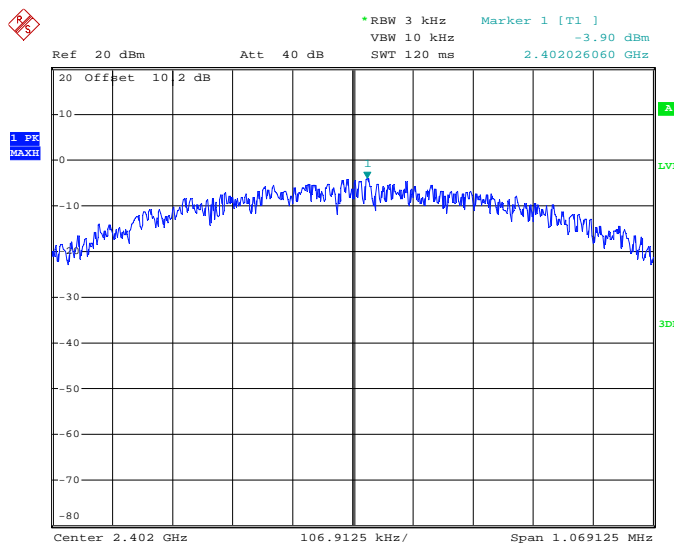

Date: 3.AUG.2018 14:35:19

Figure 7.5.2-1: Power Spectral Density - Low Channel

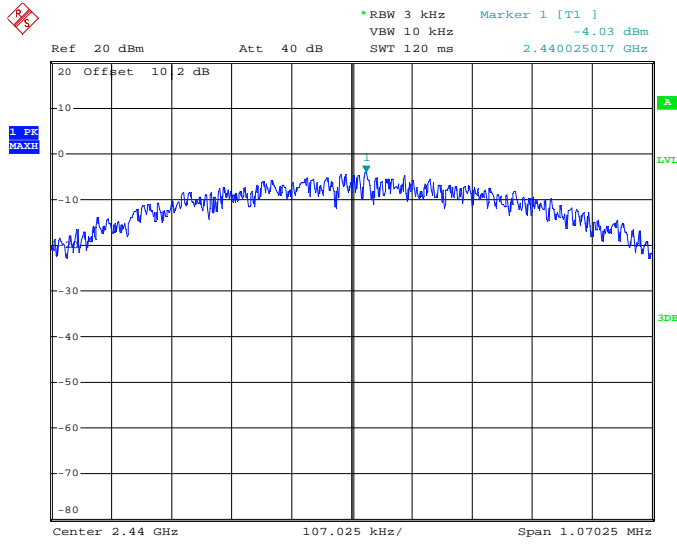

Date: 3.AUG.2018 15:03:54

Figure 7.5.2-2: Power Spectral Density - Middle Channel

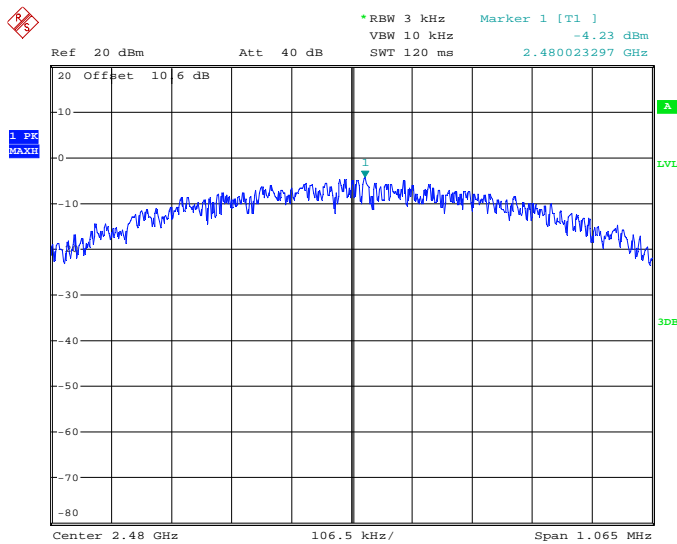

Date: 26.APR.2019 15:26:13

Figure 7.5.2-3: Power Spectral Density – High Channel

7.6 Power Line Conducted Emissions – FCC: Section 15.207; ISED Canada: RSS-Gen 8.8

7.6.1 Measurement Procedure

ANSI C63.10 section 6.2 was the guiding document for this evaluation. Conducted emissions were performed from 150 kHz to 30 MHz with the spectrum analyzer’s resolution bandwidth set to 9 kHz and the video bandwidth set to 30 kHz. The calculation for the conducted emissions is as follows:

**Corrected Reading = Analyzer Reading + LISN Loss + Cable Loss**  
**Margin = Applicable Limit - Corrected Reading**

7.6.2 Measurement Results

Performed by: Thierry Jean-Charles

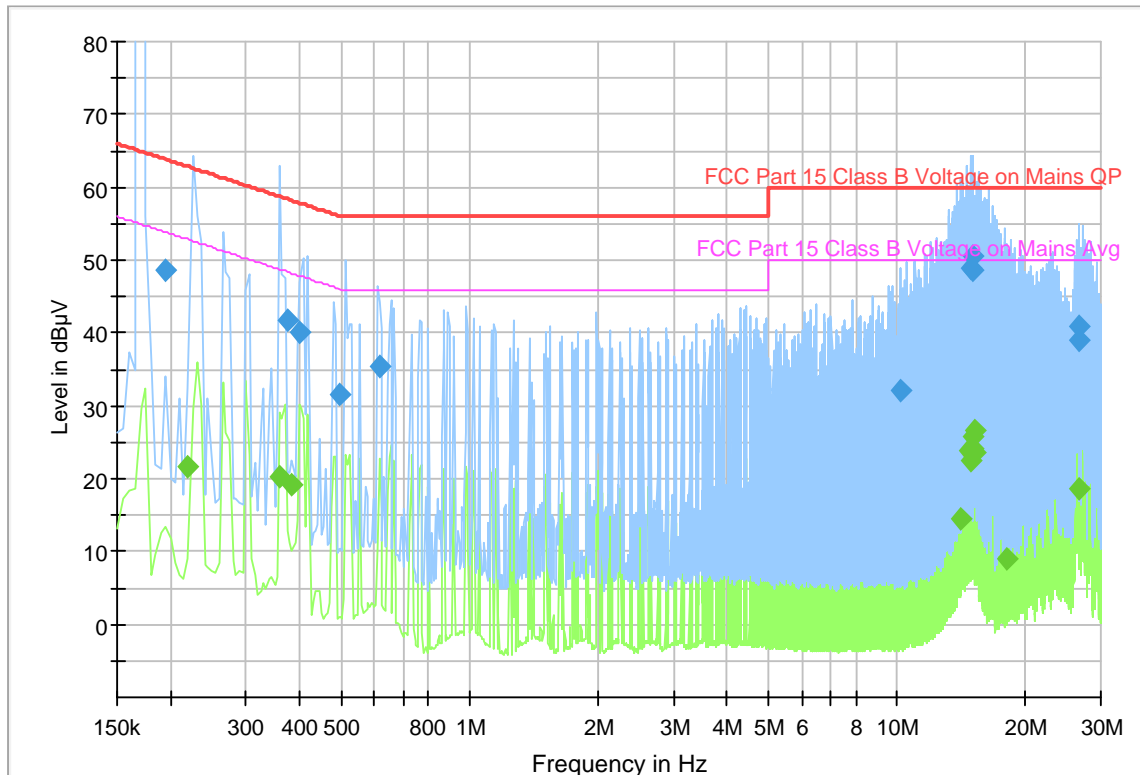

Figure 7.6.2-1: Conducted Emissions Results

Table 7.6.2-1: Conducted EMI Results – Quasi-Peak

Frequency (MHz)	QuasiPeak (dB $\mu$ V)	Limit (dB $\mu$ V)	Margin (dB)	Meas. Time (ms)	Bandwidth (kHz)	Line	PE	Corr. (dB)
0.195000	48.55	63.82	15.27	1000.0	10.000	N	GND	10.2
0.375000	41.82	58.39	16.57	1000.0	10.000	N	GND	10.2
0.400000	40.21	57.85	17.64	1000.0	10.000	L1	GND	10.1
0.495000	31.68	56.08	24.40	1000.0	10.000	L1	GND	10.1
0.615000	35.49	56.00	20.51	1000.0	10.000	L1	GND	10.1
10.190000	32.00	60.00	28.00	1000.0	10.000	L1	GND	11.2
14.810000	48.79	60.00	11.21	1000.0	10.000	N	GND	11.6
15.050000	50.56	60.00	9.44	1000.0	10.000	L1	GND	11.8
15.060000	48.66	60.00	11.34	1000.0	10.000	L1	GND	11.8
26.570000	39.03	60.00	20.97	1000.0	10.000	L1	GND	12.4
26.685000	40.85	60.00	19.15	1000.0	10.000	L1	GND	12.4

Table 7.6.2-2: Conducted EMI Results - Average

Frequency (MHz)	Average (dB $\mu$ V)	Limit (dB $\mu$ V)	Margin (dB)	Meas. Time (ms)	Bandwidth (kHz)	Line	PE	Corr. (dB)
0.220000	21.70	52.82	31.12	1000.0	10.000	N	GND	10.2
0.360000	20.31	48.73	28.42	1000.0	10.000	N	GND	10.2
0.385000	19.24	48.17	28.93	1000.0	10.000	L1	GND	10.1
14.075000	14.42	50.00	35.58	1000.0	10.000	N	GND	11.5
14.685000	23.87	50.00	26.13	1000.0	10.000	N	GND	11.6
14.875000	22.46	50.00	27.54	1000.0	10.000	N	GND	11.6
15.040000	24.22	50.00	25.78	1000.0	10.000	L1	GND	11.8
15.060000	25.73	50.00	24.27	1000.0	10.000	N	GND	11.6
15.170000	23.49	50.00	26.51	1000.0	10.000	N	GND	11.6
15.230000	26.65	50.00	23.35	1000.0	10.000	L1	GND	11.8
17.970000	8.90	50.00	41.10	1000.0	10.000	N	GND	11.8
26.635000	18.68	50.00	31.32	1000.0	10.000	L1	GND	12.4

## 8 MEASUREMENT UNCERTAINTIES

The expanded laboratory measurement uncertainty figures ( $U_{\text{Lab}}$ ) provided below correspond to an expansion factor (coverage factor)  $k = 1.96$  which provide confidence levels of 95%.

**Table 8-1: Measurement Uncertainties**

Parameter	$U_{\text{lab}}$
Occupied Channel Bandwidth	$\pm 0.009 \%$
RF Conducted Output Power	$\pm 1.15 \text{ dB}$
Power Spectral Density	$\pm 1.15 \text{ dB}$
Antenna Port Conducted Emissions	$\pm 1.15 \text{ dB}$
Radiated Emissions $\leq 1\text{GHz}$	$\pm 5.86 \text{ dB}$
Radiated Emissions $> 1\text{GHz}$	$\pm 4.65 \text{ dB}$
Temperature	$\pm 0.860 \text{ }^\circ\text{C}$
Radio Frequency	$\pm 2.832 \times 10^{-8}$
AC Power Line Conducted Emissions	$\pm 3.72 \text{ dB}$

**9 CONCLUSION**

In the opinion of TÜV SÜD America, Inc. the models SWPD01-DC, manufactured by Cooper Lighting LLC, meets the requirements of FCC Part 15.247 and Industry Canada's Radio Standards Specification RSS-247 for the tests documented herein.

**END REPORT**