



FCC/ IC - TEST REPORT

Report Number : **68.912.20.0016.01** Date of Issue: August 7, 2020

Model : **WWB1-W, WWB1-W-CUST, WWB3-W, WWB3-W-CUST, WWB3-RL-W, WWB3-RL-W-CUST, WWB5-RL-W, WWB5-RL-W-CUST**

Product Type : WaveLinx Lite Wallstation

Applicant : Cooper Lighting LLC

Address : 1121 Hwy 74 s., Peachtree City, GA 30269, United States

Production Facility : LEEDARSON LIGHTING CO., LTD

Address : Xingda Road, Xingtai Industrial Zone, Changtai County, Zhangzhou, Fujian, China

Test Result : **Positive** **Negative**

Total pages including Appendices : **33**

TÜV SÜD Certification and Testing (China) Co., Ltd. Shenzhen Branch is a subcontractor to TÜV SÜD Product Service GmbH according to the principles outlined in ISO 17025.

TÜV SÜD Certification and Testing (China) Co., Ltd. Shenzhen Branch reports apply only to the specific samples tested under stated test conditions. Construction of the actual test samples has been documented. It is the manufacturer's responsibility to assure that additional production units of this model are manufactured with identical electrical and mechanical components. The manufacturer/importer is responsible to the Competent Authorities in Europe for any modifications made to the production units which result in non-compliance to the relevant regulations. TÜV SÜD Certification and Testing (China) Co., Ltd. Shenzhen Branch shall have no liability for any deductions, inferences or generalizations drawn by the client or others from TÜV SÜD Certification and Testing (China) Co., Ltd. Shenzhen Branch issued reports.

This report is the confidential property of the client. As a mutual protection to our clients, the public and ourselves, extracts from the test report shall not be reproduced except in full without our written approval.



1 Table of Contents

1	Table of Contents	2
2	Details about the Test Laboratory.....	3
3	Description of the Equipment under Test	4
4	Summary of Test Standards.....	5
5	Summary of Test Results.....	6
6	General Remarks	7
7	Test Setups	8
8	Systems test configuration.....	9
9	Technical Requirement	10
9.1	Conducted Peak output power	10
9.2	6 dB Bandwidth and 99% Occupied Bandwidth	12
9.3	Power spectral density.....	15
9.4	Spurious RF conducted emissions	17
9.5	Band edge	21
9.6	Spurious radiated emissions for transmitter	23
10	Test Equipment List.....	31
11	System Measurement Uncertainty	33



2 Details about the Test Laboratory

Details about the Test Laboratory

Test Site 1

Company name: TÜV SÜD Certification and Testing (China) Co., Ltd. Shenzhen Branch
Building 12&13, Zhiheng Wisdomland Business Park,
Nantou Checkpoint Road 2, Nanshan District,
Shenzhen City, 518052,
P. R. China

FCC Registration Number: 514049

FCC Designation Number: CA5009

ISED#: 10320A

Telephone: 86 755 8828 6998
Fax: 86 755 8828 5299

3 Description of the Equipment under Test

Product/PMN:	WaveLinx Lite Wallstation
Model no./HVIN:	WWB5-RL-W
FCC ID:	2AKCY-WWBZIG
IC:	4706A-WWBZIG
Ratings:	3VDC
RF Transmission Frequency:	2405MHz-2480MHz
No. of Operated Channel:	16
Modulation:	OQPSK
Antenna Type:	PIFA antenna
Antenna Gain:	2.9dBi
Description of the EUT:	The Equipment Under Test (EUT) is a WaveLinx Lite Wallstation supports 2.4GHz Zigbee function.

4 Summary of Test Standards

Test Standards	
FCC Part 15 Subpart C 10-1-2019 Edition	PART 15 - RADIO FREQUENCY DEVICES Subpart C - Intentional Radiators
RSS-Gen Issue 5, Amendment 1, March 2019	General Requirements and Information for the Certification of Radio Apparatus
RSS-247 Issue 2 February 2017	Digital Transmission Systems (DTSS), Frequency Hopping Systems (FHSS) and License-Exempt Local Area Network (LE-LAN) Devices

All the test methods were according to KDB558074 D01 15.247 Meas Guidance v05r02 Measurement Guidance and ANSI C63.10 (2013).

5 Summary of Test Results

Test Condition		Test Site	Test Result		
			Pass	Fail	N/A
§15.207 RSS-GEN 8.8	Conducted emission AC power port	Note 3	<input type="checkbox"/>	<input type="checkbox"/>	<input checked="" type="checkbox"/>
§15.247 (b) (3) & RSS-247 5.4(d)	Conducted peak output power	Site 1	<input checked="" type="checkbox"/>	<input type="checkbox"/>	<input type="checkbox"/>
§15.247(a)(1) RSS-247 5.1(b)	20dB bandwidth	---	<input type="checkbox"/>	<input type="checkbox"/>	<input checked="" type="checkbox"/>
§15.247(a)(1) §RSS-247 5.1(b)	Carrier frequency separation	---	<input type="checkbox"/>	<input type="checkbox"/>	<input checked="" type="checkbox"/>
RSS-247 5.4(d)	Equivalent Isotropic Radiated Power	Site 1	<input checked="" type="checkbox"/>	<input type="checkbox"/>	<input type="checkbox"/>
RSS-GEN 6.7	99% Occupied Bandwidth	Site 1	<input checked="" type="checkbox"/>	<input type="checkbox"/>	<input type="checkbox"/>
§15.247(a)(1)(iii) RSS-247 5.1(d)	Number of hopping frequencies	---	<input type="checkbox"/>	<input type="checkbox"/>	<input checked="" type="checkbox"/>
§15.247(a)(1)(iii) RSS-247 5.1(d)	Dwell Time	---	<input type="checkbox"/>	<input type="checkbox"/>	<input checked="" type="checkbox"/>
RSS-247 5.2(a)	6dB bandwidth and 99% Occupied Bandwidth	Site 1	<input checked="" type="checkbox"/>	<input type="checkbox"/>	<input type="checkbox"/>
§15.247(e) RSS-247 5.2(b)	Power spectral density	Site 1	<input checked="" type="checkbox"/>	<input type="checkbox"/>	<input type="checkbox"/>
§15.247(d) RSS-247 5.5	Spurious RF conducted emissions	Site 1	<input checked="" type="checkbox"/>	<input type="checkbox"/>	<input type="checkbox"/>
§15.247(d) RSS-247 5.5	Band edge	Site 1	<input checked="" type="checkbox"/>	<input type="checkbox"/>	<input type="checkbox"/>
§15.247(d) & §15.209 & §15.205 RSS-247 5.5 & RSS-Gen 6.13	Spurious radiated emissions for transmitter	Site 1	<input checked="" type="checkbox"/>	<input type="checkbox"/>	<input type="checkbox"/>
§15.203 RSS-Gen 6.8	Antenna requirement	Note 2	<input checked="" type="checkbox"/>	<input type="checkbox"/>	<input type="checkbox"/>

Note 1: N/A=Not Applicable.

Note 2: The EUT uses a PIFA antenna, which gain is 2.9dBi. In accordance to RSS-Gen 6.8, it is considered sufficiently to comply with the provisions of this section;

Note 3: The EUT is not intended to operate from the AC power lines;

6 General Remarks

Remarks

This submittal(s) (test report) is intended for FCC ID: 2AKCY-WWBZIG and IC: 4706A-WWBZIG complies with Section 15.207, 15.205, 15.209, 15.247 of the FCC Part 15, Subpart C Rules; RSS-Gen Issue 5 and RSS-247 issue 2.

All models are identical except their mechanical design is a little different. Such as the number of buttons or the icon of the buttons. So all the tests were applied on WW5-RL-W, other models are deemed to fulfill the requirement without testing.

SUMMARY:

All tests according to the regulations cited on page 5 were

- Performed

- **Not** Performed

The Equipment under Test

- **Fulfills** the general approval requirements.

- **Does not** fulfill the general approval requirements.

Sample Received Date: July 28, 2020

Testing Start Date: July 28, 2020

Testing End Date: August 3, 2020

- TÜV SÜD Certification and Testing (China) Co., Ltd. Shenzhen Branch -

Reviewed by:

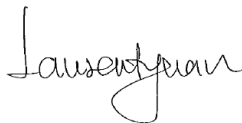

Laurent Yuan
EMC Project Manager

Prepared by:



Henry Chen
EMC Project Engineer

Tested by:



Louise Liu
EMC Test Engineer

7 Test Setups

7.1 Radiated test setups

Below 1GHz

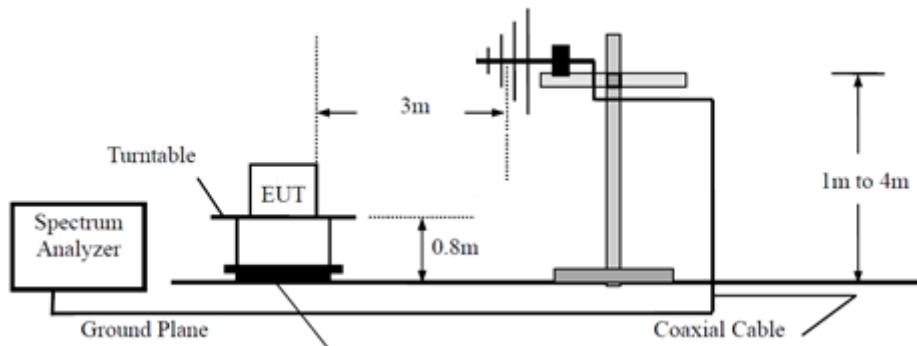

Above 1GHz

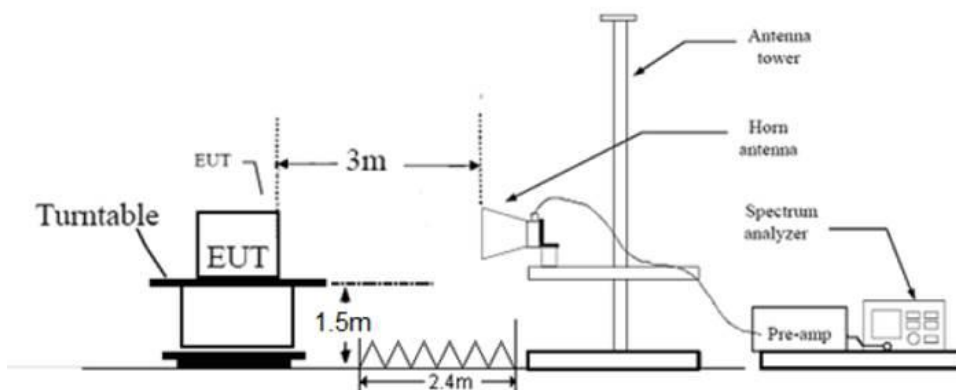

7.2 Conducted RF test setups

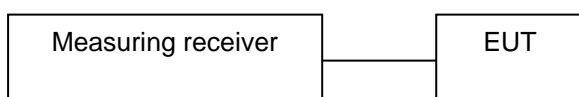

8 Systems test configuration

Auxiliary Equipment Used during Test:

DESCRIPTION	MANUFACTURER	MODEL NO.	S/N
---	---	---	---

Test software information:

Test Software Version	EMI_Test_Tool	
Modulation	Setting TX Power	Packet Type
OQPSK	8dBm	/

The system was configured to channel 11, 19, and 26 for the test.

9 Technical Requirement

9.1 Conducted Peak output power

Test Method

1. Connect the power meter to the EUT
 - a) The EUT is configured to transmit continuously, or to transmit with a constant duty factor.
 - b) At all times the EUT is transmitting at its maximum power control level.
 - c) The integration period of the power meter exceeds the repetition period of the transmitted signal by at least a factor of five.
2. Measure the average power of the transmitter. This measurement is an average over both the on and off periods of the transmitter.
3. Adjust the measurement in dBm by adding $10\log(1/x)$, where x is the duty cycle to the measurement result.

Limits

Conducted peak output power limit as below:

Frequency Range MHz	Limit W	Limit dBm
2400-2483.5	≤1	≤30

For e.i.r.p limit as below:

Frequency Range MHz	Limit W	Limit dBm
2400-2483.5	≤4	≤30

Test result as below table

Frequency MHz	Conducted Peak Output Power dBm	Antenna Gain dBi	EIRP dBm	Result
Bottom channel 2405MHz	6.70	2.9	9.60	Pass
Middle channel 2445MHz	6.74	2.9	9.64	Pass
Top channel 2480MHz	6.68	2.9	9.58	Pass

Test Graphs

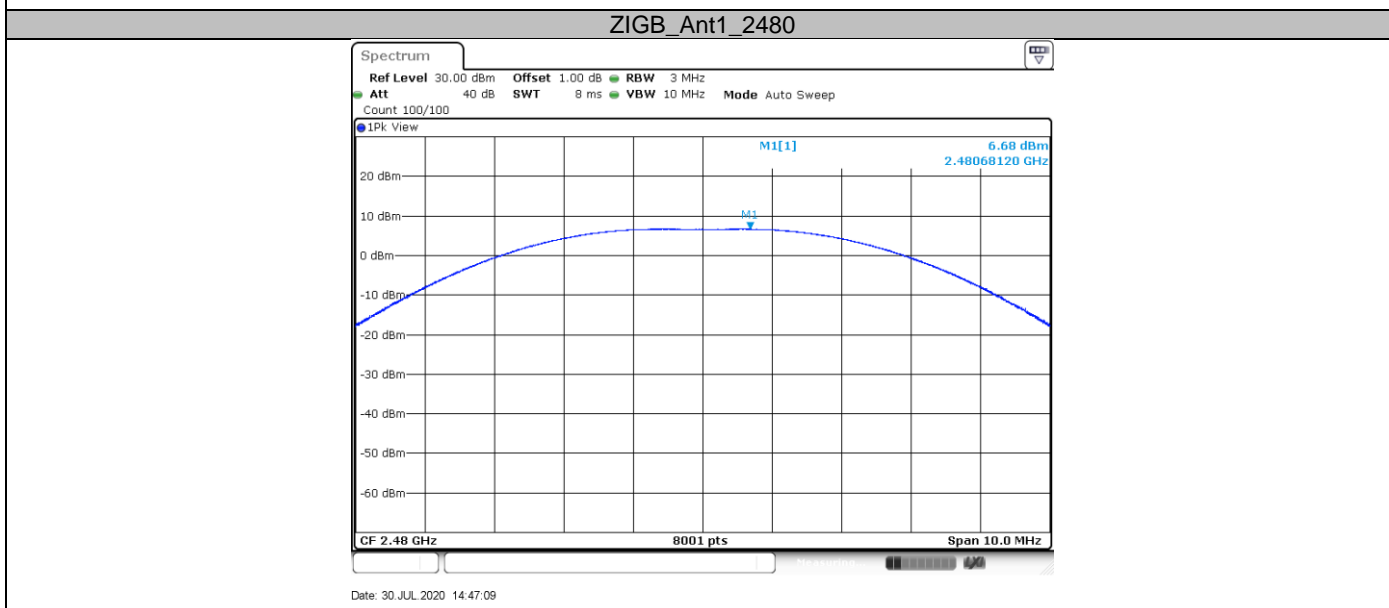
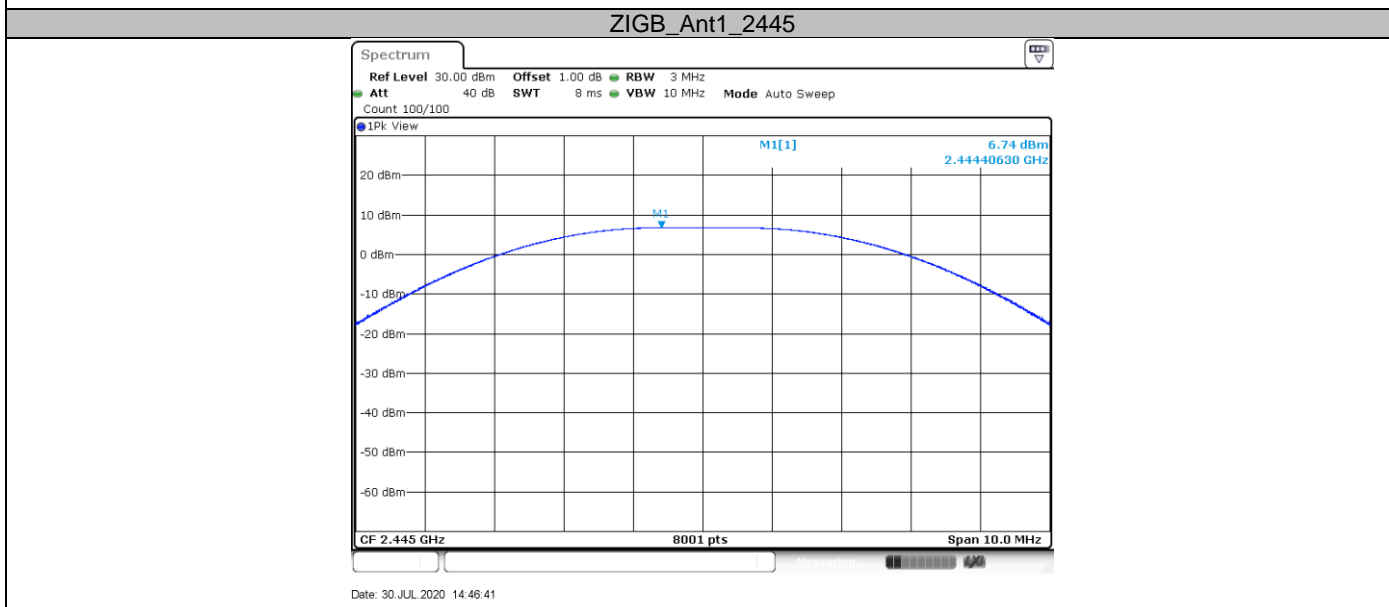
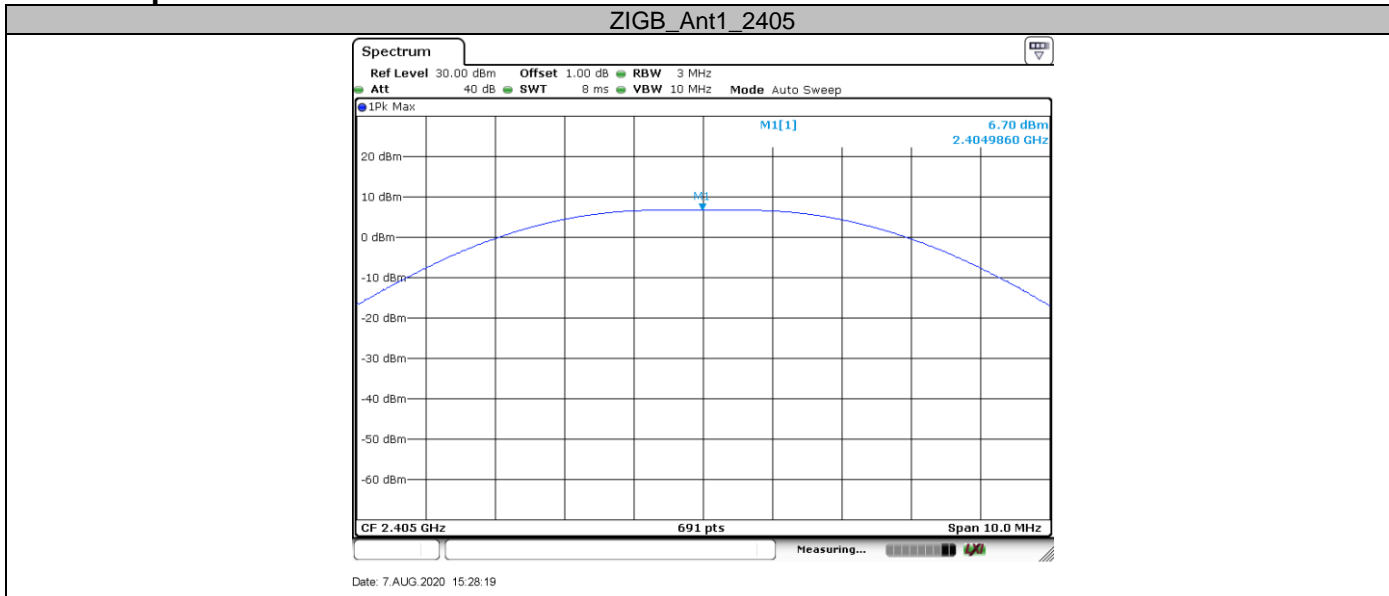

9.2 6 dB Bandwidth and 99% Occupied Bandwidth

Test Method

1. Use the following spectrum analyzer settings:
RBW=100K, VBW≥3RBW, Sweep = auto, Detector function = peak, Trace = max hold
2. Use the automatic bandwidth measurement capability of an instrument, may be employed using the X dB bandwidth mode with X set to 6 dB, care shall be taken so that the bandwidth measurement is not influenced by any intermediate power nulls in the fundamental emission that might be ≥ 6 dB.
3. Allow the trace to stabilize, record the X dB Bandwidth value.

Limit

Limit [kHz]

≥500

Test result

Frequency MHz	6dB bandwidth MHz	99% bandwidth MHz	Result
Bottom channel 2405MHz	1.860	2.288	Pass
Middle channel 2445MHz	1.670	2.298	Pass
Top channel 2480MHz	1.660	2.288	Pass

Test Graphs

ZIGB_Ant1_2405

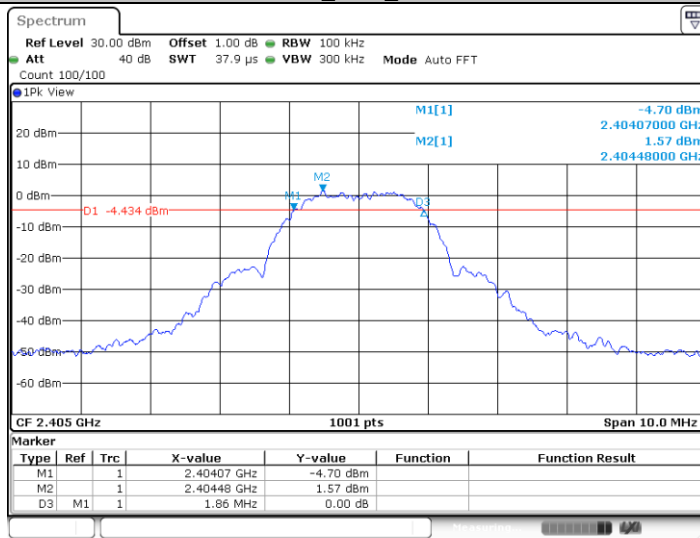

Date: 27.JUL.2020 12:08:30

ZIGB_Ant1_2445

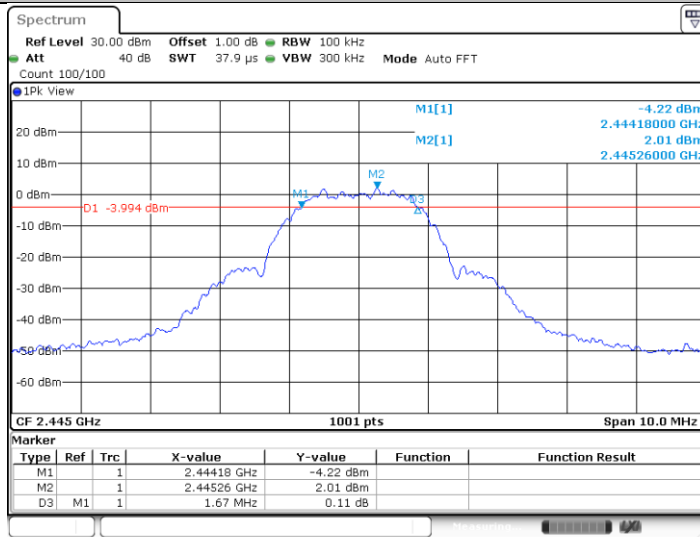

Date: 27.JUL.2020 12:13:18

ZIGB_Ant1_2480

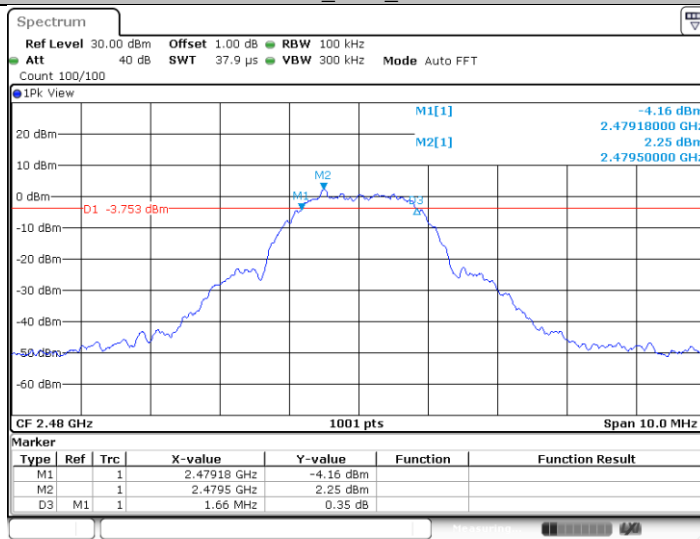

Date: 27.JUL.2020 12:15:50

ZIGB_Ant1_2405

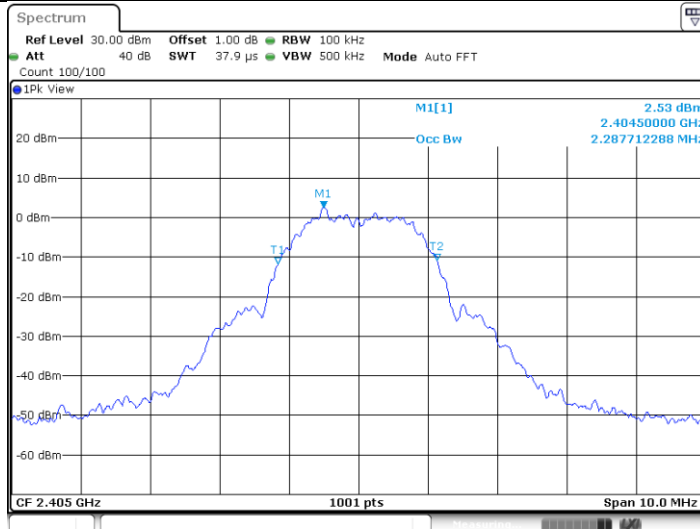

Date: 27 JUL 2020 12:09:35

ZIGB_Ant1_2445

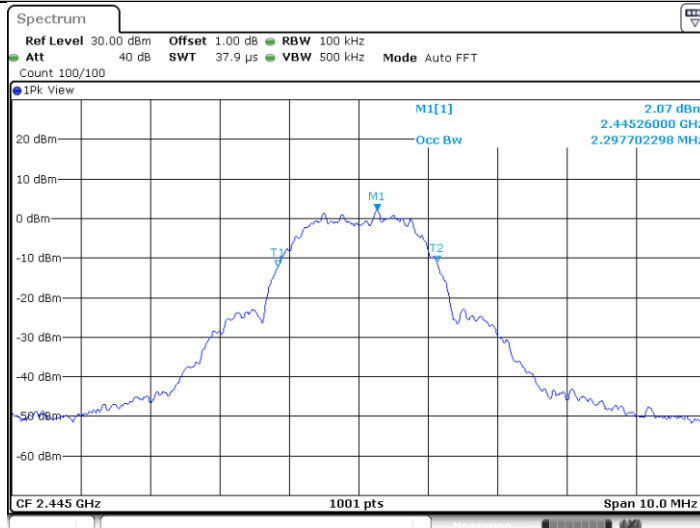

Date: 27 JUL 2020 12:13:28

ZIGB_Ant1_2480

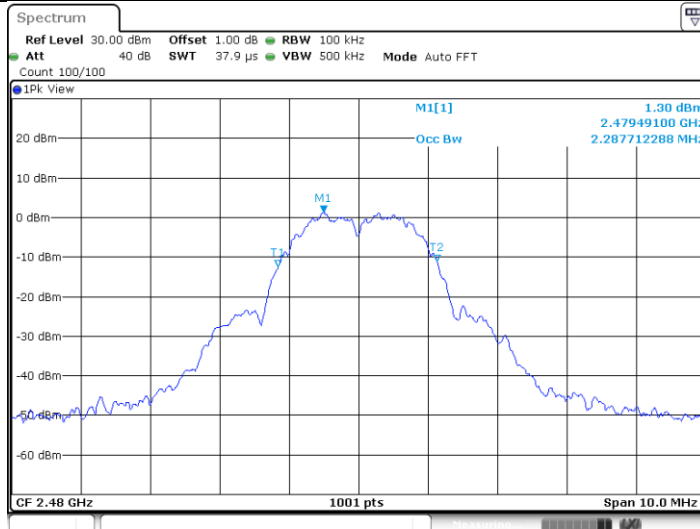

Date: 27 JUL 2020 12:16:01



9.3 Power spectral density

Test Method

This procedure shall be used if maximum peak conducted output power was used to demonstrate compliance:

1. Set analyzer center frequency to DTS channel center frequency. RBW=3kHz, VBW≥3RBW, Span=1.5 times DTS bandwidth, Detector=Peak, Sweep=auto, Trace= max hold.
2. Allow trace to fully stabilize, use the peak marker function to determine the maximum amplitude level within the RBW.
3. Repeat above procedures until other frequencies measured were completed.

Limit

Limit [dBm/3KHz]

≤8

Test result

Frequency MHz	Power spectral density dBm/10KHz	Result
Top channel 2405MHz	-3.35	Pass
Middle channel 2445MHz	-4.1	Pass
Bottom channel 2480MHz	-3.99	Pass

Test Graphs

ZIGB_Ant1_2405

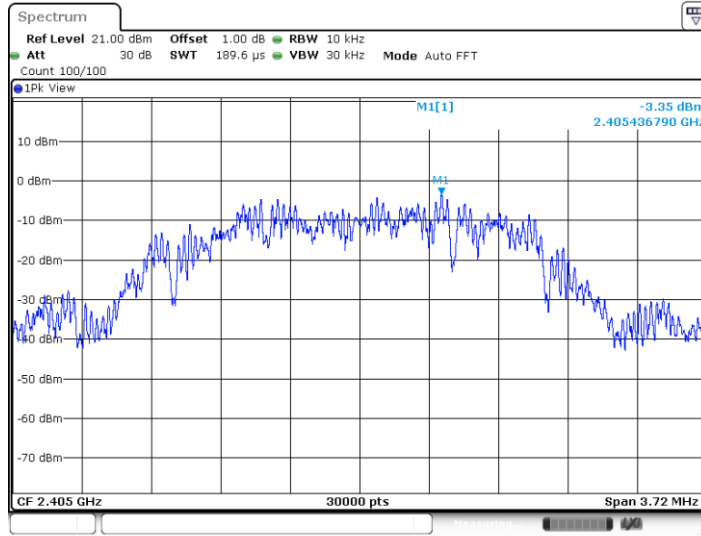

Date: 27.JUL.2020 12:09:47

ZIGB_Ant1_2445

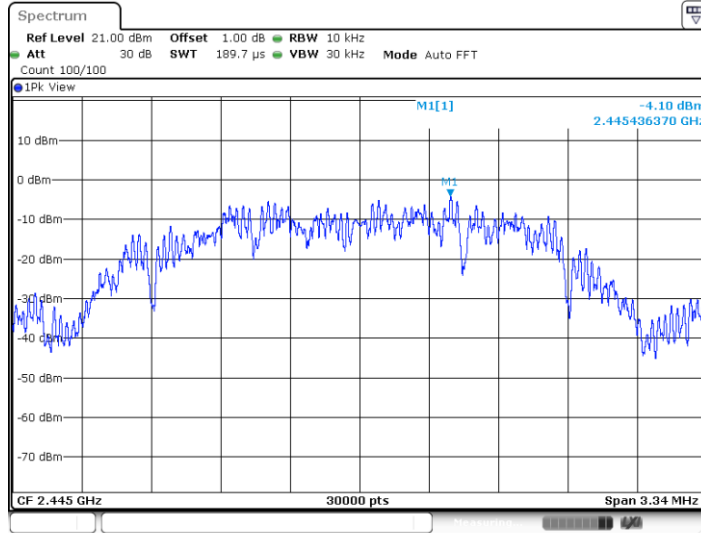

Date: 27.JUL.2020 12:13:40

ZIGB_Ant1_2480

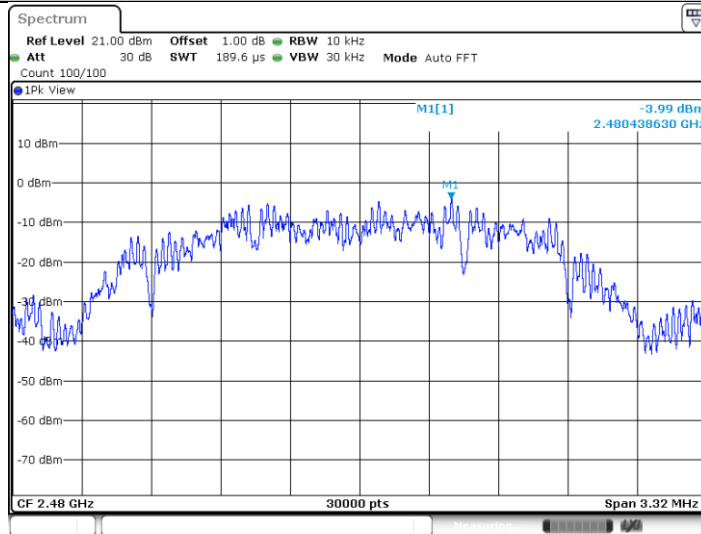

Date: 27.JUL.2020 12:16:13

9.4 Spurious RF conducted emissions

Test Method

1. Establish a reference level by using the following procedure:
 - a. Set RBW=100 kHz. VBW≥3RBW. Detector =peak, Sweep time = auto couple, Trace mode = max hold.
 - b. Allow trace to fully stabilize, use the peak marker function to determine the maximum PSD level.
2. Use the maximum PSD level to establish the reference level.
 - a. Set the center frequency and span to encompass frequency range to be measured.
 - b. Use the peak marker function to determine the maximum amplitude level. Ensure that the amplitude of all unwanted emissions outside of the authorized frequency band (excluding restricted frequency bands) are attenuated by at least the minimum requirements, report the three highest emissions relative to the limit.
3. Repeat above procedures until other frequencies measured were completed.

Limit

Frequency Range MHz	Limit (dBc)
30-25000	-20

Test Result:

Test Mode	Antenna	Channel (MHz)	Freq Range (MHz)	Ref Level (dBm)	Result (dBm)	Limit (dBm)	Verdict
Zigbee	ANT1	2405	30~1000	3.96	-67.97	-16.04	PASS
Zigbee	ANT1	2405	1000~26500	3.96	-52.19	-16.04	PASS
Zigbee	ANT1	2445	30~1000	4.65	-67.79	-15.35	PASS
Zigbee	ANT1	2445	1000~26500	4.65	-51.73	-15.35	PASS
Zigbee	ANT1	2480	30~1000	4.94	-67.91	-15.06	PASS
Zigbee	ANT1	2480	1000~26500	4.94	-52.73	-15.06	PASS

Test Graphs

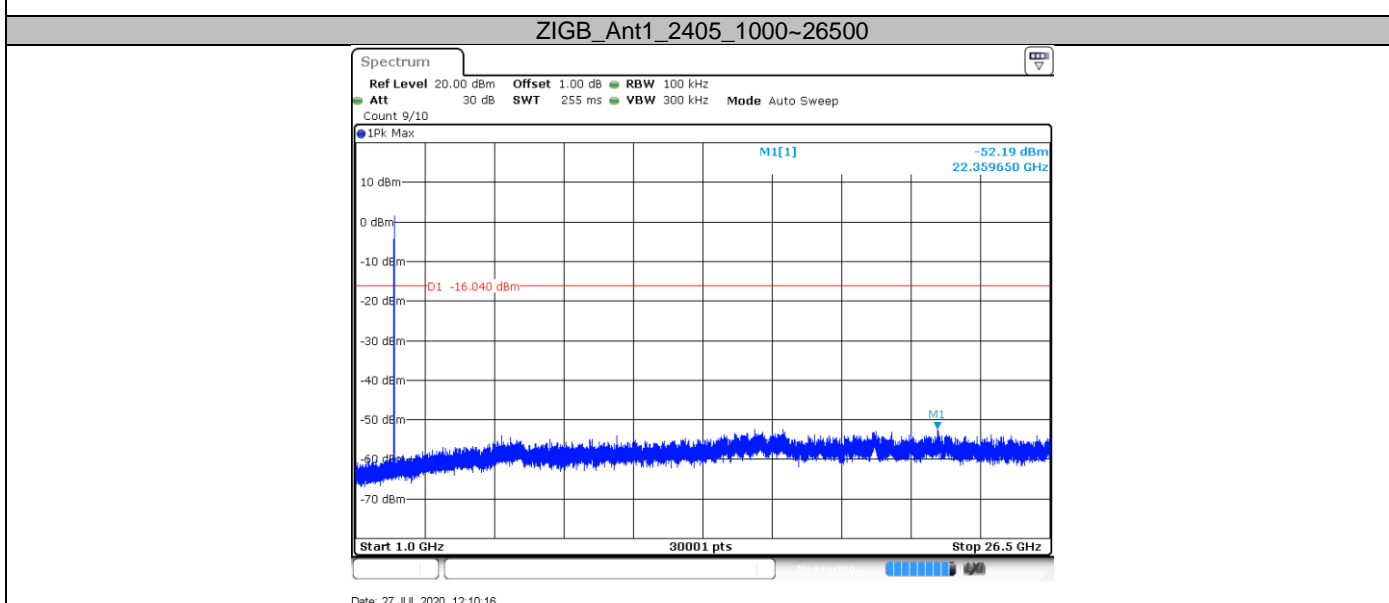
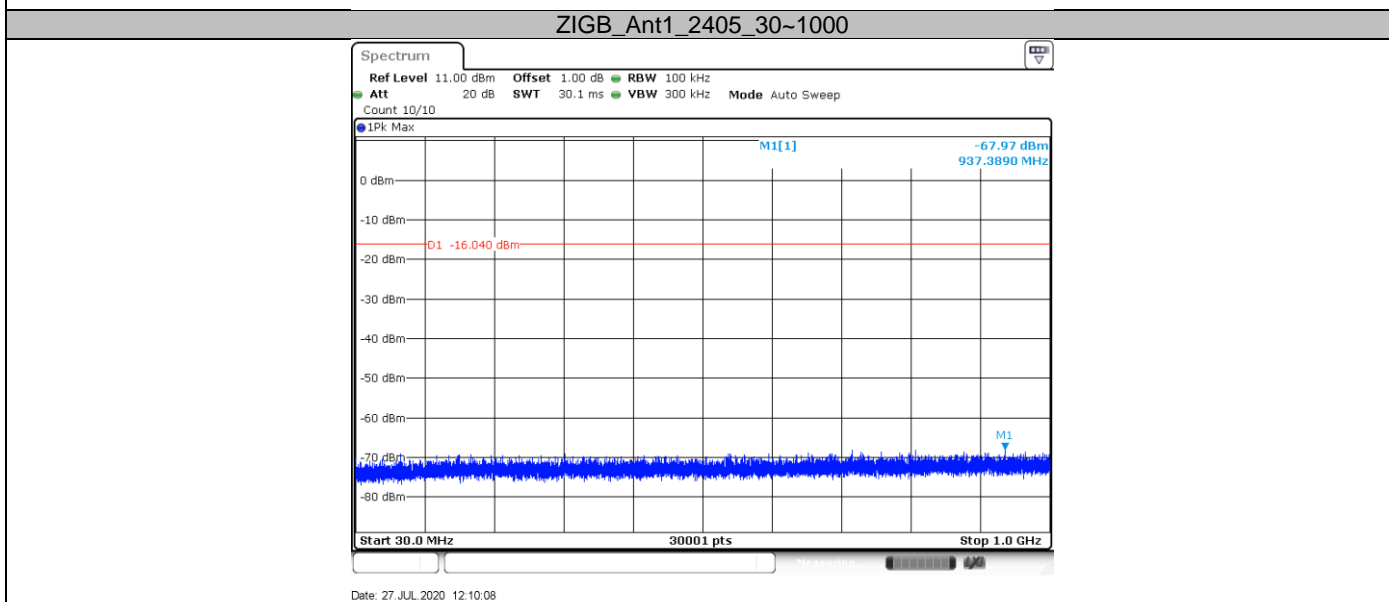
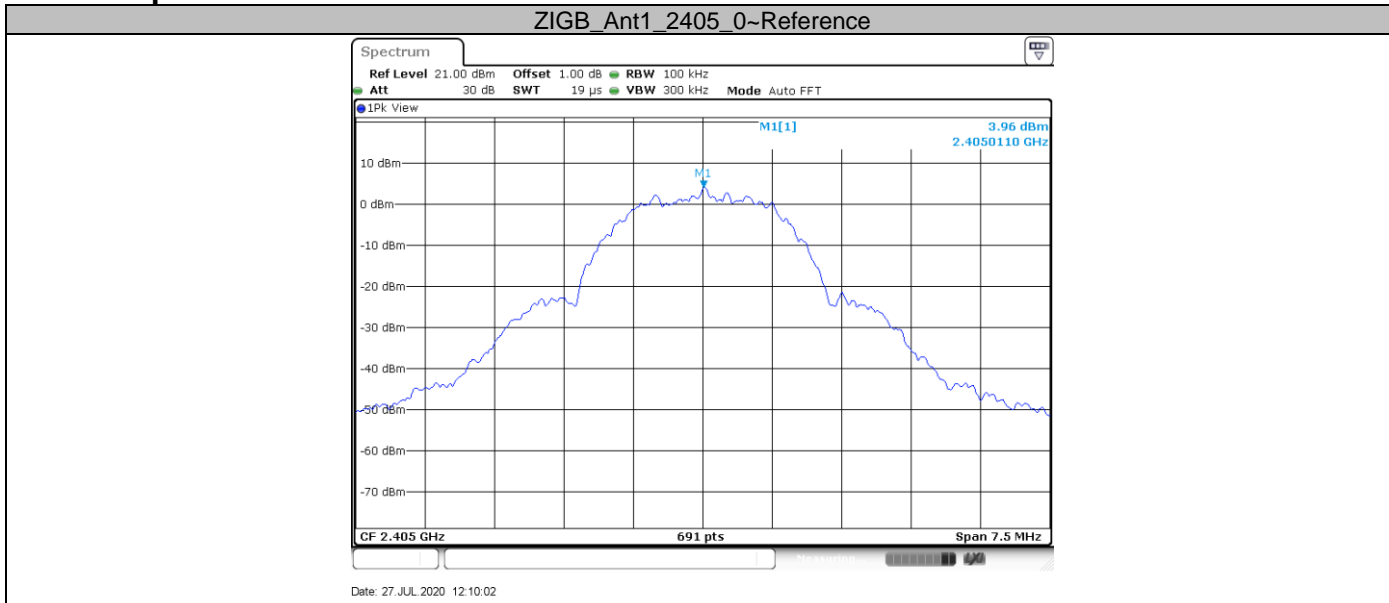

ZIGB_Ant1_2445_0~Reference

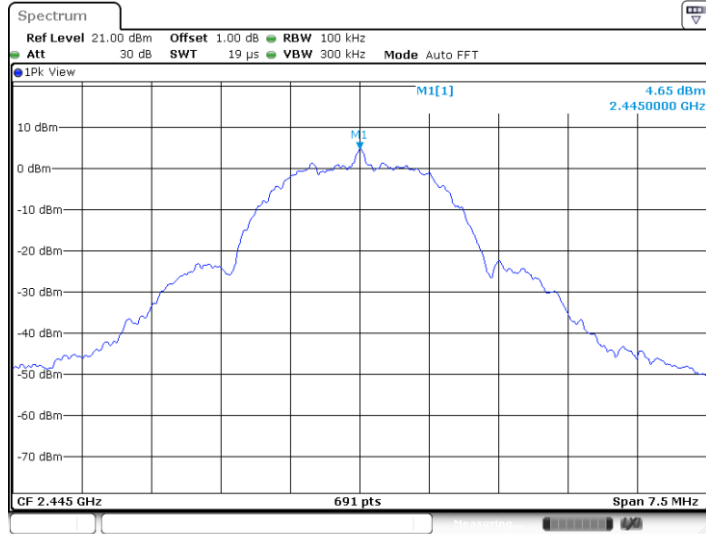

Date: 27 JUL 2020 12:13:46

ZIGB_Ant1_2445_30~1000

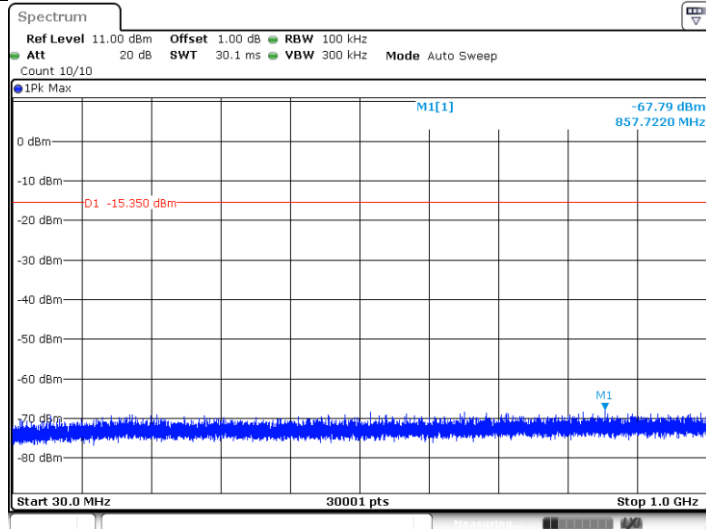

Date: 27 JUL 2020 12:13:52

ZIGB_Ant1_2445_1000~26500

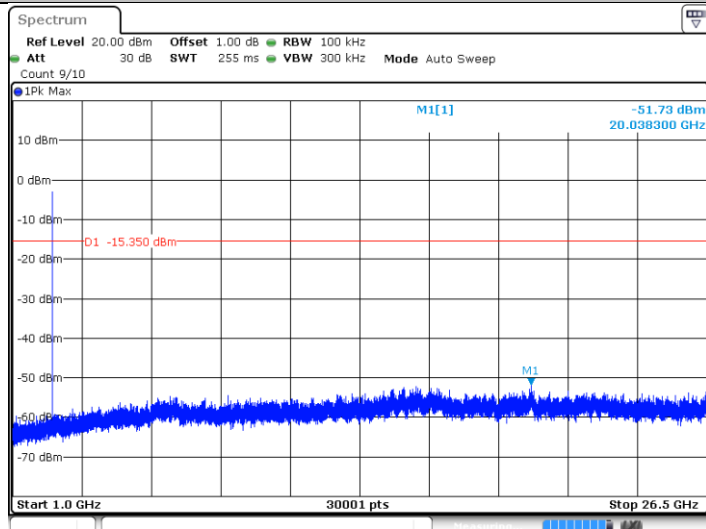

Date: 27 JUL 2020 12:14:00

ZIGB_Ant1_2480_0~Reference

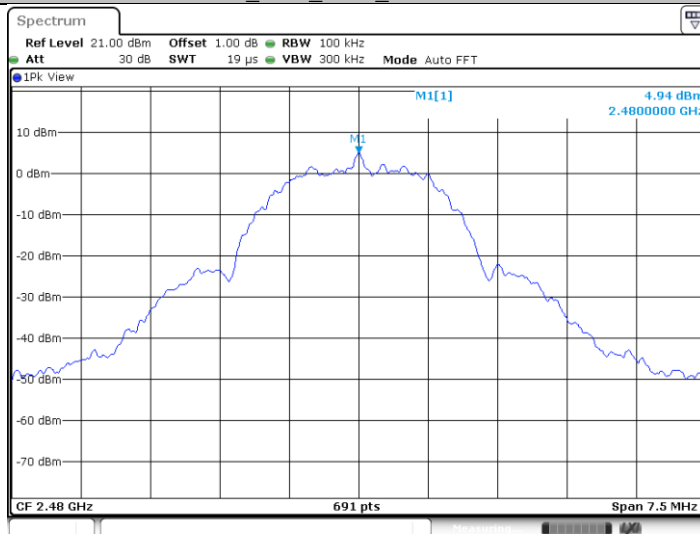

Date: 27.JUL.2020 12:16:28

ZIGB_Ant1_2480_30~1000

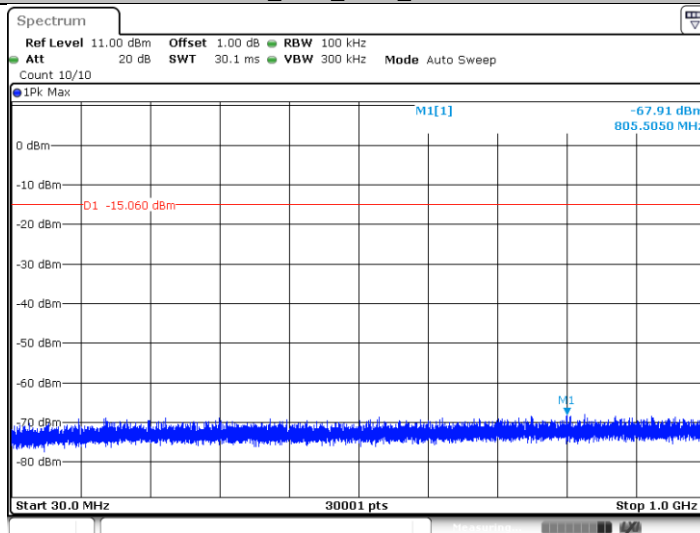

Date: 27.JUL.2020 12:16:34

ZIGB_Ant1_2480_1000~26500

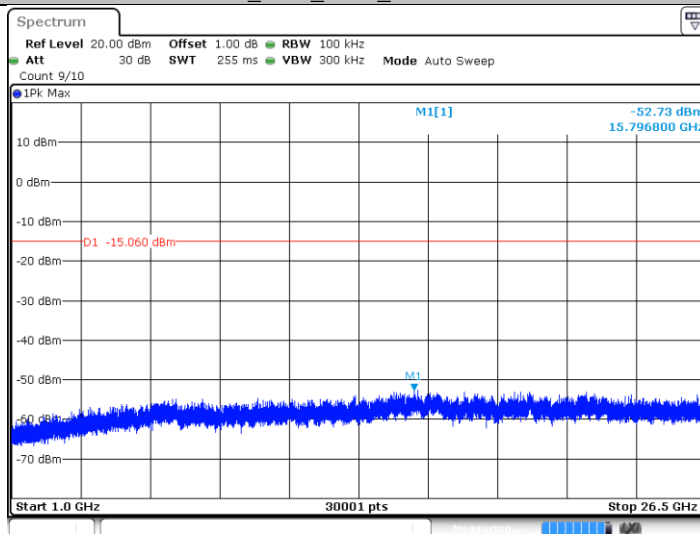

Date: 27.JUL.2020 12:16:42

9.5 Band edge

Test Method

- 1 Use the following spectrum analyzer settings:
Span = wide enough to capture the peak level of the in-band emission and all spurious
RBW = 100 kHz, VBW \geq RBW, Sweep = auto, Detector function = peak, Trace = max hold.
- 2 Allow the trace to stabilize, use the peak and delta measurement to record the result.
- 3 The level displayed must comply with the limit specified in this Section.

Limit

Frequency Range MHz	Limit (dBc)
30-25000	-20

Test result

Test Mode	Channel (MHz)	Reference Level(dBm)	Result (dBm)	Limit (dBm)	Verdict
Zigbee	2405	0.64	-54.56	-19.36	PASS
Zigbee	2480	2.64	-49.17	-17.36	PASS

Test Graphs

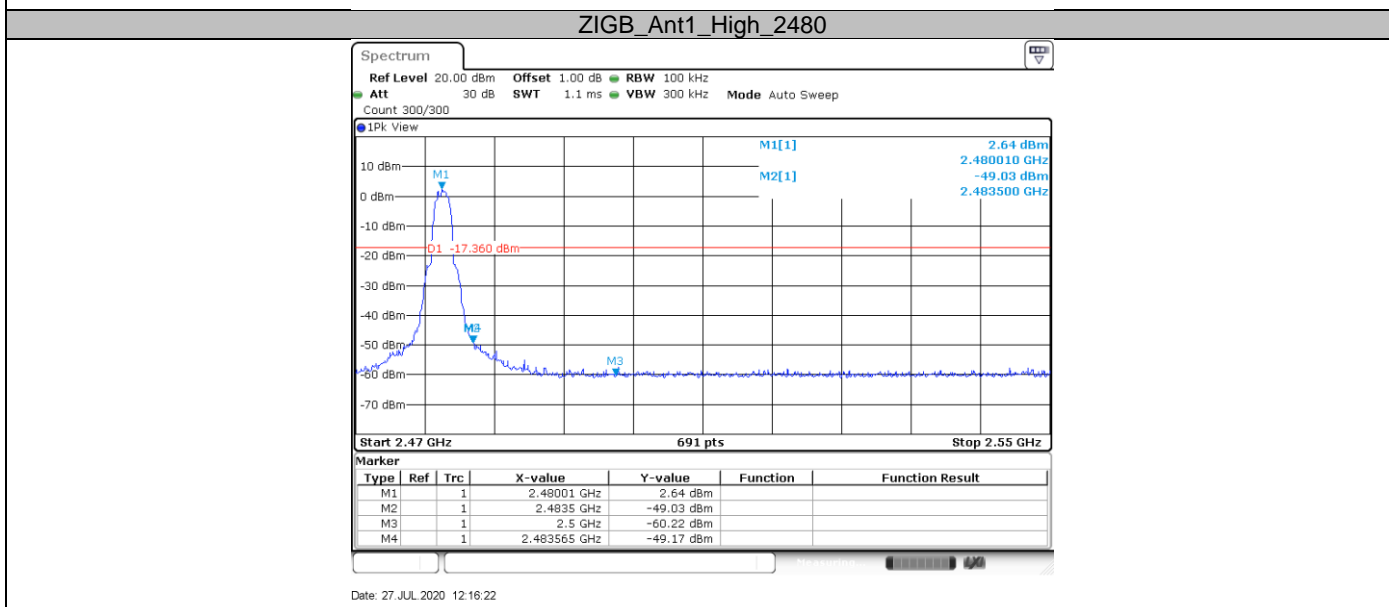
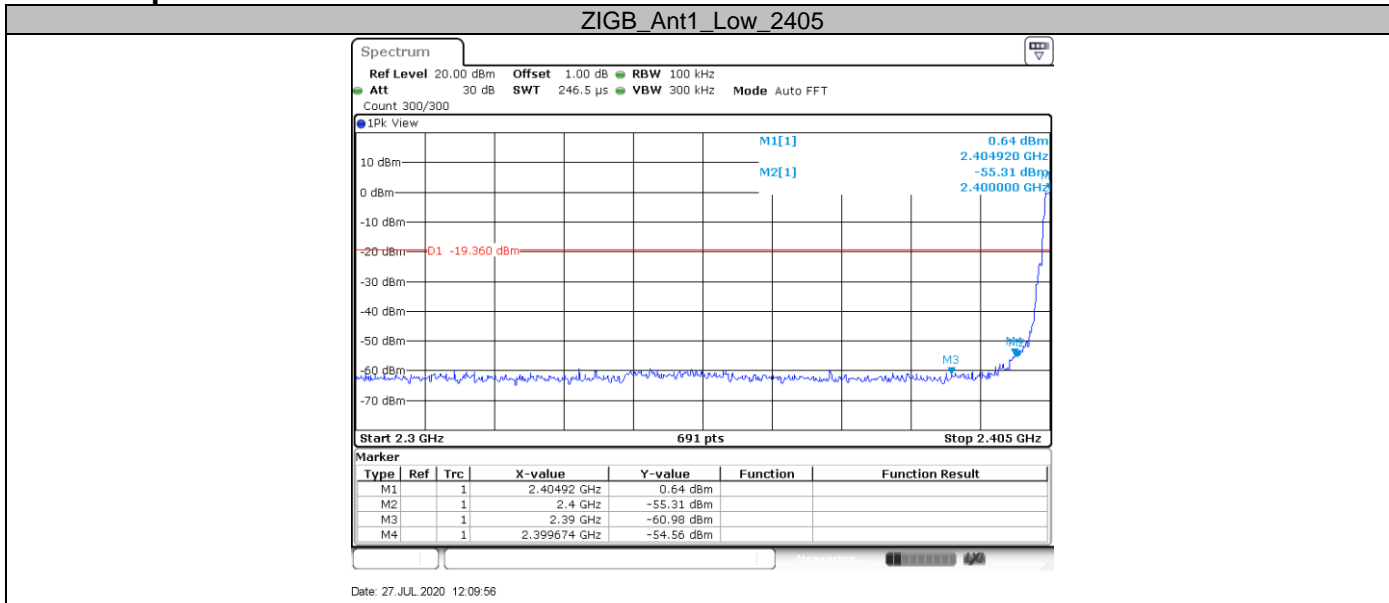

9.6 Spurious radiated emissions for transmitter

Test Method

- 1: The EUT was placed on a turn table which is 1.5m above ground plane for above 1GHz and 0.8m above ground for below 1GHz at 3 meter chamber room for test. The table was rotated 360 degrees to determine the position of the highest radiation.
- 2: The EUT was set 3 meters away from the interference – receiving antenna, which was mounted on the top of a variable – height antenna tower.
- 3: The height of antenna is varied from one meter to four meters above the ground to determine the maximum value of the field strength. Both horizontal and vertical polarizations of the antenna are set to make the measurement.
- 4: For each suspected emission, the EUT was arranged to its worst case and then the antenna was tuned to heights from 1 meter to 4 meters and the rotatable table was turned from 0 degrees to 360 degrees to find the maximum reading.
- 5: Use the following spectrum analyzer settings According to C63.10:

For Below 1GHz

Use the following spectrum analyzer settings:

Span = wide enough to capture the peak level of the in-band emission and all spurious
 RBW = 100 KHz to 120KHz, VBW ≥ RBW for peak measurement, Sweep = auto, Detector function = peak, Trace = max hold.

For Peak unwanted emissions Above 1GHz:

Span = wide enough to capture the peak level of the in-band emission and all spurious
 RBW = 1MHz, VBW ≥ RBW for peak measurement, Sweep = auto, Detector function = peak, Trace = max hold.

Procedures for average unwanted emissions measurements above 1000 MHz

a) RBW = 1MHz.

b) VBW \ [3 × RBW].

c) Detector = RMS (power averaging), if [span / (# of points in sweep)] \ RBW / 2.

Satisfying this condition can require increasing the number of points in the sweep or reducing the span. If the condition is not satisfied, then the detector mode shall be set to peak.

d) Averaging type = power (i.e., rms) (As an alternative, the detector and averaging type may be set for linear voltage averaging. Some instruments require linear display mode to use linear voltage averaging. Log or dB averaging shall not be used.)

e) Sweep time = auto.

f) Perform a trace average of at least 100 traces if the transmission is continuous. If the transmission is not continuous, then the number of traces shall be increased by a factor of 1 / D, where D is the duty cycle. For example, with 50% duty cycle, at least 200 traces shall be averaged. (If a specific emission is demonstrated to be continuous—i.e., 100% duty cycle—then rather than turning ON and OFF with the transmit cycle, at least 100 traces shall be averaged.)

g) If tests are performed with the EUT transmitting at a duty cycle less than 98%, then a correction factor shall be added to the measurement results prior to comparing with the emission limit, to compute the emission level that would have been measured had the test been performed at 100% duty cycle. The correction factor is computed as follows:

1) If power averaging (rms) mode was used in the preceding step e), then the correction factor is $[10 \log (1 / D)]$, where D is the duty cycle. For example, if the transmit duty cycle was 50%, then 3 dB shall be added to the measured emission levels.

- 2) If linear voltage averaging mode was used in the preceding step e), then the correction factor is $[20 \log (1 / D)]$, where D is the duty cycle. For example, if the transmit duty cycle was 50%, then 6 dB shall be added to the measured emission levels.
- 3) If a specific emission is demonstrated to be continuous (100% duty cycle) rather than turning ON and OFF with the transmit cycle, then no duty cycle correction is required for that emission.

Limit

The radio emission outside the operating frequency band shall be at least 20 dB below that in the 100 kHz bandwidth within the band that contains the highest level of the desired power. Radiated emissions which fall in the restricted bands, as defined in section RSS-GEN 8.10, must comply with the radiated emission limits specified in section 15.209.

Frequency MHz	Field Strength uV/m	Field Strength dBµV/m	Detector
30-88	100	40	QP
88-216	150	43.5	QP
216-960	200	46	QP
960-1000	500	54	QP
Above 1000	500	54	AV
Above 1000	5000	74	PK

According to C63.10, if the peak (or quasi-peak) measured value complies with the average limit, it is unnecessary to perform an average measurement, so AV emission value did not show in below table if the peak value complies with average limit.

Spurious radiated emissions for transmitter

Transmitting spurious emission test result as below:

Below 1G:

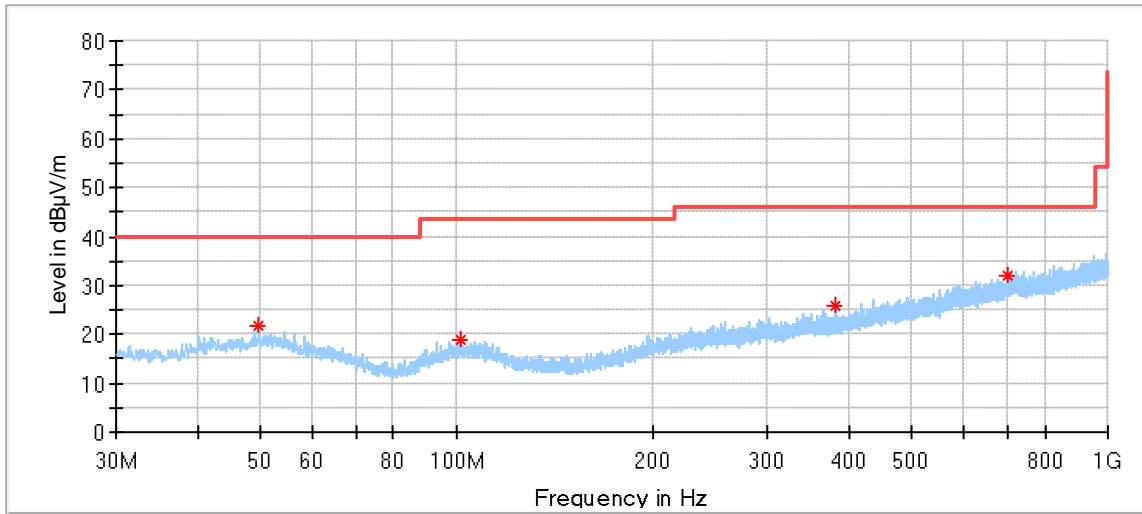

Frequency (MHz)	MaxPeak (dBµV/m)	Limit (dBµV/m)	Margin (dB)	Height (cm)	Pol	Azimuth (deg)	Corr. (dB/m)
49.723333	21.87	40.00	18.13	100.0	H	280.0	14.7
101.348889	18.75	43.50	24.75	100.0	H	115.0	12.2
381.625000	25.87	46.00	20.13	100.0	H	310.0	16.8
700.755000	31.89	46.00	14.11	100.0	H	331.0	23.0

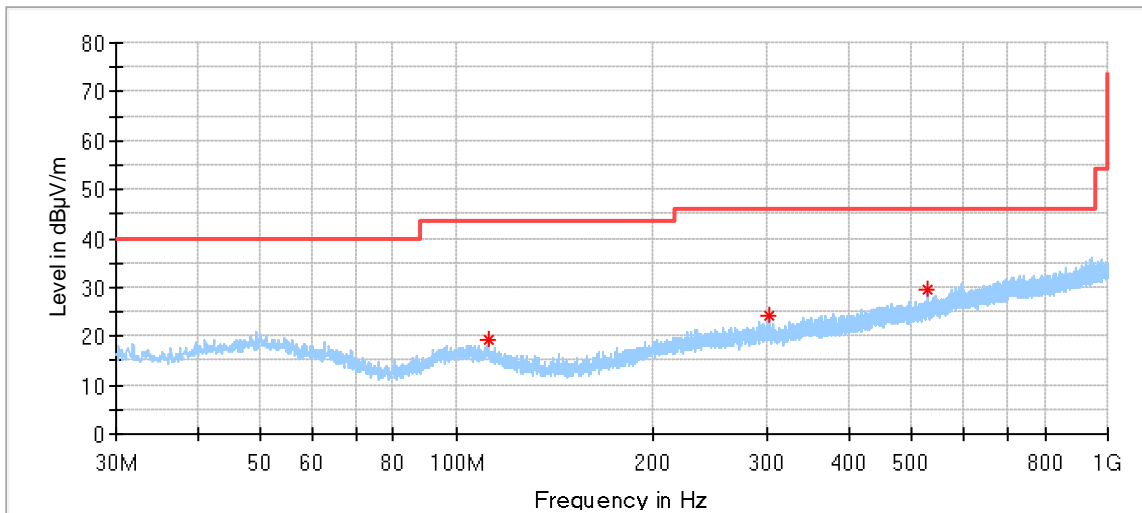

Frequency (MHz)	MaxPeak (dBµV/m)	Limit (dBµV/m)	Margin (dB)	Height (cm)	Pol	Azimuth (deg)	Corr. (dB/m)
111.695556	19.33	43.50	24.17	100.0	V	267.0	12.0
301.061111	24.26	46.00	21.74	100.0	V	159.0	15.3
528.795556	29.38	46.00	16.62	100.0	V	74.0	20.0

Low channel 2405MHz Test Result

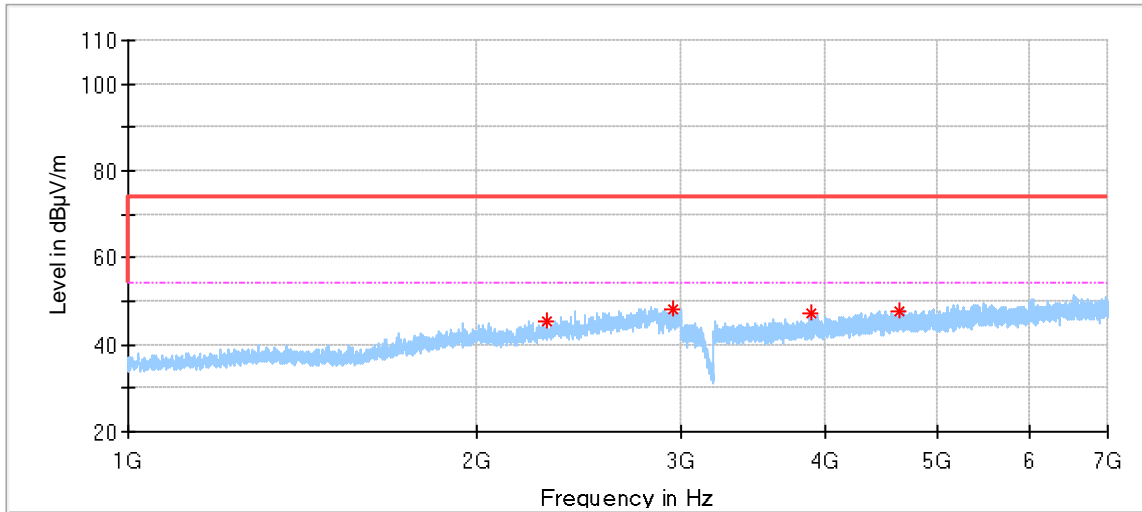

Frequency (MHz)	MaxPeak (dBµV/m)	Limit (dBµV/m)	Margin (dB)	Height (cm)	Pol	Azimuth (deg)	Corr. (dB/m)
2298.000000	45.26	74.00	28.74	150.0	H	60.0	-3.7
2947.000000	48.30	74.00	25.70	150.0	H	40.0	-0.6
3891.500000	47.10	74.00	26.90	150.0	H	250.0	0.8
4628.000000	47.63	74.00	26.37	150.0	H	23.0	3.2

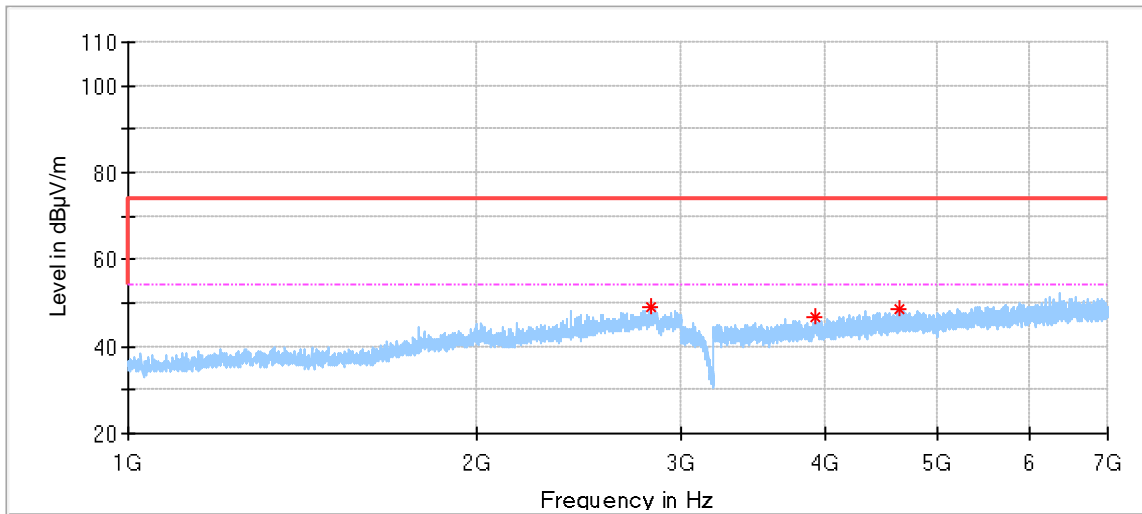

Frequency (MHz)	MaxPeak (dBµV/m)	Limit (dBµV/m)	Margin (dB)	Height (cm)	Pol	Azimuth (deg)	Corr. (dB/m)
2820.000000	48.97	74.00	25.03	150.0	V	61.0	-0.8
3917.500000	46.57	74.00	27.43	150.0	V	100.0	1.5
4636.500000	48.71	74.00	25.29	150.0	V	93.0	3.1

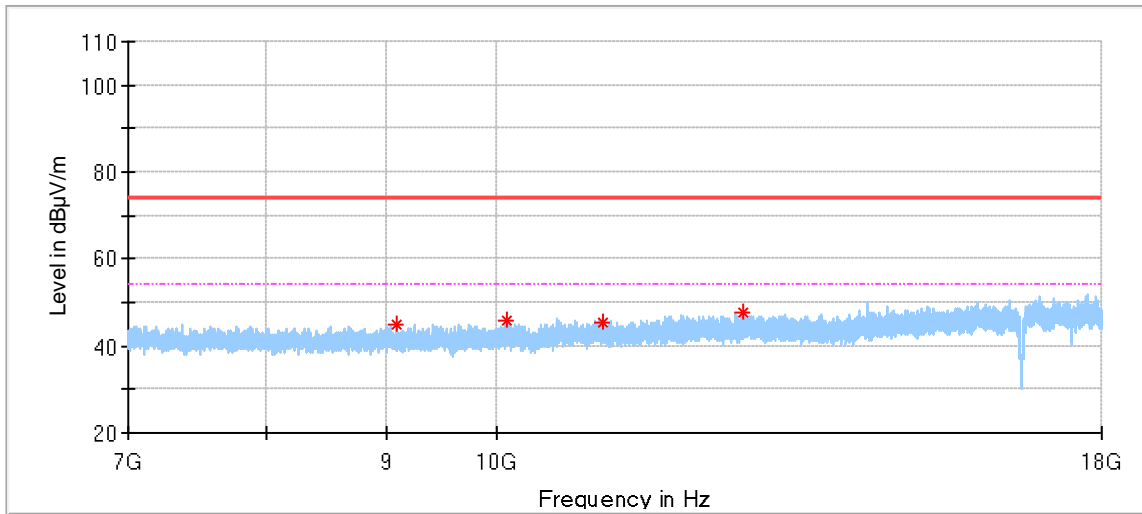

Frequency (MHz)	MaxPeak (dBµV/m)	Limit (dBµV/m)	Margin (dB)	Height (cm)	Pol	Azimuth (deg)	Corr. (dB/m)
9089.500000	45.10	74.00	28.90	150.0	H	198.0	6.9
10102.000000	45.88	74.00	28.12	150.0	H	83.0	8.0
11087.500000	45.50	74.00	28.50	150.0	H	1.0	8.3
12704.500000	47.75	74.00	26.25	150.0	H	129.0	10.1

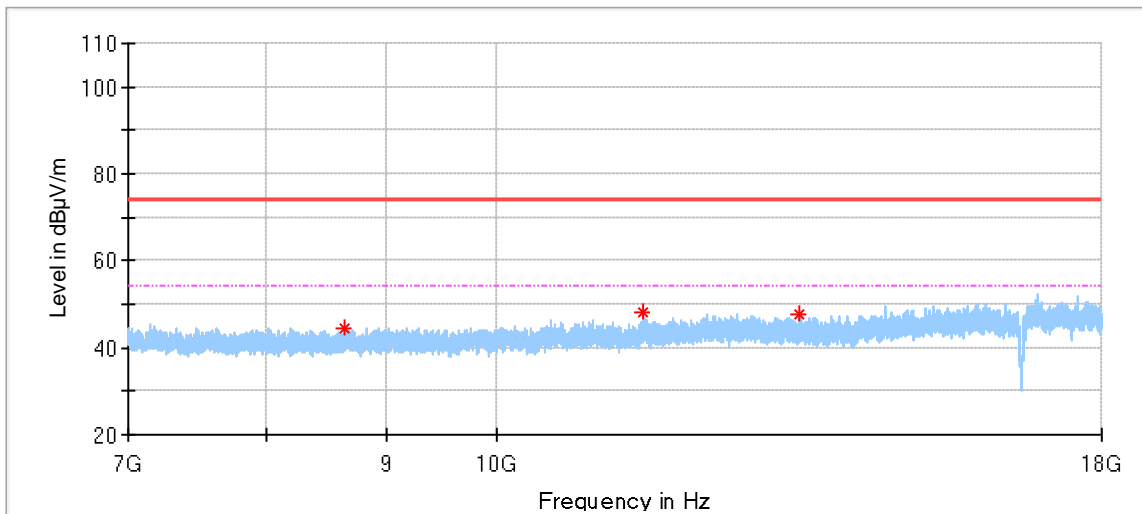

Frequency (MHz)	MaxPeak (dBµV/m)	Limit (dBµV/m)	Margin (dB)	Height (cm)	Pol	Azimuth (deg)	Corr. (dB/m)
8627.000000	44.65	74.00	29.35	150.0	V	0.0	6.6
11539.500000	47.96	74.00	26.04	150.0	V	234.0	8.8
13433.500000	47.62	74.00	26.38	150.0	V	234.0	9.6

Middle channel 2445MHz Test Result

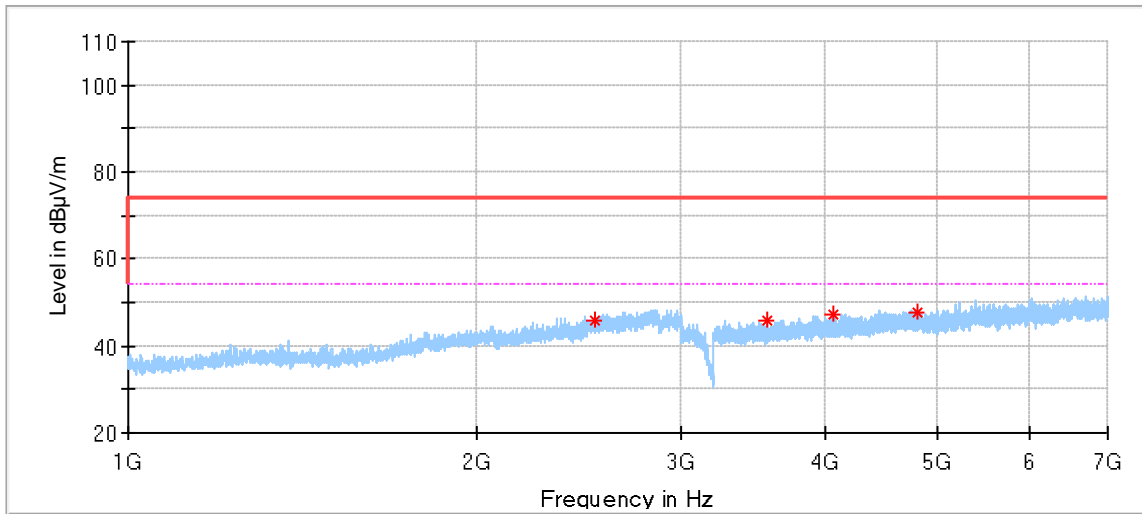

Frequency (MHz)	MaxPeak (dBµV/m)	Limit (dBµV/m)	Margin (dB)	Height (cm)	Pol	Azimuth (deg)	Corr. (dB/m)	Corr. (dB)
2522.500000	46.01	74.00	27.99	150.0	H	74.0	-2.2	---
3563.000000	46.06	74.00	27.94	150.0	H	334.0	-1.1	---
4061.500000	47.07	74.00	26.93	150.0	H	147.0	1.3	---
4789.000000	47.87	74.00	26.13	150.0	H	93.0	3.1	---

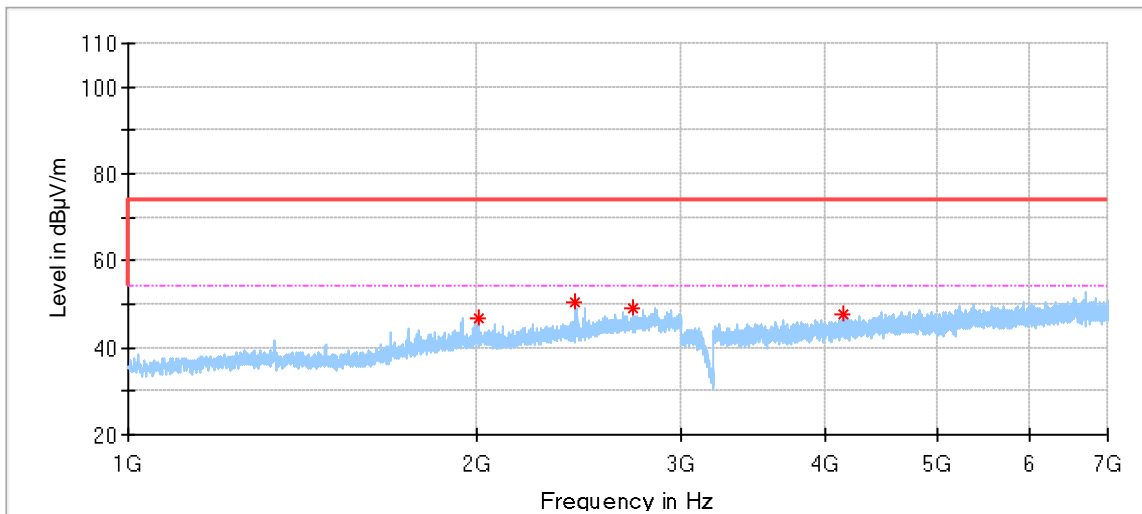

Frequency (MHz)	MaxPeak (dBµV/m)	Limit (dBµV/m)	Margin (dB)	Height (cm)	Pol	Azimuth (deg)	Corr. (dB/m)
2003.000000	46.89	74.00	27.11	150.0	V	152.0	-4.4
2426.000000	50.38	74.00	23.62	150.0	V	89.0	-2.9
2723.000000	49.18	74.00	24.82	150.0	V	195.0	-1.4
4134.000000	47.71	74.00	26.29	150.0	V	356.0	1.8

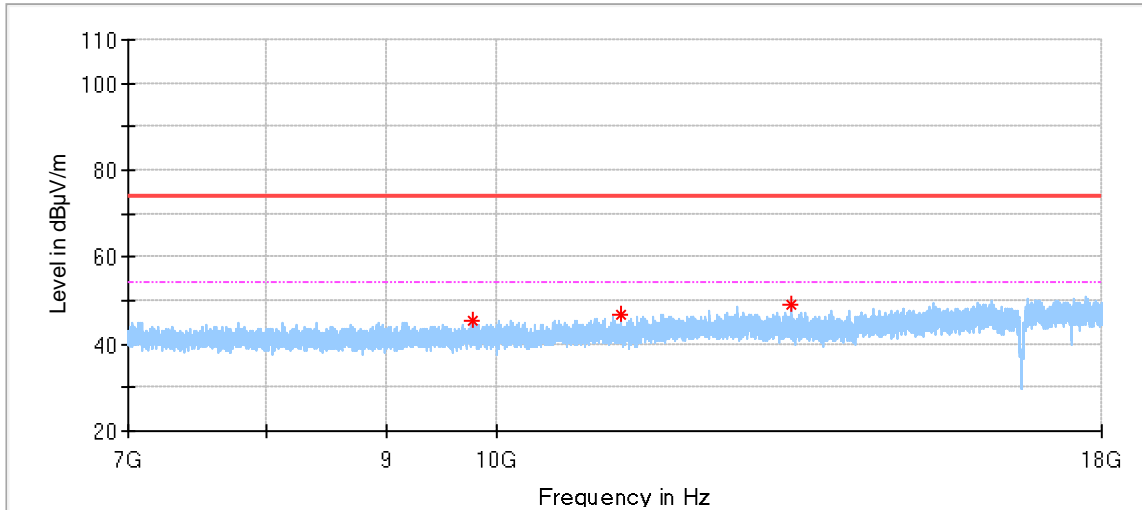

Frequency (MHz)	MaxPeak (dBµV/m)	Limit (dBµV/m)	Margin (dB)	Height (cm)	Pol	Azimuth (deg)	Corr. (dB/m)
9771.500000	45.57	74.00	28.43	150.0	H	47.0	7.6
11297.000000	46.69	74.00	27.31	150.0	H	185.0	8.4
13330.000000	49.04	74.00	24.96	150.0	H	208.0	10.0

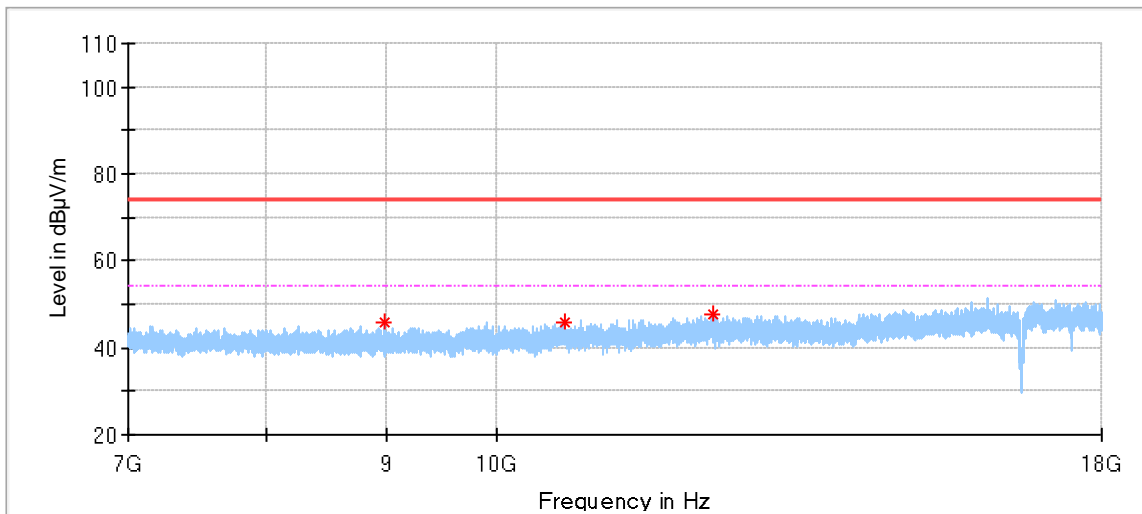

Frequency (MHz)	MaxPeak (dBµV/m)	Limit (dBµV/m)	Margin (dB)	Height (cm)	Pol	Azimuth (deg)	Corr. (dB/m)
8977.000000	45.63	74.00	28.37	150.0	V	15.0	7.0
10685.500000	46.05	74.00	27.95	150.0	V	313.0	8.3
12344.500000	47.65	74.00	26.35	150.0	V	198.0	10.0

High channel 2480MHz Test Result

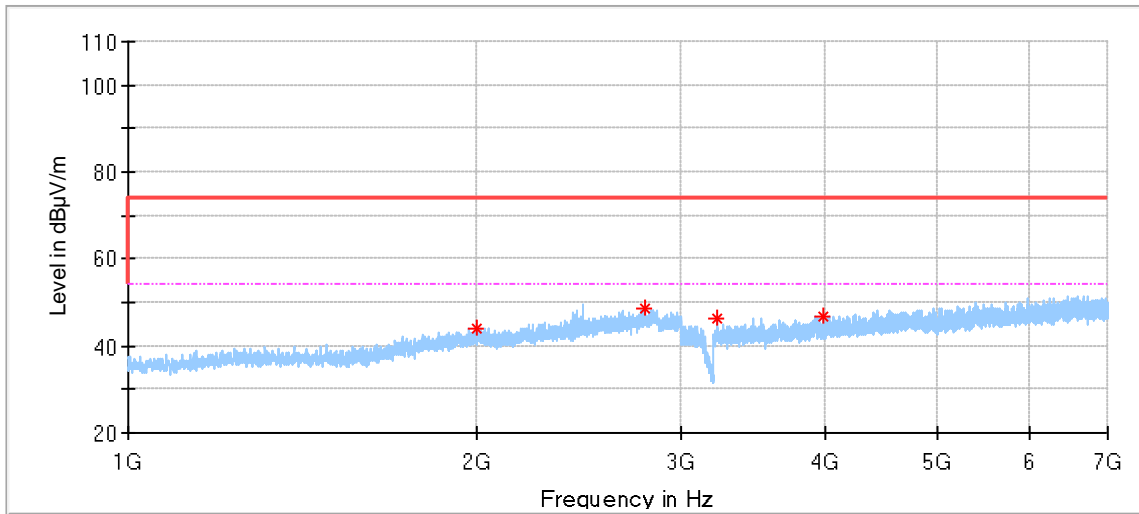

Frequency (MHz)	MaxPeak (dBµV/m)	Limit (dBµV/m)	Margin (dB)	Height (cm)	Pol	Azimuth (deg)	Corr. (dB/m)
2001.500000	43.83	74.00	30.17	150.0	H	237.0	-4.3
2787.000000	48.73	74.00	25.27	150.0	H	332.0	-0.9
3224.500000	46.09	74.00	27.91	150.0	H	1.0	-1.3
3976.000000	46.74	74.00	27.26	150.0	H	292.0	1.1

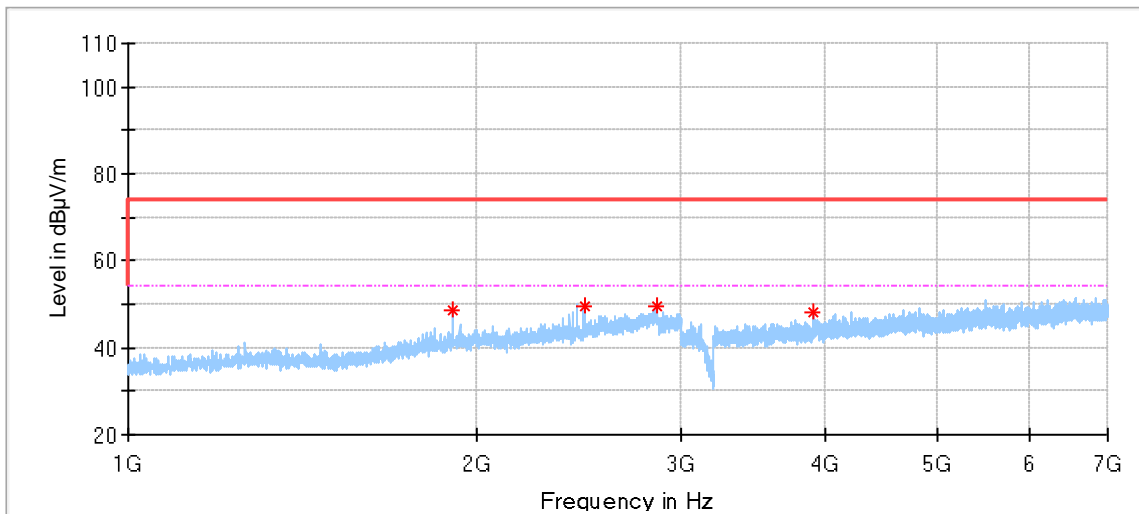

Frequency (MHz)	MaxPeak (dBµV/m)	Limit (dBµV/m)	Margin (dB)	Height (cm)	Pol	Azimuth (deg)	Corr. (dB/m)
1908.000000	48.42	74.00	25.58	150.0	V	208.0	-4.9
2480.000000	49.70	74.00	24.30	150.0	V	331.0	-2.5
2854.500000	49.74	74.00	24.26	150.0	V	193.0	-0.9
3901.500000	47.98	74.00	26.02	150.0	V	340.0	1.0

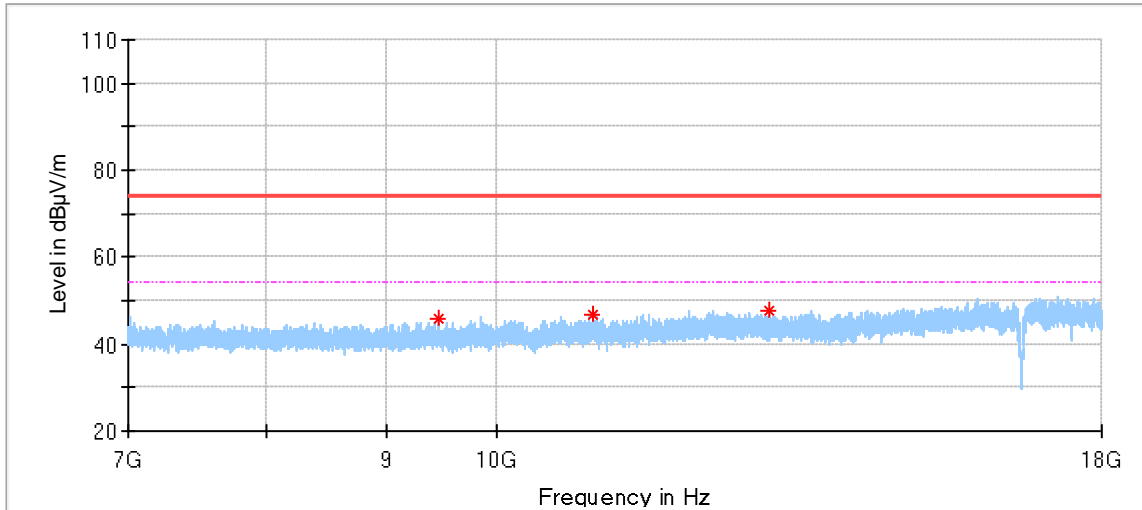

Frequency (MHz)	MaxPeak (dBµV/m)	Limit (dBµV/m)	Margin (dB)	Height (cm)	Pol	Azimuth (deg)	Corr. (dB/m)
9463.000000	45.80	74.00	28.20	150.0	H	119.0	7.2
10979.000000	46.62	74.00	27.38	150.0	H	96.0	8.2
13039.500000	47.88	74.00	26.12	150.0	H	70.0	10.0

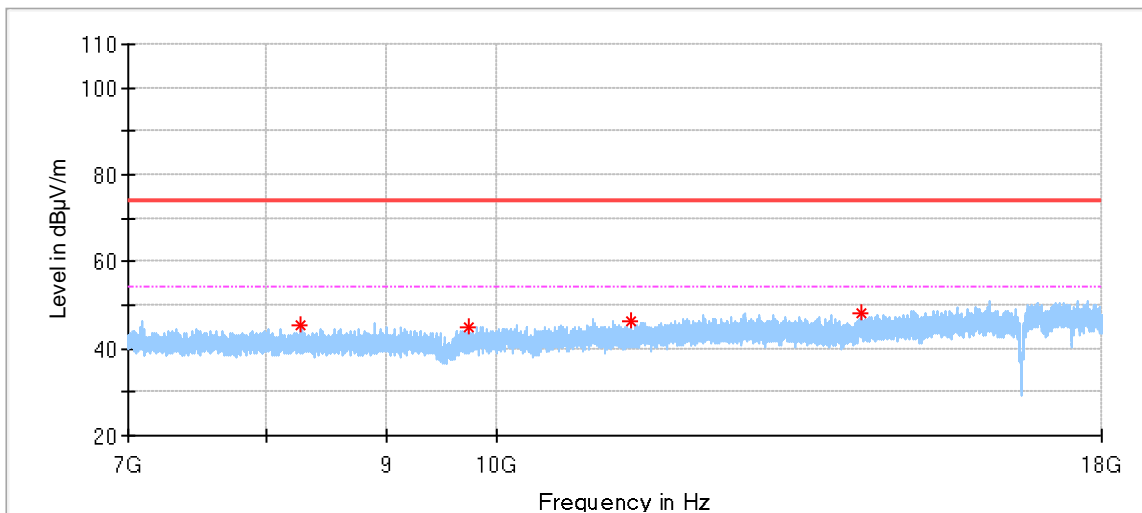

Frequency (MHz)	MaxPeak (dBµV/m)	Limit (dBµV/m)	Margin (dB)	Height (cm)	Pol	Azimuth (deg)	Corr. (dB/m)
8281.000000	45.23	74.00	28.77	150.0	V	57.0	6.7
9742.000000	44.86	74.00	29.14	150.0	V	80.0	7.5
11401.500000	46.43	74.00	27.57	150.0	V	103.0	8.5
14243.500000	48.38	74.00	25.63	150.0	V	80.0	10.7

Remark:

- (1) Data of measurement within frequency range 18-26GHz are the noise floor or attenuated more than 20dB below the permissible limits or the field strength is too small to be measured, so test data does not present in this report;
- (2) Level=Reading Level + Correction Factor
 Above 1GHz: Corrector factor = Antenna Factor + Cable Loss- Amplifier Gain
 Below 1GHz: Corrector factor = Antenna Factor + Cable Loss
 (The Reading Level is recorded by software which is not shown in the sheet)

10 Test Equipment List

Radiated Emission Test

DESCRIPTION	MANUFACTURER	MODEL NO.	EQUIPMENT ID	SERIAL NO.	CAL INTERVAL (YEAR)	CAL. DUE DATE
EMI Test Receiver	Rohde & Schwarz	ESR 7	68-4-74-19-001	102176	1	2021-6-29
Trilog Super Broadband Test Antenna	Schwarzbeck	VULB 9163	68-4-80-14-002	707	1	2021-8-4
Horn Antenna	Rohde & Schwarz	HF907	68-4-80-14-005	102294	1	2021-7-14
Loop Antenna	Rohde & Schwarz	HFH2-Z2	68-4-80-14-006	100398	1	2021-7-6
Pre-amplifier	Rohde & Schwarz	SCU 18	68-4-29-14-001	102230	1	2021-6-21
Attenuator	Agilent	8491A	68-4-81-16-001	MY39264334	1	2021-6-21
3m Semi-anechoic chamber	TDK	9X6X6	68-4-90-14-001	----	3	2022-10-28
Test software	Rohde & Schwarz	EMC32	68-4-90-14-001-A10	Version10.35.02	N/A	N/A

TS8997 Test System

DESCRIPTION	MANUFACTURER	MODEL NO.	EQUIPMENT ID	SERIAL NO.	CAL INTERVAL (YEAR)	CAL. DUE DATE
Signal Generator	Rohde & Schwarz	SMB100A	68-4-48-14-001	108272	1	2021-6-21
Vector Signal Generator	Rohde & Schwarz	SMBV100A	68-4-48-18-001	262825	1	2021-6-21
Communication Synthetical Test Instrument	Rohde & Schwarz	CMW 270	68-4-48-18-003	101251	1	2021-6-21
Signal Analyzer	Rohde & Schwarz	FSV40	68-4-74-14-004	101030	1	2021-6-21
Vector Signal Generator	Rohde & Schwarz	SMU 200A	68-4-48-14-003	105324	1	2021-6-22
RF Switch Module	Rohde & Schwarz	OSP120/OSP-B157	68-4-93-14-003	101226/100851	1	2021-6-21
Power Splitter	Weinschel	1580	68-4-85-14-001	SC319	1	2021-7-16
10dB Attenuator	Weinschel	4M-10	68-4-81-14-003	43152	1	2021-6-21
10dB Attenuator	R&S	DNF	68-4-81-14-004	DNF-001	1	2021-6-21
10dB Attenuator	R&S	DNF	68-4-81-14-005	DNF-002	1	2021-6-21
10dB Attenuator	R&S	DNF	68-4-81-14-006	DNF-003	1	2021-6-21
10dB Attenuator	R&S	DNF	68-4-81-14-007	DNF-004	1	2021-6-21
Test software	Rohde & Schwarz	EMC32	68-4-48-14-003-A10	Version 10.60.10	N/A	N/A
Test software	Tonscend	System for BT/WIFI	68-4-74-14-006-A13	Version 2.6.77.0518	N/A	N/A
Shielding Room	TDK	TS8997	68-4-90-19-003	----	1	2020-11-07

11 System Measurement Uncertainty

For a 95% confidence level, the measurement expanded uncertainties for defined systems, in accordance with the recommendations of ISO 17025 were:

System Measurement Uncertainty	
Test Items	Extended Uncertainty
Uncertainty for Radiated Spurious Emission 25MHz-3000MHz	Horizontal: 4.81dB; Vertical: 4.89dB;
Uncertainty for Radiated Spurious Emission 3000MHz-18000MHz	Horizontal: 4.69dB; Vertical: 4.68dB;
Uncertainty for Radiated Spurious Emission 18000MHz-40000MHz	Horizontal: 4.89dB; Vertical: 4.87dB;
Uncertainty for Conducted RF test with TS 8997	RF Power Conducted: 1.16dB Frequency test involved: 0.6x10 ⁻⁷ or 1%
Uncertainty Evaluation for Power Spectral Density Conducted measurement	1.17dB
Uncertainty Evaluation for Spurious emissions Conducted measurement	1.43dB
Uncertainty Evaluation for Humidity	0.936%
Uncertainty Evaluation for Temperature	0.195 °C