



<b>Prüfbericht-Nr.:</b> <i>Test report no.:</i>	NN202ULD(P15C-BR/EDR) 001	<b>Auftrags-Nr.:</b> <i>Order no.:</i>	238489405	Seite 1 von 32 Page 1 of 32
<b>Kunden-Referenz-Nr.:</b> <i>Client reference no.:</i>	N/A	<b>Auftragsdatum:</b> <i>Order date:</i>	3-Aug-2020	
<b>Auftraggeber:</b> <i>Client:</i>	Cooper Lighting, LLC 1121 Hwy 74 S, Peachtree City, Georgia, United States, 30269			
<b>Prüfgegenstand:</b> <i>Test item:</i>	Bluetooth Stereo Audio Module			
<b>Bezeichnung / Typ-Nr.:</b> <i>Identification / Type no.:</i>	BTZ-983H			
<b>Auftrags-Inhalt:</b> <i>Order content:</i>	FCC Part 15C Test report (BT)			
<b>Prüfgrundlage:</b> <i>Test specification:</i>	FCC 47CFR Part 15: Subpart C Section 15.247			
<b>Wareneingangsdatum:</b> <i>Date of sample receipt:</i>	23-Jul-2020			
<b>Prüfmuster-Nr.:</b> <i>Test sample no.:</i>	A002873378-002 A002873378-003			
<b>Prüfzeitraum:</b> <i>Testing period:</i>	10-Aug-2020 – 14-Aug-2020			
<b>Ort der Prüfung:</b> <i>Place of testing:</i>	EMC/RF Laboratory Taipei			
<b>Prüflaboratorium:</b> <i>Testing laboratory:</i>	Taipei Testing Laboratories			
<b>Prüfergebnis*:</b> <i>Test result*:</i>	Pass			
<b>überprüft von:</b> <i>reviewed by:</i>		<b>genehmigt von:</b> <i>authorized by:</i>		
<b>Datum:</b> 05-Oct-2020 <i>Date:</i>	Jack H.C. Chang	<b>Datum:</b> 05-Oct-2020 <i>Date:</i>	Brenda S.H. Chen	
<b>Stellung / Position:</b>	Project Manager	<b>Stellung / Position:</b>	Project Manager	
<b>Sonstiges / Other:</b>				
<b>Zustand des Prüfgegenstandes bei Anlieferung:</b> <i>Condition of the test item at delivery:</i>		Prüfmuster vollständig und unbeschädigt <i>Test item complete and undamaged</i>		
* Legende:	1 = sehr gut P(ass) = entspricht o.g. Prüfgrundlage(n)	2 = gut F(ail) = entspricht nicht o.g. Prüfgrundlage(n)	3 = befriedigend N/A = nicht spezifiziert	4 = ausreichend N/T = nicht getestet
* Legend:	1 = very good P(ass) = passed a.m. test specification(s)	2 = good F(ail) = failed a.m. test specification(s)	3 = satisfactory N/A = not specified	4 = sufficient N/T = not tested
<p><b>Dieser Prüfbericht bezieht sich nur auf das o.g. Prüfmuster und darf ohne Genehmigung der Prüfstelle nicht auszugsweise vervielfältigt werden. Dieser Bericht berechtigt nicht zur Verwendung eines Prüfzeichens.</b> <i>This test report only relates to the a. m. test sample. Without permission of the test center this test report is not permitted to be duplicated in extracts. This test report does not entitle to carry any test mark.</i></p>				

V05

## TEST SUMMARY

Report Section	FCC Clause	Test Item	Result
5.1.1	15.247(b) & 15.203	Antenna Requirement	Pass
5.1.2	15.247(b)(1)	Peak Output Power	Pass
5.1.3	15.247(a)(1)	20 dB Bandwidth	Pass
5.1.3	2.1049	99% Occupied Bandwidth	Pass
5.1.4	15.247(d)	Conducted Spurious Emission and Band Edges	Pass
5.1.5	15.247(d) & 15.205 & 15.209	Radiated Spurious Emissions and Band Edges	Pass
5.1.6	15.247(a)(1)	Hopping Channel Separation	Pass
5.1.7	15.247(a)(1) (iii)	Number of Hopping Frequency Used	Pass
5.1.8	15.247(a)(1) (iii)	Dwell Time on Each Channel	Pass
5.2.1	15.207	Mains Conducted Emission	Pass
6.1	FCC KDB 447498 D01 v06	RF Exposure Compliance	Pass

**Note:**

1. If the Frequency Hopping Systems operating in 2400-2483.5 MHz band and the output power less than 125 mW. The hopping channel carrier frequencies separated by a minimum of 25 kHz or two-thirds of the 20 dB bandwidth of hopping channel whichever is greater.
2. Determining compliance based on the results of the compliance measurement, not taking into account measurement instrumentation uncertainty.

## Contents

<b>HISTORY OF THIS TEST REPORT .....</b>	<b>5</b>
<b>1. GENERAL REMARKS .....</b>	<b>6</b>
<b>1.1 COMPLEMENTARY MATERIALS.....</b>	<b>6</b>
<b>1.2 DECISION RULE OF CONFORMITY .....</b>	<b>6</b>
<b>2. TEST SITES .....</b>	<b>7</b>
<b>2.1 TEST LABORATORY .....</b>	<b>7</b>
<b>2.2 TEST FACILITY.....</b>	<b>7</b>
<b>2.3 TRACEABILITY .....</b>	<b>8</b>
<b>2.4 CALIBRATION .....</b>	<b>8</b>
<b>2.5 MEASUREMENT UNCERTAINTY .....</b>	<b>8</b>
<b>3. GENERAL PRODUCT INFORMATION.....</b>	<b>9</b>
<b>3.1 PRODUCT FUNCTION AND INTENDED USE .....</b>	<b>9</b>
<b>3.2 SYSTEM DETAILS AND RATINGS.....</b>	<b>9</b>
<b>3.3 NOISE GENERATING AND NOISE SUPPRESSING PARTS .....</b>	<b>10</b>
<b>3.4 SUBMITTED DOCUMENTS.....</b>	<b>10</b>
<b>4. TEST SET-UP AND OPERATION MODES.....</b>	<b>11</b>
<b>4.1 PRINCIPLE OF CONFIGURATION SELECTION .....</b>	<b>11</b>
<b>4.2 CARRIER FREQUENCY AND CHANNEL.....</b>	<b>11</b>
<b>4.3 TEST OPERATION AND TEST SOFTWARE.....</b>	<b>12</b>
<b>4.4 SPECIAL ACCESSORIES AND AUXILIARY EQUIPMENT .....</b>	<b>13</b>
<b>4.5 TEST SETUP DIAGRAM .....</b>	<b>14</b>
<b>5. TEST RESULTS .....</b>	<b>15</b>
<b>5.1 TRANSMITTER REQUIREMENT &amp; TEST SUITES .....</b>	<b>15</b>
5.1.1 <i>Antenna Requirement .....</i>	<i>15</i>
5.1.2 <i>Peak Output Power .....</i>	<i>16</i>
5.1.3 <i>20 dB Bandwidth and 99% Occupied Bandwidth.....</i>	<i>19</i>
5.1.4 <i>Conducted Spurious Emissions and Frequency Band Edges Measured in 100kHz Bandwidth.....</i>	<i>20</i>
5.1.5 <i>Radiated Spurious Emissions and Band Edges .....</i>	<i>21</i>
5.1.6 <i>Hopping Channel Separation .....</i>	<i>27</i>
5.1.7 <i>Number of Hopping Frequency.....</i>	<i>28</i>
5.1.8 <i>Dwell Time.....</i>	<i>29</i>
<b>5.2 MAINS EMISSION .....</b>	<b>30</b>
5.2.1 <i>Mains Conducted Emission.....</i>	<i>30</i>

<b>6.</b>	<b>SAFETY HUMAN EXPOSURE .....</b>	<b>32</b>
<b>6.1</b>	<b>RF EXPOSURE COMPLIANCE .....</b>	<b>32</b>
6.1.1	<i>SAR Test Exclusion Thresholds.....</i>	<i>32</i>

**APPENDIX A - TEST RESULT OF CONDUCTED**

**APPENDIX B - TEST RESULT OF RADIATED SPURIOUS EMISSIONS & MAINS CONDUCTED  
EMISSION**

**APPENDIX SP - PHOTOGRAPHS TEST SETUP**

**APPENDIX EP - PHOTOGRAPHS OF EUT**

**Prüfbericht - Nr.: NN202ULD(P15C-BR/EDR) 001**  
Test Report No.Seite 5 von 32  
Page 5 of 32**HISTORY OF THIS TEST REPORT**

Report No.	Description	Date Issued
NN202ULD(P15C-BR/EDR) 001	Original Release	05-Oct-2020

## 1. General Remarks

### 1.1 Complementary Materials

All attachments are integral parts of this test report. This applies especially to the following appendix:

**Appendix A - Test Result of Conducted**

**Appendix B - Test Result of Radiated Spurious Emissions & Mains Conducted Emission**

**Appendix SP - Photographs Test Setup**

**Appendix EP - Photographs of EUT**

### Applied Standard and Test Levels

Radio
FCC CFR47 Part 15: Subpart C Section 15.247
ANSI C63.10:2013
KDB 558074 D01 15.247 Meas Guidance v05r02
KDB 447498 D01 General RF Exposure Guidance v06

### 1.2 Decision Rule of Conformity

The decision rule of conformity of this test report is following the requirements of the requested standard in the quotation, and agreed among testing laboratory and manufacturer (applicant) to exclude the consideration of Measurement Uncertainty, unless it is required by the specific standard.

## 2. Test Sites

### 2.1 Test Laboratory

Taipei Testing Laboratories

11F. No.758, Sec. 4, Bade Rd., Songshan Dist.  
Taipei City 105  
Taiwan (R.O.C.)

### 2.2 Test Facility

Taipei Testing Laboratories

No.458-18, Sec. 2, Fenliao Rd., Linkou Dist.,  
New Taipei City 244  
Taiwan (R.O.C.)  
FCC Registration No.: 226631  
ISED Registration No.: 25563



## 2.3 Traceability

All measurement equipment calibrations are traceable to NML(Taiwan)/NIST(USA) or where calibration is performed outside Taiwan, to equivalent nationally recognized standards organizations.

## 2.4 Calibration

Equipment requiring calibration is calibrated periodically in a suitably accredited Calibration Lab. Additionally all equipment is verified for proper performance on a regular basis using in house standards or comparisons.

## 2.5 Measurement Uncertainty

All measurement uncertainty values are shown with a coverage factor of  $k=2$  to indicate a 95% level of confidence.

### Emission Measurement Uncertainty

Parameter	Uncertainty
Radiated Emission (9 kHz ~ 30 MHz)	$\pm 1.15$ dB
Radiated Emission (30 MHz ~ 200 MHz)	$\pm 1.30$ dB
Radiated Emission (200 MHz ~ 1 GHz)	$\pm 1.30$ dB
Radiated Emission (1 GHz ~ 18 GHz)	$\pm 1.54$ dB
Radiated Emission (18 GHz ~ 40 GHz)	$\pm 2.52$ dB
Mains Conducted Emission	$\pm 1.65$ dB



### 3. General Product Information

#### 3.1 Product Function and Intended Use

The EUT is a Bluetooth Stereo Audio Module. It contains a Bluetooth compatible module enabling the user to communicate data through a Wireless interface.

For details refer to the User Guide, Data Sheet and Circuit Diagram.

#### 3.2 System Details and Ratings

##### Basic Information of EUT

Item	EUT information
Kind of Equipment/Test Item	Bluetooth Stereo Audio Module
Type Identification	BTZ-983H
FCC ID	2AKCY-RL56BBLE

##### Technical Specification of EUT

Item	EUT information
Operating Frequency	2402 MHz ~ 2480 MHz
Channel Spacing	1 MHz
Channel number	79
Operation Voltage	5Vdc
Modulation	GFSK, $\pi/4$ -DQPSK, 8DPSK
Maximum Output Power (mW)	13.614
Antenna Information	Refer to 5.1.1
Accessory Device	Refer to 4.4

### **3.3 Noise Generating and Noise Suppressing Parts**

Refer to the Circuit Diagram.

### **3.4 Submitted Documents**

- Circuit Diagram
- Instruction Manual
- Rating Label
- Technical Description

## 4. Test Set-up and Operation Modes

### 4.1 Principle of Configuration Selection

The test modes were adapted accordingly in reference to the instructions for use.

During testing, Channel and Power Controlling Software provided by the customer was used to control the operating channel as well as the output power level. The RF output power selection is for the setting of RF output expected by the customer and is going to be fixed on the firmware of the final end product.

**Table for Parameters of Test Software Setting**

Frequency (MHz)	Power Setting		
	GFSK	$\pi/4$ -DQPSK	8DPSK
2402	PL0	PL0	PL0
2441	PL0	PL0	PL0
2480	PL0	PL0	PL0

### 4.2 Carrier Frequency and Channel

Channel	Freq. (MHz)	Channel	Freq. (MHz)	Channel	Freq. (MHz)	Channel	Freq. (MHz)
0	2402	20	2422	40	2442	60	2462
1	2403	21	2423	41	2443	61	2463
2	2404	22	2424	42	2444	62	2464
3	2405	23	2425	43	2445	63	2465
4	2406	24	2426	44	2446	64	2466
5	2407	25	2427	45	2447	65	2467
6	2408	26	2428	46	2448	66	2468
7	2409	27	2429	47	2449	67	2469
8	2410	28	2430	48	2450	68	2470
9	2411	29	2431	49	2451	69	2471
10	2412	30	2432	50	2452	70	2472
11	2413	31	2433	51	2453	71	2473
12	2414	32	2434	52	2454	72	2474
13	2415	33	2435	53	2455	73	2475
14	2416	34	2436	54	2456	74	2476
15	2417	35	2437	55	2457	75	2477
16	2418	36	2438	56	2458	76	2478
17	2419	37	2439	57	2459	77	2479
18	2420	38	2440	58	2460	78	2480
19	2421	39	2441	59	2461		

### 4.3 Test Operation and Test Software

Setup for testing: Test samples are provided with a USB interface which makes it possible to control them through a test software installed on a notebook computer.

This software was running on the laptop computer connected to the EUT. It was used to enable the operation modes listed as below.

Test Software	ISRT_V2.1.32.5667
---------------	-------------------

The samples were used as follows:

A002873378-002 for conducted

A002873378-003 for radiated

Full test was applied on all test modes, but only worst case was shown.

EUT Configure Mode	Applicable To			Mains Conducted Emission	Description
	Antenna Port Conducted Measurement	Radiated Spurious Emissions above 1 GHz	Radiated Spurious Emissions below 1 GHz		
-	√	√	√	√	-

Note:

1. For Radiated emission test, pre-tested GFSK,  $\pi/4$ -DQPSK, 8DPSK modulation type and found 8DPSK was the worse, therefore chosen for the final test and presented in the test report.
2. The EUT had been pre-tested on the positioned of each 3 axis. The worst case was found when position on **Z-plane**.
3. "-" means no effect.

#### Antenna Port Conducted Measurement:

Pre-Scan full test was applied on all test modes, but only worst case was shown.

Following channel(s) was (were) selected for the final test as listed below.

EUT Configure Mode	Available Frequency (MHz)	Tested Frequency (MHz)	Modulation Type	Packet Type
-	2402 to 2480	2402, 2441, 2480	GFSK	1DH5
-	2402 to 2480	2402, 2441, 2480	$\pi/4$ -DQPSK	2DH5
-	2402 to 2480	2402, 2441, 2480	8DPSK	3DH5

#### Radiated Spurious Emissions (Above 1 GHz):

Pre-Scan full test was applied on all test modes, but only worst case was shown.

Following channel(s) was (were) selected for the final test as listed below.

EUT Configure Mode	Available Frequency (MHz)	Tested Frequency (MHz)	Modulation Type	Packet Type
-	2402 to 2480	2402, 2441, 2480	GFSK	1DH5
-	2402 to 2480	2402, 2441, 2480	$\pi/4$ -DQPSK	2DH5
-	2402 to 2480	2402, 2441, 2480	8DPSK	3DH5

#### Radiated Spurious Emissions (Below 1 GHz):

Pre-Scan full test was applied on all test modes, but only worst case was shown.

Following channel(s) was (were) selected for the final test as listed below.

EUT Configure Mode	Available Frequency (MHz)	Tested Frequency (MHz)	Modulation Type	Packet Type
-	2402 to 2480	2480	8DPSK	3DH5

**Mains Conducted Emission Test:**

- Pre-Scan full test was applied on all test modes, but only worst case was shown.
- Following channel(s) was (were) selected for the final test as listed below.

EUT Configure Mode	Available Frequency (MHz)	Tested Frequency (MHz)	Modulation Type	Packet Type
-	2402 to 2480	2480	8DPSK	3DH5

**Test Condition**

Test Item	Ambient Temperature	Relative Humidity	Tested by
Conducted Measurement	22-26 °C	50-65 %	Stanislas Charles
Radiated Spurious Emissions above 1 GHz	22-26 °C	50-65 %	Simon Tsai
Radiated Spurious Emissions below 1 GHz	22-26 °C	50-65 %	Simon Tsai
Mains Conducted Emission	22-26 °C	50-65 %	Eagle Tsai

## 4.4 Special Accessories and Auxiliary Equipment

The product has been tested together with the following additional accessories:

**Accessory of EUT**

N/A

**Support Unit**

No.	Description	Brand	Model	S/N	Remark
1	Notebook	HP	15s-du0007TX	CND93662VF	Radiated
2	UART	N/A	CP2102	N/A	
3	Adapter	HP	TPN-CA16	N/A	
1	Notebook	HP	15s-du0007TX	CND93662VF	Mains Conducted Emission
2	Adapter	HP	TPN-CA16	N/A	

No.	Description	Shielded	Ferrite Core (Qty)	Length (m)	Remark
A	Signal Cable	No	0	0.1	Radiated
B	Adapter Cable	YES	0	1	
A	Signal Cable	NO	0	0.1	Mains Conducted Emission
B	Adapter Cable	YES	0	1.5	
C	Power Cable	YES	0	1	

### 4.5 Test Setup Diagram

<Radiated Spurious Emissions>

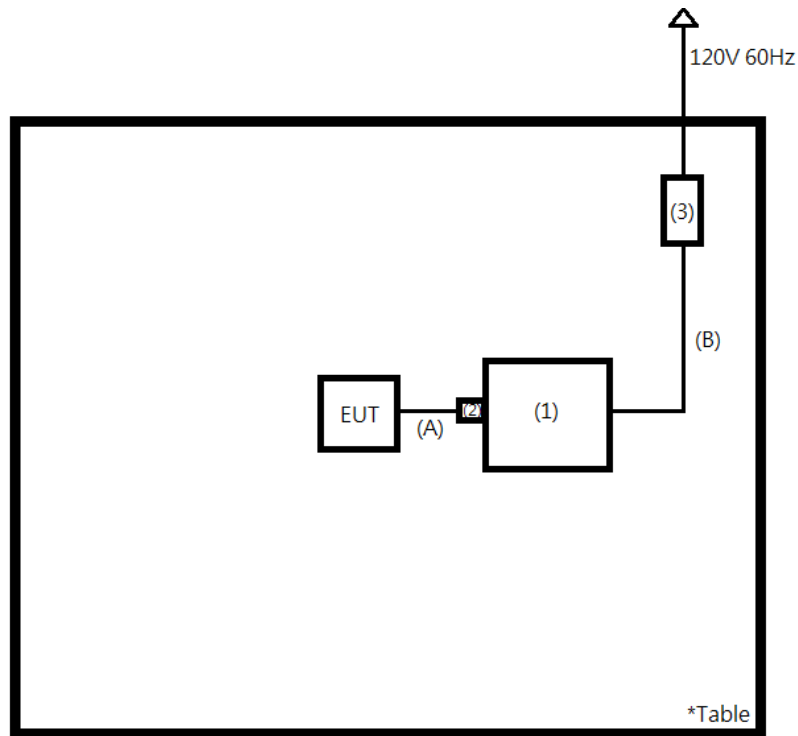

<Mains Conducted Emission mode>

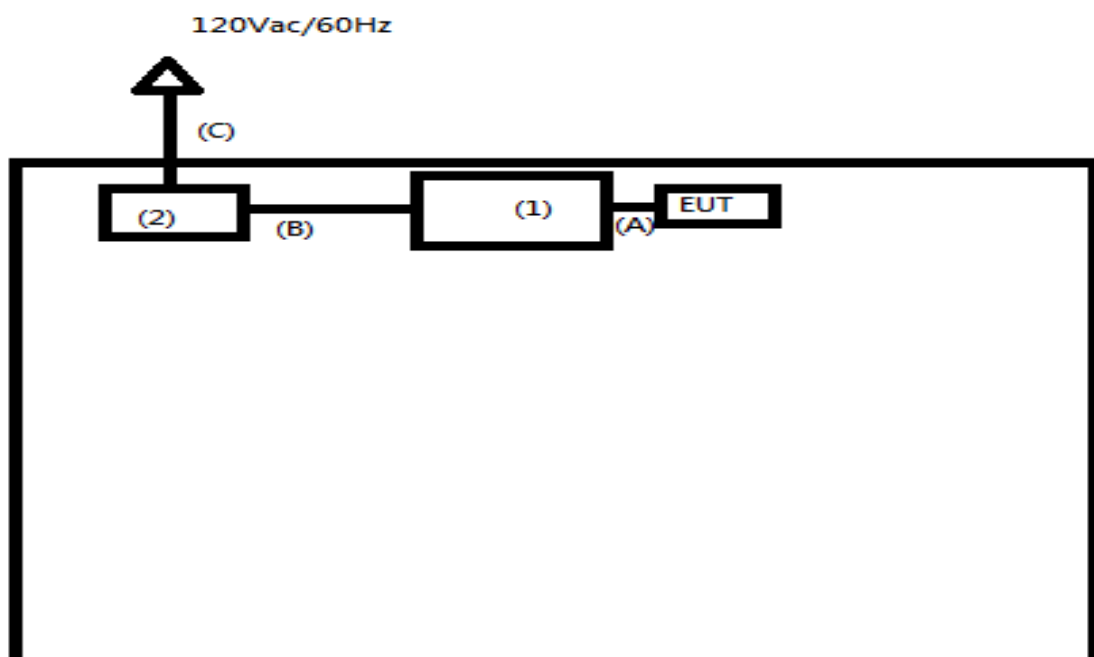

## 5. Test Results

### 5.1 Transmitter Requirement & Test Suites

#### 5.1.1 Antenna Requirement

**Requirement** Use of approved antennas only

According to the manufacturer declaration, the EUT has an antenna with a directional gain of 5.5 dBi. The antenna is IFA with no possibility of replacement with a non-approved antenna by the end-user. Therefore, the EUT is considered to comply with this provision. Refer to EUT photo for details.

## 5.1.2 Peak Output Power

### Limit

For frequency hopping systems operating in the 2400-2483.5 MHz band employing at least 75 non-overlapping hopping channels, and all frequency hopping systems in the 5725-5850 MHz band: 1 watt.  
 For all other frequency hopping systems in the 2400-2483.5 MHz band: 0.125 watts.

**Kind of Test Site**                      Shielded room

### Test Setup



### Test Instruments

Kind of Equipment	Manufacturer	Type	S/N	Calibration Date	Calibration Due Date
Power Meter	Anritsu	ML2495A	1901008	2020/4/6	2021/4/5
Power Sensor	Anritsu	MA2411B	1725269	2020/4/7	2021/4/6

### Test Procedures

A peak power sensor was used on the output port of the EUT. A power meter was used to read the response of the peak power sensor. Record the power level.

Average power sensor was used to perform output power measurement, trigger and gating function of wide band power meter is enabled to measure max output power of TX on burst. Duty factor is not added to measured value.



**Test Result**
**Peak Output Power**
**<GFSK>**

Channel	Channel Frequency	Peak Output Power		Limit
	(MHz)	(dBm)	(mW)	(mW)
Low Channel	2402	11.34	13.614	125
Middle Channel	2441	9.68	9.290	125
High Channel	2480	8.36	6.855	125

**< $\pi/4$ -DQPSK>**

Channel	Channel Frequency	Peak Output Power		Limit
	(MHz)	(dBm)	(mW)	(mW)
Low Channel	2402	10.17	10.399	125
Middle Channel	2441	8.40	6.918	125
High Channel	2480	6.95	4.955	125

**<8DPSK>**

Channel	Channel Frequency	Peak Output Power		Limit
	(MHz)	(dBm)	(mW)	(mW)
Low Channel	2402	10.21	10.495	125
Middle Channel	2441	8.49	7.063	125
High Channel	2480	7.12	5.152	125

**Average Power**
**<GFSK>**

Channel	Channel Frequency	Average Power	
	(MHz)	(dBm)	(mW)
Low Channel	2402	11.07	12.794
Middle Channel	2441	9.42	8.750
High Channel	2480	8.09	6.442

**< $\pi/4$ -DQPSK>**

Channel	Channel Frequency	Average Power	
	(MHz)	(dBm)	(mW)
Low Channel	2402	9.87	9.705
Middle Channel	2441	8.05	6.383
High Channel	2480	6.67	4.645

**<8DPSK>**

Channel	Channel Frequency	Average Power	
	(MHz)	(dBm)	(mW)
Low Channel	2402	9.89	9.750
Middle Channel	2441	8.10	6.457
High Channel	2480	6.76	4.742

### 5.1.3 20 dB Bandwidth and 99% Occupied Bandwidth

**Kind of Test Site**                      Shielded room

**Test Setup**

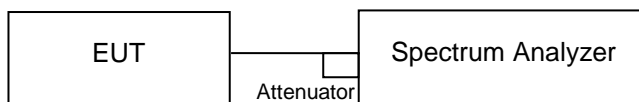

**Test Instruments**

Kind of Equipment	Manufacturer	Type	S/N	Calibration Date	Calibration Due Date
Spectrum Analyzer	R&S	FSV40	101512	2020/2/18	2021/2/16

**Test Procedure**

- a. Check the calibration of the measuring instrument using either an internal calibrator or a known signal from an external generator.
- b. Turn on the EUT and connect it to measurement instrument. Then set it to any one convenient frequency within its operating range. Set a reference level on the measuring instrument equal to the highest peak value.
- c. Measure the frequency difference of two frequencies that were attenuated 20 dB from the reference level. Record the frequency difference as the emission bandwidth.
- d. Repeat above procedures until all frequencies measured were complete.
- e. The transmitter output was connected to the spectrum analyzer through an attenuator. The bandwidth of the fundamental frequency was measured by spectrum analyzer with resolution bandwidth in the range of 1 % to 5 % of the anticipated emission bandwidth, and a video bandwidth at least 3x the resolution bandwidth and set the detector to PEAK. The width of a frequency band such that, below the lower and above the upper frequency limits, the mean powers emitted are each equal to a specified percentage 0.5 % of the total mean power of a given emission.

**Test Results**

Please refer to Appendix A.

### 5.1.4 Conducted Spurious Emissions and Frequency Band Edges Measured in 100kHz Bandwidth

**Limit**

20dB (below that in the 100 kHz bandwidth within the band that contains the highest level of the desired power.)

**Kind of Test Site**                      Shielded room

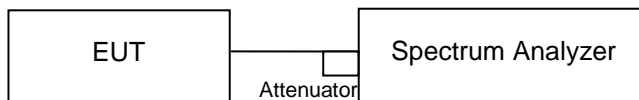
**Test Setup**

**Test Instruments**

Kind of Equipment	Manufacturer	Type	S/N	Calibration Date	Calibration Due Date
Spectrum Analyzer	R&S	FSV40	101512	2020/2/18	2021/2/16

**Test Procedure**

The transmitter output was connected to the spectrum analyzer via a low lose cable. Set both RBW and VBW of spectrum analyzer to 100 kHz and 300 kHz with suitable frequency span including 100 MHz bandwidth from band edge. The band edges was measured and recorded.

**Test Results**

Please refer to Appendix A.

### 5.1.5 Radiated Spurious Emissions and Band Edges

#### Limit

Radiated emissions which fall in the restricted bands, as defined in §15.205(a), must comply with the radiated emission limits specified in §15.209(a).

Emissions radiated outside the restricted and authorized frequency bands must either comply with the radiated emission limits specified for the restricted bands or in §15.247(d).

**Kind of Test Site**                      3m Semi-Anechoic Chamber

#### Test Setup

<Radiated Emissions below 30 MHz>

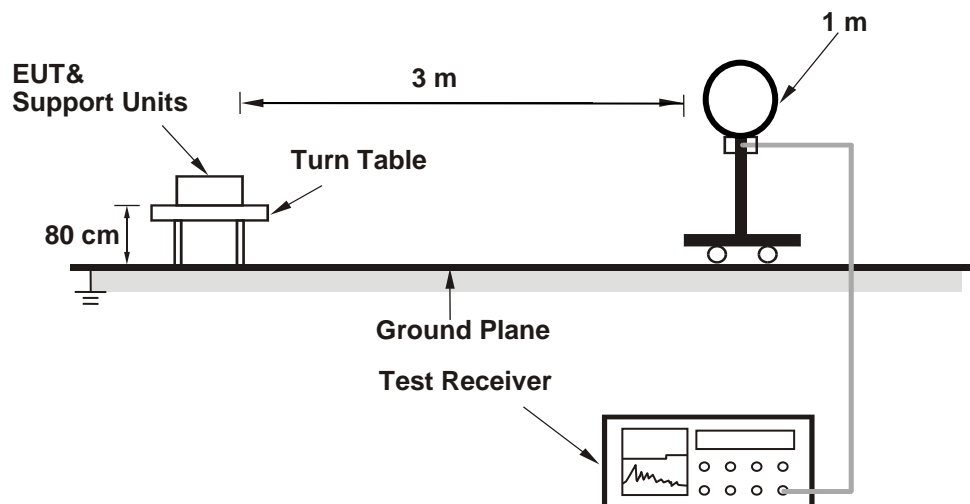

<Radiated Emissions 30 MHz to 1 GHz>

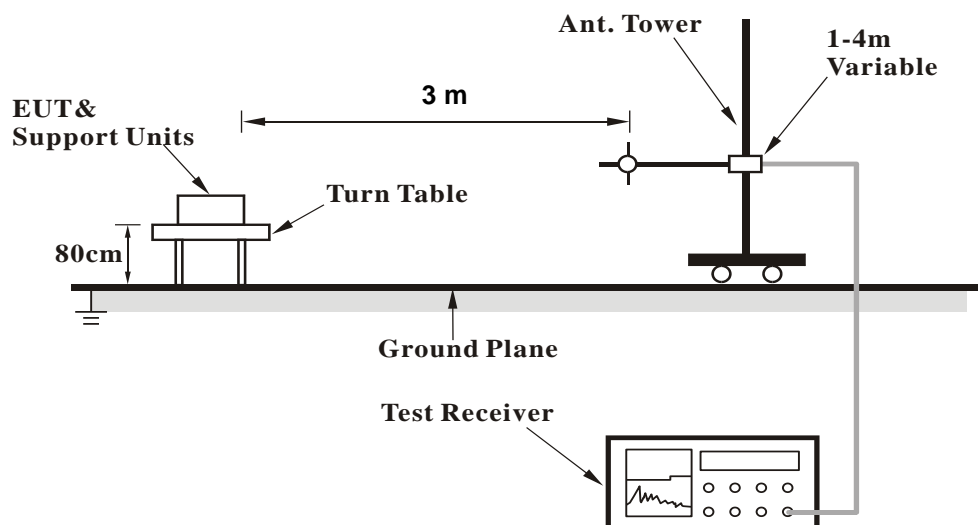

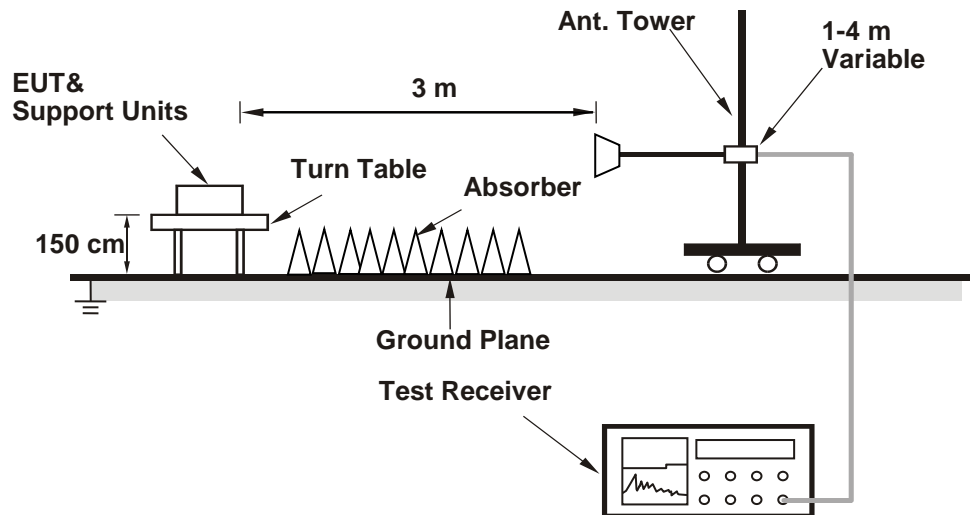
**<Radiated Emissions above 1 GHz>**

For the actual test configuration, please refer to the attached file (Test Setup Photo).

**Test Instruments**

Kind of Equipment	Manufacturer	Type	S/N	Calibration Date	Calibration Due Date
Signal Analyzer	R&S	FSV40	101508	2020/3/16	2021/3/15
Receiver	R&S	ESR7	102108	2020/4/22	2021/4/21
Bilog Antenna	SCHWARZBECK	VULB-9168	00951	2020/2/14	2021/2/12
Horn Antenna	ETS-Lindgren	3117	00218930	2019/12/6	2020/12/4
LF-AMP	Agilent	8447D	2944A10772	2020/2/11	2021/2/9
HF-AMP + AC source	EMCI	EMC051845SE	980633	2020/2/17	2021/2/15
HF-AMP + AC source	EMCI	EMC184045SE	980657	2020/2/17	2021/2/15
Horn Antenna	SCHWARZBECK	BBHA 9170	00887	2020/4/10	2021/4/9
Microwave Cable	HUBER+SUHNER	SUCOFLEX 104EA	800056/4EA	2020/3/25	2021/3/24
Microwave Cable	HUBER+SUHNER	SUCOFLEX 104	804680/4	2020/3/25	2021/3/24
Microwave Cable	HUBER+SUHNER	SUCOFLEX 104	MY37202/4	2020/3/25	2021/3/24
Microwave Cable	HUBER+SUHNER	SUCOFLEX 102EA	800898/2EA	2020/4/22	2021/4/21
Microwave Cable	HUBER+SUHNER	SUCOFLEX 102EA	800901/2EA	2020/4/22	2021/4/21
Microwave Cable	HUBER+SUHNER	SUCOFLEX 102EA	801027/2EA	2020/4/22	2021/4/21
Loop Antenna	Chance Most	EMCILPA600 +calibration	287	2020/1/9	2021/1/7

**Test Procedures****For Radiated Emissions below 30 MHz**

- a. The EUT was placed on the top of a rotating table 0.8 meters above the ground at a 3 meter chamber room. The table was rotated 360 degrees to determine the position of the highest radiation.
- b. The EUT was set 3 meters away from the interference-receiving antenna, which was mounted on the top of a variable-height antenna tower.
- c. Parallel, perpendicular, and ground-parallel orientations of the antenna are set to make the measurement.
- d. For each suspected emission, the EUT was arranged to its worst case and the rotatable table was turned from 0 degrees to 360 degrees to find the maximum reading.
- e. The test-receiver system was set to Quasi-Peak Detect Function and Specified Bandwidth with Maximum Hold Mode.

**Note:**

1. The resolution bandwidth and video bandwidth of test receiver/spectrum analyzer is 9 kHz at frequency below 30 MHz.
2. All modes of operation were investigated and the worst-case emissions are reported.

**For Radiated Emissions above 30 MHz**

- a. The EUT was placed on the top of a rotating table 0.8 meters (for 30 MHz ~ 1 GHz) / 1.5 meters (for above 1 GHz) above the ground at 3 meter chamber room for test. The table was rotated 360 degrees to determine the position of the highest radiation.
- b. The EUT was set 3 meters away from the interference-receiving antenna, which was mounted on the top of a variable-height antenna tower.
- c. The height of antenna is varied from one meter to four meters above the ground to determine the maximum value of the field strength. Both horizontal and vertical polarizations of the antenna are set to make the measurement.
- d. For each suspected emission, the EUT was arranged to its worst case and then the antenna was tuned to heights from 1 meter to 4 meters and the rotatable table was turned from 0 degrees to 360 degrees to find the maximum reading.
- e. The test-receiver system was set to quasi-peak detect function and specified bandwidth with maximum hold mode when the test frequency is below 1 GHz.
- f. The test-receiver system was set to peak and average detected function and specified bandwidth with maximum hold mode when the test frequency is above 1 GHz. If the peak reading value also meets average limit, measurement with the average detector is unnecessary.

**Note:**

1. The resolution bandwidth and video bandwidth of test receiver/spectrum analyzer is 120 kHz for Quasi-peak detection (QP) or Peak detection (PK) at frequency below 1 GHz.
2. The resolution bandwidth of test receiver/spectrum analyzer is 1 MHz and the video bandwidth is 3 MHz for Peak detection (PK) at frequency above 1 GHz.
3. The resolution bandwidth of test receiver/spectrum analyzer is 1 MHz and the video bandwidth is  $\geq 1/T$  (Duty cycle < 98 %) or 10 Hz (Duty cycle  $\geq$  98 %) for Average detection (AV) at frequency above 1 GHz.
4. All modes of operation were investigated and the worst-case emissions are reported.
5. The Radiated Emissions testing was performed in the X, Y and Z axis orientation. The worst-case Axis orientation is recorded in this test report.



**Prüfbericht - Nr.: NN202ULD(P15C-BR/EDR) 001**  
*Test Report No.*

**Seite 25 von 32**  
*Page 25 of 32*

**Test Results**

Factor (dB/m) = Antenna Factor (dB/m) + Cable Loss (dB)

Level (dBuV/m) = Reading (dBuV) + Factor (dB/m)

Please refer to Appendix B.

### 5.1.6 Hopping Channel Separation

**Limit**  $\geq 25$  kHz or 2/3 of 20 dB bandwidth, whichever is greater

**Kind of Test Site** Shielded room

#### Test Setup

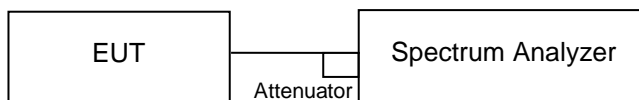

#### Test Instruments

Kind of Equipment	Manufacturer	Type	S/N	Calibration Date	Calibration Due Date
Spectrum Analyzer	R&S	FSV40	101512	2020/2/18	2021/2/16

#### Test Procedure

Measurement Procedure REF

- Check the calibration of the measuring instrument using either an internal calibrator or a known signal from an external generator.
- Turn on the EUT and connect it to measurement instrument. Then set it to any one convenient frequency within its operating range.
- By using the MaxHold function record the separation of two adjacent channels.
- Measure the frequency difference of these two adjacent channels by SA MARK function. And then plot the result on SA screen.
- Repeat above procedures until all frequencies measured were complete.

#### Test Results

Please refer to Appendix A.

### 5.1.7 Number of Hopping Frequency

**Limit**  $\geq 15$  non-overlapping channels

**Kind of Test Site** Shielded room

**Test Setup**

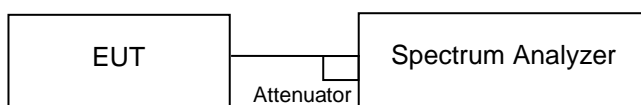

**Test Instruments**

Kind of Equipment	Manufacturer	Type	S/N	Calibration Date	Calibration Due Date
Spectrum Analyzer	R&S	FSV40	101512	2020/2/18	2021/2/16

**Test Procedure**

- a. Check the calibration of the measuring instrument (SA) using either an internal calibrator or a known signal from an external generator.
- b. Turn on the EUT and connect its antenna terminal to measurement via a low loss cable. Then set it to any one measured frequency within its operating range and make sure the instrument is operated in its linear range.
- c. Set the SA on MaxHold Mode, and then keep the EUT in hopping mode. Record all the signals from each channel until each one has been recorded.
- d. Set the SA on View mode and then plot the result on SA screen.
- e. Repeat above procedures until all frequencies measured were complete.

**Test Results**

Please refer to Appendix A.

### 5.1.8 Dwell Time

**Limit** 0.4s

**Kind of Test Site** Shielded room

#### Test Setup

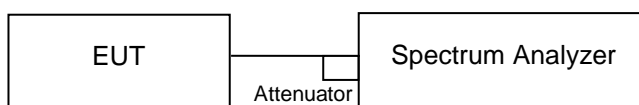

#### Test Instruments

Kind of Equipment	Manufacturer	Type	S/N	Calibration Date	Calibration Due Date
Spectrum Analyzer	R&S	FSV40	101512	2020/2/18	2021/2/16

#### Test Procedures

- Check the calibration of the measuring instrument (SA) using either an internal calibrator or a known signal from an external generator.
- Turn on the EUT and connect its antenna terminal to measurement via a low loss cable. Then set it to any one measured frequency within its operating range and make sure the instrument is operated in its linear range.
- Adjust the center frequency of SA on any frequency be measured and set SA to zero span mode. And then, set RBW and VBW of spectrum analyzer to proper value.
- Measure the time duration of one transmission on the measured frequency. And then plot the result with time difference of this time duration.
- Repeat above procedures until all different time-slot modes have been completed.

#### Test Results

Please refer to Appendix A.

## 5.2 Mains Emission

### 5.2.1 Mains Conducted Emission

**Limit**

Mains Conducted Emission as defined in §15.207 must comply with the mains conducted emission limits.

**Kind of Test Site**                      Shielded room

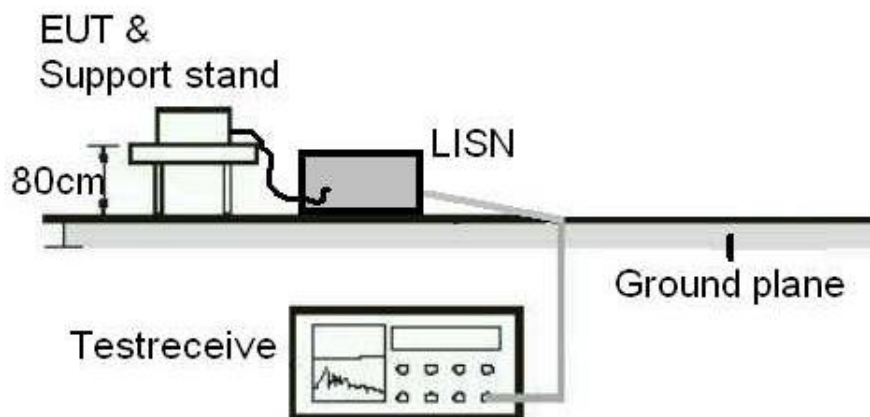
**Test Setup**

**Test Instruments**

Kind of Equipment	Manufacturer	Type	S/N	Calibration Date	Calibration Due Date
TWO-LINE V-NETWORK	SCHHWARZBECK	NSLK 8127	8127-00976	2019/10/2	2020/9/30
EMI Test Receiver	R&S	ESR7	102108	2020/4/22	2021/4/21
10dB attenuation	SCHHWARZBECK	VTSD 9561 F-N	660	2020/2/24	2021/2/23
Measurement Software	EZ	EZ_EMG (Version NB-03A)	N/A	N/A	N/A

**Test Procedures**

- a. The EUT was placed 0.4 meters from the conducting wall of the shielded room with EUT being connected to the power mains through a line impedance stabilization network (LISN). Other support units were connected to the power mains through another LISN. The two LISNs provide 50 ohm/50 uH of coupling impedance for the measuring instrument.
- b. Both lines of the power mains connected to the EUT were checked for maximum conducted interference.
- c. The frequency range from 150 kHz to 30 MHz was searched. Emission levels under (Limit – 20 dB) was not recorded.

Note: The resolution bandwidth and video bandwidth of test receiver is 9 kHz for quasi-peak detection (QP) and average detection (AV) at frequency 0.15 MHz – 30 MHz.

**Test Results**

Please refer to Appendix B.

## **6. Safety Human exposure**

### **6.1 RF Exposure Compliance**

#### **6.1.1 SAR Test Exclusion Thresholds**

##### **Results**

Since the maximum output power of the transmitter is  $13.614 \text{ mW} < 19 \text{ mW}$  (Distance: 10 mm), hence the EUT is excluded from SAR evaluation according to FCC KDB publication 447498 D01: Mobile Portable RF Exposure.



## Appendix A: Test Results of Conducted Test

### Test Result of 20 dB Bandwidth

#### GFSK

Channel	Channel Frequency (MHz)	20 dB Bandwidth (kHz)	Result
Low Channel	2402	1024.98	Pass
Middle Channel	2441	1024.98	Pass
High Channel	2480	1025.00	Pass

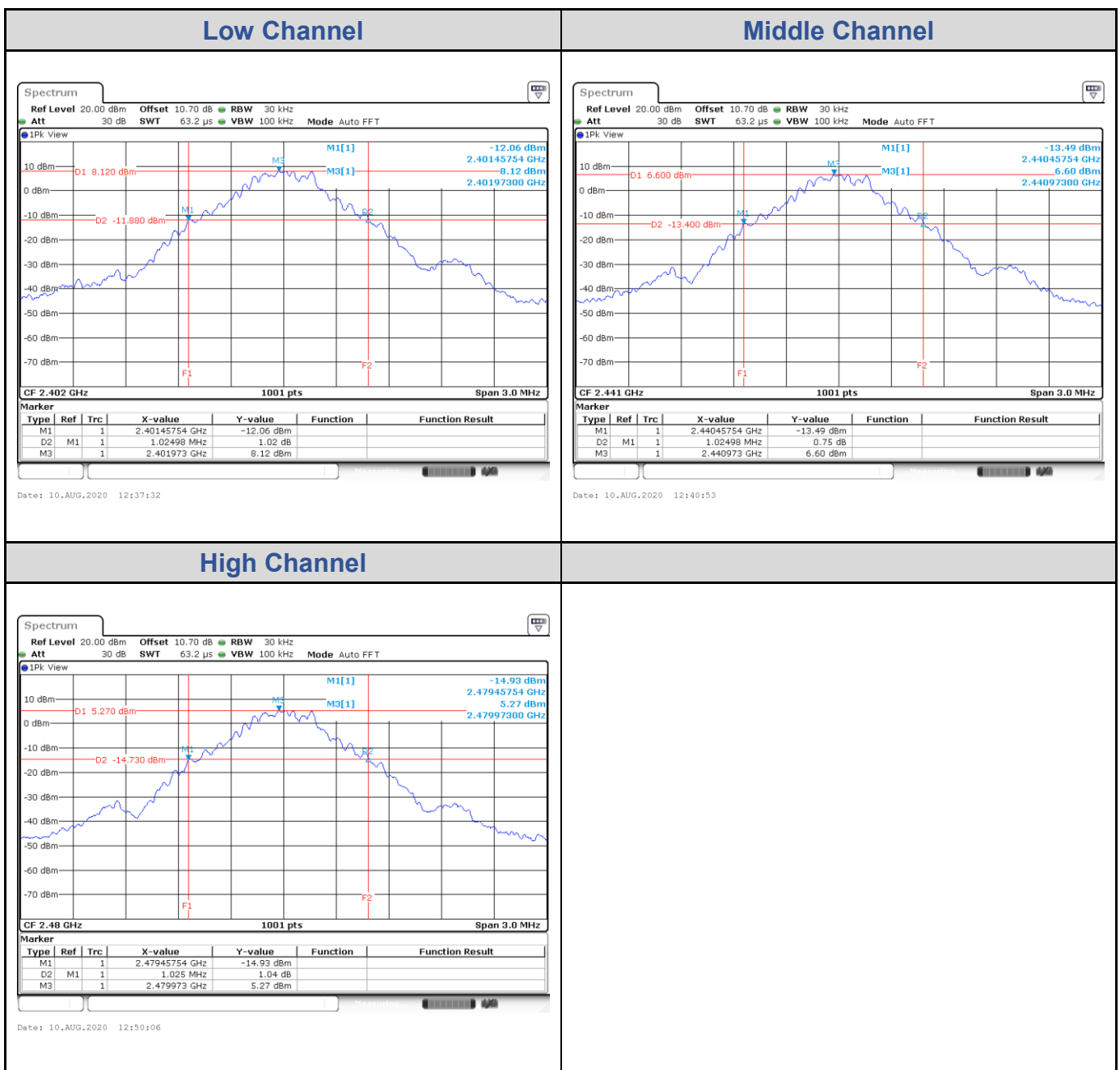

**8DPSK**

Channel	Channel Frequency (MHz)	20 dB Bandwidth (kHz)	Result
Low Channel	2402	1297.70	Pass
Middle Channel	2441	1294.70	Pass
High Channel	2480	1291.70	Pass

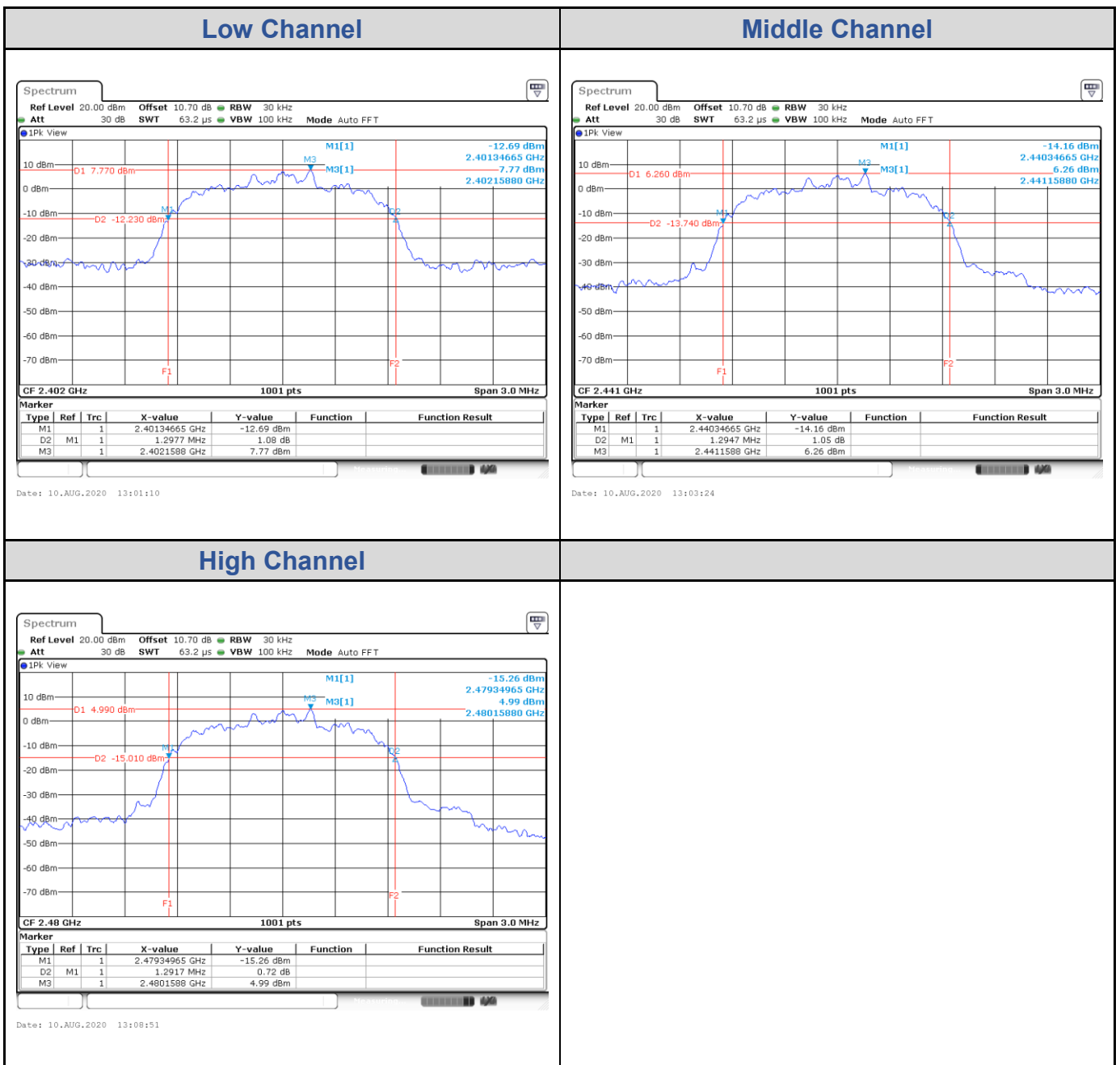

## Test Result of 99% Occupied Bandwidth

### GFSK

Channel	Channel Frequency (MHz)	99% Bandwidth (kHz)
Low Channel	2402	899.10
Middle Channel	2441	899.10
High Channel	2480	899.10

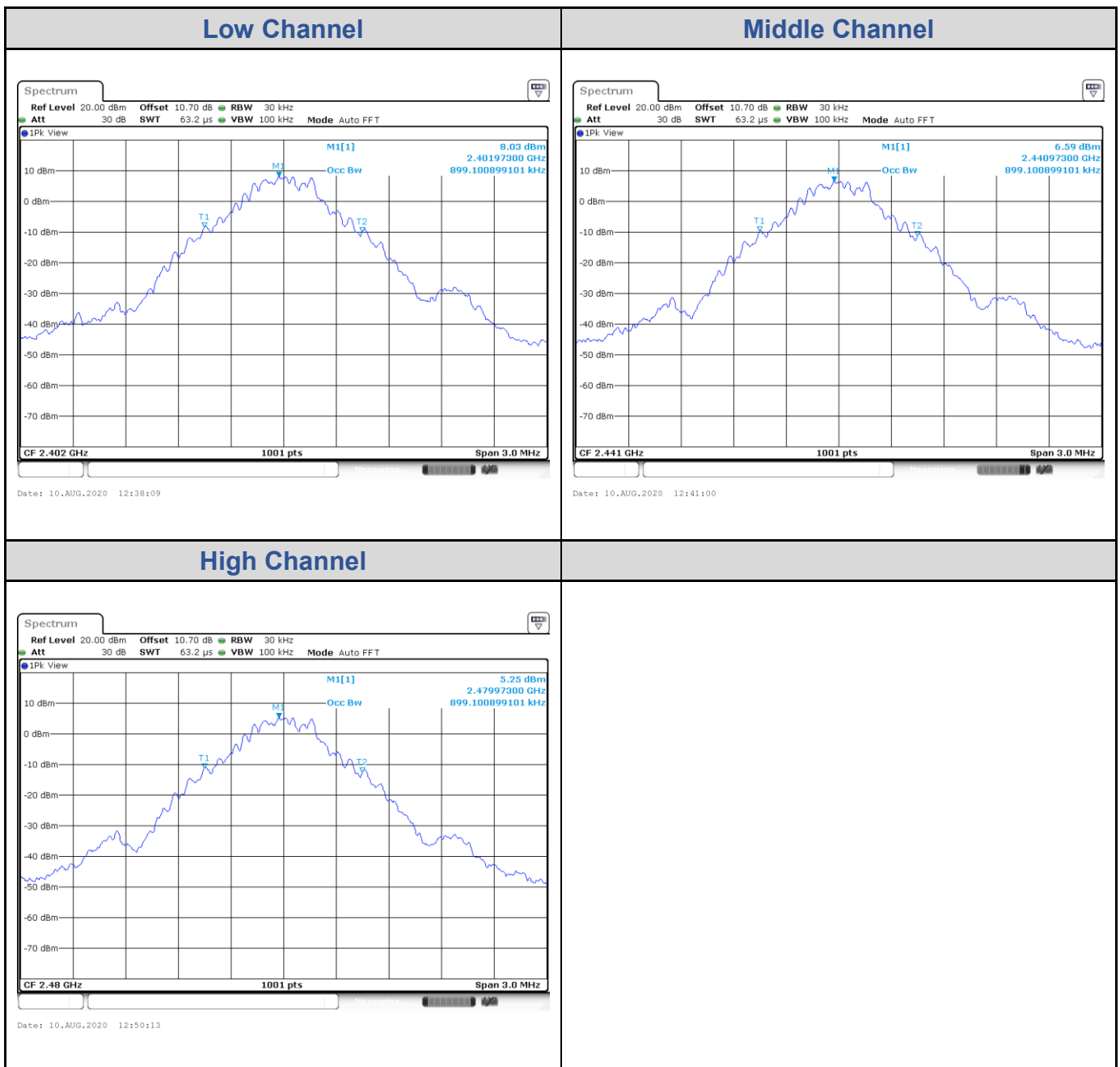

**8DPSK**

Channel	Channel Frequency (MHz)	99% Bandwidth (kHz)
Low Channel	2402	1177.82
Middle Channel	2441	1171.83
High Channel	2480	1165.83

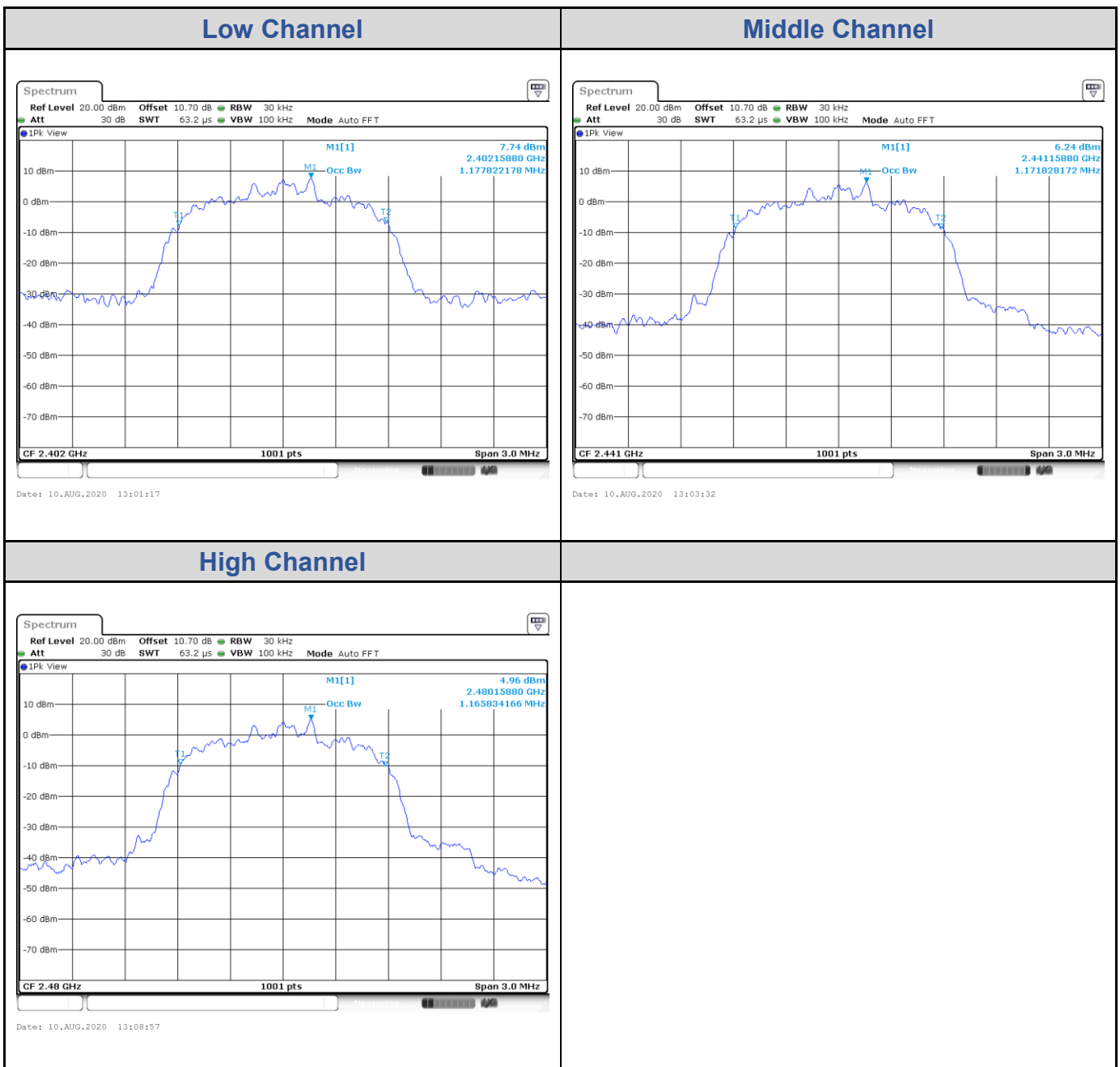

## Test Result of Conducted Spurious Emissions, Tx Mode

### GFSK

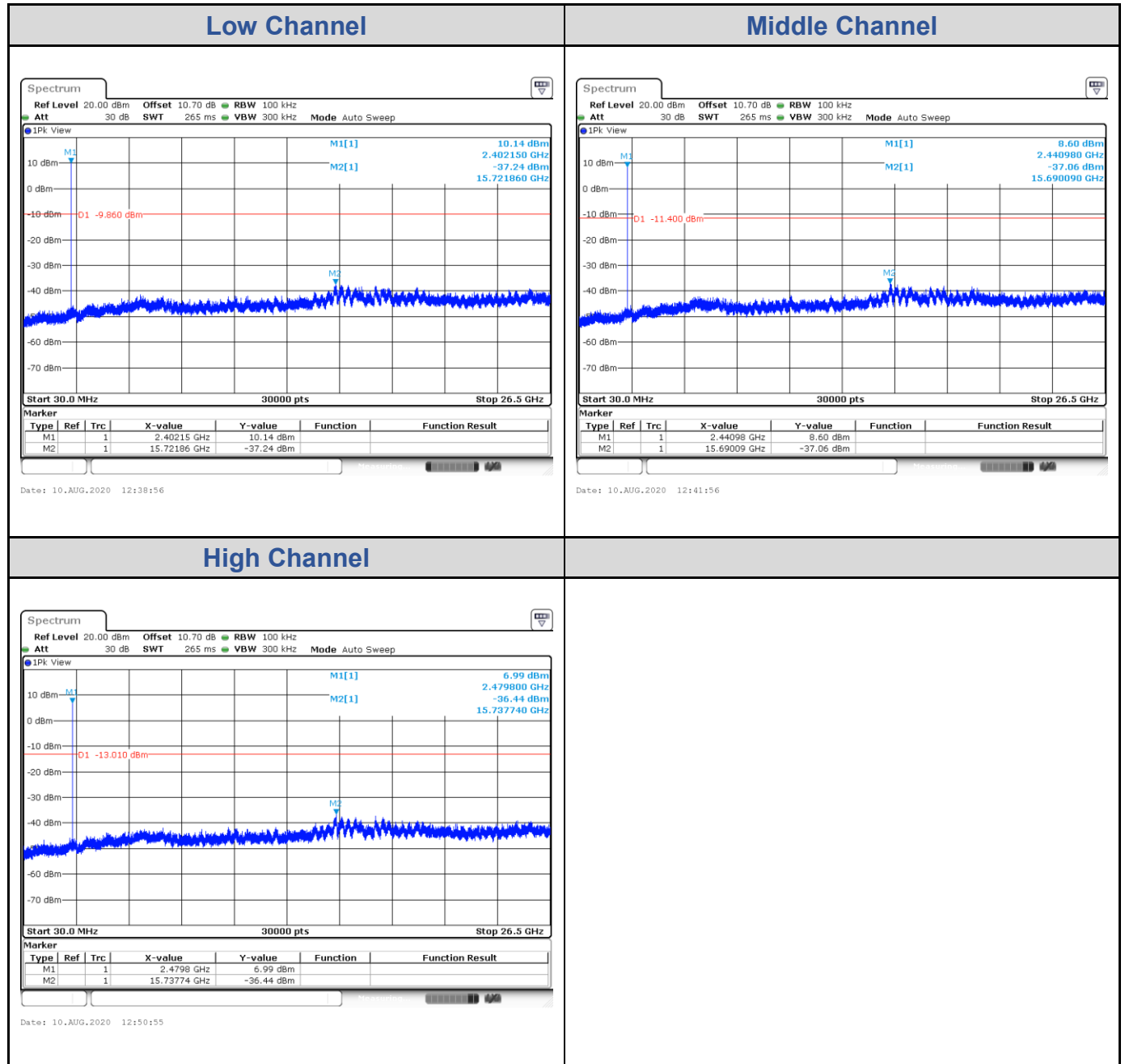

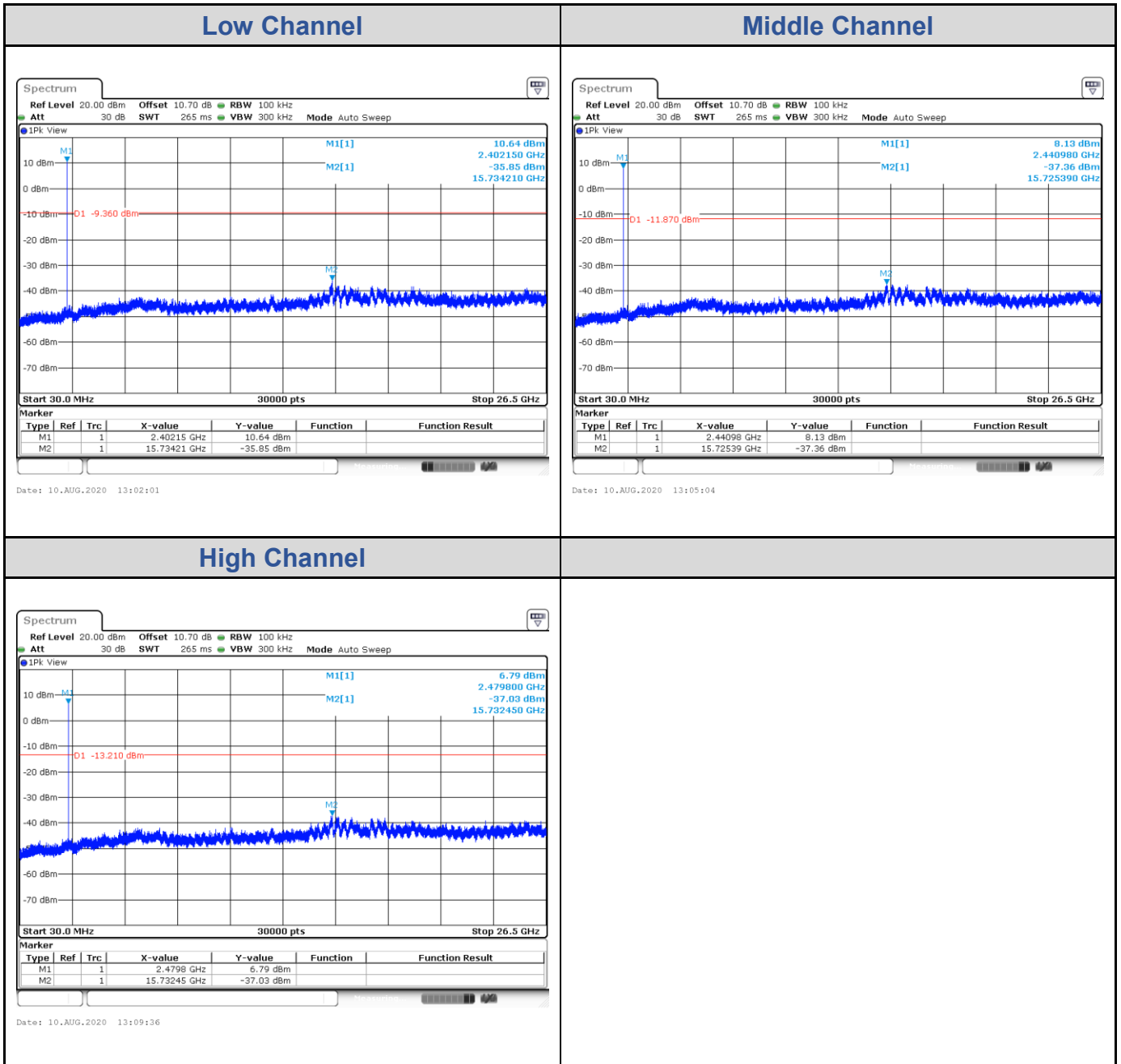
**8DPSK**

## Test Result of Conducted Band Edge, Tx Mode

### GFSK

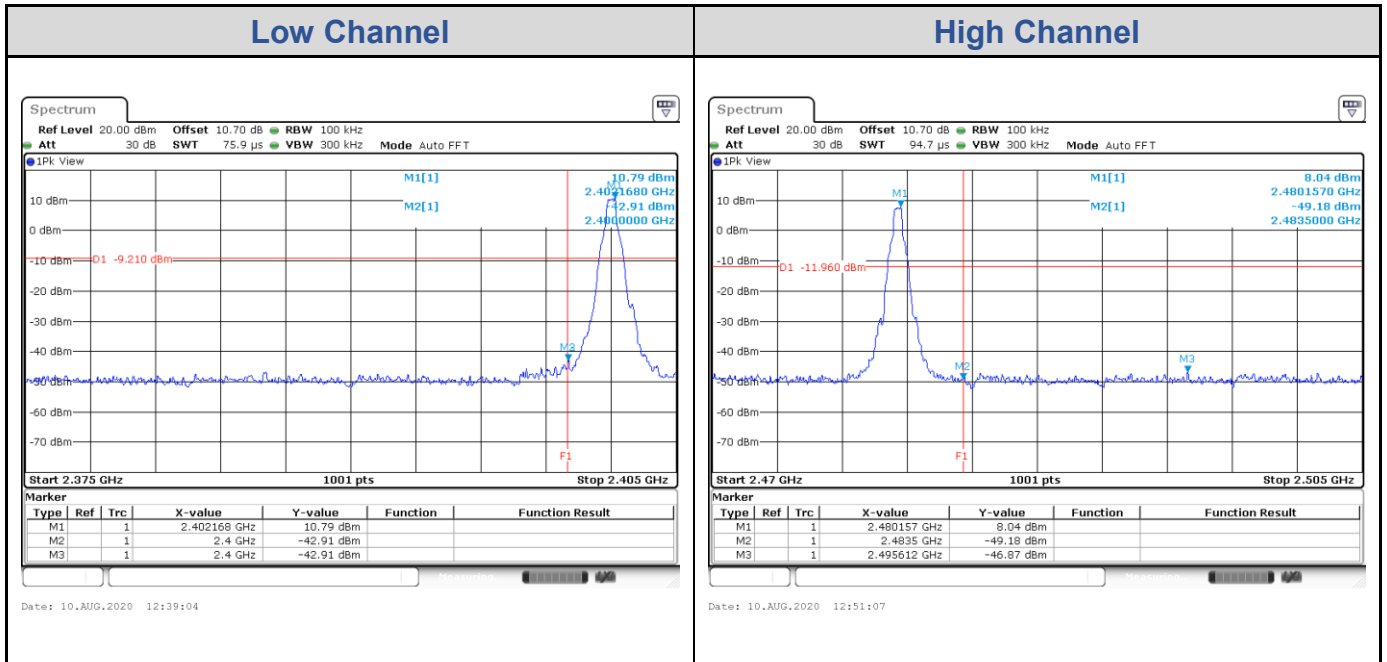

### 8DPSK

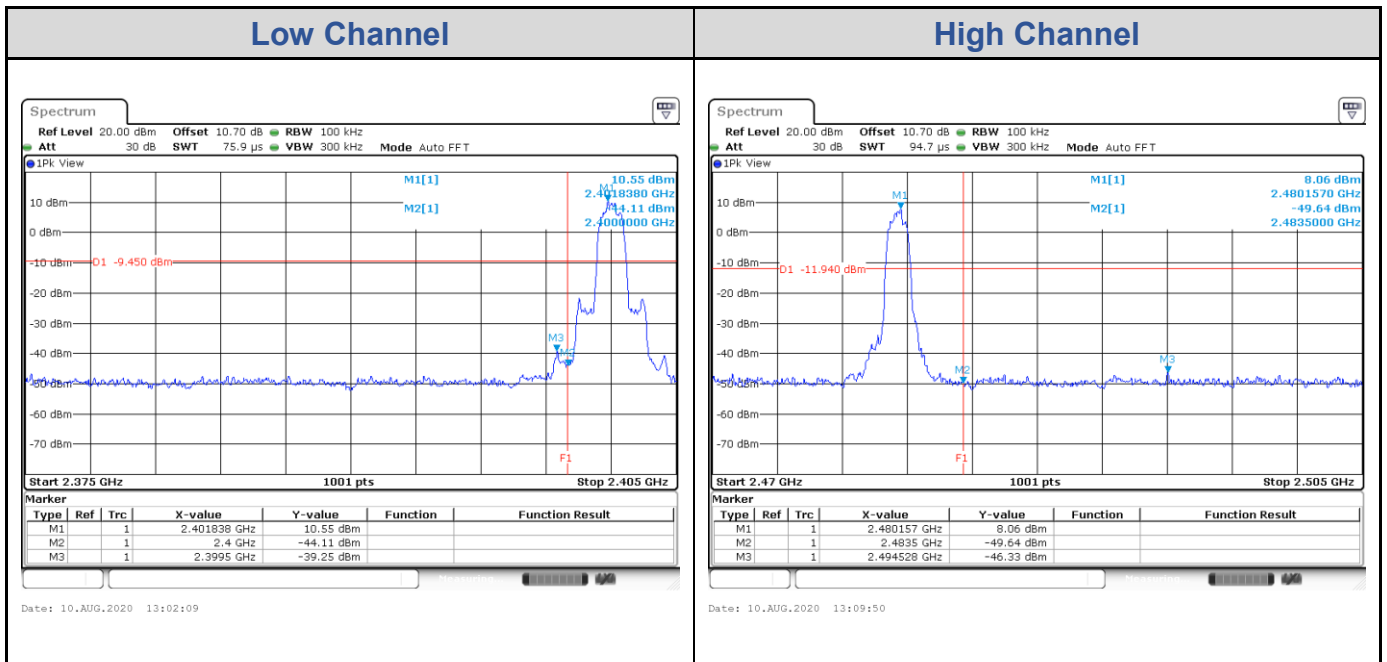

## Test Result of Hopping Band Edge

### GFSK

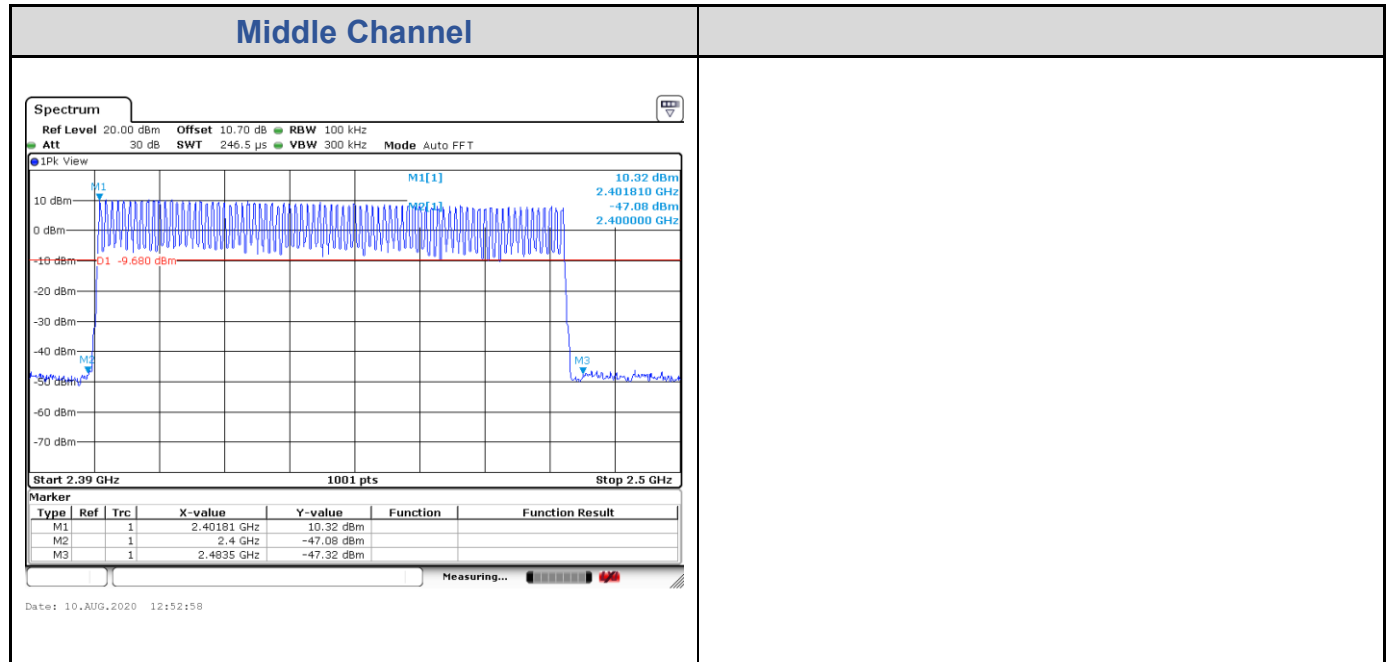

### 8DPSK

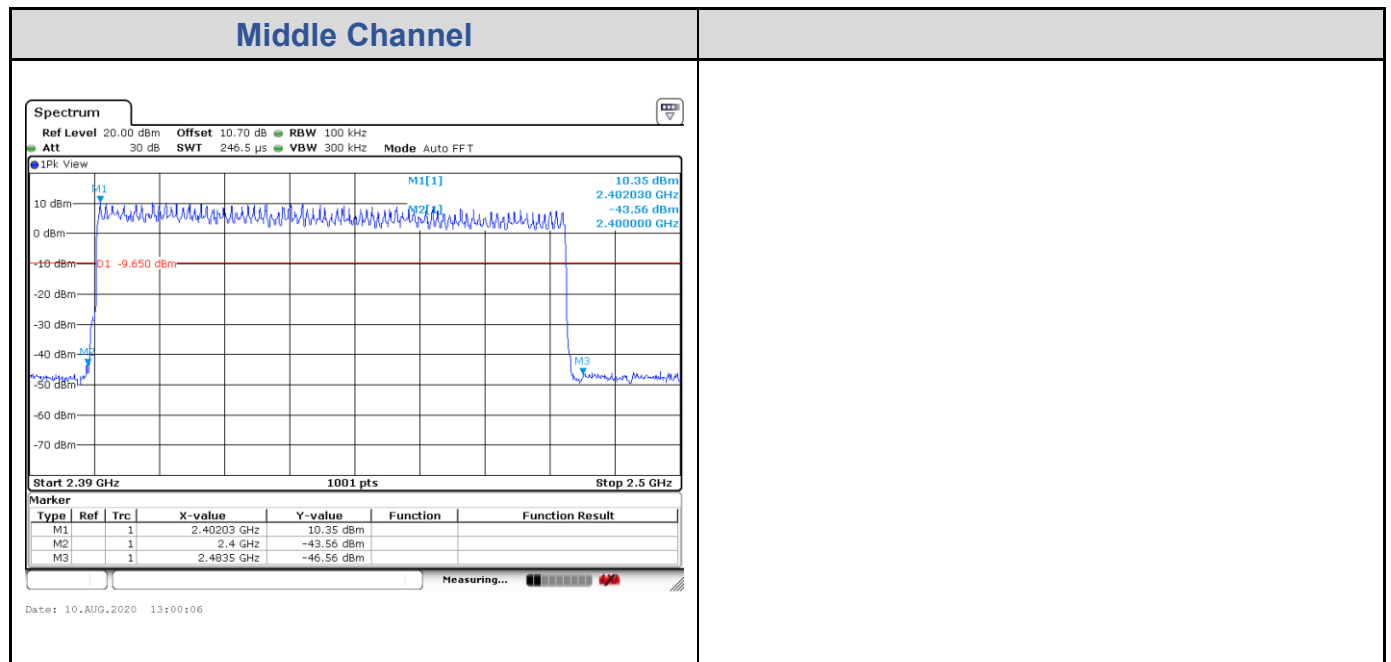



## Test Result of Hopping Channel Separation

### GFSK

Channel	Channel Frequency (MHz)	Adjacent Channel Separation (MHz)	20 dB Bandwidth (kHz)	Minimum Limit (MHz)	Result
0	2402	1.00	1024.98	0.683	Pass
39	2441	1.00	1024.98	0.683	Pass
78	2480	1.00	1025.00	0.683	Pass

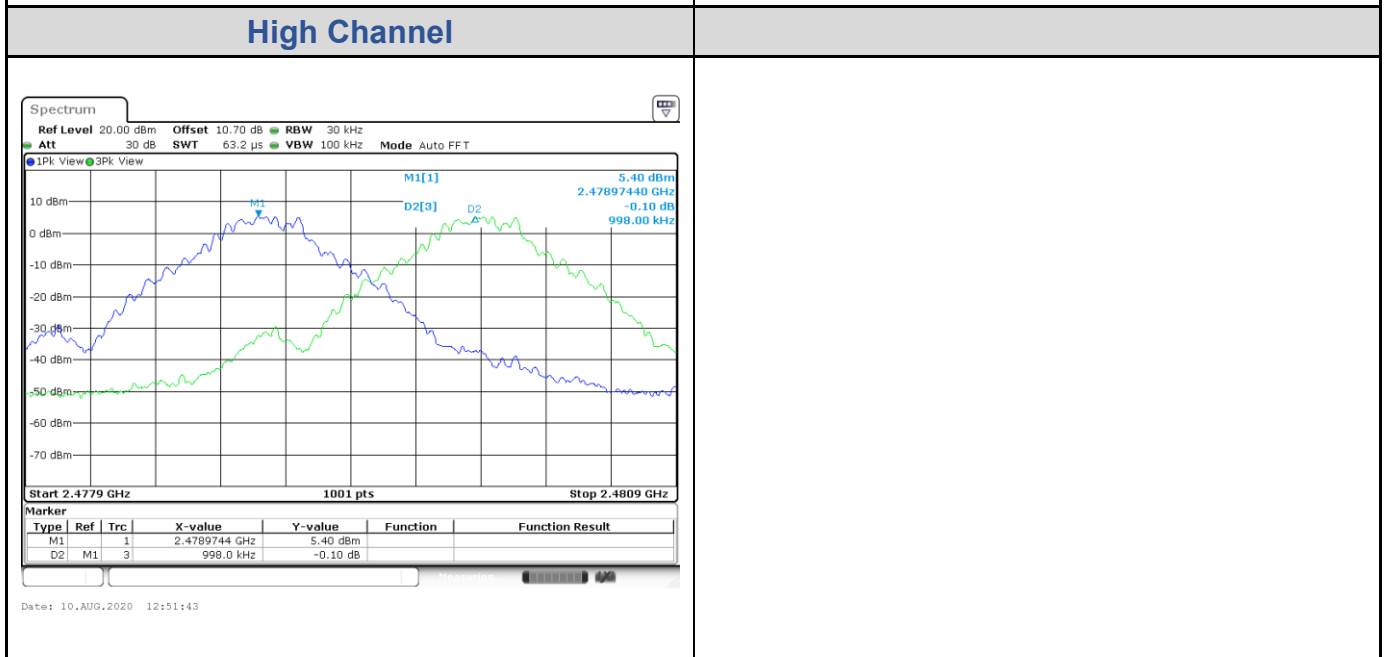
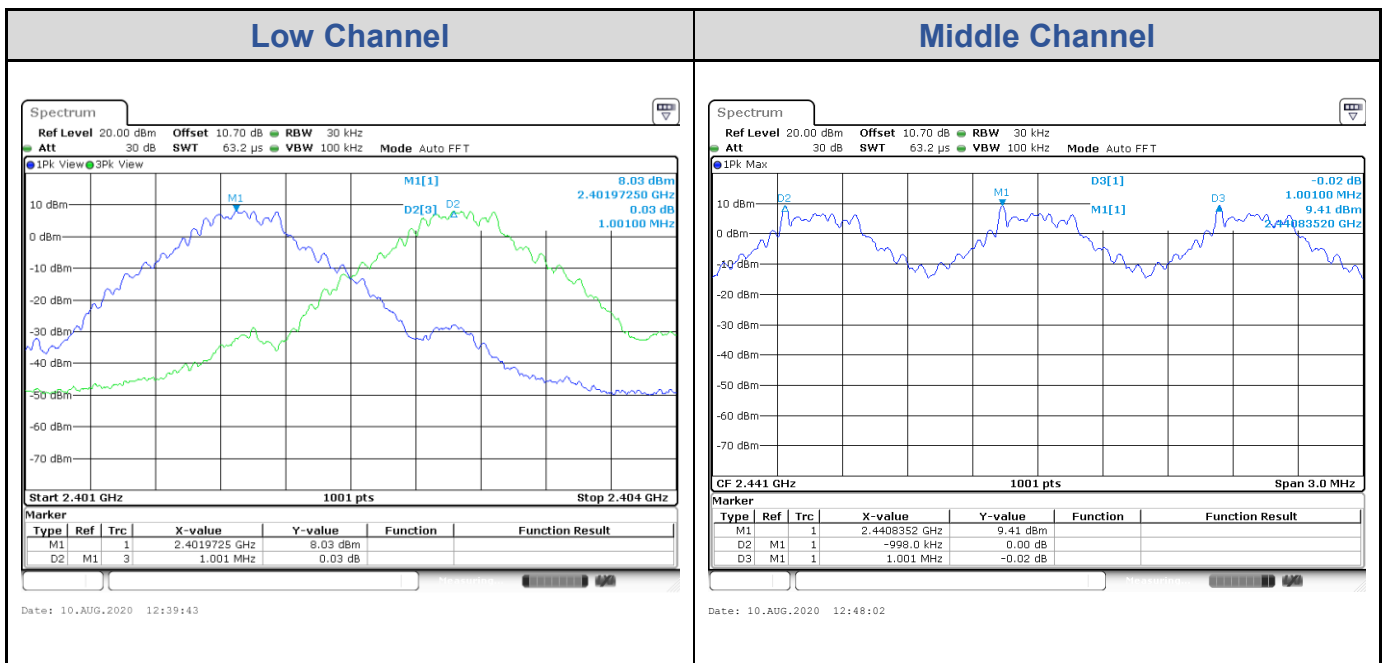

**8DPSK**

Channel	Channel Frequency (MHz)	Adjacent Channel Separation (MHz)	20 dB Bandwidth (kHz)	Minimum Limit (MHz)	Result
0	2402	1.00	1297.70	0.865	Pass
39	2441	1.00	1294.70	0.863	Pass
78	2480	1.00	1291.70	0.861	Pass

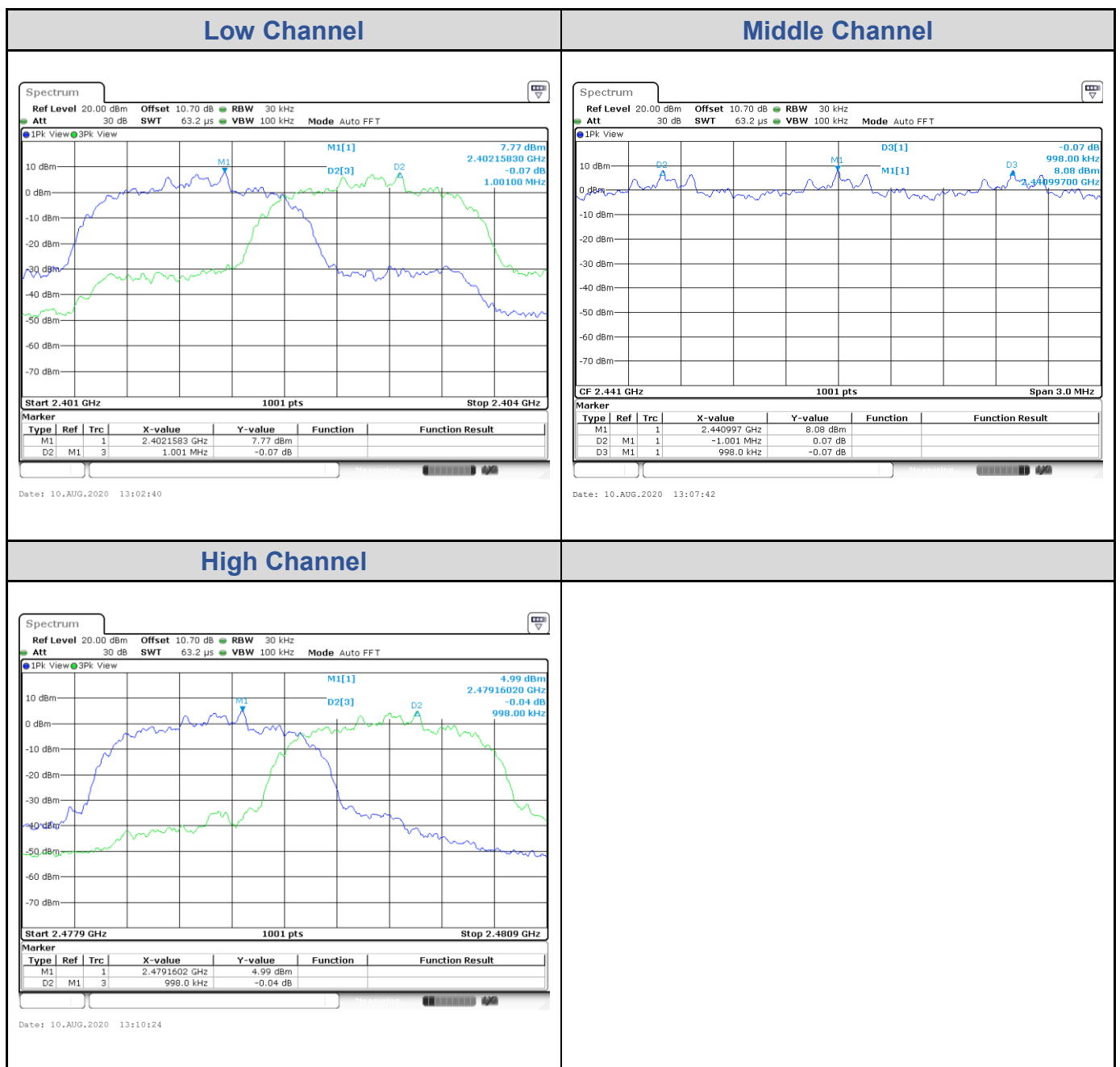

### Test Result of Number of Hopping Frequency

Frequency Range	Measured Quantity of Hopping Channel	Limit	Result
2400 to 2483.5 MHz	79	≥15	Pass

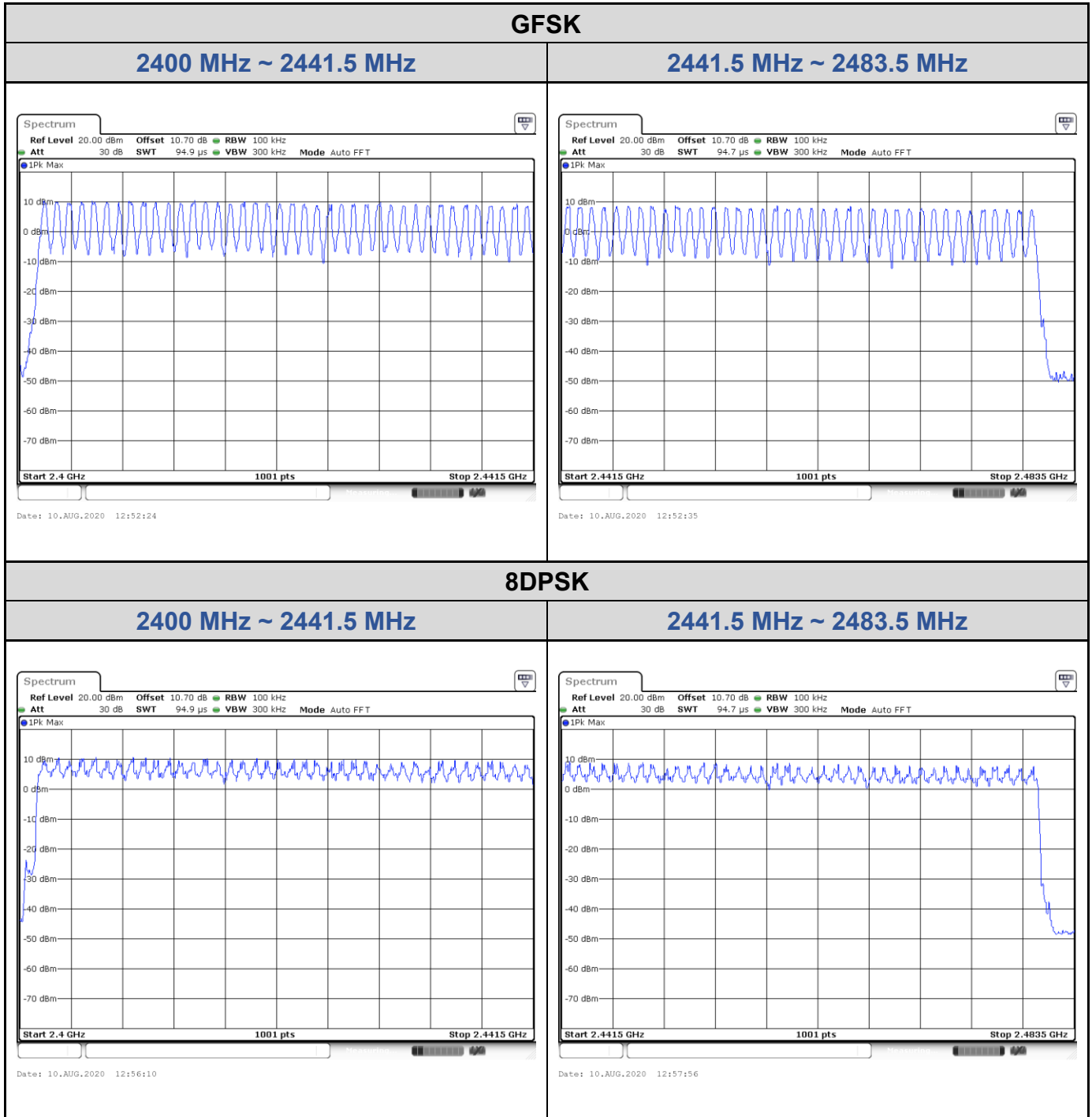

### Test Result of Dwell Time

#### GFSK

Data Mode	Number of transfer in a 31.6 (79Hopping*0.4s)	Package transfer time (msec)	Dwell time (s)	Limit (s)	Result
1DH5	16 (times / 5 sec) * 6.32 = 101.12 times	2.93	0.296	0.4	Pass

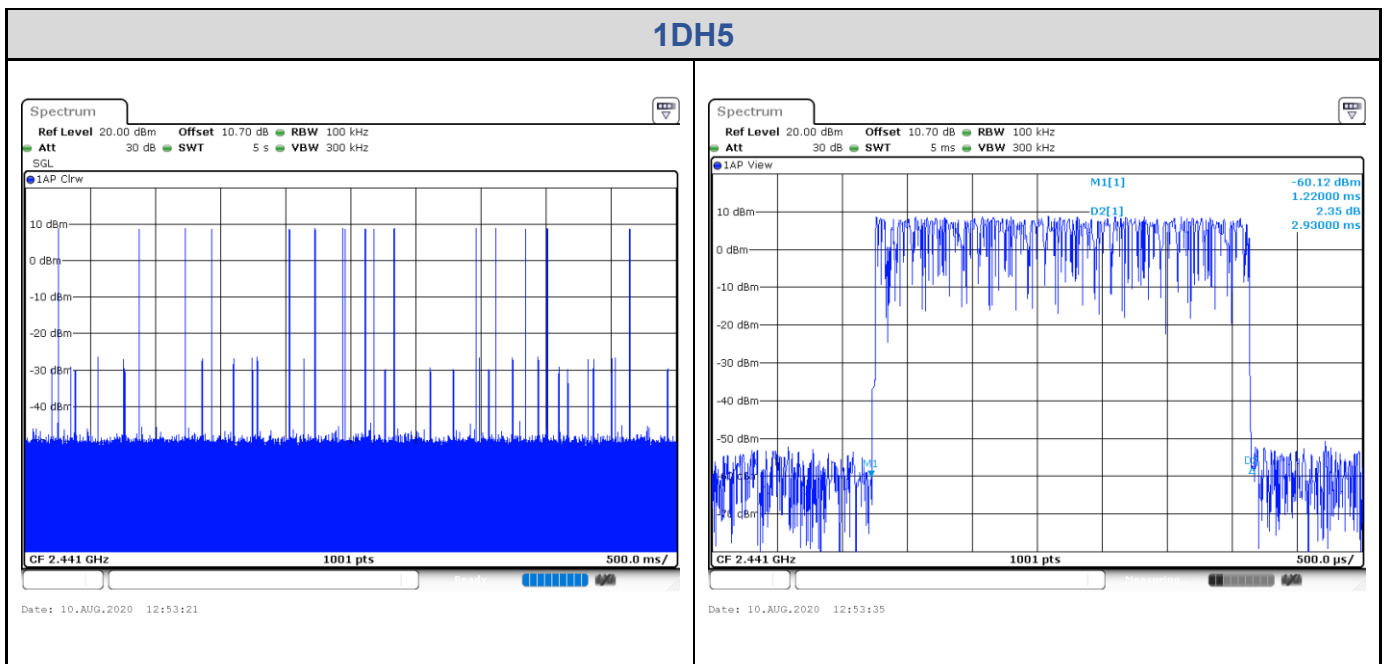

8DPSK

Data Mode	Number of transfer in a 31.6 (79Hopping*0.4s)	Package transfer time (msec)	Dwell time (s)	Limit (s)	Result
3DH5	14 (times / 5 sec) * 6.32 = 88.48 times	2.935	0.259	0.4	Pass

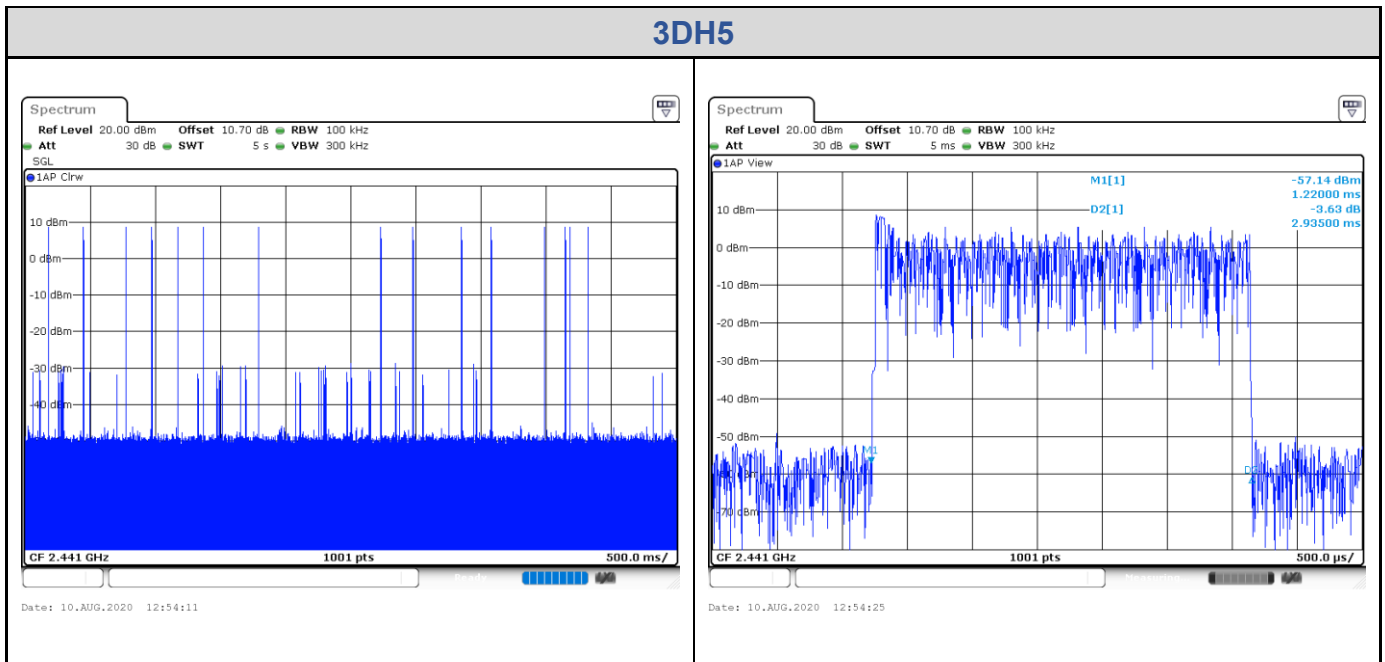

# Appendix B: Test Results of Radiated Spurious Emissions & Mains

## Conducted Emission Test

### Band Edges, 2.31GHz ~ 2.9GHz

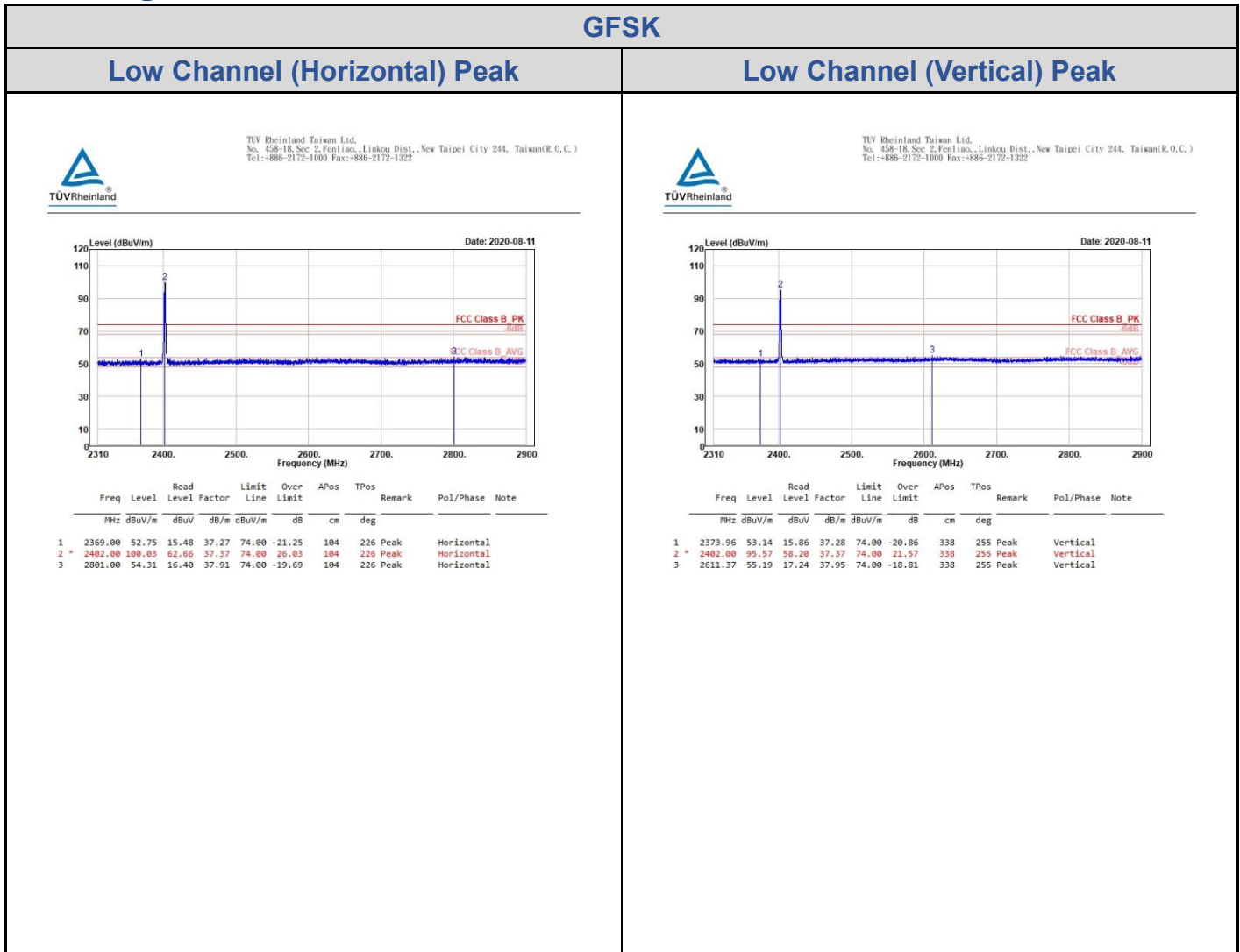

GFSK

Low Channel (Horizontal) Average

Low Channel (Vertical) Average

TÜVRheinland  
TUV Rheinland Taiwan Ltd.  
No. 458-18, Sec. 2, Fenhiao, Linkou Dist., New Taipei City 244, Taiwan(R.O.C.)  
Tel: +886-2172-1000 Fax: +886-2172-1322

TÜVRheinland  
TUV Rheinland Taiwan Ltd.  
No. 458-18, Sec. 2, Fenhiao, Linkou Dist., New Taipei City 244, Taiwan(R.O.C.)  
Tel: +886-2172-1000 Fax: +886-2172-1322

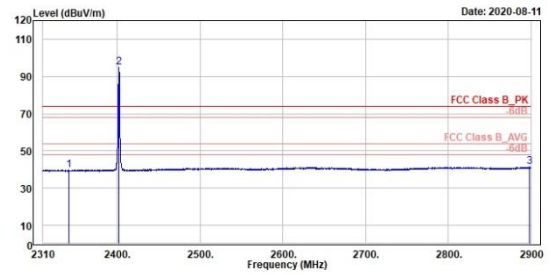
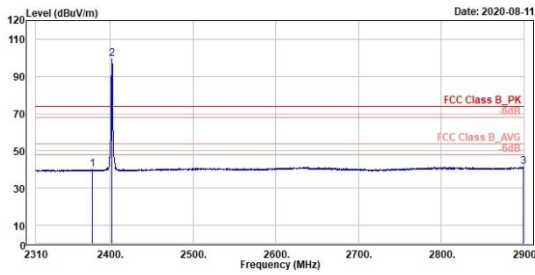

Freq	Level	Read	Limit	Over	APos	TPos	Remark	Pol/Phase	Note
MHz	dBuV/m	dBuV	dB/m	dBuV/m	dB	cm	deg		
1	2378.09	39.04	2.64	37.30	54.00	-14.06	104	226 Average	Horizontal
2 *	2402.00	99.52	62.15	37.37	54.00	45.52	104	226 Average	Horizontal
3	2899.76	41.38	3.06	38.32	54.00	-12.62	104	226 Average	Horizontal

Freq	Level	Read	Limit	Over	APos	TPos	Remark	Pol/Phase	Note
MHz	dBuV/m	dBuV	dB/m	dBuV/m	dB	cm	deg		
1	2341.15	39.08	2.70	37.18	54.00	-14.12	338	255 Average	Vertical
2 *	2402.00	95.04	57.07	37.37	54.00	41.04	338	255 Average	Vertical
3	2899.47	41.36	3.05	38.31	54.00	-12.64	338	255 Average	Vertical

**GFSK**
**High Channel (Horizontal) Peak**
**High Channel (Vertical) Peak**

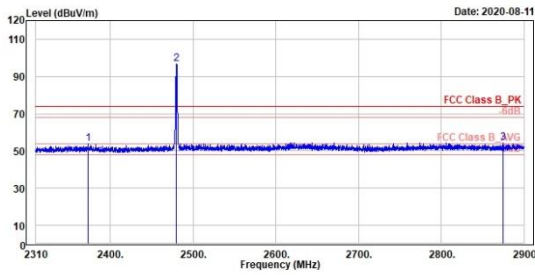

TÜV Rheinland Taiwan Ltd.  
 No. 458-18, Sec. 2, Fenhiao, Linkou Dist., New Taipei City 244, Taiwan(R.O.C.)  
 Tel: +886-2172-1000 Fax: +886-2172-1322



Peak	Freq	Level	Read Level	Factor	Limit Line	Over Limit	APos	TPos	Remark	Pol/Phase	Note
	MHz	dBuV/m	dBuV	dB/m	dBuV/m	dB	cm	deg			
1	2373.01	53.04	16.56	37.28	74.00	-20.16	295	319	Peak	Horizontal	
2 *	2480.00	96.78	59.22	37.56	74.00	22.78	295	319	Peak	Horizontal	
3	2874.98	54.49	16.30	38.19	74.00	-19.51	295	319	Peak	Horizontal	

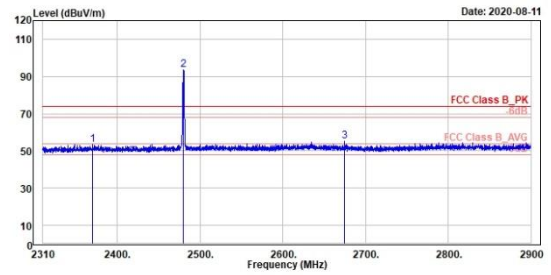

TÜV Rheinland Taiwan Ltd.  
 No. 458-18, Sec. 2, Fenhiao, Linkou Dist., New Taipei City 244, Taiwan(R.O.C.)  
 Tel: +886-2172-1000 Fax: +886-2172-1322



Peak	Freq	Level	Read Level	Factor	Limit Line	Over Limit	APos	TPos	Remark	Pol/Phase	Note
	MHz	dBuV/m	dBuV	dB/m	dBuV/m	dB	cm	deg			
1	2370.06	53.32	16.05	37.27	74.00	-20.68	400	248	Peak	Vertical	
2 *	2480.00	93.58	56.02	37.56	74.00	19.58	400	248	Peak	Vertical	
3	2675.09	55.13	17.31	37.82	74.00	-18.87	400	248	Peak	Vertical	



GFSK

High Channel (Horizontal) Average

High Channel (Vertical) Average



TUV Rheinland Taiwan Ltd.  
No. 458-18, Sec. 2, Fenhiao, Linkou Dist., New Taipei City 244, Taiwan(R.O.C.)  
Tel: +886-2172-1000 Fax: +886-2172-1322

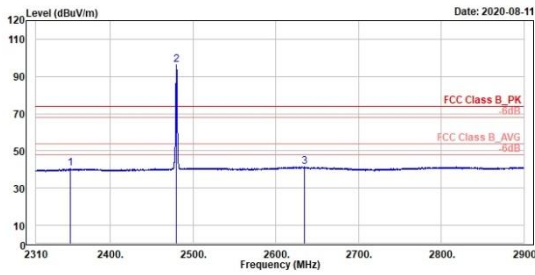

Freq	Level	Read Level	Factor	Limit Line	Over Limit	APos	TPos	Remark	Pol/Phase	Note
MHz	dBuV/m	dBuV	dB/m	dBuV/m	dB	cm	deg			
1	2352.01	48.44	3.23	37.21	54.00	-13.56	295	319 Average	Horizontal	
2 *	2480.00	96.21	56.65	37.56	54.00	42.21	295	319 average	Horizontal	
3	2634.85	41.54	3.65	37.89	54.00	-12.46	295	319 Average	Horizontal	



TUV Rheinland Taiwan Ltd.  
No. 458-18, Sec. 2, Fenhiao, Linkou Dist., New Taipei City 244, Taiwan(R.O.C.)  
Tel: +886-2172-1000 Fax: +886-2172-1322

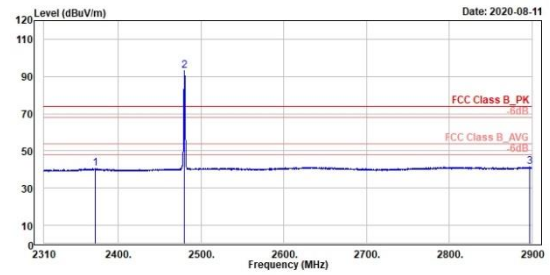

Freq	Level	Read Level	Factor	Limit Line	Over Limit	APos	TPos	Remark	Pol/Phase	Note
MHz	dBuV/m	dBuV	dB/m	dBuV/m	dB	cm	deg			
1	2371.71	48.59	3.32	37.27	54.00	-13.41	400	248 Average	Vertical	
2 *	2480.00	92.95	55.39	37.56	54.00	38.95	400	248 Average	Vertical	
3	2897.29	41.37	3.06	38.31	54.00	-12.63	400	248 Average	Vertical	

8DPSK

Low Channel (Horizontal) Peak

Low Channel (Vertical) Peak

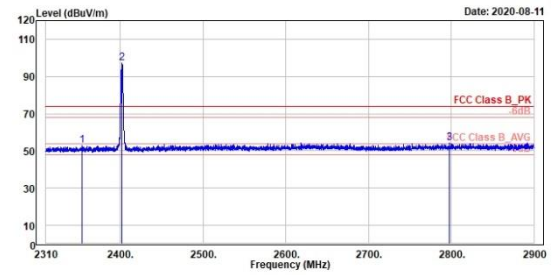
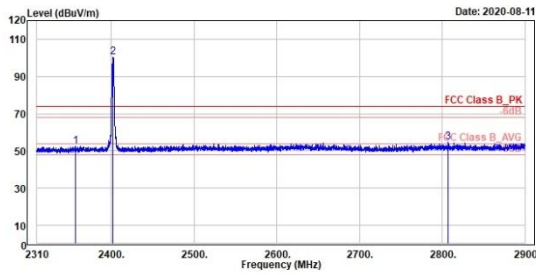

Peak	Freq (MHz)	Level (dBuV/m)	Read Level (dBuV)	Level Factor (dB/m)	Limit Line (dBuV/m)	Over Limit (dB)	APos (cm)	TPos (deg)	Remark	Pol/Phase	Note
1	2356.73	52.43	15.21	37.22	74.00	-21.57	144	222	Peak	Horizontal	
2 *	2482.00	100.49	63.12	37.37	74.00	26.49	144	222	Peak	Horizontal	
3	2897.49	54.54	16.61	37.93	74.00	-19.46	144	222	Peak	Horizontal	

Peak	Freq (MHz)	Level (dBuV/m)	Read Level (dBuV)	Level Factor (dB/m)	Limit Line (dBuV/m)	Over Limit (dB)	APos (cm)	TPos (deg)	Remark	Pol/Phase	Note
1	2353.54	52.82	15.60	37.22	74.00	-21.18	307	263	Peak	Vertical	
2 *	2482.00	97.07	59.78	37.37	74.00	23.07	307	263	Peak	Vertical	
3	2797.69	54.44	16.53	37.91	74.00	-19.56	307	263	Peak	Vertical	

8DPSK

Low Channel (Horizontal) Average

Low Channel (Vertical) Average

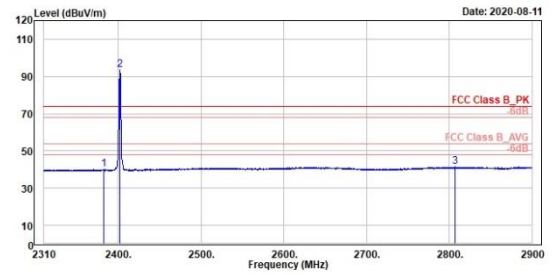
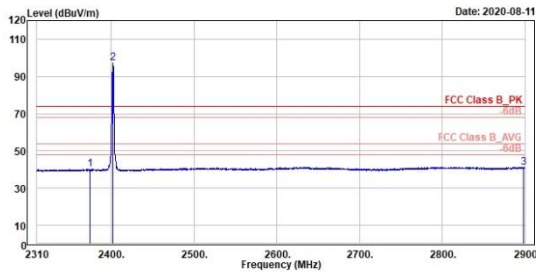

Freq	Level	Read Level	Factor	Limit Line	Over Limit	APos	TPos	Remark	Pol/Phase	Note
MHz	dBuV/m	dBuV	dB/m	dBuV/m	dB	cm	deg			
1	2373.96	48.24	2.96	37.28	54.00	-13.76	144	222 Average	Horizontal	
2 *	2482.00	96.98	59.61	37.37	54.00	42.98	144	222 Average	Horizontal	
3	2898.70	41.27	2.96	38.31	54.00	-12.73	144	222 Average	Horizontal	

Freq	Level	Read Level	Factor	Limit Line	Over Limit	APos	TPos	Remark	Pol/Phase	Note
MHz	dBuV/m	dBuV	dB/m	dBuV/m	dB	cm	deg			
1	2382.10	40.02	2.72	37.30	54.00	-13.98	307	263 Average	Vertical	
2 *	2482.00	93.54	56.17	37.37	54.00	39.54	307	263 Average	Vertical	
3	2807.37	41.33	3.40	37.93	54.00	-12.67	307	263 Average	Vertical	

8DPSK

High Channel (Horizontal) Peak

High Channel (Vertical) Peak

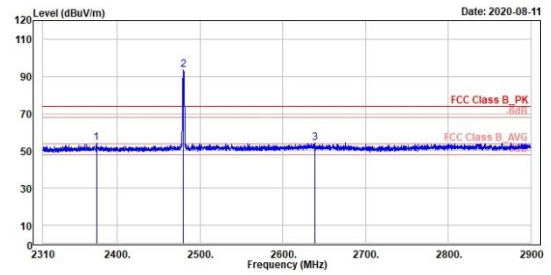
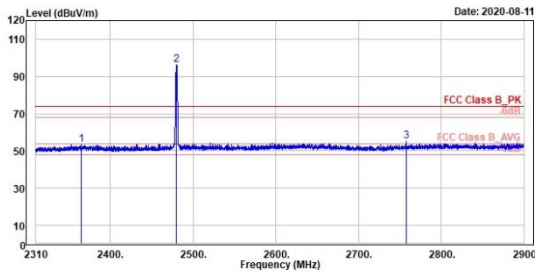

Freq	Level	Read	Level	Factor	Limit	Over	APos	TPos	Remark	Pol/Phase	Note
MHz	dBuV/m	dBuV	dB/m	dBuV/m	dB	cm	cm	deg			
1	2365.22	53.47	16.22	37.25	74.00	-20.53	368	328	Peak	Horizontal	
2 *	2480.00	96.48	58.92	37.56	74.00	22.48	368	328	Peak	Horizontal	
3	2757.81	55.07	17.21	37.86	74.00	-18.93	368	328	Peak	Horizontal	

Freq	Level	Read	Level	Factor	Limit	Over	APos	TPos	Remark	Pol/Phase	Note
MHz	dBuV/m	dBuV	dB/m	dBuV/m	dB	cm	cm	deg			
1	2374.66	54.23	16.95	37.28	74.00	-19.77	400	247	Peak	Vertical	
2 *	2480.00	93.45	55.89	37.56	74.00	19.45	400	247	Peak	Vertical	
3	2639.22	54.26	16.39	37.87	74.00	-19.74	400	247	Peak	Vertical	

8DPSK

High Channel (Horizontal) Average

High Channel (Vertical) Average



TUV Rheinland Taiwan Ltd.  
No. 458-18, Sec. 2, Fenliao, Linkou Dist., New Taipei City 244, Taiwan(R.O.C.)  
Tel: +886-2172-1000 Fax: +886-2172-1322

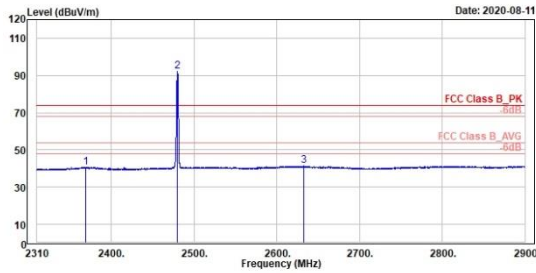

Freq	Level	Read Level	Factor	Limit Line	Over Limit	APos	TPos	Remark	Pol/Phase	Note
MHz	dBuV/m	dBuV	dB/m	dBuV/m	dB	cm	deg			
1	2368.76	40.68	3.41	37.27	54.00	-13.32	368	328 Average	Horizontal	
2 *	2488.00	92.25	54.69	37.56	54.00	38.25	368	328 average	Horizontal	
3	2633.00	41.65	3.75	37.90	54.00	-12.35	368	328 Average	Horizontal	



TUV Rheinland Taiwan Ltd.  
No. 458-18, Sec. 2, Fenliao, Linkou Dist., New Taipei City 244, Taiwan(R.O.C.)  
Tel: +886-2172-1000 Fax: +886-2172-1322

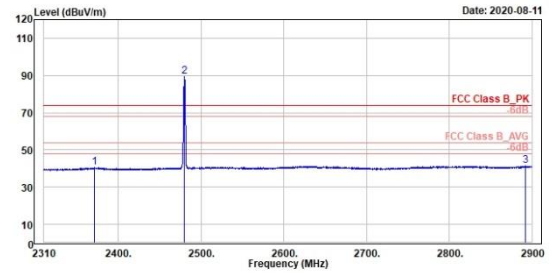

Freq	Level	Read Level	Factor	Limit Line	Over Limit	APos	TPos	Remark	Pol/Phase	Note
MHz	dBuV/m	dBuV	dB/m	dBuV/m	dB	cm	deg			
1	2370.77	40.40	3.13	37.27	54.00	-13.60	400	247 Average	Vertical	
2 *	2488.00	89.20	51.04	37.56	54.00	35.20	400	247 Average	Vertical	
3	2892.33	41.33	3.05	38.28	54.00	-12.67	400	247 Average	Vertical	

Spurious Emissions, Tx Mode, 9kHz ~ 30MHz

8DPSK

High Channel (Open) 9kHz~150kHz

High Channel (Open) 150kHz~30MHz



TÜV Rheinland Taiwan Ltd.  
No. 458-18, Sec 2, Fenliao, Linkou Dist., New Taipei City 244, Taiwan(R.O.C.)  
Tel: +886-2172-1000 Fax: +886-2172-1322

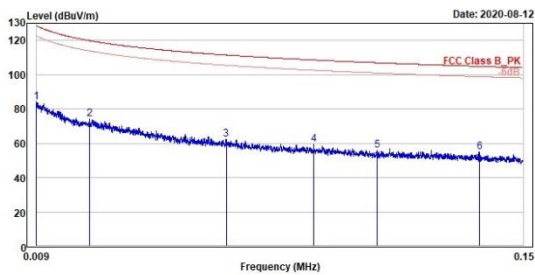

	Freq	Level	Read	Limit	Over	APos	TPos	Remark	Pol/Phase	Note
	MHz	dBuV/m	dBuV	dB/m	dBuV/m	dB	cm	deg		
1	0.01	83.81	3.87	79.94	128.58	-44.69	100	36	QP	Open
2	0.02	73.95	2.18	71.77	119.88	-45.93	100	306	QP	Open
3	0.06	62.49	-0.65	63.14	111.48	-48.99	100	97	QP	Open
4	0.09	59.54	-0.96	60.50	108.58	-49.04	100	358	QP	Open
5	0.11	55.98	-2.91	58.81	106.96	-51.06	100	99	QP	Open
6	0.14	54.81	-2.28	57.09	104.85	-50.04	100	286	QP	Open



TÜV Rheinland Taiwan Ltd.  
No. 458-18, Sec 2, Fenliao, Linkou Dist., New Taipei City 244, Taiwan(R.O.C.)  
Tel: +886-2172-1000 Fax: +886-2172-1322

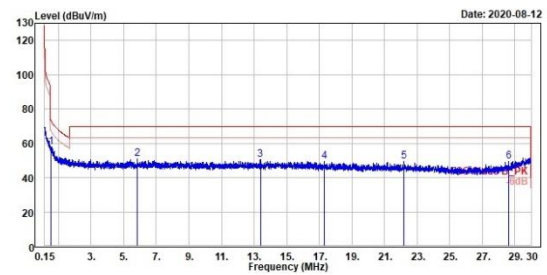

	Freq	Level	Read	Limit	Over	APos	TPos	Remark	Pol/Phase	Note
	MHz	dBuV/m	dBuV	dB/m	dBuV/m	dB	cm	deg		
1	0.56	57.95	12.17	45.78	72.61	-14.66	100	174	QP	Open
2	5.85	50.73	12.38	38.35	69.50	-18.77	100	193	QP	Open
3	13.39	50.51	13.02	37.49	69.50	-18.99	100	129	QP	Open
4	17.30	49.65	12.60	37.05	69.50	-19.85	100	154	QP	Open
5	22.17	49.29	13.47	35.82	69.50	-20.21	100	176	QP	Open
6	28.63	49.48	13.04	36.44	69.50	-20.02	100	168	QP	Open

Spurious Emissions, Tx Mode, 30MHz ~ 1GHz

8DPSK

High Channel (Horizontal)

High Channel (Vertical)



TUV Rheinland Taiwan Ltd.  
No. 458-18, Sec. 2, Fenhiao, Linkou Dist., New Taipei City 244, Taiwan(R.O.C.)  
Tel: +886-2172-1000 Fax: +886-2172-1322

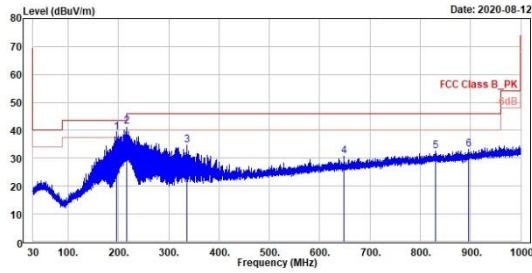

Line	Level	Read Level	Factor	Limit Line	Over Limit	Apos	TPos	Remark	Pol/Phase	Note
MHz	dBuV/m	dBuV	dB/m	dBuV/m	dB	cm	deg			
1	196.00	39.12	49.00	-9.88	43.50	-4.38	200	21 QP	horizontal	
2	216.05	41.32	51.01	-9.69	46.00	-4.68	164	24 QP	horizontal	
3	336.04	34.64	40.36	-5.72	46.00	-11.36	100	54 QP	horizontal	
4	648.08	30.68	31.26	-0.58	46.00	-15.32	300	260 QP	horizontal	
5	830.93	32.70	30.44	2.26	46.00	-13.30	102	360 QP	horizontal	
6	895.63	33.64	29.90	3.14	46.00	-12.96	100	1 QP	horizontal	



TUV Rheinland Taiwan Ltd.  
No. 458-18, Sec. 2, Fenhiao, Linkou Dist., New Taipei City 244, Taiwan(R.O.C.)  
Tel: +886-2172-1000 Fax: +886-2172-1322

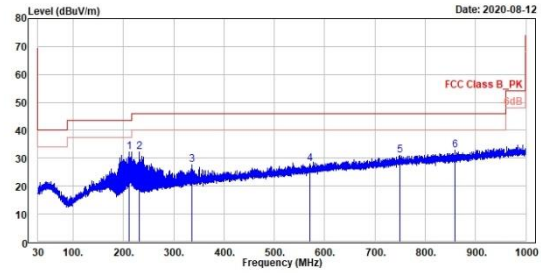

Line	Level	Read Level	Factor	Limit Line	Over Limit	Apos	TPos	Remark	Pol/Phase	Note
MHz	dBuV/m	dBuV	dB/m	dBuV/m	dB	cm	deg			
1	211.97	32.31	42.08	-9.77	43.50	-11.19	200	117 QP	vertical	
2	232.05	32.26	41.00	-8.74	46.00	-13.74	200	95 QP	vertical	
3	336.04	27.66	33.38	-5.72	46.00	-18.34	300	82 QP	vertical	
4	570.29	27.98	29.80	-1.82	46.00	-18.02	100	266 QP	vertical	
5	749.06	31.01	29.92	1.09	46.00	-14.99	300	306 QP	vertical	
6	859.16	32.08	30.30	2.50	46.00	-13.20	400	115 QP	vertical	

## Spurious Emissions, Tx Mode, 1GHz ~ 26.5GHz

### GFSK

#### Low Channel (Horizontal)

#### Low Channel (Vertical)



TÜV Rheinland Taiwan Ltd.  
 No. 458-18, Sec. 2, Fenhiao, Linkou Dist., New Taipei City 244, Taiwan(R.O.C.)  
 Tel: +886-2172-1000 Fax: +886-2172-1322

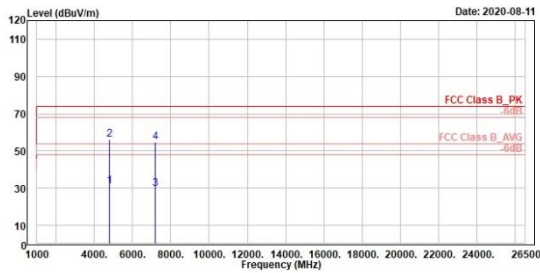

1	2	3	4
4894.00	4984.00	7206.00	7286.00
31.08	55.98	29.88	54.71
41.20	66.10	37.53	62.36
-10.20	-10.20	-7.65	-7.65
54.00	74.00	54.00	74.00
-22.92	-18.10	-24.12	-19.29
114	114	383	383
342	342	90	90
Average	Peak	Average	Peak
horizontal	horizontal	horizontal	horizontal
DF		DF	



TÜV Rheinland Taiwan Ltd.  
 No. 458-18, Sec. 2, Fenhiao, Linkou Dist., New Taipei City 244, Taiwan(R.O.C.)  
 Tel: +886-2172-1000 Fax: +886-2172-1322

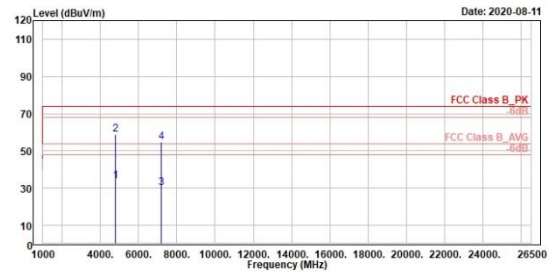

1	2	3	4
4894.00	4984.00	7206.00	7286.00
33.83	58.65	29.91	54.74
44.03	68.85	37.56	62.39
-10.20	-10.20	-7.65	-7.65
54.00	74.00	54.00	74.00
-20.17	-15.35	-24.09	-19.26
316	316	100	100
291	291	360	360
Average	Peak	Average	Peak
vertical	vertical	vertical	vertical
DF		DF	



GFSK

Middle Channel (Horizontal)

Middle Channel (Vertical)



TUV Rheinland Taiwan Ltd.  
No. 458-18, Sec. 2, Fenhiao, Linkou Dist., New Taipei City 244, Taiwan(R.O.C.)  
Tel: +886-2172-1000 Fax: +886-2172-1322

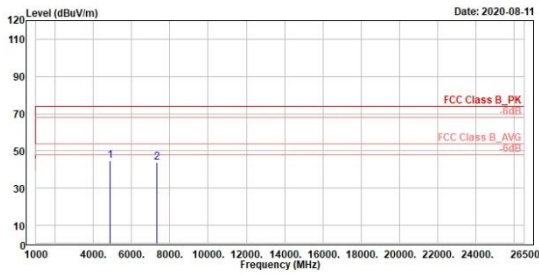

Freq	Level	Read Level	Factor	Limit Line	Over Limit	APos	TPos	Remark	Pol/Phase	Note
MHz	dBuV/m	dBuV	dB/m	dBuV/m	dB	cm	deg			
1	4882.00	44.06	54.92	-10.06	74.00	-29.14	100	3 Peak	horizontal	
2	7323.00	43.86	51.65	-7.79	74.00	-30.14	400	44 Peak	horizontal	



TUV Rheinland Taiwan Ltd.  
No. 458-18, Sec. 2, Fenhiao, Linkou Dist., New Taipei City 244, Taiwan(R.O.C.)  
Tel: +886-2172-1000 Fax: +886-2172-1322

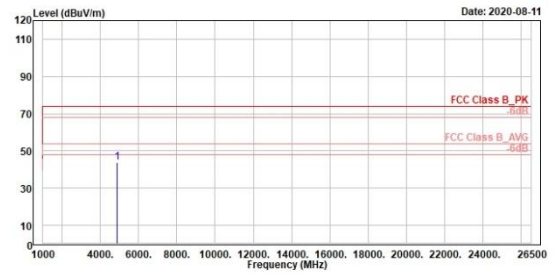

Freq	Level	Read Level	Factor	Limit Line	Over Limit	APos	TPos	Remark	Pol/Phase	Note
MHz	dBuV/m	dBuV	dB/m	dBuV/m	dB	cm	deg			
1	4882.00	44.01	54.07	-10.06	74.00	-29.99	100	150 Peak	vertical	

GFSK

High Channel (Horizontal)

High Channel (Vertical)



TUV Rheinland Taiwan Ltd.  
No. 458-18, Sec. 2, Fenhiao, Linkou Dist., New Taipei City 244, Taiwan(R.O.C.)  
Tel: +886-2172-1000 Fax: +886-2172-1322

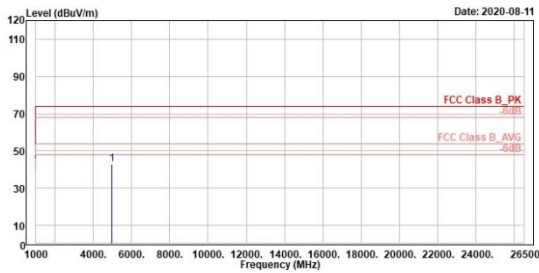

1	4960.00	42.89	52.65	-9.76	74.00	-31.11	300	0	Peak	horizontal
---	---------	-------	-------	-------	-------	--------	-----	---	------	------------



TUV Rheinland Taiwan Ltd.  
No. 458-18, Sec. 2, Fenhiao, Linkou Dist., New Taipei City 244, Taiwan(R.O.C.)  
Tel: +886-2172-1000 Fax: +886-2172-1322

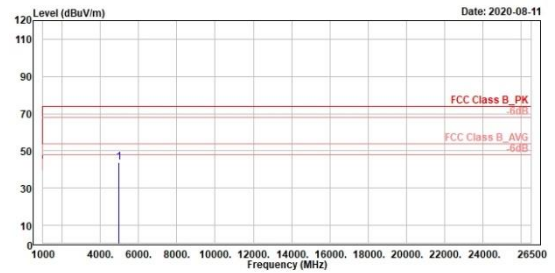

1	4960.00	44.02	53.78	-9.76	74.00	-29.98	400	308	Peak	vertical
---	---------	-------	-------	-------	-------	--------	-----	-----	------	----------

8DPSK

Low Channel (Horizontal)

Low Channel (Vertical)



TUV Rheinland Taiwan Ltd.  
No. 458-18, Sec. 2, Fenhiao, Linkou Dist., New Taipei City 244, Taiwan(R.O.C.)  
Tel: +886-2172-1000 Fax: +886-2172-1322

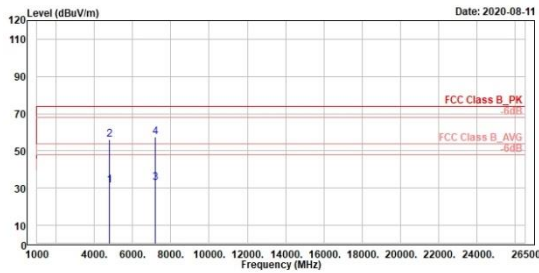

1	2	3	4
Level	Read Level	Factor	Limit
dBuV/m	dBuV	dB/m	dBuV/m
31.35	41.55	-10.20	54.00
56.14	66.34	-10.20	74.00
32.63	40.28	-7.65	54.00
57.42	65.07	-7.65	74.00

Limit	Over Limit	APos	TPos	Remark	Pol/Phase	Note
dB	dB	cm	deg			
-22.65	116	341	Average	horizontal	DF	
-17.86	116	341	Peak	horizontal		
-21.37	330	182	Average	horizontal	DF	
-16.58	330	182	Peak	horizontal		



TUV Rheinland Taiwan Ltd.  
No. 458-18, Sec. 2, Fenhiao, Linkou Dist., New Taipei City 244, Taiwan(R.O.C.)  
Tel: +886-2172-1000 Fax: +886-2172-1322

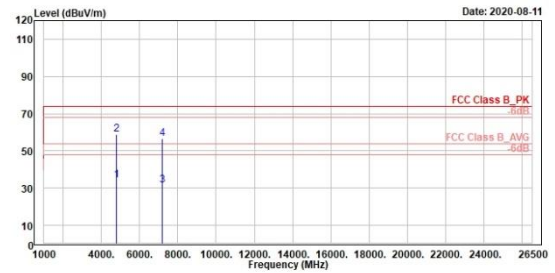

1	2	3	4
Level	Read Level	Factor	Limit
dBuV/m	dBuV	dB/m	dBuV/m
34.10	44.30	-10.20	54.00
58.89	69.09	-10.20	74.00
31.58	39.23	-7.65	54.00
56.37	64.02	-7.65	74.00

Limit	Over Limit	APos	TPos	Remark	Pol/Phase	Note
dB	dB	cm	deg			
-19.90	316	293	Average	vertical	DF	
-15.11	316	293	Peak	vertical		
-22.42	188	59	Average	vertical	DF	
-17.63	188	59	Peak	vertical		

8DPSK

Middle Channel (Horizontal)

Middle Channel (Vertical)



TUV Rheinland Taiwan Ltd.  
No. 458-18, Sec. 2, Fenhiao, Linkou Dist., New Taipei City 244, Taiwan(R.O.C.)  
Tel: +886-2172-1000 Fax: +886-2172-1322

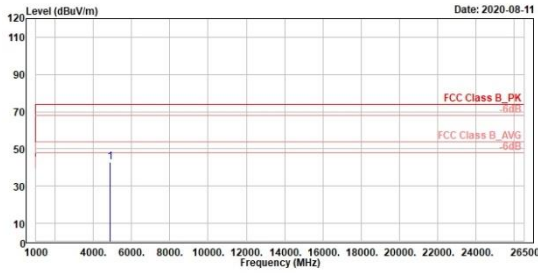

Read	Level	Level Factor	Limit	Over	APos	TPos	Remark	Pol/Phase	Note
MHz	dBuV/m	dBuV	dB/m	dBuV/m	dB	cm	deg		
1	4882.00	43.08	53.14	-10.06	74.00	-30.92	117	0 Peak	horizontal



TUV Rheinland Taiwan Ltd.  
No. 458-18, Sec. 2, Fenhiao, Linkou Dist., New Taipei City 244, Taiwan(R.O.C.)  
Tel: +886-2172-1000 Fax: +886-2172-1322

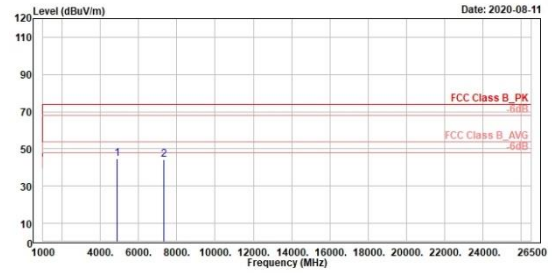

Read	Level	Level Factor	Limit	Over	APos	TPos	Remark	Pol/Phase	Note
MHz	dBuV/m	dBuV	dB/m	dBuV/m	dB	cm	deg		
1	4882.00	44.65	54.71	-10.06	74.00	-29.35	490	328 Peak	vertical
2	7323.00	44.41	52.29	-7.79	74.00	-29.59	100	102 Peak	vertical

8DPSK

High Channel (Horizontal)

High Channel (Vertical)



TUV Rheinland Taiwan Ltd.  
No. 458-18, Sec. 2, Fenhiao, Linkou Dist., New Taipei City 244, Taiwan(R.O.C.)  
Tel: +886-2172-1000 Fax: +886-2172-1322

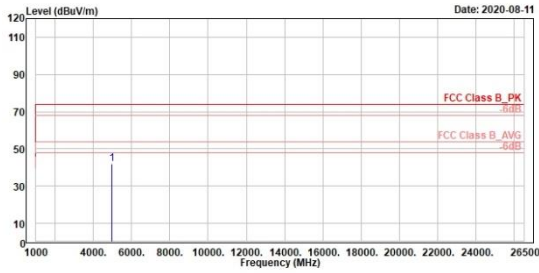

1	4960.00	41.95	51.71	-9.76	74.00	-32.05	103	360	Peak	horizontal
---	---------	-------	-------	-------	-------	--------	-----	-----	------	------------



TUV Rheinland Taiwan Ltd.  
No. 458-18, Sec. 2, Fenhiao, Linkou Dist., New Taipei City 244, Taiwan(R.O.C.)  
Tel: +886-2172-1000 Fax: +886-2172-1322

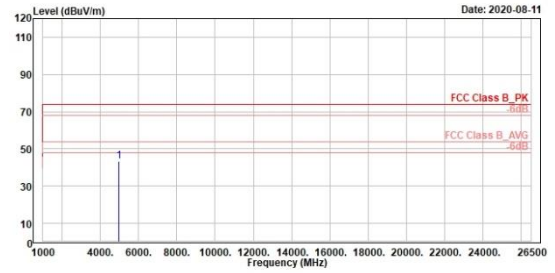

1	4960.00	43.12	52.88	-9.76	74.00	-30.88	300	303	Peak	vertical
---	---------	-------	-------	-------	-------	--------	-----	-----	------	----------

Mains Conducted Emission, 150kHz ~ 30MHz

Worst Band

(Line)

(Neutral)



TUV Rheinland Taiwan Ltd(New Taipei City Branch),  
No. 458-19, Sec. 2, Fenliao Rd., Linkou Dist., New Taipei City 244  
Tel:+886-2172-1000 Fax:+886-2172-1322

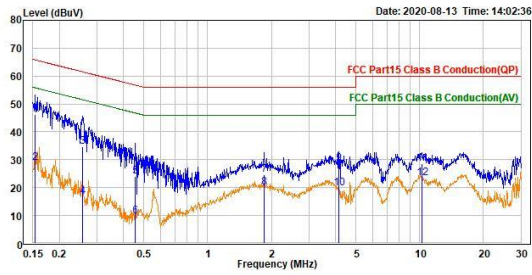

	Read Freq	Level	Factor	Level	Limit Line	Over Limit	Remark	Pol/Phase	Note
	MHz	dBuV	dB	dBuV	dBuV	dB			
1	0.153	36.15	10.11	46.26	65.83	-19.57	QP	line1	
2	0.153	18.75	10.11	28.86	55.83	-26.97	Average	line1	
3	0.258	24.66	10.11	34.77	61.49	-26.72	QP	line1	
4	0.258	6.74	10.11	16.85	51.49	-34.64	Average	line1	
5	0.454	13.95	10.12	24.07	56.81	-32.74	QP	line1	
6	0.454	-0.36	10.12	9.76	46.81	-37.05	Average	line1	
7	1.850	14.61	10.17	24.78	56.00	-31.22	QP	line1	
8	1.850	9.86	10.17	20.03	46.00	-25.97	Average	line1	
9	4.147	18.28	10.21	28.49	56.00	-27.51	QP	line1	
10	4.147	9.44	10.21	19.65	46.00	-26.35	Average	line1	
11	10.222	18.27	10.36	28.63	60.00	-31.37	QP	line1	
12	10.222	12.93	10.36	23.29	50.00	-26.71	Average	line1	



TUV Rheinland Taiwan Ltd(New Taipei City Branch),  
No. 458-19, Sec. 2, Fenliao Rd., Linkou Dist., New Taipei City 244  
Tel:+886-2172-1000 Fax:+886-2172-1322

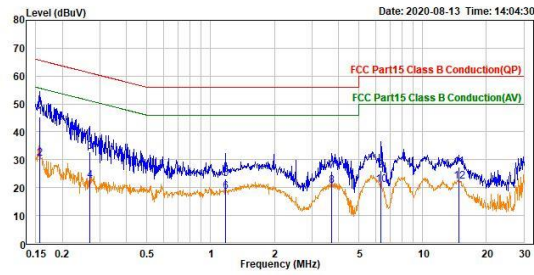

	Read Freq	Level	Factor	Level	Limit Line	Over Limit	Remark	Pol/Phase	Note
	MHz	dBuV	dB	dBuV	dBuV	dB			
1	0.157	35.30	10.11	45.41	65.63	-20.22	QP	neutral	
2	0.157	20.25	10.11	30.36	55.63	-25.27	Average	neutral	
3	0.270	22.87	10.11	32.98	61.11	-28.13	QP	neutral	
4	0.270	12.44	10.11	22.55	51.11	-28.56	Average	neutral	
5	1.175	12.98	10.14	23.12	56.00	-32.88	QP	neutral	
6	1.175	8.27	10.14	18.41	46.00	-27.59	Average	neutral	
7	3.735	15.78	10.20	25.98	56.00	-30.02	QP	neutral	
8	3.735	10.34	10.20	20.54	46.00	-25.46	Average	neutral	
9	6.367	15.83	10.28	26.11	60.00	-33.89	QP	neutral	
10	6.367	10.74	10.28	21.02	50.00	-28.98	Average	neutral	
11	14.782	16.83	10.50	27.33	60.00	-32.67	QP	neutral	
12	14.782	11.82	10.50	22.32	50.00	-27.68	Average	neutral	