



Test Report

FCC ID: 2AKCY-0520000007
IC: 4706A-0520000007

FCC Rule Part: 15.247
ISED Canada Radio Standards Specification: RSS-247

Report Number: AT72153009-3C0

Manufacturer: Eaton Cooper Lighting LLC
Model: 0550-000717

Test Begin Date: September 05, 2019
Test End Date: September 25, 2019

Report Issue Date: November 27, 2019



FOR THE SCOPE OF ACCREDITATION UNDER Certificate Number: 2955.09

This report must not be used by the client to claim product certification, approval, or endorsement by A2LA, NIST, or any agency of the Federal Government.

Prepared By:

Jeremy Pickens
Senior Wireless Engineer
TÜV SÜD America Inc.

Reviewed by:

Ryan McGann
Team Leader
TÜV SÜD America Inc.

This test report shall not be reproduced except in full. This report may be reproduced in part with prior written consent of TÜV SÜD America Inc. The results contained in this report are representative of the sample(s) submitted for evaluation.

This report contains 29 pages

TABLE OF CONTENTS

1	GENERAL	3
1.1	PURPOSE	3
1.2	APPLICANT INFORMATION	3
1.3	PRODUCT DESCRIPTION	3
1.4	TEST METHODOLOGY AND CONSIDERATIONS	4
2	TEST FACILITIES	5
2.1	LOCATION	5
2.2	LABORATORY ACCREDITATIONS/RECOGNITIONS/CERTIFICATIONS	5
2.3	RADIATED EMISSIONS TEST SITE DESCRIPTION	6
2.3.1	<i>Semi-Anechoic Chamber Test Site – Chamber A</i>	6
2.3.2	<i>Semi-Anechoic Chamber Test Site – Chamber B</i>	7
2.4	CONDUCTED EMISSIONS TEST SITE DESCRIPTION	8
2.4.1	<i>Conducted Emissions Test Site</i>	8
3	APPLICABLE STANDARD REFERENCES	9
4	LIST OF TEST EQUIPMENT	9
5	SUPPORT EQUIPMENT.....	10
6	EQUIPMENT UNDER TEST SETUP BLOCK DIAGRAM.....	10
7	SUMMARY OF TESTS.....	11
7.1	ANTENNA REQUIREMENT – FCC 15.203	11
7.2	POWER LINE CONDUCTED EMISSIONS – FCC 15.207, ISED CANADA: RSS-GEN 8.8	11
7.2.1	<i>Measurement Procedure</i>	11
7.2.2	<i>Measurement Results</i>	11
7.3	6dB / 99% BANDWIDTH – FCC 15.247(A)(2), ISED CANADA: RSS-247 5.2(A), RSS-GEN 6.7 ..	13
7.3.1	<i>Measurement Procedure</i>	13
7.3.2	<i>Measurement Results</i>	13
7.4	FUNDAMENTAL EMISSION OUTPUT POWER – FCC 15.247(B)(3), ISED CANADA: RSS-247 5.4(D)	16
7.4.1	<i>Measurement Procedure</i>	16
7.4.2	<i>Measurement Results</i>	16
7.5	EMISSION LEVELS	17
7.5.1	<i>Emissions into Non-restricted Frequency Bands – FCC 15.247(d); ISED Canada: RSS-247 5.5.....</i>	17
7.5.2	<i>Emissions into Restricted Frequency Bands – FCC: 15.205, 15.209; ISED Canada: RSS-Gen 8.9 / 8.10.....</i>	20
7.6	MAXIMUM POWER SPECTRAL DENSITY IN THE FUNDAMENTAL EMISSION – FCC 15.247(E) ISED CANADA: RSS-247 5.2(B).....	22
7.6.1	<i>Measurement Procedure</i>	22
7.6.2	<i>Measurement Results</i>	22
8	ESTIMATION OF MEASUREMENT UNCERTAINTY	24
9	CONCLUSION.....	24
	APPENDIX A: PLOTS	25

1 GENERAL

1.1 Purpose

The purpose of this report is to demonstrate compliance with Part 15 Subpart C of the FCC's Code of Federal Regulations and Innovation, Science and Economic Development Canada's Radio Standards Specification RSS-247 for the tests documented herein for single modular approval.

1.2 Applicant Information

Cooper Lighting LLC
1121 Highway 74 South
Peachtree City, GA 30269 USA

1.3 Product Description

The DUT is a WaveLinx Outdoor / Industrial Dual Chip Sensor that will be used as part of light fixture for occupancy detection, ambient light sensor and controlling light over wireless network. The DUT utilizes Zigbee and Bluetooth LE technologies. The 0550-000717 uses a shared PCB antenna for the BLE and Zigbee functions of a combination chip (Mighty Gecko) and has an additional BLE chip (Blue Gecko) with a second dedicated PCB antenna. The device does not support simultaneous transmissions.

This report documents the Zigbee operation of the Mighty Gecko chipset in sensor module.

Technical Details:

Detail	Description
Frequency Range (MHz)	2405 – 2480
Number of Channels	16
Channel Spacing	5 MHz
Modulation Format	DSSS
Data Rates	250kbps
Operating Voltage	15Vdc
Antenna Type(s) / Gain(s)	Surface Mount Chip / 2.6dBi (Ethertronics, P/N: 1001013)

Test Sample Serial Number(s): Not Labeled

Test Sample Condition: The equipment was provided in good condition without any physical damage.

1.4 Test Methodology and Considerations

All modes of operation, including all data rates, were evaluated and the data presented in this report represents the worst case where applicable.

For radiated emissions, the EUT was evaluated in three orthogonal orientations. The worst-case orientation was the X-orientation.

For antenna port conducted emissions, an MMCX to SMA adapter was used to directly connect the DUT to the measuring equipment through suitable attenuation.

For power line conducted emissions, the EUT was evaluated with a commercially available AC-DC Single output LED driver.

Power setting during test: 15 – Channels 11-25
 0 – Channel 26

2 TEST FACILITIES

2.1 Location

The radiated and conducted emissions test sites are located at the following addresses:

TÜV SÜD America, Inc.
5945 Cabot Pkwy, Suite 100
Alpharetta, GA 30005
Phone: (678) 341-5900

2.2 Laboratory Accreditations/Recognitions/Certifications

TÜV SÜD America, Inc. is accredited to ISO/IEC 17025 by the American Association for Laboratory Accreditation/A2LA accreditation program and has been issued certificate number 2955.09 in recognition of this accreditation.

Unless otherwise specified, all tests methods described within this report are covered under the ISO/IEC 17025 scopes of accreditation.

The Semi-Anechoic Chamber Test Sites and Conducted Emissions Sites have been fully described, submitted to, and accepted by the FCC, ISED Canada and the Japanese Voluntary Control Council for Interference by information technology equipment.

FCC Designation Accreditation Number:	US1233
ISED Canada Lab Code:	23932
VCCI Member Number:	1831
• VCCI Registration Number	A-0295

2.3 Radiated Emissions Test Site Description

2.3.1 Semi-Anechoic Chamber Test Site – Chamber A

The Semi-Anechoic Chamber Test Site consists of a 20' x 30' x 18' shielded enclosure. The chamber is lined with Toyo Ferrite Grid Absorber, model number FFG-1000. The ferrite tile grid is 101 x 101 x 19mm thick and weighs approximately 550 grams. These tiles are mounted on steel panels and installed directly on the inner walls of the chamber.

The turntable is 5' in diameter and is located 5'6" from the back wall of the chamber. The chamber is grounded via 1 - 8' copper ground rod, installed at the center of the back wall, it is bound to the ground plane using 3/4" stainless steel braided cable.

The turntable is all steel, flush mounted EMCO Model 1060 installed in an all steel frame. The table is remotely operated from inside the control room located 25' from the range. The turntable is electrically bonded to the surrounding ground plane via steel fingers installed on the edge of the turn table. The steel fingers make constant contact with the ground plane during operation.

Behind the turntable is a 3' x 6' x 4' deep shielded pit used for support equipment if necessary. The pit is equipped with 1 - 4" PVC chase from the turntable to the pit that allows for cabling to the EUT if necessary. The underside of the turntable can be accessed from the pit so cables can be supplied to the EUT from the pit.

The chamber rear wall is covered with a mixture of Siepel pyramidal absorber. The side walls of the chamber are partially covered with Siepel pyramidal absorber.

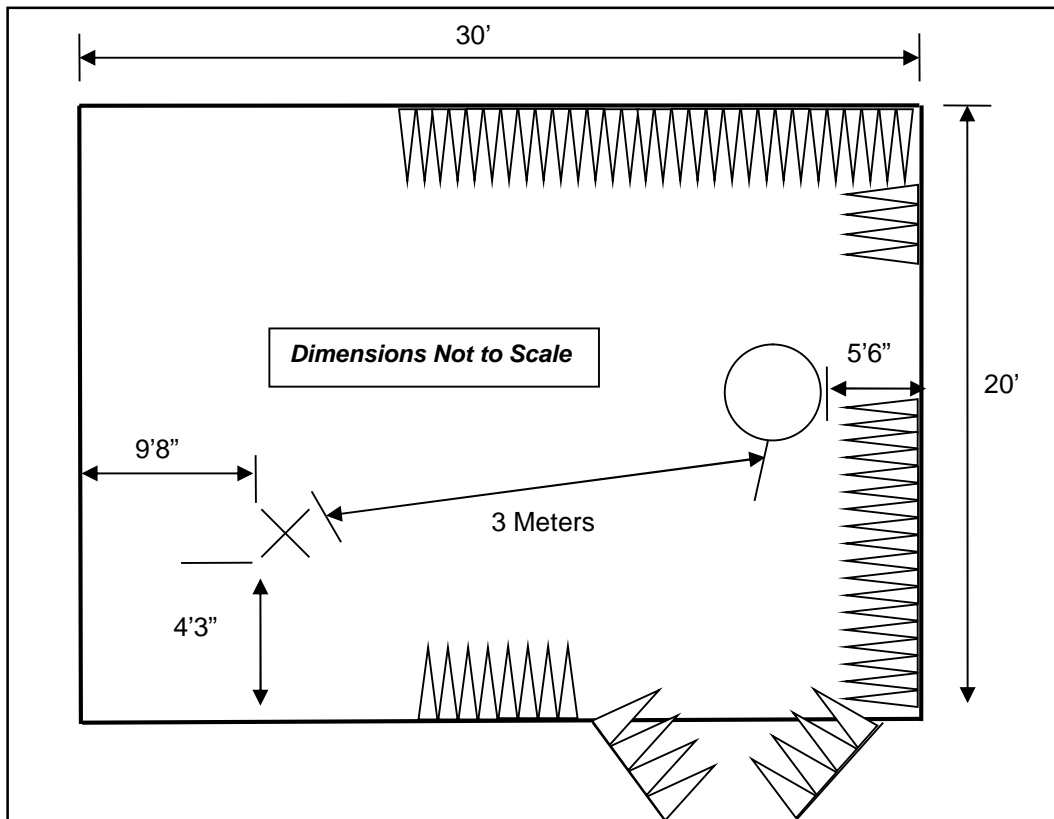

Figure 2.3.1-1: Semi-Anechoic Chamber Test Site – Chamber A

2.3.2 Semi-Anechoic Chamber Test Site – Chamber B

The Semi-Anechoic Chamber Test Site consists of a 20'W x 30'L x 20'H shielded enclosure. The chamber is lined with ETS-Lindgren Ferrite Absorber, model number FT-1500. The ferrite tile 600 mm x 600 mm (2.62 in x 23.62 in) panels and are mounted directly on the inner walls of the chamber shield.

The specular regions of the chamber are lined with additional ETS-Lindgren PS-600 hybrid absorber to extend its frequency range up to 18GHz and beyond.

The turntable is a 2m ETS-Lindgren Model 2170 and installed off the center axis is located 5'6" from the back wall of the chamber. The chamber is grounded via 1 - 8' copper ground rod, installed at the center of the back wall, it is bound to the shield using #8 solid copper wire.

The antenna mast is an EMCO 1060 and is remotely controlled from the control room for both antenna height and polarization.

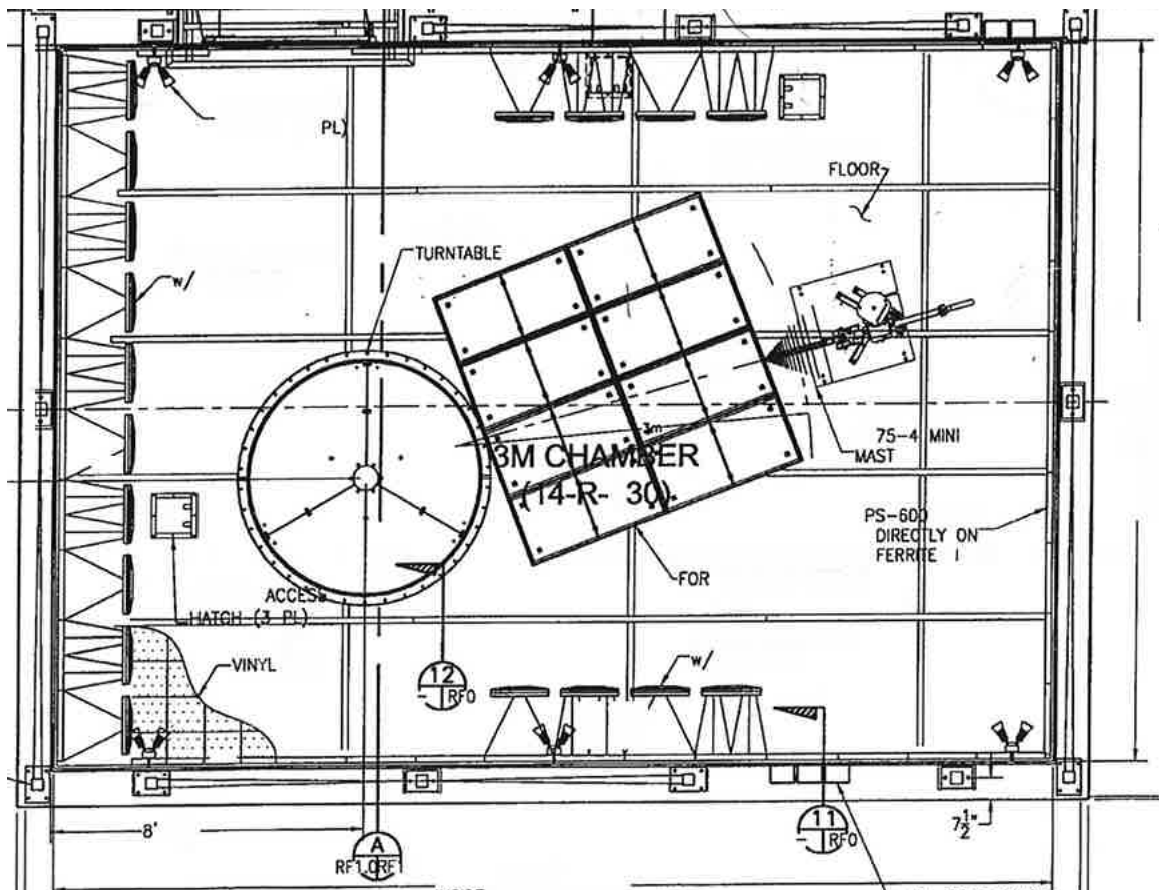

Figure 2.3.2-1: Semi-Anechoic Chamber Test Site – Chamber B

2.4 Conducted Emissions Test Site Description

2.4.1 Conducted Emissions Test Site

The AC mains conducted EMI site is located in the main EMC lab. It consists of a 12' x 10' horizontal coupling plane (HCP) as well as a 12'x8' vertical coupling plane (VCP). The HCP is constructed of 4' x 10' sheets of particle board sandwiched by galvanized steel sheets. These panels are bonded using 11AWG 1/8" x 2" by 10' galvanized sheet steel secured to the panels via by screws. The VCP is constructed of three 4'x8' sheets of 11AWG solid aluminum.

The HCP and VCP are electrically bonded together using 1"x1" angled aluminum secured with screws.

The site is of sufficient size to test tabletop and floor standing equipment in accordance with section 6.1.4 of ANSI C63.10.

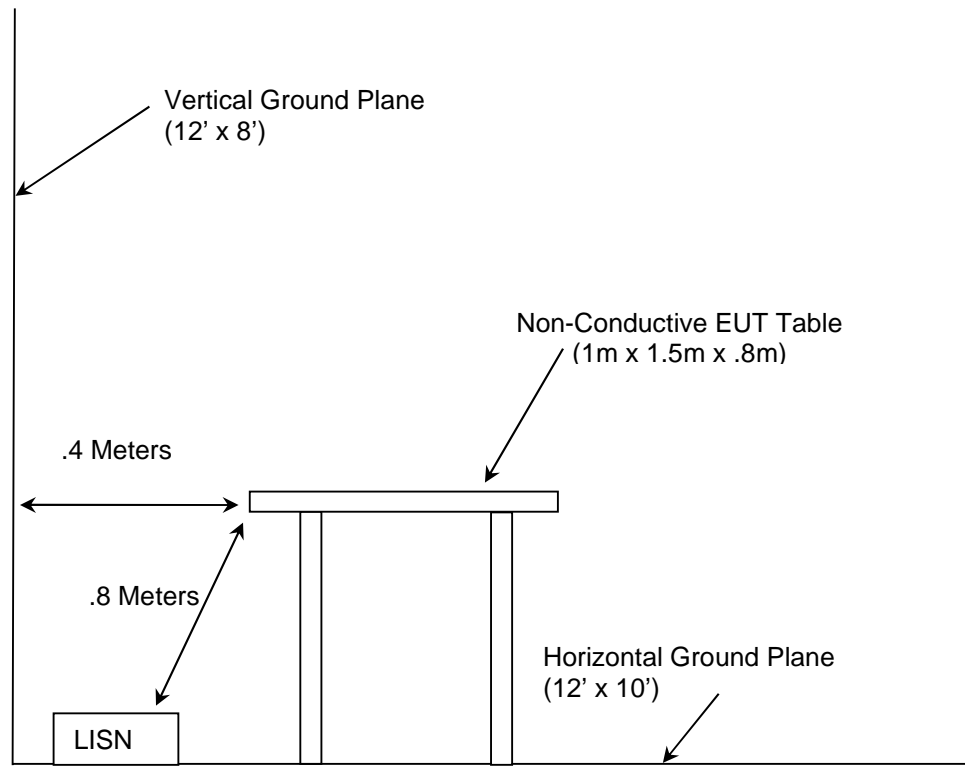

Figure 2.4.1-1: AC Mains Conducted EMI Site

3 APPLICABLE STANDARD REFERENCES

The following standards were used:

- ❖ ANSI C63.10-2013: American National Standard of Procedures for Compliance Testing of Unlicensed Wireless Devices.
- ❖ US Code of Federal Regulations (CFR): Title 47, Part 2, Subpart J: Equipment Authorization Procedures, 2019
- ❖ US Code of Federal Regulations (CFR): Title 47, Part 15, Subpart C: Radio Frequency Devices, Intentional Radiators, 2019
- ❖ FCC KDB 558074 D01 DTS Meas Guidance v05r02 - Guidance for Performing Compliance Measurements on Digital Transmission Systems (DTS) Operating Under §15.247, April 2, 2019
- ❖ ISED Canada Radio Standards Specification: RSS-247 – Digital Transmission Systems (DTSs), Frequency Hopping Systems (FHSs) and Licence-Exempt Local Area Network (LE-LAN) Devices, Issue 2, February 2017.
- ❖ ISED Canada Radio Standards Specification: RSS-GEN – General Requirements for Compliance of Radio Apparatus, Issue 5, April 2018 + Amendment 1, March 2019

4 LIST OF TEST EQUIPMENT

The calibration interval of test equipment is annually or the manufacturer's recommendations. Where the calibration interval deviates from the annual cycle based on the instrument manufacturer's recommendations, it shall be stated below.

Table 4-1: Test Equipment

Asset ID	Manufacturer	Model	Equipment Type	Serial Number	Last Calibration Date	Calibration Due Date
213	TEC	PA 102	Amplifier	44927	07/22/2019	07/22/2020
324	ACS	Belden	Conducted EMI Cable	8214	03/19/2019	03/19/2020
329	A.H.Systems	SAS-571	Horn Antenna	721	08/27/2019	08/27/2021
335	Suhner	SF-102A	Cable (40GHZ)	882/2A	07/08/2019	07/08/2020
338	Hewlett Packard	8449B	High Frequency Pre-Amp	3008A01111	07/15/2019	07/15/2021
345	Suhner Sucoflex	102A	Cable 42(GHZ)	1077/2A	07/09/2019	07/09/2020
432	Microwave Circuits	H3G020G4	Highpass Filter	264066	05/31/2019	05/31/2020
622	Rohde & Schwarz	FSV40 (v3.40)	FSV Signal Analyzer 10Hz to 40GHz	101338	07/30/2018	07/30/2020
628	EMCO	6502	Active Loop Antenna 10kHz-30MHz	9407-2877	02/11/2019	11/02/2021
638	Rohde & Schwarz	OSP 120	Open Switch and Control Unit	101229	06/11/2019	06/11/2021
651	Rohde & Schwarz	TS-PR26	18GHz to 26.5GHz Pre-Amplifier	100023	07/10/2019	07/10/2020
652	Rohde & Schwarz	3160-09	High Frequency Antenna 18GHz to 26.5GHz	060922-21894	NCR	NCR
813	PMM	9010	EMI Receiver; RF Input 50ohm; 10Hz-50MHz;	697WW30606	02/25/2019	02/25/2020
819	Rohde & Schwarz	ESR26	EMI Test Receiver	101345	11/6/2018	11/6/2019
827	(-)	TS8997 Rack Cable Set	TS8997 Rack Cable Set	N/A	05/01/2019	05/01/2020
836	ETS Lindgren	SAC Cable Set	SAC Cable Set includes 620, 837, 838	N/A	05/01/2019	05/01/2020
853	Teseq	CBL 6112D; 6804.17.A	Bilog Antenna; Attenuator	51616; 20181110A	10/15/2018	10/15/2020
3010	Rohde & Schwarz	ENV216	Two-Line V-Network	3010	07/10/2019	07/10/2020

NCR = No Calibration Required

NOTE: All test equipment was used only during active calibration cycles as reported above.

5 SUPPORT EQUIPMENT

Table 5-1: Support Equipment

Item	Equipment Type	Manufacturer	Model Number	Serial Number
1	Sensor	Eaton Cooper Lighting	0550-000717	Not Labeled
2	DALI Control Module	Unknown	MSP8VMV	Not Labeled

Table 5-2: Cable Description

Item	Cable Type	Length	Shield	Termination
A	DC Power Cable	0.5 m	No	1 – 2
B	AC Power	2.0 m	No	2 – AC Mains

6 EQUIPMENT UNDER TEST SETUP BLOCK DIAGRAM

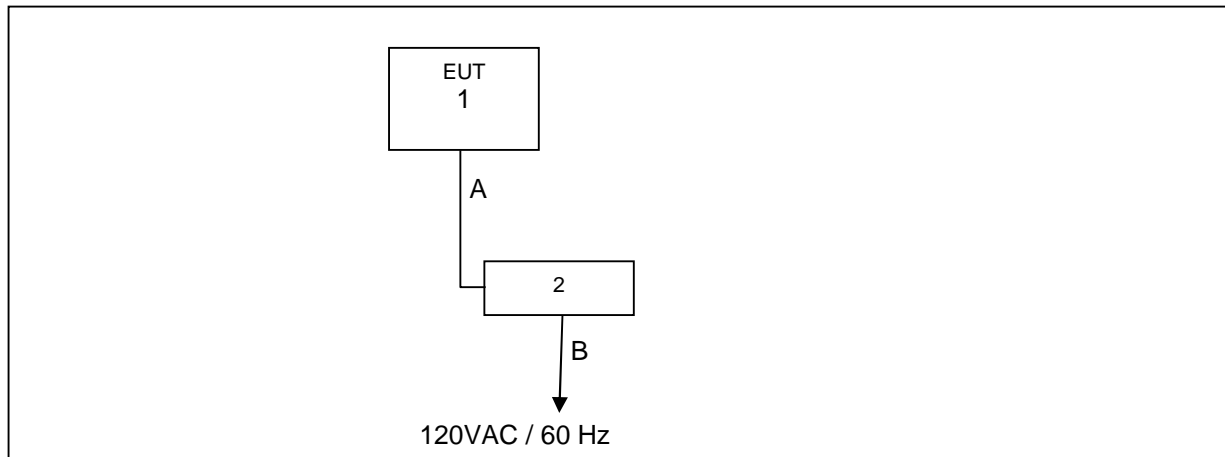

Figure 6-1: Test Setup Block Diagram

7 SUMMARY OF TESTS

Along with the tabular data shown below, plots were taken of all signals deemed important enough to document.

7.1 Antenna Requirement – FCC 15.203

The EUT utilizes a Surface Mount Chip antenna. The antenna is integral to the device and cannot be removed or replaced by the end user. The gain of the antenna is 2.6dBi.

7.2 Power Line Conducted Emissions – FCC 15.207, ISED Canada: RSS-Gen 8.8

7.2.1 Measurement Procedure

Conducted emissions were performed from 150kHz to 30MHz with the spectrum analyzer's resolution bandwidth set to 9kHz and the video bandwidth set to 30kHz. The calculation for the conducted emissions is as follows:

Corrected Reading = Analyzer Reading + LISN Loss + Cable Loss

Margin = Corrected Reading – Applicable Limit

7.2.2 Measurement Results

Performed by: Sean Vick

Table 7.2.2-1: Conducted EMI Results – 120VAC/60Hz – Line 1

Frequency (MHz)	Corrected Reading		Limit		Margin		Correction (dB)
	Quasi-Peak	Average	Quasi-Peak	Average	Quasi-Peak	Average	
	(dB μ V)	(dB μ V)	(dB μ V)	(dB μ V)	(dB)	(dB)	
0.306	38.93	23.13	60.08	50.08	-21.15	-26.95	9.5
0.326	39.13	32.42	59.55	49.55	-20.42	-17.13	9.5
0.578	31.25	15.93	56	46	-24.75	-30.07	9.55
0.59	34.67	20.81	56	46	-21.33	-25.19	9.55
0.614	32.94	16.04	56	46	-23.06	-29.96	9.55
0.63	31.21	16.11	56	46	-24.79	-29.89	9.56
0.87	30.54	15.2	56	46	-25.46	-30.8	9.6
0.886	31.17	16.67	56	46	-24.83	-29.33	9.6
3.49	31.42	13.93	56	46	-24.58	-32.07	9.77
28.898	37.36	35.62	60	50	-22.64	-14.38	9.86

Table 7.2.2-2: Conducted EMI Results – 120VAC/60Hz – Line 2

Frequency (MHz)	Corrected Reading		Limit		Margin		Correction (dB)
	Quasi-Peak	Average	Quasi-Peak	Average	Quasi-Peak	Average	
	(dB μ V)	(dB μ V)	(dB μ V)	(dB μ V)	(dB)	(dB)	
0.15	24.92	13.12	66	56	-41.08	-42.88	9.43
0.294	34.33	24.12	60.41	50.41	-26.08	-26.29	9.45
0.318	34.52	28.89	59.76	49.76	-25.24	-20.87	9.45
0.578	30.95	15.4	56	46	-25.05	-30.6	9.5
0.602	31.22	15.66	56	46	-24.78	-30.34	9.5
0.618	30.96	15.28	56	46	-25.04	-30.72	9.5
0.63	29.06	15.69	56	46	-26.94	-30.31	9.51
0.882	31.15	17.24	56	46	-24.85	-28.76	9.56
0.898	28.82	16.77	56	46	-27.18	-29.23	9.56
28.898	37.26	33.34	60	50	-22.74	-16.66	9.92

7.3 6dB / 99% Bandwidth – FCC 15.247(a)(2), ISED Canada: RSS-247 5.2(a), RSS-GEN 6.7**7.3.1 Measurement Procedure**

The 6dB bandwidth was measured in accordance with the FCC KDB 558074 D01 Section 8.2 which references Subclause 11.8 of ANSI C63.10. The Resolution Bandwidth (RBW) of the spectrum analyzer was set to 100 kHz. The Video Bandwidth (VBW) was set to ≥ 3 times the RBW. The trace was set to max hold with a peak detector active. The marker-delta function of the spectrum analyzer was utilized to determine the 6 dB bandwidth of the emission.

The occupied bandwidth measurement function of the spectrum analyzer was used to measure the 99% bandwidth. The span of the analyzer was set to capture all products of the modulation process, including the emission sidebands. The resolution bandwidth was set from 1% to 5% of the occupied bandwidth and the video bandwidth set to at least 3 times the resolution bandwidth. A peak detector was used.

7.3.2 Measurement Results

Performed by: Jeremy Pickens

Table 7.3.2-1: 6dB / 99% Bandwidth

Modulation	Frequency [MHz]	6dB Bandwidth [MHz]	99% Bandwidth [MHz]
GFSK	2405	1.782	2.237
	2440	1.782	2.237
	2480	1.782	2.252

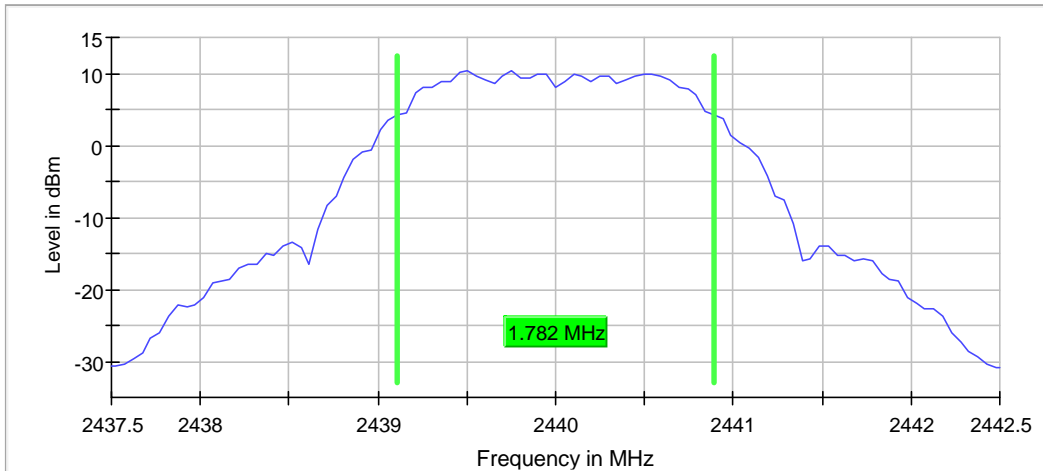

Figure 7.3.2-1: Sample Plot - 6dB BW

Table 7.3.2-2: Sample Measurement Settings (6dB BW)

Setting	Instrument Value	Target Value
Start Frequency	2.43750 GHz	2.43750 GHz
Stop Frequency	2.44250 GHz	2.44250 GHz
Span	5.000 MHz	5.000 MHz
RBW	100.000 kHz	~ 100.000 kHz
VBW	300.000 kHz	~ 300.000 kHz
SweepPoints	101	~ 100
Sweeptime	18.938 μ s	AUTO
Reference Level	10.000 dBm	10.000 dBm
Attenuation	30.000 dB	AUTO
Detector	MaxPeak	MaxPeak
SweepCount	100	100
Filter	3 dB	3 dB
Trace Mode	Max Hold	Max Hold
Sweepstype	FFT	AUTO
Preamp	off	off
Stablemode	Trace	Trace
Stablevalue	0.50 dB	0.50 dB
Run	11 / max. 150	max. 150
Stable	5 / 5	5
Max Stable Difference	0.39 dB	0.50 dB

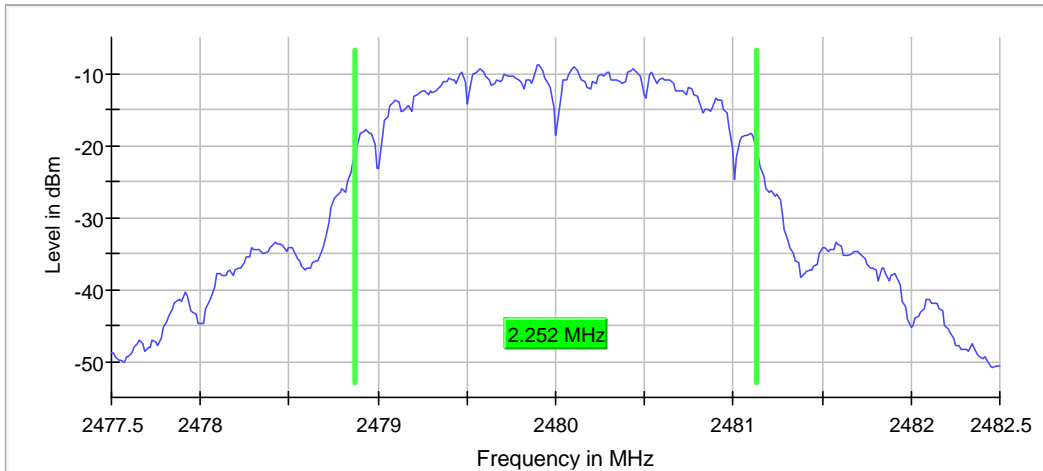

Figure 7.3.2-2: Sample Plot - 99% OBW

Table 7.3.2-3: Sample Measurement Settings (OBW)

Setting	Instrument Value	Target Value
Start Frequency	2.47750 GHz	2.47750 GHz
Stop Frequency	2.48250 GHz	2.48250 GHz
Span	5.000 MHz	5.000 MHz
RBW	30.000 kHz	>= 25.000 kHz
VBW	100.000 kHz	>= 90.000 kHz
SweepPoints	333	~ 333
Sweptime	63.218 μ s	AUTO
Reference Level	-10.000 dBm	-10.000 dBm
Attenuation	10.000 dB	AUTO
Detector	MaxPeak	MaxPeak
SweepCount	100	100
Filter	3 dB	3 dB
Trace Mode	Max Hold	Max Hold
Sweeptype	FFT	AUTO
Preamp	off	off
Stablemode	Trace	Trace
Stablevalue	0.30 dB	0.30 dB
Run	22 / max. 150	max. 150
Stable	3 / 3	3
Max Stable Difference	0.21 dB	0.30 dB

7.4 Fundamental Emission Output Power – FCC 15.247(b)(3), ISED Canada: RSS-247 5.4(d)

7.4.1 Measurement Procedure

The maximum conducted output power was measured in accordance with FCC KDB 558074 D01 utilizing the RBW ≥ DTS Bandwidth method. The RF output of the equipment under test was directly connected to the input of the analyzer applying suitable attenuation. Worst-case power across all data rates is reported.

7.4.2 Measurement Results

Performed by: Jeremy Pickens

Table 7.4.2-1: Conducted Output Power

Modulation	Frequency [MHz]	Peak Power [dBm]
GFSK	2405	14.7
	2440	14.5
	2475	14.5
	2480	-0.6

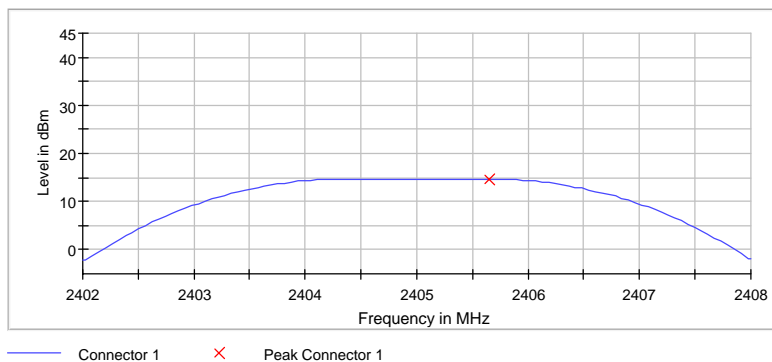

Figure 7.4.2-1: Sample Plot

Table 7.4.2-2: Sample Measurement Settings

Setting	Instrument Value	Target Value
Start Frequency	2.40200 GHz	2.40200 GHz
Stop Frequency	2.40800 GHz	2.40800 GHz
Span	6.000 MHz	6.000 MHz
RBW	2.000 MHz	≥ 1.782 MHz
VBW	10.000 MHz	≥ 6.000 MHz
SweepPoints	101	~ 101
Sweeptime	953.450 ns	AUTO
Reference Level	20.000 dBm	20.000 dBm
Attenuation	40.000 dB	AUTO
Detector	MaxPeak	MaxPeak
SweepCount	100	100
Filter	3 dB	3 dB
Trace Mode	Max Hold	Max Hold
SweepType	FFT	AUTO
Preamp	off	off
Stablemode	Trace	Trace
Stablevalue	0.50 dB	0.50 dB
Run	4 / max. 150	max. 150
Stable	3 / 3	3
Max Stable Difference	0.01 dB	0.50 dB

7.5 Emission Levels

7.5.1 Emissions into Non-restricted Frequency Bands – FCC 15.247(d); ISED Canada: RSS-247 5.5

7.5.1.1 Measurement Procedure

The unwanted emissions into non-restricted bands were measured conducted in accordance with FCC KDB 558074 D01 Section 8.5. The RF output of the equipment under test was directly connected to the input of the spectrum analyzer applying suitable attenuation. The Resolution Bandwidth (RBW) of the spectrum analyzer was set to 100 kHz. The Video Bandwidth (VBW) was set to ≥ 300 kHz. The resulting spectrum analyzer peak level was used to determine the reference level with respect to the 20 dBc limit at the band edges. The spectrum span was then adjusted for the measurement of spurious emissions from 30MHz to 25GHz, 10 times the highest fundamental frequency. The worst-case for each modulation was investigated at the lower and upper band edges.

7.5.1.2 Measurement Results

Performed by: Jeremy Pickens

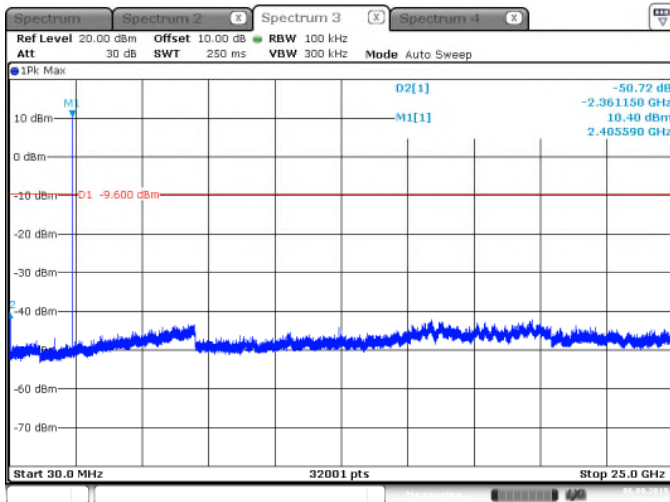

Date: 6 SEP 2019 15:38:45

Figure 7.5.1.2-1: LCH – 30MHz–25GHz

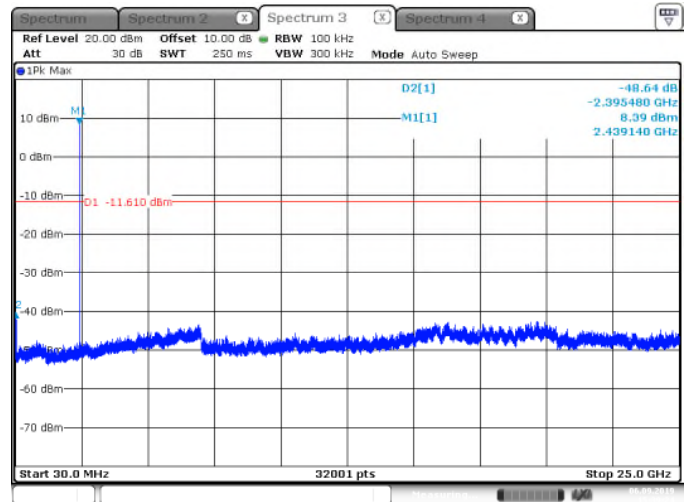

Date: 6 SEP 2019 15:38:25

Figure 7.5.1.2-2: MCH – 30MHz–25GHz

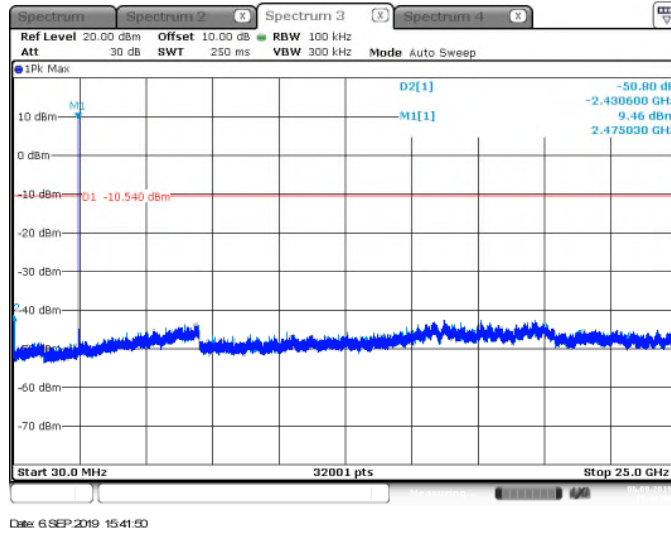

Figure 7.5.1.2-3: HCH – 30MHz–25GHz

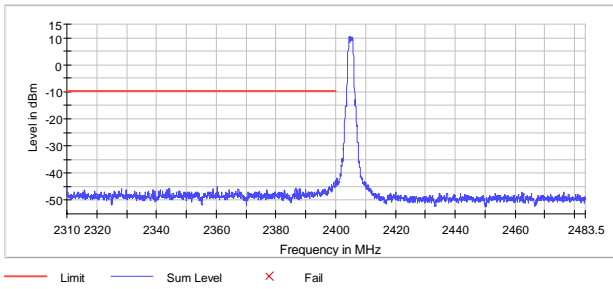

Figure 7.5.1.2-4: Lower Band-edge

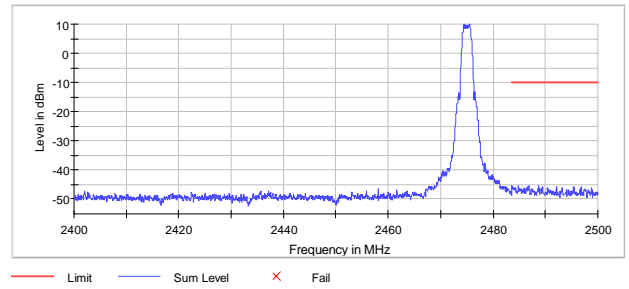

Figure 7.5.1.2-5: Upper Band-edge – Channel 25

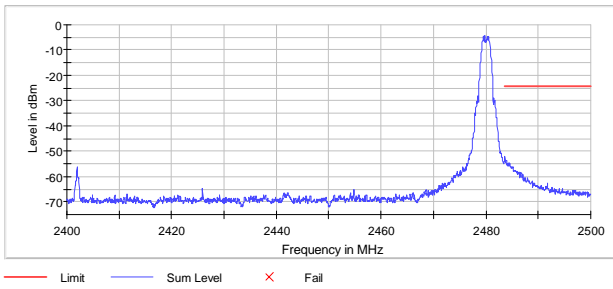

Figure 7.5.1.2-6: Upper Band-edge – Channel 26

Frequency (MHz)	Level (dBm)	Margin (dB)	Limit (dBm)	Result
2399.825000	-42.5	32.8	-9.7	PASS
2399.875000	-42.8	33.2	-9.7	PASS
2399.975000	-43.1	33.4	-9.7	PASS
2399.925000	-43.2	33.5	-9.7	PASS
2399.775000	-43.2	33.6	-9.7	PASS
2399.725000	-43.3	33.6	-9.7	PASS
2399.225000	-43.4	33.7	-9.7	PASS
2399.275000	-43.7	34.0	-9.7	PASS
2399.675000	-43.9	34.2	-9.7	PASS
2399.325000	-44.0	34.3	-9.7	PASS
2399.175000	-44.0	34.4	-9.7	PASS
2399.375000	-44.2	34.5	-9.7	PASS
2398.475000	-44.4	34.8	-9.7	PASS
2398.525000	-44.5	34.8	-9.7	PASS
2399.425000	-44.6	34.9	-9.7	PASS

Table 7.5.1.2-1: Lower Band-edge- Low Channel

Frequency (MHz)	Level (dBm)	Margin (dB)	Limit (dBm)	Result
2488.725000	-45.3	35.3	-10.1	PASS
2484.875000	-45.4	35.3	-10.1	PASS
2488.775000	-45.5	35.4	-10.1	PASS
2484.825000	-45.5	35.4	-10.1	PASS
2486.775000	-45.5	35.5	-10.1	PASS
2483.575000	-45.6	35.5	-10.1	PASS
2483.775000	-45.6	35.5	-10.1	PASS
2486.825000	-45.6	35.6	-10.1	PASS
2483.825000	-45.7	35.6	-10.1	PASS
2483.625000	-45.8	35.7	-10.1	PASS
2489.475000	-45.8	35.7	-10.1	PASS
2496.825000	-45.8	35.8	-10.1	PASS
2492.125000	-45.9	35.8	-10.1	PASS
2486.575000	-45.9	35.9	-10.1	PASS
2495.375000	-45.9	35.9	-10.1	PASS

Table 7.5.1.2-2: Upper Band-edge – High Channel 25

Table 7.5.1.2-3: Upper Band-edge – High Channel 26

Frequency (MHz)	Level (dBm)	Margin (dB)	Limit (dBm)	Result
2483.625000	-52.1	27.7	-24.4	PASS
2483.675000	-52.2	27.8	-24.4	PASS
2483.575000	-52.6	28.2	-24.4	PASS
2483.525000	-53.6	29.2	-24.4	PASS
2483.925000	-53.7	29.3	-24.4	PASS
2483.875000	-53.8	29.4	-24.4	PASS
2483.725000	-54.1	29.7	-24.4	PASS
2483.775000	-54.1	29.7	-24.4	PASS
2483.825000	-54.4	30.0	-24.4	PASS
2484.475000	-54.7	30.3	-24.4	PASS
2484.525000	-54.8	30.4	-24.4	PASS
2483.975000	-54.9	30.5	-24.4	PASS
2484.075000	-55.0	30.6	-24.4	PASS
2484.325000	-55.0	30.6	-24.4	PASS
2484.275000	-55.2	30.7	-24.4	PASS

7.5.2 Emissions into Restricted Frequency Bands – FCC: 15.205, 15.209; ISED Canada: RSS-Gen 8.9 / 8.10

7.5.2.1 Measurement Procedure

The unwanted emissions into restricted bands were measured radiated over the frequency range of 30MHz to 25GHz, 10 times the highest fundamental frequency.

The EUT was rotated through 360° and the receive antenna height was varied from 1 meter to 4 meters so that the maximum radiated emissions level would be detected. For frequencies below 1000 MHz, quasi-peak measurements were made using a resolution bandwidth RBW of 120 kHz and a video bandwidth VBW of 300 kHz. For frequencies above 1000 MHz, peak and average measurements were made with RBW and VBW of 1 MHz and 3 MHz respectively.

Each emission found to be in a restricted band as defined by section 15.205, including any emission at the operational band-edge, was compared to the radiated emission limits as defined in section 15.209.

7.5.2.2 Measurement Results

Performed by: Jeremy Pickens

Table 7.5.2.2-1: Radiated Spurious Emissions Tabulated Data

Frequency (MHz)	Level (dBuV)		Antenna Polarity (H/V)	Correction Factors (dB)	Corrected Level (dBuV/m)		Limit (dBuV/m)		Margin (dB)	
	pk	Qpk/Avg			pk	Qpk/Avg	pk	Qpk/Avg	pk	Qpk/Avg
Channel 11 (2405MHz)										
2390	44.80	31.10	H	0.61	45.41	31.71	74.0	54.0	28.6	22.3
2390	45.30	32.00	V	0.61	45.91	32.61	74.0	54.0	28.1	21.4
4810	45.70	34.30	H	8.87	54.57	43.17	74.0	54.0	19.4	10.8
4810	45.60	33.90	V	8.87	54.47	42.77	74.0	54.0	19.5	11.2
Channel 18 (2440MHz)										
4880	43.60	32.60	H	9.19	52.79	41.79	74.0	54.0	21.2	12.2
4880	44	33.2	V	9.19	53.19	42.39	74.0	54.0	20.8	11.6
7320	44.10	30.80	H	13.62	57.72	44.42	74.0	54.0	16.3	9.6
7320	43.60	30.80	V	13.62	57.22	44.42	74.0	54.0	16.8	9.6
Channel 25 (2475MHz)										
2483.5	47.6	34.6	H	0.92	48.52	35.52	74.0	54.0	25.5	18.5
2483.5	50.3	37	V	0.92	51.22	37.92	74.0	54.0	22.8	16.1
4950	43.7	31.6	H	9.50	53.20	41.10	74.0	54.0	20.8	12.9
4950	43.8	31.1	V	9.50	53.30	40.60	74.0	54.0	20.7	13.4
Channel 26 (2480MHz)										
2483.5	46.7	33.4	H	0.92	47.62	34.32	74.0	54.0	26.4	19.7
2483.5	48.1	35.1	V	0.92	49.02	36.02	74.0	54.0	25.0	18.0

7.5.2.3 Sample Calculation:

$$R_C = R_U + CF_T$$

Where:

CF_T = Total Correction Factor (AF+CA+AG)-DC (Average Measurements Only)

R_U = Uncorrected Reading

R_C = Corrected Level

AF = Antenna Factor

CA = Cable Attenuation

AG = Amplifier Gain

DC = Duty Cycle Correction Factor

Example Calculation: Peak

Corrected Level: $44.1 + 13.62 = 57.72\text{dBuV/m}$

Margin: $74\text{dBuV/m} - 57.72\text{dBuV/m} = 16.3\text{dB}$

Example Calculation: Average

Corrected Level: $30.8 + 13.62 - 0 = 44.42\text{dBuV}$

Margin: $54\text{dBuV} - 44.42\text{dBuV} = 9.6\text{dB}$

**7.6 Maximum Power Spectral Density in the Fundamental Emission – FCC 15.247(e)
ISED Canada: RSS-247 5.2(b)****7.6.1 Measurement Procedure**

The power spectral density was measured in accordance with the FCC KDB 558074 D01 utilizing Section 8.4. The RF output of the equipment under test was directly connected to the input of the spectrum analyzer applying suitable attenuation. The Resolution Bandwidth (RBW) of the spectrum analyzer was set to 10 kHz. The Video Bandwidth (VBW) was set to 30 kHz. Span was set to 1.5 times the channel bandwidth. The trace was set to max hold with the peak detector active.

7.6.2 Measurement Results

Performed by: Jeremy Pickens

Table 7.6.2-1: Power Spectral Density

Modulation	Frequency [MHz]	PSD [dBm]
GFSK	2405	3.731
	2440	3.537
	2475	3.493
	2480	-1.688

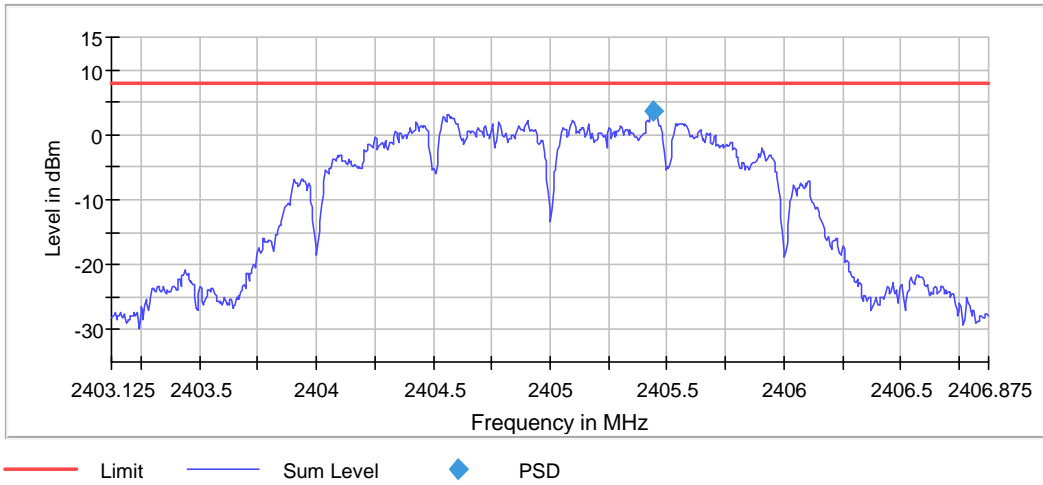

Figure 7.6.2-1: Sample PSD Plot

Table 7.6.2-2: Sample Measurement Settings (PSD)

Setting	Instrument Value	Target Value
Start Frequency	2.40313 GHz	2.40313 GHz
Stop Frequency	2.40688 GHz	2.40688 GHz
Span	3.750 MHz	3.750 MHz
RBW	10.000 kHz	<= 10.000 kHz
VBW	30.000 kHz	>= 30.000 kHz
SweepPoints	750	~ 750
SweepTime	3.750 ms	AUTO
Reference Level	10.000 dBm	10.000 dBm
Attenuation	30.000 dB	AUTO
Detector	MaxPeak	MaxPeak
SweepCount	100	100
Filter	3 dB	3 dB
Trace Mode	Max Hold	Max Hold
SweepType	Sweep	Sweep
Preamp	off	off
Stablemode	Trace	Trace
Stablevalue	0.50 dB	0.50 dB
Run	10 / max. 150	max. 150
Stable	2 / 2	2
Max Stable Difference	0.31 dB	0.50 dB

8 ESTIMATION OF MEASUREMENT UNCERTAINTY

The expanded laboratory measurement uncertainty figures (U_{Lab}) provided below correspond to an expansion factor (coverage factor) $k = 1.96$ which provide confidence levels of 95%.

Table 8-1: Estimation of Measurement Uncertainty

Parameter	U_{lab}
Occupied Channel Bandwidth	$\pm 0.009 \%$
RF Conducted Output Power	$\pm 0.349 \text{ dB}$
Power Spectral Density	$\pm 0.372 \text{ dB}$
Antenna Port Conducted Emissions	$\pm 1.264 \text{ dB}$
Radiated Emissions $\leq 1 \text{ GHz}$	$\pm 5.814 \text{ dB}$
Radiated Emissions $> 1 \text{ GHz}$	$\pm 4.318 \text{ dB}$
Temperature	$\pm 0.860 \text{ }^\circ\text{C}$
Radio Frequency	$\pm 2.832 \times 10^{-8}$
AC Power Line Conducted Emissions	$\pm 3.360 \text{ dB}$

9 CONCLUSION

In the opinion of TUV SUD the 0550-000717, manufactured by Eaton Cooper Lighting LLC meets the requirements of FCC Part 15 subpart C and ISED Canada's Radio Standards Specification RSS-247 for the tests documented herein.

Appendix A: Plots

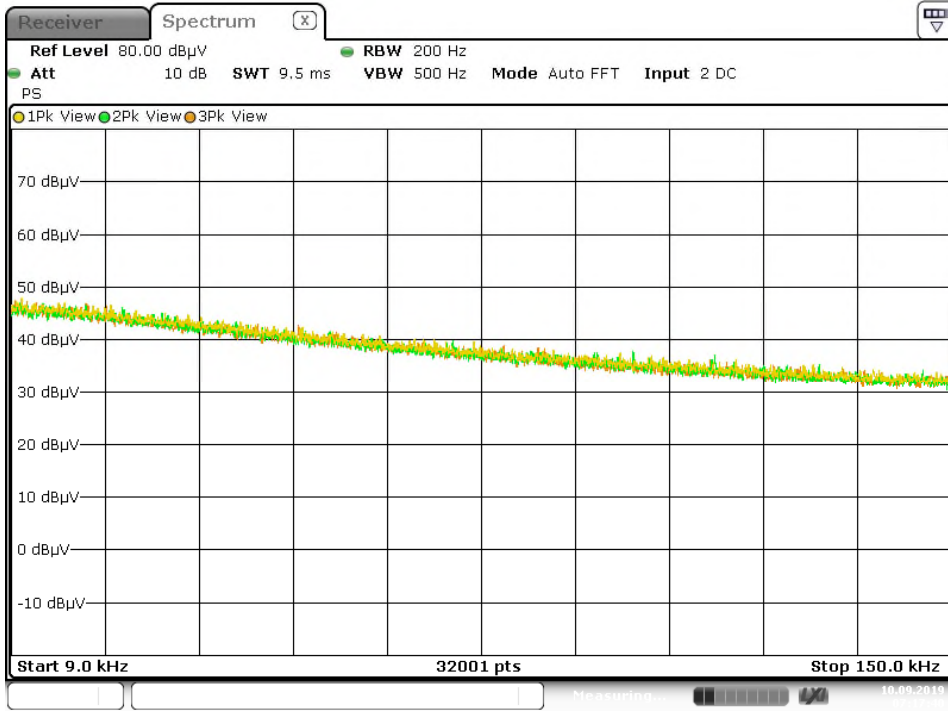
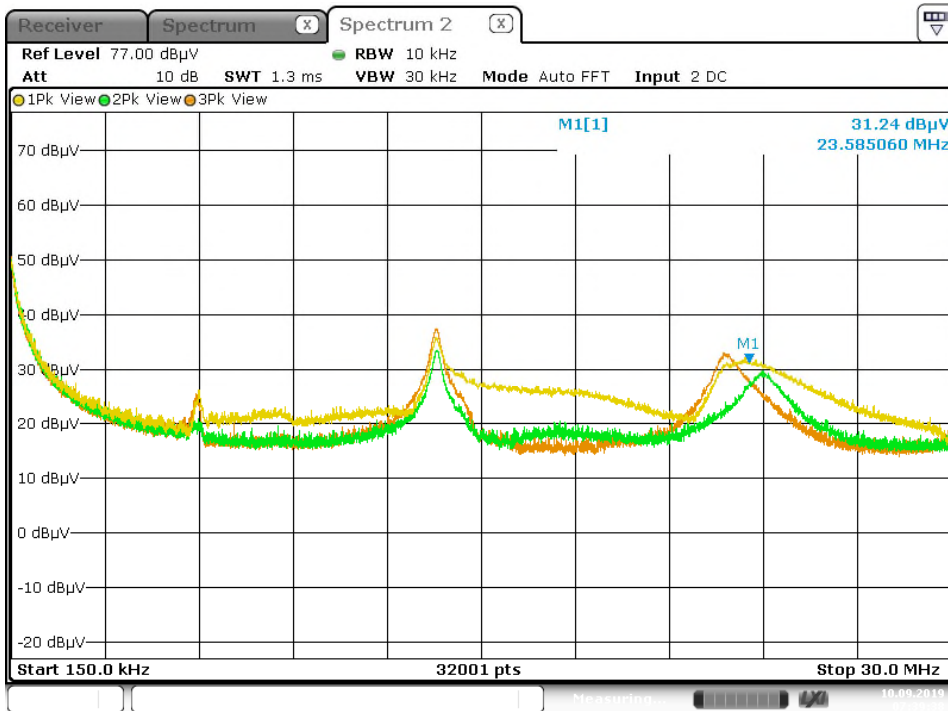
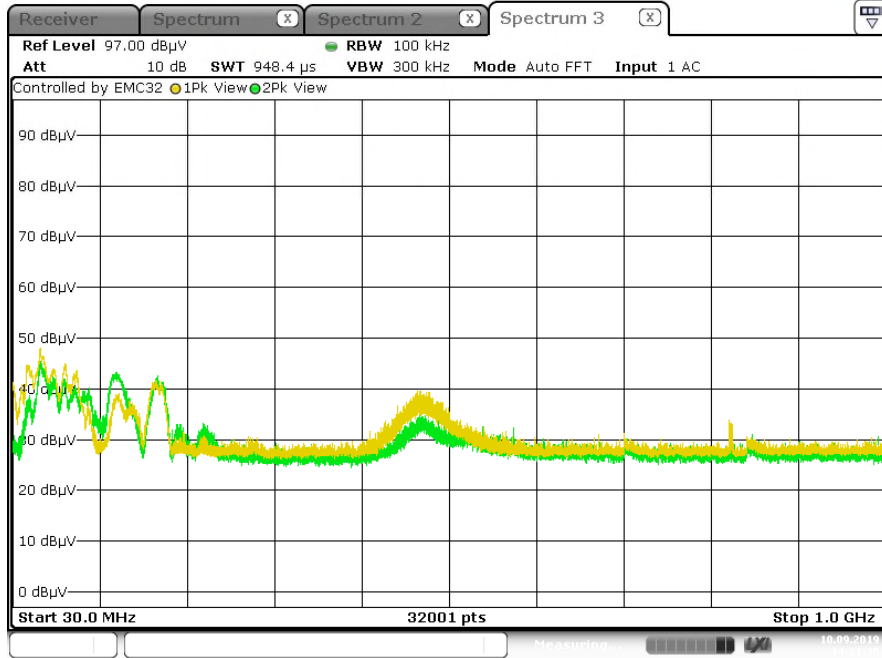

Figure A-1: 9kHz-150kHz



Note: Emissions above the noise floor are related to the driver and not associated with the DUT.

Figure A-2: 150kHz-30MHz



Date: 10.SEP.2019 14:21:36

Note: Emissions above the noise floor are from the digital sections of the DUT and not associated with the radio.

Figure A-3: 30MHz-1GHz

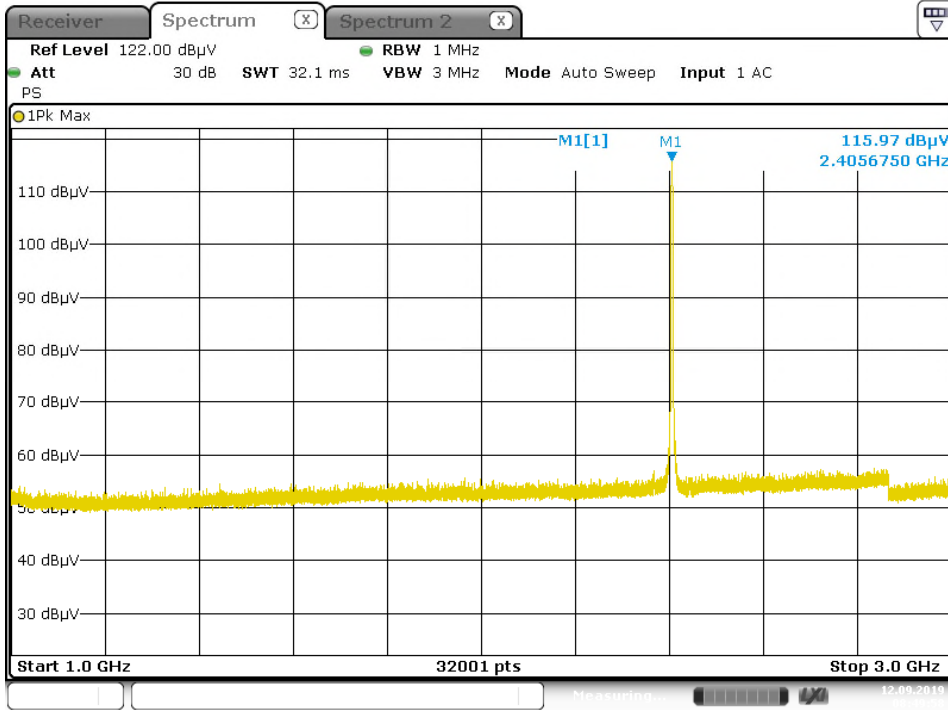

Date: 12.SEP.2019 08:49:58

Figure A-4: 1GHz-3GHz

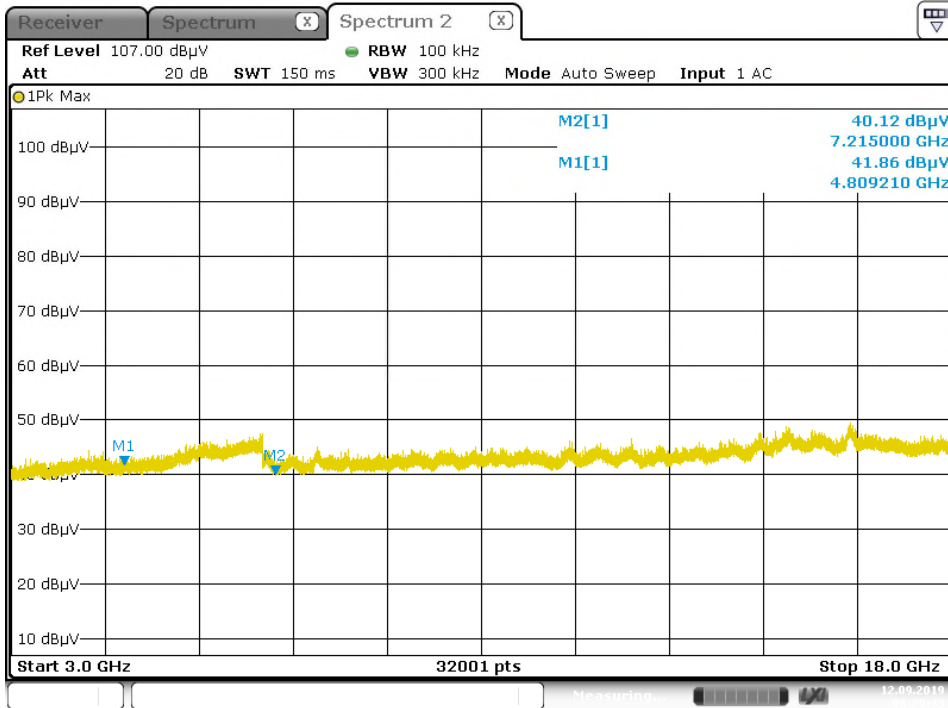

Date: 12 SEP 2019 08:29:33

Figure A-5: 3GHz-18GHz

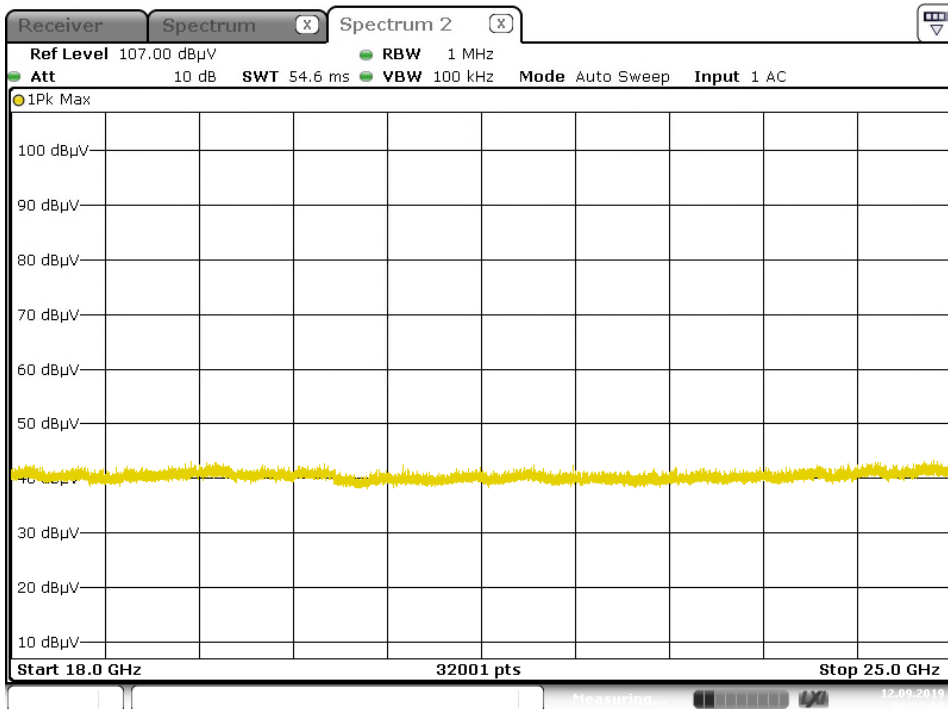

Date: 12 SEP 2019 09:27:07

Figure A-6: 18GHz-25GHz

END REPORT