



# **FCC TEST REPORT**

**FCC ID: 2AKCU3014862**

On Behalf of

**Zebra A/S**

**SELFIE STICK W. REMOTE SOLID COLOR**

**Model No.: 3014862**

Prepared for : Zebra A/S  
Address : Strandgade 71-73, DK-1401 Copenhagen K Denmark

Prepared By : Shenzhen Alpha Product Testing Co., Ltd.  
Address : Building i, No.2, Lixin Road, Fuyong Street, Bao'an District, 518103,  
Shenzhen, Guangdong, China

Report Number : T1890103 03  
Date of Receipt : December 05, 2018  
Date of Test : December 05, 2018 – January 15, 2019  
Date of Report : January 15, 2019  
Version Number : REV0

## TABLE OF CONTENTS

Description	Page
<b>1. Summary of Standards And Results-----</b>	<b>6</b>
1.1. Description of Standards and Results -----	6
<b>2. General Information -----</b>	<b>7</b>
2.1. Description of Device (EUT)-----	7
2.2. Accessories of Device (EUT) -----	8
2.3. Tested Supporting System Details -----	8
2.4. Block Diagram of connection between EUT and simulators -----	8
2.5. Test Mode Description -----	8
2.6. Test Conditions -----	8
2.7. Additional instructions -----	9
2.8. Test Facility -----	10
2.9. Measurement Uncertainty -----	10
2.10. Test Equipment List -----	11
<b>3. Spurious Emission-----</b>	<b>12</b>
3.1. Test Limits -----	12
3.2. Test Procedure -----	12
3.3. Test Setup -----	13
3.4. Test Results -----	14
<b>4. Power Line Conducted Emission-----</b>	<b>23</b>
4.1. Test Limits -----	23
4.2. Test Procedure -----	23
4.3. Test Setup -----	23
4.4. Test Results -----	24
<b>5. Conducted Maximum Output Power -----</b>	<b>25</b>
5.1. Test limits -----	25
5.2. Test Procedure -----	25
5.3. Test Setup -----	25
5.4. Test Results -----	25
<b>6. Peak Power Spectral Density-----</b>	<b>26</b>
6.1. Test limits -----	26
6.2. Test Procedure -----	26
6.3. Test Setup -----	26
6.4. Test Results -----	26
<b>7. Bandwidth-----</b>	<b>28</b>
7.1. Test limits -----	28
7.2. Test Procedure -----	28
7.3. Test Setup -----	28
7.4. Test Results -----	28
<b>8. Band Edge Check-----</b>	<b>30</b>
8.1. Test limits -----	30
8.2. Test Procedure -----	30
8.3. Test Results -----	30
<b>9. Antenna Requirement -----</b>	<b>36</b>
9.1. Standard Requirement -----	36
9.2. Antenna Connected Construction -----	36

9.3. Results ----- 36

## TEST REPORT DECLARATION

Applicant : Zebra A/S  
 Address : Strandgade 71-73, DK-1401 Copenhagen K Denmark  
 Manufacturer : NINGBO SELECTED ELECTRICAL APPLIANCES CO., LTD  
 Address : NO.98 3ZONE PUXI, LINHAI VILLAGE, LINSHAN TOWN, YUYAO, NINGBO,  
 ZHEJIANG  
 Model Name : SELFIE STICK W. REMOTE SOLID COLOR  
                   (A) Model No. : 3014862  
                   (B) Trademark : N/A

Measurement Standard Used:

**FCC Rules and Regulations Part 15 Subpart C Section 15.247: 2017,  
 ANSI C63.10-2013**

The device described above is tested by Shenzhen Alpha Product Testing Co., Ltd. to determine the maximum emission levels emanating from the device. The maximum emission levels are compared to the FCC Part 15 Subpart C limits both conducted and radiated emissions. The test results are contained in this test report and Shenzhen Alpha Product Testing Co., Ltd. is assumed of full responsibility for the accuracy and completeness of these tests.

After the test, our opinion is that EUT compliance with the requirement of the above standards.

This report applies to above tested sample only. This report shall not be reproduced in parts without written approval of Shenzhen Alpha Product Testing Co., Ltd.

Tested by (name + signature).....:

Reak Yang  
 Project Engineer

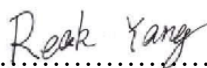
.....  

Approved by (name + signature).....:

Simple Guan  
 Project Manager

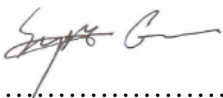
.....  

Date of issue.....

January 15, 2019

**Revision History**

Revision	Issue Date	Revisions	Revised By
00	January 15, 2019	Initial released Issue	Simple Guan

## 1. SUMMARY OF STANDARDS AND RESULTS

### 1.1. Description of Standards and Results

The EUT have been tested according to the applicable standards as referenced below:

Test Item	Test Requirement	Standards Paragraph	Result
Conducted Emission	FCC PART 15:2017	15.207	N/A
6dB Bandwidth	FCC PART 15:2017	15.247 (a)(2)	P
Output Power	FCC PART 15:2017	15.247 (b)(3)	P
Radiated Spurious Emission	FCC PART 15:2017	15.247 (c)	P
Conducted Spurious & Band Edge Emission	FCC PART 15:2017	15.247 (d)	P
Power Spectral Density	FCC PART 15:2017	15.247 (e)	P
Radiated Band Edge Emission	FCC PART 15:2017	15.205	P
Antenna Requirement	FCC PART 15:2017	15.203	P
Note:	1. P is an abbreviation for Pass. 2. F is an abbreviation for Fail. 3. N/A is an abbreviation for Not Applicable.		

## 2. GENERAL INFORMATION

### 2.1. Description of Device (EUT)

Description	: The product is built with Bluetooth compatibility
Model Name	: SELFIE STICK W. REMOTE SOLID COLOR
Model Number	: 3014862
Diff	: The appliance contains four different colors, all the samples are identical except appearance color.
Trademark	: N/A
Test Voltage	: DC 3V from battery
Bluetooth Version	: Bluetooth 4.0 BLE
Operation frequency	: 2402-2480MHz
Channel No.	: 40 Channels
Modulation type	: GFSK
Antenna Type	: PCB Antenna, Maximum Gain is -3dBi
Software version	: V1.0
Hardware version	: V1.0
Product Size	: Length: 26.4mm Width: 24.2mm Height: 311.3mm – 905.3mm

## 2.2. Accessories of Device (EUT)

Power Source : N/A

## 2.3. Tested Supporting System Details

No.	Description	Manufacturer	Model	Serial Number	Certification or sDOC
1	N/A	N/A	N/A	N/A	N/A

## 2.4. Block Diagram of connection between EUT and simulators



## 2.5. Test Mode Description

Tested mode, channel, and data rate information		
Mode	Channel	Frequency (MHz)
GFSK	Low :CH0	2402
	Middle: CH19	2440
	High: CH39	2480

## 2.6. Test Conditions

Items	Required	Actual
Temperature range:	15-35°C	25°C
Humidity range:	25-75%	56%
Pressure range:	86-106kPa	98kPa



## 2.7. Additional instructions

Software (Used for test) from client

Mode	Special Hardware operating is used. The Hardware operating method is provided by client to enable the EUT under transmission condition continuously at specific channel frequencies individually.		
Power level setup by client			
Mode	Channel	Frequency (MHz)	Soft Set
GFSK	CH0	2402	TX level is set as defaults value.
	CH19	2440	
	CH39	2480	

## 2.8. Test Facility

Shenzhen Alpha Product Testing Co., Ltd  
 Building i, No.2, Lixin Road, Fuyong Street, Bao'an District, 518103,  
 Shenzhen, Guangdong, China

June 21, 2018 File on Federal Communication Commission  
 Registration Number: 293961  
 Designation Number: CN1236

July 25, 2017 Certificated by IC  
 Registration Number: 12135A

## 2.9. Measurement Uncertainty

(95% confidence levels, k=2)

Item	Uncertainty
Uncertainty for Power point Conducted Emissions Test	2.74dB
Uncertainty for Radiation Emission test in 3m chamber (below 30MHz)	2.13 dB(Polarize: V)
	2.57dB(Polarize: H)
Uncertainty for Radiation Emission test in 3m chamber (30MHz to 1GHz)	3.77dB(Polarize: V)
	3.80dB(Polarize: H)
Uncertainty for Radiation Emission test in 3m chamber (1GHz to 25GHz)	4.16dB(Polarize: H)
	4.13dB(Polarize: V)
Uncertainty for radio frequency	$5.8 \times 10^{-8}$
Uncertainty for conducted RF Power	0.37dB
Uncertainty for temperature	0.2°C
Uncertainty for humidity	%
Uncertainty for DC and low frequency voltages	0.06%

## 2.10. Test Equipment List

Equipment	Manufacturer	Model No.	Serial No.	Last cal.	Cal. Due day
Bilog Antenna	SCHWARZBECK	VULB 9168	9168-438	2018.04.13	2020.04.12
Spectrum analyzer	Agilent	E4407B	MY49510055	2018.09.21	2019.09.20
Horn Antenna	SCHWARZBECK	BBHA 9120 D	BBHA 9120 D(1201)	2018.04.13	2020.04.12
Filter	KANGMAI	ZLPF-LDC-1000- 1959	1209002075	2018.09.21	2019.09.20
Filter	WAINWRIGHT	WHKX2.80 /18G- 12SS	SN1	2018.09.21	2019.09.20
RF Cable	Resenberger	Cable 4	N/A	2018.09.21	2019.09.20
Signal Analyzer	Agilent	N9020A	MY499100060	2018.09.11	2019.09.10
vector Signal Generator	Agilent	N5182A	MY49060042	2018.09.11	2019.09.10
vector Signal Generator	Agilent	E4438C	US44271917	2018.09.11	2019.09.10
Amplifier	HP	HP8347A	2834A00455	2018.09.21	2019.09.20
Amplifier	Agilent	8449B	3008A02664	2018.04.13	2020.04.12
Filter	WAINWRIGHT	WHKX1.0G/15G- 10SS	SN40	2018.09.21	2019.09.20
Test Receiver	ROHDE&SCHWARZ	ESR	1316.3003K03-102082-Wa	2018.09.21	2019.09.20
9*6*6 anechoic chamber	CHENYU	9*6*6	N/A	2016.07.21	2020.07.20
RF Cable	Resenberger	Cable 1	N/A	2018.09.21	2019.09.20
RF Cable	Resenberger	Cable 2	N/A	2018.09.21	2019.09.20
RF Cable	Resenberger	Cable 3	N/A	2018.09.21	2019.09.20
Loop Antenna	SCHWARZBECK	FMZB 1519B	00005	2018.09.26	2020.09.25
Attenuator	HP	8494B	DC-18G	2018.09.21	2019.09.20
Attenuator	HP	8496B	DC-18G	2018.09.21	2019.09.20
20dB Attenuator	ICPROBING	IATS1	82347	2018.09.21	2019.09.20
Horn Antenna	SCHWARZBECK	BBHA 9170	BBHA 9170294	2017.02.22	2019.02.21

### 3. SPURIOUS EMISSION

#### 3.1. Test Limits

Frequencies (MHz)	Field Strength (microrvolts/meter)	Measurement Distance (meters)
0.009~0.490	2400/F(KHz)	300
0.490~1.705	24000/F(KHz)	30
1.705~30.0	30	30
30~88	100	3
88~216	150	3
216~960	200	3
Above 960	500	3

Harmonic emissions limits comply with below 54 dBuV/m at 3m. Other emissions radiated outside of the specified frequency bands, except for harmonics, shall be attenuated by at least 50 dB below the level of the fundamental or comply with the radiated emissions limits specified in section 15.209(a) limit in the table below has to be followed.

**NOTE:**

- a) The tighter limit applies at the band edges.
- b) Emission Level(dB uV/m)=20log Emission Level(uV/m)

#### 3.2. Test Procedure

The measuring distance of 3m shall be used for measurements at frequency up to 1GH and above 1GHz, The EUT was placed on a rotating 0.8 m high above ground for below 1GHz and 1.5m high for above 1GHz testing, the table was rotated 360 degrees to determine the position of the highest radiation

The Test antenna shall vary between 1m and 4m, Both Horizontal and Vertical antenna are set of make measurement.

The initial step in collecting conducted emission data is a spectrum analyzer Peak detector mode pre-scanning the measurement frequency range. Significant Peaks are then marked. and then Qusia Peak Detector mode premeasured

If Peak value comply with QP limit Below 1GHz.The EUT deemed to comply with QP limit. But the Peak value and average value both need to comply with applicable limit above 1GHz.

For the actual test configuration, please see the test setup photo.

### 3.3. Test Setup

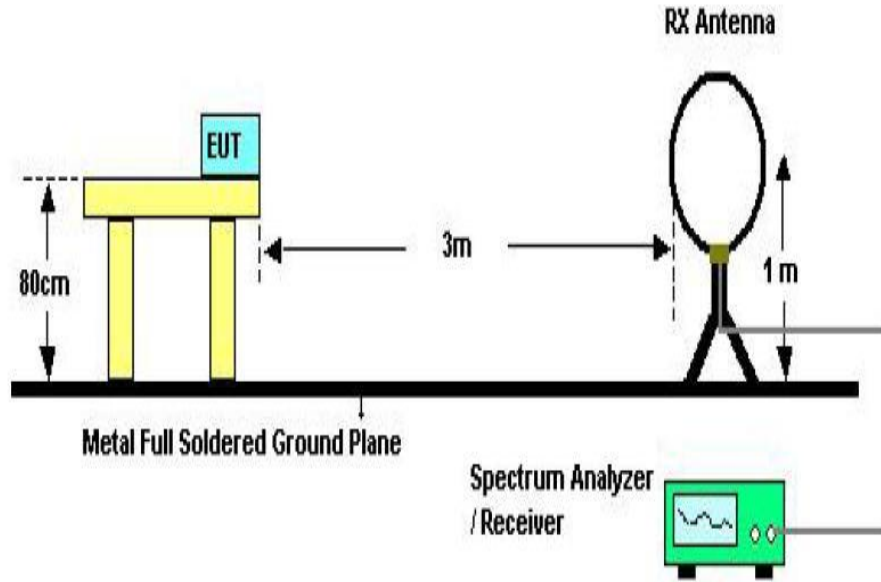

Below 30MHz Test Setup

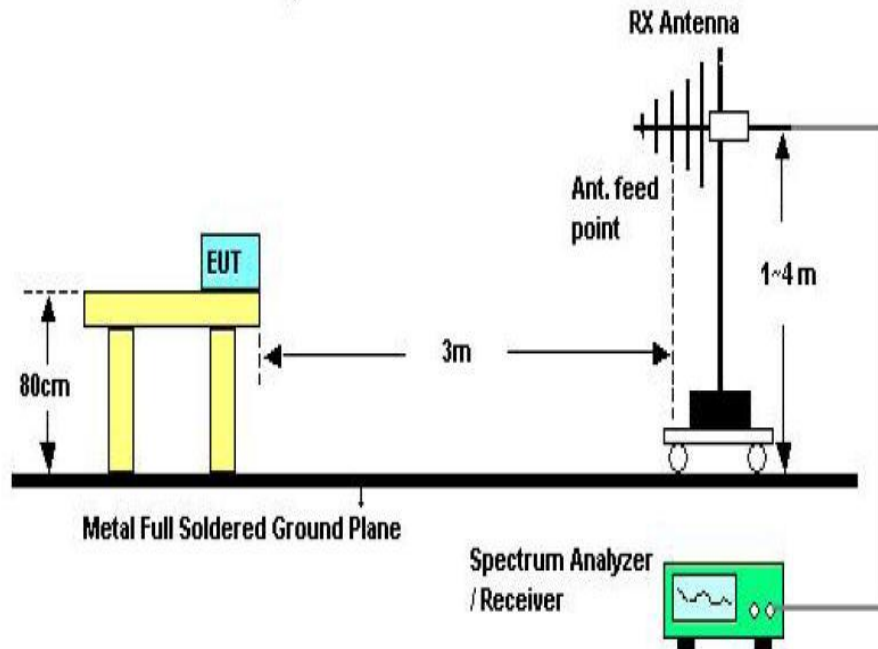

Above 30MHz Test Setup

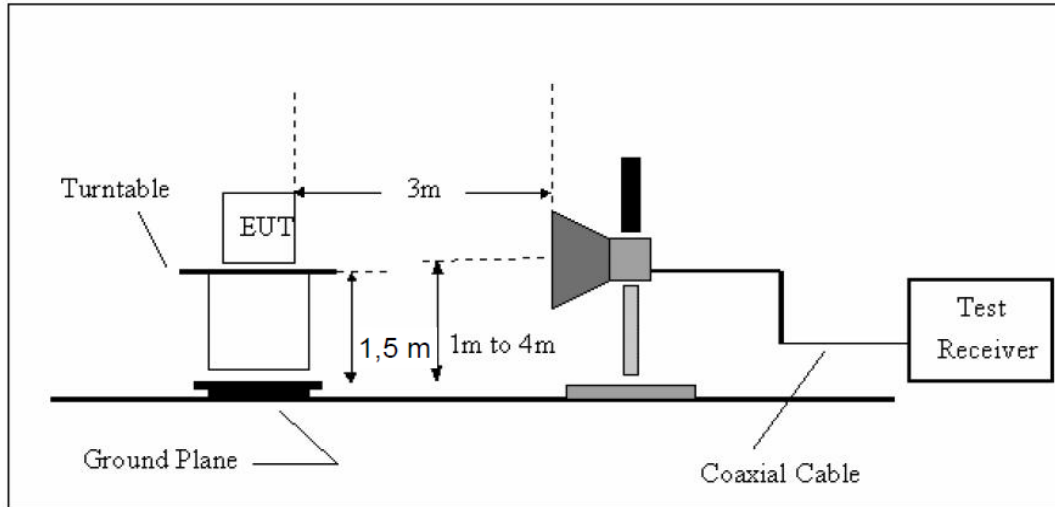

Above 1GHz Test Setup

### 3.4. Test Results

#### Test Condition

Continually Transmitting in maximum power.

9KHz~150KHz	RBW200Hz	VBW1KHz
150KHz~30MHz	RBW9KHz	VBW 30KHz
30MHz~1GHz	RBW120KHz	VBW 300KHz
Above1GHz	RBW1MHz	VBW 3MHz

We have scanned the 10th harmonic from 9 kHz to the EUT.

Detailed information please see the following page.

From 9KHz to 30MHz: Conclusion: PASS

Note: 1. If the amplitude of the spurious emission is more than 20dB above the allowable value, it's considered too low relative to the limit value, no necessary to report.

2. For above 1GHz test, if peak Result comply with AV limit, AV Result is deemed to comply with AV limit, no necessary to report.

Vertical

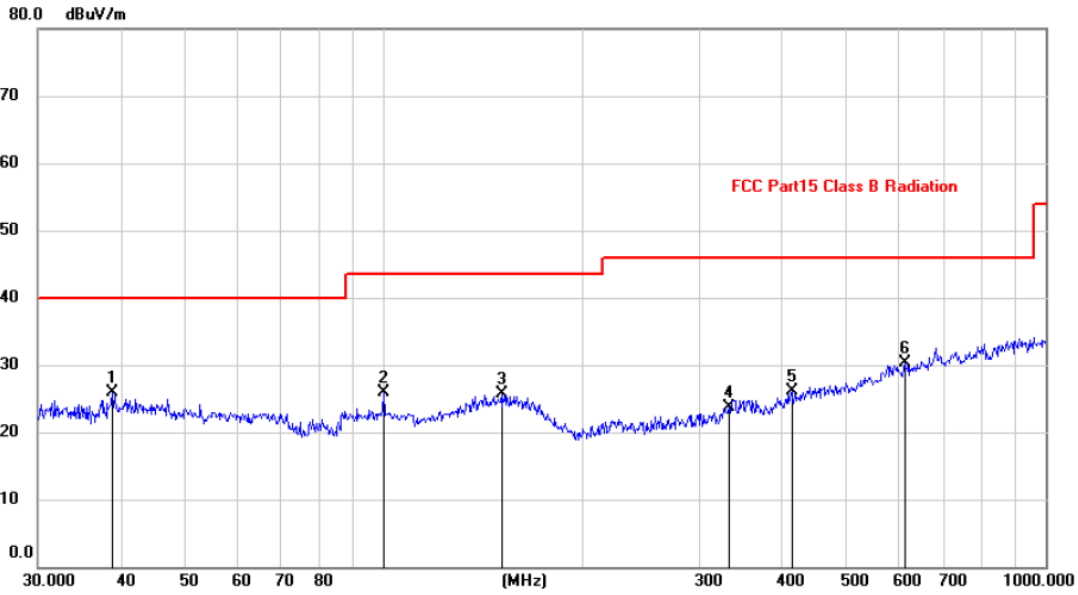

No.	Mk.	Freq.	Reading Level	Correct Factor	Measurement	Limit	Margin	Antenna Height	Table Degree
		MHz	dBuV	dB	dBuV/m	dBuV/m	dB	cm	degree
1	*	39.0242	11.66	14.20	25.86	40.00	-14.14	peak	
2		99.8777	15.27	10.60	25.87	43.50	-17.63	peak	
3		151.0663	11.05	14.56	25.61	43.50	-17.89	peak	
4		332.5187	9.47	14.32	23.79	46.00	-22.21	peak	
5		413.2706	10.23	15.96	26.19	46.00	-19.81	peak	
6		612.0642	10.59	19.75	30.34	46.00	-15.66	peak	

Note: 1. \*:Maximum data; x:Over limit; !:over margin.

2.Measurement=Reading Level+Correct Factor; Correct Factor=Antenna Factor+Cable Loss.

### Horizontal

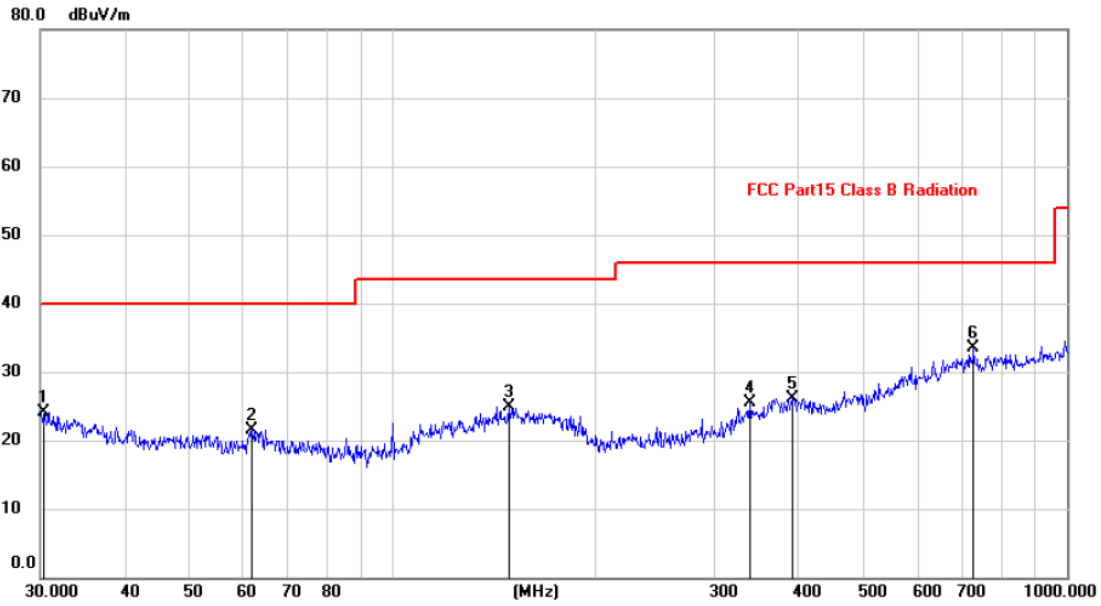

No.	Mk.	Freq.	Reading Level	Correct Factor	Measurement	Limit	Margin	Antenna Height	Table Degree
		MHz	dBuV	dB	dBuV/m	dBuV/m	dB	cm	degree
1		30.4237	10.86	13.30	24.16	40.00	-15.84	peak	
2		61.9949	8.97	12.55	21.52	40.00	-18.48	peak	
3		148.4410	10.45	14.44	24.89	43.50	-18.61	peak	
4		339.5887	11.13	14.42	25.55	46.00	-20.45	peak	
5		393.4723	10.66	15.41	26.07	46.00	-19.93	peak	
6	*	726.8052	12.18	21.33	33.51	46.00	-12.49	peak	

Note:1. \*:Maximum data; x:Over limit; !:over margin.

2.Measurement=Reading Level+Correct Factor; Correct Factor=Antenna Factor+Cable Loss.

**Notes:** Above is below 1GHz test data. This report only shall the worst case mode for TX 2402MHz.



### TX:2402MHz Horizontal

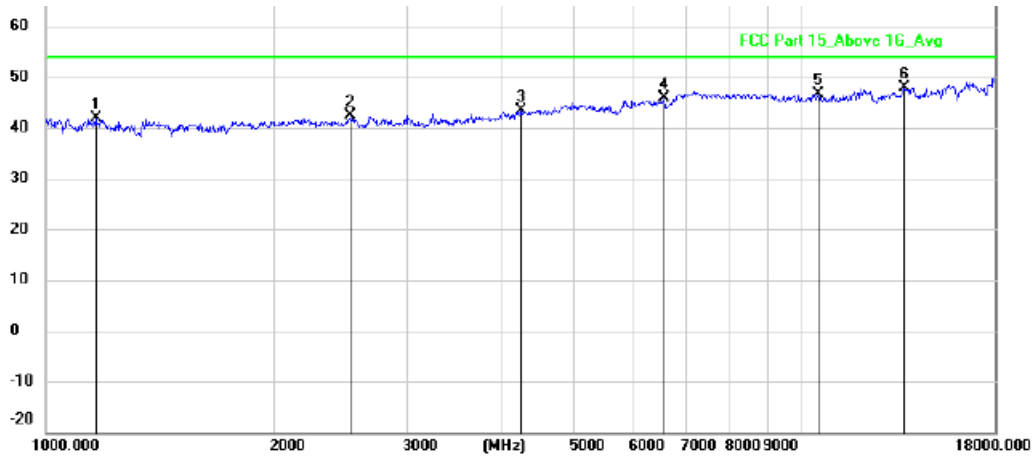

No.	Mk.	Freq.	Reading Level	Correct Factor	Measurement	Limit	Margin	Antenna Height	Table Degree
		MHz	dBuV	dB	dBuV/m	dBuV/m	dB	cm	degree
1		1162.182	50.22	-8.36	41.86	74.00	-32.14	peak	
2		2521.664	45.67	-3.32	42.35	74.00	-31.65	peak	
3		4242.641	47.89	-4.52	43.37	74.00	-30.63	peak	
4		6564.209	45.18	0.75	45.93	74.00	-28.07	peak	
5		10514.57	41.42	5.20	46.62	74.00	-27.38	peak	
6	*	13677.96	41.49	6.43	47.92	74.00	-26.08	peak	

Note:1. \*:Maximum data; x:Over limit; !:over margin.

2.Measurement=Reading Level+Correct Factor; Correct Factor=Antenna Factor+Cable Loss.

### TX:2402MHz Vertical

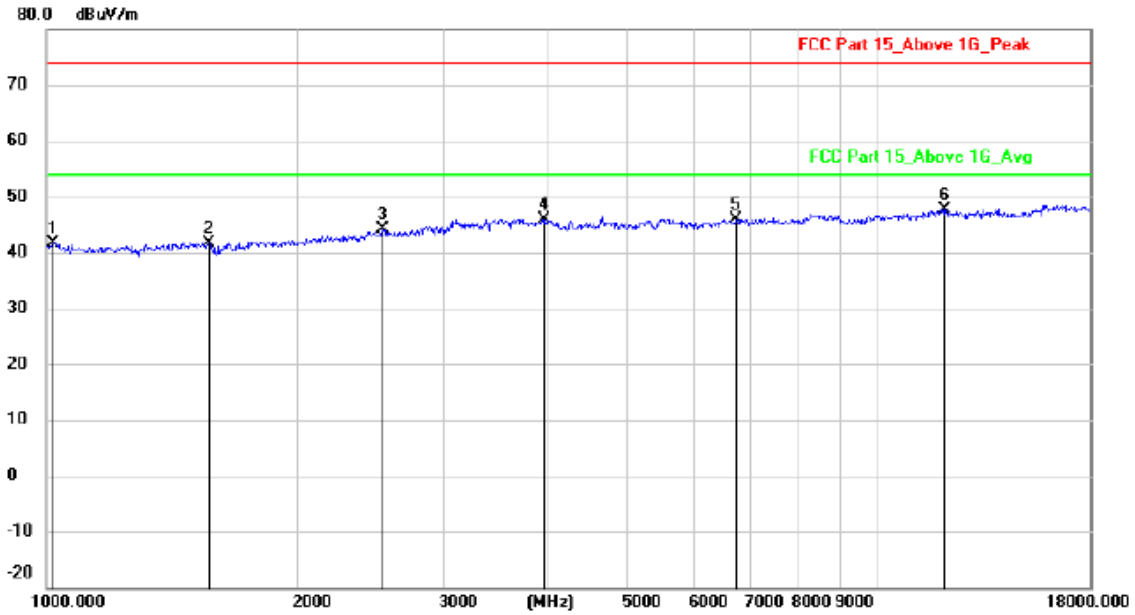

No.	Mk.	Freq.	Reading Level	Correct Factor	Measurement	Limit	Margin	Antenna Height	Table Degree	
		MHz	dBuV	dB	dBuV/m	dBuV/m	dB	cm	degree	Comment
1		1017.494	50.35	-8.64	41.71	74.00	-32.29			peak
2		1565.190	48.51	-6.89	41.62	74.00	-32.38			peak
3		2536.283	47.45	-3.29	44.16	74.00	-29.84			peak
4		3958.309	51.16	-5.19	45.97	74.00	-28.03			peak
5		6756.708	44.82	1.13	45.95	74.00	-28.05			peak
6	*	12044.52	42.13	5.59	47.72	74.00	-26.28			peak

Note:1. \*:Maximum data; x:Over limit; !:over margin.

2.Measurement=Reading Level+Correct Factor; Correct Factor=Antenna Factor+Cable Loss.

### TX:2440MHz Vertical

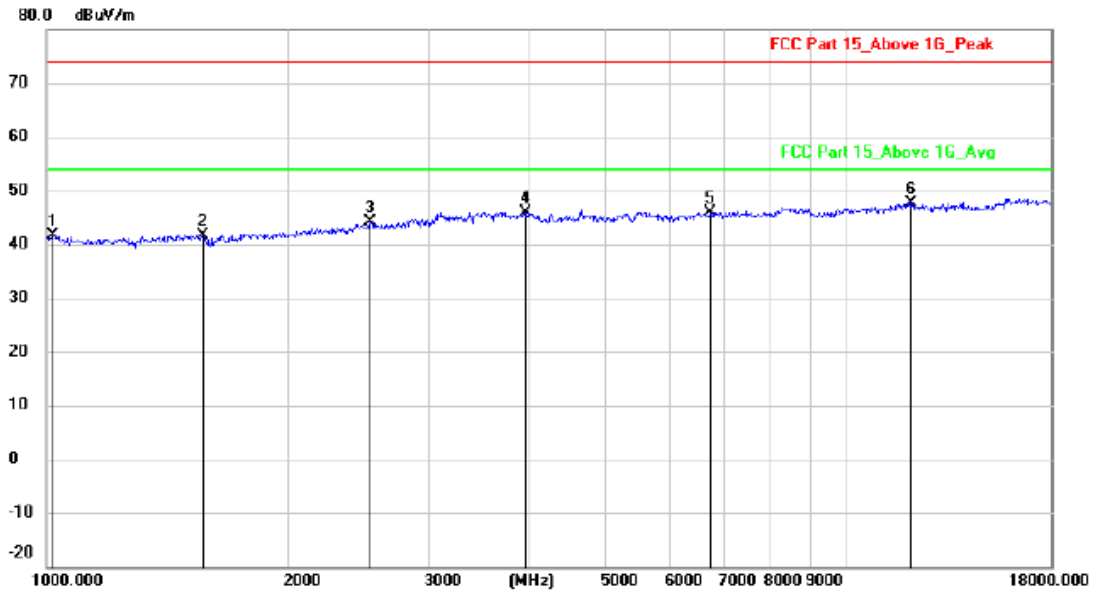

No.	Mk.	Freq. MHz	Reading Level dBuV	Correct Factor dB	Measure- ment dBuV/m	Limit dBuV/m	Margin dB	Antenna Height cm	Table Degree	Comment
1		1017.494	50.35	-8.64	41.71	74.00	-32.29			peak
2		1565.190	48.51	-6.89	41.62	74.00	-32.38			peak
3		2536.283	47.45	-3.29	44.16	74.00	-29.84			peak
4		3958.309	51.16	-5.19	45.97	74.00	-28.03			peak
5		6756.708	44.82	1.13	45.95	74.00	-28.05			peak
6	*	12044.52	42.13	5.59	47.72	74.00	-26.28			peak

Note:1. \*:Maximum data; x:Over limit; !:over margin.

2.Measurement=Reading Level+Correct Factor; Correct Factor=Antenna Factor+Cable Loss.

### TX:2440MHz Horizontal

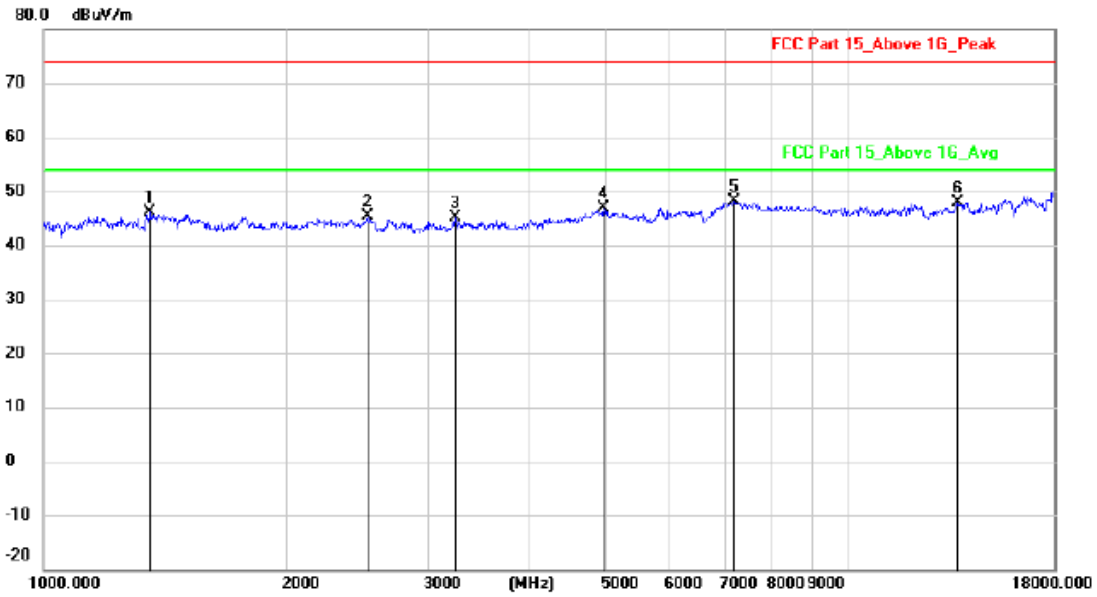

No.	Mk.	Freq. MHz	Reading Level dBuV	Correct Factor dB	Measure- ment dBuV/m	Limit dBuV/m	Margin dB	Antenna Height cm	Table Degree degree	Comment
1		1354.577	53.25	-7.15	46.10	74.00	-27.90			peak
2		2521.664	48.67	-3.32	45.35	74.00	-28.65			peak
3		3242.619	47.51	-2.28	45.23	74.00	-28.77			peak
4		4959.307	49.51	-2.58	46.93	74.00	-27.07			peak
5	*	7200.309	44.76	3.46	48.22	74.00	-25.78			peak
6		13677.96	41.49	6.43	47.92	74.00	-26.08			peak

Note: 1. \*:Maximum data; x:Over limit; !:over margin.

2.Measurement=Reading Level+Correct Factor; Correct Factor=Antenna Factor+Cable Loss.

### TX:2480MHz Horizontal

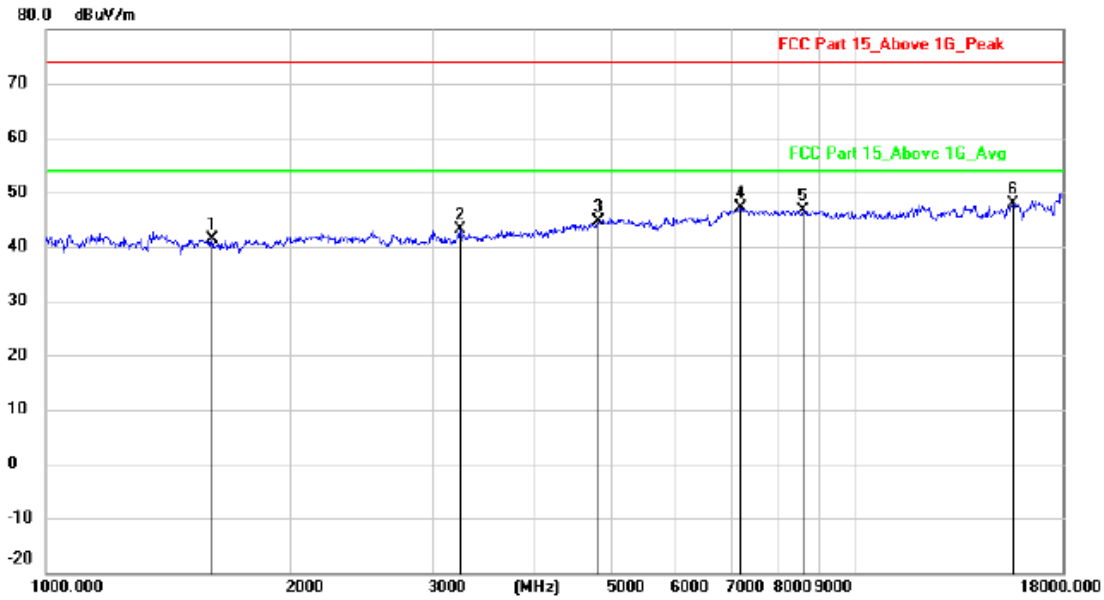

No.	Mk.	Freq. MHz	Reading Level dBuV	Correct Factor dB	Measure- ment dBuV/m	Limit dBuV/m	Margin dB	Antenna Height cm	Table Degree degree	Comment
1		1601.804	48.14	-6.83	41.31	74.00	-32.69			peak
2		3242.619	45.51	-2.28	43.23	74.00	-30.77			peak
3		4804.110	47.59	-2.93	44.66	74.00	-29.34			peak
4		7200.309	43.76	3.46	47.22	74.00	-26.78			peak
5		8613.467	42.83	3.91	46.74	74.00	-27.26			peak
6	*	15622.99	43.12	4.76	47.88	74.00	-26.12			peak

Note:1. \*:Maximum data; x:Over limit; !:over margin.

2.Measurement=Reading Level+Correct Factor; Correct Factor=Antenna Factor+Cable Loss.

### TX:2480MHz Vertical

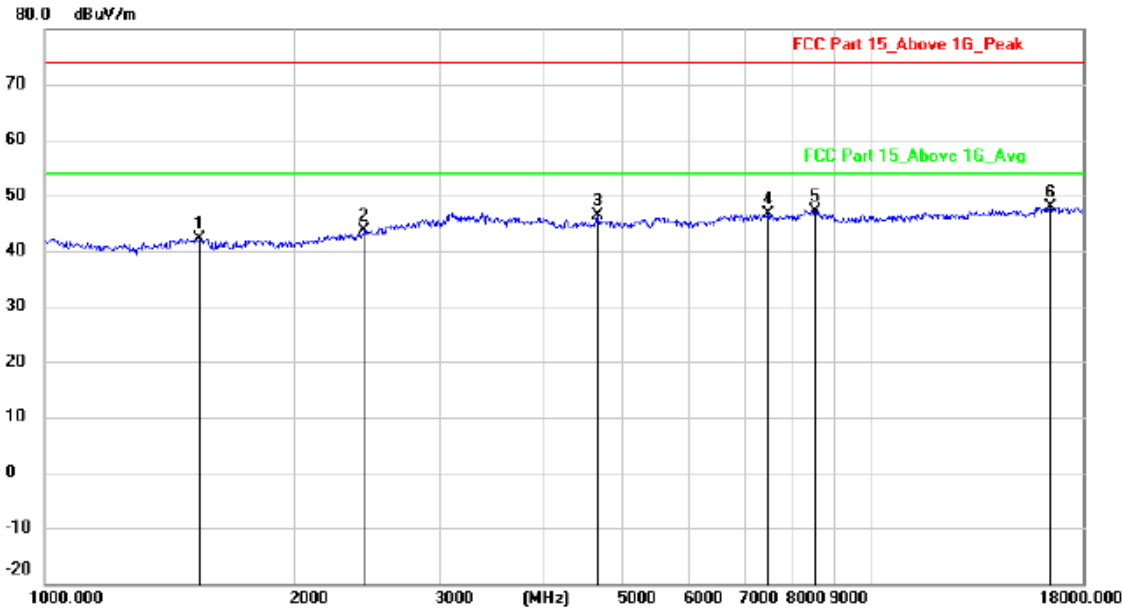

No.	Mk.	Freq. MHz	Reading Level dBuV	Correct Factor dB	Measure- ment dBuV/m	Limit dBuV/m	Margin dB	Antenna Height cm	Table Degree	Comment
1		1538.281	49.18	-6.94	42.24	74.00	-31.76			peak
2		2428.671	47.06	-3.40	43.66	74.00	-30.34			peak
3		4667.241	49.81	-3.33	46.48	74.00	-27.52			peak
4		7497.646	43.29	3.29	46.58	74.00	-27.42			peak
5		8539.102	43.45	3.76	47.21	74.00	-26.79			peak
6	*	16409.81	43.62	4.37	47.99	74.00	-26.01			peak

Note:1. \*:Maximum data; x:Over limit; !:over margin.  
 2.Measurement=Reading Level+Correct Factor; Correct Factor=Antenna Factor+Cable Loss.

The data for 18G-25GHz is very low, so not be shown

## 4. Power Line Conducted Emission

### 4.1. Test Limits

Frequency MHz	Limits dB( $\mu$ V)	
	Quasi-peak Level	Average Level
0.15 -0.50	66 -56*	56 - 46*
0.50 -5.00	56	46
5.00 -30.00	60	50

- Notes: 1. \*Decreasing linearly with logarithm of frequency.  
 2. The lower limit shall apply at the transition frequencies.  
 3. The limit decreases in line with the logarithm of the frequency in rang of 0.15 to 0.50 MHz.

### 4.2. Test Procedure

The EUT is put on the plane 0.8m high above the ground by insulating support and is connected to the power mains through a line impedance stabilization network (L.I.S.N.). This provides a 50ohm coupling impedance for the EUT system. Please refer the block diagram of the test setup and photographs. Both sides of AC lines are checked to find out the maximum conducted emission. In order to find the maximum emission levels, the relative positions of equipment and all of the interface cables shall be changed according to ANSI C63.10:2013 on Conducted Emission Measurement.

The bandwidth of test receiver is set at 9 kHz.

### 4.3. Test Setup

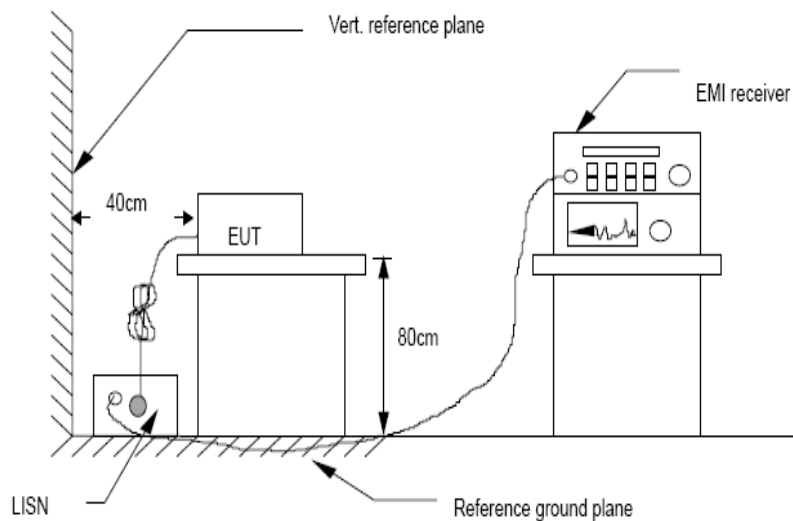

#### 4.4. Test Results

The product supplied by battery only, so this item does not applicable.



## 5. CONDUCTED MAXIMUM OUTPUT POWER

### 5.1. Test limits

Please refer section 15.247.

### 5.2. Test Procedure

Details see the KDB558074 D01 15.247 Meas Guidance v05r01

5.2.1 Place the EUT on the table and set it in transmitting mode.

5.2.2 Measure out each mode and each bands peak output power of EUT.

Note: The cable loss and attenuator loss were offset into measure device as amplitude offset.

### 5.3. Test Setup

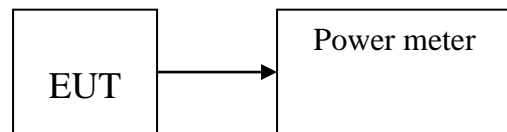

### 5.4. Test Results

Channel	Frequency (MHz)	PK Output Power (dBm)	PK Output Power (mW)	Limit (dBm)
CH0	2402	-1.062	0.783	30
CH19	2440	-1.058	0.784	30
CH39	2480	-1.085	0.779	30
Conclusion: PASS				

## 6. PEAK POWER SPECTRAL DENSITY

### 6.1. Test limits

6.1.1 Please refer section 15.247.

6.1.2 For direct sequence systems, the peak power spectral density conducted from the intentional radiator to the antenna shall not be greater than 8dBm in any 3kHz band during any time interval of continuous transmission.

6.1.3 The direct sequence operating of the hybrid system, with the frequency hopping operation turned off, shall comply with the power density requirements of paragraph (d) of this section.

### 6.2. Test Procedure

Details see the KDB558074 D01 15.247 Meas Guidance v05r01

6.2.1 Place the EUT on the table and set it in transmitting mode.

6.2.2 Remove the antenna from the EUT and then connect a low loss RF cable from the antenna port to the spectrum analyzer.

6.2.3 Set the spectrum analyzer as RBW = 3kHz(Set the RBW to:  $3\text{ kHz} \leq \text{RBW} \leq 100\text{ kHz}$ .),  
VBW = 10kHz(Set the VBW  $\geq 3 \times \text{RBW}$ ), span= $1.5 \times \text{DTS bandwidth}$ ., detail see the test plot.

6.2.4 Record the max reading.

6.2.5 Repeat the above procedure until the measurements for all frequencies are completed.

### 6.3. Test Setup

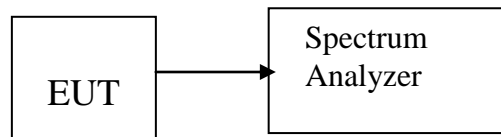

### 6.4. Test Results

Channel	Frequency (MHz)	Power Spectral Density (dBm)	Limit (dBm)	Result
CH0	2402	-10.551	8	PASS
CH19	2440	-11.074	8	PASS
CH39	2480	-11.147	8	PASS
Conclusion: PASS				

### Low channel-2402MHz

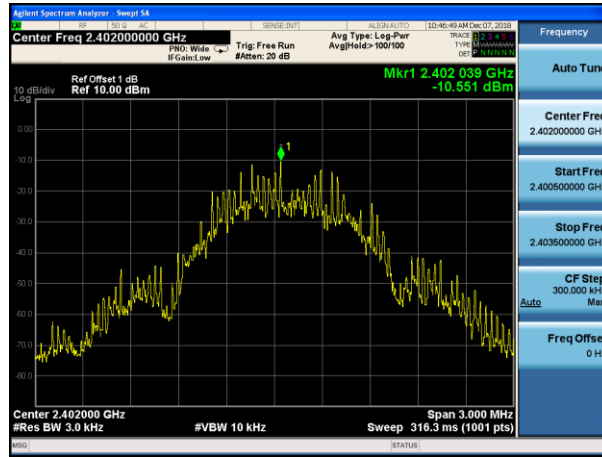

### Middle channel-2440MHz

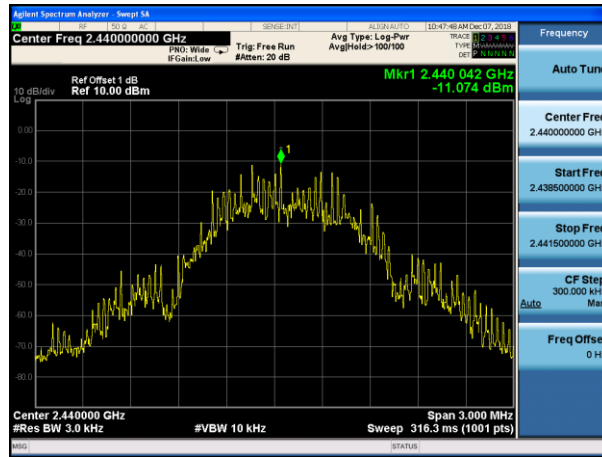

### High channel-2480MHz

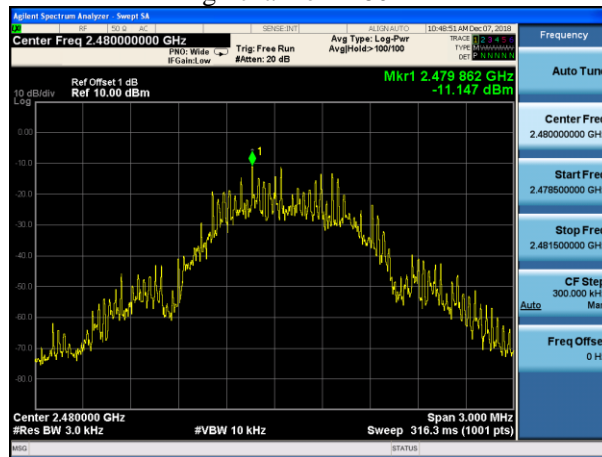

## 7. BANDWIDTH

### 7.1. Test limits

Please refer section 15.247

For direct sequence systems, the minimum 6dB bandwidth shall be at least 500 kHz.

### 7.2. Test Procedure

Details see the KDB558074 D01 15.247 Meas Guidance v05r01

a) The bandwidth is measured at an amplitude level reduced 20dB from the reference level. The reference level is the level of the highest amplitude signal observed from the transmitter at the fundamental frequency. Once the reference level is established, the equipment is conditioned with typical modulating signal to produce the worst-case (i.e. the widest) bandwidth.

b) The test receiver set RBW = 100kHz, VBW  $\geq 3 \cdot$ RBW =300kHz,, Sweep time set auto, detail see the test plot.

### 7.3. Test Setup

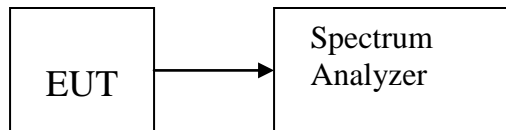

### 7.4. Test Results

Channel	Frequency (MHz)	6dB Bandwidth (MHz)	Limit (MHz)	Result
CH0	2402	0.818	0.5	PASS
CH19	2440	0.825	0.5	PASS
CH39	2480	0.829	0.5	PASS

### Low channel-2402MHz

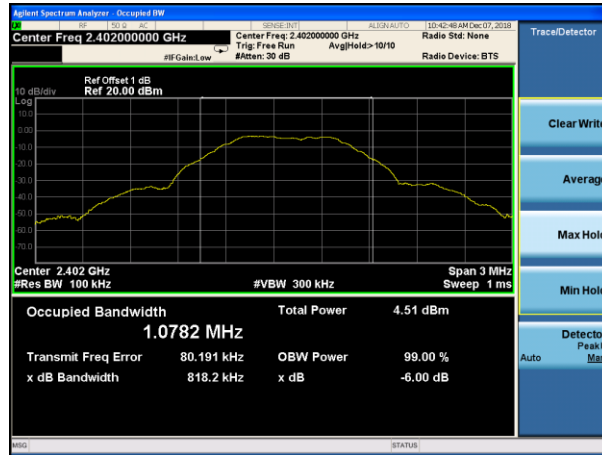

### Middle channel-2440MHz

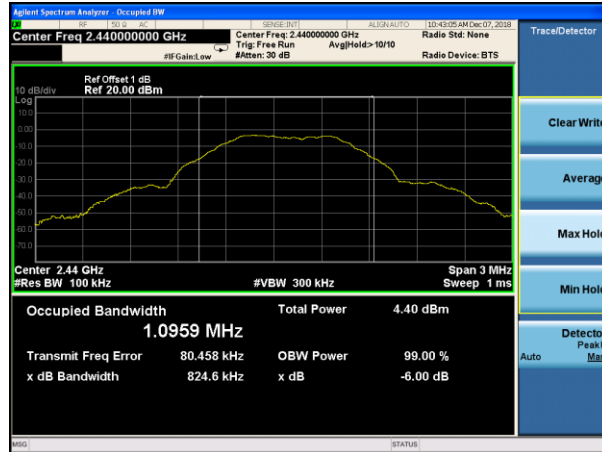

### High channel-2480MHz



## 8. BAND EDGE CHECK

### 8.1. Test limits

Please refer section 15.247.

### 8.2. Test Procedure

Details see the KDB558074 D01 15.247 Meas Guidance v05r01

8.2.1 Put the EUT on a 1.5m high table, power on the EUT. Emissions were scanned and measured rotating the EUT to 360 degrees, Find the maximum Emission

8.2.2 Check the spurious emissions out of band.

8.2.3 Both Peak and Average level were measured with Spectrum Analyzer, and the RBW is set at 1MHz, VBW is set at 3MHz for Peak measure; RBW is set at 1MHz, VBW is set at 10Hz for Average measure. Test Setup Same as 5.2.2.

### 8.3. Test Results

We have scanned the 10th harmonic from 9KHz to the EUT's highest frequency..  
Detailed information please see the following page.

From 9KHz to 30MHz: Conclusion: PASS

Note: 1. The amplitude of the spurious emission is more than 20dB above the allowable value, it's considered too low relative to the limit value, no necessary to report.  
2. For above 1GHz test, if peak Result comply with AV limit, AV Result is deemed to comply with AV limit, no necessary to report.

Radiated Method:  
**TX 2402MHz Horizontal**

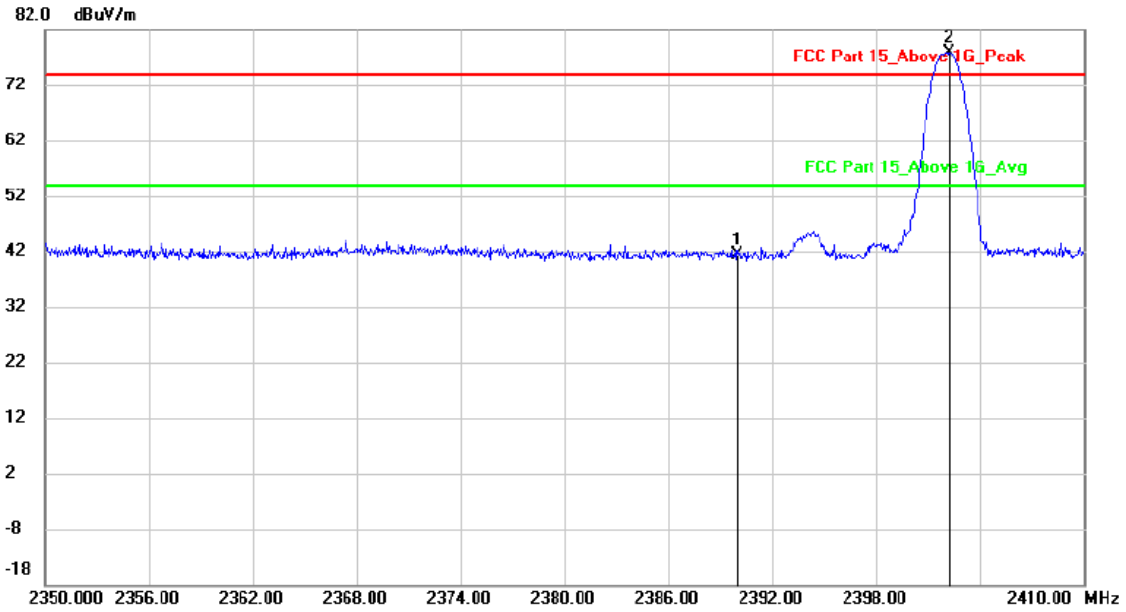

No.	Mk.	Freq.	Reading Level	Correct Factor	Measurement	Limit	Margin	Antenna Height	Table Degree	
		MHz	dBuV	dB	dBuV/m	dBuV/m	dB	cm	degree	Comment
1		2390.000	44.83	-3.40	41.43	74.00	-32.57			peak
2	*	2402.200	81.39	-3.41	77.98	74.00	3.98			peak

Note: 1. \*:Maximum data; x:Over limit; !:over margin.

2. Measurement=Reading Level+Correct Factor; Correct Factor=Antenna Factor+Cable Loss.

**TX 2402MHz Vertical**

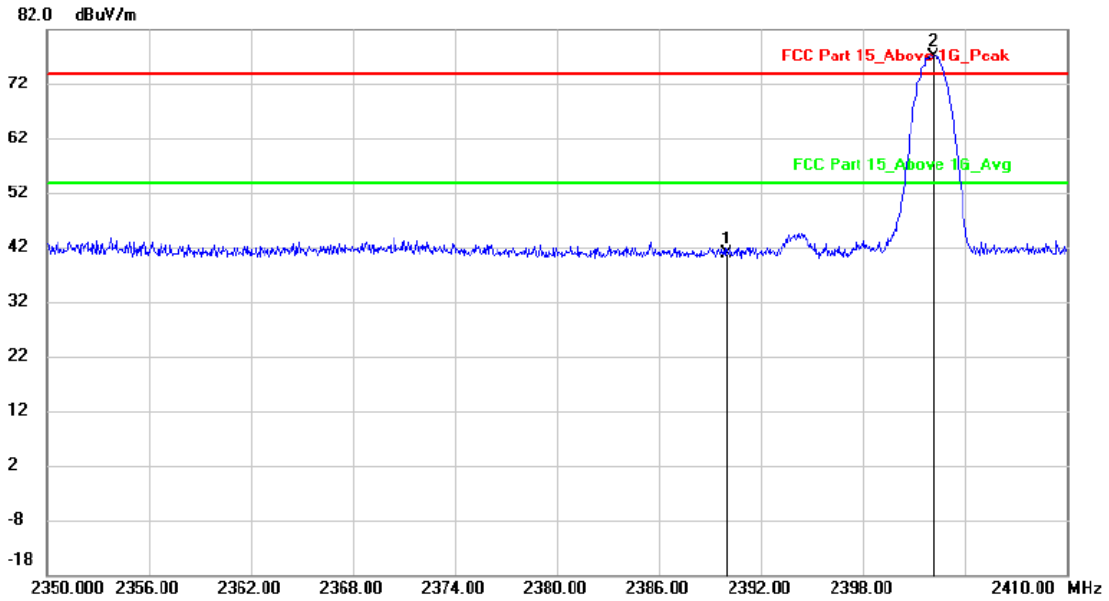

No.	Mk.	Freq. MHz	Reading Level dBuV	Correct Factor dB	Measure- ment dBuV/m	Limit dBuV/m	Margin dB	Antenna Height cm	Table Degree	Comment
1		2390.000	44.18	-3.40	40.78	74.00	-33.22	peak		
2	*	2402.140	80.64	-3.41	77.23	74.00	3.23	peak		

Note:1. \*:Maximum data; x:Over limit; l:over margin.

2.Measurement=Reading Level+Correct Factor; Correct Factor=Antenna Factor+Cable Loss.



**TX 2480MHz Horizontal**

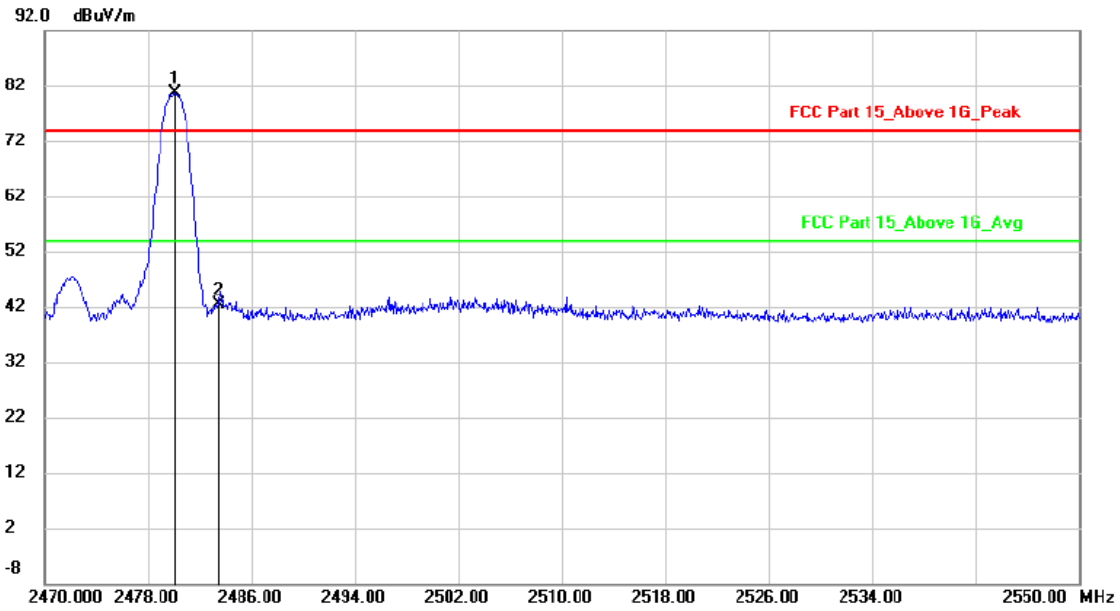

No.	Mk.	Freq. MHz	Reading Level dBuV	Correct Factor dB	Measure- ment dBuV/m	Limit dBuV/m	Margin dB	Detector	Antenna Height cm	Table Degree	Comment
1	*	2480.080	83.91	-3.38	80.53	74.00	6.53	peak			
2		2483.500	45.80	-3.38	42.42	74.00	-31.58	peak			

Note: 1. \*:Maximum data; x:Over limit; !:over margin.

2.Measurement=Reading Level+Correct Factor; Correct Factor=Antenna Factor+Cable Loss.

**TX 2480MHz Vertical**

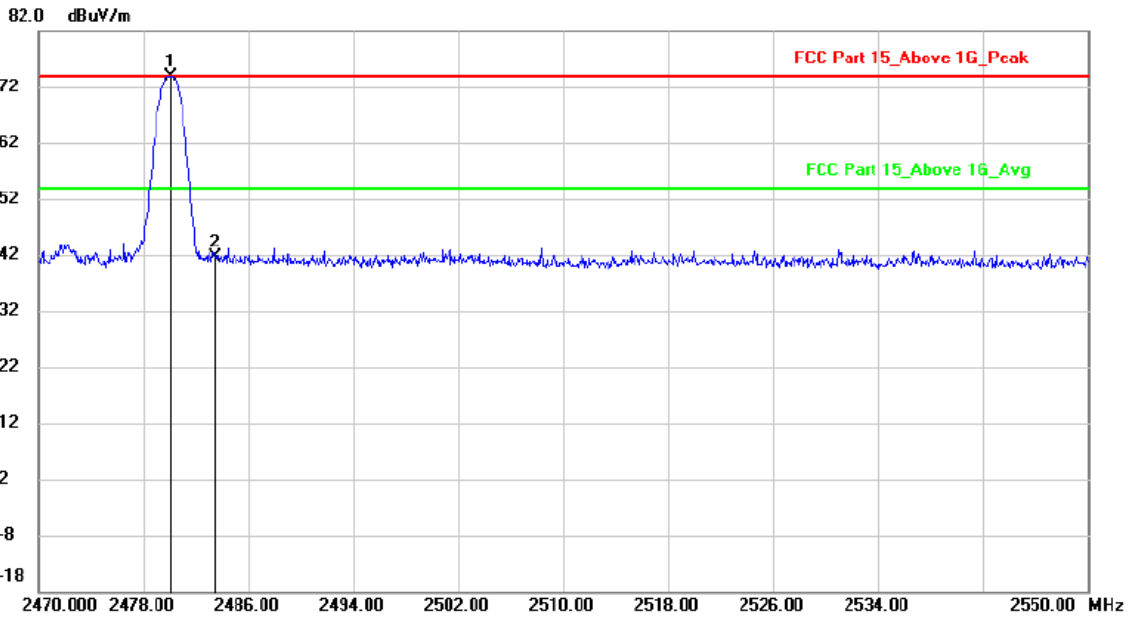

No.	Mk.	Freq.	Reading Level	Correct Factor	Measurement	Limit	Margin	Antenna Height	Table Degree
		MHz	dBuV	dB	dBuV/m	dBuV/m	dB	cm	degree
1	*	2480.080	77.34	-3.38	73.96	74.00	-0.04	peak	
2		2483.500	44.90	-3.38	41.52	74.00	-32.48	peak	

Note: 1. \*:Maximum data; x:Over limit; !:over margin.

2.Measurement=Reading Level+Correct Factor; Correct Factor=Antenna Factor+Cable Loss.

Note: If peak Result comply with AV limit, QP and AV Result is deemed to comply with AV limit



## **9. ANTENNA REQUIREMENT**

### **9.1. Standard Requirement**

An intentional radiator shall be designed to ensure that no antenna other than that furnished by the responsible party shall be used with the device. The use of a permanently attached antenna or of an antenna that uses a unique coupling to the intentional radiator shall be considered sufficient to comply with the provisions of this Section. The manufacturer may design the unit so that a broken antenna can be replaced by the user, but the use of a standard antenna jack or electrical connector is prohibited.

### **9.2. Antenna Connected Construction**

The antenna is internal antenna and no consideration of replacement. Please see EUT photo for details.

### **9.3. Results**

The EUT antenna is an internal Coaxial Antenna. It complies with the standard requirement.