

TEST REPORT
 No.: 6-0082-11-1-2a

According to:
FCC Regulations
 Part 22 & Part 24

IC-Regulations
 RSS-132 Issue 2, RSS-133 Issue 5 &
 RSS-Gen Issue 3

for
u-blox AG

RF Data-Module LISA-U200
FCC-ID: XPYLISAU200
IC-ID: 8595A-LISAU200







Laboratory Accreditation and Listings			
 DAkks Deutsche Akkreditierungsstelle D-PL-12047-01-01	 FEDERAL COMMUNICATIONS COMMISSION USA Reg. No.: 736496 MRA US-EU 0003	 Industry Canada Reg. No.: 3462D-1 Reg. No.: 3462D-2 Reg. No.: 3462D-3	 Voluntary Controls for Electromagnetic Emissions Reg. No.: R-2665, R-2666 C-2914, T-1967, G-301
 WiFi ALLIANCE AUTHORIZED RF LABORATORY	 CTIA Authorized Test Lab LAB CODE 20011130-00		
accredited according to DIN EN ISO/IEC 17025			
<p align="center"> CETECOM GmbH Laboratory Radio Communications & Electromagnetic Compatibility Im Teelbruch 116 • 45219 Essen • Germany Registered in Essen, Germany, Reg. No.: HRB Essen 8984 Tel.: + 49 (0) 20 54 / 95 19-954 • Fax: + 49 (0) 20 54 / 95 19-964 E-mail: info@cetecom.com • Internet: www.cetecom.com </p>			

Table of contents

1. SUMMARY OF TEST RESULTS.....	3
1.1. TX Mode TESTS OVERVIEW FCC Part 15/22/24 and Canada IC Standards (RSS).....	3
1.2. RX Mode TESTS OVERVIEW FCC Part 15/22/24 and Canada IC Standards (RSS).....	4
2. ADMINISTRATIVE DATA	5
2.1. Identification of the testing laboratory.....	5
2.2. Test location	5
2.3. Organizational items	5
2.4. Applicant’s details	5
2.5. Manufacturer’s details	5
3. EQUIPMENT UNDER TEST (EUT).....	6
3.1. Technical description of main EUT.....	6
3.2. EUT: Type, S/N etc. and short descriptions used in this test report	7
3.3. Auxiliary Equipment (AE): Type, S/N etc. and short descriptions.....	7
3.4. EUT set-ups	7
3.5. EUT operating modes	8
3.6. Parameter Settings on mobile phone and base station CMU200	9
4. DESCRIPTION OF TEST SET-UP’S.....	10
4.1. GSM-Mode Test Set-up for conducted measurements	10
4.2. Test set-up for radiated measurements	11
5. MEASUREMENTS	12
5.1. Conducted emissions on AC-Power lines.....	12
5.2. Radiated field strength emissions below 30 MHz	14
5.3. Occupied and emission bandwidth	17
5.4. RF Peak power output conducted	19
5.5. RF Peak power output radiated.....	21
5.6. Radio Frequency Exposure Evaluation.....	23
5.7. Radiated and Conducted out of Band RF emissions and Block Edge	26
5.8. Frequency stability on temperature and voltage variations.....	35
5.9. Measurement uncertainties	44
6. ACCREDITATION DETAILS OF CETECOM’S LABORATORIES AND TEST SITES	44
7. INSTRUMENTS AND ANCILLARY.....	45
7.1. Used equipment “CTC”	45

Table of annexes

	Total pages
SEPARTE DOCUMENT TR6-0082-11-1-2A_A1.PDF: DIAGRAM OF TESTING	86
SEPARTE DOCUMENT TR6-0082-11-1-2A_A2.PDF: PHOTOGRAPHS OF EUT	5
SEPARTE DOCUMENT TR6-0082-11-1-2A_A3.PDF: PHOTOGRAPHS OF MEASUREMENT SET UP’S	4

1. Summary of test results

The test results apply exclusively to the test samples as presented in this Report. The CETECOM GmbH does not assume responsibility for any conclusions and generalizations taken in conjunction with other specimens or samples of the type of the item presented to tests.

The presented RF data-module includes GPRS/(E)GPRS and W-CDMA Band II and V technologies. This test report shows results for GPRS and (E)GPRS technologies only.

Following tests have been performed to show compliance with applicable FCC Part 2, Part 22, Subpart H and Part 24, Subpart E (Broadband PCS) of the FCC CFR 47 Rules, Edition 1st October 2010 and Canada RSS-132, RSS-133 and RSS-Gen standards.

1.1. TX Mode TESTS OVERVIEW FCC Part 15/22/24 and Canada IC Standards (RSS)

TEST CASES	PORT	REFERENCES & LIMITS			EUT set-up	EUT op-mode	Result
		FCC Standard	RSS Section	TEST LIMIT			
Emissions AC-Power Lines 0,15-30 MHz conducted	AC-Power lines	§15.207	RSS-Gen, Issue 3: Chapter 7.2.4	FCC §15.107 class B limits §15.207 limits IC: Table 4, Chapter 7.2.4	3	2 + 4	Passed
field strength <30 MHz radiated	Cabinet + Interconnecting cables	§15.209(a)	RSS-Gen: 4.11	2400/F(kHz) µV/m 24000/F(kHz) µV/m 30 µV/m	3	2 + 4	Passed
RF POWER conducted	Antenna terminal	§2.1046	--	N/A	2	1+ 2+ 3+ 4	Passed
RF-POWER (ERP/EIRP) radiated	Cabinet	§2.1046 §22.913(a)(2) §24.232(c)	RSS-132: 4.4 SRSP-503: 5.1.3 RSS-133:4.1/6.4 SRSP-510: 5.1.2	< 7 Watt (ERP) < 2 Watt (EIRP)	1	1 + 2 + 3 + 4	Passed
Radio frequency Exposure EVALUATION (MPE)	Antenna terminal	§1.1310 §2.1091	RSS-102, Issue 2	FCC: §1.1310 Table 1, Limits for General Population IC: Chapter 4.2 RF-Limits	2	1 + 3	Passed
SPURIOUS EMISSIONS conducted	Antenna terminal	§2.1051 §2.1057 §22.917(a)(b) §24.238(a)(b)	RSS 132: 4.5.1 RSS 133: 6.5.1(a)(b)	43+10log(P) dBc	2	1+ 2+ 3+ 4	Passed
26dB EMISSION BANDWIDTH	Antenna terminal	§2.202 §2.1049 §22.917(a) §24.238(a)	RSS Gen:4.6.1	99% Power	2	1+ 2+ 3+ 4	Passed
99% OCCUPIED BANDWIDTH	Antenna terminal	§2.202 §2.1049 §22.917(a) §24.238(a)	RSS Gen:4.6.1	99% Power	2	1+ 2+ 3+ 4	Passed
SPURIOUS EMISSIONS radiated	Cabinet + Interconnecting cables	§2.1053(a) §2.1057 §22.917(a)(b) §24.238(a)(b)	RSS-132: 4.5.1 & 4.5.2 RSS 133: 6.5.1(a)(b)	43+10log(P) dBc	1	2 + 4	Passed
FREQUENCY STABILITY conducted	Antenna terminal	§22.355, table C-1 §24.235 §2.1055(a)(2)	RSS-132: 4.3 RSS 133: 6.3	< ±2.5ppm <±0.1 ppm	2	1+ 2+ 3+ 4	Passed

1.2. RX Mode TESTS OVERVIEW FCC Part 15/22/24 and Canada IC Standards (RSS)

TEST CASES	PORT	REFERENCES & LIMITS			EUT set-up	EUT op-mode	Result
		FCC Standard	RSS Section	TEST LIMIT			
Emissions AC-Power Lines 0,15-30 MHz conducted	AC-Power lines	§15.107 §15.207	RSS-Gen, Issue 3: Chapter 7.2.4	FCC §15.107 class B limits §15.207 limits IC: Table 4, Chapter 7.2.4	--	--	Passed Remark 1
RECEIVER emissions radiated	Cabinet + Interconnecting cables	§15.109 §15.33 §15.35	RSS-132, Issue 2: 4.6 RSS-Gen, Issue 3: 6.1 RSS 133, Issue 5: 6.6	FCC 15.109 class B limits IC-limits: Table 1, Chapter 6	--	--	Passed Remark 1
RECEIVER Emissions 30-1000MHz conducted	Antenna terminal	§2.1051	RSS-Gen: 6.2 RSS132: 4.6 RSS133: 6.7(b)	43+10log(P) dBc IC: < 2 nW/4kHz < 5nW/4kHz (P > 1GHz)	--	--	Passed Remark 1

Remark: 1.) See separate test report TR6-0082-11-1-2c for measurements according Part 15, Subpart B.

ATTESTATION:

I declare that all measurements were performed by me or under my supervision and that all measurements have been performed and are correct to my best knowledge and belief to Industry Canada standards. All requirements as shown in above table are met in accordance with enumerated standards.

.....
Dipl.-Ing. W. Richter
Responsible for test section

GmbH
Im Teelbruch 116
45219 Essen
Tel.: + 49 (0) 20 54 / 95 19 - 0
Fax: + 49 (0) 20 54 / 95 19 - 007

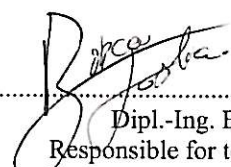
.....
Dipl.-Ing. B. Taslica
Responsible for test report

2. Administrative Data

2.1. Identification of the testing laboratory

Company name:	CETECOM GmbH
Address:	Im Teelbruch 116 45219 Essen - Kettwig Germany
Responsible for testing laboratory:	Dipl.-Ing. W. Richter
Deputy:	Dipl.-Ing. J. Schmitt
Laboratory accreditations/Listings:	DAkkS-Registration No. D-PL-12047-01-01 FCC-Registration No.: 736496, MRA US-EU 0003 IC-Registration No. 3462D-1, 3462D-2, 3462D-3 VCCI Reg. No. R-2665, R-2666, C-2914, T-1967, G-301

2.2. Test location

2.2.1. Test laboratory "CTC"

Company name:	see chapter 2.1. Identification of the testing laboratory
---------------	---

2.3. Organizational items

Order No.:	E600082001
Responsible for test report and project leader:	Dipl.-Ing. B. Taslica
Receipt of EUT:	2011-10-26
Date(s) of test:	2011-10-26- 2011-11-15
Date of report:	2011-11-23

Version of template:	11.10

2.4. Applicant's details

Applicant's name:	u-blox AG
Address:	Zürcherstrasse 68 8800 Thalwil Switzerland
Contact person:	Mr. Andreas Thiel

2.5. Manufacturer's details

Manufacturer's name:	please see Applicant's details
Address:	please see Applicant's details

3. Equipment under test (EUT)

3.1. Technical description of main EUT

Main function	E-GPRS/UMTS RF Module		
Type	RF data module		
GSM Frequency range (US/Canada -bands)	GSM 850: 824 – 849MHz (Uplink), 869-894MHz (Downlink) GSM1900: 1850-1910MHz (Uplink), 1930-1990MHz (Downlink)		
Type of modulation	GMSK/8-PSK		
Number of channels (USA/Canada -bands)	GSM 850: 128 – 251, 125 channels GSM1900: 512 – 810, 300 channels		
EMISSION DESIGNATOR(S)	247KGXW (GPRS850) 250KGXW (EDGE850) 247KG7W (GPRS1900) 256KG7W (EDGE 1900)		
Antenna Type	<input type="checkbox"/> Integrated <input type="checkbox"/> External, no RF- connector <input checked="" type="checkbox"/> External, separate RF-connector	Frequency range of antenna: 800MHz to 2200MHz	
Antenna Gain	<input checked="" type="checkbox"/> radiated: 3.0 dBi average gain		
MAX PEAK/AVERAGE Output Power (conducted): GPRS 850 EDGE 850	32.80 dBm (PK) / 32.67 dBm (AV) 30.11 dBm (PK) / 27.30 dBm (AV)		
MAX PEAK/AVERAGE Output Power (radiated): GPRS 850 EDGE850	26.80 dBm (PK) 26.20 dBm (PK)		
MAX PEAK/AVERAGE Output Power (conducted): GPRS 1900 EDGE 1900	30.45 dBm (PK) / 30.27 dBm (AV) 29.04 dBm (PK) / 26.47 dBm (AV)		
MAX PEAK/AVERAGE Output Power (radiated): GPRS 1900 EDGE 1900	26.30 dBm (PK) 27.20 dBm (PK)		
FCC-ID	XPYLISAU200		
IC	8595-LISAU200		
Installed options	<input checked="" type="checkbox"/> W-CDMA Band II and Band V (usable in USA/Canada)		
Power supply	<input checked="" type="checkbox"/> over AC/DC adaptor: 110V/60Hz <input checked="" type="checkbox"/> DC power 3.8 Volt (nominal)		
Special EMI components	--		
Lowest radio frequency signal	Master clock 26 MHz		
EUT sample type	<input type="checkbox"/> Production	<input checked="" type="checkbox"/> Pre-Production	<input type="checkbox"/> Engineering

3.2. EUT: Type, S/N etc. and short descriptions used in this test report

Short description*)	EUT	Type	S/N serial number	HW hardware status	SW software status
EUT A	RF Data-Module	LISA-U200	IMEI: 35890104000 1353	146001	21.03.00
EUT B	RF Data-Module	LISA-U200	IMEI: 35890104000 1734	146001	21.03.00
EUT C	Adapter Board	LISA-U200 FAE	SN095	IP02_HW_CS_ 150000	--
EUT D	Magnetic Mount Antenna	GA.107	#1	--	--

*) EUT short description is used to simplify the identification of the EUT in this test report.

3.3. Auxiliary Equipment (AE): Type, S/N etc. and short descriptions

AE short description *)	Auxiliary Equipment	Type	S/N serial number	HW hardware status	SW software status
AE 1	AC/DC adaptor (AC 110V/60Hz, DC 12 V)	0055 (Power supply connected on EUT B)	# 1	--	--

*) AE short description is used to simplify the identification of the auxiliary equipment in this test report.

3.4. EUT set-ups

EUT set-up no. *)	Combination of EUT and AE	Remarks
Set. 1	EUT A + EUT C + EUT D+ AE 1	Used for radiated tests
Set. 2	EUT A + EUT B	Used for conducted tests (power supply cables at EUT B for low, high and low voltage)
Set. 3	EUT B + EUT C+ EUT D+ AE 1	Used for radiated tests

*) EUT set-up no. is used to simplify the identification of the EUT set-up in this test report.

3.5. EUT operating modes

EUT operating mode no. *)	Description of operating modes	Additional information
op. 1	GPRS 850 TCH mode TCH=128/192/251	A communication link is established between the mobile station and the test simulator. The transmitter is operated at its maximum rated output power: 33 dBm (power class 4; power control level 5). USF_Duty CYCLE set to 100%, coding scheme CS-1 for GMSK modulation, slot 3 active, uplink gamma: 3 (33dBm). The input signal to the receiver is modulated with normal test modulation. The wanted RF input signal level to the receiver of the mobile station is set to a level to provide a stable communication link.
op. 2	EGPRS 850 TCH mode TCH=128/192/251	A communication link is established between the mobile station and the test simulator. The transmitter is operated at its maximum rated output power: 33 dBm (power class 4; power control level 5). USF_Duty CYCLE set to 100%, coding scheme MCS-5 for 8PSK modulation, slot 3 active, uplink gamma: 6 (27dBm). The input signal to the receiver is modulated with normal test modulation. The wanted RF input signal level to the receiver of the mobile station is set to a level to provide a stable communication link.
op. 3	GPRS 1900 TCH mode TCH=512/661/810	A communication link is established between the mobile station and the test simulator. The transmitter is operated at its maximum rated output power: 30 dBm (power class 1; power control level 0). USF_Duty CYCLE set to 100%, coding scheme CS-1 for GMSK modulation, slot 3 active, uplink gamma: 3 (30dBm). The input signal to the receiver is modulated with normal test modulation. The wanted RF input signal level to the receiver of the mobile station is set to a level to provide a stable communication link
op. 4	EGPRS 1900 TCH mode PCL=0 (max. power) TCH=512/661/810	A communication link is established between the mobile station and the test simulator. The transmitter is operated at its maximum rated output power: 30 dBm (power class 1; power control level 0). USF_Duty CYCLE set to 100%, coding scheme MCS-5 for 8-PSK modulation, slot 3 active, uplink gamma: 5 (26dBm). The input signal to the receiver is modulated with normal test modulation. The wanted RF input signal level to the receiver of the mobile station is set to a level to provide a stable communication link

*) EUT operating mode no. is used to simplify the test report.

3.6. Parameter Settings on mobile phone and base station CMU200

Following settings apply to the MS during the measurements in GPRS/(E)GPRS-Mode only:

Parameter	Traffic Mode	Idle Mode
Traffic Channels mobile station (EUT)	GSM 850 TCH _{MS} = 128/ 192 /251 GSM 1900 TCH _{MS} = 512 / 661 / 810	--
maximum power level (PCL)	GSM 850: PCL = 5 (2 Watt) GSM 1900: PCL = 0 (1 Watt)	--
Modulation	GPRS: GMSK-Modulation Scheme EDGE: 8-PSK Modulation Scheme	--
DTX	Off	--
Bitstream	PRBS 2E9-1 (pseudo-random-sequence) – CCITT 0.153	
Timeslot	3	
Hopping	Off	
Timeslot (slot mode)	GPRS/EDGE-Mode: maximum power on one uplink slot according MS class	
MS slot class	Class 8	
Maximum data transmission rate, single time slot	GPRS: 20,0 kbit/s Slot EDGE: 59,2 kbit/s Slot	
Speech transcoding (Traffic Mode)	Full rate Version 1	
Domain	Packet Switched(PS)	
Mode	BCCH and TCH	
BCCH – base station (CMU,CMD)		GSM 850: 182 GSM 1900: 651
TCH – base station (CMD, CMU)	auto	
Power level TCH – base station (used timeslot level)	- 70 dBm	
Power level BCCH – base station (control channel level)	- 80 dBm	
External attenuation RF/AF-Input/Output	Accord. calibration prior to measurements	
Mobile Country Code	310	310
BS_AG_BLKS_RES	Not applicable	0
Paging reorganisation		Off (0)
Signalling channel		SDCCH
Location Update		Auto
Cell access		Disabled (barred)

Settings for CMU (general)

Repetition	Continuous	
Stop condition	None	
Display mode	Max./Min	
Statistic Count	1000 Bursts	
Decoder	Standard	

Additional settings on the base stations CMU200 for frequency stability measurements

4. DESCRIPTION OF TEST SET-UP'S

4.1. GSM-Mode Test Set-up for conducted measurements

The EUT's RF-signal is coupled out by a suitable antenna coupling connector (1). The signal is first 10 dB attenuated (2) before it is 0° divided by a power divider (3). One of the signal path is connected to the communication base station (4), other branch is connected to the spectrum – analyzer (5). The specific attenuation losses for both signal paths/branches are determined prior to the measurement within a set-up calibration. These are then taken into account by correcting the measurement readings on the spectrum-analyzer.

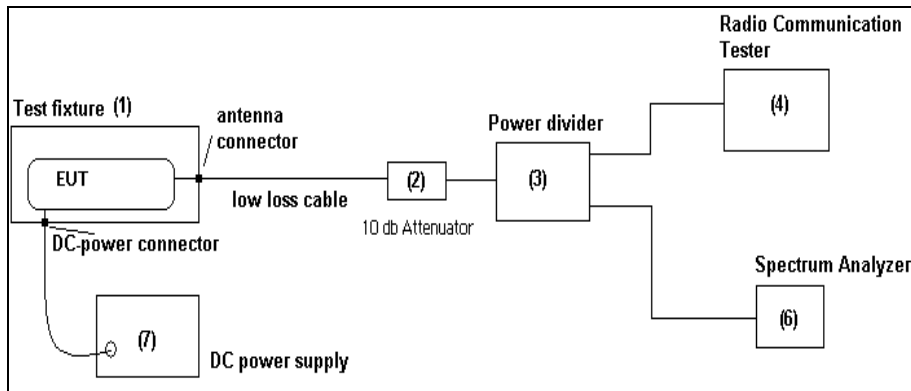

Schematic: Test set-up conducted

Following modified test set-up schematic apply for tests performed inside the climatic chamber: (Frequency stability)

In case an external connector is available (test fixture), following set-up is used for measurements.

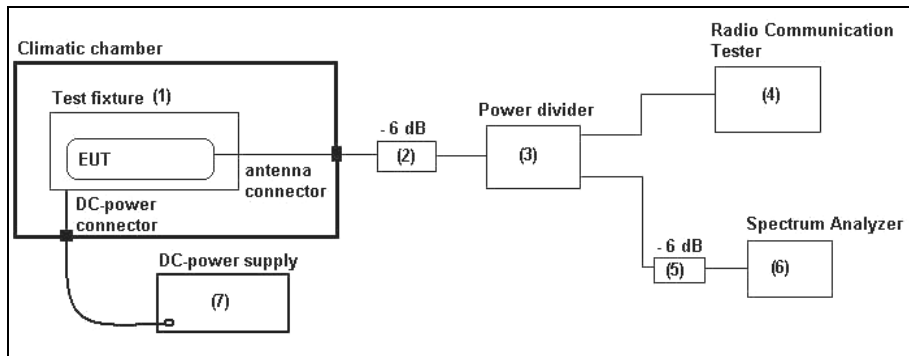

Schematic: Test set-up conducted within climatic chamber

4.2. Test set-up for radiated measurements

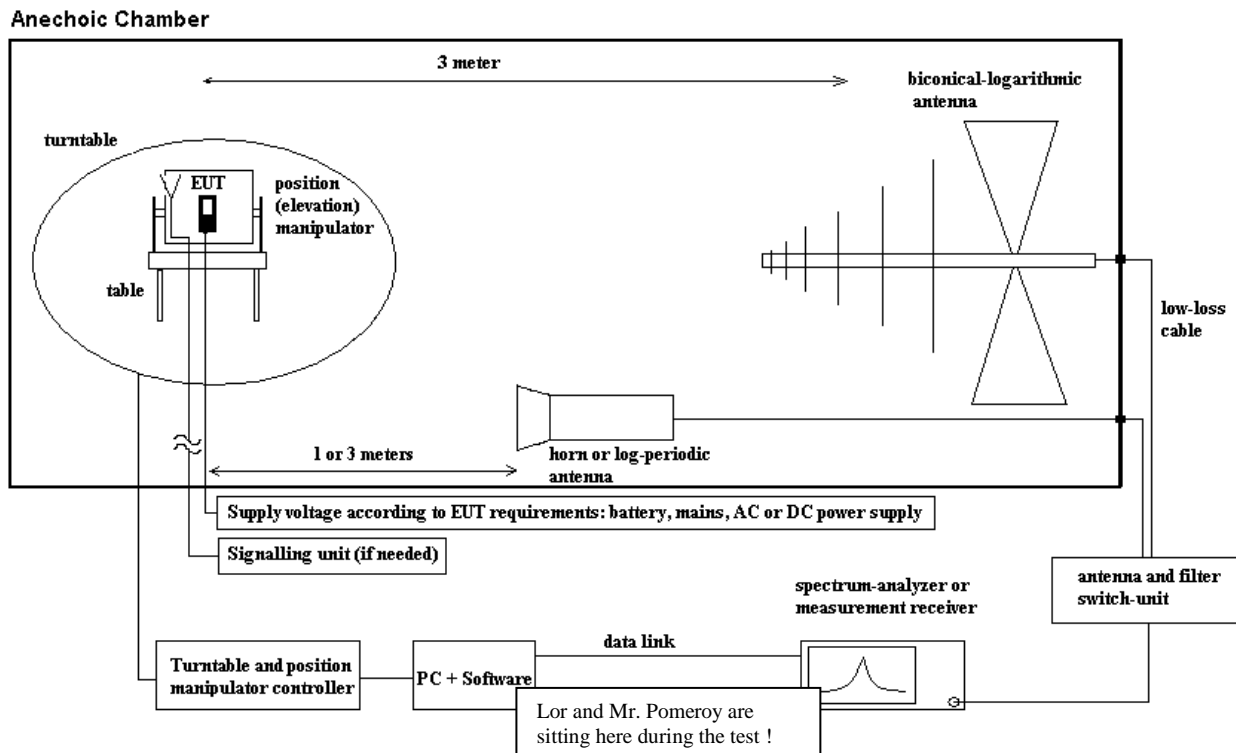

Schematic: radiated measurements test set-up

MEASUREMENT METHOD in the range 30 MHz to 1 GHz

An EMI receiver together with a broadband antenna was used in order to identify the emissions from the EUT by positioning the antenna close to the EUT surfaces. The interconnecting cables and equipment position were varied in order to maximize the emissions. Then most critical frequencies are recorded for further investigations. Based on the exploratory measurements, the most critical frequencies are re-measured by maintaining the EUT's operating mode, cable position, etc. The EUT was placed on a non-conductive support of 0.8 m height. By rotating the turntable angle in the range 0 to 360 degree, the EUT itself either over 3-orthogonal axis (not defined usage position) or 2-orthogonal axis (defined usage position) and the measurement antenna height from 1 meter to 4 meters, the maximized emissions are recorded. The measurements are performed for both polarizations of the measuring antenna: horizontal and vertical.

MEASUREMENT METHOD in the range 1 GHz to 26.5 GHz or 40 GHz):

The EUT and accessories are placed on a non-conducting tipping table of 0.8 meter height (semi-anechoic chamber) or 1.55m height (fully-anechoic chamber) which is situated in the middle of the turntable. The turntable can rotate the device under test 360 degree, the tipping table can rotate the device from laid to standing position. This way the device under test can be rotated in all three orthogonal planes in order to maximize the detected emissions. The turn- and tipping table are controlled by a controller unit. All positions manipulations are software controlled from an operator PC.

The measurements are performed for both receiving antenna polarisations: vertical and horizontal.

Up to 18 GHz a measurement distance of 3 meters is used, above 18 GHz the distance is 1 meter. A logarithmic-periodic antenna for frequencies above 1 GHz up to 26.5 GHz is used. For frequencies above 26.5 GHz a horn antenna is used, pls. compare the equipment list for more details.

The EUT is powered either by an external DC-supply with nominal voltage or an AC/DC power supply as accessory. The communication signalling (if necessary for operation) is performed from outside the chamber with a communication test simulator (CMU200 from Rohde&Schwarz) and a signalling antenna place near the EUT.

5. Measurements

5.1. Conducted emissions on AC-Power lines

5.1.1. Test location and equipment (for reference numbers please see chapter 'List of test equipment')

test location	<input checked="" type="checkbox"/> CETECOM Essen (Chapter 2.2.1)	<input type="checkbox"/> Please see Chapter 2.2.2		<input type="checkbox"/> Please see Chapter 2.2.3	
test site	<input type="checkbox"/> 333 EMI field	<input checked="" type="checkbox"/> 348 EMI cond.			
receiver	<input type="checkbox"/> 001 ESS	<input checked="" type="checkbox"/> 377 ESCS 30			
LISN	<input checked="" type="checkbox"/> 005 ESH2-Z5	<input type="checkbox"/> 007 ESH3-Z6	<input type="checkbox"/> 300 ESH3-Z5 & 50Ω used for AE	<input type="checkbox"/> no LISN for AE	
signaling	<input type="checkbox"/> 392 MT8820A	<input type="checkbox"/> 436 CMU	<input type="checkbox"/> 547 CMU		
line voltage	<input type="checkbox"/> 230 V 50 Hz via public mains		<input checked="" type="checkbox"/> 060 110 V 60 Hz via PAS 5000		

TEST CONDITION AND MEASUREMENT PROCEDURES TEST SET-UP

link to test system (if used):	<input type="checkbox"/> air link	<input type="checkbox"/> cable connection	<input type="checkbox"/>
EUT-grounding	<input type="checkbox"/> none	<input type="checkbox"/> with power supply	<input type="checkbox"/> additional connection
Equipment set up	<input checked="" type="checkbox"/> table top (40 cm distance to reference ground plane (wall))		<input type="checkbox"/> floor standing EUT stands isolated on reference ground plane (floor)
Climatic conditions	Temperature: (22±3°C)		Rel. humidity: (40±20)%
EMI-Receiver (Analyzer) Settings	Frequency Range: 150 kHz to 30 MHz RBW: 9 kHz		

Devices which can be connected to the public AC-power network, should be tested against the radio frequency voltage conducted back into the AC-power line in the frequency range 150kHz to 30 MHz. Compliance should be tested by measuring the radio frequency voltage between each power line and ground at the power terminals in the stated frequency range.

A 500hm/50µH line impedance stabilization network (LISN) is used therefore. The EUT power input leads are connected through the LISN to the AC-power source. The LISN enclosure is electrically connected to the GND-plane. The measuring instrument is connected to the coaxial output of the LISN.

Tabletop devices were set-up on a 80 cm height over reference ground plane, floor standing equipment 10 cm raised above ground plane.

Measurements have been performed on each phase line and neutral line of the devices AC-power lines. The EUT was power supplied with 110 V/60Hz.

The EUT was tested in the defined operating mode and installed (connected) to accessory equipment according the general description of use given by the applicant.

Preliminary testing as a first step, determines the worst-case phase line (neutral or phase) as well as the most critical amplitude by changing the operating mode. A complete frequency-sweep is performed with PK-Detector.

Final testing for power phases and critical frequencies (Margin to AV- or QP limit lower than 3dB) as a second step includes measurements either on discrete frequency components with receivers detector set to Quasi-Peak and Average per frequency component or a complete frequency sweep with corresponding detector according to ANSI 63.4, CISPR 16.

MEASUREMENT RESULTS

EUT Type and S/N or EUT set-up no.		EUT set-up 3				
Diagram No.	EUT operating mode no. or comment	Used Detector	Power line	Limit Class	Additional (scan-) information	Result
a_1.2	EUT operating mode 1 (ARFCN 128)	<input type="checkbox"/> Peak <input checked="" type="checkbox"/> CAV <input checked="" type="checkbox"/> QP	L1/ N	<input type="checkbox"/> A <input checked="" type="checkbox"/> B	The Diagram shows QP/CAV detector measurements on L1 and N with maxhold mode.	passed
a_1.3	EUT operating mode 1 (ARFCN 192)	<input type="checkbox"/> Peak <input checked="" type="checkbox"/> CAV <input checked="" type="checkbox"/> QP	L1/ N	<input type="checkbox"/> A <input checked="" type="checkbox"/> B	The Diagram shows QP/CAV detector measurements on L1 and N with maxhold mode.	passed
a_1.4	EUT operating mode 1 (ARFCN 251)	<input type="checkbox"/> Peak <input checked="" type="checkbox"/> CAV <input checked="" type="checkbox"/> QP	L1/ N	<input type="checkbox"/> A <input checked="" type="checkbox"/> B	The Diagram shows QP/CAV detector measurements on L1 and N with maxhold mode.	passed
a_1.5	EUT operating mode 2 (ARFCN 512)	<input type="checkbox"/> Peak <input checked="" type="checkbox"/> CAV <input checked="" type="checkbox"/> QP	L1/ N	<input type="checkbox"/> A <input checked="" type="checkbox"/> B	The Diagram shows QP/CAV detector measurements on L1 and N with maxhold mode. Final measurement QP and AV was carried out on at least one frequency	passed
a_1.6	EUT operating mode 2 (ARFCN 661)	<input type="checkbox"/> Peak <input checked="" type="checkbox"/> CAV <input checked="" type="checkbox"/> QP	L1/ N	<input type="checkbox"/> A <input checked="" type="checkbox"/> B	The Diagram shows QP/CAV detector measurements on L1 and N with maxhold mode. Final measurement QP and AV was carried out on at least one frequency	passed
a_1.7	EUT operating mode 2 (ARFCN 810)	<input type="checkbox"/> Peak <input checked="" type="checkbox"/> CAV <input checked="" type="checkbox"/> QP	L1/ N	<input type="checkbox"/> A <input checked="" type="checkbox"/> B	The Diagram shows QP/CAV detector measurements on L1 and N with maxhold mode. Final measurement QP and AV was carried out on at least one frequency	passed

Remarks:

For more information please see diagrams enclosed in the annex to this Report.

Positive margin means passed result.

Margin to Limit for verdict: $M = L_T - R_R + C_{Loss}$

Abbreviations used:

- R_R : Receiver readings in dB μ V
- C_{Loss} : cable loss
- L_T : Limit in dB μ V

VERDICT

Summary of measurement results for conducted emissions on AC-Power lines: Passed

5.2. Radiated field strength emissions below 30 MHz

5.2.1. Test location and equipment (for reference numbers please see chapter 'List of test equipment')

test location	<input checked="" type="checkbox"/> CETECOM Essen (Chapter. 2.2.1)	<input type="checkbox"/> Please see Chapter. 2.2.2	<input type="checkbox"/> Please see Chapter. 2.2.3
test site	<input checked="" type="checkbox"/> 441 EMI SAR	<input type="checkbox"/> 487 SAR NSA	<input type="checkbox"/> 347 Radio.lab.
receiver	<input type="checkbox"/> 377 ESCS30	<input checked="" type="checkbox"/> 001 ESS	<input type="checkbox"/>
spectr. analys.	<input type="checkbox"/> 584 FSU	<input type="checkbox"/> 120 FSEM	<input type="checkbox"/> 264 FSEK
antenna	<input type="checkbox"/> 574 BTA-L	<input type="checkbox"/> 133 EMCO3115	<input type="checkbox"/> 302 BBHA9170
signaling	<input type="checkbox"/> 392 MT8820A	<input type="checkbox"/> 436 CMU	<input type="checkbox"/> 547 CMU
otherwise	<input type="checkbox"/> 400 FTC40x15E	<input type="checkbox"/> 401 FTC40x15E	<input type="checkbox"/> 110 USB LWL
DC power	<input type="checkbox"/> 456 EA 3013A	<input type="checkbox"/> 457 EA 3013A	<input type="checkbox"/> 459 EA 2032-50
line voltage	<input type="checkbox"/> 230 V 50 Hz via public mains	<input checked="" type="checkbox"/> 060 110 V 60 Hz	via PAS 5000

STANDARDS AND LIMITS: CFR 47, §15.205, §15.209, RSS-Gen

Frequency [MHz]	Field strength		Measurement distance [meters]	Remarks
	[µV/m]	[dBuV/m]		
0.009 – 0.490	2400/f (kHz)	67.6 – 20Log(f) (kHz)	300	Correction factor used due to measurement distance of 3m
0.490 – 1.705	24000/f (kHz)	87.6 – 20 Log(f) (kHz)	30	Correction factor used due to measurement distance of 3m
1.705 – 30	30	29.54	30	Correction factor used due to measurement distance of 3m

Remark: * decreases with the logarithm of the frequency

TEST CONDITION AND MEASUREMENT TEST SET-UP

link to test system (if used):	<input type="checkbox"/> air link	<input type="checkbox"/> cable connection	<input type="checkbox"/>
EUT-grounding	<input type="checkbox"/> none	<input type="checkbox"/> with power supply	<input type="checkbox"/> additional connection
Equipment set up	<input checked="" type="checkbox"/> table top	<input type="checkbox"/> floor standing	
Climatic conditions	Temperature: (22±3°C)	Rel. humidity: (40±20)%	
EMI-Receiver (Analyzer) Settings	Span/Range: 9kHz to 150kHz; 150 kHz to 30 MHz RBW/VBW: 200Hz/auto; 10 kHz/ auto (ANSI63.10/CISPR#16) Detector/ Mode: PEAK, TRACE max-hold mode, repetitive scan for exploratory measurements Quasi-Peak, for final measurement on critical frequencies (f<1GHz)		

GENERAL MEASUREMENT PROCEDURES:

The measurement test set-up and test procedure are in accordance with the provisions described in ANSI 63.10: 2009

The **Equipment under Test (EUT)** was set-up to defined operating mode and installed (connected) to accessory equipment according the general description of use given by the applicant.

The measurement loop antenna was situated in 3m distance to the EUT. Between EUT and measurement antenna absorbers are covering the GND-Plane. With these absorbers the chamber fulfills CIPR16-1-4 site VSWR-criteria. Radiated magnetic emission measurements were made with the antenna situated in 1 meter height. The loop antenna was moved at least to 2-perpendicular axes (antenna vector in direction of EUT and parallel to EUT) in order to maximize the emissions, the EUT itself either over 3-orthogonal axes (no defined usage position) or 2-orthogonal axis (defined usage position) by the position manipulator.

According the standard the compliance should be checked in 30m and 300m measurement distance. Therefore a additional extrapolation factor was used in order to normalize the measurement data. The frequency dependent extrapolation factor used for this reduced measurement distance, can be found on page 16.

MEASUREMENT RESULTS

Due to uncritical measurements (only noise floor) measurements have been performed only in E-GPRS Mode.

Set-up No.		3								
Operating Mode		2								
Diagram no.	Frequency (MHz)	MaxPeak (dBμV/m)	Meas. Time (ms)	Bandwidth (kHz)	Antenna height (cm)	Polarity	Turntable position (deg)	Corr. (dB) (C _F)	Margin (dB) (M)	Limit (dBμV/m) (L _T)
a_3.05 (mid. ch.)	Same settings (see below)	See diagram	10	Same settings (see below)	100	--	0°..360°	Same settings (see below)	See diagram	
a_3.06 (high ch.)										
a_3.04 (low channel)	0.009 to 0.150	<-55	10	0.2	100	--	0°..360°	300 to 3m	>20	See diagram
	0.150 to 0.5	-66.63		10				300 to 3m	>20	
	0.5 to 30	19.23		10				300 to 3m 30 to 3m	10.31	

Remark: Selected worst-case measurement to the closest limit of EDGE mode. Please see the other measured channels as diagrams in the separate annex.

Set-up No.		3								
Operating Mode		4								
Diagram no.	Frequency (MHz)	MaxPeak (dBμV/m)	Meas. Time (ms)	Bandwidth (kHz)	Antenna height (cm)	Polarity	Turntable position (deg)	Corr. (dB) (C _F)	Margin (dB) (M)	Limit (dBμV/m) (L _T)
a_3.01 (low. ch.)	Same settings (see below)	See diagram	10	Same settings (see below)	100	--	0°..360°	Same settings (see below)	See diagram	
a_3.02 (mid. ch.)										
a_3.03 (high channel)	0.009 to 0.150	<-55	10	0.2	100	--	0°..360°	300 to 3m	>20	See diagram
	0.150 to 0.5	<-60		10				300 to 3m	>20	
	0.5 to 30	20.41		10				300 to 3m 30 to 3m	9.13	

Remark: Selected worst-case measurement to the closest limit of EDGE mode. Please see the other measured channels as diagrams in the separate annex.

<p>Margin to Limit:</p> $M = L_T - R_R + C_F + D_F$ $= L_T - R_R + (AF_{ANTENNA} + Cable_{LOSS}) + D_F$	<p>Abbreviations used:</p> <ul style="list-style-type: none"> • R_R : Receiver readings in dBμV/m • C_F: Transducer in dB = AF (antenna factor) + CL (cable loss) • D_F: distance correction factor (if different measurement distance used than specified in the standard) • L_T : Limit in dBμV/m
--	--

VERDICT: Summary of measurement results for radiated frequencies below 30 MHz - Passed

5.3. Occupied and emission bandwidth

5.3.1. Test location and equipment (for reference numbers please see chapter 'List of test equipment')

test location	<input checked="" type="checkbox"/> CETECOM Essen (Chapter. 2.2.1)	<input type="checkbox"/> Please see Chapter. 2.2.2	<input type="checkbox"/> Please see Chapter. 2.2.3
test site	<input type="checkbox"/> 441 EMI SAR	<input type="checkbox"/> 487 SAR NSA	<input type="checkbox"/> 337 OATS <input checked="" type="checkbox"/> 347 Radio.lab.
receiver	<input type="checkbox"/> 377 ESCS30	<input type="checkbox"/> 001 ESS	<input checked="" type="checkbox"/> 489 ESU
otherwise	<input checked="" type="checkbox"/> 530 10dB Attenuator		<input checked="" type="checkbox"/> cable K15

5.3.2. References of occupied and emission bandwidth

FCC: §2.202, §2.1049, §22.917(a), §24.238(a)

IC: RSS-Gen: 4.6.1

„the **occupied bandwidth** is the frequency bandwidth, such that, below it lower and above it upper frequency limits, the mean powers radiated are each equal to 0.5 percent of the total mean power radiated”

Test Set-up

- see conducted measurement set-up described in 4.1

Mobile phone settings

- Provisions with the requirements is based on the fact, that GSM modulation scheme is GMSK Modulation for GSM equipment with a maximum data transmission rate of 17,6 kBit/s per Slot.
- Provisions with the requirements is based on the fact, that EDGE modulation scheme is 8-PSK Modulation for EDGE equipment with a maximum data transmission rate of 69,2 kBit/s per Slot.
- a call was established with settings according chapter 3.7

Settings of the Spectrum-Analyser

Frequency range	RBW (resolution bandwidth)	VBW (video bandwidth)
1 MHz around carrier frequency	1% from applicants stated/measured emission bandwidth	3..10 times the RBW

Test method

The measurements were made at the upper, middle and lower carrier traffic frequencies of the operating band. Choosing three TX-carrier frequencies of the mobile phone within each operable GSM band, should be sufficient to demonstrate compliance

Additionally the emission bandwidth (-26 dBc bandwidth) was recorded for all three channels. The results were taken in order to determine according the §24.238 the measurement resolution bandwidth, which should be approximately 1% of the emission bandwidth.

Results

Set-up 2, Op-Mode 1

Channel/ Frequency (MHz)	Occupied 99% bandwidth [kHz]	Emission bandwidth [kHz]
GPRS 850	Channel 128/ 824.2 MHz	246.79
	Channel 192/ 837.0 MHz	243.59
	Channel 251/ 848.8 MHz	243.59

Remarks: see annex A1 for diagrams

Set-up 2, Op-Mode 2

Channel/ Frequency (MHz)	Occupied 99% bandwidth [kHz]	Emission bandwidth [kHz]
EGPRS 850	Channel 128/ 824.2 MHz	250.0
	Channel 192/ 837.0 MHz	250.0
	Channel 251/ 848.8 MHz	248.4

Remarks: see annex A1 for diagrams

Set-up 2, Op-Mode 3

Channel/ Frequency (MHz)		Occupied 99% bandwidth [kHz]	Emission bandwidth [kHz]
GPRS 1900	Channel 512/ 1850.2 MHz	240.38	312.50
	Channel 661/ 1880.0 MHz	246.79	317.31
	Channel 810/ 1909.8 MHz	245.19	314.10

Remarks: see annex A1 for diagrams

Set-up 2, Op-Mode 4

Channel/ Frequency (MHz)		Occupied 99% bandwidth [kHz]	Emission bandwidth [kHz]
EGPRS 1900	Channel 512/ 1850.2 MHz	250.00	323.72
	Channel 661/ 1880.0 MHz	246.79	317.31
	Channel 810/ 1909.8 MHz	250.00	317.31

Remarks: see annex A1 for diagrams

VERDICT: Passed

5.4. RF Peak power output conducted

5.4.1. Test location and equipment (for reference numbers please see chapter 'List of test equipment')

test location	<input checked="" type="checkbox"/> CETECOM Essen (Chapter. 2.2.1)	<input type="checkbox"/> Please see Chapter. 2.2.2	<input type="checkbox"/> Please see Chapter. 2.2.3
test site	<input type="checkbox"/> 441 EMI SAR	<input type="checkbox"/> 487 SAR NSA	<input type="checkbox"/> 347 Radio.lab.
receiver	<input type="checkbox"/> 377 ESCS30	<input type="checkbox"/> 001 ESS	<input type="checkbox"/> 489 ESU 40
spectr. analys.	<input type="checkbox"/> 584 FSU	<input type="checkbox"/> 120 FSEM	<input type="checkbox"/> 264 FSEK
antenna	<input type="checkbox"/> 574 BTA-L	<input type="checkbox"/> 133 EMCO3115	<input type="checkbox"/> 302 BBHA9170
signaling	<input type="checkbox"/> 392 MT8820A	<input checked="" type="checkbox"/> 436 CMU	<input type="checkbox"/> 547 CMU
otherwise	<input type="checkbox"/> 400 FTC40x15E	<input type="checkbox"/> 401 FTC40x15E	<input type="checkbox"/> 110 USB LWL
DC power	<input type="checkbox"/> 456 EA 3013A	<input checked="" type="checkbox"/> 463 HP3245A	<input type="checkbox"/> 459 EA 2032-50
otherwise	<input type="checkbox"/> 331 HC 4055	<input checked="" type="checkbox"/> 248 6 dB Attenuator	<input type="checkbox"/> 529 Power divider
line voltage	<input type="checkbox"/> 230 V 50 Hz via public mains		<input type="checkbox"/> 060 110 V 60 Hz via PAS 5000

Standards and References

FCC: §2.1046 (conducted), §22.913(a)(2), § 24.232(c)

IC: RSS-132:4.4 + SRSP 503:5.1.3 for GSM 850; RSS-133:4.1/6.4 + SRSP-510:5.1.2 for GSM 1900

- Maximum Power Output of the mobile phone should be determined while measured conducted E(IRP).
- Limit GSM850: 7 Watt
- Limit GSM1900: 2 Watt

Test condition and measurement test set-up

link to test system (if used):	<input type="checkbox"/> air link	<input checked="" type="checkbox"/> cable connection	<input type="checkbox"/>
Climatic conditions	Temperature: (22±3°C)		Rel. humidity: (40±20)%

TEST SET-UP (CONDUCTED)

- see conducted measurement set-up, description in chapter 4.1
- a suitable artificial antenna or RF-connector is provided by the applicant in order to perform the conducted measurements. Any data provided with the artificial antenna or connector, have been taken in account in order to correct the measurement data. (0.3dB for attenuation of antenna connector)

MOBILE PHONE SETTINGS

- according chapter 3.6

BASE STATION SETTING

- according 3.6 chapter

RESULTS (CONDUCTED)

Op. Mode 1, Set-up 2

Channel/ Frequency (MHz)		Peak Output Power (dBm)	Average Output Power (dBm)
GPRS 850	Channel 128/ 824.2 MHz	32.79	32.57
	Channel 192/ 837.0 MHz	32.79	32.60
	Channel 251/ 848.8 MHz	32.80	32.67

Op. Mode 2, Set-up 2

Channel/ Frequency (MHz)		Peak Output Power (dBm)	Average Output Power (dBm)
E-GPRS 850	Channel 128/ 824.2 MHz	29.92	27.13
	Channel 192/ 837.0 MHz	29.98	27.22
	Channel 251/ 848.8 MHz	30.11	27.30

Op. Mode 3, Set-up 2

Channel/ Frequency (MHz)		Peak Output Power (dBm)	Average Output Power (dBm)
GPRS 1900	Channel 512/ 1850.2 MHz	30.45	30.27
	Channel 661/ 1880.0 MHz	30.32	30.14
	Channel 810/ 1909.8 MHz	30.32	30.15

Op. Mode 4, Set-up 2

Channel/ Frequency (MHz)		Peak Output Power (dBm)	Average Output Power (dBm)
E-GPRS 1900	Channel 512/ 1850.2 MHz	29.04	26.47
	Channel 661/ 1880.0 MHz	28.95	26.36
	Channel 810/ 1909.8 MHz	28.94	26.37

VERDICT: Passed

5.5. RF Peak power output radiated

5.5.1. Test location and equipment (for reference numbers please see chapter 'List of test equipment')

test location	<input checked="" type="checkbox"/> CETECOM Essen (Chapter. 2.2.1)	<input type="checkbox"/> Please see Chapter. 2.2.2	<input type="checkbox"/> Please see Chapter. 2.2.3
test site	<input type="checkbox"/> 441 EMI SAR	<input type="checkbox"/> 487 SAR NSA	<input type="checkbox"/> 347 Radio.lab. <input checked="" type="checkbox"/> 443 FAR
receiver	<input type="checkbox"/> 377 ESCS30	<input type="checkbox"/> 001 ESS	<input checked="" type="checkbox"/> 489 ESU 40
spectr. analys.	<input type="checkbox"/> 584 FSU	<input type="checkbox"/> 120 FSEM	<input type="checkbox"/> 264 FSEK
antenna	<input type="checkbox"/> 574 BTA-L	<input type="checkbox"/> 133 EMCO3115	<input type="checkbox"/> 302 BBHA9170 <input checked="" type="checkbox"/> 608 HL 562 <input checked="" type="checkbox"/> 549 HL025 <input type="checkbox"/> 477 GPS
signaling	<input type="checkbox"/> 392 MT8820A	<input type="checkbox"/> 436 CMU	<input checked="" type="checkbox"/> 546 CMU
otherwise	<input type="checkbox"/> 400 FTC40x15E	<input type="checkbox"/> 401 FTC40x15E	<input type="checkbox"/> 110 USB LWL <input type="checkbox"/> 482 Filter Matrix <input type="checkbox"/> 378 RadiSense
DC power	<input type="checkbox"/> 456 EA 3013A	<input checked="" type="checkbox"/> 463 HP3245A	<input type="checkbox"/> 459 EA 2032-50 <input type="checkbox"/> 268 EA- 3050 <input type="checkbox"/> 494 AG6632A <input type="checkbox"/> 498 NGPE 40
otherwise	<input type="checkbox"/> 331 HC 4055	<input type="checkbox"/> 248 6 dB Attenuator	<input type="checkbox"/> 529 Power divider <input type="checkbox"/> - cable OTA20
line voltage	<input type="checkbox"/> 230 V 50 Hz via public mains <input type="checkbox"/> 060 110 V 60 Hz via PAS 5000		

REFERENCES

FCC: §2.1046 (conducted), §22.913(a)(2), § 24.232(c)

IC: RSS-132:4.4 + SRSP 503:5.1.3 for GSM 850; RSS-133:4.1/6.4 + SRSP-510:5.1.2 for GSM 1900

- Maximum Power Output of the mobile phone should be determined while measured radiated E(I)RP.
- Limit GSM850: 7 Watt
- Limit GSM1900: 2 Watt

Test condition and measurement test set-up

link to test system (if used):	<input type="checkbox"/> air link	<input type="checkbox"/> cable connection	<input type="checkbox"/>
Climatic conditions	Temperature: (22±3°C)		Rel. humidity: (40±20)%

MOBILE PHONE SETTINGS

- according to chapter 3.6

BASE STATION SETTING

- according to chapter 3.6

5.5.2. RADIATED RF-POWER

TEST METHOD

- 1.) The measurements were made at the upper, middle and lower carrier traffic frequencies of the operating band. Choosing three TX-carrier frequencies of the mobile phone within each operable GSM band, should be sufficient to demonstrate compliance.
- 2.) The measurements were performed with the integrated power measurement function of the „radio communication tester CMU200 from Rohde&Schwarz company. In this way spectrum-analyzers instrument limitations can be avoided or minimized. Instead, CMU manufacturers declared measurement error can be considered for this measurement.
- 3.) The attenuation (insertion loss) at the RF Inputs/Outputs of CMU were set according to the path loss of the test set-up, determined in a step before starting the measurements.
- 4.) PK and Average Values have been recorded for each channel and band.

The measurements were made at the upper, center, and lower carrier traffic frequencies of each of the supported operating band. Choosing three TX-carrier frequencies of the mobile phone, should be sufficient to demonstrate compliance.

The measurements were performed by using the **substitution method** (ANSI/TIA/EIA 603) with a spectrum-analyzer. This method can be described like follows:

1. choosing of suitable spectrum-analyzer settings for performing the measurements. This settings of the spectrum analyzer must be maintained for both stages of the measurements: EUT emission measurements and also for measurements of the substituted level.

Parameter	Setting for GSM measurements	Settings for UTRA/FDD measurements
RBW _{3dB}	3 MHz	10 MHz
VBW	10 MHz	10 MHz
Span	20 MHz	50 MHz
Detector Mode	Positive max-hold	Positive max-hold
Average	off	off
Sweep Time	coupled	coupled

2. The maximum level of the peak power was recorded, while the emissions were maximized by rotating the EUT in three orthogonal axes, which was situated on a non-conductive turntable of 1.55 m height ($P_{MEAS,1}$). This was performed for both measuring antenna polarisations (vertical/horizontal), the maximum of both values is used for further measurements and final substitution ($P_{MEAS, 1, MAX}$).
3. As the maximum emission is recorded, the EUT is replaced by a frequency dependant suitable antenna, which is connected to a RF-signal generator, which is transmitting on the determined worst-case frequency as determined in step 2.
4. The RF-signal level of the signal generator is adjusted as long the same worst-case level determined first step is measured at the spectrum analyzer ($P_{SMHU}=P_{MEAS,1, MAX}$)
5. Than the RF-signal cable is disconnected from the antenna and connected to a power-level meter. The level is determined ($P_{MEAS,2}$).
6. The final result is calculated by adding the ERP/EIRP gain of the antenna which substitutes the EUT.
 $P_{EUT,SUBST} = P_{MEAS,2} + G_{ANTENNA}$

G850 RESULTS (RADIATED)

Channel/ Frequency (MHz) (SET-up 1)		Peak Output Power (dBm)		Antenna Polarisation for maximum Power	Verdict	
		PK	AV			
GPRS 850	Channel 128/ 824.2 MHz	26.8	1.)	ERP-Value	V/H	Passed
	Channel 192/ 837.0 MHz	26.7				
	Channel 251/ 848.8 MHz	26.2				
E-GPRS 850	Channel 128/ 824.2 MHz	25.3	1.)	ERP-Value	V/H	Passed
	Channel 192/ 837.0 MHz	26.2				
	Channel 251/ 848.8 MHz	26.1				

Remark: 1.) see conducted measurements for PAR factor

PCS 1900 RESULTS (RADIATED)

Channel/ Frequency (MHz) (SET-up 1)		Peak Output Power (dBm)		Antenna Polarisation for maximum Power	Verdict	
		PK	AV			
GPRS 1900	Channel 512/ 1850.2 MHz	25.7	1.)	EIRP-Value	V/H	Passed
	Channel 661/ 1880.0 MHz	26.3				
	Channel 810/ 1909.8 MHz	26.2				
E-GPRS 1900	Channel 512/ 1850.2 MHz	26.9	1.)	EIRP-Value	V/H	Passed
	Channel 661/ 1880.0 MHz	27.2				
	Channel 810/ 1909.8 MHz	25.6				

Remark: 1.) see conducted measurements for PAR factor

5.6. Radio Frequency Exposure Evaluation

References:

The criteria used for the evaluation of human exposure to radio frequency radiation is table 1 according FCC §1.1310 and table chapter 4.2 of RSS-102 standard and it is subject for evaluation of the RF exposure prior to equipment authorization.

§2.1091: Further information on evaluating compliance with these limits can be found in the FCC’s OST/OET Bulletin Number 65, ‘Evaluating Compliance with FCC-Specified Guidelines for Human Exposure to Radiofrequency Radiation.’

For purposes of these requirements mobile devices are defined by the FCC as transmitters designed to be used in other than fixed locations and to generally be used in such a way that a separation distance of at least 20 centimeters is normally maintained between radiating structures and the body of the user or nearby persons. These devices are normally evaluated for exposure potential with relation to the MPE limits given in Table 1 of Appendix A.

§24.232

(a) Base stations are limited to 1640 watts peak equivalent isotropically radiated power (e.i.r.p.) with an antenna height up to 300 meters HAAT.

b) Mobile/portable stations are limited to 2 watts e.i.r.p. peak power, ...

§22.913

(a) Maximum ERP. The effective radiated power (ERP) of base transmitters and cellular repeaters must not exceed 500 Watts. The ERP of mobile transmitters and auxiliary test transmitters must not exceed 7 Watts.

TABLE 1—LIMITS FOR MAXIMUM PERMISSIBLE EXPOSURE (MPE)—Continued

Frequency range (MHz)	Electric field strength (V/m)	Magnetic field strength (A/m)	Power density (mW/cm ²)	Averaging time (minutes)
30–300	61.4	0.163	1.0	6
300–1500	f/300	6
1500–100,000	5	6
(B) Limits for General Population/Uncontrolled Exposure				
0.3–1.34	614	1.63	*(100)	30
1.34–30	824/f	2.19/f	*(180/f ²)	30
30–300	27.5	0.073	0.2	30
300–1500	f/1500	30
1500–100,000	1.0	30

f = frequency in MHz

Table 1: LIMITS FOR MAXIMUM PERMISSIBLE EXPOSURE (MPE)

For given Power density limit at a single frequency (accord. Table 1 Limits) the maximum antenna gain can be calculated:

The used equation to predict the power density in the far-field of one single radiating antenna can be made by following equation:

$$S = \frac{EIRP}{4\pi R^2} = \frac{P * G}{4\pi R^2}$$

$$G_{NUMERIC} = \frac{S * 4\pi R^2}{P}$$

Abbreviations:

- S: Power density (unit: mW/cm²)
- P: Power Input to the antenna
- G: Gain of the antenna relative to an isotropic radiator,
- EIRP: Equivalent isotropically radiated power, determined within a separate measurement (unit: mW)
- R: distance to the center of the radiation of the antenna (unit: cm)

General Limits:

§1.1307

Cellular Radiotelephone Service (subpart H of part 22)

Non-building-mounted antennas: height above ground level to lowest point of antenna < 10 m and total power of all channels > 1000 W ERP (1640 W EIRP)

§1.1307

Personal Communications Services (part 24)

Broadband PCS (subpart E): non-building-mounted antennas: height above ground level to lowest point of antenna < 10 m and total power of all channels > 2000 W ERP (3280 W EIRP)

§1.1310 LIMITS FOR MAXIMUM PERMISSIBLE EXPOSURE (MPE)

Table 1(B) Limits for General Population/Uncontrolled Exposure

300–1500 MHz: $f/1500$ mW/cm²

1500–100,000 MHz: 1.0 mW/cm²

§2.1091

Subject to routine evaluation is required when the device operate at frequencies of 1.5 GHz or below and their effective radiated power (ERP) is 1.5 watts or more, or if they operate at frequencies above 1.5 GHz and their ERP is 3 watts or more.

RSS-102

Standard requires the RF-exposure value in W/m² unit., therefore the value determined in mW/cm² unit should be multiplied by 10 to have the required unit.

METHOD: The RF-exposure values were derived from the measured conducted Peak Power with assumed antenna gain of 0dBi. The gain does not include path losses of interconnecting cables between RF-delivering output port and antenna gain. Typical path losses are 0.7 to 1.5 dB per meter depending of cable quality.

The power was checked on 3 frequencies (lowest/middle/highest) within each operable GPRS/(E)GPRS-band. Please refer to chapter 4.1 for the measurement set-up.

A correction factor of $10 \cdot \log_{10}(\text{number of possible active slots}/8 \text{ slots})$ for GPRS/E-GPRS can be applied, as result was used here and further details of the calculation see in the table mentioned-below at the next page.

5.6.1. General result for fixed GSM operations with assumed 0dBi antenna gain

Operational Bands	Channel no.	Channel Freq. (MHz)	Max. Power-Value (conducted)				MPE-Value		Margin to limit:	Maximum admissible antenna gain at 20 cm distance (cable losses not considered) (Unit: dBi)	
			Peak value (Unit: dBm)	Duty-cycle correction factor acc. max. no. of uplink slots ¹⁾ (Unit: dB)	Equivalent value (Unit: dBm)	Converted (Unit: mWatt)	(Unit: mWatt/cm ²)				
GPRS 850	128	824.2	32.79	-3.01	29.78	950.60	0.1891		0.5495	0.3603	4.6320
	192	837	33.00	-3.01	29.99	997.70	0.1985		0.5580	0.3595	4.4889
	251	848.8	32.80	-3.01	29.79	952.80	0.1896		0.5659	0.3763	4.7497
GPRS 1900	512	1850.2	30.45	-3.01	27.44	554.63	0.1103		1.0000	0.8897	9.5726
	661	1880	30.32	-3.01	27.31	538.27	0.1071		1.0000	0.8929	9.7026
	810	1808.8	30.32	-3.01	27.31	538.27	0.1071		1.0000	0.8929	9.7026

Remark: 1) 'EUT A' support GPRS/(E)GPRS multislots class 33 (max. 4 uplink time slots).

Canadian RSS-102 standard requires the RF-exposure value in W/m² unit.; therefore the value determined in mW/cm² unit, should be multiplied by 10 to have the required unit.

Conclusion:

For the actual project a commercial available magnetic antenna (EUT D) with the antenna gain of 3.0 dBi was used. Measuring the conducted e.r.p. power shows at the middle channel of the GPRS 850 Band within the maximum admissible antenna gain.

5.6.2. Results for mobile operations

Prediction for Part 22 (max antenna gain for mobile operations)

Maximum conducted peak power: 32,80 dBm on ARFCN 251.

Highest admissible antenna gain for **850 MHz mobile operations (@20cm)** where no routine evaluation is required according § 2.1091 (c) for P= 1.5W ERP

$$G = 10 \log 1500\text{mW [ERP]} - 32.80\text{dBm} + 2.15 \text{ dB} = \mathbf{1.11 \text{ dBi}}$$

Prediction for Part 24 (max antenna gain for mobile operations)

Maximum conducted peak power: 30,45 dBm on ARFCN 512.

Highest admissible antenna gain for **1900 MHz mobile operations (@20cm)** where no routine evaluation is required accord. §2.1091 (c) and §24.232 for P= 2W EIRP

$$G = 10 \log 2000\text{mW [EIRP]} - 30,45 \text{ dBm} = \mathbf{2.55 \text{ dBi}}$$

5.7. Radiated and Conducted out of Band RF emissions and Block Edge

5.7.1. Test location and equipment (for reference numbers please see chapter 'List of test equipment')

test location	<input checked="" type="checkbox"/> CETECOM Essen (Chapter. 2.2.1)	<input type="checkbox"/> Please see Chapter. 2.2.2	<input type="checkbox"/> Please see Chapter. 2.2.3
test site	<input type="checkbox"/> 441 EMI SAR	<input type="checkbox"/> 487 SAR NSA	<input type="checkbox"/> 337 OATS
receiver	<input type="checkbox"/> 377 ESCS30	<input type="checkbox"/> 001 ESS	<input checked="" type="checkbox"/> 489 ESU
spectr. analys.	<input type="checkbox"/> 584 FSU	<input type="checkbox"/> 120 FSEM	<input type="checkbox"/> 264 FSEK
antenna	<input type="checkbox"/> 574 BTA-L	<input type="checkbox"/> 133 EMCO3115	<input type="checkbox"/> 302 BBHA9170
signaling	<input type="checkbox"/> 017 CMD 65	<input type="checkbox"/> 323 CMD 55	<input type="checkbox"/> 340 CMD 55
signaling	<input type="checkbox"/> 392 MT8820A	<input type="checkbox"/> 436 CMU	<input checked="" type="checkbox"/> 547 CMU
power supply	<input type="checkbox"/> 463 HP3245A	<input type="checkbox"/> 457 EA 3013A	<input type="checkbox"/> 459 EA 2032-50
otherwise	<input checked="" type="checkbox"/> 529 6dB divider	<input checked="" type="checkbox"/> 530 10dB Att.	<input type="checkbox"/> 110 USB LWL
line voltage	<input checked="" type="checkbox"/> 110 V 60 Hz via public mains	<input checked="" type="checkbox"/> 060 110 V 60 Hz via PAS 5000	<input type="checkbox"/> 268 EA- 3050
			<input type="checkbox"/> 494 AG6632A
			<input checked="" type="checkbox"/> 498 NGPE 40
			<input type="checkbox"/> 431 Near field

REFERENCES

FCC: §2.1051-conducted, §2.1053(a)-radiated, §2.1057, §22.917(a)(b); §24.238(a)(b)

IC: RSS-132: 4.5.1&4.5.2, RSS-133: 6.5.1(a)(b)

„the power of emissions shall be attenuated below the transmitter output power (p) by at least least $43+10\log(P)$ dB“

Test condition and measurement test set-up

link to test system (if used):	<input checked="" type="checkbox"/> air link (radiated)	<input checked="" type="checkbox"/> cable connection (conducted)	<input type="checkbox"/>
Climatic conditions	Temperature: (22±3°C)		Rel. humidity: (40±20)%

FREQUENCY RANGE

The spectrum was scanned from 9 kHz to the 10th harmonic of the highest frequency generated within the equipment. A PEAK detector was used except measurements near the block-edge where a AVERAGE detector applied.

“The specification that all emissions shall be attenuated below the transmitter power (P) by at least $43 + 10 \log (P)$ dB, translates in the relevant power range of the mobile phone (1 to 0.001 W) to a constant limit of -13 dBm.”

“§ 2.1057 Frequency spectrum to be investigated. (a) In all of the measurements set forth in §§ 2.1051 and 2.1053, the spectrum shall be investigated from the lowest radio frequency signal generated in the equipment, without going below 9 kHz”

DESCRIPTION OF SET-UP

- see conducted set-up in chapter 4.1
- see radiated set-up in chapter 4.2

SETTINGS ON MOBILE PHONE

The measurements were made at the upper, middle, and lower carrier frequencies of the operating band. Choosing three representative TX-carrier frequencies of the mobile phone within each operable GSM band, should be sufficient to demonstrate compliance with the emissions limits outside and adjacent to the frequency blocks.

A call was established with settings according chapter 3.7

TEST METHOD RADIATED:

By rotating the EUT in three orthogonal planes, the emissions were recorded with Peak-Detector and Hold-Max function of the spectrum-analyzer. If the harmonic could not be detected above the noise floor, the ambient level was recorded. Measurement distance is 3m for frequencies up to 20GHz and 1m for frequencies greater then 18GHz. The readings on the spectrum analyzer are corrected with annually performed chamber path calibration values so the readings shown are equivalent to ERP/EIRP values. Critical measurements near the limit are re-measured with a substitution method accord. ANSI/TIA/EIA 603 as described in.

SETTINGS OF SPECTRUM-ANALYSER

Frequency range	RBW (resolution bandwidth)	VBW (video bandwidth)
BLOCK-EDGE compliance: 1 MHz immediately adjacent to the frequency blocks	1% from applicants stated/measured emission bandwidth	3..10 times the RBW
More than 1 MHz outside and adjacent the frequency blocks	1kHz or 100kHz to measurement frequencies up to 1MHz 1 MHz for measurement frequency range 1MHz to maximum 10-times TX-frequency	3..10 times the RBW

Settings for G850 Mode (conducted)

	Start freq. MHz	Stop freq. MHz	R-BW MHz	V-BW MHz	Sweep time sec.	Att.	Detector
Sweep 1 (subrange 1)	0.009	1	0.001	0.01	10	25	MaxH-PK
Sweep 1 (subrange 2)	1	30	0.1	1	5	25	MaxH-PK
Sweep 2 (subrange 1)	30	1000	1	1	10	35	MaxH-PK
Sweep 2 (subrange 2)	1000	2500	1	1	15	35	MaxH-PK
Sweep 2 (subrange 3)	2500	9000	1	1	60	35	MaxH-PK
Sweep 3a (Block-Edge)	823	824	0.003	0.01	30	35	MaxH-PK
Sweep 3b (Block-Edge)	823	824	0.003	0.01	30	35	MaxH-AV
Sweep 4a (Block-Edge)	850	851	0.003	0.01	30	35	MaxH-PK
Sweep 4b (Block-Edge)	850	851	0.003	0.01	30	35	MaxH-AV

Settings for PCS1900 Mode (conducted)

	Start freq. MHz	Stop freq. MHz	R-BW MHz	V-BW MHz	Sweep time sec.	Att.	Detector
Sweep 1 (subrange 1)	0.009	1	0.001	0.01	10	25	MaxH-PK
Sweep 1 (subrange 2)	1	30	0.1	1	5	25	MaxH-PK
Sweep 2 (subrange 1)	30	1000	1	1	10	35	MaxH-PK
Sweep 2 (subrange 2)	1000	2500	1	1	15	35	MaxH-PK
Sweep 2 (subrange 3)	2500	19500	1	1	160	35	MaxH-PK
Sweep 3a (Block-Edge)	1849	1850	0.003	0.01	30	35	MaxH-PK
Sweep 3b (Block-Edge)	1849	1850	0.003	0.01	30	35	MaxH-AV
Sweep 4a (Block-Edge)	1910	1911	0.003	0.01	30	35	MaxH-PK
Sweep 4b (Block-Edge)	1910	1911	0.003	0.01	30	35	MaxH-AV

5.7.2. Results (conducted)

5.7.2.1. GPRS TCH 850: Op. Mode 1, Set-up 2

Lowest channel: 128

Transmitting channel/ frequency: TX = 824.2 MHz							
Sweep no.	Diagram number	Frequency of emission [MHz]	Worst-Peak level [dBm]	Frequency of worst-peak level [MHz]	Result [dBm]	Limit [dBm]	Verdict
Sweep 1	a_4.17	0.009 to 30	--	--	<-50.36	-13	Passed
Sweep 2	a_4.20	30 to 12750	--	--	<-23.00		Passed
Sweep 3 ^{1.)}	a_4.36	823.98	--	--	-27.32 (AV)		Passed

Remark: see diagrams in Annex A1 for more details

1.) Block-Edge compliance

Middle channel = 192

Transmitting channel/ frequency: TX = 837 MHz							
Sweep no.	Diagram number	Frequency of emission [MHz]	Worst-Peak level [dBm]	Frequency of worst-peak level [MHz]	Result [dBm]	Limit [dBm]	Verdict
Sweep 1	a_4.18	0.009 to 30	--	--	<-49.96	-13	Passed
Sweep 2 ^{1.)}	a_4.21	30 to 12750	--	--	<-22.93		Passed

Remark: see diagrams in Annex A1 for more details

Highest channel: 251

Transmitting channel/ frequency: TX = 848.8 MHz							
Sweep no.	Diagram number	Frequency of emission [MHz]	Worst-Peak level [dBm]	Frequency of worst-peak level [MHz]	Result [dBm]	Limit [dBm]	Verdict
Sweep 1	a_4.19	0.009 to 30	--	--	<-50.49	-13	Passed
Sweep 2	a_4.22	30 to 12750	--	--	<-23.00		Passed
Sweep 3 ^{1.)}	a_4.38	849.02	--	--	-27.30 (AV)		Passed

Remark: see diagrams in Annex A1 for more details

1.) Band-Edge compliance

5.7.3. E-GPRS TCH 850: Op. Mode 2, Set-up 2

Lowest channel: 128

Transmitting channel/ frequency: TX = 824.2 MHz							
Sweep no.	Diagram number	Frequency of emission [MHz]	Worst-Peak level [dBm]	Frequency of worst-peak level [MHz]	Result [dBm]	Limit [dBm]	Verdict
Sweep 1	a_4.01	0.009 to 30	--	--	<-51.57	-13	Passed
Sweep 2 ¹⁾	a_4.04	30 to 12750	--	--	<-23.38		Passed
Sweep 3 ^{2.)}	a_4.07	823.98	--	--	-19.48 (PK)		Passed

Remark: see diagrams in Annex A1 for more details

- 1.) Carrier of wanted TX on diagram
- 2.) Block-Edge compliance

Middle channel = 192

Transmitting channel/ frequency: TX = 837 MHz							
Sweep no.	Diagram number	Frequency of emission [MHz]	Worst-Peak level [dBm]	Frequency of worst-peak level [MHz]	Result [dBm]	Limit [dBm]	Verdict
Sweep 1	a_4.02	0.009 to 30	--	--	<-50.78	-13	Passed
Sweep 2 ¹⁾	a_4.05	30 to 12750	--	--	<-23.60		Passed

Remark: see diagrams in Annex A1 for more details

- 1.) Carrier of wanted TX on diagram

Highest channel: 251

Transmitting channel/ frequency: TX = 848.8 MHz							
Sweep no.	Diagram number	Frequency of emission [MHz]	Worst-Peak level [dBm]	Frequency of worst-peak level [MHz]	Result [dBm]	Limit [dBm]	Verdict
Sweep 1	a_4.03	0.009 to 30	--	--	<-50.40	-13	Passed
Sweep 2 ¹⁾	a_4.06	30 to 12750	--	--	<-23.23		Passed
Sweep 3 ^{2.)}	a_4.08	849.0	--	--	-18.97 (PK)		Passed

Remark: see diagrams in Annex A1 for more details

- 1.) Carrier of wanted TX on diagram
- 2.) Block-Edge compliance

5.7.4. GPRS 1900 Mode: Op. Mode 3, Set-up 2

Lowest channel: 512

Transmitting channel/ frequency: TX = 1850,2 MHz							
Sweep no.	Diagram number	Frequency of emission [MHz]	Worst-Peak level [dBm]	Frequency of worst-peak level [MHz]	Result [dBm]	Limit [dBm]	Verdict
Sweep 1	a_4.09	0.009 to 30	--	--	<-50.98	-13	Passed
Sweep 2 ¹⁾	a_4.10	30 to 12750	--	--	<-19.75		Passed
Sweep 3 ^{2.)}	a_4.39	1849.98	--	--	-30.22 (AV)		Passed

Remark: see diagrams for more details

- 1.) Carrier of wanted TX on diagram
- 2.) Block-Edge compliance

Middle channel: 661

Transmitting channel/ frequency: TX = 1880,0 MHz							
Sweep no.	Diagram number	Frequency of emission [MHz]	Worst-Peak level [dBm]	Frequency of worst-peak level [MHz]	Result [dBm]	Limit [dBm]	Verdict
Sweep 1	a_4.11	0.009 to 30	--	--	<-51.17	-13	Passed
Sweep 2 ¹⁾	a_4.12	30 to 12750	--	--	<-20.30		Passed

Remark: see diagrams for more details

- 1.) Carrier of wanted TX on diagram

Highest channel: 810

Transmitting channel/ frequency: TX = 1908,8 MHz							
Sweep no.	Diagram number	Frequency of emission [MHz]	Worst-Peak level [dBm]	Frequency of worst-peak level [MHz]	Result [dBm]	Limit [dBm]	Verdict
Sweep 1	a_4.13	0.009 to 30	--	--	<-50.91	-13	Passed
Sweep 2 ¹⁾	a_4.14	30 to 12750	--	--	<-19.75		Passed
Sweep 3 ^{2.)}	a_4.40	1910.02	--	--	-29.13 (AV)		Passed

Remark: see diagrams for more details

- 1.) Carrier of wanted TX on diagram
- 2.) Block-Edge compliance

5.7.5. E-GPRS 1900 Mode: Op. Mode 4, Set-up 2

Lowest channel: 512

Transmitting channel/ frequency: TX = 1850,2 MHz							
Sweep no.	Diagram number	Frequency of emission [MHz]	Worst-Peak level [dBm]	Frequency of worst-peak level [MHz]	Result [dBm]	Limit [dBm]	Verdict
Sweep 1	a_4.23	0.009 to 30	--	--	<-50.18	-13	Passed
Sweep 2 ¹⁾	a_4.26	30 to 12750	--	--	<-19.76		Passed
Sweep 3 ^{2.)}	a_4.15	1849.99	--	--	-45.45 (PK)		Passed

Remark: see diagrams for more details

- 1.) Carrier of wanted TX on diagram
- 2.) Block-Edge compliance

Middle channel: 661

Transmitting channel/ frequency: TX = 1880,0 MHz							
Sweep no.	Diagram number	Frequency of emission [MHz]	Worst-Peak level [dBm]	Frequency of worst-peak level [MHz]	Result [dBm]	Limit [dBm]	Verdict
Sweep 1	a_4.24	0.009 to 30	--	--	<-50.31	-13	Passed
Sweep 2 ¹⁾	a_4.27	30 to 12750	--	--	<-19.55		Passed

Remark: see diagrams for more details

- 1.) Carrier of wanted TX on diagram

Highest channel: 810

Transmitting channel/ frequency: TX = 1908,8 MHz							
Sweep no.	Diagram number	Frequency of emission [MHz]	Worst-Peak level [dBm]	Frequency of worst-peak level [MHz]	Result [dBm]	Limit [dBm]	Verdict
Sweep 1	a_4.25	0.009 to 30	-54.44	7.97	<-51.11	-13	Passed
Sweep 2 ¹⁾	a_4.28	30 to 12750	--	--	<-19.70		Passed
Sweep 3 ^{2.)}	a_4.16	1910.02	--	--	-44.34 (PK)		Passed

Remark: see diagrams for more details

- 1.) Carrier of wanted TX on diagram
- 2.) Block-Edge compliance

5.7.6. Results (Radiated)

Due to uncritical measurements (only noise floor) measurements have been performed only in E-GPRS Mode.

5.7.6.1. E-GPRS 850 Mode: Op. Mode 1, Set-up 1

Lowest channel: 128

Transmitting channel/ frequency: TX = 824.2 MHz							
Sweep no.	Diagram number (H/V)	Frequency of emission [MHz]	Worst-Level Polarisation	Frequency of worst-level [MHz]	Result [dBm]	Limit [dBm]	Verdict
Sweep 1 ^{1.)}	a_5.03	30 to 9000	H/V	--	Passed	-13	Passed ^{1.)}
Sweep 2 ^{2.)}	a_5.03_BE	823.97	V	--	-52.0 (AV)		Passed ^{2.)}

Remarks: see diagrams enclosed in annex A1

- 1.) Carrier of wanted TX on diagram and performed as pre-measurement
- 2.) Block-Edge compliance and performed as final-measurement

Middle channel: 192

Transmitting channel/ frequency: TX = 837.0 MHz							
Sweep no.	Diagram number (H/V)	Frequency of emission [MHz]	Worst-Level Polarisation	Frequency of worst-level [MHz]	Result [dBm]	Limit [dBm]	Verdict
Sweep 1 ^{1.)}	a_5.05	30 to 9000	H/V	150.52	-35.44	-13	Passed ^{1.)}
				4183.37	-40.98	-13	Passed ^{1.)}

Remarks: see diagrams enclosed in annex A1

- 1.) Carrier of wanted TX on diagram and performed as pre-measurement

Highest channel: 251

Transmitting channel/ frequency: TX = 849.8 MHz							
Sweep no.	Diagram number (H/V)	Frequency of emission [MHz]	Worst-Level Polarisation	Frequency of worst-level [MHz]	Result [dBm]	Limit [dBm]	Verdict
Sweep 1 ^{1.)}	a_5.04	30 to 9000	H/V	--	Passed	-13	Passed ^{1.)}
Sweep 2 ^{2.)}	a_5.04_BE	849.03	H/V	--	-24.01 (PK)		Passed ^{2.)}

Remarks: see diagrams enclosed in annex A1

- 1.) Carrier of wanted TX on diagram and performed as pre-measurement
- 2.) Block-Edge compliance

5.7.6.2. E-GPRS 1900 Mode: Op. Mode 4, Set-up 1

Lowest channel: 512

Transmitting channel/ frequency: TX = 1850,2 MHz							
Sweep no.	Diagram number (H/V)	Frequency of emission [MHz]	Worst-Level Polarisation	Frequency of worst-level [MHz]	Result [dBm]	Limit [dBm]	Verdict
Sweep 1	a_5.06	0.003 - 20000	H	3700	-37.6	-13	Passed ^{1.)}
Sweep 2	a_5.06_BE	1850.0	H/V	--	-23.94		Passed ^{2.)}

Remarks: see diagrams enclosed in annex A1

- 1.) Carrier of wanted TX on diagram and performed as final-measurement
- 2.) Block-Edge compliance and performed as final-measurement

Middle channel: 661

Transmitting channel/ frequency: TX = 1880,0 MHz							
Sweep no.	Diagram number (H/V)	Frequency of emission [MHz]	Worst-Level Polarisation	Frequency of worst-level [MHz]	Result [dBm]	Limit [dBm]	Verdict
Sweep 1	a_5.07	0.003 - 20000	H	3759.99	-33.2	-13	Passed ^{1.)}

Remarks: see diagrams enclosed in annex A1

- 1.) Carrier of wanted TX on diagram and performed as final-measurement

Highest channel: 810

Transmitting channel/ frequency: TX = 1908,8 MHz							
Sweep no.	Diagram number (H/V)	Frequency of emission [MHz]	Worst-Level Polarisation	Frequency of worst-level [MHz]	Result [dBm]	Limit [dBm]	Verdict
Sweep 1	a_5.08	0.003 - 20000	H	3819.97	-32.6	-13	Passed ^{1.)}
Sweep 2	a_5.08_BE	1910.0	H/V	--	-22.88		Passed ^{2.)}

Remark: see diagrams for more details, only worst-case level mentioned.

- 1.) Carrier of wanted TX on diagram and performed as final-measurement
- 2.) Block-Edge compliance

5.8. Frequency stability on temperature and voltage variations

5.8.1. Test location and equipment (for reference numbers please see chapter 'List of test equipment')

test location	<input checked="" type="checkbox"/> CETECOM Essen (Chapter. 2.2.1)	<input type="checkbox"/> Please see Chapter. 2.2.2	<input type="checkbox"/> Please see Chapter. 2.2.3
test site	<input type="checkbox"/> 441 EMI SAR	<input type="checkbox"/> 487 SAR NSA	<input checked="" type="checkbox"/> 347 Radio.lab.
receiver	<input type="checkbox"/> 377 ESCS30	<input type="checkbox"/> 001 ESS	<input type="checkbox"/> 489 ESU 40
spectr. analys.	<input type="checkbox"/> 584 FSU	<input type="checkbox"/> 120 FSEM	<input type="checkbox"/> 264 FSEK
antenna	<input type="checkbox"/> 574 BTA-L	<input type="checkbox"/> 133 EMCO3115	<input type="checkbox"/> 302 BBHA9170
signaling	<input type="checkbox"/> 392 MT8820A	<input type="checkbox"/> 436 CMU	<input checked="" type="checkbox"/> 547 CMU
otherwise	<input type="checkbox"/> 400 FTC40x15E	<input type="checkbox"/> 401 FTC40x15E	<input type="checkbox"/> 110 USB LWL
DC power	<input type="checkbox"/> 456 EA 3013A	<input type="checkbox"/> 457 EA 3013A	<input type="checkbox"/> 459 EA 2032-50
Climatic test chamber	<input checked="" type="checkbox"/> 331 HC 4055		
line voltage	<input type="checkbox"/> 230 V 50 Hz via public mains	<input type="checkbox"/> 060 110 V 60 Hz via PAS 5000	

STANDARDS AND REFERENCES:

FCC: §2.1055(a)(2), §22.355, §24.235

IC: RSS-132: 4.3, RSS-133: 6.3

§22.355 Table C-1; § 24.235

“The frequency stability shall be sufficient to ensure that the fundamental emission stays within the authorized frequency block”

TEST CONDITION AND MEASUREMENT TEST SET-UP

link to test system (if used):	<input type="checkbox"/> air link	<input checked="" type="checkbox"/> cable connection	<input type="checkbox"/>
Climatic conditions	Temperature: (22±3°C)		Rel. humidity: (40±20)%

TEST SET-UP

In order to maintain the voltage constant over the time period of the tests, a dummy battery was connected to a laboratory power supply. The power supply voltage was controlled on the input of the power supply terminals of the EUT.

A conducted measurement test set-up like described in chapter 4.1 was used.

MOBILE PHONE SETTINGS

The measurements were made at the upper, middle, and lower carrier frequencies of the operating band. Choosing three representative TX-carrier frequencies of the mobile phone within each operable GSM band, should be sufficient to demonstrate compliance.

A call was established with settings according chapter 3.7

TEST METHOD

The RF Channel spacing is 200 kHz, with a guard band of 200 kHz of each band of the sub-bands. The aim of the EUT is to function under all extreme conditions within authorized sub-bands in regard to temperature and voltage variations. The frequency deviation was recorded with base station’s build in capability. (CMU) As the standard requires that the fundamental emissions stays within the authorized band, a limit of 0.1ppm is considered low enough to ensure this.

5.8.2. Frequency shift of carrier against a voltage range at constant nominal temperature of 20° Celsius

- 1.) determine the carrier frequency for the lowest and highest channel at room temperature and nominal voltage [20°C]
- 2.) The voltage was reduced in 0.1V steps to the lower end point, where the mobile phone stops working. (this shall be specified by the manufacturer) Record the carrier frequency shift within 2 minutes after powering on the mobile phone, to prevent for self heating effects.
- 3.) The voltage was increased in 0.1V steps to the upper declared voltage of the battery. Record the carrier frequency shift within 2 minutes after powering on the mobile phone, to prevent for self heating effects.

RESULTS

5.8.2.1. GPRS 850 Mode: Op. Mode 1, set-up 2

Voltage [V]	Nominal Frequency [Hz]	Maximum frequency error		Verdict Limit=±2.5ppm
		[Hz]	[ppm]	
3.30	836400000	14	0.017	Passed
3.40		12	0.014	
3.50		12	0.014	
3.60		13	0.016	
3.70		15	0.018	
3.80		11	0.013	
3.90		13	0.016	
4.00		11	0.013	
4.10		12	0.014	
4.20		14	0.017	
4.30		15	0.018	
4.40		15	0.018	

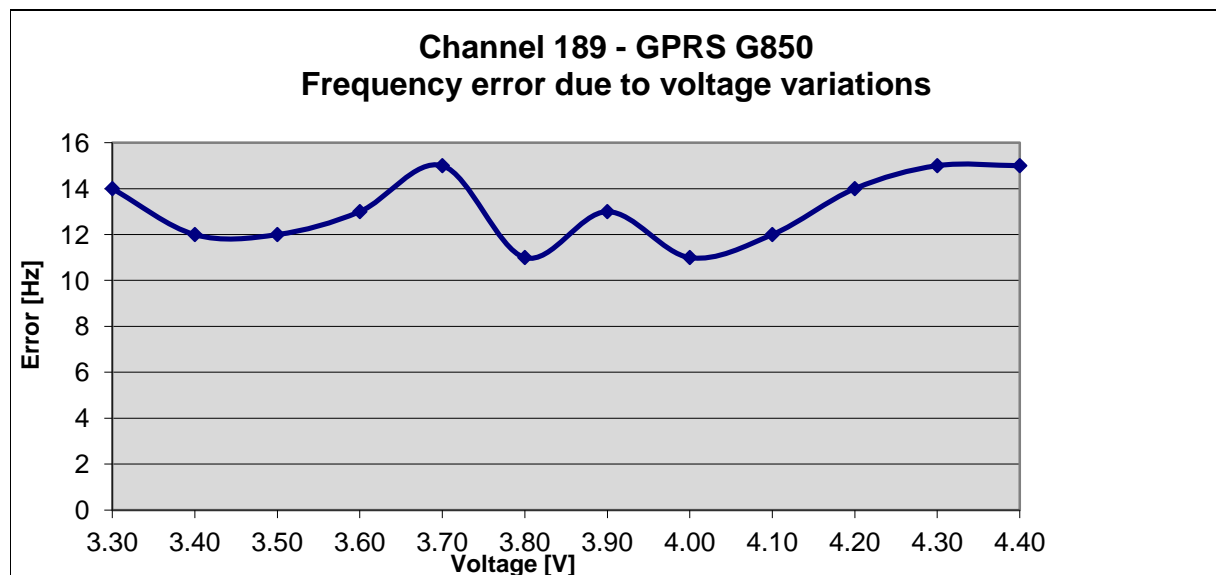

5.8.2.2. E-GPRS G850 Mode: Op. Mode 2, set-up 1

Voltage [V]	Nominal Frequency [Hz]	Maximum frequency error		Verdict Limit=±2.5ppm
		[Hz]	[ppm]	
3.30	836400000	-18	-0.022	Passed
3.40		-21	-0.025	
3.50		-22	-0.026	
3.60		-22	-0.026	
3.70		-22	-0.026	
3.80		-21	-0.025	
3.90		-20	-0.024	
4.00		-20	-0.024	
4.10		-21	-0.025	
4.20		-20	-0.024	
4.30		-19	-0.023	
4.40		-22	-0.026	

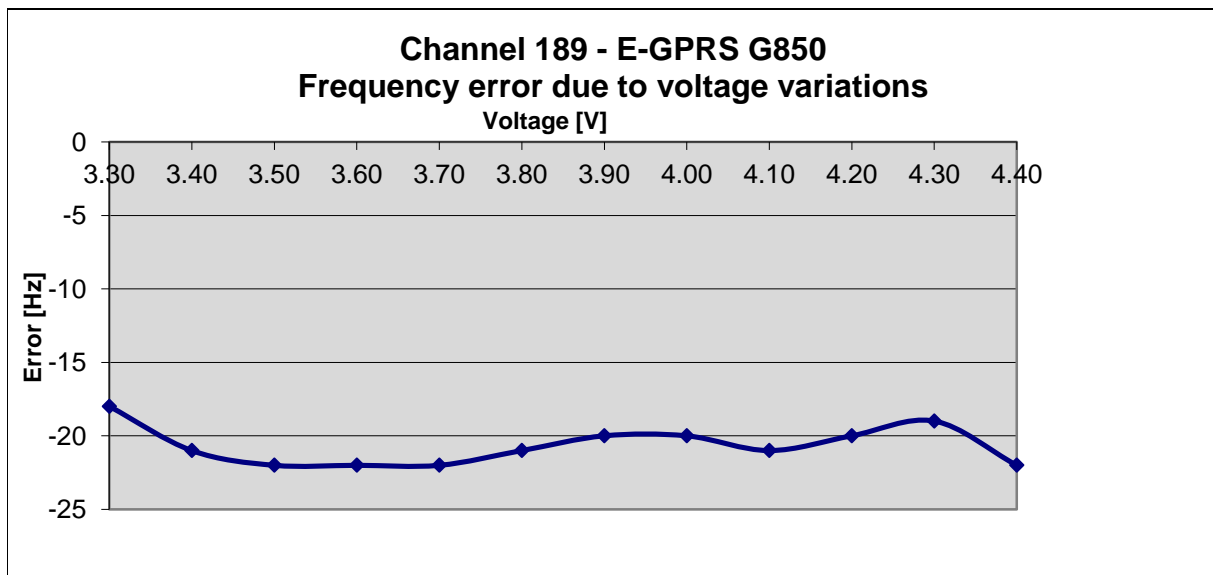

5.8.2.3. GPRS PCS 1900 Mode: Op. Mode 3, set-up 2

Voltage [V]	Nominal Frequency [Hz]	Maximum frequency error		Verdict Limit=±0.1ppm
		[Hz]	[ppm]	
3.30	1880000000	17	0.009	Passed
3.40		16	0.009	
3.50		19	0.010	
3.60		19	0.010	
3.70		20	0.011	
3.80		20	0.011	
3.90		17	0.009	
4.00		20	0.011	
4.10		19	0.010	
4.20		21	0.011	
4.30		18	0.010	
4.40		22	0.012	

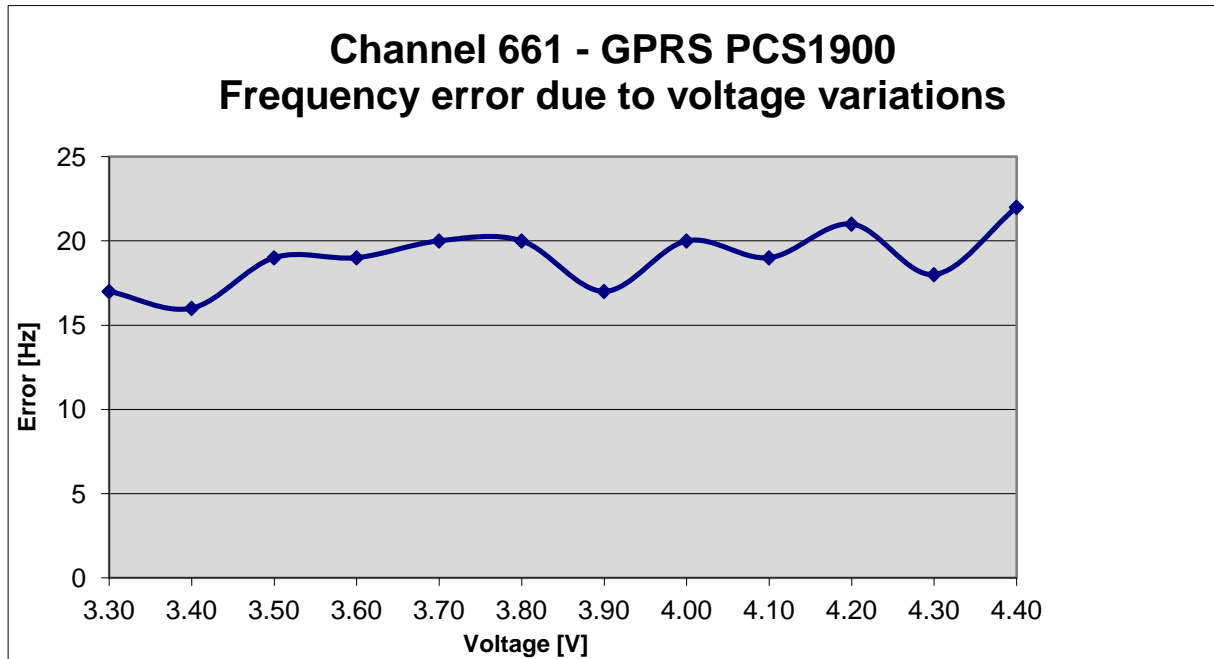

5.8.2.4. GPRS PCS 1900 Mode: Op. Mode 4, set-up 2

Voltage [V]	Nominal Frequency [Hz]	Maximum frequency error		Verdict Limit=±0.1ppm
		[Hz]	[ppm]	
3.30	1880000000	-27	-0.014	Passed
3.40		-25	-0.013	
3.50		-24	-0.013	
3.60		-28	-0.015	
3.70		-34	-0.018	
3.80		-26	-0.014	
3.90		-28	-0.015	
4.00		-26	-0.014	
4.10		-28	-0.015	
4.20		-32	-0.017	
4.30		-30	-0.016	
4.40		-30	-0.016	

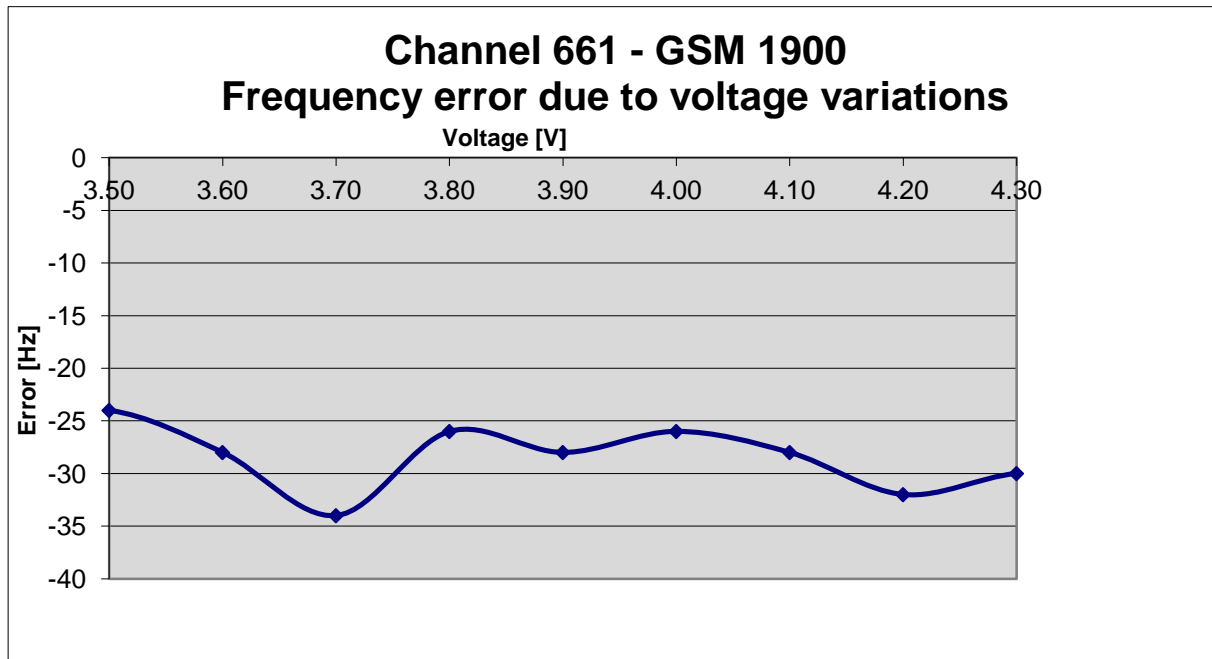

5.8.3. Frequency shift of carrier against temperature at constant power supply voltage

- 1.) determine the carrier frequency for the lowest, middle and highest channel at room temperature and nominal voltage [20°C]
- 2.) expose the mobile station to -30°C, wait sufficient time to have constant temperature.
- 3.) Perform the carrier frequencies measurements in 10°C increments from -30°C to +60°C. For about half hour at the specified temperature the mobile was powered-off. After powering-on, the measurements were made within 2 minute for the channel lower channel, in order to prevent self-warming of the mobile.

5.8.3.1. GPRS 850 Mode: Op. Mode 1, set-up 3

Temperature	Maximum frequency error						Verdict Limit=±2.5ppm
	Channel 128	Channel 189	Channel 250	Channel 128	Channel 189	Channel 250	
	[Hz]			[ppm]			
-30	16	16	18	0.019	0.019	0.021	Passed
-20	14	16	15	0.017	0.019	0.018	
-10	14	17	16	0.017	0.020	0.019	
0	15	15	16	0.018	0.018	0.019	
10	17	16	17	0.021	0.019	0.020	
20	15	14	14	0.018	0.018	0.016	
30	14	16	14	0.017	0.019	0.016	
40	15	17	14	0.018	0.020	0.016	
50	16	13	15	0.019	0.016	0.018	

**Frequency Error due to temperature variations
GPRS 850**

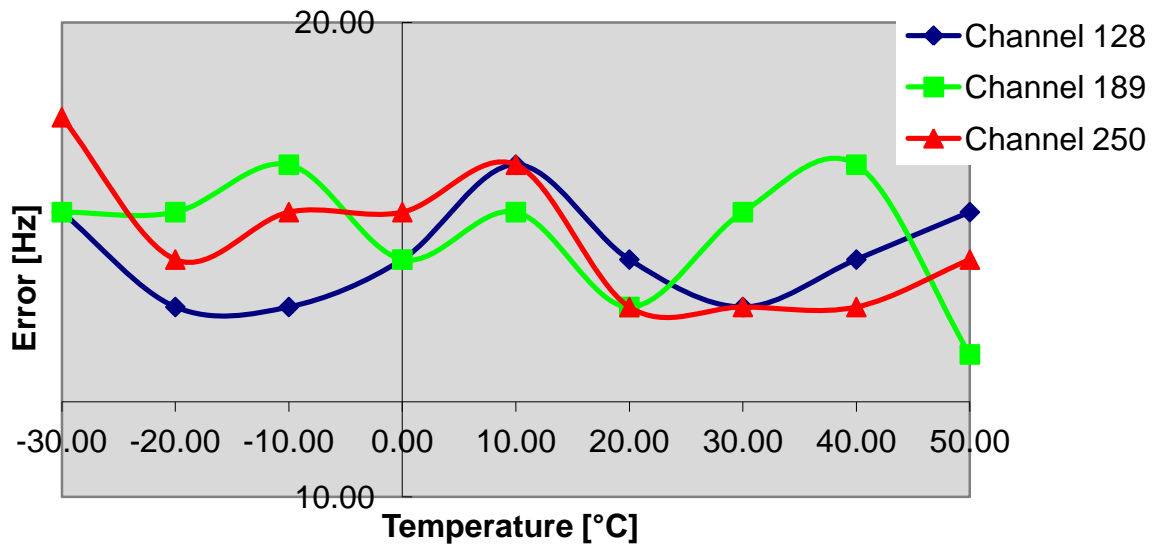

5.8.3.2. E-GPRS 850 Mode: Op. Mode 2, set-up 2

Temperature	Maximum frequency error						Verdict Limit=±2.5ppm
	Channel 128	Channel 189	Channel 250	Channel 128	Channel 189	Channel 250	
	[Hz]			[ppm]			
-30	-19	-19	-18	-0.023	-0.023	-0.021	Passed
-20	-17	-19	-19	-0.021	-0.023	-0.022	
-10	-20	-19	-17	-0.024	-0.023	-0.020	
0	-18	-19	-19	-0.022	-0.023	-0.022	
10	-19	-20	-19	-0.023	-0.024	-0.022	
20	-16	-21	-19	0.018	0.017	0.016	
30	-18	-21	-19	-0.022	-0.025	-0.022	
40	-15	-17	-19	-0.018	-0.020	-0.022	
50	-14	-19	-18	-0.017	-0.023	-0.021	

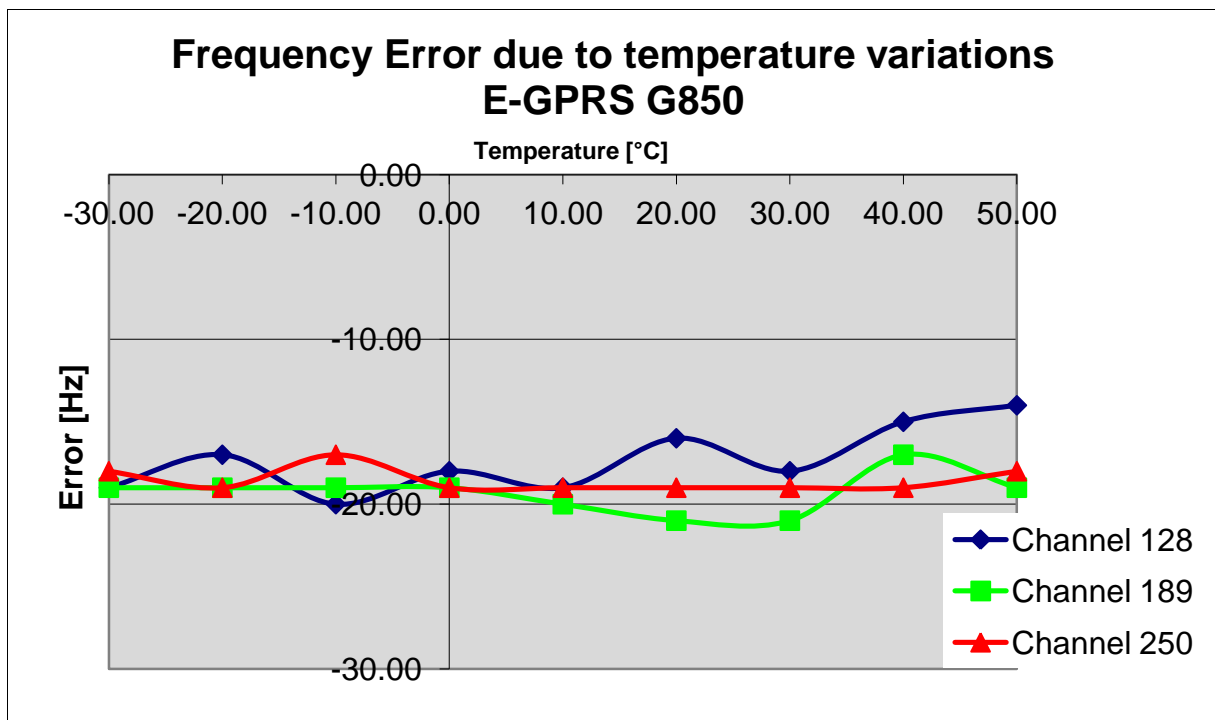

5.8.3.3. GPRS PCS 1900 Mode: Op. Mode 3, set-up 2

Temperature	Maximum frequency error						Verdict Limit=±0.1ppm
	Channel 512	Channel 661	Channel 810	Channel 512	Channel 661	Channel 810	
	[Hz]			[ppm]			
-30	24	24	21	0.013	0.013	0.011	Passed
-20	26	20	24	0.014	0.011	0.013	
-10	25	17	25	0.014	0.009	0.013	
0	19	19	21	0.010	0.010	0.011	
10	20	18	19	0.011	0.010	0.010	
20	22	19	22	0.012	0.010	0.012	
30	20	17	-18	0.011	0.009	-0.009	
40	21	17	20	0.011	0.009	0.010	
50	22	-17	-21	0.012	-0.009	-0.011	

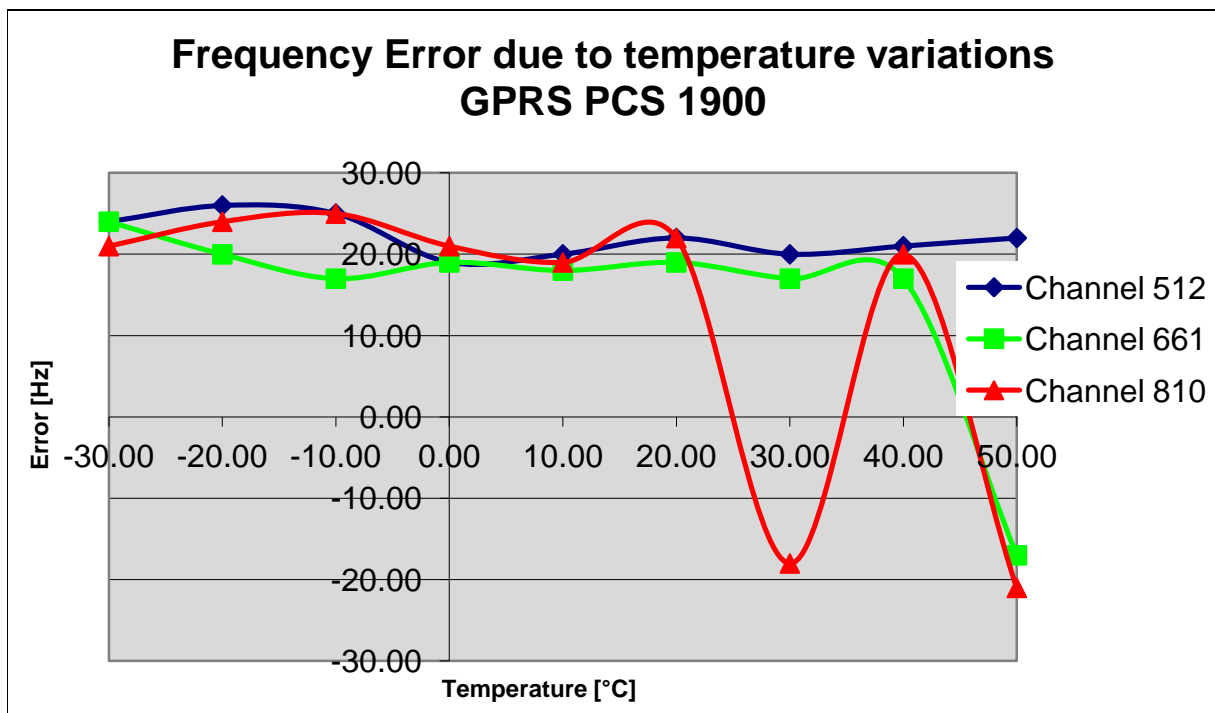

5.8.3.4. GPRS PCS 1900 Mode: Op. Mode 4, set-up 2

Temperature	Maximum frequency error						Verdict Limit=±0.1ppm
	Channel 512	Channel 661	Channel 810	Channel 512	Channel 661	Channel 810	
	[Hz]			[ppm]			
-30	28	20	22	0.015	0.011	0.012	Passed
-20	-23	-24	-34	-0.012	-0.013	-0.018	
-10	-22	-24	-28	-0.012	-0.013	-0.015	
0	-26	-30	-29	-0.014	-0.016	-0.015	
10	-22	-26	-27	-0.012	-0.014	-0.014	
20	-22	-25	-28	-0.012	-0.013	-0.015	
30	-24	-23	-25	-0.013	-0.012	-0.013	
40	-23	-28	-25	-0.012	-0.015	-0.013	
50	25	17	16	0.014	0.009	0.008	

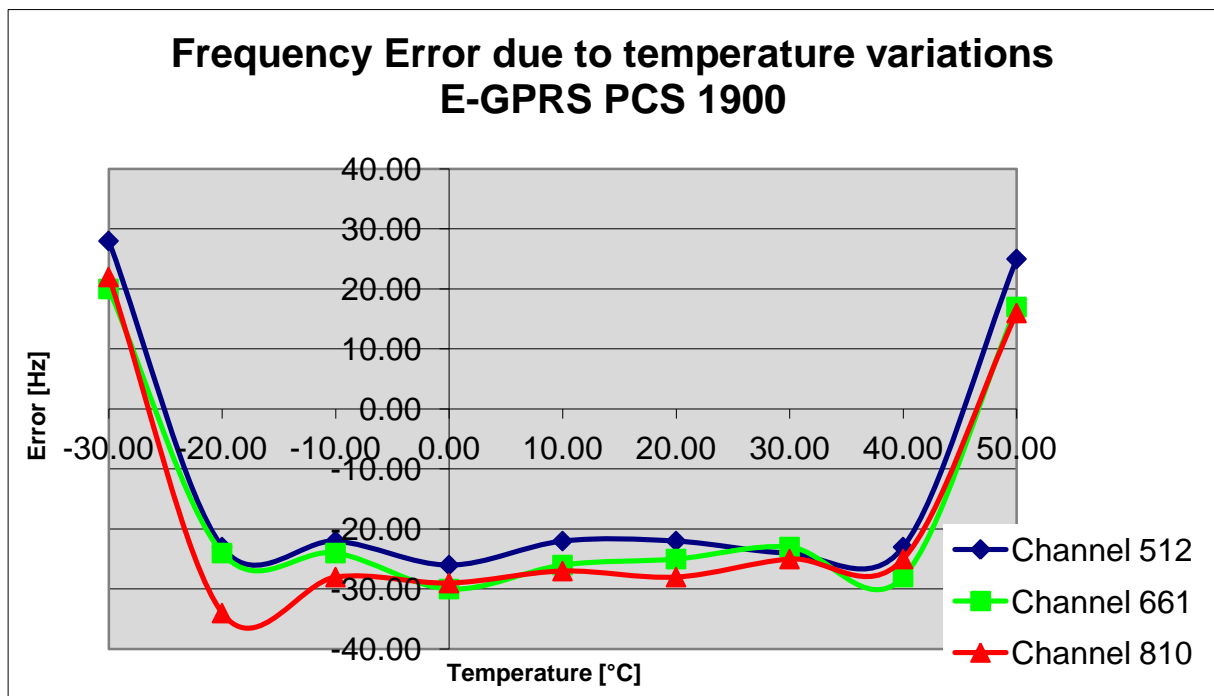

5.9. Measurement uncertainties

The reported uncertainties are calculated based on the standard uncertainty multiplied with the appropriate coverage factor **k**, such that a confidence level of approximately 95% is achieved.

For uncertainty determination, each component used in the concrete measurement set-up was taken in account and it's contribution to the overall uncertainty according it's statistical distribution calculated.

Following table shows expectable uncertainties for each measurement type performed.

RF-Measurement	Frequency range	Calculated uncertainty based on a confidence level of 95%	Remarks:
Power Output conducted	9 kHz .. 20 GHz	1 dB	--
Power Output radiated	30 MHz .. 4 GHz	3,17 dB	Substitution method
Conducted emissions on antenna ports	9 kHz .. 20 GHz	1 dB	--
Radiated emissions enclosure	150 kHz .. 30 MHz	5 dB	Magnetic field
	30 MHz .. 1 GHz	4.2 dB	E-Field
	1 GHz .. 20 GHz	3.17 dB	Substitution method
Occupied bandwidth	9 kHz .. 4 GHz	0.1272 ppm (Delta Marker)	Frequency error
		1 dB	Power
Emission bandwidth	9 kHz .. 4 GHz	0,1272 ppm (Delta Marker)	Frequency error
		1 dB	Power
Frequency stability	9 kHz .. 20 GHz	0,0636 ppm	--
Conducted emissions on AC-mains port (U _{CISPR})	9 kHz .. 150 kHz	4 dB	--
	150 kHz .. 30 MHz	3.6 dB	--

Table: measurement uncertainties, valid for conducted/radiated measurements

6. Accreditation details of CETECOM's laboratories and test sites

Ref.-No.	Accreditation Certificate	Valid for laboratory area or test site	Accreditation Body
-	D-PL-12047-01-01	All laboratories and test sites of CETECOM GmbH, Essen	DAkKS, Deutsche Akkreditierungsstelle GmbH
337 487 558 348 348	736496	Radiated Measurements 30 MHz to 1 GHz, 3 m / 10 m (OATS) Radiated Measurements 30 MHz to 1 GHz, 3 m (SAR) Radiated Measurements above 1 GHz, 3 m (FAR) Mains Ports Conducted Interference Measurements Telecommunication Ports Conducted Interference Measur.	FCC, Federal Communications Commission Laboratory Division, USA (MRA US-EU 0003)
337 487 550 558	3462D-1 3462D-2 3462D-2 3462D-3	Radiated Measurements 30 MHz to 1 GHz, 3 m / 10 m (OATS) Radiated Measurements 30 MHz to 1 GHz, 3 m (SAR) Radiated Measurements 1 GHz to 6 GHz, 3 m (SAR) Radiated Measurements above 1 GHz, 3 m (FAR)	IC, Industry Canada Certification and Engineering Bureau
337 487 550 348 348	R-2665 R-2666 G-301 C-2914 T-1967	Radiated Measurements 30 MHz to 1 GHz, 3 m / 10 m (OATS) Radiated Measurements 30 MHz to 1 GHz, 3 m (SAR) Radiated Measurements 1 GHz to 6 GHz, 3 m (SAR) Mains Ports Conducted Interference Measurements Telecommunication Ports Conducted Interference Measur.	VCCI, Voluntary Control Council for Interference by Information Technology Equipment, Japan
OATS = Open Area Test Site, SAR = Semi Anechoic Room, FAR = Fully Anechoic Room			

7. Instruments and Ancillary

7.1. Used equipment “CTC”

The “Ref.-No” in the left column of the following tables allows the clear identification of the laboratory equipment.

7.1.1. Test software and firmware of equipment

Ref.-No.	Equipment	Type	Serial-No.	Version of Firmware or Software during the test
001	Emi Test Receiver	ESS	825132/017	Firm.= 1.21 , OTP=2.0, GRA=2.0
012	Signal Generator (EMS-cond.)	SMY 01	839069/027	Firm.= V 2.02
013	Power Meter (EMS cond.)	NRVD	839111/003	Firm.= V 1.51
017	Digital Radiocommunication Tester	CMD 60 M	844365/014	Firmware = V 3.52 .22.01.99, DECT = D2.87 13.01.99
053	Audio Analyzer	UPA3	860612/022	Firm. V 4,3
119	RT Harmonics Analyzer dig. Flickermeter	B10	G60547	Firm.= V 3.1DHG
140	Signal Generator	SMHU	831314/006	Firm.= 3.21
261	Thermal Power Sensor	NRV-Z55	825083/0008	EPROM-Datum 02.12.04, SE EE 1 B
262	Power Meter	NRV-S	825770/0010	Firm.= 2.6
263	Signal Generator	SMP 04	826190/0007	Firm.=3.21
264	Spectrum Analyzer	FSEK 30	826939/005	Bios=2.1, Analyzer= 3.20
295	Racal Digital Radio Test Set	6103	1572	UNIT Firmware= 4.04, SW-Main=4.04, SW-BBP=1.04, SW-DSP=1.02, Hardboot=1.02, Softboot=2.02
298	Univ. Radio Communication Tester	CMU 200	832221/091	R&S Test Firmware =3.53 /3.54 (current Testsoftw. f. all band used
323	Digital Radiocommunication Tester	CMD 55	825878/0034	Firm.= 3.52 .22.01.99
331	Climatic Test Chamber -40/+80 Grad	HC 4055	43146	TSI 1.53
335	System-CTC-EMS-Conducted	System EMS Conducted	-	EMC 32 V 8.40
340	Digital Radiocommunication Tester	CMD 55	849709/037	Firm.= 3.52 .22.01.99
355	Power Meter	URV 5	891310/027	Firm.= 1.31
365	10V Insertion Unit 50 Ohm	URV5-Z2	100880	Eprom Data = 31.03.08
366	Ultra Compact Simulator	UCS 500 M4	V0531100594	Firm. UCS 500=001925/3.06a02, rc=ISMIEC 4.10
371	Bluetooth Tester	CBT32	100153	CBT V5.30+ SW-Option K55
377	Emi Test Receiver	ESCS 30	100160	Firm.= 2.30, OTP= 02.01, GRA= 02.36
378	Broadband RF Field Monitor	RadiSense III	03D00013SNO-08	Firm.= V.03D13
383	Signal Generator	SME 03	842 828 /034	Firm.= 4.61
389	Digital Multimeter	Keithley 2000	0583926	Firm. = A13 (Mainboard) A02 (Display)
392	Radio Communication Tester	MT8820A	6K00000788	Firm.= 4.50 #005, IPL=4.01#001,OS=4.02#001, GSM=4.41#013, W-CDMA= 4.54#004, scenario= 4.52#002
436	Univ. Radio Communication Tester	CMU 200	103083	R&S Test Firmware Base=5.14, Mess-Software= GSM:5.14 WCDMA:5.14 (current Testsoftw. F. all band to be used ,
441	CTC-SAR-EMI Cable Loss	System EMI field (SAR) Cable	-	EMC 32 Version 8.40
442	CTC-SAR-EMS	System EMS field (SAR)	-	EMC 32 Version 8.40
443	CTC-FAR-EMI-RSE	System CTC-FAR-EMI-RSE	-	Spuri 7.2.5 or EMC 32 Ver. 8.40
444	CTC-FAR-EMS field	System-EMS-Field (FAR)	-	EMC 32 Version 8.40
460	Univ. Radio Communication Tester	CMU 200	108901	R&S Test Firmware Base=5.14, GSM=5.14 WCDMA=5.14 (current Testsoftw.,f. all band to be used,
489	Emi Test Receiver	ESU40	1000-30	Firmware=4.43 SP3, Bios=V5.1-16-3, Spec. =01.00
491	ESD Simulator dito	ESD dito	dito307022	V 2.30
524	Voltage Drop Simulator	VDS 200	0196-16	Software Nr. 000037 Version V4.20a01
526	Burst Generator	EFT 200 A	0496-06	Software Nr. 000034 Version V2.32
527	Micro Pulse Generator	MPG 200 B	0496-05	Software-Nr. 000030 Version V2.43
528	Load Dump Simulator	LD 200B	0496-06	Software-Nr. 000031 Version V2.35a01
546	Univ. Radio Communication Tester	CMU 200	106436	R&S Test Firmware Base=5.14, GSM=5.14 WCDMA=5.14 (current Testsoftw.,f. all band to be used
547	Univ. Radio Communication Tester	CMU 200	835390/014	R&S Test Firmware Base=V5.1403 (current Testsoftw., f. all band used, GSM = 5.14 WCDMA: = 5.14
584	Spectrum Analyzer	FSU 8	100248	2.82_SP3
594	Univ. Radio Communication Tester	CMW500	101757	Firmware Base=2.0.20.9, LTE=2.0.20.8. CDMA= 2.0.10
597	Univ. Radio Communication Tester	CMU 200	100347	R&S Test Firmware Base=5.01, GSM=5.02 WCDMA= not installed, Mainboard= µP1=V.850
598	Spectrum Analyzer	FSEM 30 (Reserve)	831259/013	Firmware Bios 3.40 , Analyzer 3.40 Sp 2

7.1.2. Single instruments and test systems

Ref.-No.	Equipment	Type	Serial-No.	Manufacturer	Interval of calibration	Remark	Cal due
001	Emi Test Receiver	ESS	825132/017	Rohde & Schwarz	12 M	-	31.03.2012
005	AC - LISN (50 Ohm/50µH, test site 1)	ESH2-Z5	861741/005	Rohde & Schwarz	24/12 M	-	31.03.2012
007	DC - LISN (50 Ohm/5µH)	ESH3-Z6	892563/002	Rohde & Schwarz	24/12 M	-	31.03.2012
009	Power Meter (EMS-radiated)	NRV	863056/017	Rohde & Schwarz	24 M	-	31.03.2013
016	Line Impedance Simulating Network	Op. 24-D	B6366	Spitzenberger+Spies	36 M	-	31.03.2013
020	Horn Antenna 18 GHz (Subst 1)	3115	9107-3699	EMCO	36/12 M	-	31.03.2013
021	Loop Antenna (H-Field)	6502	9206-2770	EMCO	36 M	-	31.03.2013
030	Loop Antenna (H-field)	HFH-Z2	879604/026	Rohde & Schwarz	36 M	-	31.03.2012
033	RF-current probe (100kHz-30MHz)	ESH2-Z1	879581/18	Rohde & Schwarz	24 M	-	31.03.2013
057	relay-switch-unit (EMS system)	RSU	494440/002	Rohde & Schwarz	pre-m	1a	
060	power amplifier (DC-2kHz)	PAS 5000	B6363	Spitzenberger+Spies	-	3	
066	notch filter (WCDMA; FDD1)	WRCT 1900/2200-5/40-10EEK	5	Wainwright GmbH	12 M	1c	30.06.2012
086	DC - power supply, 0 -10 A	LNG 50-10	-	Heinzinger Electronic	pre-m	2	
087	DC - power supply, 0 -5 A	EA-3013 S	-	Elektro Automatik	pre-m	2	
090	Helmholtz coil: 2x10 coils in series	-	-	RWTÜV	-	4	
091	USB-LWL-Converter	OLS-1	007/2006	Ing. Büro Scheiba	-	4	
099	passive voltage probe	ESH2-Z3	299.7810.52	Rohde & Schwarz	36 M	-	31.03.2012
100	passive voltage probe	Probe TK 9416	without	Schwarzbeck	36 M	-	31.03.2012
110	USB-LWL-Converter	OLS-1	-	Ing. Büro Scheiba	-	4	
119	RT Harmonics Analyzer dig. Flickermeter	B10	G60547	BOCONSULT	36 M	-	31.03.2013
134	horn antenna 18 GHz (Subst 2)	3115	9005-3414	EMCO	12 M	-	31.03.2012
136	adjustable dipole antenna (Dipole 1)	3121C-DB4	9105-0697	EMCO	12 M	-	31.03.2012
140	Signal Generator	SMHU	831314/006	Rohde & Schwarz	24 M	-	31.03.2012
248	attenuator	SMA 6dB 2W	-	Radiall	pre-m	2	
249	attenuator	SMA 10dB 10W	-	Radiall	pre-m	2	
252	attenuator	N 6dB 12W	-	Radiall	pre-m	2	
256	attenuator	SMA 3dB 2W	-	Radiall	pre-m	2	
257	hybrid	4031C	04491	Narda	pre-m	2	
260	hybrid coupler	4032C	11342	Narda	pre-m	2	
261	Thermal Power Sensor	NRV-Z55	825083/0008	Rohde & Schwarz	24/12 M	-	31.03.2012
262	Power Meter	NRV-S	825770/0010	Rohde & Schwarz	24 M	-	31.03.2012
263	Signal Generator	SMP 04	826190/0007	Rohde & Schwarz	36 M	-	31.03.2013
264	Spectrum Analyzer	FSEK 30	826939/005	Rohde & Schwarz	12 M	-	31.03.2014
265	peak power sensor	NRV-Z33, Model 04	840414/009	Rohde & Schwarz	24 M	-	31.03.2012
266	peak power sensor	NRV-Z31, Model 04	843383/016	Rohde & Schwarz	24 M	-	31.03.2012
267	notch filter GSM 850	WRCA 800/960-6EEK	9	Wainwright GmbH	pre-m	2	
268	AC/DC power supply	EA 3050-A	9823636	Elektro Automatik	pre-m	2	
270	termination	1418 N	BB6935	Weinschel	pre-m	2	
271	termination	1418 N	BE6384	Weinschel	pre-m	2	
272	attenuator (20 dB) 50 W	Model 47	BF6239	Weinschel	pre-m	2	
273	attenuator (10 dB) 100 W	Model 48	BF9229	Weinschel	pre-m	2	
274	attenuator (10 dB) 50 W	Model 47 (10 dB) 50 W	BG0321	Weinschel	pre-m	2	
275	DC-Block	Model 7003 (N)	C5129	Weinschel	pre-m	2	
276	DC-Block	Model 7006 (SMA)	C7061	Weinschel	pre-m	2	
279	power divider	1515 (SMA)	LH855	Weinschel	pre-m	2	
287	pre-amplifier 25MHz - 4GHz	AMF-2D-100M4G-35-10P	379418	Miteq	12 M	1c	30.06.2012
291	high pass filter GSM 850/900	WHJ 2200-4EE	14	Wainwright GmbH	12 M	1c	30.06.2012
298	Univ. Radio Communication Tester	CMU 200	832221/091	Rohde & Schwarz	pre-m	3	
300	AC LISN (50 Ohm/50µH, 1-phase)	ESH3-Z5	892 239/020	Rohde & Schwarz	24/12 M	-	31.03.2012
301	attenuator (20 dB) 50W, 18GHz	47-20-33	AW0272	Lucas Weinschel	pre-m	2	
302	horn antenna 40 GHz (Meas 1)	BBHA9170	155	Schwarzbeck	36 M	-	31.03.2014
303	horn antenna 40 GHz (Subst 1)	BBHA9170	156	Schwarzbeck	36 M	-	31.03.2014
331	Climatic Test Chamber -40/+80 Grad	HC 4055	43146	Heraeus Vötsch	24 M	-	30.11.2012
341	Digital Multimeter	Fluke 112	81650455	Fluke	24 M	-	31.03.2012
342	Digital Multimeter	Voltcraft M-4660A	IB 255466	Voltcraft	24 M	-	31.03.2013
347	laboratory site	radio lab.	-	-	-	5	
348	laboratory site	EMI conducted	-	-	-	5	
354	DC - Power Supply 40A	NGPE 40/40	448	Rohde & Schwarz	pre-m	2	
355	Power Meter	URV 5	891310/027	Rohde & Schwarz	24 M	-	31.03.2012
356	power sensor	NRV-Z1	882322/014	Rohde & Schwarz	24 M	-	31.03.2013
357	power sensor	NRV-Z1	861761/002	Rohde & Schwarz	24 M	-	31.03.2013
373	V-Network 5µH/50 Ohm	ESH3-Z6	100535	Rohde & Schwarz	24/12 M	-	31.03.2012
376	Horn Antenna 6 GHz	BBHA9120 E	BBHA 9120 E.179	Schwarzbeck	12 M	-	31.03.2012
377	Emi Test Receiver	ESCS 30	100160	Rohde & Schwarz	12 M	-	31.03.2012
389	Digital Multimeter	Keithley 2000	0583926	Keithley	24 M	-	31.03.2013
392	Radio Communication Tester	MT8820A	6K00000788	Anritsu	12 M	-	31.03.2012
431	Model 7405	Near-Field Probe Set	9305-2457	EMCO	-	4	
436	Univ. Radio Communication Tester	CMU 200	103083	Rohde & Schwarz	12 M	-	31.03.2012
441	CTC-SAR-EMI Cable Loss	System EMI field (SAR) Cable	-	CETECOM	12 M	5	31.10.2012

Ref.-No.	Equipment	Type	Serial-No.	Manufacturer	Interval of calibration	Remark	Cal due
443	CTC-FAR-EMI-RSE	System CTC-FAR-EMI-RSE	-	ETS-Lindgren/CETECOM	12 M	5	30.06.2012
448	notch filter WCDMA_FDD II	WRCT 1850.0/2170.0-5/40-10SSK	5	Wainwright Instruments GmbH	12 M	1c	30.06.2012
449	notch filter WCDMA FDD V	WRCT 824.0/894.0-5/40-8SSK	1	Wainwright	12 M	1c	30.06.2012
454	Oscilloscope	HM 205-3	9210 P 29661	Hameg	-	4	
456	DC-Power supply 0-5 A	EA 3013 S	207810	Elektro Automatik	pre-m	2	
459	DC -Power supply 0-5 A , 0-32 V	EA-PS 2032-50	910722	Elektro Automatik	pre-m	2	
460	Univ. Radio Communication Tester	CMU 200	108901	Rohde & Schwarz	12 M	-	31.03.2012
463	Universal source	HP3245A	2831A03472	Agilent	-	4	
466	Digital Multimeter	Fluke 112	89210157	Fluke USA	24 M	-	31.03.2012
467	Digital Multimeter	Fluke 112	89680306	Fluke USA	24 M	-	31.03.2012
468	Digital Multimeter	Fluke 112	90090455	Fluke USA	24 M	-	31.03.2012
477	ReRadiating GPS-System	AS-47	-	Automotive Cons. Fink	-	3	
480	power meter (Fula)	NRVS	838392/031	Rohde & Schwarz	24 M	-	31.03.2013
482	filter matrix	Filter matrix SAR 1	-	CETECOM (Brl)	-	1d	
484	pre-amplifier 2,5 - 18 GHz	AMF-5D-02501800-25-10P	1244554	Miteq	12 M	-	30.07.2012
487	System CTC NSA-Verification SAR-EMI	System EMI field (SAR) NSA	-	ETS Lindgren/CETECOM	24 M	-	30.09.2013
489	Emi Test Receiver	ESU40	1000-30	Rohde & Schwarz	12 M	-	31.03.2012
502	band reject filter	WRCG 1709/1786-1699/1796-	SN 9	Wainwright	pre-m	2	
503	band reject filter	WRCG 824/849-814/859-60/10SS	SN 5	Wainwright	pre-m	2	
512	notch filter GSM 850	WRCA 800/960-02/40-6EEK	SN 24	Wainwright	12 M	1c	30.06.2012
517	relais switch matrix	HF Relais Box Keithley System	SE 04	Keithley	pre-m	2	
523	Digital Multimeter	L4411A	MY46000154	Agilent	24 M	-	31.03.2013
529	6 dB Broadband resistive power divider	Model 1515	LH 855	Weinschel	pre-m	2	
530	10 dB Broadband resistive power divider	R 416110000	LOT 9828	-	pre-m	2	
546	Univ. Radio Communication Tester	CMU 200	106436	R&S	12 M	-	31.03.2012
547	Univ. Radio Communication Tester	CMU 200	835390/014	Rohde & Schwarz	12 M	-	31.03.2012
548	Digital-Barometer	GBP 2300	without	Greisinger GmbH	36/12 M	-	31.03.2012
549	Log.Per-Antenna	HL025	1000060	Rohde & Schwarz	36/12 M	-	31.03.2012
552	high pass filter 2,8-18GHz	WHKX 2.8/18G-10SS	4	Wainwright	12 M	1c	30.07.2012
558	System CTC FAR S-VSWR	System CTC FAR S-VSWR	-	CTC	24 M	-	31.07.2013
574	Biconilog Hybrid Antenna	BTA-L	980026L	Frankonia	36/12 M	-	30.03.2013
584	Spectrum Analyzer	FSU 8	100248	Rohde & Schwarz	12 M	-	31.03.2012
594	Univ. Radio Communication Tester	CMW500	101757	Rohde & Schwarz	24 M	-	31.03.2012
597	Univ. Radio Communication Tester	CMU 200	100347	Rohde & Schwarz	12 M	-	31.03.2012
598	Spectrum Analyzer	FSEM 30 (Reserve)	831259/013	Rohde & Schwarz	24 M	-	13.01.2013
600	power meter	NRVD (Reserve)	834501/018	Rohde & Schwarz	24 M	-	31.03.2013
601	medium-sensitivity diode sensor	NRV-Z5 (Reserve)	8435323/003	Rohde & Schwarz	24 M	-	12.01.2013
602	peak power sensor	NRV-Z32 (Reserve)	835080	Rohde & Schwarz	24 M	-	12.01.2013
608	UltraLog-Antenna	HL 562	830547/009	Rohde & Schwarz	36/12 M	-	31.03.2014
611	DC power supply	E3632A	KR 75305854	Agilent	pre-m	2	
612	DC power supply	E3632A	MY 40001321	Agilent	pre-m	2	
613	Attenuator	R416120000 20dB 10W	Lot. 9828	Radiall	pre-m	2	

7.1.3. Legend

Note / remarks		Calibrated during system calibration:
	1a	System CTC-SAR-EMS (Ref.-No. 442)
	1b	System-CTC-EMS-Conducted (Ref.-No. 335)
	1c	System CTC-FAR-EMI-RSE (Ref.-No. 443)
	1d	System CTC-SAR-EMI (Ref.-No. 441)
	1e	System CTC-OATS (EMI radiated) (Ref.-No. 337)
	1 f	System CTC-CTIA-OTA (Ref.-No. 420)
	1 g	System CTC-FAR-EMS (Ref.-No. 444)
	2	Calibration or equipment check immediately before measurement
	3	Regulatory maintained equipment for functional check or support purpose
	4	Ancillary equipment without calibration e.g. mechanical equipment or monitoring equipment
	5	Test System

Interval of calibration	12 M	12 month
-------------------------	------	----------

	24 M	24 month
	36 M	36 month
	24/12 M	Calibration every 24 months, between this every 12 months internal validation
	36/12 M	Calibration every 36 months, between this every 12 months internal validation
	Pre-m	Check before starting the measurement
	-	Without calibration