



FCC Part 15C Test Report

FCC ID:2AKBPESP8266-S3

Product Name:	ESP8266-S3
Trademark:	HYSIRY 汇思锐
Model Name :	ESP8266-S3, ESP8266-S2
Prepared For :	Shenzhen Hysiry Technology Co.,Ltd.
Address :	Room 406, Fourth floor, Buliding 1, Area D, Huameiju Decoration Materials City, Xinhua Road, Xin'an street, Bao'an District , Shenzhen, China
Prepared By :	Shenzhen BCTC Technology Co., Ltd.
Address :	No.101,Yousong Road,Longhua New District, Shenzhen,China
Test Date:	Jun. 22-Jul. 03, 2017
Date of Report :	Jul. 03, 2017
Report No.:	BCTC-LH170906041E



TEST RESULT CERTIFICATION

Applicant's name : **Shenzhen Hysiry Technology Co.,Ltd.**
Address : Room 406, Fourth floor, Buliding 1, Area D, Huameiju
 Decoration Materials City, Xihu Road, Xin'an street, Bao'an
 District , Shenzhen, China

Manufacture's Name..... : **Shenzhen Hysiry Technology Co.,Ltd.**
Address : Room 406, Fourth floor, Buliding 1, Area D, Huameiju
 Decoration Materials City, Xihu Road, Xin'an street, Bao'an
 District , Shenzhen, China

Product description

Product name : ESP8266-S3
Model and/or type reference : ESP8266-S2

Standards : FCC Part15.247
 ANSI C63.10:2013
 KDB 558074 D01 DTS Meas Guidance v04

This device described above has been tested by BCTC, and the test results show that the equipment under test (EUT) is in compliance with the FCC requirements. And it is applicable only to the tested sample identified in the report.

This report shall not be reproduced except in full, without the written approval of BCTC, this document may be altered or revised by BCTC, personal only, and shall be noted in the revision of the document.

Prepared by (Engineer)	Eric Yang	
Reviewer(Supervisor)	Jade Yang	
Approved(Manager)	Carson Zhang	

**Table of Contents**

	Page
1 . SUMMARY OF TEST RESULTS	5
1.1 TEST FACILITY	6
1.2 MEASUREMENT UNCERTAINTY	6
2 . GENERAL INFORMATION	7
2.1 GENERAL DESCRIPTION OF EUT	7
2.2 DESCRIPTION OF TEST MODES	8
2.3 BLOCK DIGRAM SHOWING THE CONFIGURATION OF SYSTEM TESTED	9
2.4 DESCRIPTION OF SUPPORT UNITS(CONDUCTED MODE)	10
2.5 EQUIPMENTS LIST FOR ALL TEST ITEMS	11
3 . EMC EMISSION TEST	12
3.1 CONDUCTED EMISSION MEASUREMENT	12
3.1.1 POWER LINE CONDUCTED EMISSION LIMITS	12
3.1.2 TEST PROCEDURE	12
3.1.3 DEVIATION FROM TEST STANDARD	12
3.1.4 TEST SETUP	13
3.1.5 EUT OPERATING CONDITIONS	13
3.1.6 TEST RESULTS	14
3.2 RADIATED EMISSION MEASUREMENT	16
3.2.1 RADIATED EMISSION LIMITS	16
3.2.2 TEST PROCEDURE	17
3.2.3 DEVIATION FROM TEST STANDARD	17
3.2.4 TEST SETUP	17
3.2.5 EUT OPERATING CONDITIONS	18
3.2.6 TEST RESULTS (BETWEEN 9KHZ – 30 MHZ)	19
3.2.7 TEST RESULTS (BETWEEN 30MHZ – 1GHZ)	20
3.2.8 TEST RESULTS (1GHZ~25GHZ)	22
3.3 RADIATED BAND EMISSION MEASUREMENT	26
3.3.1 TEST REQUIREMENT:	26
3.3.2 TEST PROCEDURE	26
3.3.3 DEVIATION FROM TEST STANDARD	27
3.3.4 TEST SETUP	27
3.3.5 EUT OPERATING CONDITIONS	27
4 . POWER SPECTRAL DENSITY TEST	34



Table of Contents		Page
4.1 APPLIED PROCEDURES / LIMIT		34
4.1.1 TEST PROCEDURE		34
4.1.2 DEVIATION FROM STANDARD		34
4.1.3 TEST SETUP		34
4.1.4 EUT OPERATION CONDITIONS		34
4.1.5 TEST RESULTS		35
5 . BANDWIDTH TEST		41
5.1 APPLIED PROCEDURES / LIMIT		41
5.1.1 TEST PROCEDURE		41
5.1.2 DEVIATION FROM STANDARD		41
5.1.3 TEST SETUP		41
5.1.4 EUT OPERATION CONDITIONS		41
5.1.5 TEST RESULTS		42
6 . PEAK OUTPUT POWER TEST		48
6.1 APPLIED PROCEDURES / LIMIT		48
6.1.1 TEST PROCEDURE		48
6.1.2 DEVIATION FROM STANDARD		48
6.1.3 TEST SETUP		48
6.1.4 EUT OPERATION CONDITIONS		48
6.1.5 TEST RESULTS		49
7 . 100 KHZ BANDWIDTH OF FREQUENCY BAND EDGE		50
7.1 APPLICABLE STANDARD		50
7.2 TEST PROCEDURE		50
7.3 DEVIATION FROM STANDARD		50
7.4 TEST SETUP		50
7.5 EUT OPERATION CONDITIONS		51
7.1 TEST RESULTS		51
8 . ANTENNA REQUIREMENT		55
8.1 STANDARD REQUIREMENT		55
8.2 EUT ANTENNA		55
9 . EUT TEST PHOTO		56
10 . EUT PHOTO		58
APPENDIX-PHOTOGRAPHS OF EUT CONSTRUCTIONAL DETAILS		



1. SUMMARY OF TEST RESULTS

Test procedures according to the technical standards:

FCC Part15 (15.247) , Subpart C			
Standard Section	Test Item	Judgment	Remark
15.207	Conducted Emission	PASS	
15.247 (a)(2)	6dB Bandwidth	PASS	
15.247 (b)	Peak Output Power	PASS	
15.247 (c)	Radiated Spurious Emission	PASS	
15.247 (d)	Power Spectral Density	PASS	
15.205	Band Edge Emission	PASS	
15.203	Antenna Requirement	PASS	

NOTE:

(1) "N/A" denotes test is not applicable in this Test Report



1.1 TEST FACILITY

Shenzhen BCTC Technology Co., Ltd.

Add. : No.101, Yousong Road, Longhua New District, Shenzhen, China

FCC Registered No.: 187086

1.2 MEASUREMENT UNCERTAINTY

The reported uncertainty of measurement $y \pm U$, where expanded uncertainty U is based on a standard uncertainty multiplied by a coverage factor of $k=2$, providing a level of confidence of approximately **95 %**.

No.	Item	Uncertainty
1	Conducted Emission Test	$\pm 1.38\text{dB}$
2	RF power, conducted	$\pm 0.16\text{dB}$
3	Spurious emissions, conducted	$\pm 0.21\text{dB}$
4	All emissions, radiated (<1G)	$\pm 4.68\text{dB}$
5	All emissions, radiated (>1G)	$\pm 4.89\text{dB}$
6	Temperature	$\pm 0.5^\circ\text{C}$
7	Humidity	$\pm 2\%$



2. GENERAL INFORMATION

2.1 GENERAL DESCRIPTION OF EUT

Equipment	ESP8266-S3	
Trade Name		
Model Name	ESP8266-S3, ESP8266-S2	
Model Difference	All the model are the same circuit and RF module, except model names.	
Product Description	The EUT is a ESP8266-S3	
	Operation Frequency:	802.11b/g/n20MHz:2412~2462 MHz
	Modulation Type:	WIFI: OFDM/DSSS
	Bit Rate of Transmitter	802.11b:11/5.5/2/1 Mbps 802.11g:54/48/36/24/18/12/9/6Mbps 802.11n:Up to 150Mbps
	Number Of Channel	802.11b/g/n20MHz:11 CH
	Antenna Designation:	Please see Note 3.
Based on the application, features, or specification exhibited in User's Manual, the EUT is considered as an ITE/Computing Device. More details of EUT technical specification, please refer to the User's Manual.		
Channel List	Please refer to the Note 2.	
Power supply	DC1.8-3.3V	
hardware version	--	
Software version	--	
Serial number	--	
Connecting I/O Port(s)	Please refer to the User's Manual	

Note:

1. For a more detailed features description, please refer to the manufacturer's specifications or the User's Manual.



2.

Channel List for 802.11b/g/n(20)							
Channel	Frequency (MHz)	Channel	Frequency (MHz)	Channel	Frequency (MHz)	Channel	Frequency (MHz)
01	2412	04	2427	07	2442	10	2457
02	2417	05	2432	08	2447	11	2462
03	2422	06	2437	09	2452		

3.

Table for Filed Antenna

Ant.	Brand	Model Name	Antenna Type	Connector	Gain (dBi)	NOTE
1	N/A	N/A	PCB antenna	N/A	0	WIFI antenna

2.2 DESCRIPTION OF TEST MODES

Pretest Mode	Description
Mode 1	802.11b CH1/ CH6/ CH11
Mode 2	802.11g CH1/ CH6/ CH11
Mode 3	802.11n20 CH1/ CH6/ CH11
Mode 4	Link Mode

Conducted Emission	
Final Test Mode	Description
Mode 4	Link Mode

For Radiated Emission	
Final Test Mode	Description
Mode 1	802.11b CH1/ CH6/ CH11
Mode 2	802.11g CH1/ CH6/ CH11
Mode 3	802.11n20 CH1/ CH6/ CH11

Note:

(1) The measurements are performed at all Bit Rate of Transmitter, the worst data was reported.

2.3 BLOCK DIGRAM SHOWING THE CONFIGURATION OF SYSTEM TESTED

Conducted Emission/

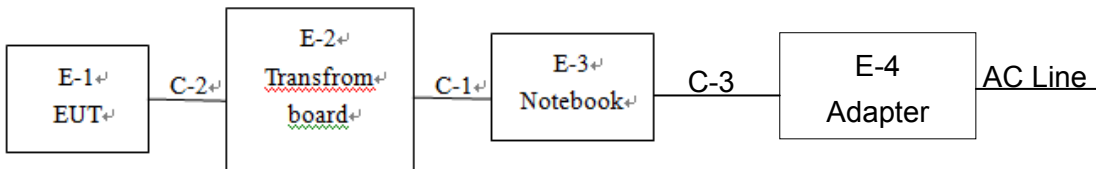

Radiated Spurious Emission Test

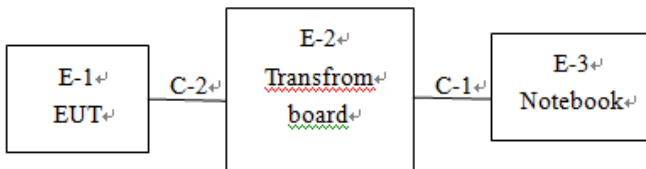

RF test setup:

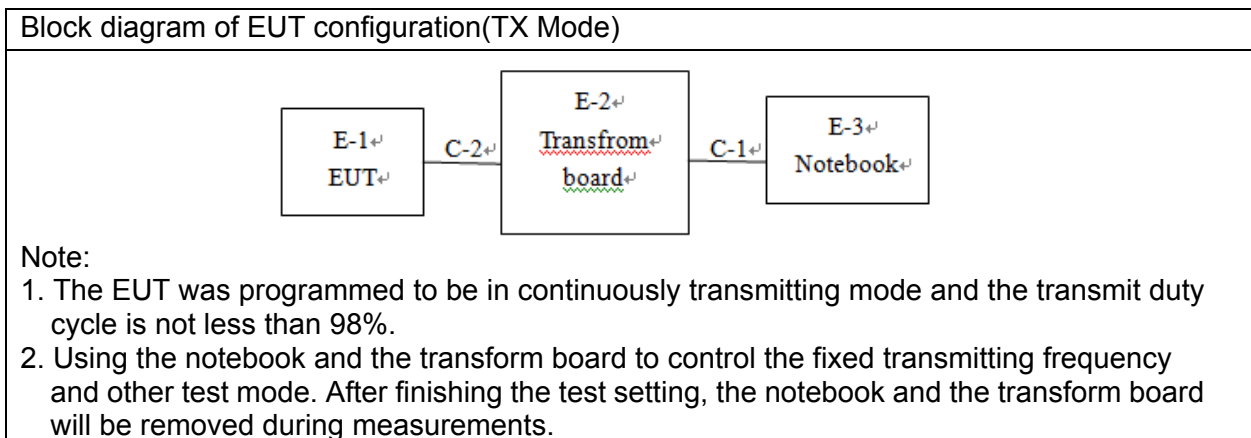



2.4 DESCRIPTION OF SUPPORT UNITS(CONDUCTED MODE)

The EUT has been tested as an independent unit together with other necessary accessories or support units. The following support units or accessories were used to form a representative test configuration during the tests.

Item	Equipment	Mfr/Brand	Model/Type No.	Series No.	Note
E-1	ESP8266-S3	HYSIRY 汇思锐	ESP8266-S3	N/A	EUT
E-2	Transfrom board	N/A	N/A	N/A	N/A
E-3	Notebook	Lenovo	S2	N/A	Lab Provide
E-4	Adapter	Lenovo	EXA0703YH	N/A	Lab Provide

Item	Shielded Type	Ferrite Core	Length	Note
C1	NO	NO	0.8M	USB cable unshielded
C2	NO	NO	0.5M	Connection cable unshielded
C3	NO	NO	1.2M	DC cable unshielded

Note:

- (1) The support equipment was authorized by Declaration of Confirmation.
- (2) For detachable type I/O cable should be specified the length in cm in 『Length』 column.

**2.5 EQUIPMENTS LIST FOR ALL TEST ITEMS**

Radiation Test equipment

Item	Equipment	Manufacturer	Type No.	Serial No.	Last calibration	Calibrated until
1	Spectrum Analyzer (9kHz-26.5GHz)	Agilent	E4407B	MY45108040	2016.08.27	2017.08.26
2	Test Receiver (9kHz-7GHz)	R&S	ESPI	101318	2016.08.27	2017.08.26
3	Bilog Antenna (30MHz-1GHz)	R&S	VULB 9168	VULB91 68-438	2016.08.27	2017.08.26
4	Horn Antenna (1GHz-18GHz)	SCHWARZBECK	BBHA9120D	1201	2016.09.03	2017.09.03
5	Horn Antenna (14GHz-40GHz)	SCHWARZBECK	BBHA 9170	9170-181	2016.09.03	2017.09.03
6	Amplifier (9kHz-6GHz)	SCHWARZBECK	BBV9744	9744-0037	2016.08.27	2017.08.26
7	Amplifier (1GHz-18GHz)	SCHWARZBECK	BBV9718	9718-309	2016.08.27	2017.08.26
8	Amplifier (18GHz-40GHz)	SCHWARZBECK	BBV 9721	9721-205	2016.08.27	2017.08.26
9	Loop Antenna (9kHz-30MHz)	SCHWARZBECK	FMZB1519B	00014	2016.09.03	2017.09.03
10	RF cables1 (9kHz-1GHz)	R&S	R203	R20X	2016.08.27	2017.08.26
11	RF cables2 (1GHz-40GHz)	R&S	R204	R21X	2016.08.27	2017.08.26
12	Antenna connector	Florida RF Labs	N/A	RF 01#	2016.08.27	2017.08.26
13	Power Metter	ANRITSU	ML2487A	6K00001568	2016.08.27	2017.08.26
14	Power Sensor (AV)	ANRITSU	ML2491A	030989	2016.08.27	2017.08.26
15	Signal Analyzer 9kHz-26.5GHz	Agilent	N9010A	MY48030494	2016.08.27	2017.08.26
16	Test Receiver 20kHz-40GHz	R&S	ESU 40	100376	2016.08.27	2017.08.26
17	D.C. Power Supply	LongWei	PS-305D	010964729	2016.08.27	2017.08.26

Conduction Test equipment

Item	Equipment	Manufacturer	Type No.	Serial No.	Last calibration	Calibrated until
1	Test Receiver	R&S	ESCI	1166.5950K03-1 01165-ha	2016.08.27	2017.08.26
2	LISN	SCHWARZBECK	NSLK8127	8127739	2016.08.27	2017.08.26
3	LISN	R&S	NSLK8126	8126487	2016.08.27	2017.08.26
4	RF cables	R&S	R204	R20X	2016.08.27	2017.08.26
5	Attenuator	R&S	ESH3-Z2	143206	2016.08.27	2017.08.26



3. EMC EMISSION TEST

3.1 CONDUCTED EMISSION MEASUREMENT

3.1.1 POWER LINE CONDUCTED EMISSION Limits (Frequency Range 150KHz-30MHz)

FREQUENCY (MHz)	Limit (dBuV)		Standard
	Quasi-peak	Average	
0.15 -0.5	66 - 56 *	56 - 46 *	FCC
0.50 -5.0	56.00	46.00	FCC
5.0 -30.0	60.00	50.00	FCC

Note:

- (1) The tighter limit applies at the band edges.
- (2) The limit of " * " marked band means the limitation decreases linearly with the logarithm of the frequency in the range.

The following table is the setting of the receiver

Receiver Parameters	Setting
Attenuation	10 dB
Start Frequency	0.15 MHz
Stop Frequency	30 MHz
IF Bandwidth	9 kHz

3.1.2 TEST PROCEDURE

- a. The EUT was placed 0.8 meters from the horizontal ground plane with EUT being connected to the power mains through a line impedance stabilization network (LISN). All other support equipments powered from additional LISN(s). The LISN provide 50 Ohm/ 50uH of coupling impedance for the measuring instrument.
- b. Interconnecting cables that hang closer than 40 cm to the ground plane shall be folded back and forth in the center forming a bundle 30 to 40 cm long.
- c. I/O cables that are not connected to a peripheral shall be bundled in the center. The end of the cable may be terminated, if required, using the correct terminating impedance. The overall length shall not exceed 1 m.
- d. LISN at least 80 cm from nearest part of EUT chassis.
- e. For the actual test configuration, please refer to the related Item –EUT Test Photos.

3.1.3 DEVIATION FROM TEST STANDARD

No deviation

3.1.4 TEST SETUP

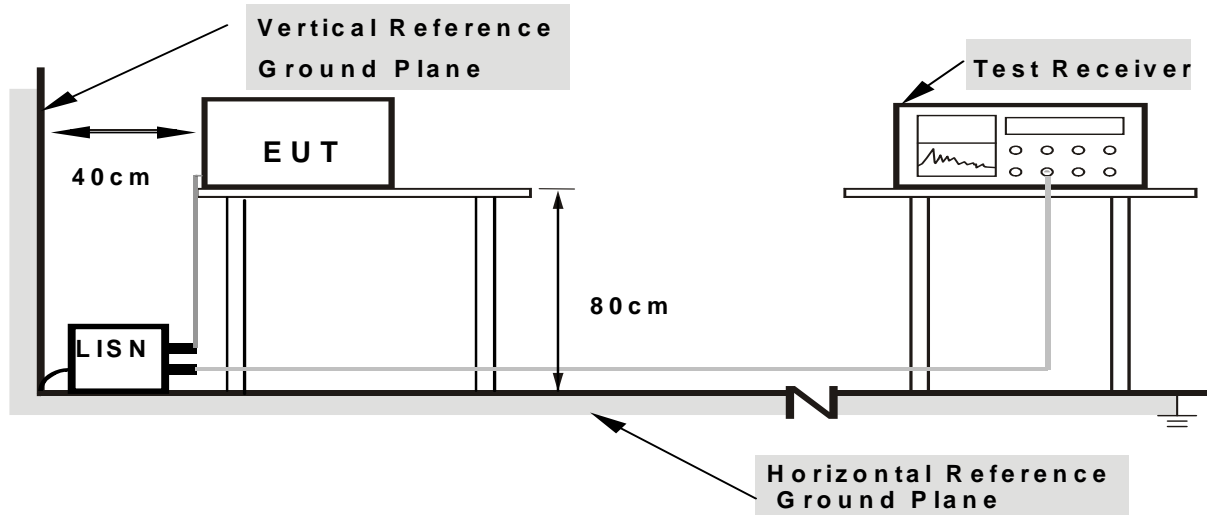

Note: 1. Support units were connected to second LISN.

2. Both of LISNs (AMN) are 80 cm from EUT and at least 80 cm from other units and other metal planes

3.1.5 EUT OPERATING CONDITIONS

The EUT was configured for testing in a typical fashion (as a customer would normally use it). The EUT has been programmed to continuously transmit during test. This operating condition was tested and used to collect the included data.

We pretest AC 120V and AC 240V, the worst voltage was AC 120V and the data recording in the report.



3.1.6 TEST RESULTS

Temperature :	26°C	Relative Humidity :	54%
Pressure :	1010hPa	Phase :	L
Test Voltage :	AC120V/60Hz	Test Mode :	Mode 4

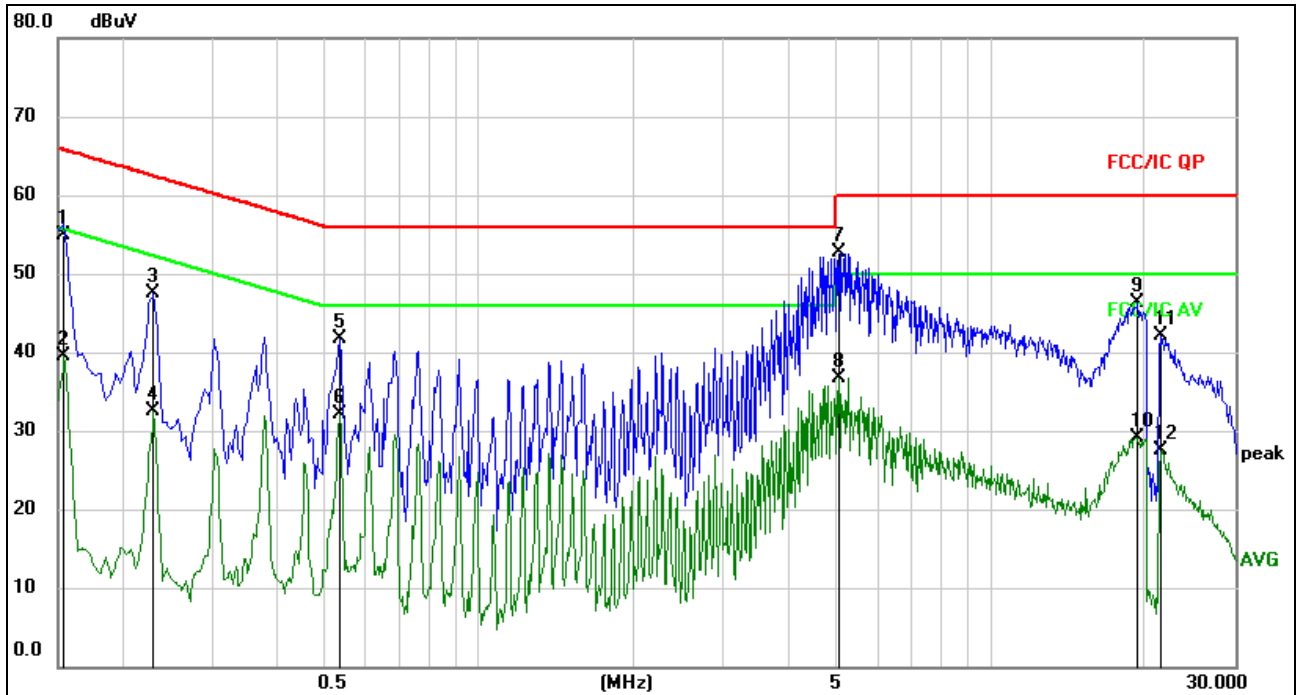

Remark:

1. All readings are Quasi-Peak and Average values.
2. Factor = Insertion Loss + Cable Loss.

No. Mk.	Freq. MHz	Reading Level dBuV	Correct Factor dB	Measure- ment dBuV	Limit dBuV	Over dB	Detector	Comment
1	0.1545	45.22	9.67	54.89	65.75	-10.86	QP	
2	0.1545	29.81	9.67	39.48	55.75	-16.27	AVG	
3	0.2310	37.84	9.65	47.49	62.41	-14.92	QP	
4	0.2310	22.95	9.65	32.60	52.41	-19.81	AVG	
5	0.5325	31.98	9.68	41.66	56.00	-14.34	QP	
6	0.5325	22.34	9.68	32.02	46.00	-13.98	AVG	
7 *	5.0370	42.99	9.74	52.73	60.00	-7.27	QP	
8	5.0370	26.95	9.74	36.69	50.00	-13.31	AVG	
9	19.2750	36.36	9.86	46.22	60.00	-13.78	QP	
10	19.2750	19.27	9.86	29.13	50.00	-20.87	AVG	
11	21.5520	32.19	9.84	42.03	60.00	-17.97	QP	
12	21.5520	17.60	9.84	27.44	50.00	-22.56	AVG	



Temperature :	26°C	Relative Humidity :	54%
Pressure :	1010hPa	Phase :	N
Test Voltage :	AC120V/60Hz	Test Mode :	Mode 4

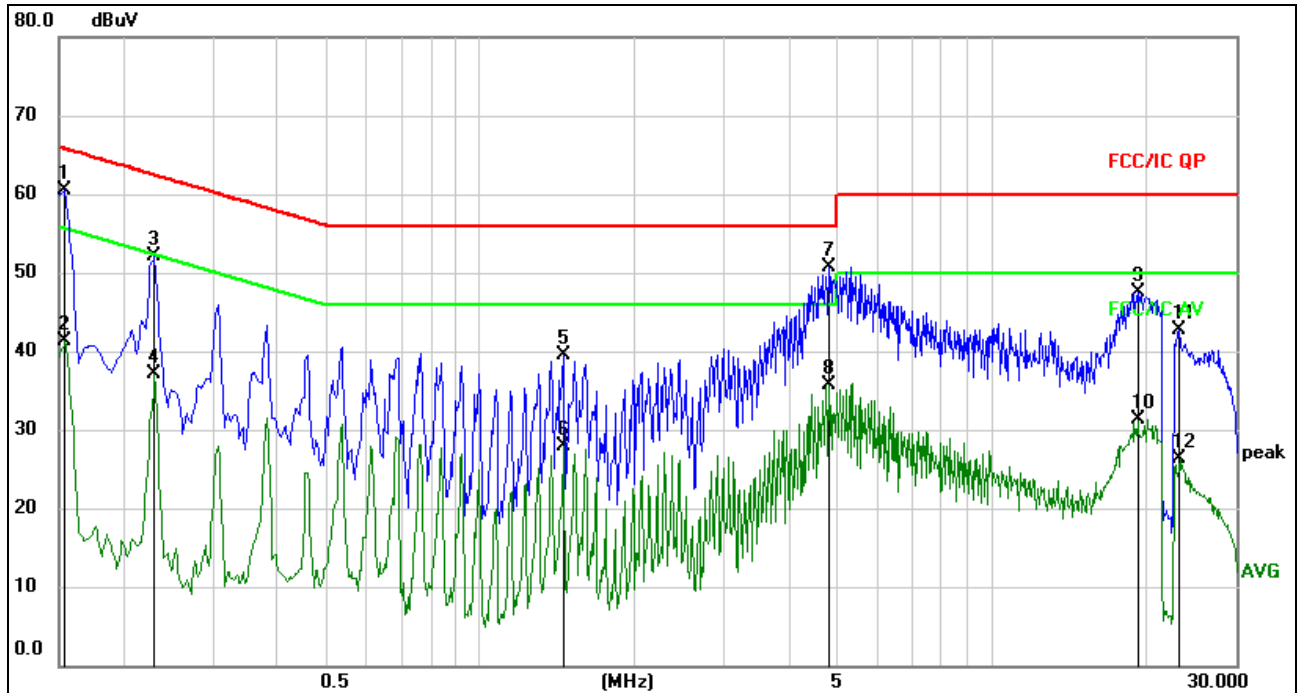

Remark:

1. All readings are Quasi-Peak and Average values.
2. Factor = Insertion Loss + Cable Loss.

No. Mk.	Freq. MHz	Reading Level dBuV	Correct Factor dB	Measure- ment dBuV	Limit dBuV	Over dB	Detector	Comment
1 *	0.1545	50.89	9.67	60.56	65.75	-5.19	QP	
2	0.1545	31.65	9.67	41.32	55.75	-14.43	AVG	
3	0.2310	42.45	9.65	52.10	62.41	-10.31	QP	
4	0.2310	27.48	9.65	37.13	52.41	-15.28	AVG	
5	1.4550	29.81	9.70	39.51	56.00	-16.49	QP	
6	1.4550	18.18	9.70	27.88	46.00	-18.12	AVG	
7	4.8165	40.88	9.74	50.62	56.00	-5.38	QP	
8	4.8165	26.01	9.74	35.75	46.00	-10.25	AVG	
9	19.2660	37.65	9.86	47.51	60.00	-12.49	QP	
10	19.2660	21.36	9.86	31.22	50.00	-18.78	AVG	
11	23.1944	32.78	9.86	42.64	60.00	-17.36	QP	
12	23.1944	16.51	9.86	26.37	50.00	-23.63	AVG	



3.2 RADIATED EMISSION MEASUREMENT

3.2.1 RADIATED EMISSION LIMITS (Frequency Range 9kHz-1000MHz)

20dBc in any 100 kHz bandwidth outside the operating frequency band. In case the emission fall within the restricted band specified on 15.205(a), then the 15.209(a) limit in the table below has to be followed.

Frequencies (MHz)	Field Strength (microrvolts/meter)	Measurement Distance (meters)
0.009~0.490	2400/F(KHz)	300
0.490~1.705	24000/F(KHz)	30
1.705~30.0	30	30
30~88	100	3
88~216	150	3
216~960	200	3
Above 960	500	3

LIMITS OF RADIATED EMISSION MEASUREMENT (Above 1000MHz)

FREQUENCY (MHz)	Limit (dBuV/m) (at 3M)	
	PEAK	AVERAGE
Above 1000	74	54

Notes:

- (1) The limit for radiated test was performed according to FCC PART 15C.
- (2) The tighter limit applies at the band edges.
- (3) Emission level (dBuV/m)=20log Emission level (uV/m).

Spectrum Parameter	Setting
Attenuation	Auto
Start Frequency	1000 MHz
Stop Frequency	25GHz
RB / VB (emission in restricted band)	1 MHz / 1 MHz for Peak, 1 MHz / 10Hz for Average

Receiver Parameter	Setting
Attenuation	Auto
Start ~ Stop Frequency	9kHz~150kHz / RB 200Hz for QP
Start ~ Stop Frequency	150kHz~30MHz / RB 9kHz for QP
Start ~ Stop Frequency	30MHz~1000MHz / RB 120kHz for QP

3.2.2 TEST PROCEDURE

Below 1GHz test procedure as below:

- a. The EUT was placed on the top of a rotating table 0.8 meters above the ground at a 3 meter semi-anechoic chamber. The table was rotated 360 degrees to determine the position of the highest radiation.
- b. The EUT was set 3 meters away from the interference-receiving antenna, which was mounted on the top of a variable-height antenna tower.
- c. The antenna height is varied from one meter to four meters above the ground to determine the maximum value of the field strength. Both horizontal and vertical polarizations of the antenna are set to make the measurement.
- d. For each suspected emission, the EUT was arranged to its worst case and then the antenna was tuned to heights from 1 meter to 4 meters (for the test frequency of below 30MHz, the antenna was tuned to heights 1 meter) and the rotatable table was turned from 0 degrees to 360 degrees to find the maximum reading.
- e. The test-receiver system was set to Peak Detect Function and Specified Bandwidth with Maximum Hold Mode.
- f. If the emission level of the EUT in peak mode was 10dB lower than the limit specified, then testing could be stopped and the peak values of the EUT would be reported. Otherwise the emissions that did not have 10dB margin would be re-tested one by one using peak, quasi-peak or average method as specified and then reported in a data sheet.

Above 1GHz test procedure as below:

- g. Different between above is the test site, change from Semi- Anechoic Chamber to fully Anechoic Chamber and change form table 0.8 metre to 1.5 metre(Above 18GHz the distance is 1 meter and table is 1.5 metre).
- h. Test the EUT in the lowest channel ,the middle channel ,the Highest channel

Note:

Both horizontal and vertical antenna polarities were tested and performed pretest to three orthogonal axis. The worst case emissions were reported

3.2.3 DEVIATION FROM TEST STANDARD

No deviation

3.2.4 TEST SETUP

(A) Radiated Emission Test-Up Frequency Below 30MHz

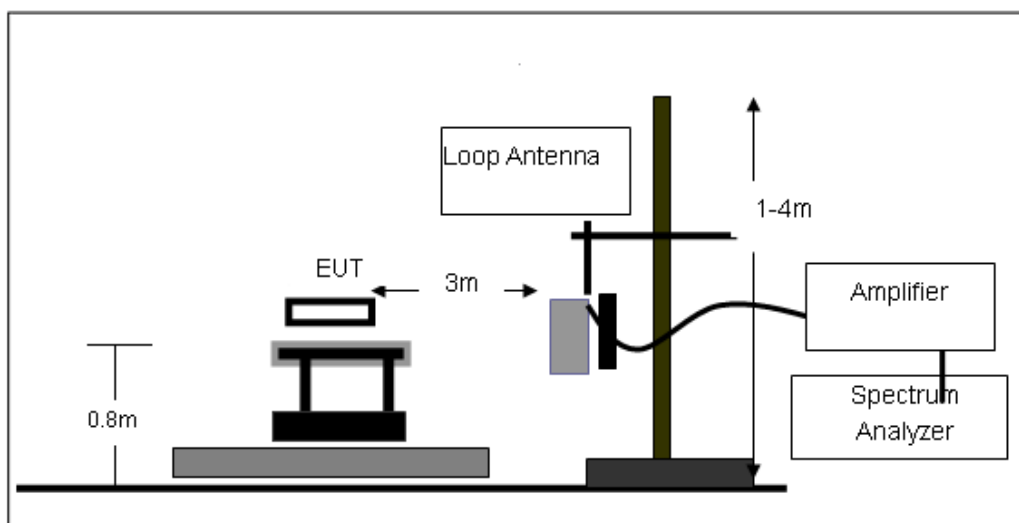

(B) Radiated Emission Test-Up Frequency 30MHz~1GHz

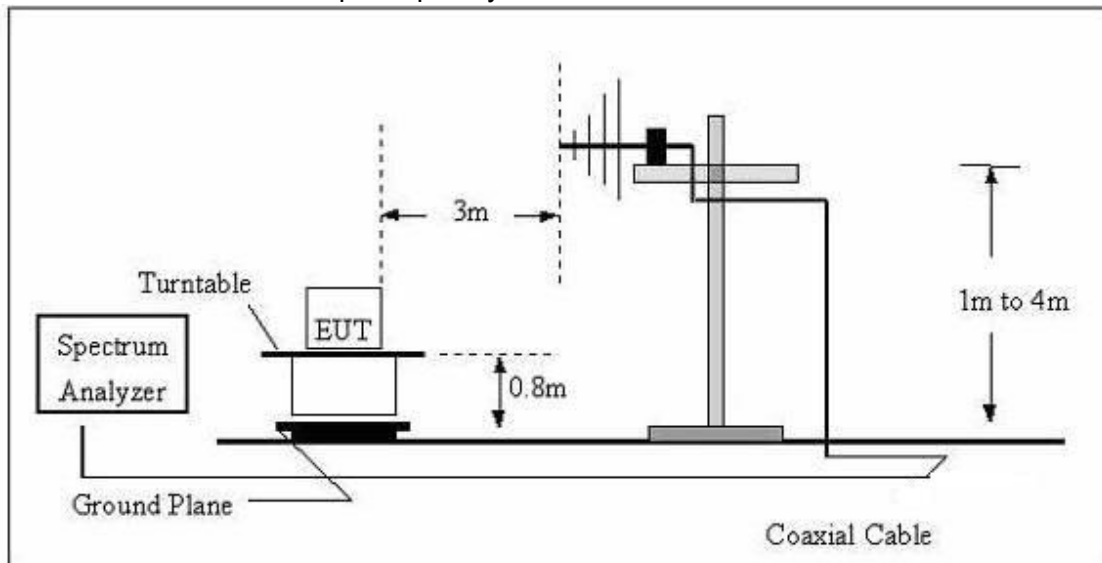

(C) Radiated Emission Test-Up Frequency Above 1GHz

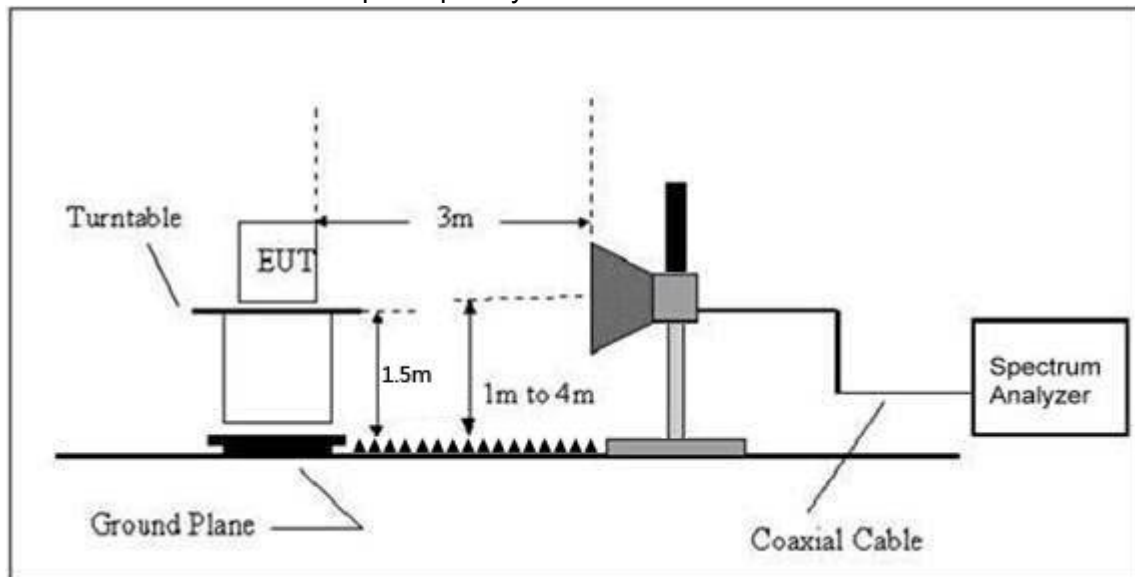

3.2.5 EUT OPERATING CONDITIONS

The EUT tested system was configured as the statements of 2.4 Unless otherwise a special operating condition is specified in the follows during the testing.

**3.2.6 TEST RESULTS (BETWEEN 9KHZ – 30 MHZ)**

Temperature:	20℃	Relative Humidity:	48%
Pressure:	1010 hPa	Test Voltage :	DC3.3V
Test Mode :	Mode 3	Polarization :	--

Freq. (MHz)	Reading (dBuV/m)	Limit (dBuV/m)	Margin (dB)	State P/F
--	--	--	--	PASS
--	--	--	--	PASS

NOTE:

The amplitude of spurious emissions which are attenuated by more than 20dB below the permissible value has no need to be reported.

Distance extrapolation factor = $40 \log(\text{specific distance}/\text{test distance})$ (dB);

Limit line = specific limits(dBuv) + distance extrapolation factor.

Correct Factor = Antenna Factor + Cable Loss – Pre-amplifier.



3.2.7 TEST RESULTS (BETWEEN 30MHZ – 1GHZ)

Temperature :	26°C	Relative Humidity :	54%
Pressure :	1010 hPa	Polarization :	Horizontal
Test Voltage :	DC3.3V		
Test Mode :	Mode 3		

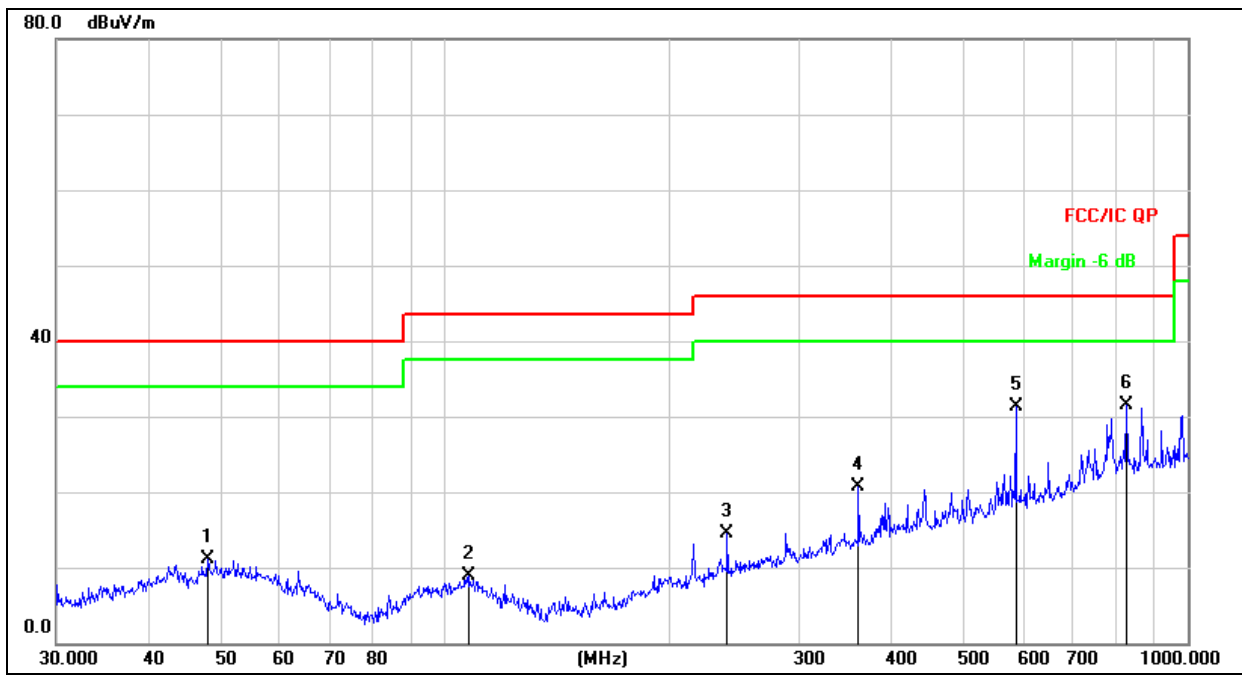

Remark:
Factor = Antenna Factor + Cable Loss – Pre-amplifier.

No.	Mk.	Freq. MHz	Reading Level dBuV	Correct Factor dB	Measure- ment dBuV/m	Limit dB/m	Over dB	Detector
1		47.9940	25.79	-14.72	11.07	40.00	-28.93	QP
2		107.8877	25.15	-16.33	8.82	43.50	-34.68	QP
3		239.9874	28.66	-14.12	14.54	46.00	-31.46	QP
4		360.4476	31.11	-10.40	20.71	46.00	-25.29	QP
5		586.8437	36.35	-4.96	31.39	46.00	-14.61	QP
6	*	827.4934	32.17	-0.75	31.42	46.00	-14.58	QP



Temperature :	26°C	Relative Humidity :	54%
Pressure :	1010 hPa	Polarization :	Vertical
Test Voltage :	DC3.3V		
Test Mode :	Mode 3		

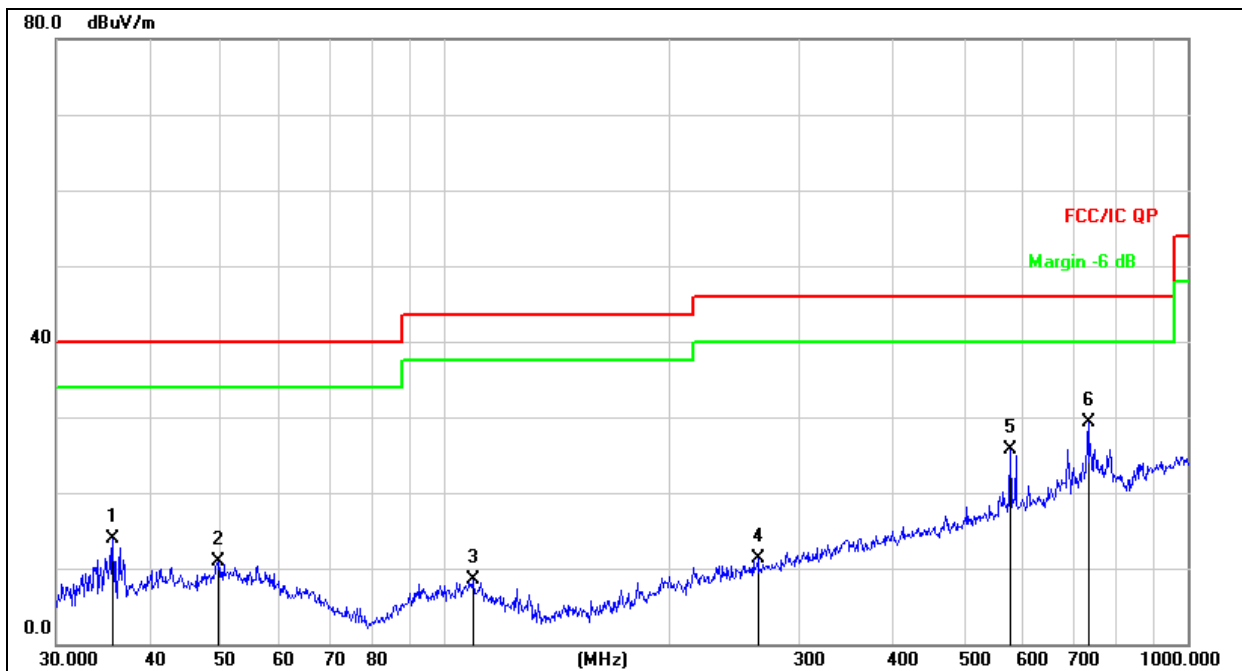

Remark:
Factor = Antenna Factor + Cable Loss – Pre-amplifier.

No.	Mk.	Freq.	Reading Level	Correct Factor	Measurement	Limit	Over	Detector
		MHz	dBuV	dB	dBuV/m	dB/m	dB	
1		35.7490	31.17	-17.19	13.98	40.00	-26.02	QP
2		49.5328	25.61	-14.71	10.90	40.00	-29.10	QP
3		109.0286	24.86	-16.41	8.45	43.50	-35.05	QP
4		263.8190	24.54	-13.28	11.26	46.00	-34.74	QP
5		576.6443	31.01	-5.31	25.70	46.00	-20.30	QP
6	*	734.4913	31.37	-2.16	29.21	46.00	-16.79	QP



3.2.8 TEST RESULTS (1GHZ~25GHZ)

802.11b									
Polar (H/V)	Frequency	Meter Reading	Pre-amplifier	Cable Loss	Antenna Factor	Emission Level	Limits	Margin	Detector Type
	(MHz)	(dBuV)	(dB)	(dB)	(dB)	(dBuV/m)	(dBuV/m)	(dB)	
Low Channel 2412MHz									
V	4824.00	68.61	39.55	7.85	25.66	62.57	74.00	-11.43	PK
V	4824.00	51.72	39.55	7.85	25.66	45.68	54.00	-8.32	AV
V	7236.00	64.38	38.33	7.52	24.55	58.12	74.00	-15.88	PK
V	7236.00	46.85	38.33	7.52	24.55	40.59	54.00	-13.41	AV
V	15450.00	50.32	35.23	6.75	26.59	48.43	74.00	-25.57	PK
H	4824.00	64.59	39.55	7.85	25.66	58.55	74.00	-15.45	PK
H	4824.00	49.65	39.55	7.85	25.66	43.61	54.00	-10.39	AV
H	7236.00	62.89	38.33	7.52	23.55	55.63	74.00	-18.37	PK
H	7236.00	49.78	38.33	7.52	23.22	42.19	54.00	-11.81	AV
H	15450.00	47.49	35.45	6.75	27.88	46.67	74.00	-27.33	PK

Polar (H/V)	Frequency	Meter Reading	Pre-amplifier	Cable Loss	Antenna Factor	Emission Level	Limits	Margin	Detector Type
	(MHz)	(dBuV)	(dB)	(dB)	(dB)	(dBuV/m)	(dBuV/m)	(dB)	
Mid Channel 2437MHz									
V	4874.00	68.38	38.89	7.57	25.45	62.51	74.00	-11.49	PK
V	4874.00	51.53	38.89	7.57	25.45	45.66	54.00	-8.34	AV
V	7311.00	65.21	38.78	7.35	24.78	58.56	74.00	-15.44	PK
V	7311.00	46.52	38.78	7.35	24.78	39.87	54.00	-14.13	AV
V	15450.00	51.72	35.89	6.42	26.47	48.72	74.00	-25.28	PK
H	4874.00	64.96	38.89	7.57	25.45	59.09	74.00	-14.91	PK
H	4874.00	50.19	38.89	7.57	25.45	44.32	54.00	-9.68	AV
H	7311.00	63.43	38.78	7.35	24.78	56.78	74.00	-17.22	PK
H	7311.00	48.68	38.78	7.35	24.78	42.03	54.00	-11.97	AV
H	15450.00	50.15	36.68	6.45	26.65	46.57	74.00	-27.43	PK

Polar (H/V)	Frequency	Meter Reading	Pre-amplifier	Cable Loss	Antenna Factor	Emission Level	Limits	Margin	Detector Type
	(MHz)	(dBuV)	(dB)	(dB)	(dB)	(dBuV/m)	(dBuV/m)	(dB)	
High Channel 2462MHz									
V	4924.00	66.90	38.75	7.46	25.45	61.06	74.00	-12.94	PK
V	4924.00	49.32	38.75	7.46	25.45	43.48	54.00	-10.52	AV
V	7386.00	68.00	38.65	7.22	24.78	61.35	74.00	-12.65	PK
V	7386.00	49.31	38.65	7.22	24.78	42.66	54.00	-11.34	AV
V	15450.00	51.41	35.58	6.35	26.47	48.65	74.00	-25.35	PK
H	4924.00	63.45	38.75	7.46	25.45	57.61	74.00	-16.39	PK
H	4924.00	47.55	38.75	7.46	25.45	41.71	54.00	-12.29	AV
H	7386.00	53.83	38.65	7.22	24.78	47.18	74.00	-26.82	PK
H	7386.00	46.98	38.65	7.22	24.78	40.33	54.00	-13.67	AV
H	15450.00	49.30	36.42	6.32	26.65	45.85	74.00	-28.15	PK



Remark:

1. Emission Level = Meter Reading + Antenna Factor + Cable Loss – Pre-amplifier,
Margin= Emission Level - Limit
2. If peak below the average limit, the average emission was no test.
3. The amplitude of spurious emissions which are attenuated by more than 20dB below the permissible value has no need to be reported.



802.11g									
Polar (H/V)	Frequency	Meter Reading	Pre-amplifier	Cable Loss	Antenna Factor	Emission Level	Limits	Margin	Detector Type
	(MHz)	(dBuV)	(dB)	(dB)	(dB)	(dBuV/m)	(dBuV/m)	(dB)	
Low Channel 2412MHz									
V	4824.00	65.56	39.55	7.85	25.66	59.52	74.00	-14.48	PK
V	4824.00	48.94	39.55	7.85	25.66	42.90	54.00	-11.10	AV
V	7236.00	59.79	38.33	7.52	24.55	53.53	74.00	-20.47	PK
V	7236.00	47.24	38.33	7.52	24.55	40.98	54.00	-13.02	AV
V	15450.00	48.52	35.23	6.75	26.59	46.63	74.00	-27.37	PK
H	4824.00	64.11	39.55	7.85	25.66	58.07	74.00	-15.93	PK
H	4824.00	49.93	39.55	7.85	25.66	43.89	54.00	-10.11	AV
H	7236.00	50.51	38.33	7.52	23.55	43.25	74.00	-30.75	PK
H	7236.00	49.04	38.33	7.52	23.22	41.45	54.00	-12.55	AV
H	15450.00	49.29	35.45	6.75	27.88	48.47	74.00	-25.53	PK

Polar (H/V)	Frequency	Meter Reading	Pre-amplifier	Cable Loss	Antenna Factor	Emission Level	Limits	Margin	Detector Type
	(MHz)	(dBuV)	(dB)	(dB)	(dB)	(dBuV/m)	(dBuV/m)	(dB)	
Mid Channel 2437MHz									
V	4874.00	67.43	38.89	7.57	25.45	61.56	74.00	-12.44	PK
V	4874.00	48.87	38.89	7.57	25.45	43.00	54.00	-11.00	AV
V	7311.00	56.56	38.78	7.35	24.78	49.91	74.00	-24.09	PK
V	7311.00	49.28	38.78	7.35	24.78	42.63	54.00	-11.37	AV
V	15450.00	50.55	35.89	6.42	26.47	47.55	74.00	-26.45	PK
H	4874.00	64.48	38.89	7.57	25.45	58.61	74.00	-15.39	PK
H	4874.00	50.07	38.89	7.57	25.45	44.20	54.00	-9.80	AV
H	7311.00	51.21	38.78	7.35	24.78	44.56	74.00	-29.44	PK
H	7311.00	49.80	38.78	7.35	24.78	43.15	54.00	-10.85	AV
H	15450.00	50.74	36.68	6.45	26.65	47.16	74.00	-26.84	PK

Polar (H/V)	Frequency	Meter Reading	Pre-amplifier	Cable Loss	Antenna Factor	Emission Level	Limits	Margin	Detector Type
	(MHz)	(dBuV)	(dB)	(dB)	(dB)	(dBuV/m)	(dBuV/m)	(dB)	
High Channel 2462MHz									
V	4924.00	64.97	38.75	7.46	25.45	59.13	74.00	-14.87	PK
V	4924.00	50.56	38.75	7.46	25.45	44.72	54.00	-9.28	AV
V	7386.00	55.06	38.65	7.22	24.78	48.41	74.00	-25.59	PK
V	7386.00	48.85	38.65	7.22	24.78	42.20	54.00	-11.80	AV
V	15450.00	50.60	35.58	6.35	26.47	47.84	74.00	-26.16	PK
H	4924.00	62.83	38.75	7.46	25.45	56.99	74.00	-17.01	PK
H	4924.00	48.22	38.75	7.46	25.45	42.38	54.00	-11.62	AV
H	7386.00	52.18	38.65	7.22	24.78	45.53	74.00	-28.47	PK
H	7386.00	47.87	38.65	7.22	24.78	41.22	54.00	-12.78	AV
H	15450.00	49.21	36.42	6.32	26.65	45.76	74.00	-28.24	PK

Remark:

1. Emission Level = Meter Reading + Antenna Factor + Cable Loss – Pre-amplifier, Margin= Emission Level - Limit
2. If peak below the average limit, the average emission was no test.
3. The amplitude of spurious emissions which are attenuated by more than 20dB below the permissible value has no need to be reported.



802.11n(20MHz)

Polar (H/V)	Frequency	Meter Reading	Pre-amplifier	Cable Loss	Antenna Factor	Emission Level	Limits	Margin	Detector Type
	(MHz)	(dBuV)	(dB)	(dB)	(dB)	(dBuV/m)	(dBuV/m)	(dB)	
Low Channel 2412MHz									
V	4824.00	64.23	39.55	7.85	25.66	58.19	74.00	-15.81	PK
V	4824.00	47.50	39.55	7.85	25.66	41.46	54.00	-12.54	AV
V	7236.00	52.62	38.33	7.52	24.55	46.36	74.00	-27.64	PK
V	7236.00	49.72	38.33	7.52	24.55	43.46	54.00	-10.54	AV
V	15450.00	48.40	35.23	6.75	26.59	46.51	74.00	-27.49	PK
H	4824.00	61.82	39.55	7.85	25.66	55.78	74.00	-18.22	PK
H	4824.00	46.08	39.55	7.85	25.66	40.04	54.00	-13.96	AV
H	7236.00	52.69	38.33	7.52	23.55	45.43	74.00	-28.57	PK
H	7236.00	49.57	38.33	7.52	23.22	41.98	54.00	-12.02	AV
H	15450.00	48.54	35.45	6.75	27.88	47.72	74.00	-26.28	PK

Polar (H/V)	Frequency	Meter Reading	Pre-amplifier	Cable Loss	Antenna Factor	Emission Level	Limits	Margin	Detector Type
	(MHz)	(dBuV)	(dB)	(dB)	(dB)	(dBuV/m)	(dBuV/m)	(dB)	
Mid Channel 2437MHz									
V	4874.00	66.33	38.89	7.57	25.45	60.46	74.00	-13.54	PK
V	4874.00	55.15	38.89	7.57	25.45	49.28	54.00	-4.72	AV
V	7311.00	56.24	38.78	7.35	24.78	49.59	74.00	-24.41	PK
V	7311.00	49.52	38.78	7.35	24.78	42.87	54.00	-11.13	AV
V	15450.00	51.19	35.89	6.42	26.47	48.19	74.00	-25.81	PK
H	4874.00	64.57	38.89	7.57	25.45	58.70	74.00	-15.30	PK
H	4874.00	49.44	38.89	7.57	25.45	43.57	54.00	-10.43	AV
H	7311.00	53.68	38.78	7.35	24.78	47.03	74.00	-26.97	PK
H	7311.00	50.47	38.78	7.35	24.78	43.82	54.00	-10.18	AV
H	15450.00	51.88	36.68	6.45	26.65	48.30	74.00	-25.70	PK

Polar (H/V)	Frequency	Meter Reading	Pre-amplifier	Cable Loss	Antenna Factor	Emission Level	Limits	Margin	Detector Type
	(MHz)	(dBuV)	(dB)	(dB)	(dB)	(dBuV/m)	(dBuV/m)	(dB)	
High Channel 2462MHz									
V	4924.00	66.98	38.75	7.46	25.45	61.14	74.00	-12.86	PK
V	4924.00	51.09	38.75	7.46	25.45	45.25	54.00	-8.75	AV
V	7386.00	56.88	38.65	7.22	24.78	50.23	74.00	-23.77	PK
V	7386.00	49.61	38.65	7.22	24.78	42.96	54.00	-11.04	AV
V	15450.00	52.50	35.58	6.35	26.47	49.74	74.00	-24.26	PK
H	4924.00	62.02	38.75	7.46	25.45	56.18	74.00	-17.82	PK
H	4924.00	48.99	38.75	7.46	25.45	43.15	54.00	-10.85	AV
H	7386.00	51.91	38.65	7.22	24.78	45.26	74.00	-28.74	PK
H	7386.00	50.46	38.65	7.22	24.78	43.81	54.00	-10.19	AV
H	15450.00	50.91	36.42	6.32	26.65	47.46	74.00	-26.54	PK

Remark:

1. Emission Level = Meter Reading + Antenna Factor + Cable Loss – Pre-amplifier, Margin= Emission Level - Limit
2. If peak below the average limit, the average emission was no test.
3. The amplitude of spurious emissions which are attenuated by more than 20dB below the permissible value has no need to be reported.



3.3 RADIATED BAND EMISSION MEASUREMENT

3.3.1 TEST REQUIREMENT:

FCC Part15 C Section 15.209 and 15.205

LIMITS OF RADIATED EMISSION MEASUREMENT (Above 1000MHz)

FREQUENCY (MHz)	Limit (dBuV/m) (at 3M)	
	PEAK	AVERAGE
Above 1000	74	54

Notes:

- (1) The limit for radiated test was performed according to FCC PART 15C.
- (2) The tighter limit applies at the band edges.
- (3) Emission level (dBuV/m)=20log Emission level (uV/m).

Spectrum Parameter	Setting
Attenuation	Auto
Start Frequency	2300MHz
Stop Frequency	2520
RB / VB (emission in restricted band)	1 MHz / 1 MHz for Peak, 1 MHz / 10Hz for Average

3.3.2 TEST PROCEDURE

Above 1GHz test procedure as below:

- a. 1. The EUT was placed on the top of a rotating table 1.5 meters above the ground at a 3 meter camber. The table was rotated 360 degrees to determine the position of the highest radiation.
- b. The EUT was set 3 meters away from the interference-receiving antenna, which was mounted on the top of a variable-height antenna tower.
- c. The antenna height is varied from one meter to four meters above the ground to determine the maximum value of the field strength. Both horizontal and vertical polarizations of the antenna are set to make the measurement.
- d. For each suspected emission, the EUT was arranged to its worst case and then the antenna was tuned to heights from 1 meter to 4 meters and the rota table was turned from 0 degrees to 360 degrees to find the maximum reading.
- e. The test-receiver system was set to Peak Detect Function and Specified Bandwidth with Maximum Hold Mode.
- f. If the emission level of the EUT in peak mode was 10dB lower than the limit specified, then testing could be stopped and the peak values of the EUT would be reported. Otherwise the emissions that did not have 10dB margin would be re-tested one by one using peak, quasi-peak or average method as specified and then reported in a data sheet.
- g. Test the EUT in the lowest channel,the Highest channel

Note:

Both horizontal and vertical antenna polarities were tested and performed pretest to three orthogonal axis. The worst case emissions were reported

3.3.3 DEVIATION FROM TEST STANDARD

No deviation

3.3.4 TEST SETUP

Radiated Emission Test-Up Frequency Above 1GHz

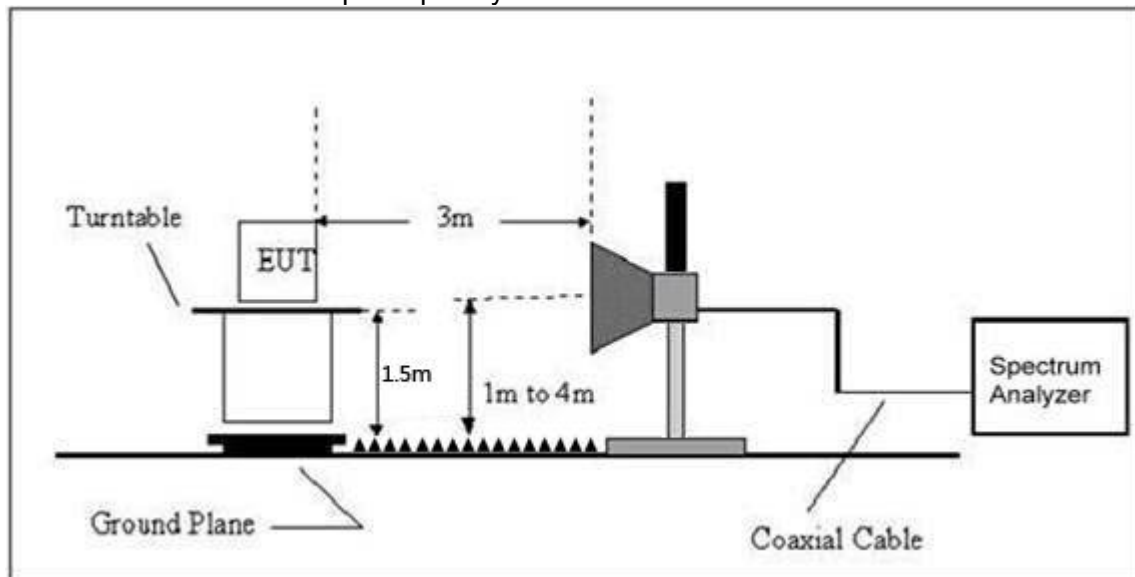

3.3.5 EUT OPERATING CONDITIONS

The EUT tested system was configured as the statements of 2.3 Unless otherwise a special operating condition is specified in the follows during the testing.



802.11b

Polar (H/V)	Frequency (MHz)	Meter Reading (dBuV)	Pre-amplifier (dB)	Cable Loss (dB)	Antenna Factor (dB/m)	Emission evel (dBuV/m)	Limits (dBuV/m)		Result
						PK	PK	AV	
Low Channel 2412MHz									
H	2390.00	54.63	38.06	7.42	20.15	44.14	74.00	54.00	PASS
H	2400.00	58.56	38.06	7.42	20.15	48.07	74.00	54.00	PASS
V	2390.00	53.72	38.06	7.42	20.15	43.23	74.00	54.00	PASS
V	2400.00	57.45	38.06	7.42	20.15	46.96	74.00	54.00	PASS

Remark:

1. Emission Level = Meter Reading + Factor, Margin= Emission Level - Limit
2. If peak below the average limit, the average emission was no test.
3. The amplitude of spurious emissions which are attenuated by more than 20dB below the permissible value has no need to be reported.

Horizontal

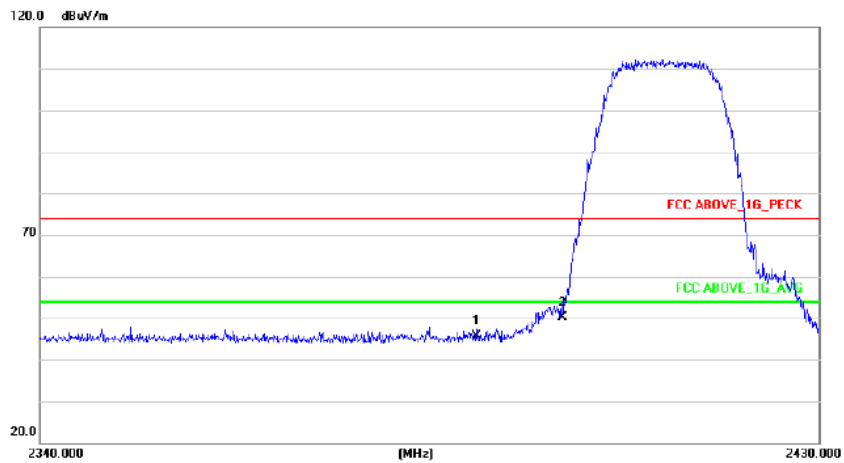

Vertical

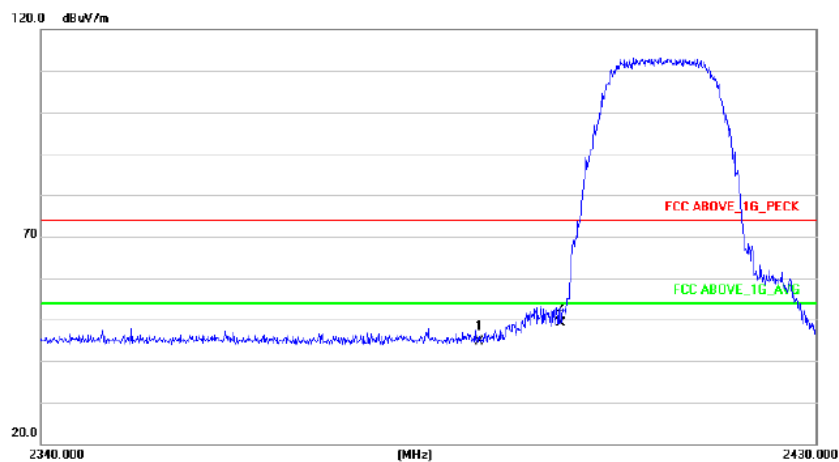



Polar (H/V)	Frequency (MHz)	Meter Reading (dBuV)	Pre-amplifier (dB)	Cable Loss (dB)	Antenna Factor (dB/m)	Emission evel (dBuV/m)	Limits (dBuV/m)		Result
						PK	PK	AV	
High Channel 2462MHz									
H	2483.50	55.10	38.17	7.42	20.51	44.86	74.00	54.00	PASS
H	2500.00	59.34	38.17	7.42	20.51	49.10	74.00	54.00	PASS
V	2485.50	53.94	38.2	7.45	20.54	43.73	74.00	54.00	PASS
V	2500.00	57.86	38.2	7.45	20.54	47.65	74.00	54.00	PASS

Horizontal

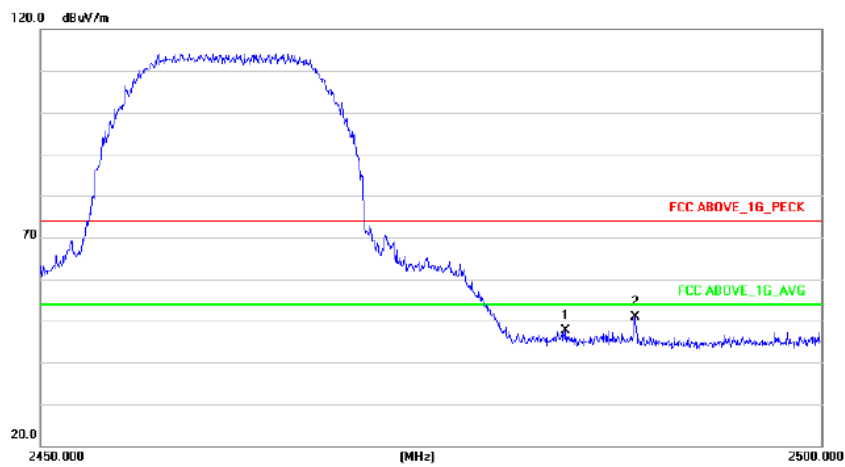

Vertical

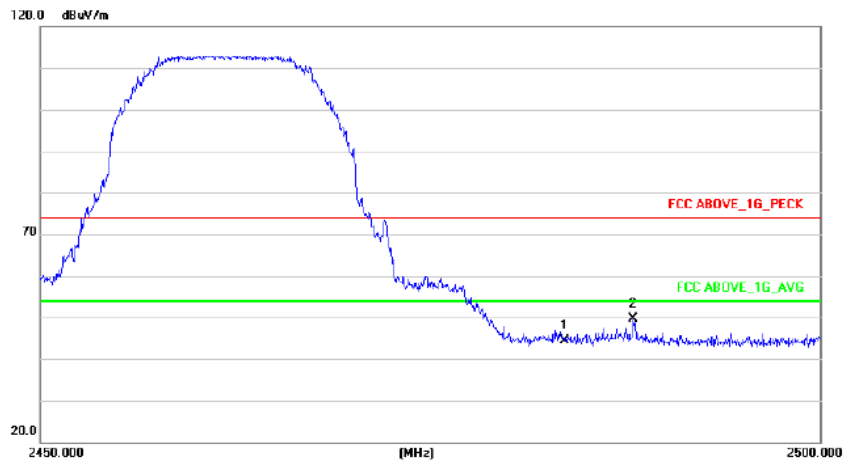



802.11g

Polar (H/V)	Frequency (MHz)	Meter Reading (dBuV)	Pre-amplifier (dB)	Cable Loss (dB)	Antenna Factor (dB/m)	Emission level (dBuV/m)	Limits (dBuV/m)		Result
						PK	PK	AV	
Low Channel 2412MHz									
H	2390.00	58.70	38.06	7.42	20.15	48.21	74.00	54.00	PASS
H	2400.00	61.64	38.06	7.42	20.15	51.15	74.00	54.00	PASS
V	2390.00	59.25	38.06	7.42	20.15	48.76	74.00	54.00	PASS
V	2400.00	59.66	38.06	7.42	20.15	49.17	74.00	54.00	PASS

Remark:

1. Emission Level = Meter Reading + Factor, Margin= Emission Level - Limit
2. If peak below the average limit, the average emission was no test.
3. The amplitude of spurious emissions which are attenuated by more than 20dB below the permissible value has no need to be reported.

Horizontal

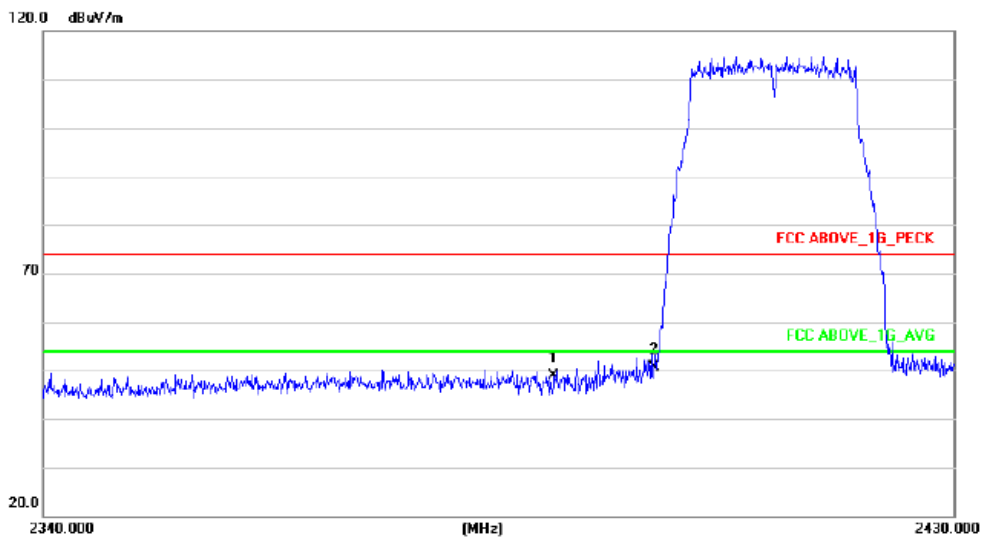

Vertical

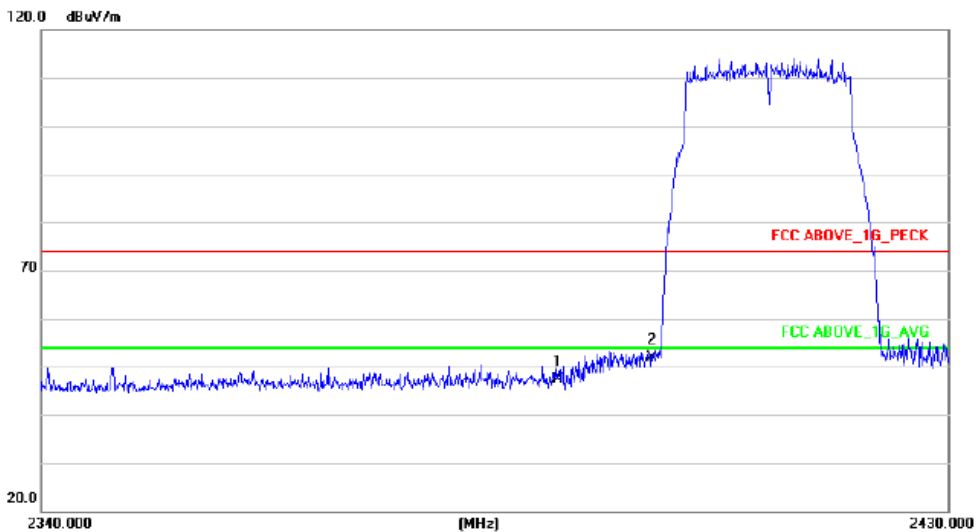



Polar (H/V)	Frequency (MHz)	Meter Reading (dBuV)	Pre-amplifier (dB)	Cable Loss (dB)	Antenna Factor (dB/m)	Emission level (dBuV/m)	Limits (dBuV/m)		Result
						PK	PK	AV	
High Channel 2462MHz									
H	2483.50	56.69	38.17	7.42	20.51	46.45	74.00	54.00	PASS
H	2500.00	57.94	38.17	7.42	20.51	47.70	74.00	54.00	PASS
V	2485.50	55.85	38.2	7.45	20.54	45.64	74.00	54.00	PASS
V	2500.00	56.46	38.2	7.45	20.54	46.25	74.00	54.00	PASS

Horizontal

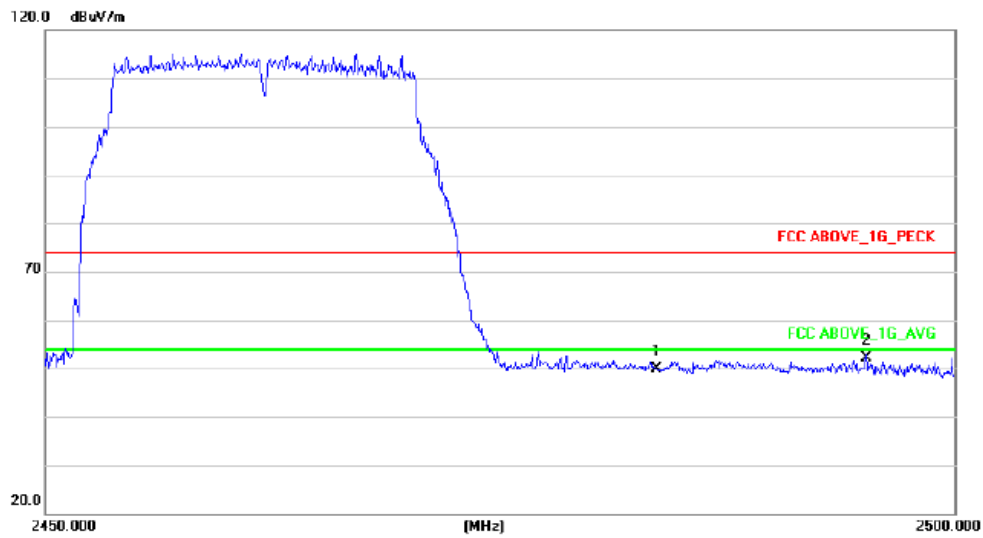

Vertical

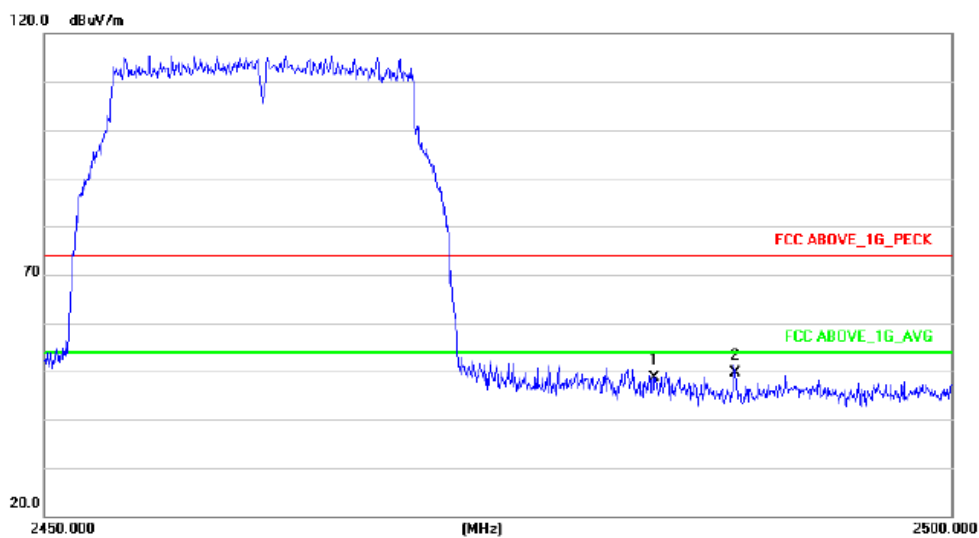



802.11n(20MHz)

Polar (H/V)	Frequency (MHz)	Meter Reading (dBuV)	Pre-amplifier (dB)	Cable Loss (dB)	Antenna Factor (dB/m)	Emission level (dBuV/m)	Limits (dBuV/m)		Result
						PK	PK	AV	
Low Channel 2412MHz									
H	2390.00	55.19	38.06	7.42	20.15	44.70	74.00	54.00	PASS
H	2400.00	58.22	38.06	7.42	20.15	47.73	74.00	54.00	PASS
V	2390.00	55.36	38.06	7.42	20.15	44.87	74.00	54.00	PASS
V	2400.00	58.70	38.06	7.42	20.15	48.21	74.00	54.00	PASS

Remark:

1. Emission Level = Meter Reading + Factor, Margin= Emission Level - Limit
2. If peak below the average limit, the average emission was no test.
3. The amplitude of spurious emissions which are attenuated by more than 20dB below the permissible value has no need to be reported.

Horizontal

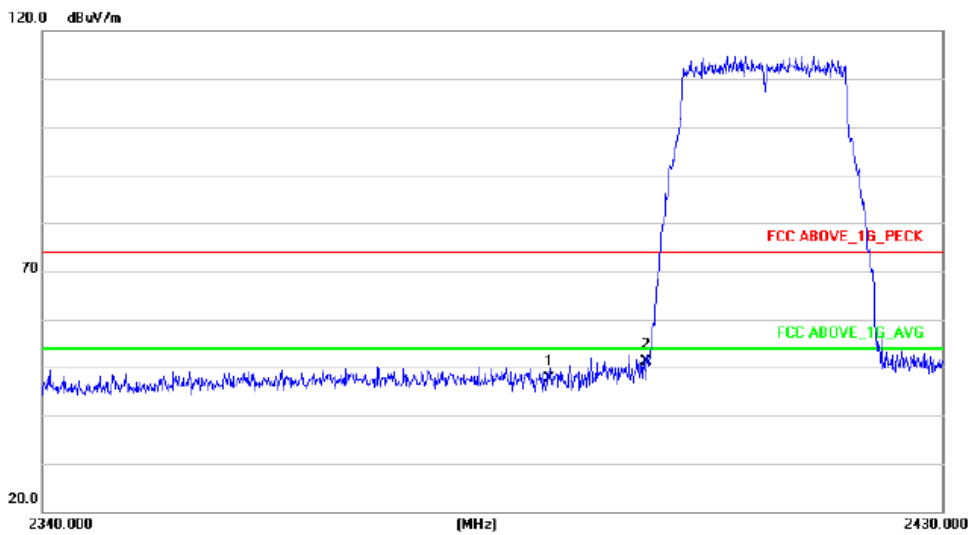

Vertical

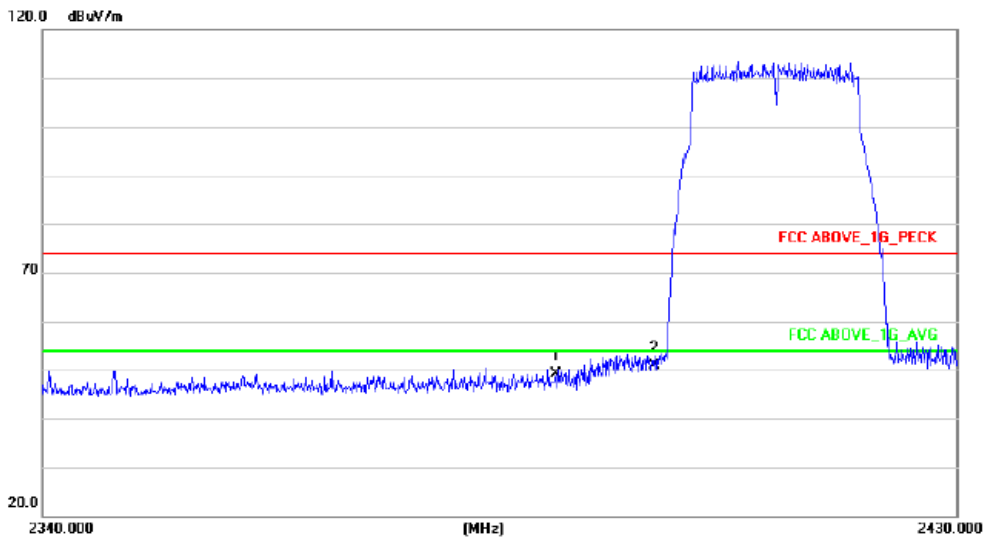



Polar (H/V)	Frequency (MHz)	Meter Reading (dBuV)	Pre-amplifier (dB)	Cable Loss (dB)	Antenna Factor (dB/m)	Emission level (dBuV/m)	Limits (dBuV/m)		Result
						PK	PK	AV	
High Channel 2462MHz									
H	2483.50	59.38	38.17	7.42	20.51	49.14	74.00	54.00	PASS
H	2500.00	58.27	38.17	7.42	20.51	48.03	74.00	54.00	PASS
V	2485.50	56.87	38.2	7.45	20.54	46.66	74.00	54.00	PASS
V	2500.00	57.45	38.2	7.45	20.54	47.24	74.00	54.00	PASS

Remark:

1. Emission Level = Meter Reading + Factor, Margin= Emission Level - Limit
2. If peak below the average limit, the average emission was no test.
3. The amplitude of spurious emissions which are attenuated by more than 20dB below the permissible value has no need to be reported.

Horizontal

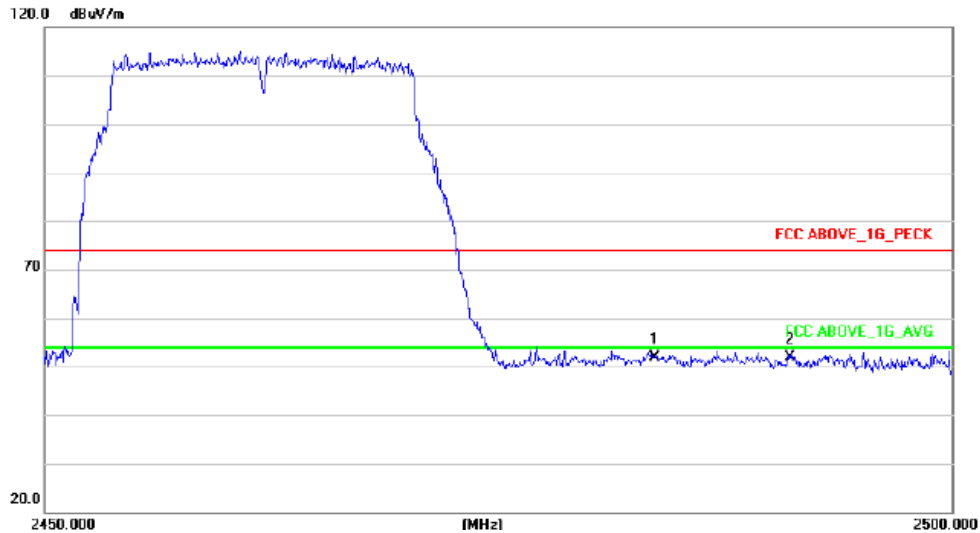

Vertical

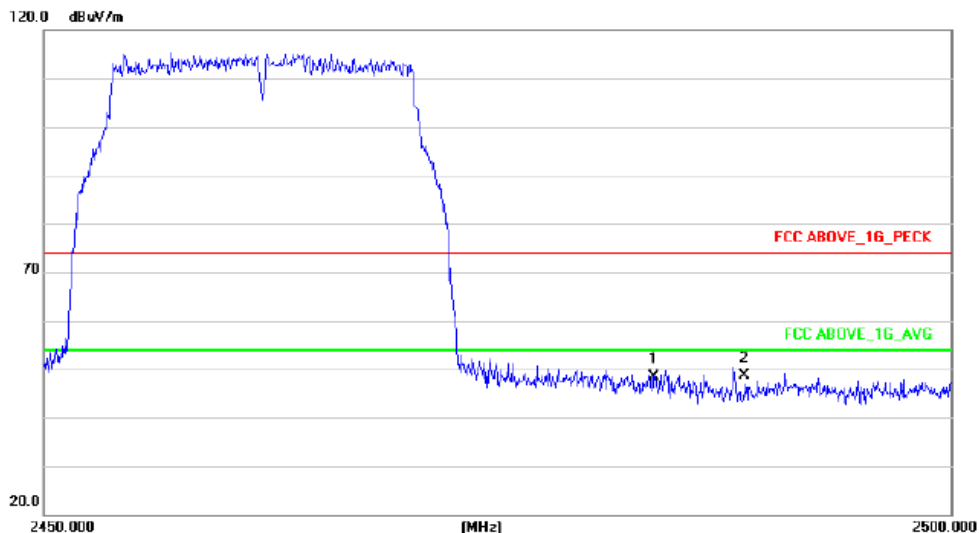



4. POWER SPECTRAL DENSITY TEST

4.1 APPLIED PROCEDURES / LIMIT

FCC Part15 (15.247) , Subpart C				
Section	Test Item	Limit	Frequency Range (MHz)	Result
15.247	Power Spectral Density	8 dBm (in any 3KHz)	2400-2483.5	PASS

4.1.1 TEST PROCEDURE

1. Set analyzer center frequency to DTS channel center frequency.
2. Set the span to 1.5 times the DTS bandwidth.
3. Set the RBW to: $3 \text{ kHz} \leq \text{RBW} \leq 100 \text{ kHz}$.
4. Set the VBW $\geq 3 \times \text{RBW}$.
5. Detector = peak.
6. Sweep time = auto couple.
7. Trace mode = max hold.
8. Allow trace to fully stabilize.
9. Use the peak marker function to determine the maximum amplitude level within the RBW.
10. If measured value exceeds limit, reduce RBW (no less than 3 kHz) and repeat.

4.1.2 DEVIATION FROM STANDARD

No deviation.

4.1.3 TEST SETUP

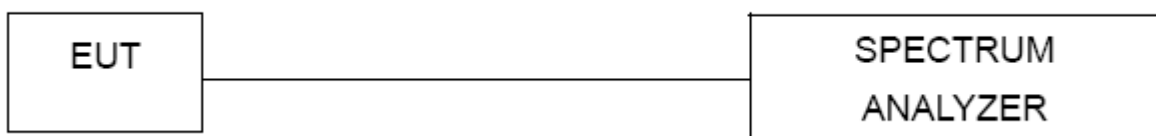

4.1.4 EUT OPERATION CONDITIONS

The EUT tested system was configured as the statements of 2.1 Unless otherwise a special operating condition is specified in the follows during the testing.



4.1.5 TEST RESULTS

Temperature :	25°C	Relative Humidity :	60%
Pressure :	1015 hPa	Test Voltage :	DC3.3V
Test Mode :	TX b Mode		

Frequency	Power Spectral Density(dBm)	Limit (dBm)	Result
2412 MHz	-4.154	8	PASS
2437 MHz	-3.098	8	PASS
2462 MHz	-4.111	8	PASS

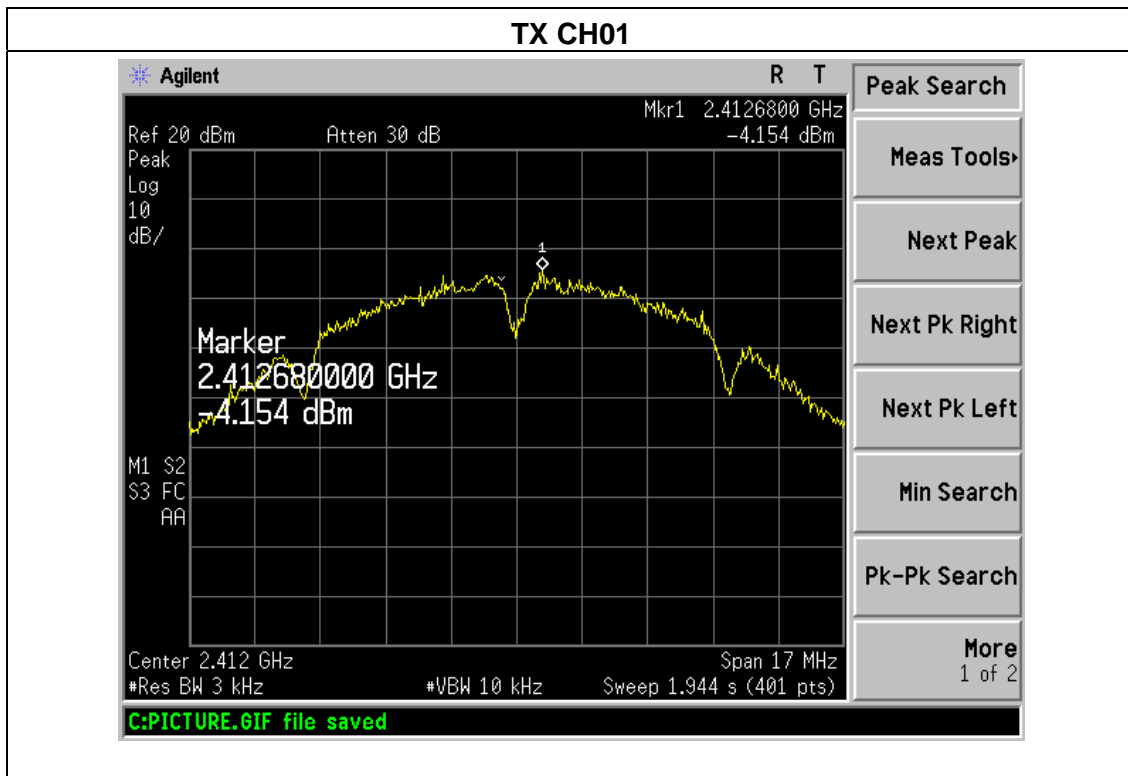

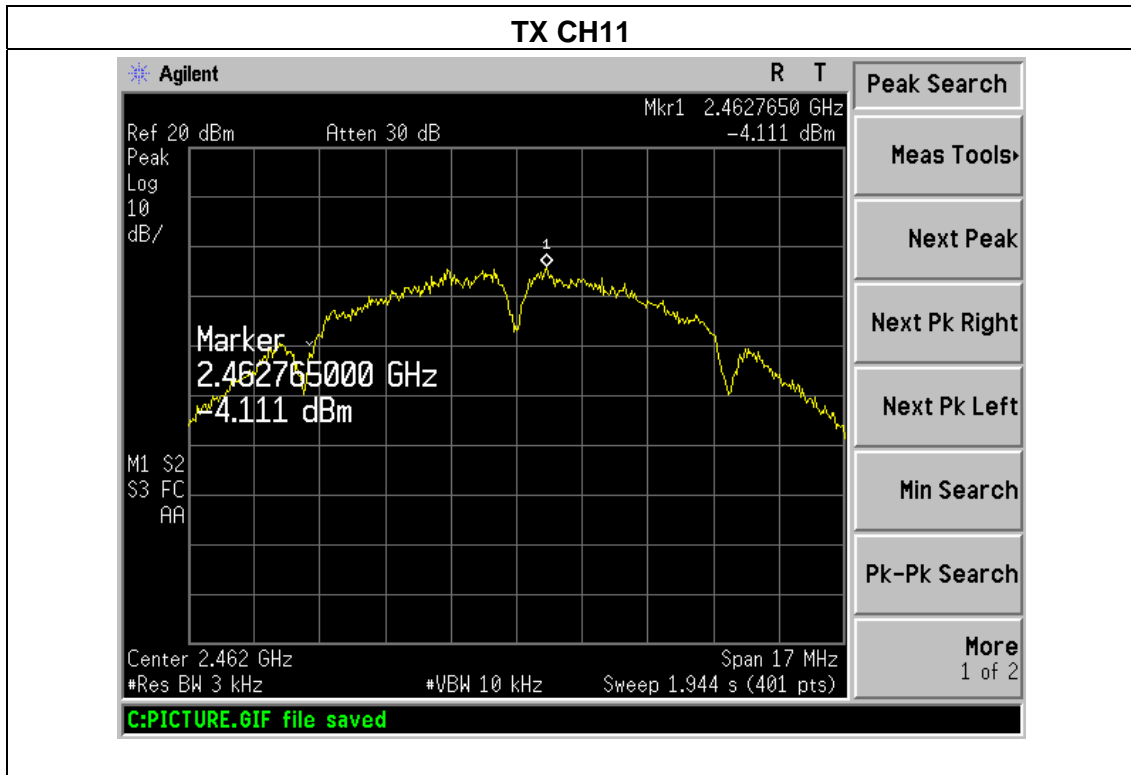
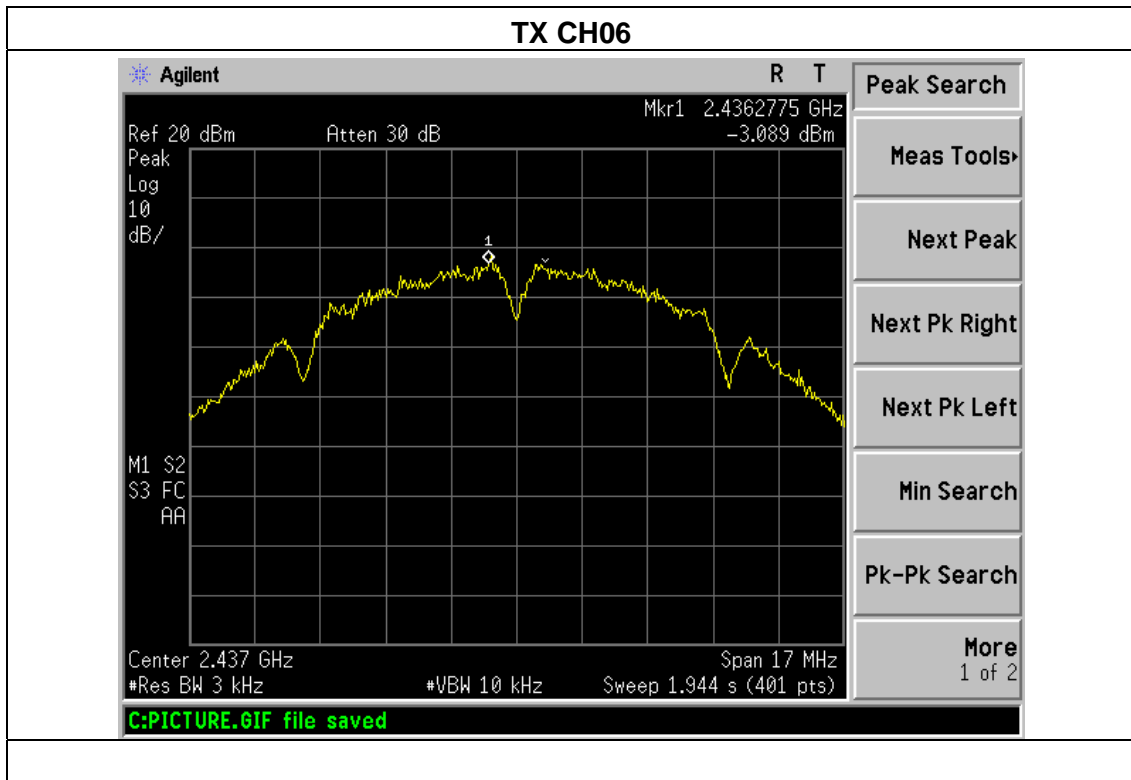



Temperature :	25°C	Relative Humidity :	60%
Pressure :	1015 hPa	Test Voltage :	DC3.3V
Test Mode :	TX g Mode		

Frequency	Power Spectral Density(dBm)	Limit (dBm)	Result
2412 MHz	-10.22	8	PASS
2437 MHz	-9.435	8	PASS
2462 MHz	-9.744	8	PASS

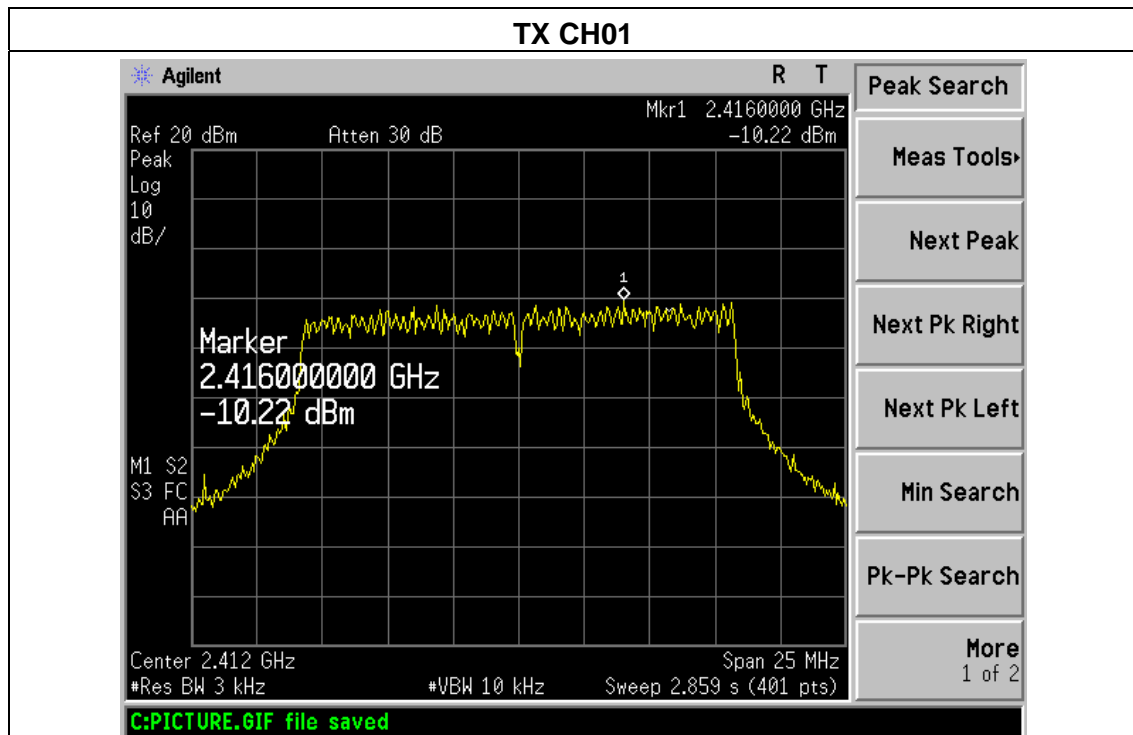

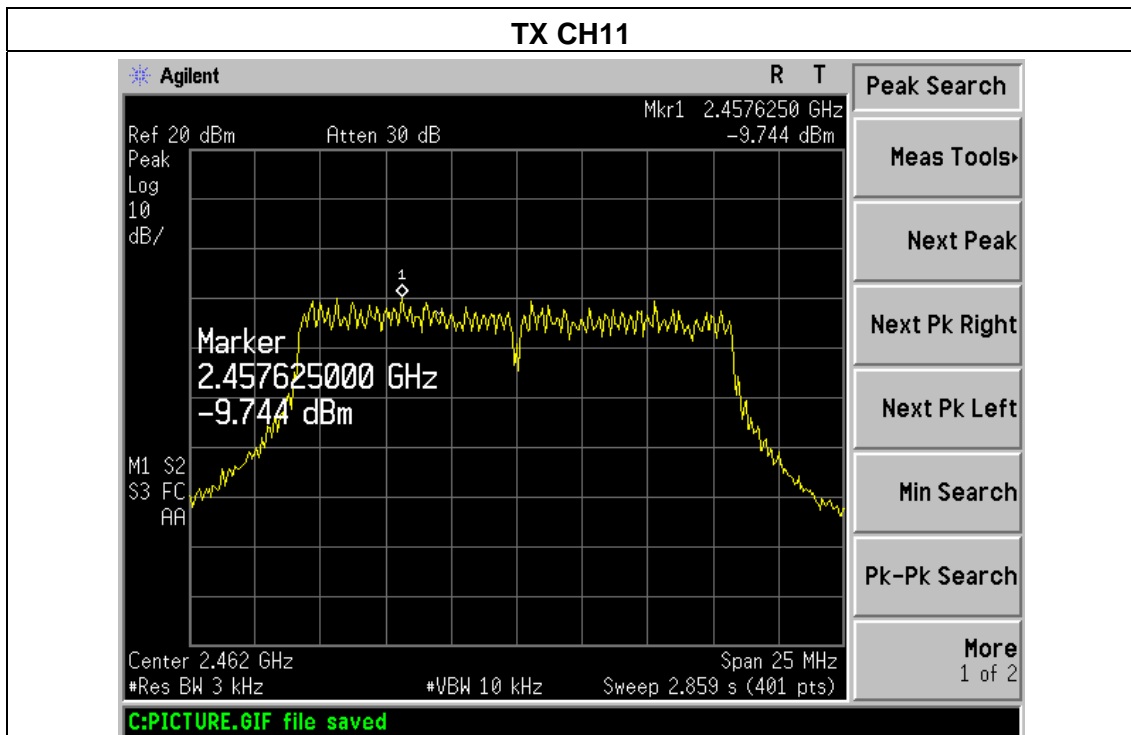
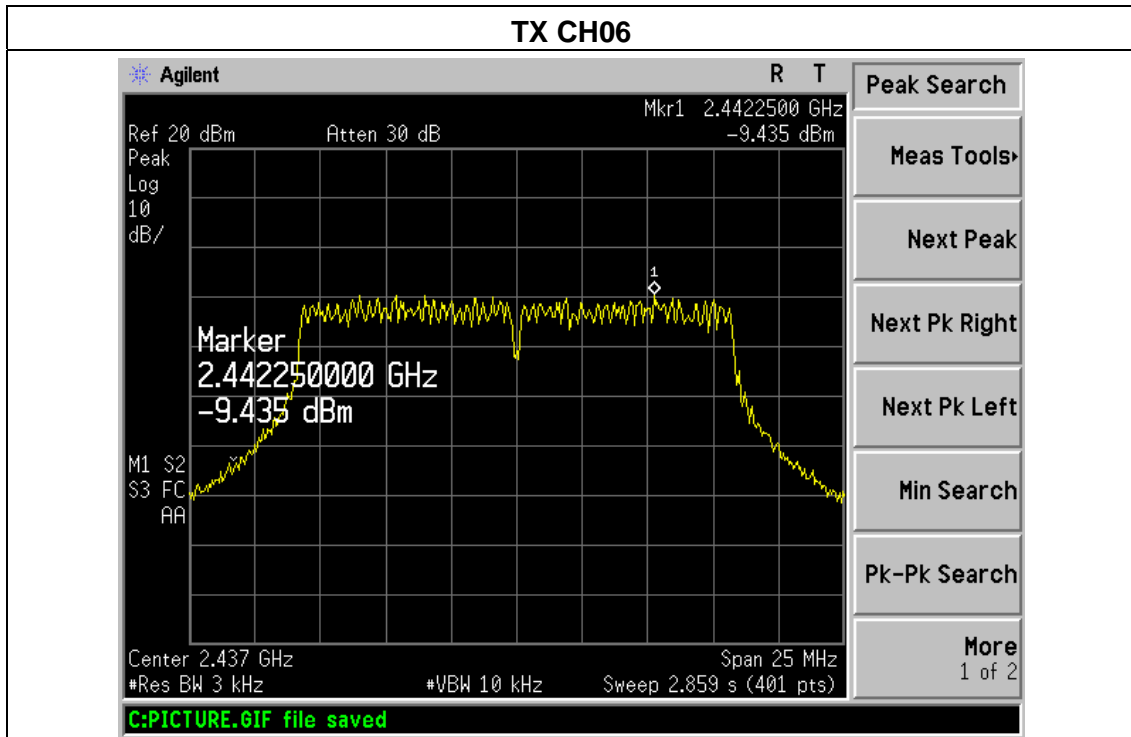



Temperature :	25°C	Relative Humidity :	60%
Pressure :	1015 hPa	Test Voltage :	DC3.3V
Test Mode :	TX n Mode(20M)		

Frequency	Power Spectral Density(dBm)	Limit (dBm)	Result
2412 MHz	-10.39	8	PASS
2437 MHz	-9.753	8	PASS
2462 MHz	-10.78	8	PASS

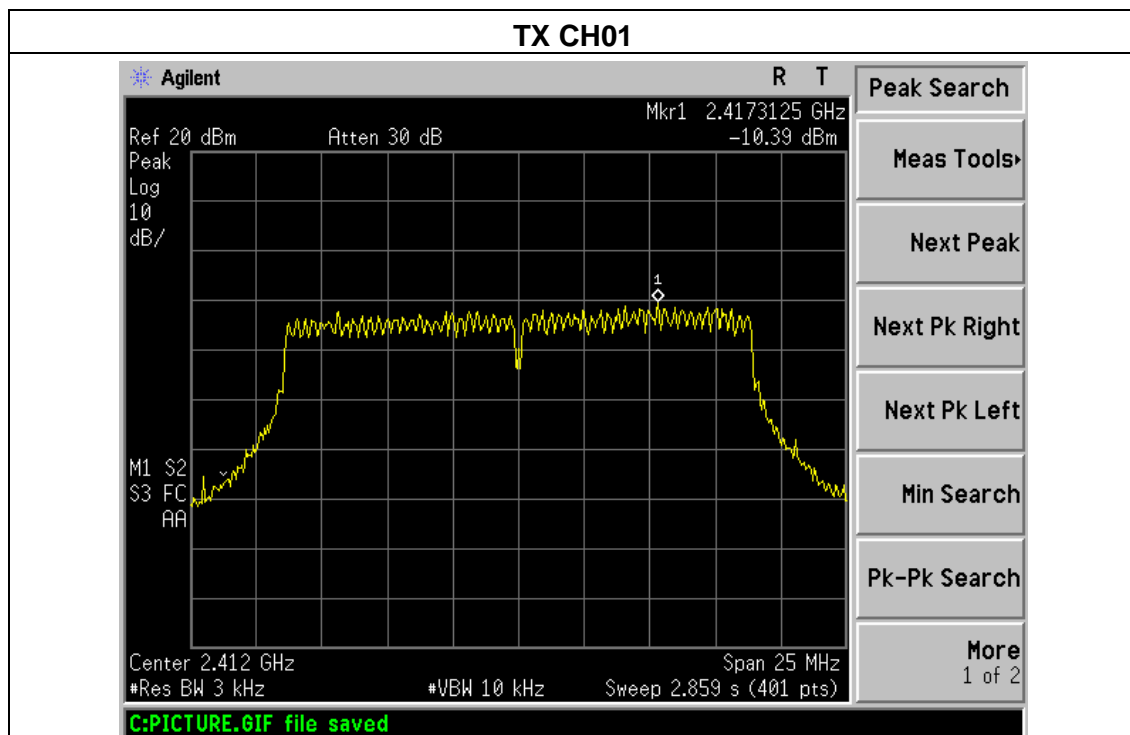

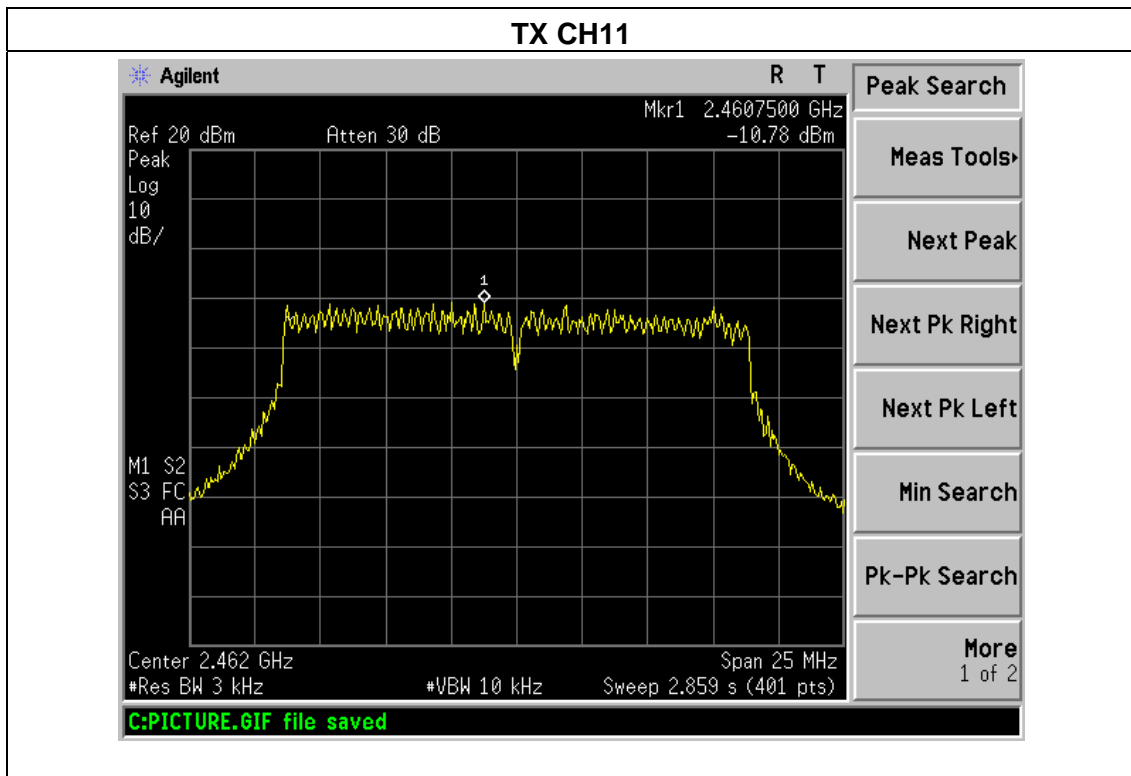
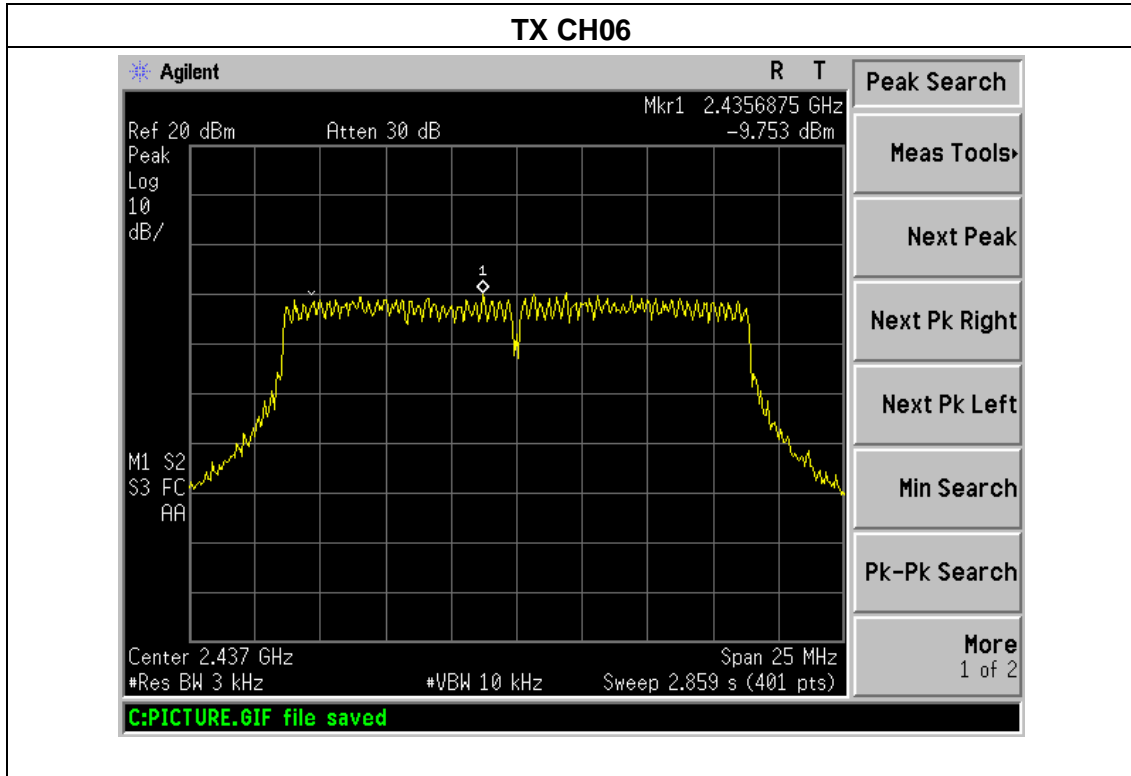



5. BANDWIDTH TEST

5.1 APPLIED PROCEDURES / LIMIT

FCC Part15 (15.247) , Subpart C				
Section	Test Item	Limit	Frequency Range (MHz)	Result
15.247(a)(2)	Bandwidth	$\geq 500\text{KHz}$ (6dB bandwidth)	2400-2483.5	PASS

5.1.1 TEST PROCEDURE

1. Set RBW = 100 kHz.
2. Set the video bandwidth (VBW) $\geq 3 \times$ RBW.
3. Detector = Peak.
4. Trace mode = max hold.
5. Sweep = auto couple.
6. Allow the trace to stabilize.
7. Measure the maximum width of the emission that is constrained by the frequencies associated with the two outermost amplitude points (upper and lower frequencies) that are attenuated by 6 dB relative to the maximum level measured in the fundamental emission.

5.1.2 DEVIATION FROM STANDARD

No deviation.

5.1.3 TEST SETUP



5.1.4 EUT OPERATION CONDITIONS

The EUT tested system was configured as the statements of 2.4 Unless otherwise a special operating condition is specified in the follows during the testing.



5.1.5 TEST RESULTS

Temperature :	25°C	Relative Humidity :	60%
Pressure :	1012 hPa	Test Voltage :	DC3.3V
Test Mode :	TX b Mode		

Channel	Frequency (MHz)	6dB bandwidth (MHz)	Limit (kHz)	Result
Low	2412	7.061	500	Pass
Middle	2437	7.040	500	Pass
High	2462	7.593	500	Pass

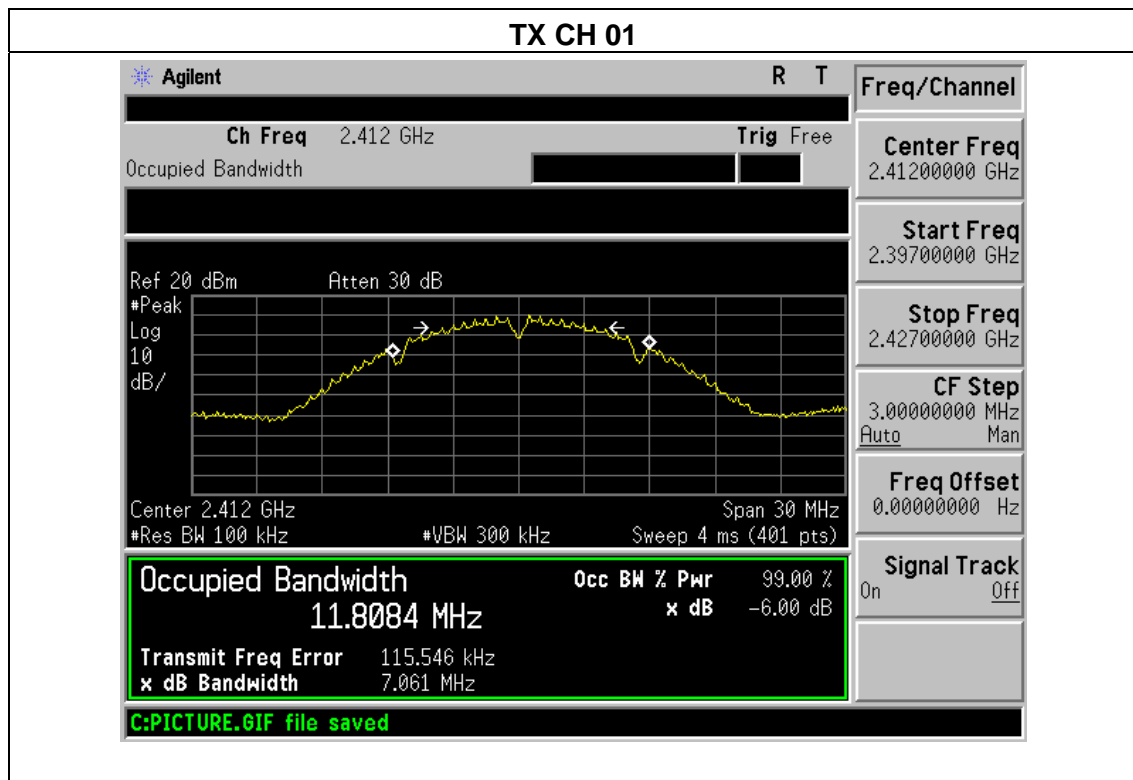



TX CH 06

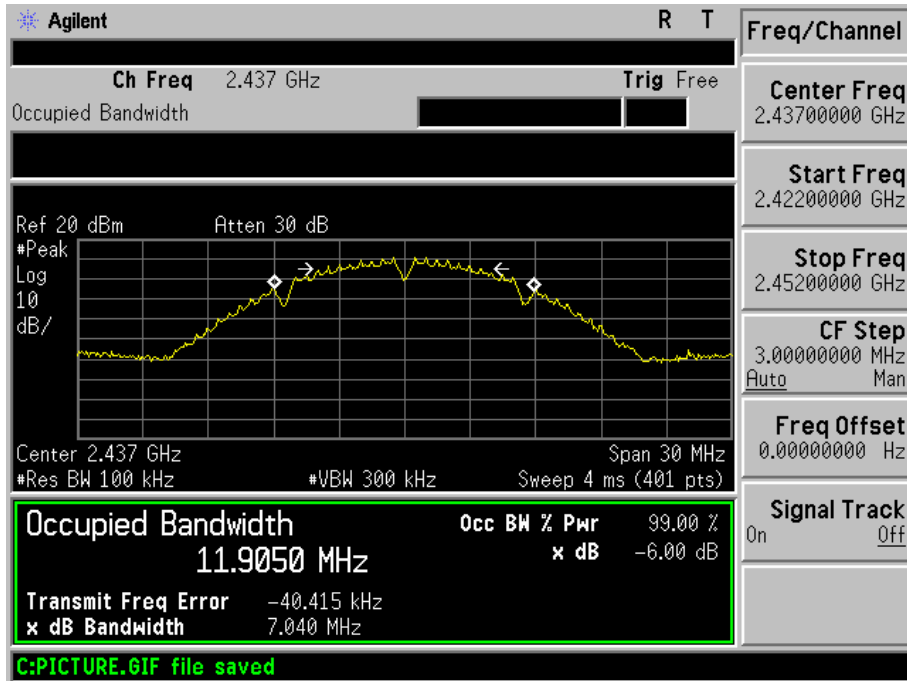

TX CH 11

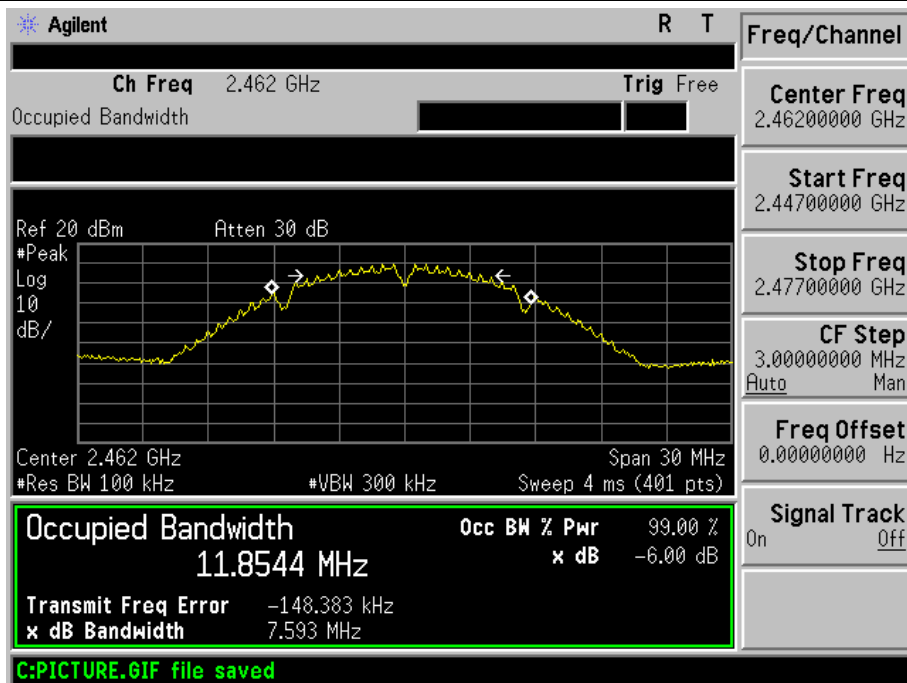



Temperature :	25°C	Relative Humidity :	60%
Pressure :	1012 hPa	Test Voltage :	DC3.3V
Test Mode :	TX g Mode		

Channel	Frequency (MHz)	6dB bandwidth (MHz)	Limit (kHz)	Result
Low	2412	16.505	500	Pass
Middle	2437	16.505	500	Pass
High	2462	16.545	500	Pass

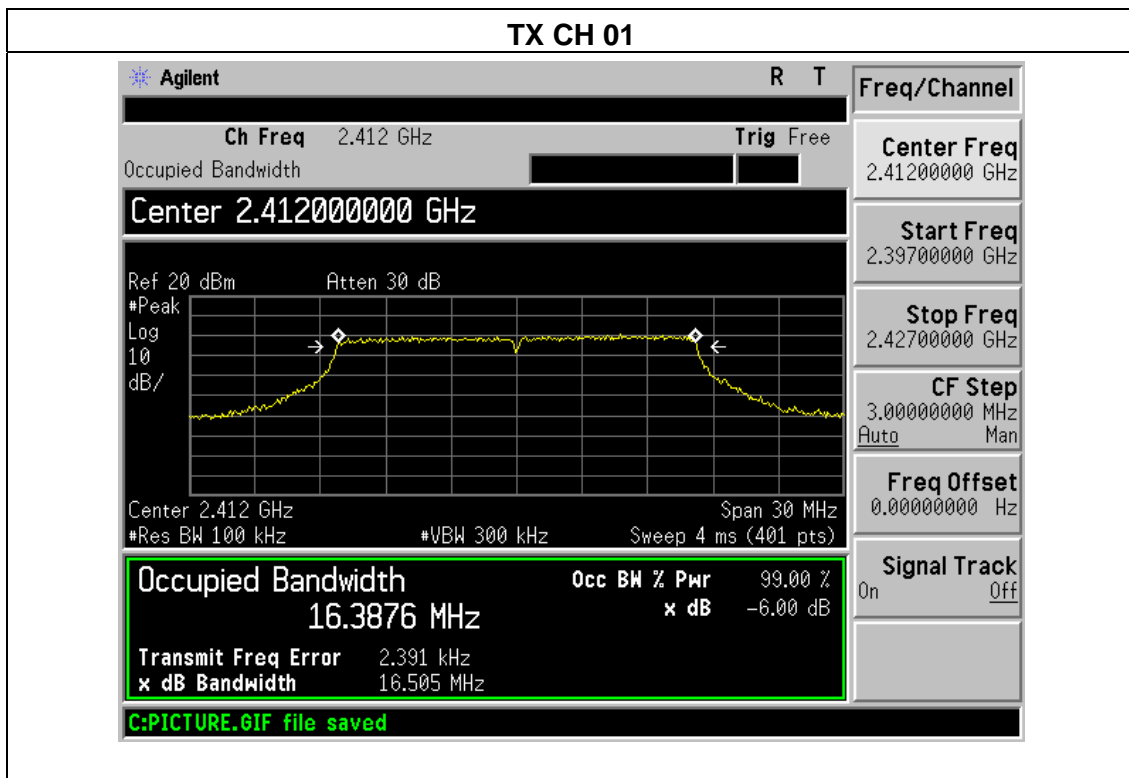

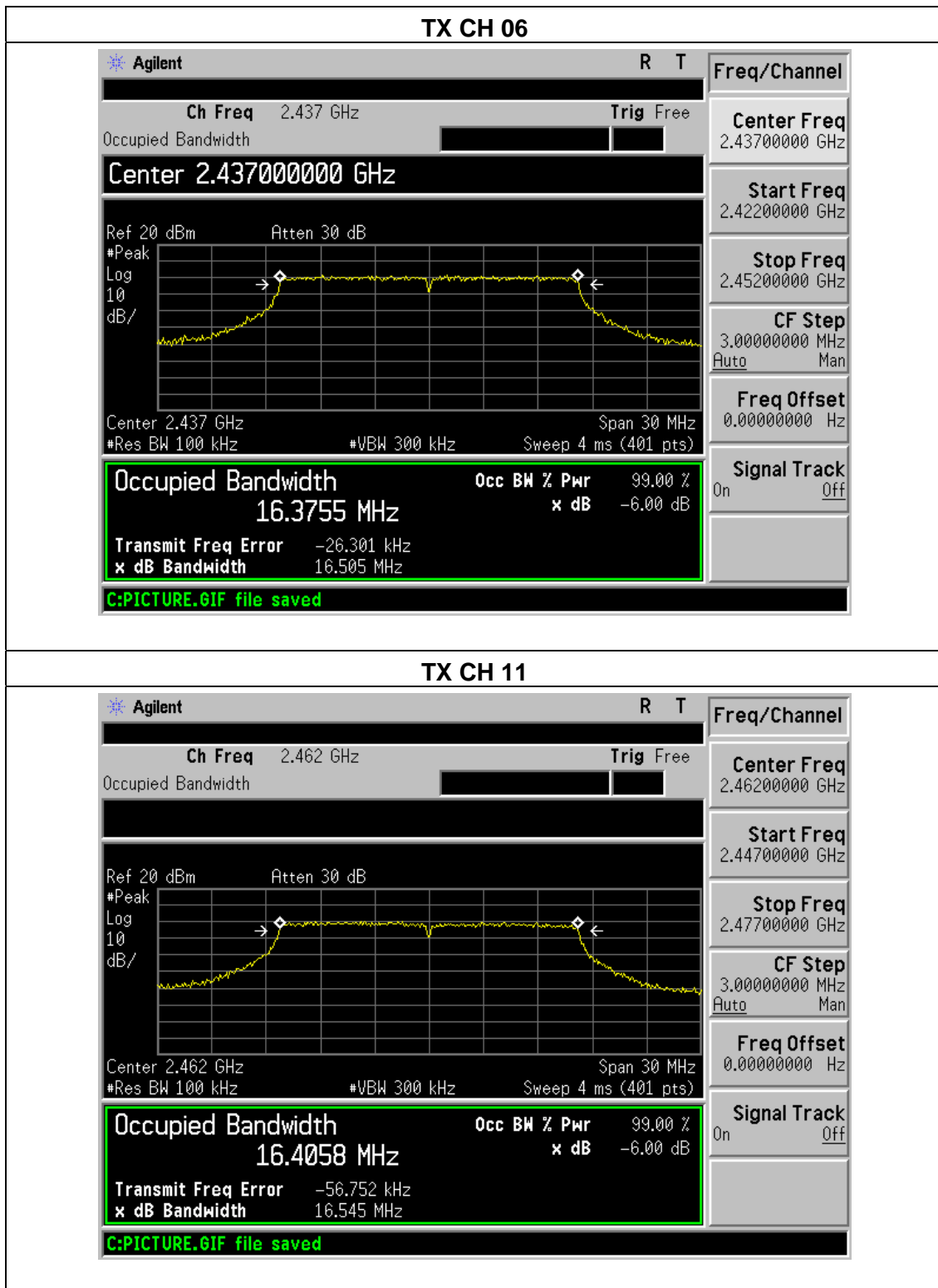



Temperature :	25°C	Relative Humidity :	60%
Pressure :	1012 hPa	Test Voltage :	DC3.3V
Test Mode :	TX n Mode(20M)		

Channel	Frequency (MHz)	6dB bandwidth (MHz)	Limit (kHz)	Result
Low	2412	17.726	500	Pass
Middle	2437	17.757	500	Pass
High	2462	17.701	500	Pass

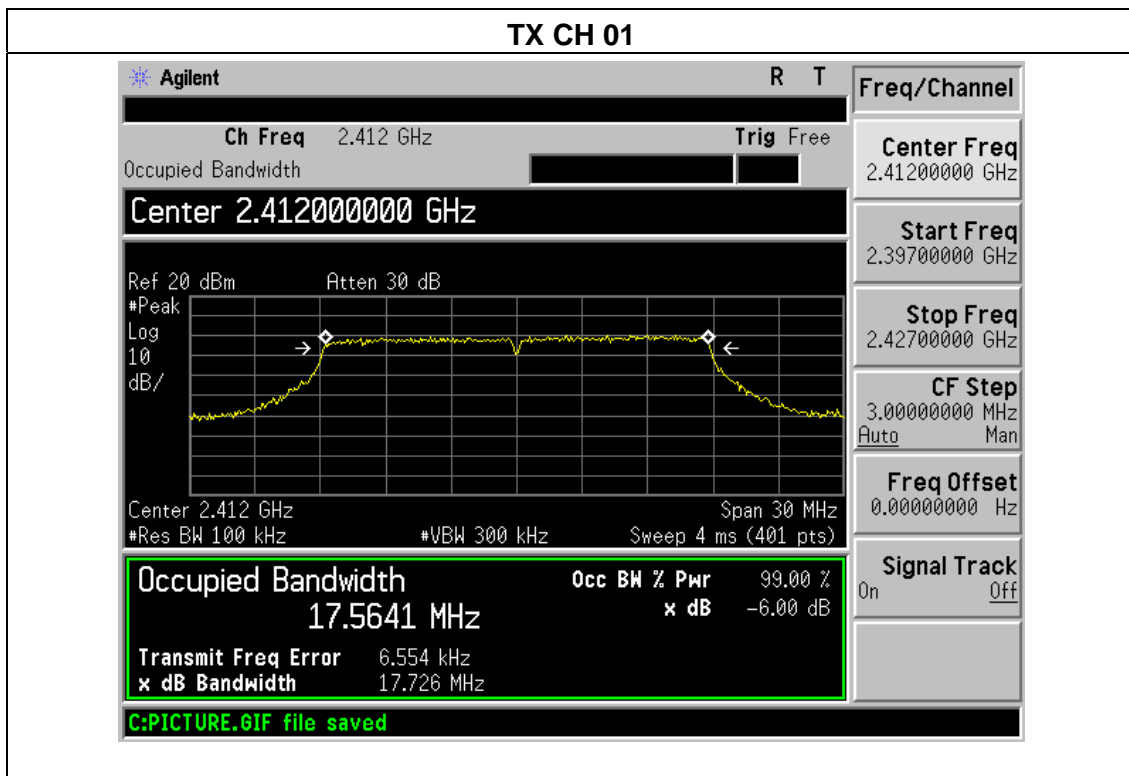

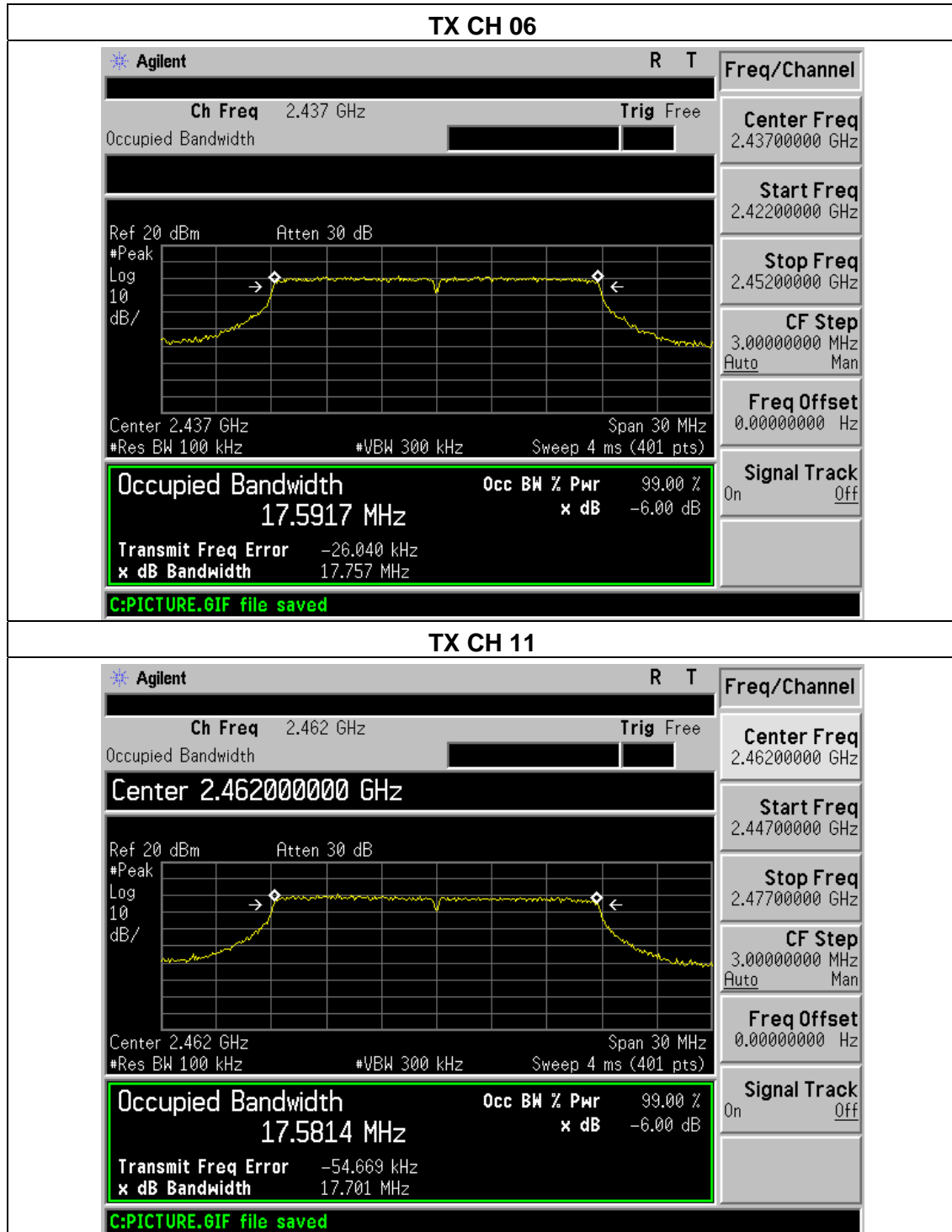



6. PEAK OUTPUT POWER TEST

6.1 APPLIED PROCEDURES / LIMIT

FCC Part15 (15.247) , Subpart C				
Section	Test Item	Limit	Frequency Range (MHz)	Result
15.247(b)(3)	Peak Output Power	1 watt or 30dBm	2400-2483.5	PASS

6.1.1 TEST PROCEDURE

- a. The EUT was directly connected to the Power meter

6.1.2 DEVIATION FROM STANDARD

No deviation.

6.1.3 TEST SETUP



6.1.4 EUT OPERATION CONDITIONS

The EUT tested system was configured as the statements of 2.4 Unless otherwise a special operating condition is specified in the follows during the testing.

**6.1.5 TEST RESULTS**

Temperature :	25°C	Relative Humidity :	60%
Pressure :	1012 hPa	Test Voltage :	DC3.3V

	Frequency	Maximum Conducted Output Power(PK)	LIMIT
	(MHz)	(dBm)	dBm
802.11b	2412	18.52	30
	2437	18.73	30
	2462	18.61	30
802.11g	2412	17.49	30
	2437	17.23	30
	2462	17.65	30
802.11n20	2412	16.64	30
	2437	16.22	30
	2462	16.58	30



7. 100 KHZ BANDWIDTH OF FREQUENCY BAND EDGE

7.1 APPLICABLE STANDARD

In any 100 kHz bandwidth outside the frequency band in which the spread spectrum or digitally modulated intentional radiator is operating, the radio frequency power that is produced by the intentional radiator shall be at least 20 dB below that in the 100 kHz bandwidth within the band that contains the highest level of the desired power, based on either an RF conducted or a radiated measurement, provided the transmitter demonstrates compliance with the peak conducted power limits. If the transmitter complies with the conducted power limits based on the use of RMS averaging over a time interval, as permitted under paragraph (b)(3) of this section, the attenuation required under this paragraph shall be 30 dB instead of 20 dB. Attenuation below the general limits specified in §15.209(a) is not required. In addition, radiated emissions which fall in the restricted bands, as defined in §15.205(a), must also comply with the radiated emission limits specified in §15.209(a) (see §15.205(c)).

7.2 TEST PROCEDURE

- a) Check the calibration of the measuring instrument using either an internal calibrator or a known signal from an external generator.
- b) Position the EUT without connection to measurement instrument. Turn on the EUT and connect its antenna terminal to measurement instrument via a low loss cable. Then set it to any one measured frequency within its operating range, and make sure the instrument is operated in its linear range.
- c) Set RBW to 100 kHz and VBW of spectrum analyzer to 300 kHz with a convenient frequency span including 100 kHz bandwidth from band edge.
- d) Measure the highest amplitude appearing on spectral display and set it as a reference level. Plot the graph with marking the highest point and edge frequency.
- e) Repeat above procedures until all measured frequencies were complete.

7.3 DEVIATION FROM STANDARD

No deviation.

7.4 TEST SETUP

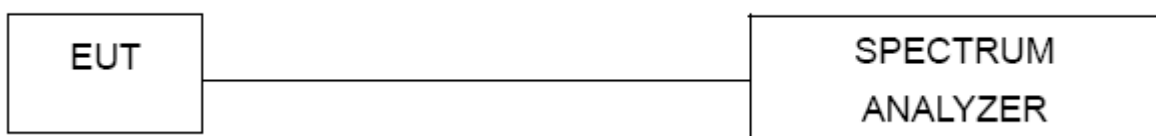



7.5 EUT OPERATION CONDITIONS

The EUT tested system was configured as the statements of 2.4 Unless otherwise a special operating condition is specified in the follows during the testing.

7.1 TEST RESULTS



802.11b: Band Edge, Left Side

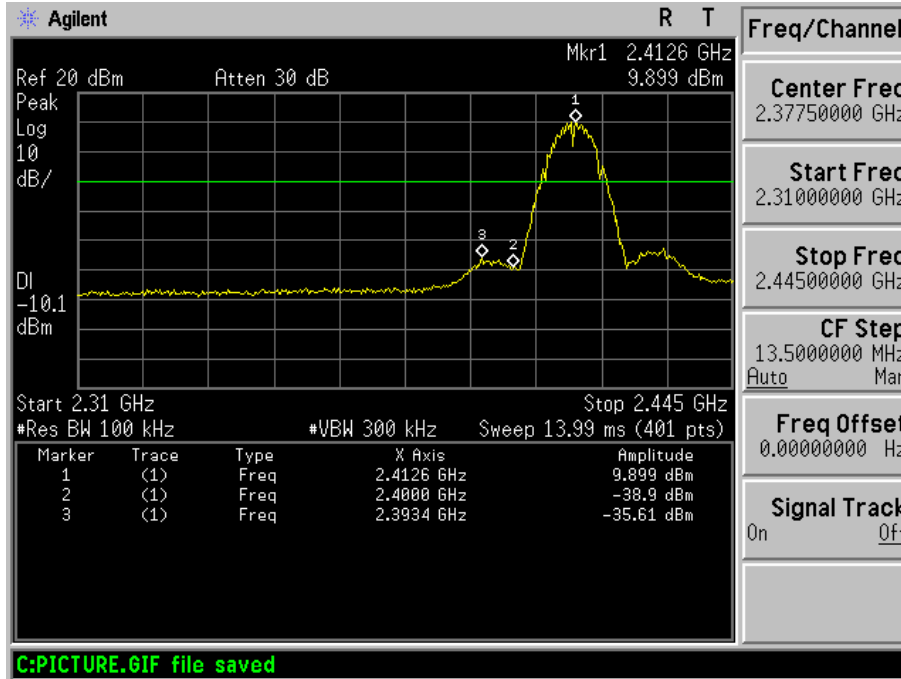

802.11b: Band Edge, Right Side

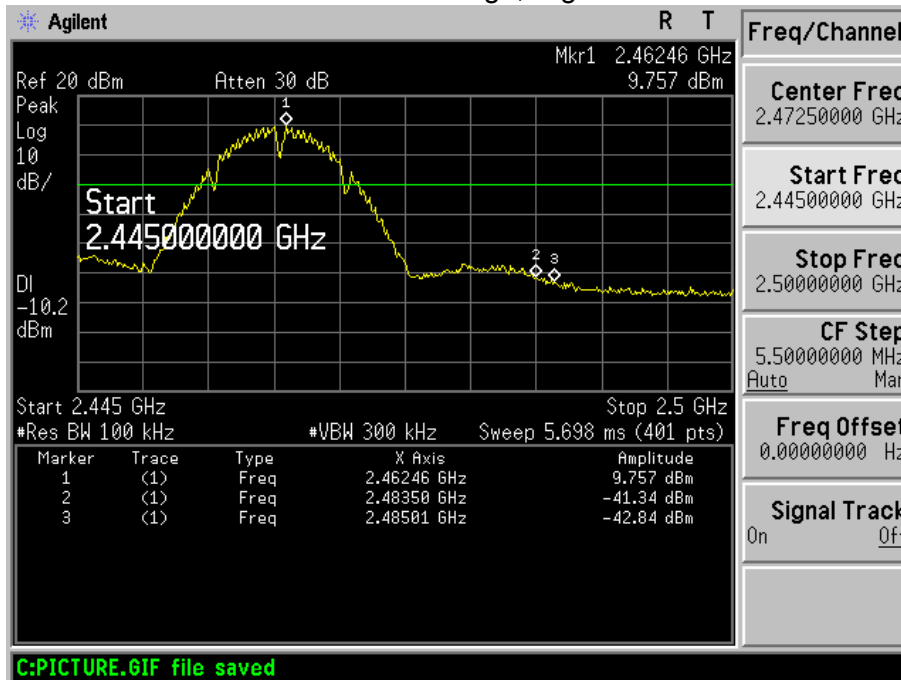



802.11g: Band Edge, Left Side

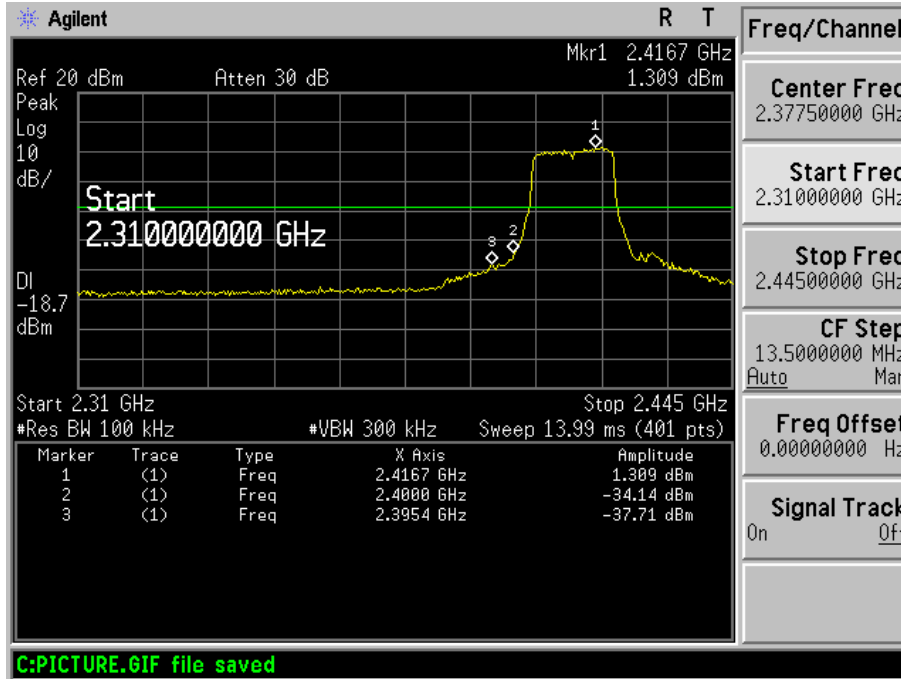

802.11g: Band Edge, Right Side

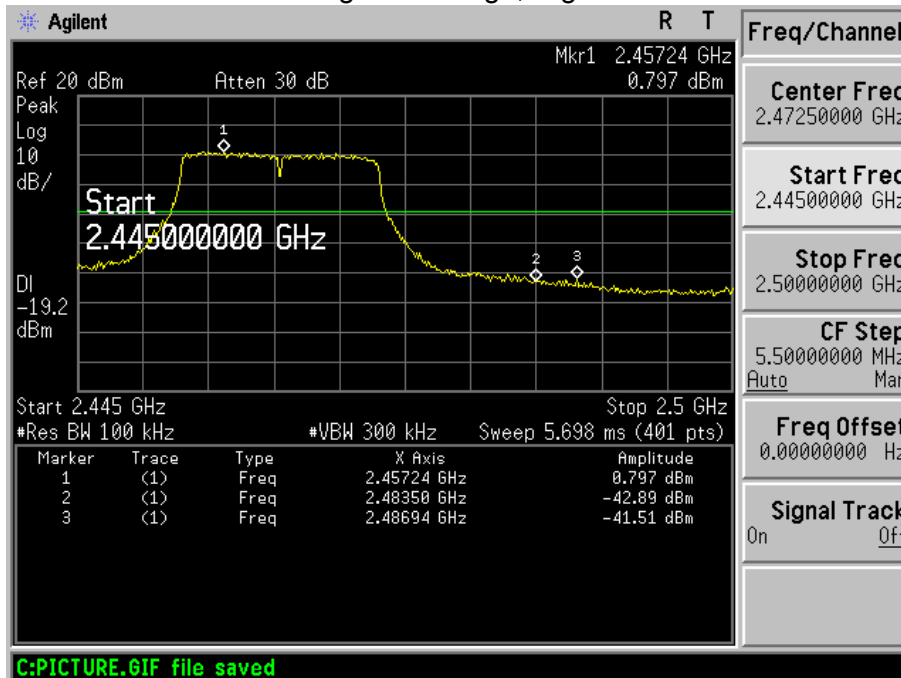



802.11n-HT20: Band Edge, Left Side

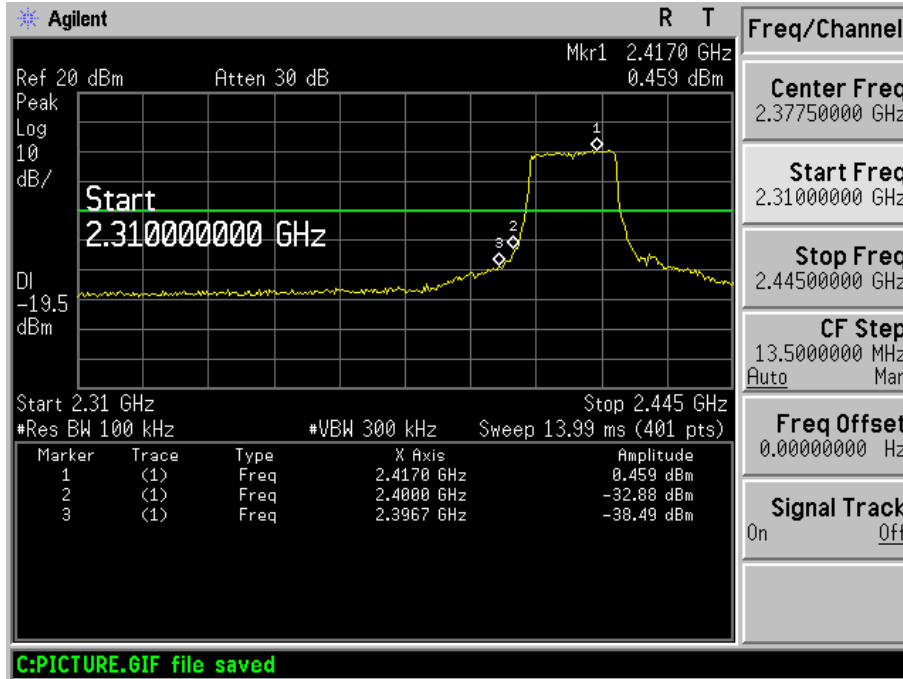

802.11n-HT20: Band Edge, Right Side

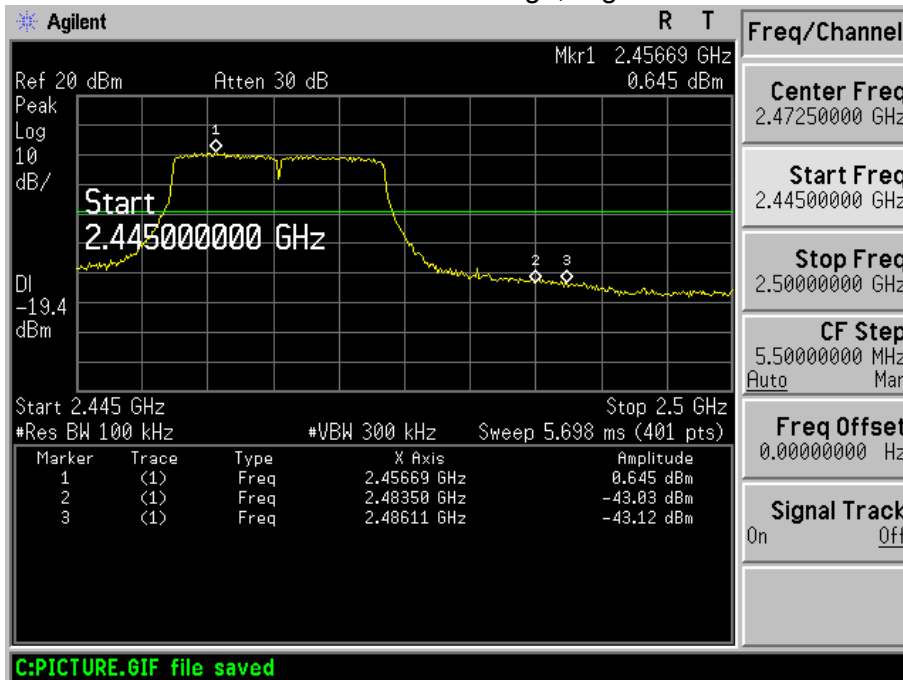



8. ANTENNA REQUIREMENT

8.1 STANDARD REQUIREMENT

15.203 requirement: For intentional device, according to 15.203: an intentional radiator shall be designed to ensure that no antenna other than that furnished by the responsible party shall be used with the device.

8.2 EUT ANTENNA

The EUT antenna is PCB antenna antenna. It complies with the standard requirement.

9. EUT TEST PHOTO

Radiated Measurement Photos

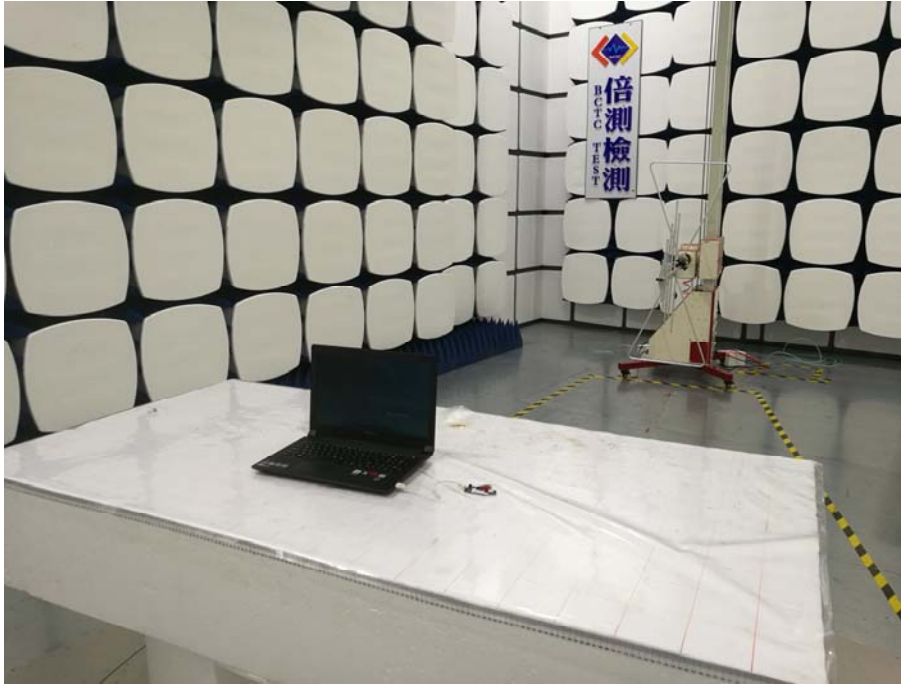

Radiated Measurement Photos

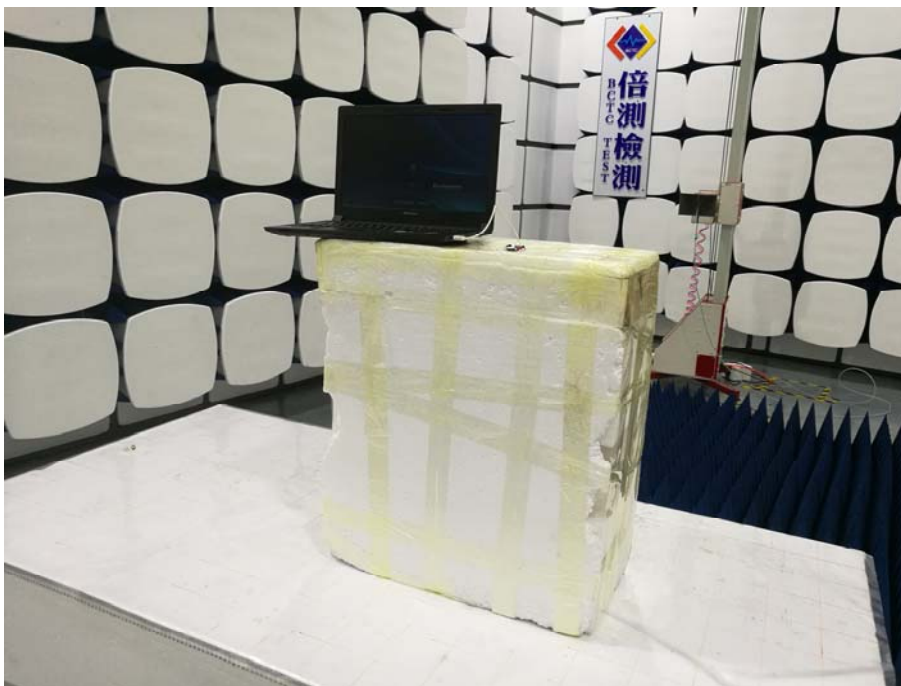



Conducted Measurement Photos



10. EUT PHOTO

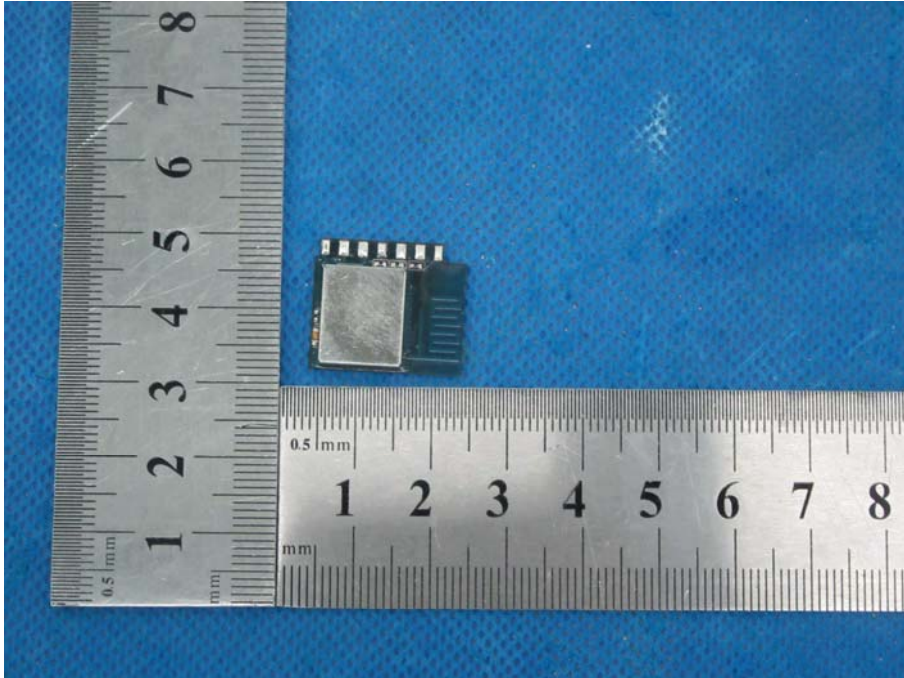

***** END OF REPORT *****