



FCC Part 15C Test Report

FCC ID: 2AKBP-X6P

Product Name:	Wifi Smart Socket
Trademark:	N/A
Model Name :	X6P X6
Prepared For :	Shenzhen Hysiry Technology Co.,Ltd.
Address :	Room 406, Fourth floor, Buliding 1, Area D, Huameiju Decoration Materials City , Xinhu Road ,Xin'an street, Bao'an District ,Shenzhen
Prepared By :	Shenzhen BCTC Testing Co., Ltd.
Address :	BCTC Building & 1-2F, East of B Building, Pengzhou Industrial, Fuyuan 1st Road, Qiaotou Community, Fuyong Street, Bao'an District, Shenzhen, China
Test Date:	Feb. 02 - Feb. 07, 2018
Date of Report :	Feb. 07, 2018
Report No.:	BCTC-FY180200793E



TEST RESULT CERTIFICATION

Applicant's name..... : **Shenzhen Hysiry Technology Co.,Ltd.**

Address..... : Room 406, Fourth floor, Buliding 1, Area D, Huameiju Decoration Materials City, Xihu Road ,Xin'an street, Bao'an District ,Shenzhen

Manufacture's Name..... : **Shenzhen Hysiry Technology Co.,Ltd.**

Address..... : Room 406, Fourth floor, Buliding 1, Area D, Huameiju Decoration Materials City, Xihu Road ,Xin'an street, Bao'an District ,Shenzhen

Product description

Product name..... : Wifi Smart Socket

Trademark..... : N/A

Model and/or type reference : X6P
X6

Standards..... : FCC Part15.247
ANSI C63.10:2013

This device described above has been tested by BCTC, and the test results show that the equipment under test (EUT) is in compliance with the FCC requirements. And it is applicable only to the tested sample identified in the report.

This report shall not be reproduced except in full, without the written approval of BCTC, this document may be altered or revised by BCTC, personal only, and shall be noted in the revision of the document.

Prepared by(Engineer): Eric Yang

Reviewer(Supervisor): Jade Yang

Approved(Manager): Carson Zhang





Table of Contents		Page
1 . SUMMARY OF TEST RESULTS		6
1.1 TEST FACILITY		7
1.2 MEASUREMENT UNCERTAINTY		7
2 . GENERAL INFORMATION		8
2.1 GENERAL DESCRIPTION OF EUT		8
2.2 DESCRIPTION OF TEST MODES		9
2.3 BLOCK DIGRAM SHOWING THE CONFIGURATION OF SYSTEM TESTED		10
2.4 DESCRIPTION OF SUPPORT UNITS(CONDUCTED MODE)		10
2.5 EQUIPMENTS LIST FOR ALL TEST ITEMS		11
3 . EMC EMISSION TEST		12
3.1 CONDUCTED EMISSION MEASUREMENT		12
3.1.1 POWER LINE CONDUCTED EMISSION LIMITS		12
3.1.2 TEST PROCEDURE		12
3.1.3 DEVIATION FROM TEST STANDARD		12
3.1.4 TEST SETUP		13
3.1.5 EUT OPERATING CONDITIONS		13
3.1.6 TEST RESULTS		13
3.2 RADIATED EMISSION MEASUREMENT		16
3.2.1 RADIATED EMISSION LIMITS		16
3.2.2 TEST PROCEDURE		16
3.2.3 DEVIATION FROM TEST STANDARD		17
3.2.4 TEST SETUP		17
3.2.5 EUT OPERATING CONDITIONS		18
3.2.6 TEST RESULTS (BETWEEN 9KHZ – 30 MHZ)		19
3.2.7 TEST RESULTS (BETWEEN 30MHZ – 1GHZ)		20
3.2.8 TEST RESULTS (1GHZ~25GHZ)		22
3.3 RADIATED BAND EMISSION MEASUREMENT		25
3.3.1 TEST REQUIREMENT:		25
3.3.2 TEST PROCEDURE		25
3.3.3 DEVIATION FROM TEST STANDARD		26
3.3.4 TEST SETUP		26
3.3.5 EUT OPERATING CONDITIONS		26
4 . POWER SPECTRAL DENSITY TEST		28
4.1 APPLIED PROCEDURES / LIMIT		28



Table of Contents		Page
4.1.1 TEST PROCEDURE		28
4.1.2 DEVIATION FROM STANDARD		28
4.1.3 TEST SETUP		28
4.1.4 EUT OPERATION CONDITIONS		28
4.1.5 TEST RESULTS		29
5 . BANDWIDTH TEST		35
5.1 APPLIED PROCEDURES / LIMIT		35
5.1.1 TEST PROCEDURE		35
5.1.2 DEVIATION FROM STANDARD		35
5.1.3 TEST SETUP		35
5.1.4 EUT OPERATION CONDITIONS		35
5.1.5 TEST RESULTS		36
6 . PEAK OUTPUT POWER TEST		42
6.1 APPLIED PROCEDURES/LIMIT		42
6.1.1 TEST PROCEDURE		42
6.1.2 DEVIATION FROM STANDARD		42
6.1.3 TEST SETUP		42
6.1.4 EUT OPERATION CONDITIONS		42
6.1.5 TEST RESULTS		43
7 . 100 KHZ BANDWIDTH OF FREQUENCY BAND EDGE		44
7.1 APPLICABLE STANDARD		44
7.2 TEST PROCEDURE		44
7.3 DEVIATION FROM STANDARD		44
7.4 TEST SETUP		44
7.5 EUT OPERATION CONDITIONS		44
7.1 TEST RESULTS		44
8 . DUTY CYCLE OF TEST SIGNAL		51
8.1 STANDARD REQUIREMENT		51
8.2 FORMULA:		51
9 . ANTENNA REQUIREMENT		53
9.1 STANDARD REQUIREMENT		53
9.2 EUT ANTENNA		53
10 . EUT TEST PHOTO		54



Table of Contents	Page
11 . EUT PHOTO APPENDIX-PHOTOGRAPHS OF EUT CONSTRUCTIONAL DETAILS	56



1. SUMMARY OF TEST RESULTS

Test procedures according to the technical standards:

FCC Part15 (15.247) , Subpart C			
Standard Section	Test Item	Judgment	Remark
15.207	Conducted Emission	PASS	
15.247 (a)(2)	6dB Bandwidth	PASS	
15.247 (b)	Peak Output Power	PASS	
15.247 (d)	Radiated Spurious Emission	PASS	
15.247 (e)	Power Spectral Density	PASS	
15.205	Restricted Band of Operation	PASS	
15.247 (d)	Band Edge (Out of Band Emissions)	PASS	
15.203	Antenna Requirement	PASS	

NOTE:

(1) "N/A" denotes test is not applicable in this Test Report



1.1 TEST FACILITY

Shenzhen BCTC Testing Co., Ltd.

Add. : BCTC Building & 1-2F, East of B Building, Pengzhou Industrial, Fuyuan 1st Road, Qiaotou Community, Fuyong Street, Bao'an District, Shenzhen, China

Test Firm Registration Number: 712850

1.2 MEASUREMENT UNCERTAINTY

The reported uncertainty of measurement $y \pm U$, where expanded uncertainty U is based on a standard uncertainty multiplied by a coverage factor of $k=2$, providing a level of confidence of approximately 95%.

No.	Item	Uncertainty
1	Conducted Emission Test	$\pm 1.38\text{dB}$
2	RF power,conducted	$\pm 0.16\text{dB}$
3	Spurious emissions,conducted	$\pm 0.21\text{dB}$
4	All emissions,radiated(<1G)	$\pm 4.68\text{dB}$
5	All emissions,radiated(>1G)	$\pm 4.89\text{dB}$
6	Temperature	$\pm 0.5^{\circ}\text{C}$
7	Humidity	$\pm 2\%$



2. GENERAL INFORMATION

2.1 GENERAL DESCRIPTION OF EUT

Equipment	Wifi Smart Socket	
Trade Name	N/A	
Model Name	X6P X6	
Model Difference	All the model are the same circuit and RF module, except model names.	
Product Description	Operation Frequency:	802.11b/g/n20MHz:2412~2462 MHz
	Modulation Type:	WIFI: OFDM/DSSS
	Bit Rate of Transmitter	802.11b:11/5.5/2/1 Mbps 802.11g:54/48/36/24/18/12/9/6Mbps 802.11n Up to 75Mbps
	Number Of Channel	802.11b/g/n20MHz:11 CH
	Antenna Designation:	Please see Note 3.
Based on the application, features, or specification exhibited in User's Manual, the EUT is considered as an ITE/Computing Device. More details of EUT technical specification, please refer to the User's Manual.		
Channel List	Please refer to the Note 2.	
Power	AC 100-240V 50/60Hz 10A	
hardware version	--	
Software version	--	
Serial number	--	
Connecting I/O Port(s)	Please refer to the User's Manual	

Note:

1. For a more detailed features description, please refer to the manufacturer's specifications or the User's Manual.



2.

Channel List for 802.11b/g/n(20)							
Channel	Frequency (MHz)	Channel	Frequency (MHz)	Channel	Frequency (MHz)	Channel	Frequency (MHz)
01	2412	04	2427	07	2442	10	2457
02	2417	05	2432	08	2447	11	2462
03	2422	06	2437	09	2452		

3.

Table for Filed Antenna

Ant.	Brand	Model Name	Antenna Type	Gain (dBi)	NOTE
1	N/A	N/A	PCB Antenna	1.0	

2.2 DESCRIPTION OF TEST MODES

Pretest Mode	Description
Mode 1	802.11b CH1/ CH6/ CH11
Mode 2	802.11g CH1/ CH6/ CH11
Mode 3	802.11n20 CH1/ CH6/ CH11
Mode 4	Link Mode

Conducted Emission	
Final Test Mode	Description
Mode 4	Link Mode

For Radiated Emission	
Final Test Mode	Description
Mode 1	802.11b CH1/ CH6/ CH11
Mode 2	802.11g CH1/ CH6/ CH11
Mode 3	802.11n20 CH1/ CH6/ CH11

Note:

(1) The measurements are performed at all Bit Rate of Transmitter, the worst data was reported.



2.3 BLOCK DIGRAM SHOWING THE CONFIGURATION OF SYSTEM TESTED

Emission Test

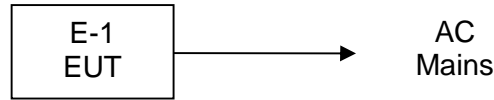

2.4 DESCRIPTION OF SUPPORT UNITS(CONDUCTED MODE)

The EUT has been tested as an independent unit together with other necessary accessories or support units. The following support units or accessories were used to form a representative test configuration during the tests.

Item	Equipment	Mfr/Brand	Model/Type No.	Series No.	Note
E-1	Wifi Smart Socket	N/A	X6P	N/A	EUT

Item	Shielded Type	Ferrite Core	Length	Note

Note:

- (1) The support equipment was authorized by Declaration of Confirmation.
- (2) For detachable type I/O cable should be specified the length in cm in 『Length』 column.



2.5 EQUIPMENTS LIST FOR ALL TEST ITEMS

Radiation Test equipment

Item	Equipment	Manufacturer	Type No.	Serial No.	Last calibration	Calibrated until
1	Spectrum Analyzer (9kHz-26.5GHz)	Agilent	E4407B	MY45108040	2017.08.27	2018.08.26
2	Test Receiver (9kHz-7GHz)	R&S	ESPI	101318	2017.08.27	2018.08.26
3	Bilog Antenna (30MHz-1GHz)	R&S	VULB 9168	VULB91 68-438	2017.08.27	2018.08.26
4	Horn Antenna (1GHz-18GHz)	SCHWARZBECK	BBHA9120D	1201	2017.09.03	2018.09.02
5	Horn Antenna (14GHz-40GHz)	SCHWARZBECK	BBHA 9170	9170-181	2017.09.03	2018.09.02
6	Amplifier (9KHz-6GHz)	SCHWARZBECK	BBV9744	9744-0037	2017.08.27	2018.08.26
7	Amplifier (1GHz-18GHz)	SCHWARZBECK	BBV9718	9718-309	2017.08.27	2018.08.26
8	Amplifier (18GHz-40GHz)	SCHWARZBECK	BBV 9721	9721-205	2017.08.27	2018.08.26
9	Loop Antenna (9KHz-30MHz)	SCHWARZBECK	FMZB1519B	00014	2017.09.03	2018.09.02
10	RF cables1 (9kHz-1GHz)	R&S	R203	R20X	2017.08.27	2018.08.26
11	RF cables2 (1GHz-40GHz)	R&S	R204	R21X	2017.08.27	2018.08.26
12	Antenna connector	Florida RF Labs	N/A	RF 01#	2017.08.27	2018.08.26
13	Power Metter	ANRITSU	ML2487A	6K00001568	2017.08.27	2018.08.26
14	Power Sensor (AV)	ANRITSU	ML2491A	030989	2017.08.27	2018.08.26
15	Signal Analyzer 9kHz-26.5GHz	Agilent	N9010A	MY48030494	2017.08.27	2018.08.26
16	Test Receiver 20kHz-40GHz	R&S	ESU 40	100376	2017.08.27	2018.08.26
17	D.C. Power Supply	LongWei	PS-305D	010964729	2017.08.27	2018.08.26

Conduction Test equipment

Item	Equipment	Manufacturer	Type No.	Serial No.	Last calibration	Calibrated until
1	Test Receiver	R&S	ESCI	1166.5950K03-1011 65-ha	2017.08.27	2018.08.26
2	LISN	SCHWARZBECK	NSLK8127	8127739	2017.08.27	2018.08.26
3	LISN	R&S	NSLK8126	8126487	2017.08.27	2018.08.26
4	RF cables	R&S	R204	R20X	2017.08.27	2018.08.26
5	Attenuator	R&S	ESH3-Z2	143206	2017.08.27	2018.08.26



3. EMC EMISSION TEST

3.1 CONDUCTED EMISSION MEASUREMENT

3.1.1 POWER LINE CONDUCTED EMISSION Limits (Frequency Range 150KHz-30MHz)

FREQUENCY (MHz)	Limit (dBuV)		Standard
	Quasi-peak	Average	
0.15 -0.5	66 - 56 *	56 - 46 *	FCC
0.50 -5.0	56.00	46.00	FCC
5.0 -30.0	60.00	50.00	FCC

Note:

- (1) The tighter limit applies at the band edges.
- (2) The limit of " * " marked band means the limitation decreases linearly with the logarithm of the frequency in the range.

The following table is the setting of the receiver

Receiver Parameters	Setting
Attenuation	10 dB
Start Frequency	0.15 MHz
Stop Frequency	30 MHz
IF Bandwidth	9 kHz

3.1.2 TEST PROCEDURE

- a. The EUT was placed 0.8 meters from the horizontal ground plane with EUT being connected to the power mains through a line impedance stabilization network (LISN). All other support equipments powered from additional LISN(s). The LISN provide 50 Ohm/ 50uH of coupling impedance for the measuring instrument.
- b. Interconnecting cables that hang closer than 40 cm to the ground plane shall be folded back and forth in the center forming a bundle 30 to 40 cm long.
- c. I/O cables that are not connected to a peripheral shall be bundled in the center. The end of the cable may be terminated, if required, using the correct terminating impedance. The overall length shall not exceed 1 m.
- d. LISN at least 80 cm from nearest part of EUT chassis.
- e. For the actual test configuration, please refer to the related Item –EUT Test Photos.

3.1.3 DEVIATION FROM TEST STANDARD

No deviation

3.1.4 TEST SETUP

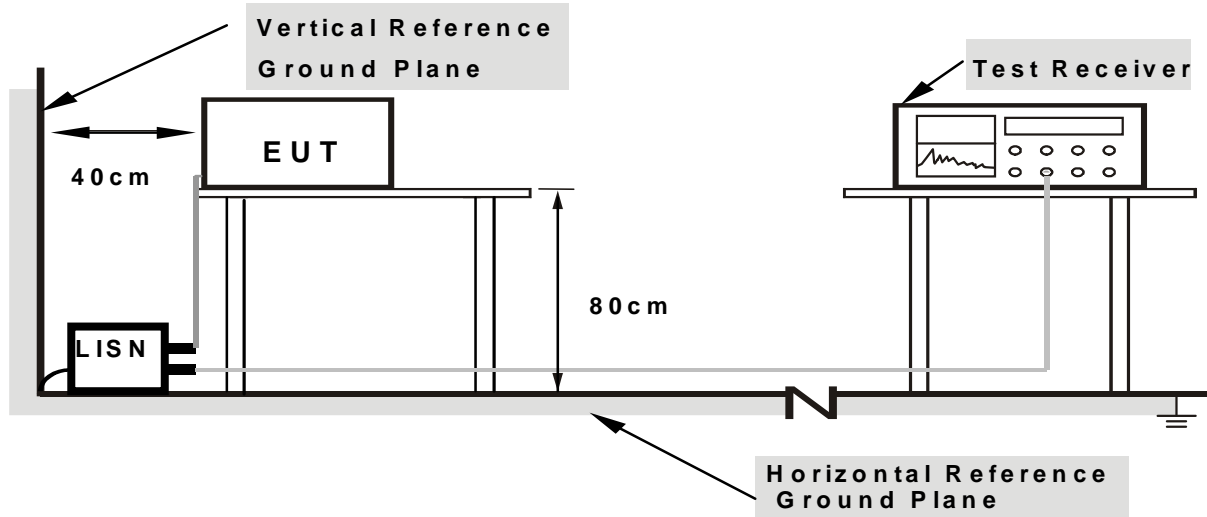

- Note:**
1. Support units were connected to second LISN.
 2. Both of LISNs (AMN) are 80 cm from EUT and at least 80 cm from other units and other metal planes

3.1.5 EUT OPERATING CONDITIONS

The EUT was configured for testing in a typical fashion (as a customer would normally use it). The EUT has been programmed to continuously transmit during test. This operating condition was tested and used to collect the included data.

We pretest AC 120V and AC 240V, the worst voltage was AC 120V and the data recording in the report.

3.1.6 TEST RESULTS



Temperature :	25 °C	Relative Humidity :	54%
Pressure :	1010hPa	Phase :	L
Test Voltage :	AC 120V/60Hz	Test Mode :	Mode 4

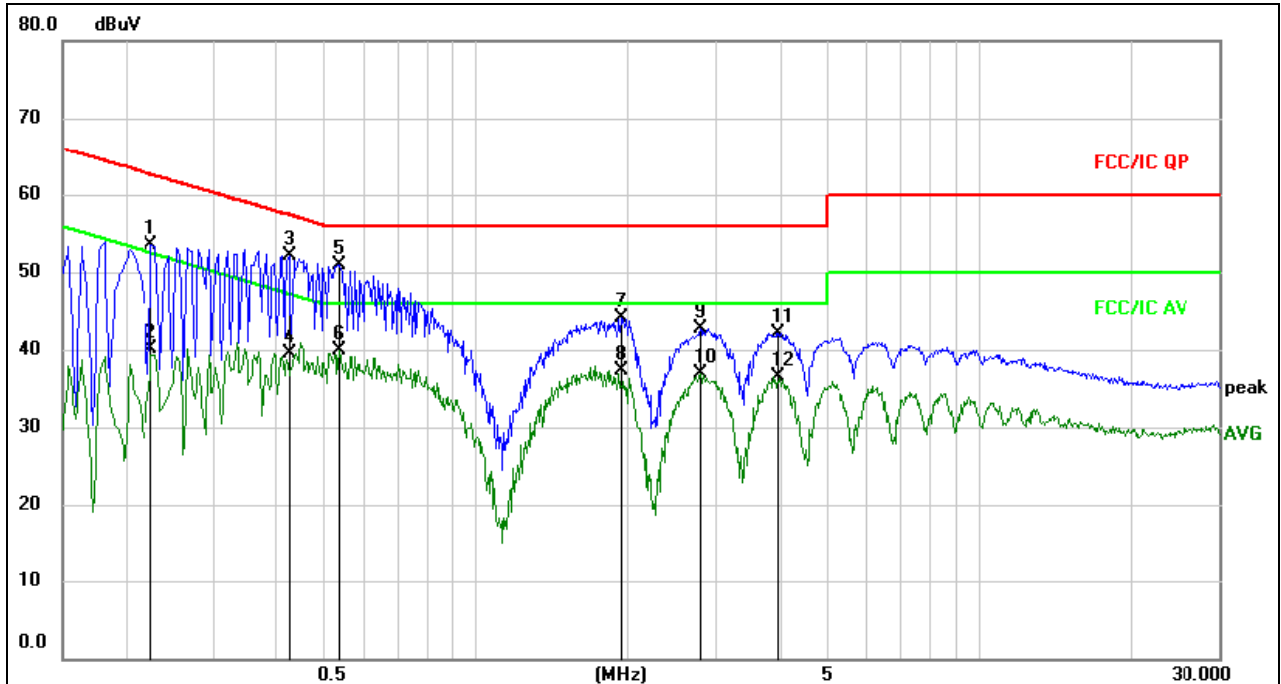

Remark:

1. All readings are Quasi-Peak and Average values.
2. Factor = Insertion Loss + Cable Loss.

No.	Mk.	Freq. MHz	Reading Level dBuV	Correct Factor dB	Measure- ment dBuV	Limit dBuV	Over dB	Detector	Comment
1		0.2265	43.94	9.65	53.59	62.58	-8.99	QP	
2		0.2265	30.41	9.65	40.06	52.58	-12.52	AVG	
3		0.4245	42.40	9.67	52.07	57.36	-5.29	QP	
4		0.4245	29.80	9.67	39.47	47.36	-7.89	AVG	
5	*	0.5325	41.30	9.68	50.98	56.00	-5.02	QP	
6		0.5325	30.25	9.68	39.93	46.00	-6.07	AVG	
7		1.9410	34.44	9.71	44.15	56.00	-11.85	QP	
8		1.9410	27.50	9.71	37.21	46.00	-8.79	AVG	
9		2.7915	32.92	9.72	42.64	56.00	-13.36	QP	
10		2.7915	27.10	9.72	36.82	46.00	-9.18	AVG	
11		3.9795	32.34	9.73	42.07	56.00	-13.93	QP	
12		3.9795	26.84	9.73	36.57	46.00	-9.43	AVG	



Temperature :	25 °C	Relative Humidity :	54%
Pressure :	1010hPa	Phase :	N
Test Voltage :	AC 120V/60Hz	Test Mode :	Mode 4

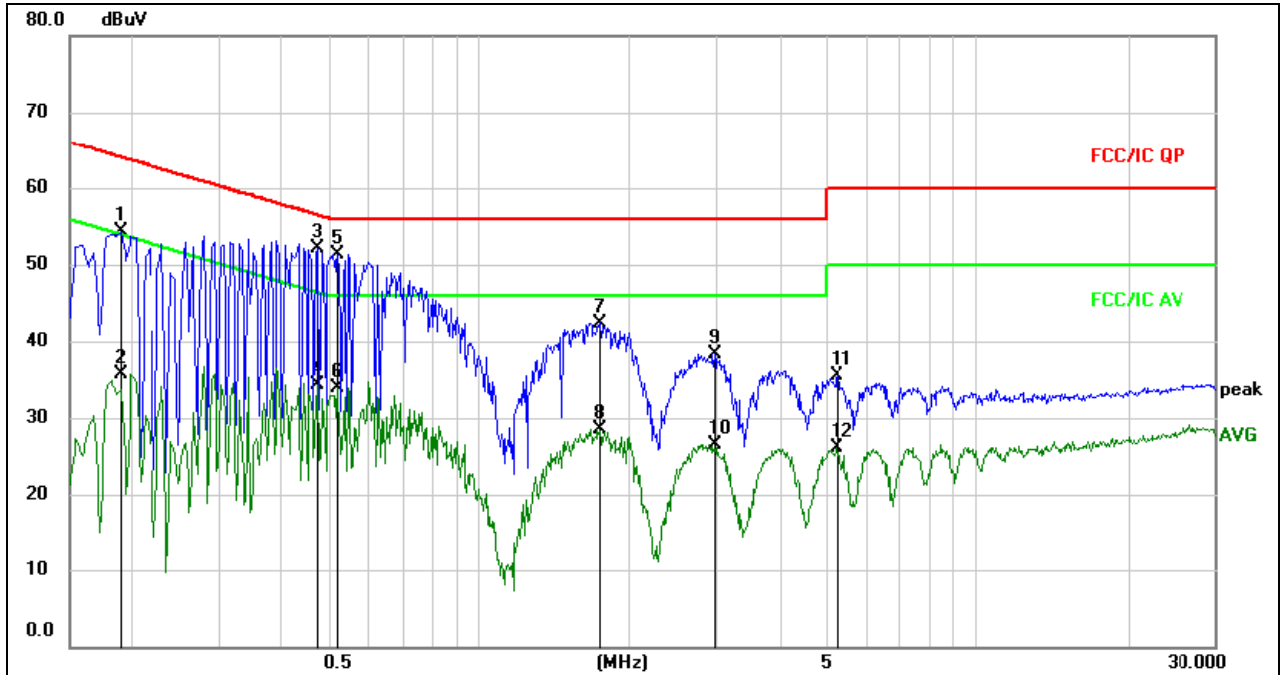

Remark:

1. All readings are Quasi-Peak and Average values.
2. Factor = Insertion Loss + Cable Loss.

No.	Mk.	Freq. MHz	Reading Level dBuV	Correct Factor dB	Measure- ment dBuV	Limit dBuV	Over dB	Detector	Comment
1		0.1905	44.64	9.65	54.29	64.01	-9.72	QP	
2		0.1905	25.97	9.65	35.62	54.01	-18.39	AVG	
3	*	0.4740	42.40	9.68	52.08	56.44	-4.36	QP	
4		0.4740	24.59	9.68	34.27	46.44	-12.17	AVG	
5		0.5190	41.65	9.68	51.33	56.00	-4.67	QP	
6		0.5190	24.31	9.68	33.99	46.00	-12.01	AVG	
7		1.7475	32.70	9.70	42.40	56.00	-13.60	QP	
8		1.7475	18.82	9.70	28.52	46.00	-17.48	AVG	
9		2.9760	28.62	9.72	38.34	56.00	-17.66	QP	
10		2.9760	16.86	9.72	26.58	46.00	-19.42	AVG	
11		5.2395	25.68	9.75	35.43	60.00	-24.57	QP	
12		5.2395	16.33	9.75	26.08	50.00	-23.92	AVG	



3.2 RADIATED EMISSION MEASUREMENT

3.2.1 RADIATED EMISSION LIMITS (Frequency Range 9KHZ-25000MHz)

20dBc in any 100 kHz bandwidth outside the operating frequency band. In case the emission fall within the restricted band specified on 15.205(a), then the 15.209(a) limit in the table below has to be followed.

Frequencies (MHz)	Field Strength (micorvolts/meter)	Measurement Distance (meters)
0.009~0.490	2400/F(KHz)	300
0.490~1.705	24000/F(KHz)	30
1.705~30.0	30	30
30~88	100	3
88~216	150	3
216~960	200	3
Above 960	500	3

LIMITS OF RADIATED EMISSION MEASUREMENT (Above 1000MHz)

FREQUENCY (MHz)	Limit (dBuV/m) (at 3M)	
	PEAK	AVERAGE
Above 1000	74	54

Notes:

- (1) The limit for radiated test was performed according to FCC PART 15C.
- (2) The tighter limit applies at the band edges.
- (3) Emission level (dBuV/m)=20log Emission level (uV/m).

Spectrum Parameter	Setting
Attenuation	Auto
Start Frequency	1000 MHz
Stop Frequency	25GHz
RB / VB (emission in restricted band)	1 MHz / 1 MHz for Peak, 1 MHz / 10Hz for Average

Receiver Parameter	Setting
Attenuation	Auto
Start ~ Stop Frequency	9kHz~150kHz / RB 200Hz for QP
Start ~ Stop Frequency	150kHz~30MHz / RB 9kHz for QP
Start ~ Stop Frequency	30MHz~1000MHz / RB 120kHz for QP

3.2.2 TEST PROCEDURE

Below 1GHz test procedure as below:

- a. The EUT was placed on the top of a rotating table 0.8 meters above the ground at a 3 meter semi-anechoic chamber. The table was rotated 360 degrees to determine the position of the highest radiation.
- b. The EUT was set 3 meters away from the interference-receiving antenna, which was mounted on the top of a variable-height antenna tower.
- c. The antenna height is varied from one meter to four meters above the ground to determine the maximum value of the field strength. Both horizontal and vertical polarizations of the antenna are set to make the measurement.
- d. For each suspected emission, the EUT was arranged to its worst case and then the antenna was tuned to heights from 1 meter to 4 meters (for the test frequency of below 30MHz, the antenna was tuned to heights 1 meter) and the rotatable table was turned from 0 degrees to 360 degrees to find the maximum reading.
- e. The test-receiver system was set to Peak Detect Function and Specified Bandwidth with Maximum Hold Mode.
- f. If the emission level of the EUT in peak mode was 10dB lower than the limit specified, then testing could be stopped and the peak values of the EUT would be reported. Otherwise the emissions that did not have 10dB margin would be re-tested one by one using peak, quasi-peak or average method as specified and then reported in a data sheet.

Above 1GHz test procedure as below:

- g. Different between above is the test site, change from Semi- Anechoic Chamber to fully Anechoic Chamber and change form table 0.8 metre to 1.5 metre(Above 18GHz the distance is 1 meter and table is 1.5 metre).
- h. Test the EUT in the lowest channel ,the middle channel ,the Highest channel

Note:

Both horizontal and vertical antenna polarities were tested and performed pretest to three orthogonal axis. The worst case emissions were reported

3.2.3 DEVIATION FROM TEST STANDARD

No deviation

3.2.4 TEST SETUP

(A) Radiated Emission Test-Up Frequency Below 30MHz

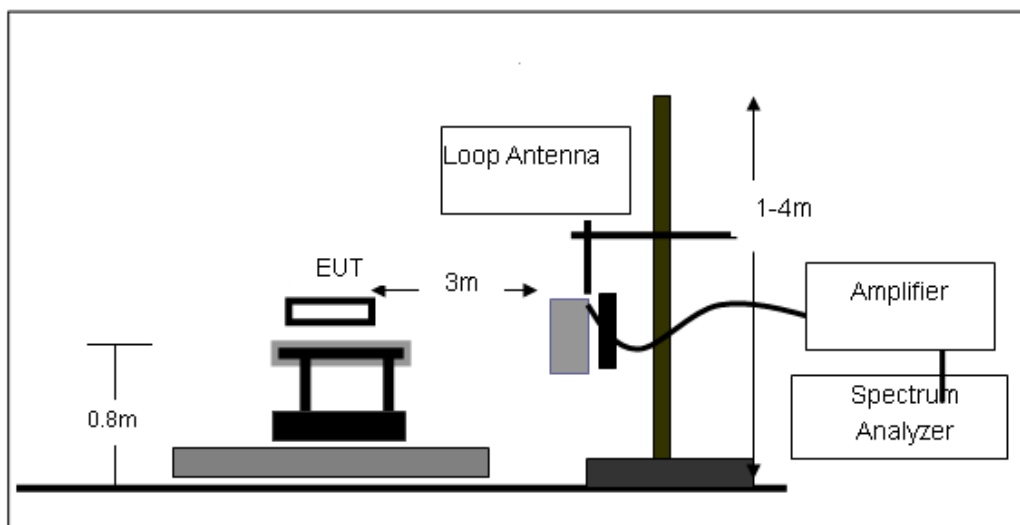

(B) Radiated Emission Test-Up Frequency 30MHz~1GHz

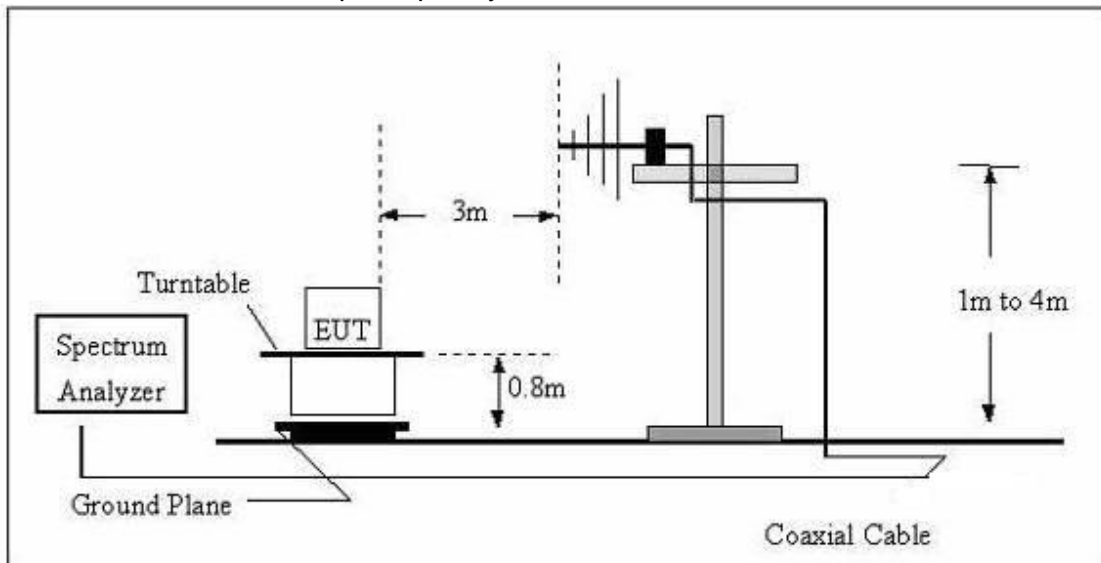

(C) Radiated Emission Test-Up Frequency Above 1GHz

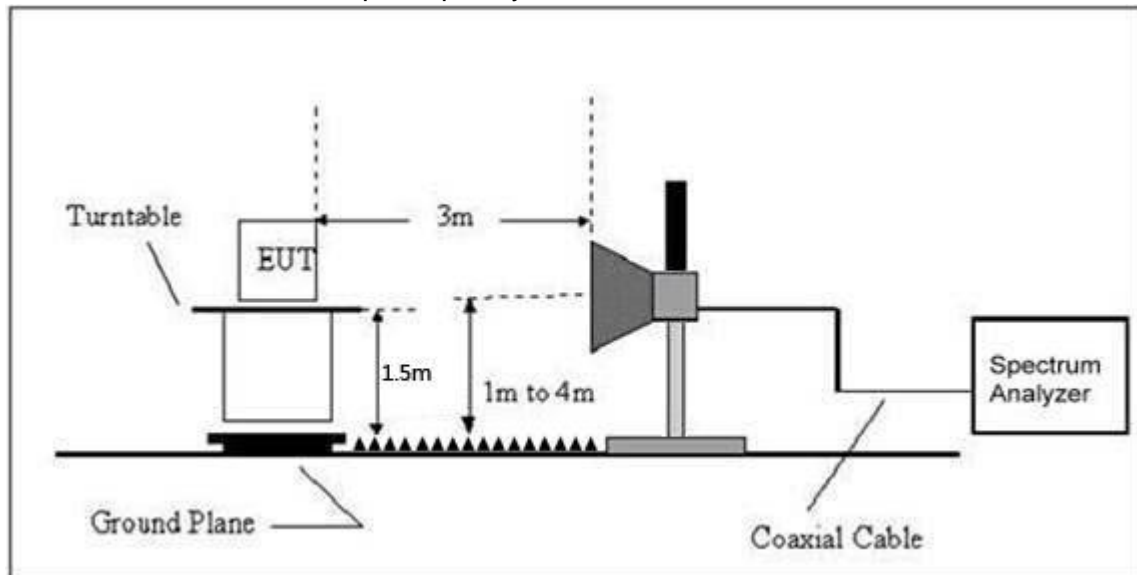

3.2.5 EUT OPERATING CONDITIONS

The EUT tested system was configured as the statements of 2.4 Unless otherwise a special operating condition is specified in the follows during the testing.

**3.2.6 TEST RESULTS (BETWEEN 9KHZ – 30 MHZ)**

Temperature:	20°C	Relative Humidity:	48%
Pressure:	1010 hPa	Test Voltage :	AC 120V/60Hz
Test Mode :	Mode 4	Polarization :	--

Freq. (MHz)	Reading (dBuV/m)	Limit (dBuV/m)	Margin (dB)	State P/F
--	--	--	--	PASS
--	--	--	--	PASS

NOTE:

The amplitude of spurious emissions which are attenuated by more than 20dB below the permissible value has no need to be reported.

Distance extrapolation factor = $40 \log(\text{specific distance}/\text{test distance})$ (dB);

Limit line = specific limits(dBuv) + distance extrapolation factor.



3.2.7 TEST RESULTS (BETWEEN 30MHZ – 1GHZ)

Temperature :	26°C	Relative Humidity :	54%
Pressure :	1010 hPa	Polarization :	Horizontal
Test Voltage :	AC 120V/60Hz		
Test Mode :	Mode 4		

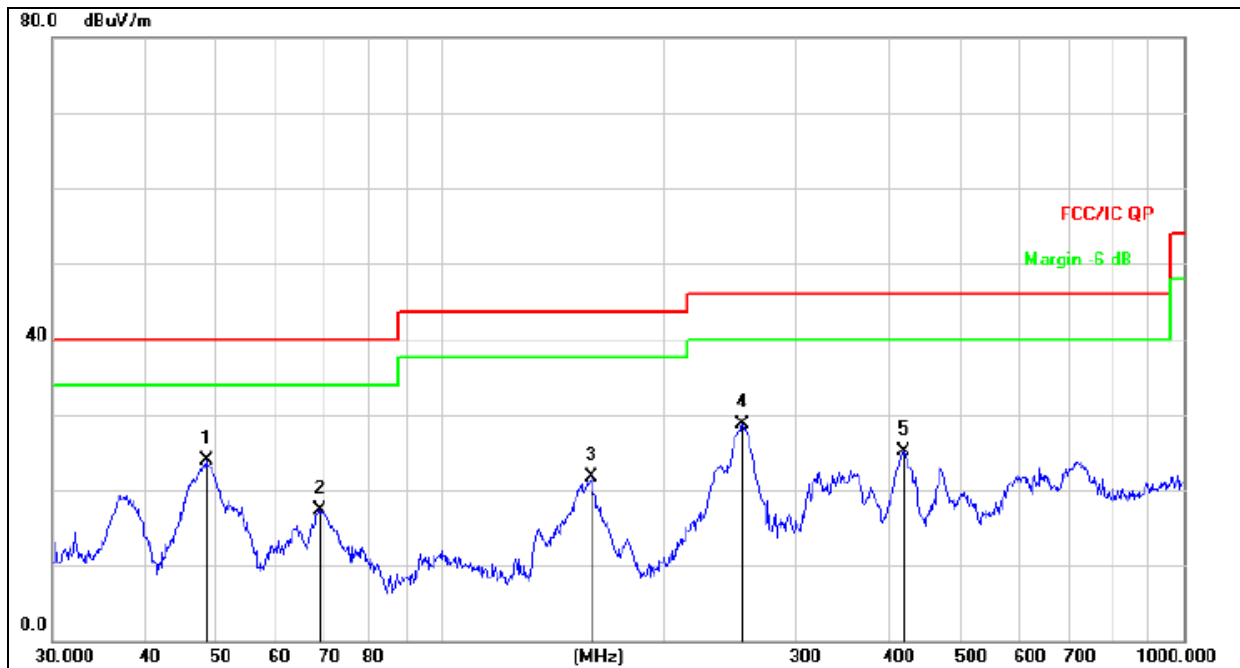

Remark:
Factor = Antenna Factor + Cable Loss – Pre-amplifier.

No.	Mk.	Freq. MHz	Reading Level dBuV	Correct Factor dB	Measure- ment dBuV/m	Limit dB/m	Over dB	Detector
1	*	48.3318	37.82	-13.97	23.85	40.00	-16.15	QP
2		68.8721	34.76	-17.36	17.40	40.00	-22.60	QP
3		159.2251	40.70	-19.06	21.64	43.50	-21.86	QP
4		254.7284	43.73	-15.06	28.67	46.00	-17.33	QP
5		420.5803	36.24	-11.14	25.10	46.00	-20.90	QP



Temperature :	26°C	Relative Humidity :	54%
Pressure :	1010 hPa	Polarization :	Vertical
Test Voltage :	AC 120V/60Hz		
Test Mode :	Mode 4		

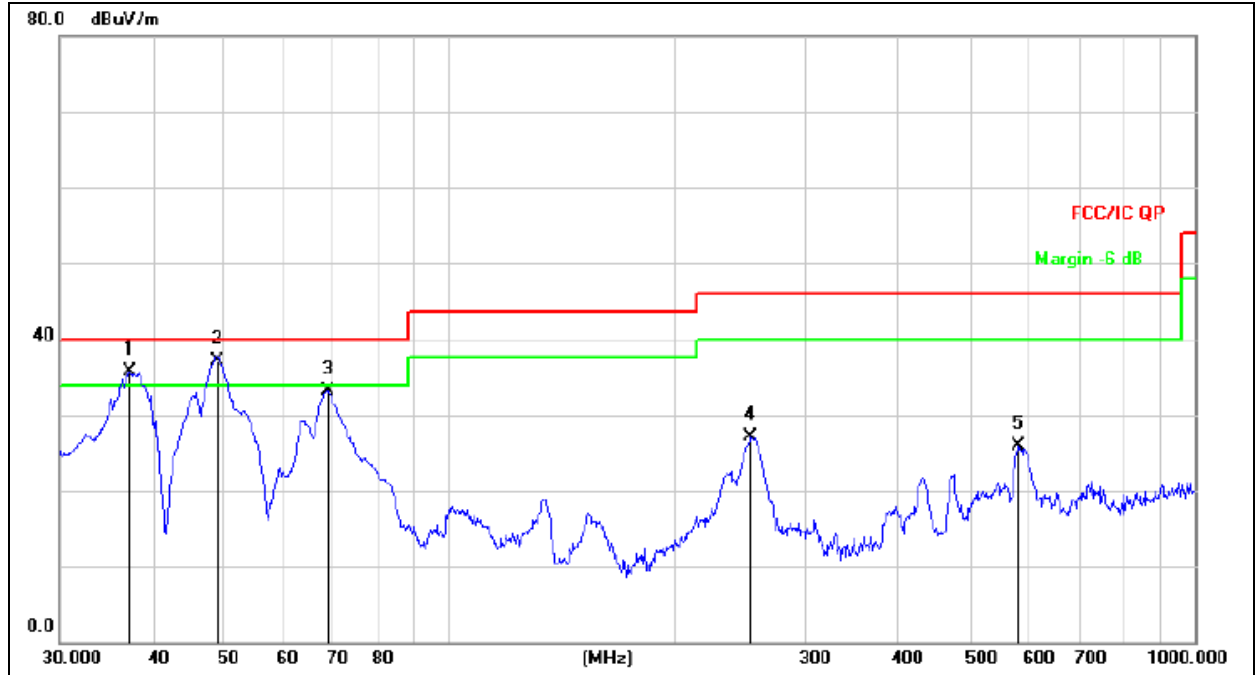

Remark:
Factor = Antenna Factor + Cable Loss – Pre-amplifier.

No.	Mk.	Freq. MHz	Reading Level dBuV	Correct Factor dB	Measure- ment dBuV/m	Limit dB/m	Over dB	Detector
1	!	37.2854	51.31	-15.69	35.62	40.00	-4.38	QP
2	*	48.9519	51.15	-13.97	37.18	40.00	-2.82	QP
3		68.6310	50.47	-17.32	33.15	40.00	-6.85	QP
4		253.8367	42.10	-15.07	27.03	46.00	-18.97	QP
5		580.7025	32.97	-6.99	25.98	46.00	-20.02	QP



3.2.8 TEST RESULTS (1GHZ-25GHZ)

802.11b

Polar (H/V)	Frequency	Meter Reading	Pre-amplifier	Cable Loss	Antenna Factor	Emission Level	Limits	Margin	Detector Type
	(MHz)	(dBuV)	(dB)	(dB)	(dB)	(dBuV/m)	(dBuV/m)	(dB)	
Low Channel:2412MHz									
V	4824.00	66.85	39.55	7.85	25.66	60.81	74.00	-13.19	PK
V	4824.00	49.76	39.55	7.85	25.66	43.72	54.00	-10.28	AV
V	7236.00	67.24	38.33	7.52	24.55	60.98	74.00	-13.02	PK
V	7236.00	47.82	38.33	7.52	24.55	41.56	54.00	-12.44	AV
V	15450.00	46.39	35.23	6.75	26.59	44.50	74.00	-29.50	PK
H	4824.00	67.67	39.55	7.85	25.66	61.63	74.00	-12.37	PK
H	4824.00	50.78	39.55	7.85	25.66	44.74	54.00	-9.26	AV
H	7236.00	68.71	38.33	7.52	23.55	61.45	74.00	-12.55	PK
H	7236.00	44.86	38.33	7.52	23.22	37.27	54.00	-16.73	AV
H	15450.00	47.73	35.45	6.75	27.88	46.91	74.00	-27.09	PK

Polar (H/V)	Frequency	Meter Reading	Pre-amplifier	Cable Loss	Antenna Factor	Emission Level	Limits	Margin	Detector Type
	(MHz)	(dBuV)	(dB)	(dB)	(dB)	(dBuV/m)	(dBuV/m)	(dB)	
Middle Channel:2437									
V	4874.00	67.76	38.89	7.57	25.45	61.89	74.00	-12.11	PK
V	4874.00	50.12	38.89	7.57	25.45	44.25	54.00	-9.75	AV
V	7311.00	67.84	38.78	7.35	24.78	61.19	74.00	-12.81	PK
V	7311.00	48.36	38.78	7.35	24.78	41.71	54.00	-12.29	AV
V	15450.00	52.56	35.89	6.42	26.47	49.56	74.00	-24.44	PK
H	4874.00	66.04	38.89	7.57	25.45	60.17	74.00	-13.83	PK
H	4874.00	49.96	38.89	7.57	25.45	44.09	54.00	-9.91	AV
H	7311.00	68.93	38.78	7.35	24.78	62.28	74.00	-11.72	PK
H	7311.00	46.72	38.78	7.35	24.78	40.07	54.00	-13.93	AV
H	15450.00	45.61	36.68	6.42	26.65	42.00	74.00	-32.00	PK

Polar (H/V)	Frequency	Meter Reading	Pre-amplifier	Cable Loss	Antenna Factor	Emission Level	Limits	Margin	Detector Type
	(MHz)	(dBuV)	(dB)	(dB)	(dB)	(dBuV/m)	(dBuV/m)	(dB)	
High Channel: 2462MHz									
V	4924.00	66.56	38.75	7.46	25.45	60.72	74.00	-13.28	PK
V	4924.00	47.71	38.75	7.46	25.45	41.87	54.00	-12.13	AV
V	7386.00	68.12	38.65	7.22	24.78	61.47	74.00	-12.53	PK
V	7386.00	49.38	38.65	7.22	24.78	42.73	54.00	-11.27	AV
V	15450.00	46.74	35.58	6.35	26.47	43.98	74.00	-30.02	PK
H	4924.00	47.97	38.75	7.46	25.45	42.13	74.00	-31.87	PK
H	4924.00	46.86	38.75	7.46	25.45	41.02	54.00	-12.98	AV
H	7386.00	62.77	38.65	7.22	24.78	56.12	74.00	-17.88	PK
H	7386.00	46.36	38.65	7.22	24.78	39.71	54.00	-14.29	AV
H	15450.00	46.31	36.42	6.32	26.65	42.86	74.00	-31.14	PK

Remark:

1. Emission Level = Meter Reading + Antenna Factor + Cable Loss – Pre-amplifier,
Margin= Emission Level - Limit
2. If peak below the average limit, the average emission was no test.
3. The amplitude of spurious emissions which are attenuated by more than 20dB below the permissible value has no need to be reported.



802.11g

Polar (H/V)	Frequency	Meter Reading	Pre-amplifier	Cable Loss	Antenna Factor	Emission Level	Limits	Margin	Detector Type
	(MHz)	(dBuV)	(dB)	(dB)	(dB)	(dBuV/m)	(dBuV/m)	(dB)	
Low Channel:2412MHz									
V	4824.00	66.33	66.49	7.85	25.66	60.45	74.00	-13.55	PK
V	4824.00	48.14	49.49	7.85	25.66	43.45	54.00	-10.55	AV
V	7236.00	64.86	66.88	7.52	24.55	60.62	74.00	-13.39	PK
V	7236.00	47.38	47.57	7.52	24.55	41.31	54.00	-12.69	AV
V	15450.00	50.36	46.14	6.75	26.59	44.25	74.00	-29.75	PK
H	4824.00	65.90	67.30	7.85	25.66	61.26	74.00	-12.74	PK
H	4824.00	49.35	50.51	7.85	25.66	44.47	54.00	-9.53	AV
H	7236.00	65.89	68.34	7.52	23.55	61.08	74.00	-12.92	PK
H	7236.00	49.02	44.61	7.52	23.22	37.02	54.00	-16.98	AV
H	15450.00	46.87	47.48	6.75	27.88	46.66	74.00	-27.34	PK

Polar (H/V)	Frequency	Meter Reading	Pre-amplifier	Cable Loss	Antenna Factor	Emission Level	Limits	Margin	Detector Type
	(MHz)	(dBuV)	(dB)	(dB)	(dB)	(dBuV/m)	(dBuV/m)	(dB)	
Middle Channel:2437									
V	4874.00	67.39	38.89	7.57	25.45	61.52	74.00	-12.48	PK
V	4874.00	49.85	38.89	7.57	25.45	43.98	54.00	-10.02	AV
V	7311.00	67.47	38.78	7.35	24.78	60.82	74.00	-13.18	PK
V	7311.00	48.10	38.78	7.35	24.78	41.45	54.00	-12.55	AV
V	15450.00	52.27	35.89	6.42	26.47	49.27	74.00	-24.73	PK
H	4874.00	65.69	38.89	7.57	25.45	59.82	74.00	-14.18	PK
H	4874.00	49.69	38.89	7.57	25.45	43.82	54.00	-10.18	AV
H	7311.00	68.56	38.78	7.35	24.78	61.91	74.00	-12.09	PK
H	7311.00	46.47	38.78	7.35	24.78	39.82	54.00	-14.18	AV
H	15450.00	45.37	36.68	6.42	26.65	41.76	74.00	-32.24	PK

Polar (H/V)	Frequency	Meter Reading	Pre-amplifier	Cable Loss	Antenna Factor	Emission Level	Limits	Margin	Detector Type
	(MHz)	(dBuV)	(dB)	(dB)	(dB)	(dBuV/m)	(dBuV/m)	(dB)	
High Channel: 2462MHz									
V	4924.00	66.20	38.75	7.46	25.45	60.36	74.00	-13.64	PK
V	4924.00	47.46	38.75	7.46	25.45	41.62	54.00	-12.38	AV
V	7386.00	67.76	38.65	7.22	24.78	61.11	74.00	-12.89	PK
V	7386.00	49.11	38.65	7.22	24.78	42.46	54.00	-11.54	AV
V	15450.00	46.49	35.58	6.35	26.47	43.73	74.00	-30.27	PK
H	4924.00	47.71	38.75	7.46	25.45	41.87	74.00	-32.13	PK
H	4924.00	46.60	38.75	7.46	25.45	40.76	54.00	-13.24	AV
H	7386.00	62.43	38.65	7.22	24.78	55.78	74.00	-18.22	PK
H	7386.00	46.11	38.65	7.22	24.78	39.46	54.00	-14.54	AV
H	15450.00	46.06	36.42	6.32	26.65	42.61	74.00	-31.39	PK

Remark:

1. Emission Level = Meter Reading + Antenna Factor + Cable Loss – Pre-amplifier,
Margin= Emission Level - Limit
2. If peak below the average limit, the average emission was no test.
3. The amplitude of spurious emissions which are attenuated by more than 20dB below the permissible value has no need to be reported.



802.11n(20MHz)

Polar (H/V)	Frequency	Meter Reading	Pre-amplifier	Cable Loss	Antenna Factor	Emission Level	Limits	Margin	Detector Type
	(MHz)	(dBuV)	(dB)	(dB)	(dB)	(dBuV/m)	(dBuV/m)	(dB)	
Low Channel:2412MHz									
V	4824.00	66.12	39.55	7.85	25.66	60.08	74.00	-13.92	PK
V	4824.00	49.22	39.55	7.85	25.66	43.18	54.00	-10.82	AV
V	7236.00	66.51	38.33	7.52	24.55	60.25	74.00	-13.75	PK
V	7236.00	47.30	38.33	7.52	24.55	41.04	54.00	-12.96	AV
V	15450.00	45.89	35.23	6.75	26.59	44.00	74.00	-30.00	PK
H	4824.00	66.93	39.55	7.85	25.66	60.89	74.00	-13.11	PK
H	4824.00	50.23	39.55	7.85	25.66	44.19	54.00	-9.81	AV
H	7236.00	67.97	38.33	7.52	23.55	60.71	74.00	-13.29	PK
H	7236.00	44.37	38.33	7.52	23.22	36.78	54.00	-17.22	AV
H	15450.00	47.22	35.45	6.75	27.88	46.40	74.00	-27.60	PK

Polar (H/V)	Frequency	Meter Reading	Pre-amplifier	Cable Loss	Antenna Factor	Emission Level	Limits	Margin	Detector Type
	(MHz)	(dBuV)	(dB)	(dB)	(dB)	(dBuV/m)	(dBuV/m)	(dB)	
Middle Channel:2437									
V	4874.00	67.02	38.89	7.57	25.45	61.15	74.00	-12.85	PK
V	4874.00	49.58	38.89	7.57	25.45	43.71	54.00	-10.29	AV
V	7311.00	67.10	38.78	7.35	24.78	60.45	74.00	-13.55	PK
V	7311.00	47.84	38.78	7.35	24.78	41.19	54.00	-12.81	AV
V	15450.00	51.98	35.89	6.42	26.47	48.98	74.00	-25.02	PK
H	4874.00	65.33	38.89	7.57	25.45	59.46	74.00	-14.55	PK
H	4874.00	49.41	38.89	7.57	25.45	43.54	54.00	-10.46	AV
H	7311.00	68.18	38.78	7.35	24.78	61.53	74.00	-12.47	PK
H	7311.00	46.21	38.78	7.35	24.78	39.56	54.00	-14.44	AV
H	15450.00	45.12	36.68	6.42	26.65	41.51	74.00	-32.49	PK

Polar (H/V)	Frequency	Meter Reading	Pre-amplifier	Cable Loss	Antenna Factor	Emission Level	Limits	Margin	Detector Type
	(MHz)	(dBuV)	(dB)	(dB)	(dB)	(dBuV/m)	(dBuV/m)	(dB)	
High Channel: 2462MHz									
V	4924.00	65.84	38.75	7.46	25.45	60.00	74.00	-14.00	PK
V	4924.00	47.20	38.75	7.46	25.45	41.36	54.00	-12.64	AV
V	7386.00	67.38	38.65	7.22	24.78	60.73	74.00	-13.27	PK
V	7386.00	48.84	38.65	7.22	24.78	42.19	54.00	-11.81	AV
V	15450.00	46.23	35.58	6.35	26.47	43.47	74.00	-30.53	PK
H	4924.00	47.45	38.75	7.46	25.45	41.61	74.00	-32.39	PK
H	4924.00	46.35	38.75	7.46	25.45	40.51	54.00	-13.49	AV
H	7386.00	62.08	38.65	7.22	24.78	55.43	74.00	-18.57	PK
H	7386.00	45.86	38.65	7.22	24.78	39.21	54.00	-14.79	AV
H	15450.00	45.81	36.42	6.32	26.65	42.36	74.00	-31.64	PK

Remark:

1. Emission Level = Meter Reading + Antenna Factor + Cable Loss – Pre-amplifier,
Margin= Emission Level - Limit
2. If peak below the average limit, the average emission was no test.
3. The amplitude of spurious emissions which are attenuated by more than 20dB below the permissible value has no need to be reported.



3.3 RADIATED BAND EMISSION MEASUREMENT

3.3.1 TEST REQUIREMENT:

FCC Part15 C Section 15.209 and 15.205

LIMITS OF RADIATED EMISSION MEASUREMENT (Above 1000MHz)

FREQUENCY (MHz)	Class B (dBuV/m) (at 3M)	
	PEAK	AVERAGE
Above 1000	74	54

Notes:

- (1) The limit for radiated test was performed according to FCC PART 15C.
- (2) The tighter limit applies at the band edges.
- (3) Emission level (dBuV/m)=20log Emission level (uV/m).

Spectrum Parameter	Setting
Attenuation	Auto
Start Frequency	2300MHz
Stop Frequency	2520
RB / VB (emission in restricted band)	1 MHz / 1 MHz for Peak, 1 MHz / 10Hz for Average

3.3.2 TEST PROCEDURE

Above 1GHz test procedure as below:

- a. 1. The EUT was placed on the top of a rotating table 1.5 meters above the ground at a 3 meter camber. The table was rotated 360 degrees to determine the position of the highest radiation.
- b. The EUT was set 3 meters away from the interference-receiving antenna, which was mounted on the top of a variable-height antenna tower.
- c. The antenna height is varied from one meter to four meters above the ground to determine the maximum value of the field strength. Both horizontal and vertical polarizations of the antenna are set to make the measurement.
- d. For each suspected emission, the EUT was arranged to its worst case and then the antenna was tuned to heights from 1 meter to 4 meters and the rota table was turned from 0 degrees to 360 degrees to find the maximum reading.
- e. The test-receiver system was set to Peak Detect Function and Specified Bandwidth with Maximum Hold Mode.
- f. If the emission level of the EUT in peak mode was 10dB lower than the limit specified, then testing could be stopped and the peak values of the EUT would be reported. Otherwise the emissions that did not have 10dB margin would be re-tested one by one using peak, quasi-peak or average method as specified and then reported in a data sheet.
- g. Test the EUT in the lowest channel,the Highest channel

Note:

Both horizontal and vertical antenna polarities were tested and performed pretest to three orthogonal axis. The worst case emissions were reported

3.3.3 DEVIATION FROM TEST STANDARD

No deviation

3.3.4 TEST SETUP

Radiated Emission Test-Up Frequency Above 1GHz

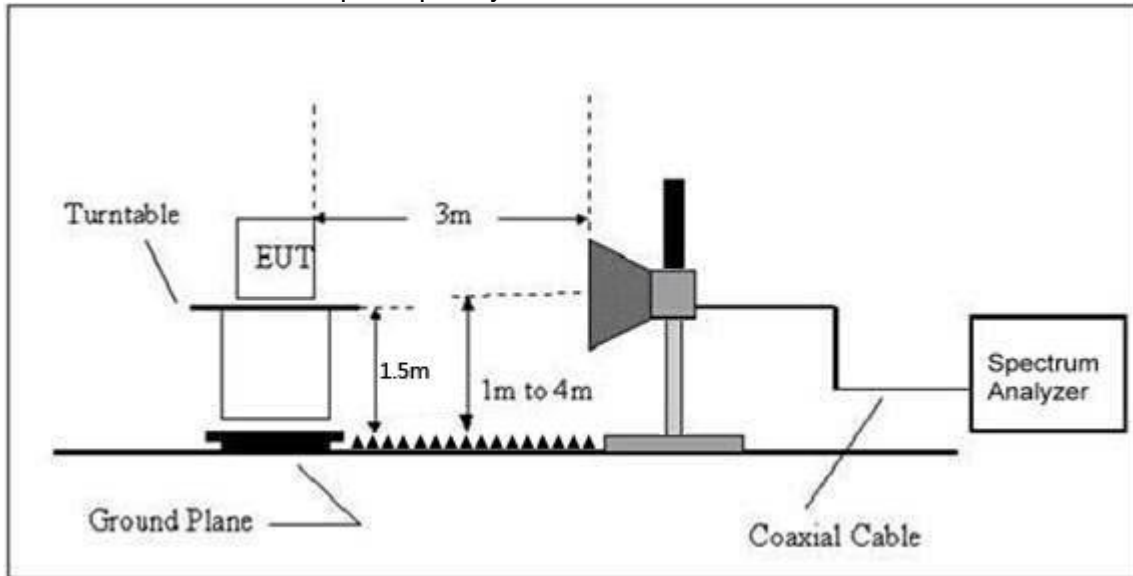

3.3.5 EUT OPERATING CONDITIONS

The EUT tested system was configured as the statements of 2.3 Unless otherwise a special operating condition is specified in the follows during the testing.



3.3.6 TEST RESULT

	Polar (H/V)	Frequency (MHz)	Meter Reading (dBuV)	Pre-amplifier (dB)	Cable Loss (dB)	Antenna Factor (dB/m)	Emission level (dBuV/m)	Limits (dBuV/m)		Result
							PK	PK	AV	
802.11b	Low Channel 2412MHz									
	H	2390.00	57.00	38.06	7.42	20.15	46.51	74.00	54.00	PASS
	H	2400.00	58.61	38.06	7.42	20.15	48.12	74.00	54.00	PASS
	V	2390.00	57.65	38.06	7.42	20.15	47.16	74.00	54.00	PASS
	V	2400.00	60.07	38.06	7.42	20.15	49.58	74.00	54.00	PASS
	High Channel 2462MHz									
	H	2483.50	59.57	38.17	7.45	20.54	49.39	74.00	54.00	PASS
	H	2485.50	56.93	38.17	7.45	20.54	46.75	74.00	54.00	PASS
	V	2483.50	60.64	38.20	7.45	20.54	50.43	74.00	54.00	PASS
	V	2485.50	55.54	38.20	7.45	20.54	45.33	74.00	54.00	PASS
802.11g	Low Channel 2412MHz									
	H	2390.00	57.93	38.06	7.42	20.15	47.44	74.00	54.00	PASS
	H	2400.00	60.66	38.06	7.42	20.15	50.17	74.00	54.00	PASS
	V	2390.00	58.07	38.06	7.42	20.15	47.58	74.00	54.00	PASS
	V	2400.00	59.59	38.06	7.42	20.15	49.10	74.00	54.00	PASS
	High Channel 2462MHz									
	H	2483.50	59.98	38.17	7.45	20.54	49.80	74.00	54.00	PASS
	H	2485.50	56.43	38.17	7.45	20.54	46.25	74.00	54.00	PASS
	V	2483.50	60.61	38.20	7.45	20.54	50.40	74.00	54.00	PASS
	V	2485.50	55.56	38.20	7.45	20.54	45.35	74.00	54.00	PASS
802.11n20	Low Channel 2412MHz									
	H	2390.00	57.96	38.06	7.42	20.15	47.47	74.00	54.00	PASS
	H	2400.00	60.83	38.06	7.42	20.15	50.34	74.00	54.00	PASS
	V	2390.00	58.12	38.06	7.42	20.15	47.63	74.00	54.00	PASS
	V	2400.00	59.47	38.06	7.42	20.15	48.98	74.00	54.00	PASS
	High Channel 2462MHz									
	H	2483.50	60.03	38.17	7.45	20.54	49.85	74.00	54.00	PASS
	H	2485.50	56.56	38.17	7.45	20.54	46.38	74.00	54.00	PASS
	V	2483.50	58.84	38.20	7.45	20.54	48.63	74.00	54.00	PASS
	V	2485.50	57.29	38.20	7.45	20.54	47.08	74.00	54.00	PASS
Remark:										
1. Emission Level = Meter Reading + Antenna Factor + Cable Loss – Pre-amplifier, Margin= Emission Level - Limit										
2. If the PK measured levels comply with average limit, then the average level were deemed to comply with average limit.										



4. POWER SPECTRAL DENSITY TEST

4.1 APPLIED PROCEDURES / LIMIT

FCC Part15 (15.247) , Subpart C				
Section	Test Item	Limit	Frequency Range (MHz)	Result
15.247	Power Spectral Density	8 dBm (in any 3KHz)	2400-2483.5	PASS

4.1.1 TEST PROCEDURE

1. Set analyzer center frequency to DTS channel center frequency.
2. Set the span to 1.5 times the DTS bandwidth.
3. Set the RBW to: $3\text{ kHz} \leq \text{RBW} \leq 100\text{ kHz}$.
4. Set the VBW $\geq 3 \times \text{RBW}$.
5. Detector = peak.
6. Sweep time = auto couple.
7. Trace mode = max hold.
8. Allow trace to fully stabilize.
9. Use the peak marker function to determine the maximum amplitude level within the RBW.
10. If measured value exceeds limit, reduce RBW (no less than 3 kHz) and repeat.

4.1.2 DEVIATION FROM STANDARD

No deviation.

4.1.3 TEST SETUP



4.1.4 EUT OPERATION CONDITIONS

The EUT tested system was configured as the statements of 2.1 Unless otherwise a special operating condition is specified in the follows during the testing.

Note: Power Spectral Density(dBm)=Reading+Cable Loss



4.1.5 TEST RESULTS

Temperature :	25°C	Relative Humidity :	60%
Pressure :	1015 hPa	Test Voltage :	AC 120V/60Hz
Test Mode :	TX b Mode		

Frequency	Power Spectral Density(dBm)	Limit (dBm)	Result
2412 MHz	-8.913	8	PASS
2437 MHz	-9.700	8	PASS
2462 MHz	-10.450	8	PASS

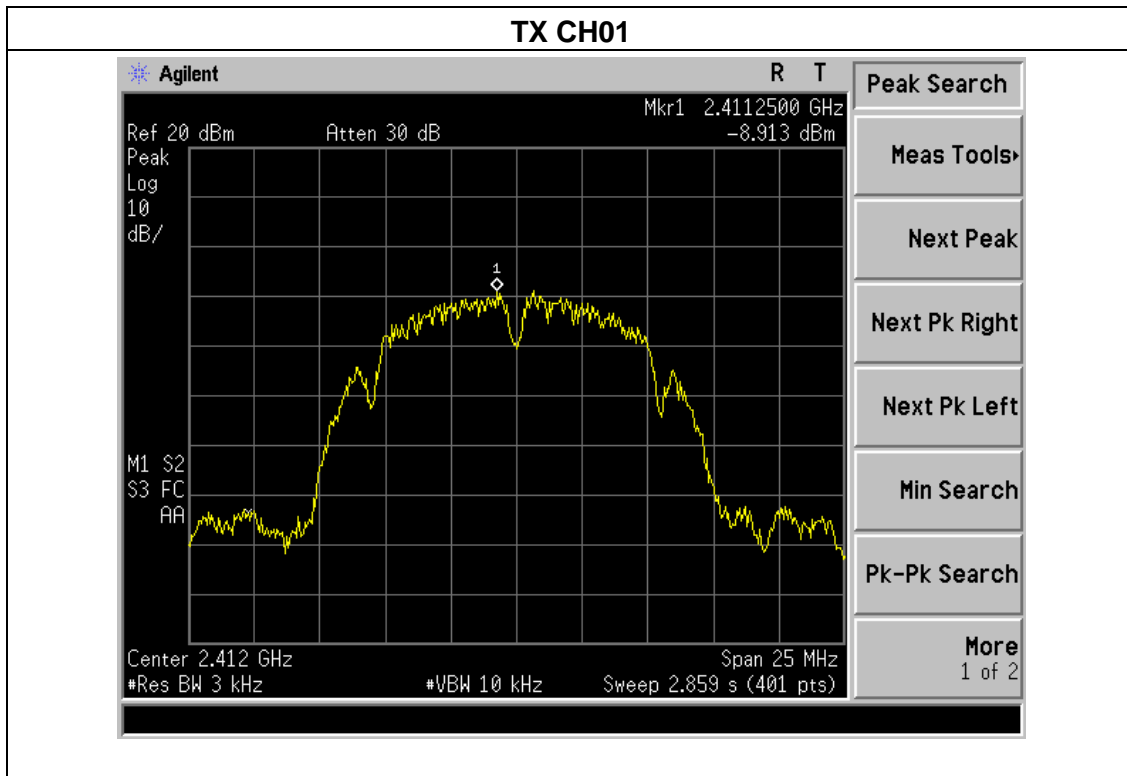

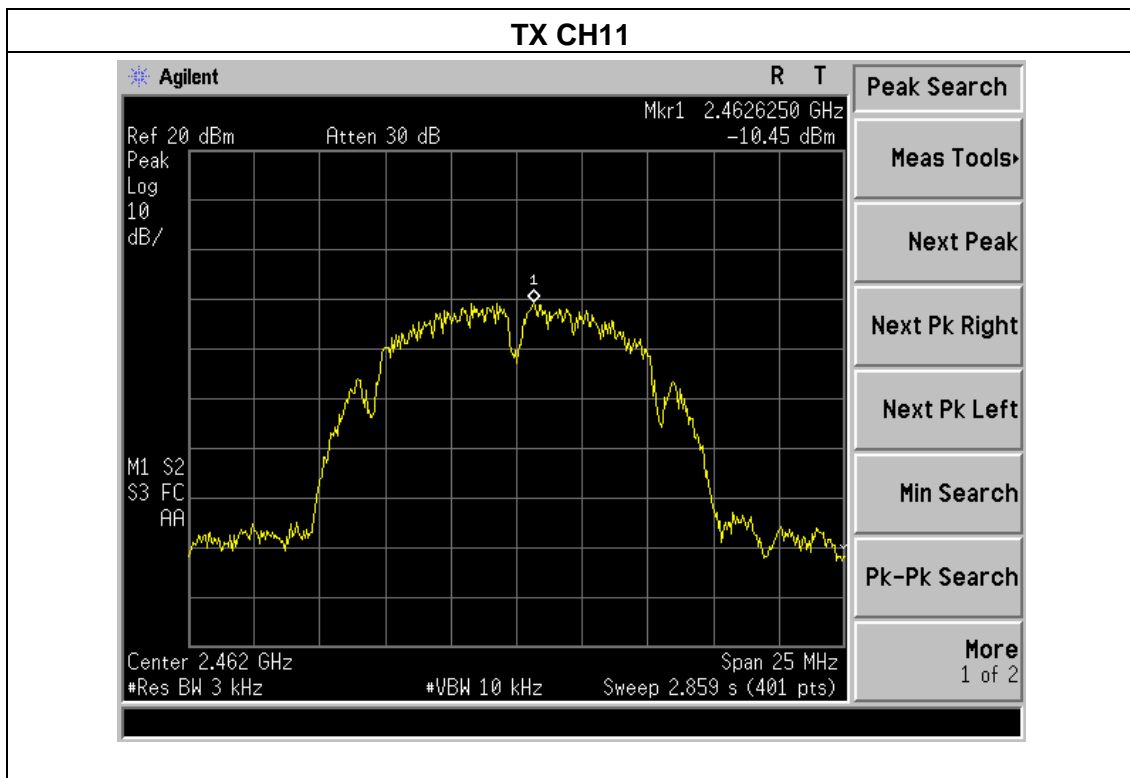
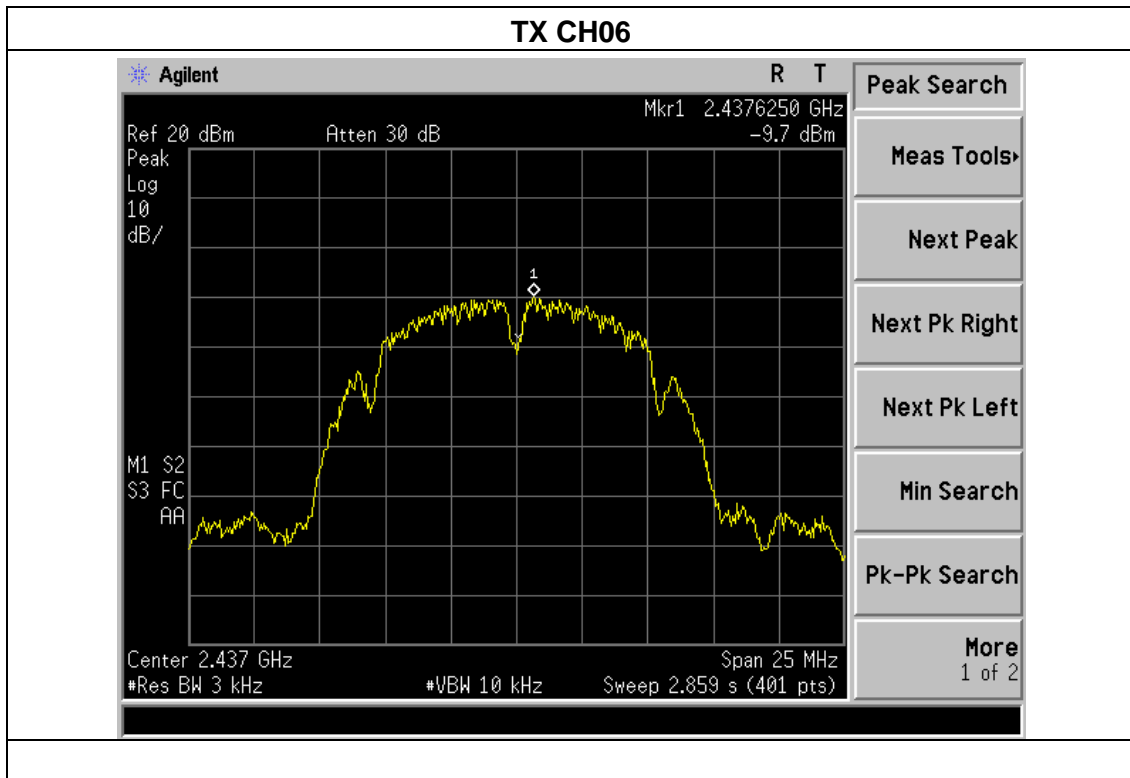



Temperature :	25°C	Relative Humidity :	60%
Pressure :	1015 hPa	Test Voltage :	AC 120V/60Hz
Test Mode :	TX g Mode		

Frequency	Power Spectral Density(dBm)	Limit (dBm)	Result
2412 MHz	-10.55	8	PASS
2437 MHz	-10.81	8	PASS
2462 MHz	-11.46	8	PASS

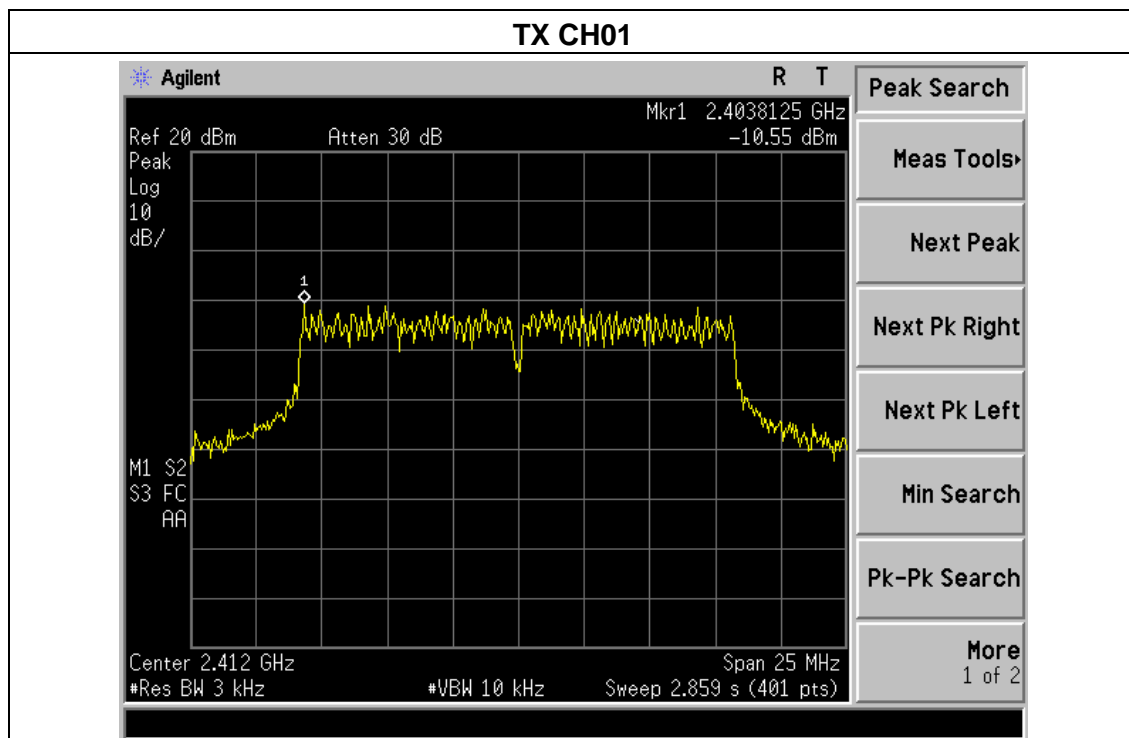

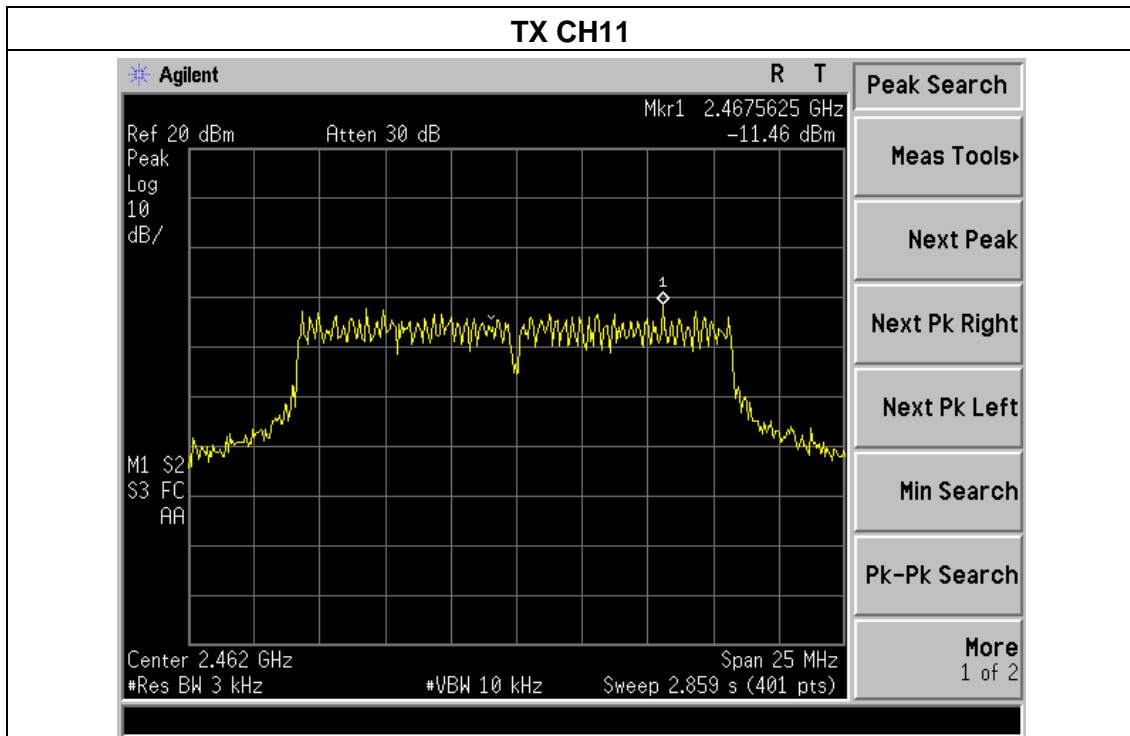
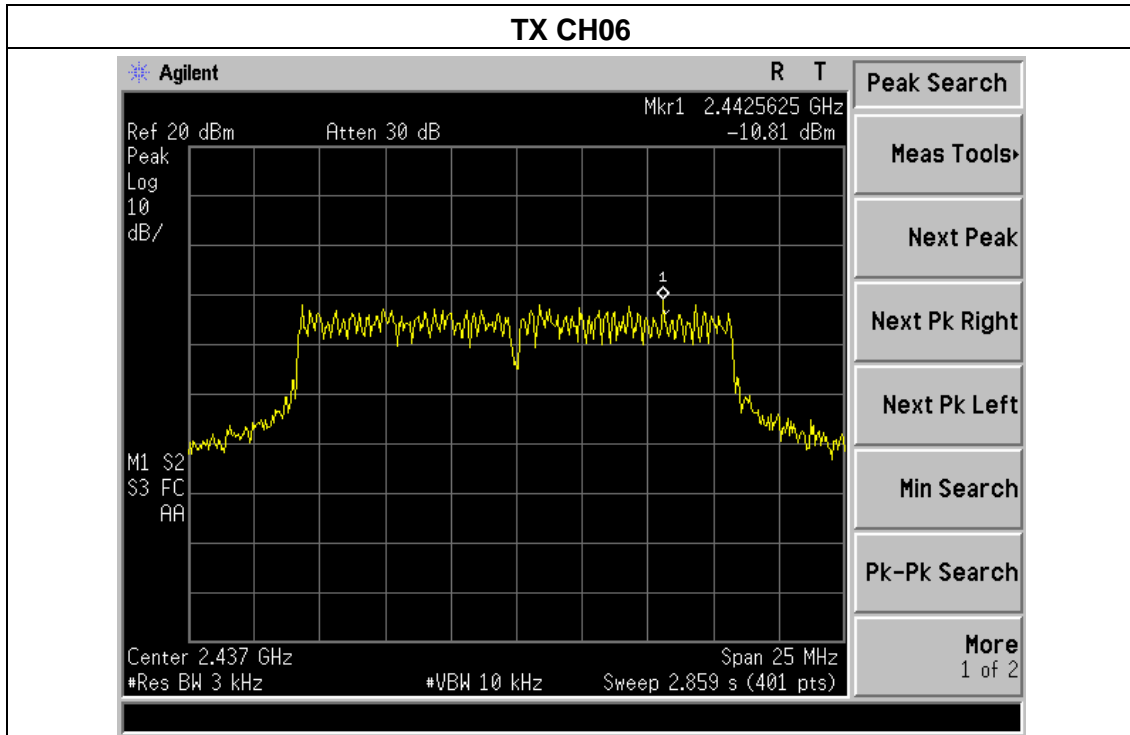



Temperature :	25°C	Relative Humidity :	60%
Pressure :	1015 hPa	Test Voltage :	AC 120V/60Hz
Test Mode :	TX n Mode(20M)		

Frequency	Power Spectral Density(dBm)	Limit (dBm)	Result
2412 MHz	-11.77	8	PASS
2437 MHz	-11.89	8	PASS
2462 MHz	-12.85	8	PASS

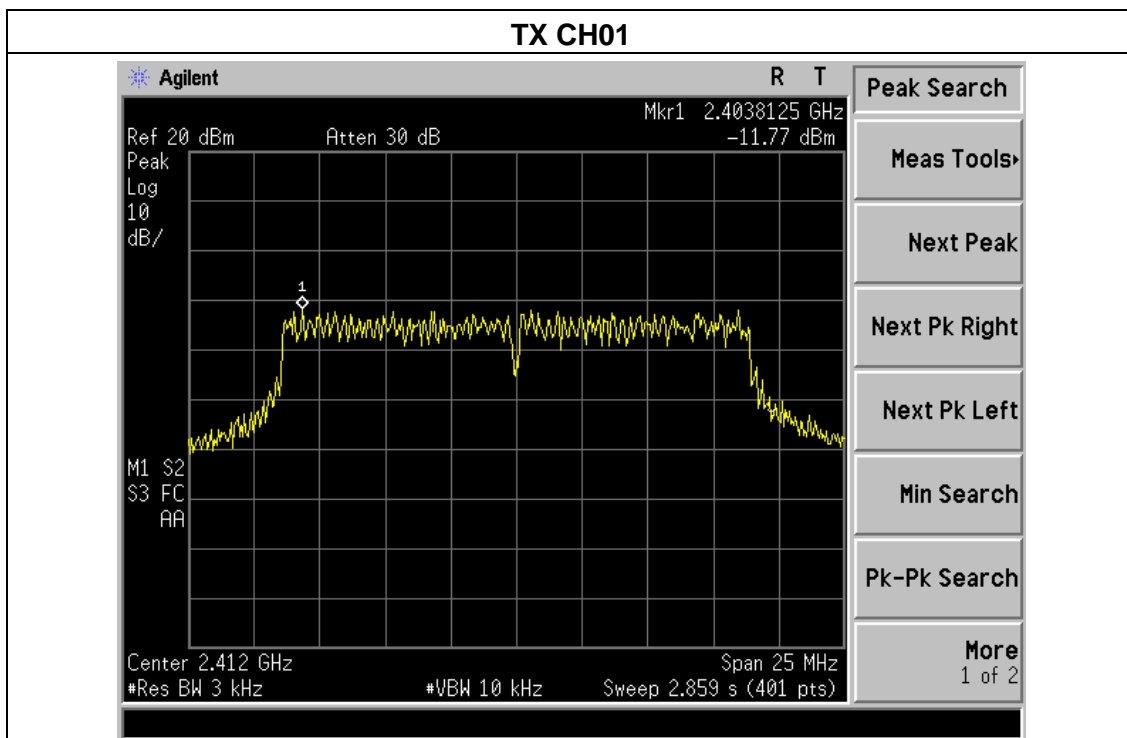

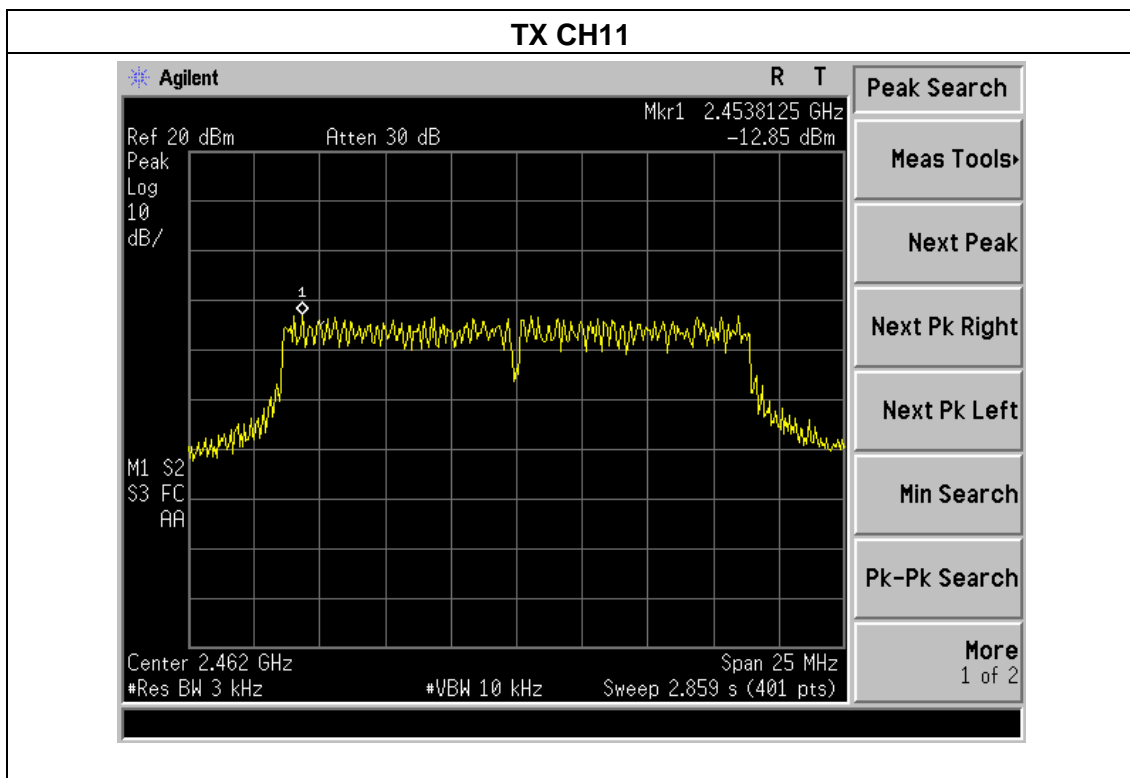
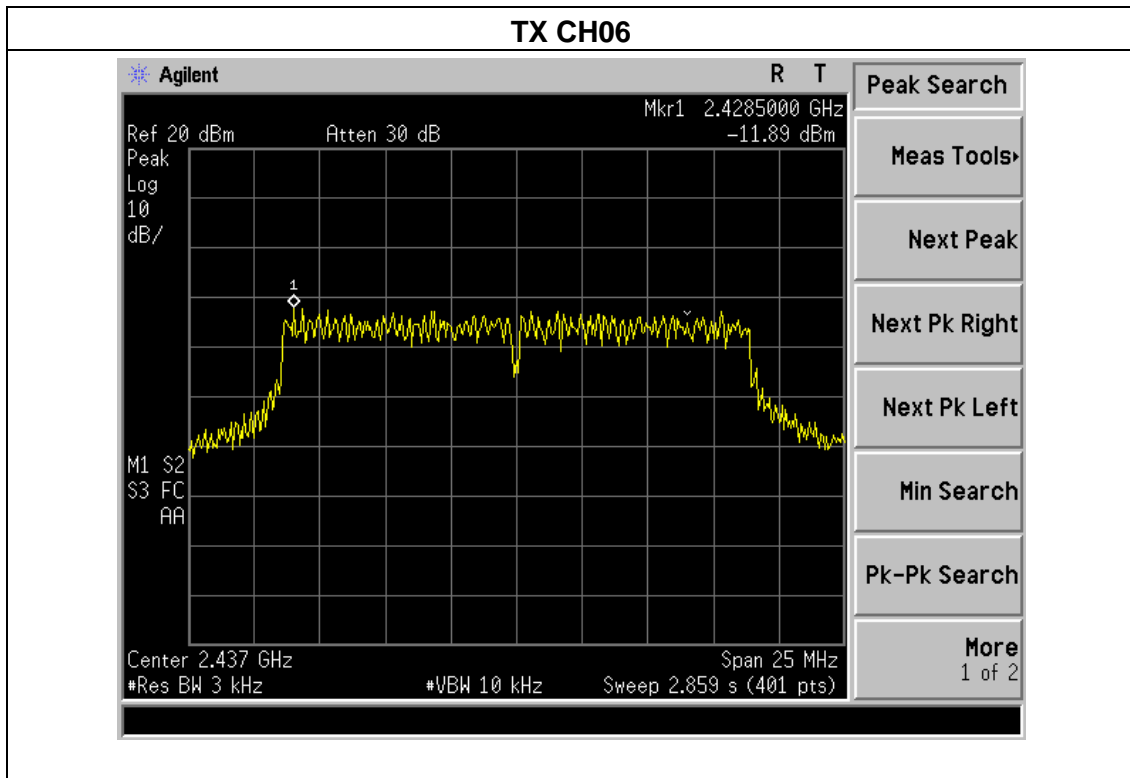

5. BANDWIDTH TEST

5.1 APPLIED PROCEDURES / LIMIT

FCC Part15 (15.247) , Subpart C				
Section	Test Item	Limit	Frequency Range (MHz)	Result
15.247(a)(2)	Bandwidth	$\geq 500\text{KHz}$ (6dB bandwidth)	2400-2483.5	PASS

5.1.1 TEST PROCEDURE

1. Set RBW = 100 kHz.
2. Set the video bandwidth (VBW) $\geq 3 \times$ RBW.
3. Detector = Peak.
4. Trace mode = max hold.
5. Sweep = auto couple.
6. Allow the trace to stabilize.
7. Measure the maximum width of the emission that is constrained by the frequencies associated with the two outermost amplitude points (upper and lower frequencies) that are attenuated by 6 dB relative to the maximum level measured in the fundamental emission.

5.1.2 DEVIATION FROM STANDARD

No deviation.

5.1.3 TEST SETUP



5.1.4 EUT OPERATION CONDITIONS

The EUT tested system was configured as the statements of 2.4 Unless otherwise a special operating condition is specified in the follows during the testing.



5.1.5 TEST RESULTS

Temperature :	25°C	Relative Humidity :	60%
Pressure :	1012 hPa	Test Voltage :	AC 120V/60Hz
Test Mode :	TX b Mode		

Frequency (MHz)	6dB bandwidth (MHz)	Limit (kHz)	Result
2412	8.152	500	Pass
2437	8.585	500	Pass
2462	8.123	500	Pass

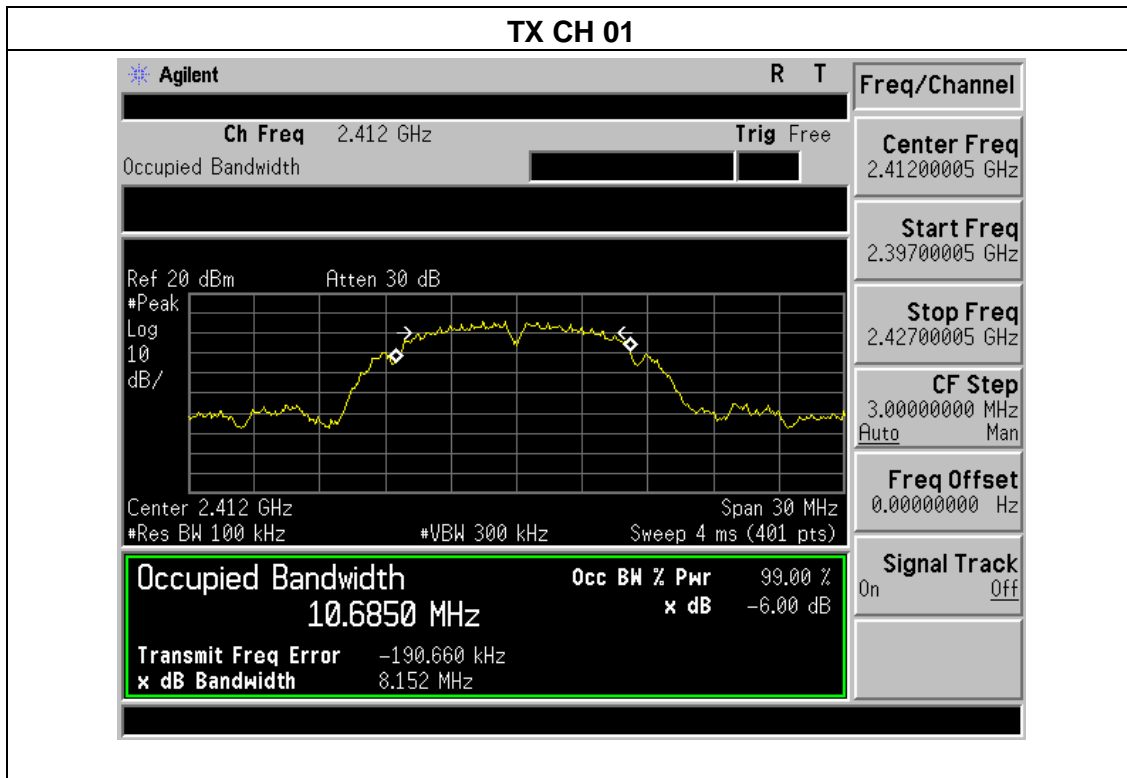

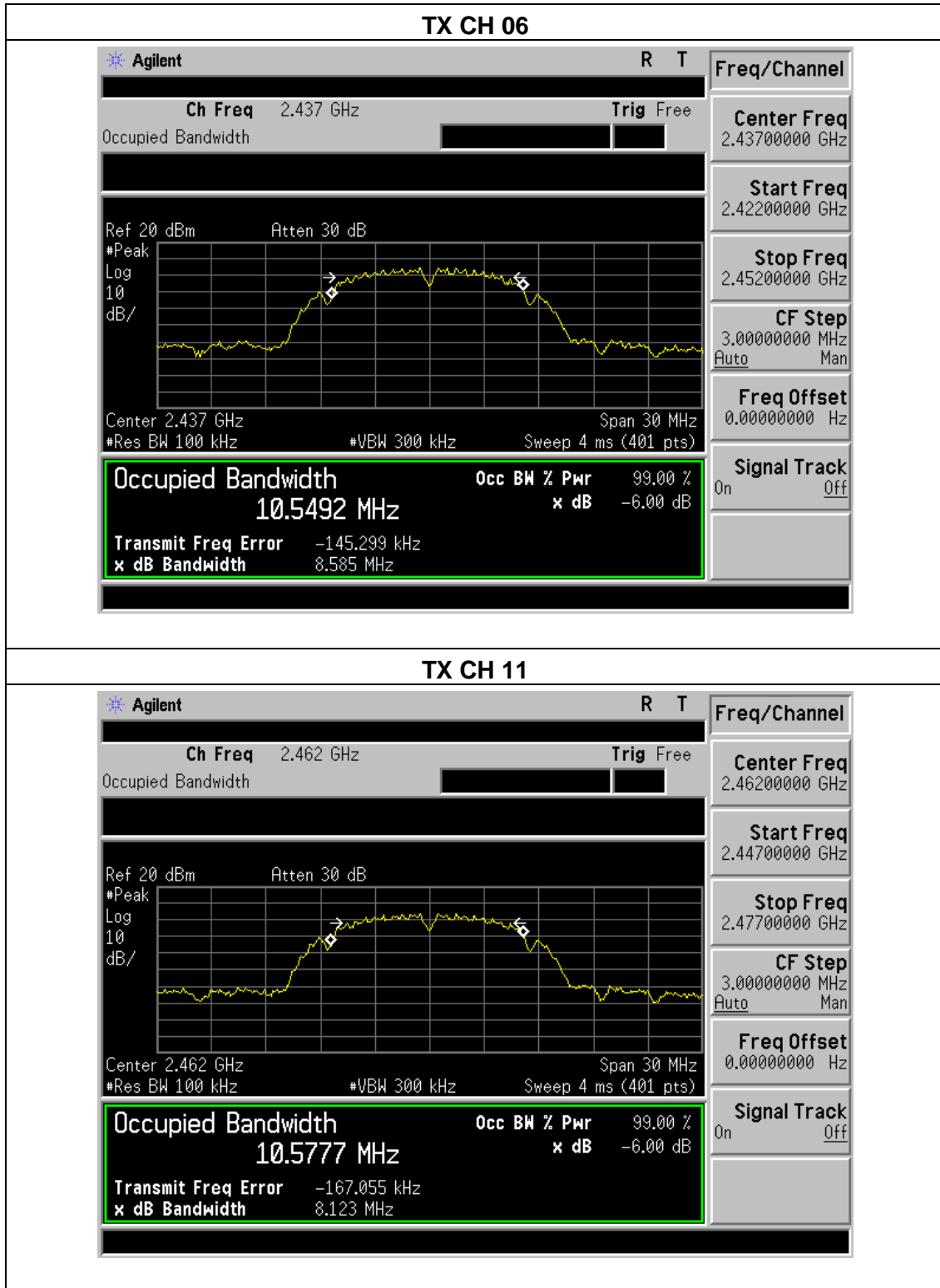



Temperature :	25°C	Relative Humidity :	60%
Pressure :	1012 hPa	Test Voltage :	AC 120V/60Hz
Test Mode :	TX g Mode		

Frequency (MHz)	6dB bandwidth (MHz)	Limit (kHz)	Result
2412	16.368	500	Pass
2437	16.361	500	Pass
2462	16.356	500	Pass

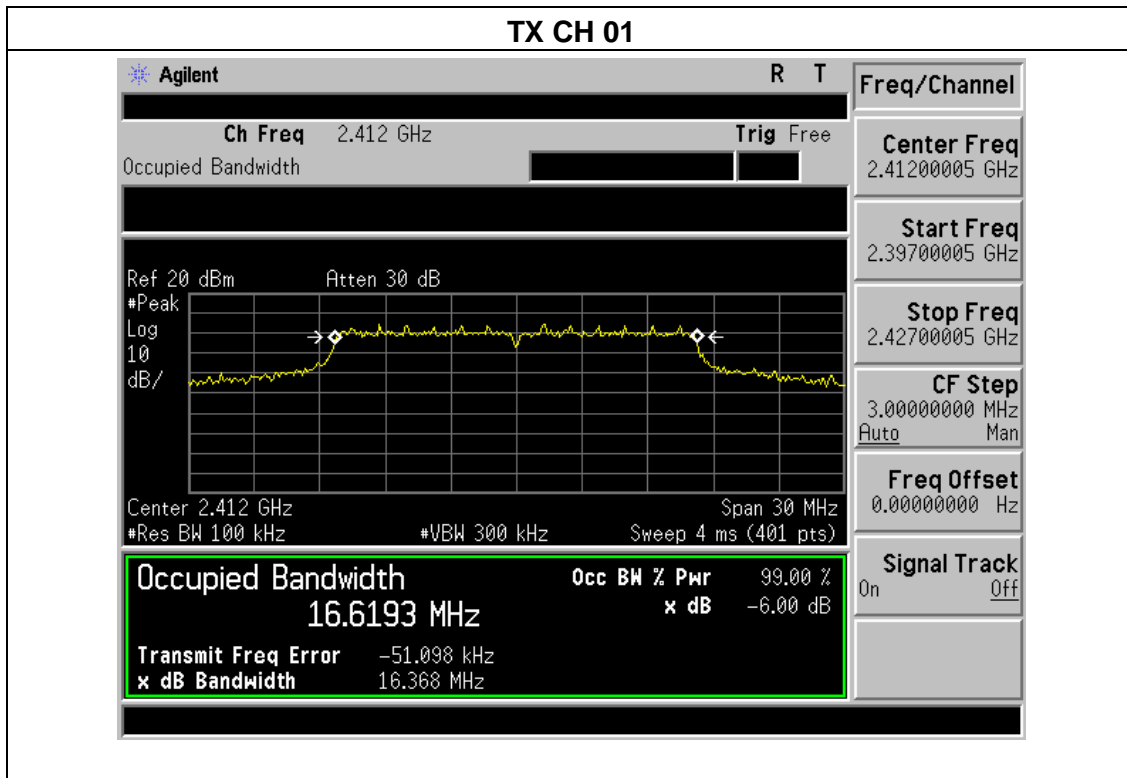

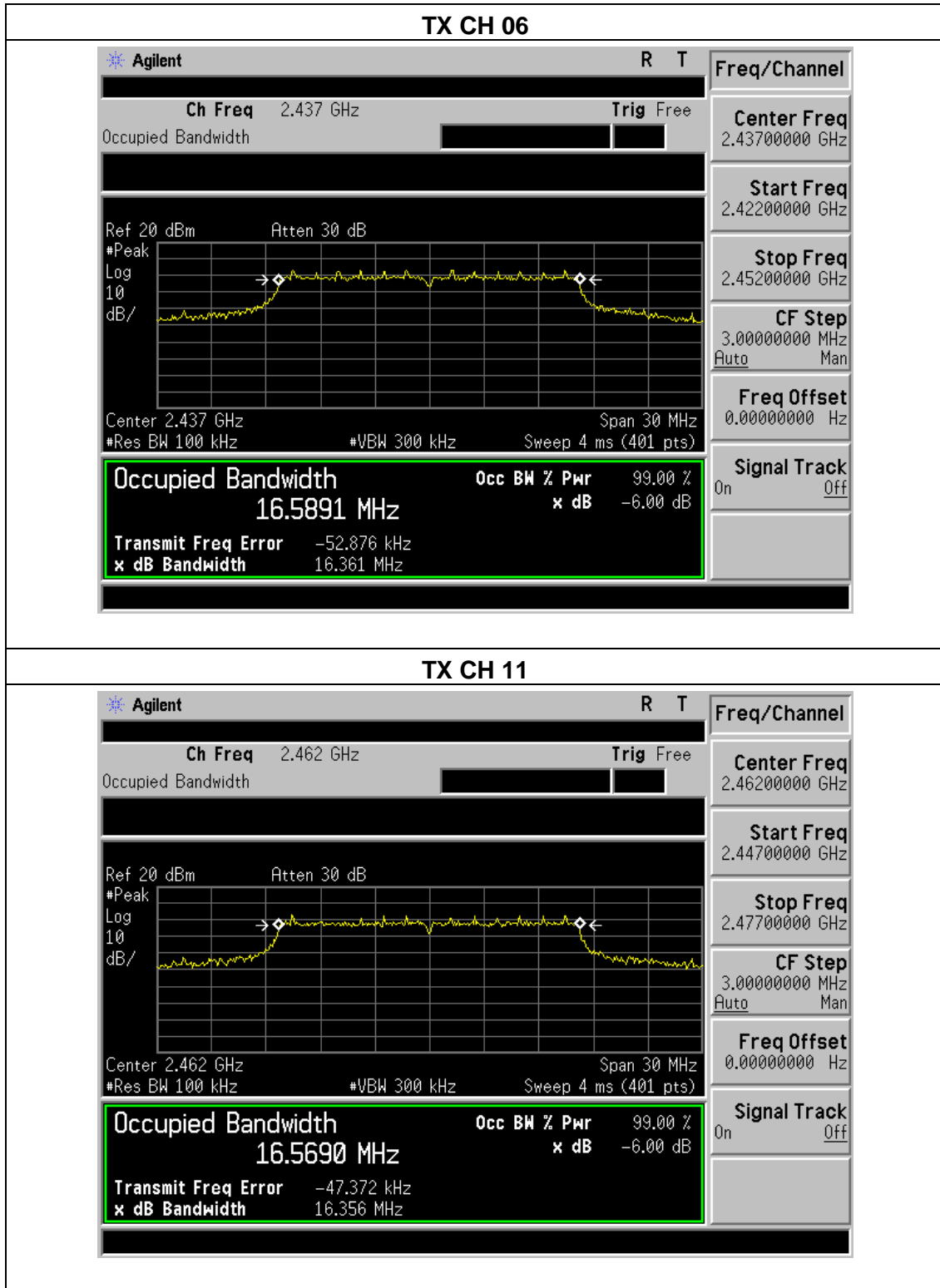



Temperature :	25°C	Relative Humidity :	60%
Pressure :	1012 hPa	Test Voltage :	AC 120V/60Hz
Test Mode :	TX n Mode(20M)		

Frequency (MHz)	6dB bandwidth (MHz)	Limit (kHz)	Result
2412	17.602	500	Pass
2437	17.605	500	Pass
2462	17.570	500	Pass

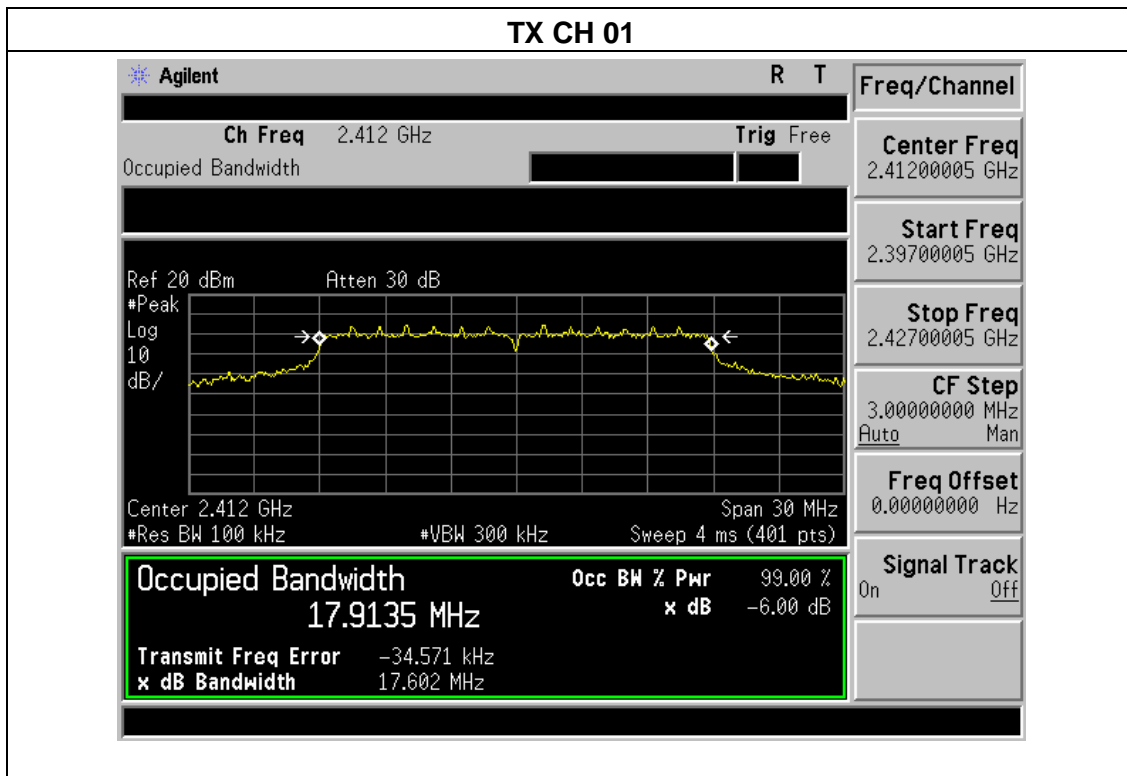

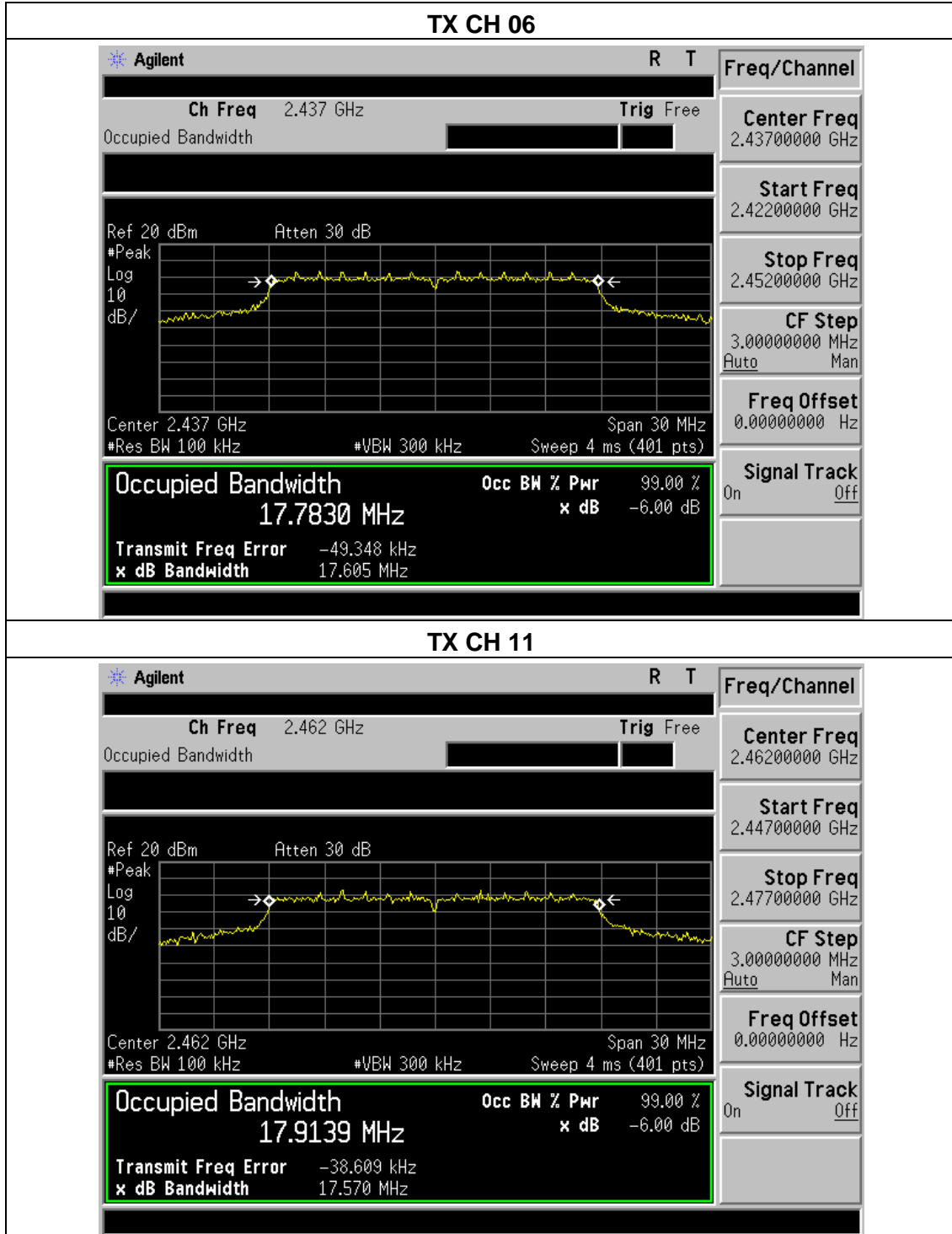



6. PEAK OUTPUT POWER TEST

6.1 APPLIED PROCEDURES/LIMIT

FCC Part15 (15.247) , Subpart C				
Section	Test Item	Limit	Frequency Range (MHz)	Result
15.247(b)(3)	Peak Output Power	1 watt or 30dBm	2400-2483.5	PASS

6.1.1 TEST PROCEDURE

- a. The EUT was directly connected to the Power meter

6.1.2 DEVIATION FROM STANDARD

No deviation.

6.1.3 TEST SETUP



6.1.4 EUT OPERATION CONDITIONS

The EUT tested system was configured as the statements of 2.4 Unless otherwise a special operating condition is specified in the follows during the testing.

**6.1.5 TEST RESULTS**

Temperature :	25°C	Relative Humidity :	60%
Pressure :	1012 hPa	Test Voltage :	AC 120V/60Hz

	Frequency	Maximum Conducted Output Power(PK)	LIMIT
	(MHz)	(dBm)	dBm
802.11b	2412	14.48	30
	2437	14.52	30
	2462	14.46	30
802.11g	2412	13.59	30
	2437	13.41	30
	2462	13.35	30
802.11n20	2412	13.42	30
	2437	13.34	30
	2462	13.17	30

7. 100 KHZ BANDWIDTH OF FREQUENCY BAND EDGE

7.1 APPLICABLE STANDARD

In any 100 kHz bandwidth outside the frequency band in which the spread spectrum intentional radiator is operating, the radio frequency power that is produced by the intentional radiator shall be at least 20 dB below that in the 100 kHz bandwidth within the band that contains the highest level of the desired power, based on either an RF conducted or a radiated measurement.

7.2 TEST PROCEDURE

- a) Check the calibration of the measuring instrument using either an internal calibrator or a known signal from an external generator.
- b) Position the EUT without connection to measurement instrument. Turn on the EUT and connect its antenna terminal to measurement instrument via a low loss cable. Then set it to any one measured frequency within its operating range, and make sure the instrument is operated in its linear range.
- c) Set RBW to 100 kHz and VBW of spectrum analyzer to 100 kHz with a convenient frequency span including 100 kHz bandwidth from band edge.
- d) Emissions radiated outside of the specified frequency bands, except for harmonics, shall be attenuated by at least 50 dB below the level of the fundamental or to the general radiated emission limits in §15.209, whichever is the lesser attenuation.
- e) Repeat above procedures until all measured frequencies were complete.

7.3 DEVIATION FROM STANDARD

No deviation.

7.4 TEST SETUP



7.5 EUT OPERATION CONDITIONS

The EUT tested system was configured as the statements of 2.4 Unless otherwise a special operating condition is specified in the follows during the testing.

7.1 TEST RESULTS



802.11b: Band Edge, Left Side

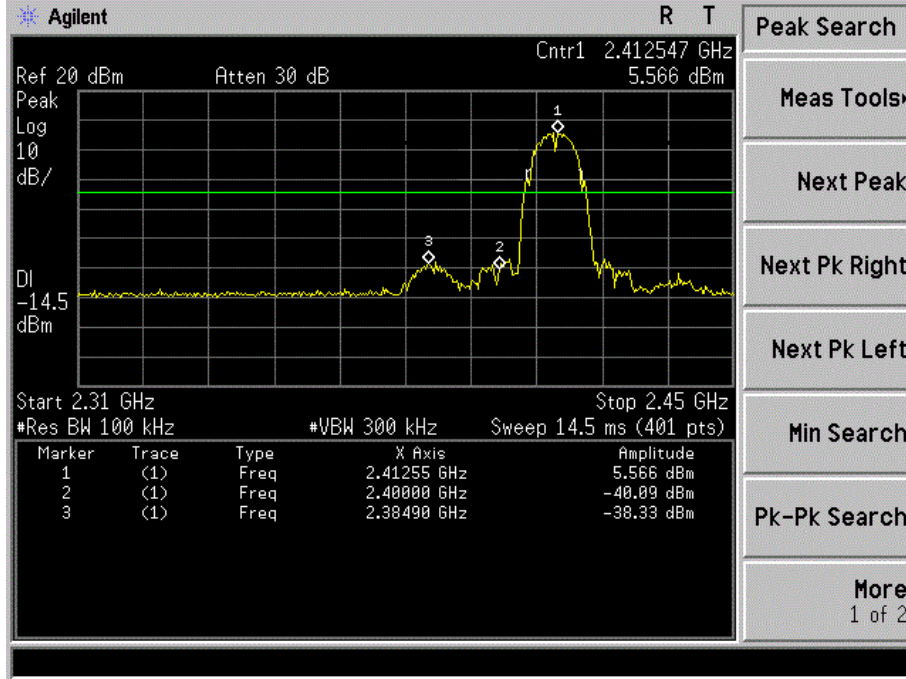

802.11b: Band Edge, Right Side

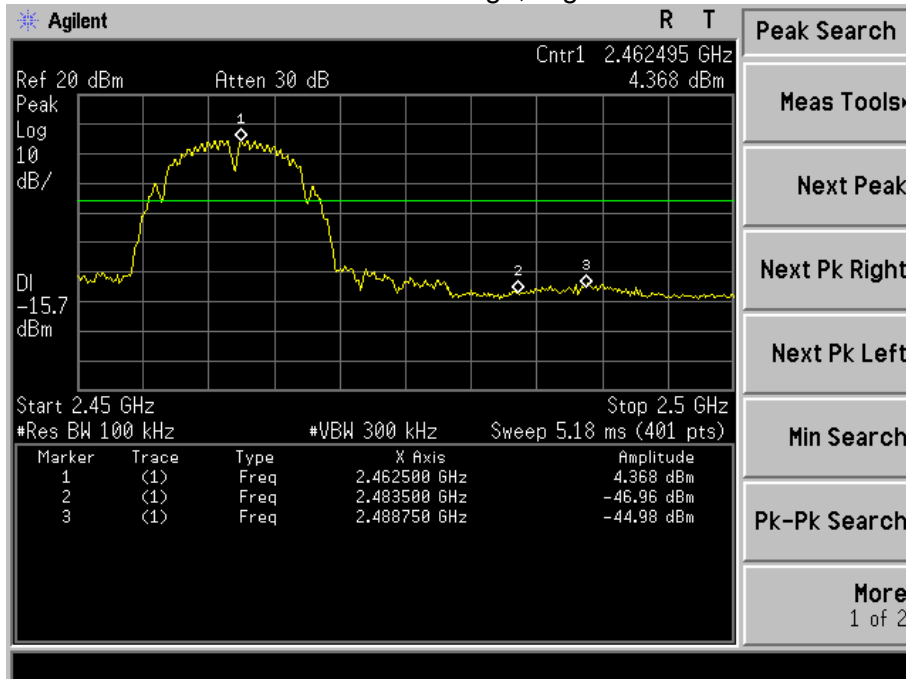



802.11g: Band Edge, Left Side

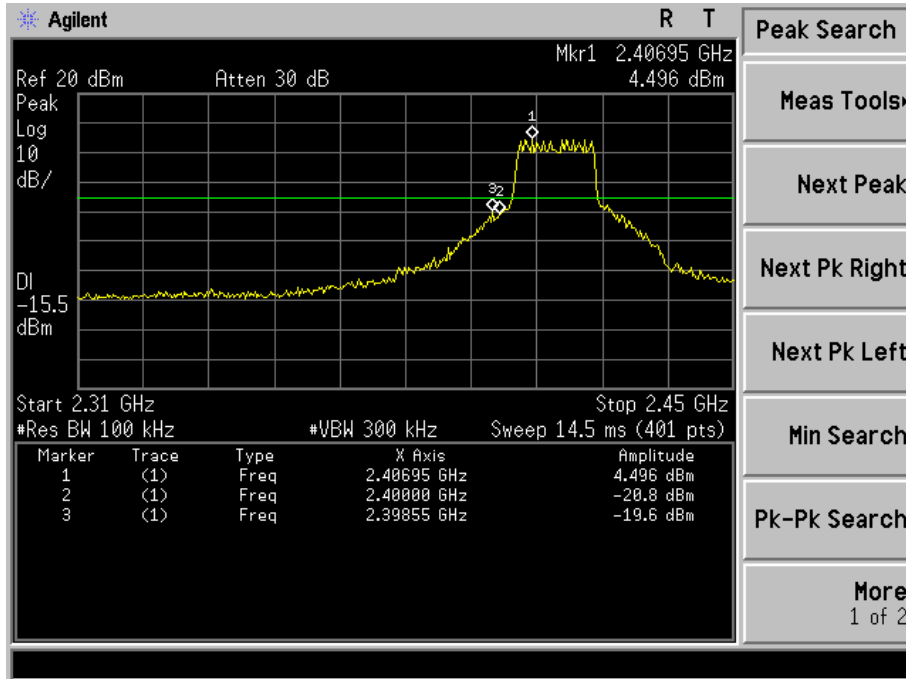

802.11g: Band Edge, Right Side

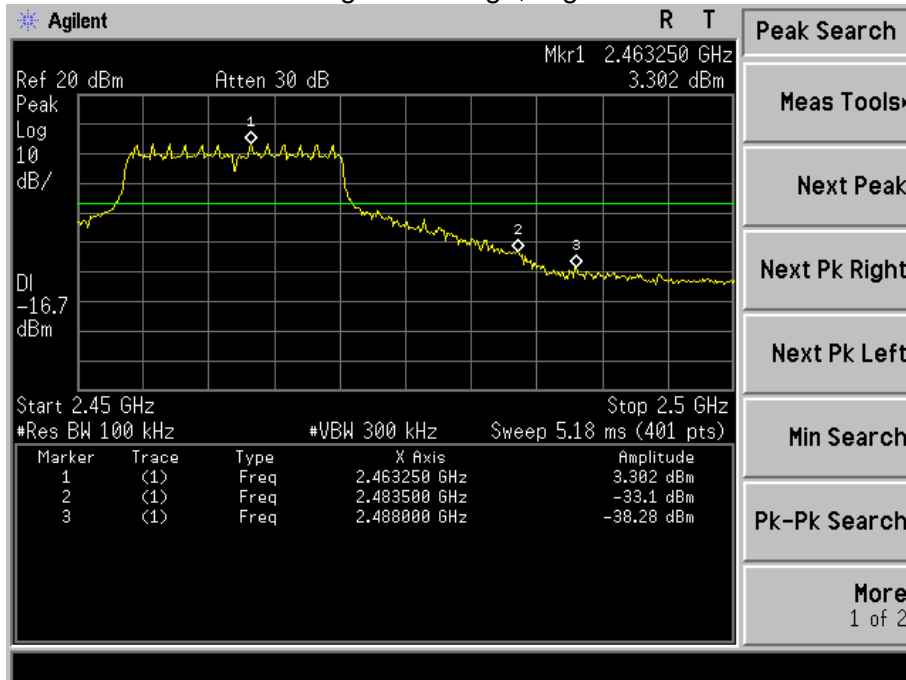



802.11n-HT20: Band Edge, Left Side

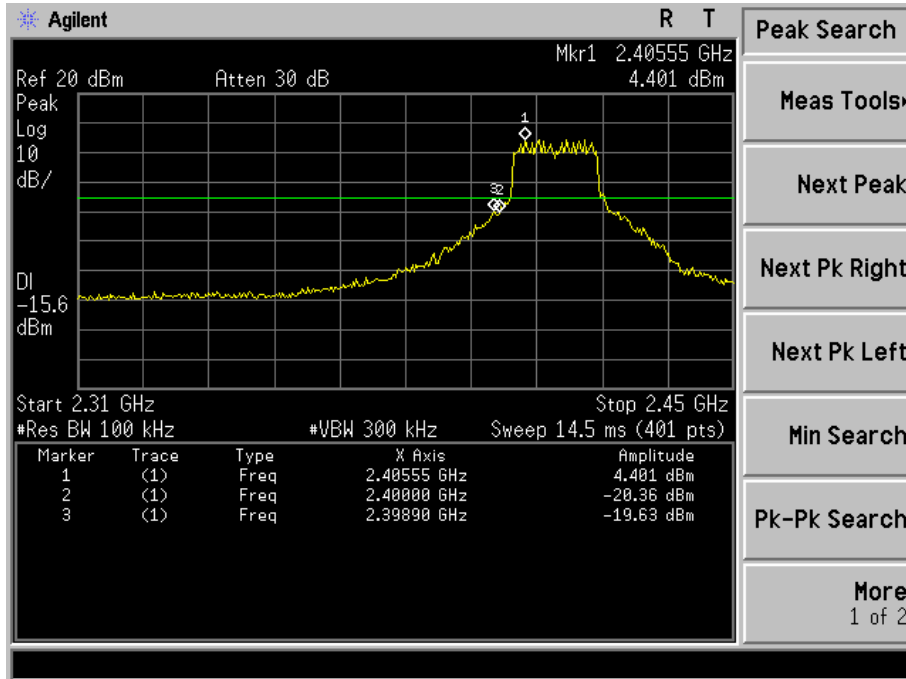

802.11n-HT20: Band Edge, Right Side

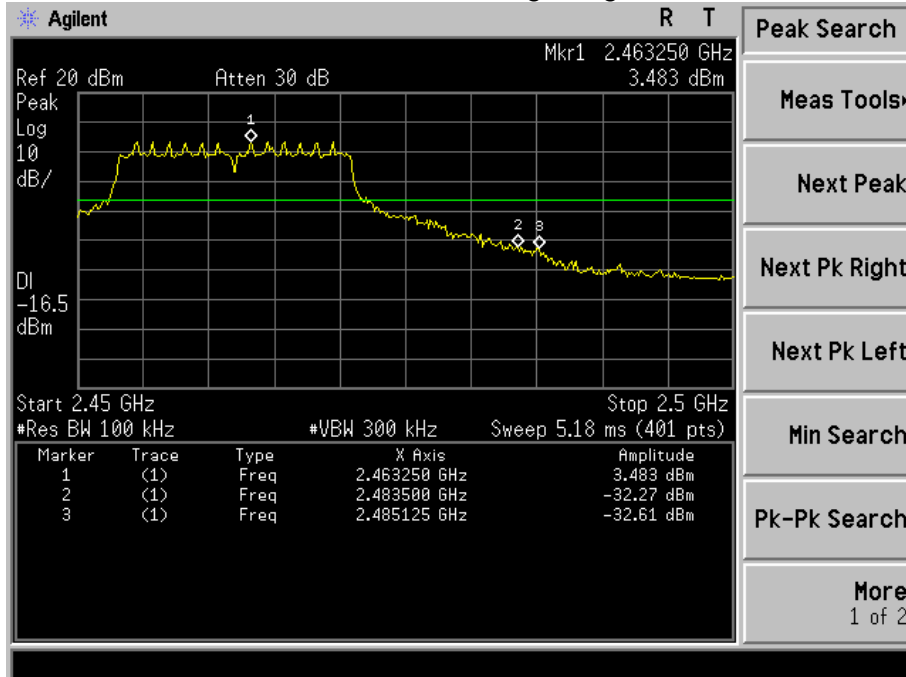



CONDUCTED EMISSION MEASUREMENT

802.11b

Low Channel 2412MHz

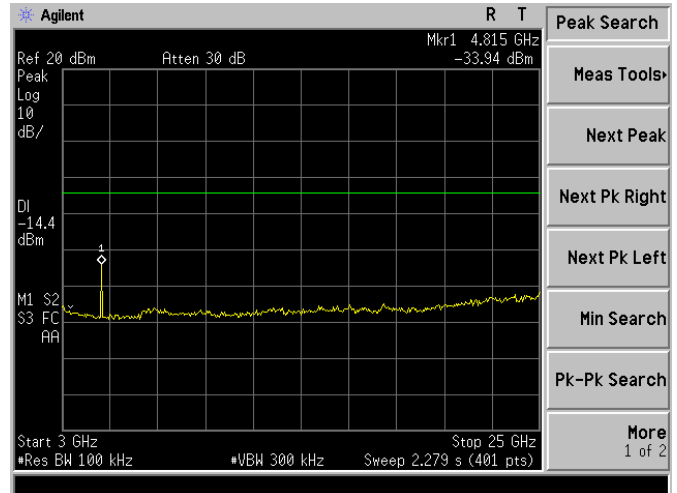
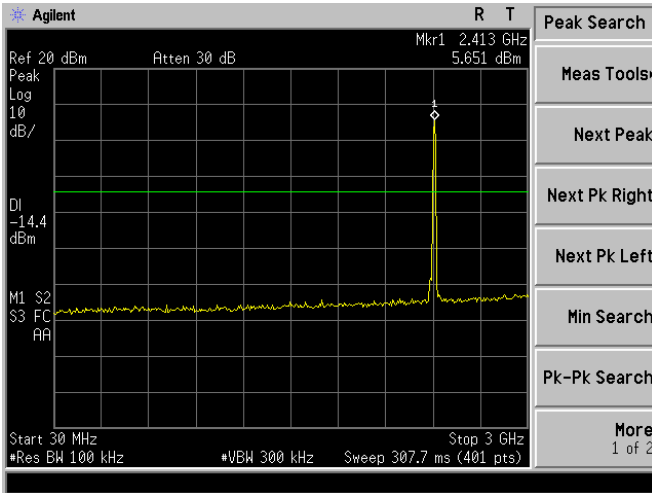

Middle Channel 2437MHz

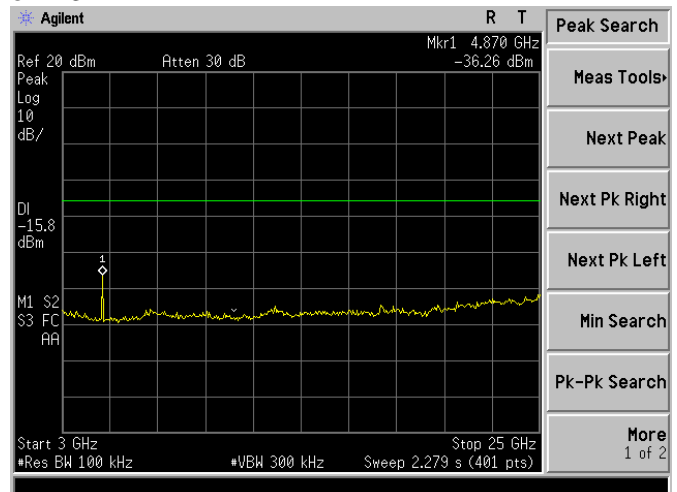
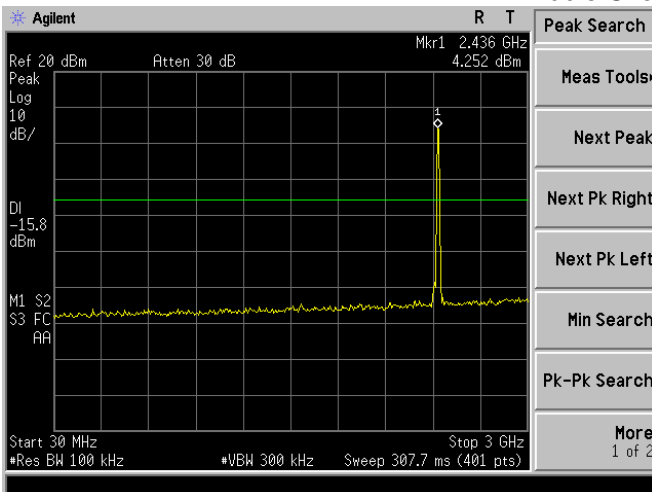

High Channel 2462MHz

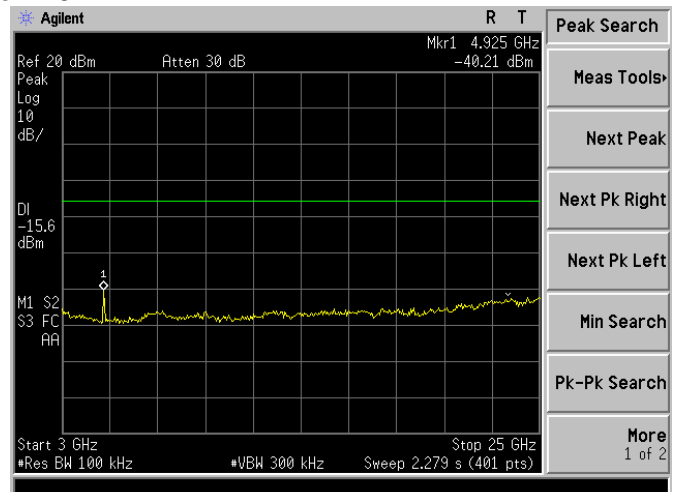
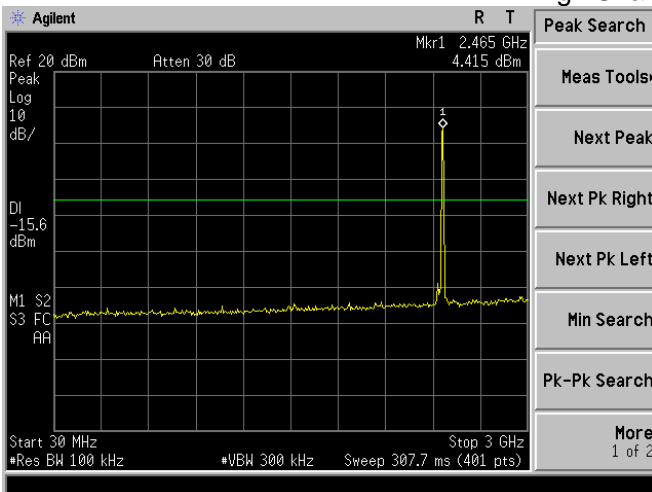



802.11g

Low Channel 2412MHz

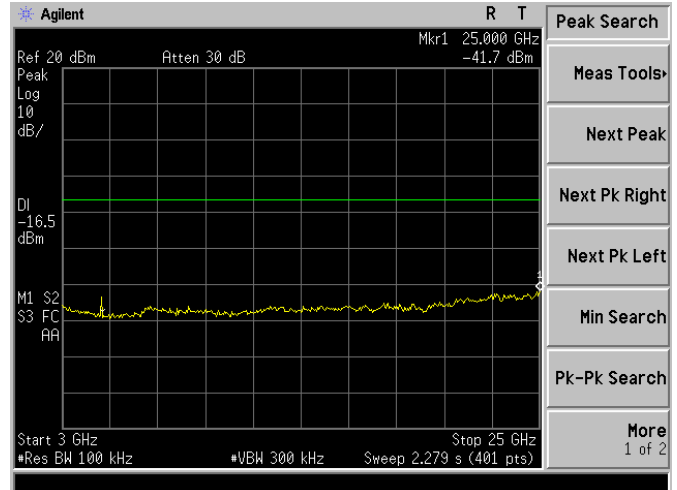
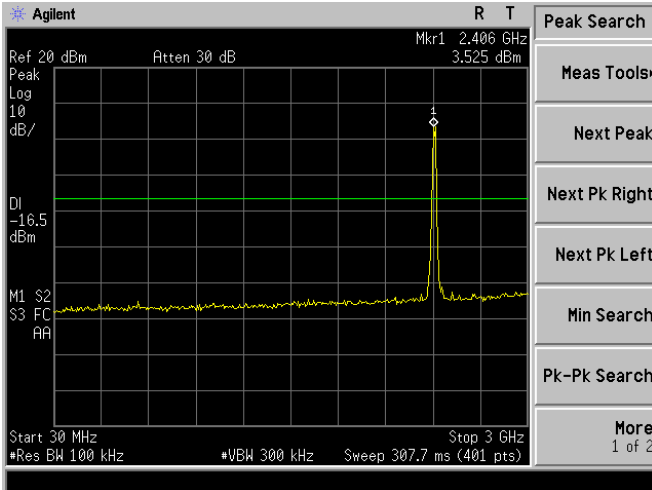

Middle Channel 2437MHz

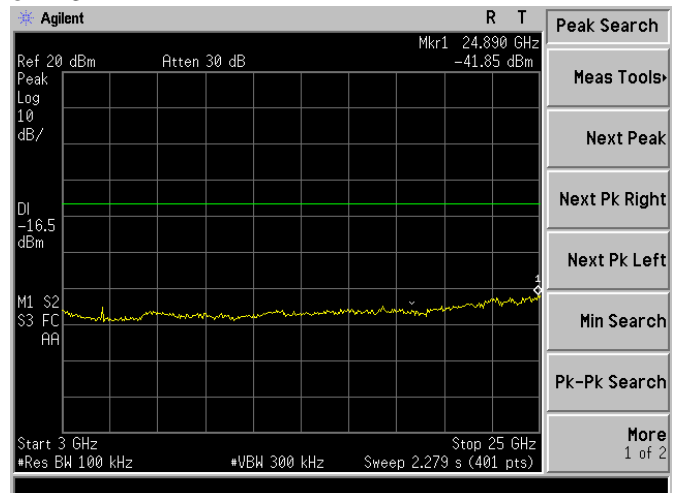
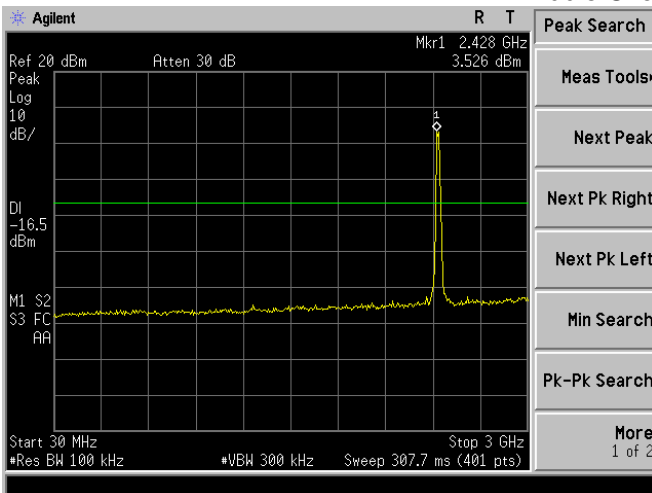

High Channel 2462MHz

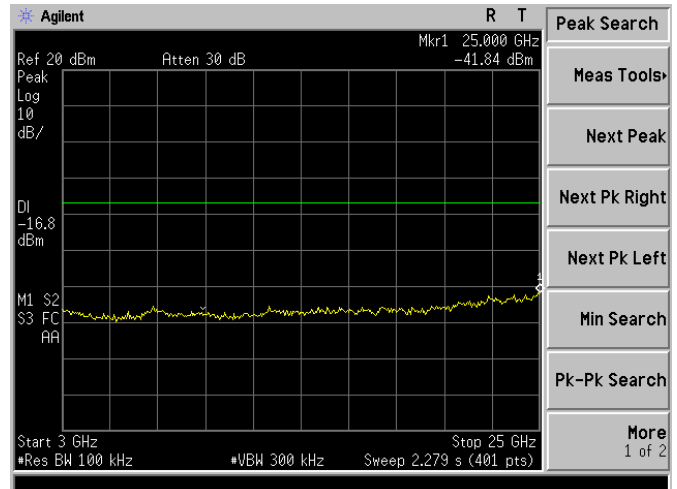
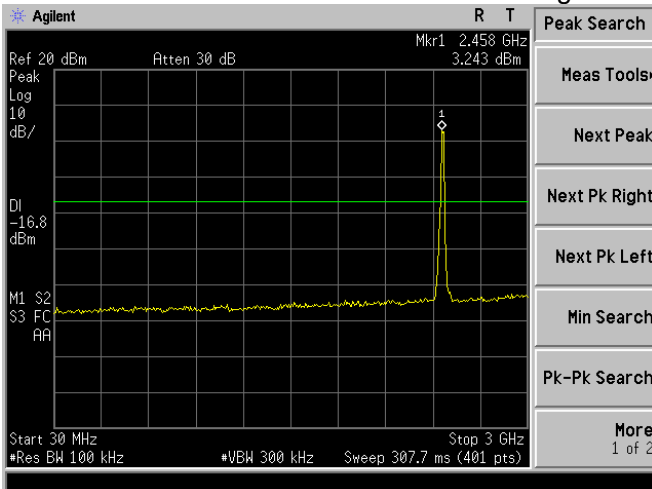



802.11n20

Low Channel 2412MHz

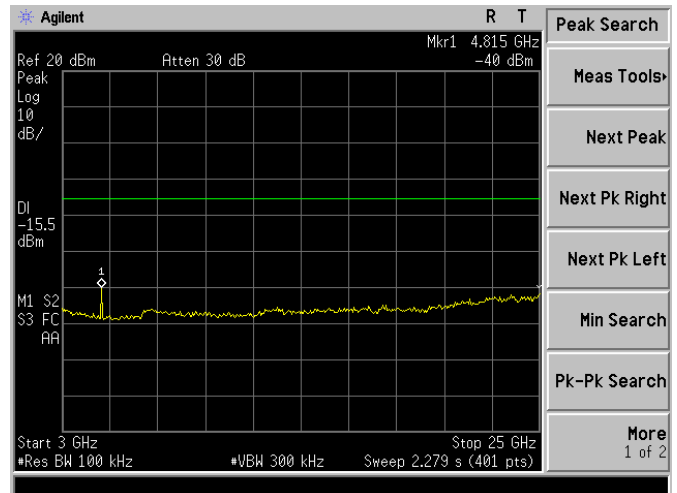
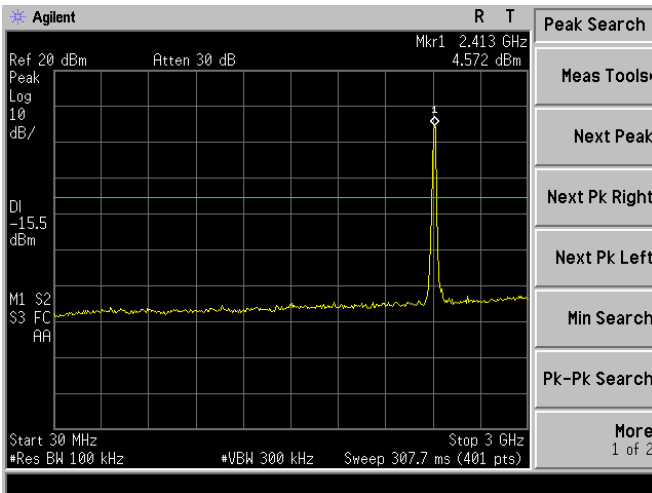

Middle Channel 2437MHz

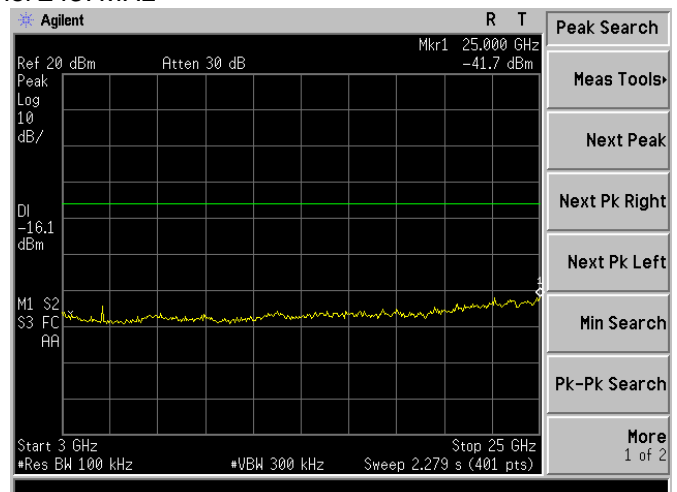
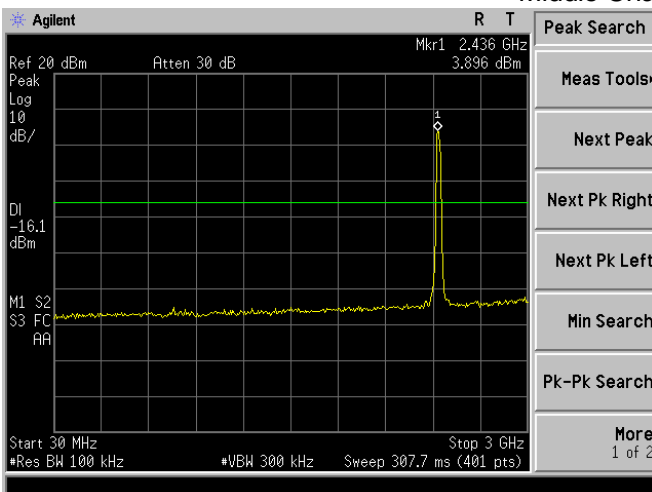

High Channel 2462MHz

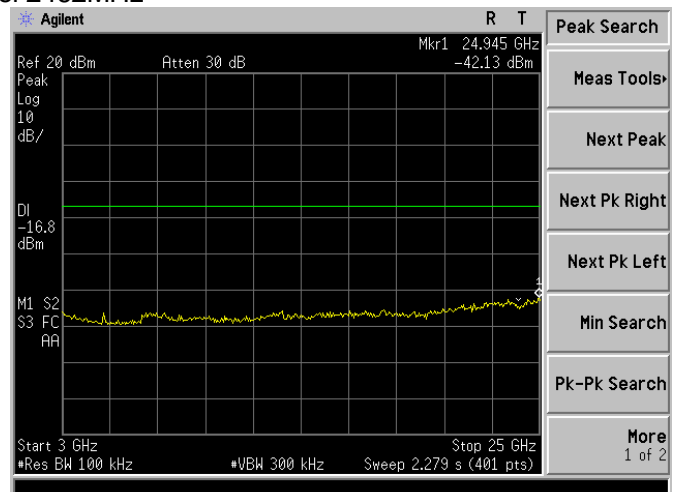
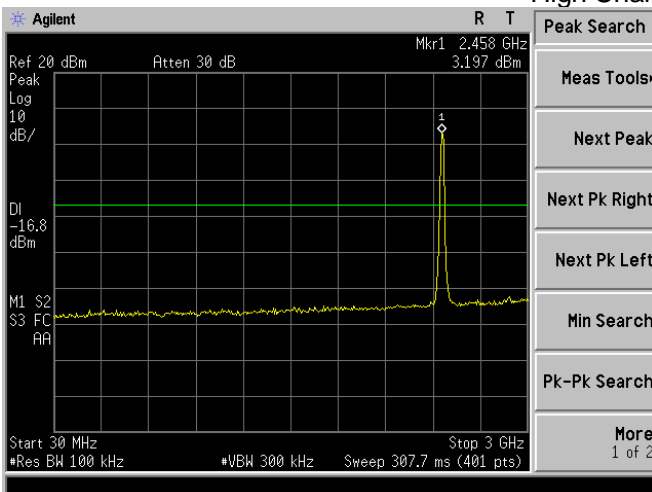



8. DUTY CYCLE OF TEST SIGNAL

8.1 STANDARD REQUIREMENT

Pre-analysis Check: While conducting average power measurement, duty cycle of each mode shall be checked to ensure its duty cycle in order to compensate for the loss due to insufficient ratio of duty cycle.

All duty cycle is pre-scanned, and result as obtained below shows only the most representative ones where duty cycle is conducted as the given transmission with given virtual operation that expresses the percentage.

8.2 FORMULA:

$$\text{Duty Cycle} = \text{Ton} / (\text{Ton} + \text{Toff})$$

Measurement Procedure:

1. Set span = Zero
2. RBW = 8MHz
3. VBW = 8MHz,
4. Detector = Peak

Duty Cycle:

	Duty Cycle	Duty Fator (dB)
802.11b	1	0
802.11g	1	0
802.11n(HT20)	1	0

802.11b

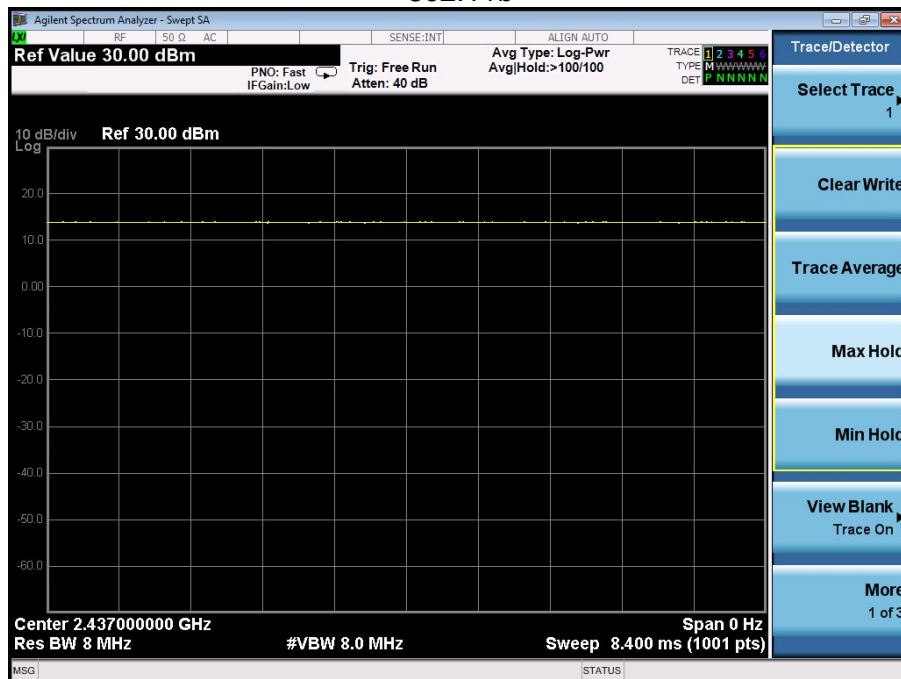



802.11g

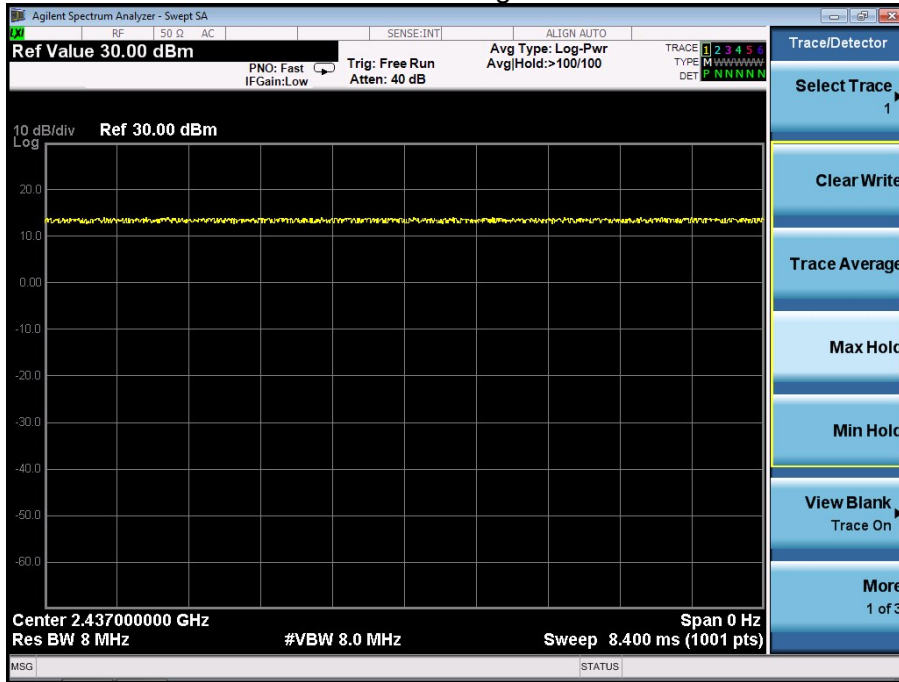

802.11n(HT20)

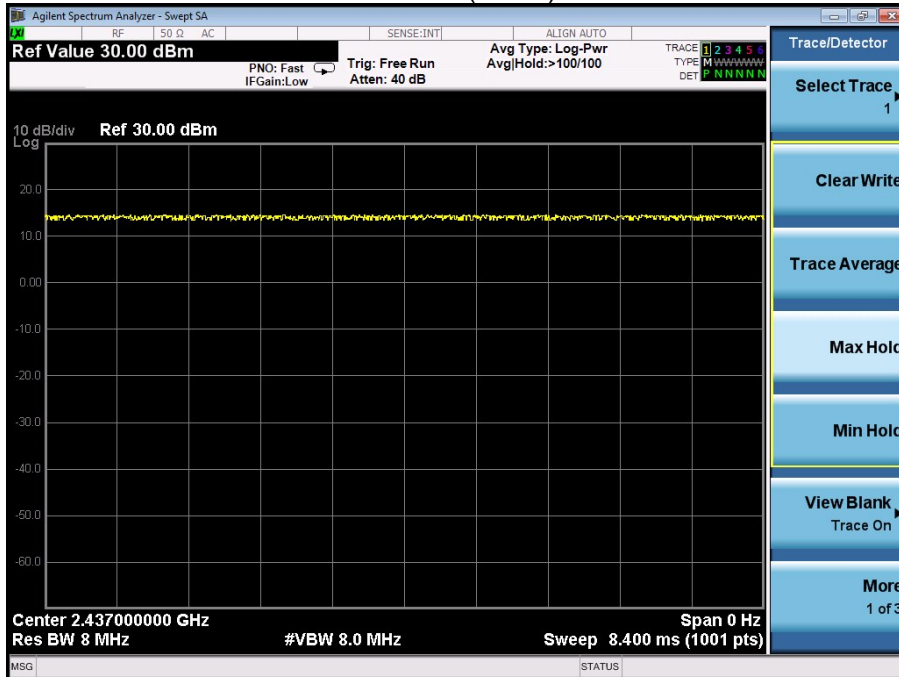



9. ANTENNA REQUIREMENT

9.1 STANDARD REQUIREMENT

15.203 requirement: For intentional device, according to 15.203: an intentional radiator shall be designed to ensure that no antenna other than that furnished by the responsible party shall be used with the device.

9.2 EUT ANTENNA

The EUT antenna is PCB Antenna, It comply with the standard requirement.

10. EUT TEST PHOTO

Conducted Measurement Photos



Radiated Measurement Photos

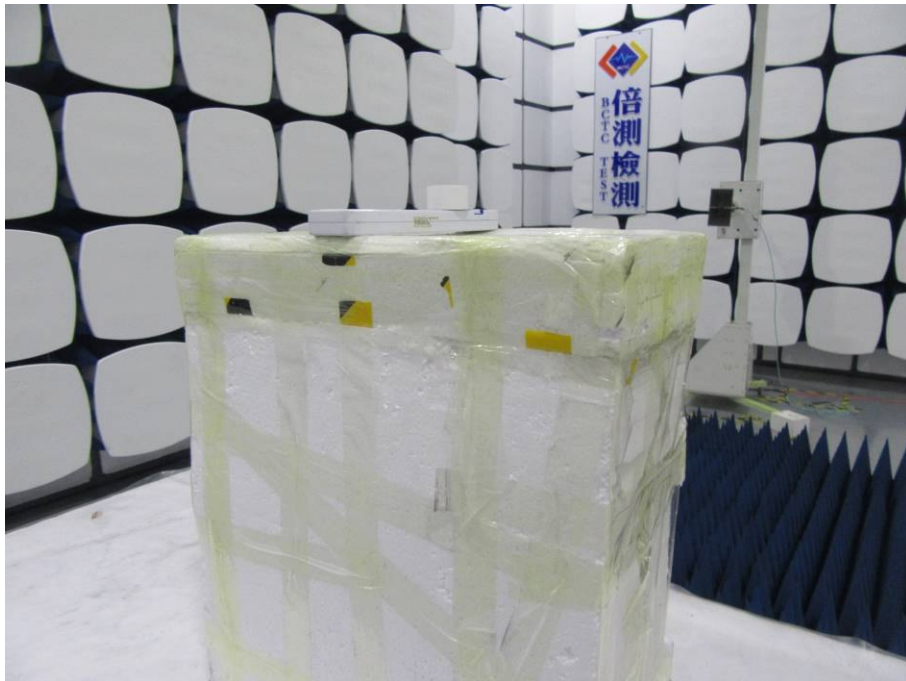

11. EUT PHOTO

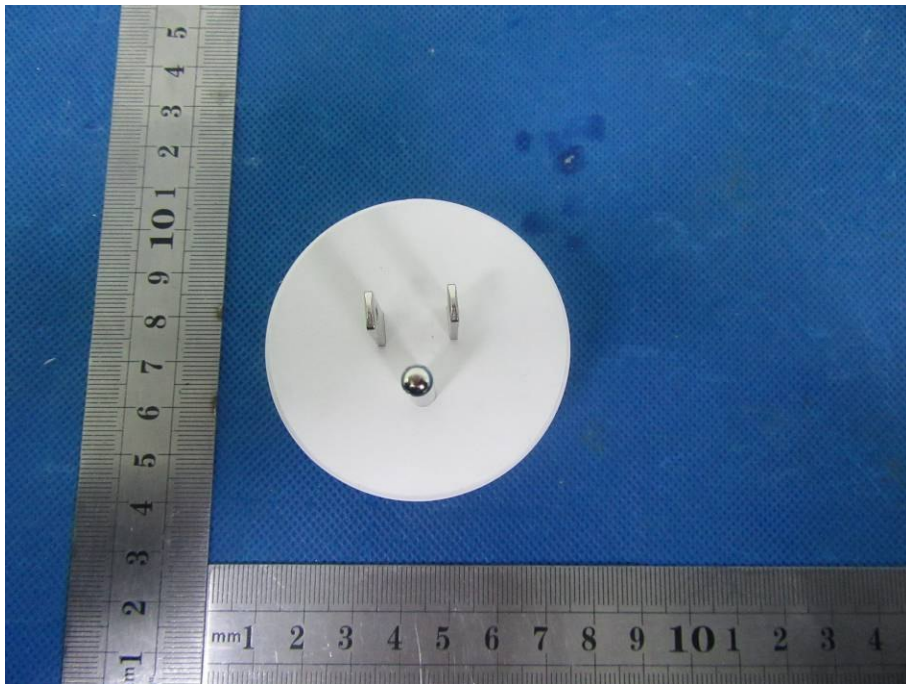

***** END OF REPORT *****