

TEST REPORT

Report No.: BCTC2011021764-2E

Applicant: Shenzhen Hysiry Technology Co., Ltd.

Product Name: Smart Plug-in Dimmer

Model/Type Ref.: X19

Tested Date: 2020-11-24 to 2020-12-23

Issued Date: 2020-12-23

Shenzhen BCTC Testing Co., Ltd.



FCC ID: 2AKBP-X19

Product Name: Smart Plug-in Dimmer
Trademark: N/A
Model/Type Ref.: X19
X19A, X19B, X19C, X20, X20A, X20B, X20C
Prepared For: Shenzhen Hysiry Technology Co., Ltd.
Address: 2403D, 24th floor, coast huanqing building, no.24 futian road, xu town community, futian street, futian district, Shenzhen, China
Manufacturer: Shenzhen Hysiry Technology Co., Ltd.
Address: 2403D, 24th floor, coast huanqing building, no.24 futian road, xu town community, futian street, futian district, Shenzhen, China
Prepared By: Shenzhen BCTC Testing Co., Ltd.
Address: 1-2/F., East of B Building, Pengzhou Industrial Park, Fuyuan 1st Road, Qiaotou, Fuyong Street, Bao'an District, Shenzhen, Guangdong, China
Sample Received Date: 2020-11-24
Sample tested Date: 2020-11-24 to 2020-12-23
Issue Date: 2020-12-23
Report No.: BCTC2011021764-2E
Test Standards: FCC Part15.247
ANSI C63.10-2013
Test Results: PASS
Remark: This is WIFI-2.4GHz band radio test report.

Tested by:

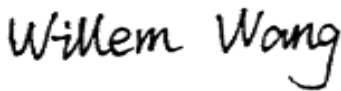
Willem Wang/Project Handler

Approved by:

Zero Zhou/Reviewer

The test report is effective only with both signature and specialized stamp. This result(s) shown in this report refer only to the sample(s) tested. Without written approval of Shenzhen BCTC Testing Co., Ltd, this report can't be reproduced except in full. The tested sample(s) and the sample information are provided by the client.

TABLE OF CONTENT

Test Report Declaration	Page
1. VERSION	5
2. TEST SUMMARY	6
3. MEASUREMENT UNCERTAINTY	7
4. PRODUCT INFORMATION AND TEST SETUP	8
4.1 Product Information	8
4.2 Test Setup Configuration	8
4.3 Support Equipment	9
4.4 Channel List	9
4.5 Test Mode	10
4.6 table of parameters of text software setting	10
5. TEST FACILITY AND TEST INSTRUMENT USED	11
5.1 Test Facility	11
5.2 Test Instrument Used	11
6. CONDUCTED EMISSIONS	13
6.1 Block Diagram Of Test Setup	13
6.2 Limit	13
6.3 Test procedure	13
6.4 EUT operating Conditions	13
6.5 Test Result	14
7. RADIATED EMISSIONS	20
7.1 Block Diagram Of Test Setup	20
7.2 Limit	21
7.3 Test procedure	22
7.4 EUT operating Conditions	23
7.5 Test Result	24
8. RADIATED BAND EMISSION MEASUREMENT AND RESTRICTED BANDS OF OPERATION	35
8.1 Block Diagram Of Test Setup	35
8.2 Limit	35
8.3 Test procedure	36
8.4 EUT operating Conditions	36
8.5 Test Result	37
9. POWER SPECTRAL DENSITY TEST	39
9.1 Block Diagram Of Test Setup	39
9.2 Limit	39
9.3 Test procedure	39
9.4 EUT operating Conditions	39
9.5 Test Result	40
10. BANDWIDTH TEST	48
10.1 Block Diagram Of Test Setup	48
10.2 Limit	48
10.3 Test procedure	48

10.4	EUT operating Conditions	48
10.5	Test Result	49
11.	PEAK OUTPUT POWER TEST	57
11.1	Block Diagram Of Test Setup	57
11.2	Limit	57
11.3	Test procedure	57
11.4	EUT operating Conditions	57
11.5	Test Result	58
12.	100 KHZ BANDWIDTH OF FREQUENCY BAND EDGE	59
12.1	Block Diagram Of Test Setup	59
12.2	Limit	59
12.3	Test procedure	59
12.4	EUT operating Conditions	59
12.5	Test Result	60
13.	DUTY CYCLE OF TEST SIGNAL	68
13.1	Standard requirement	68
13.2	Formula	68
13.3	Test procedure	68
13.4	Test Result	68
14.	ANTENNA REQUIREMENT	71
14.1	Limit	71
14.2	Test Result	71
15.	EUT PHOTOGRAPHS	72
16.	EUT TEST SETUP PHOTOGRAPHS	74

(Note: N/A means not applicable)

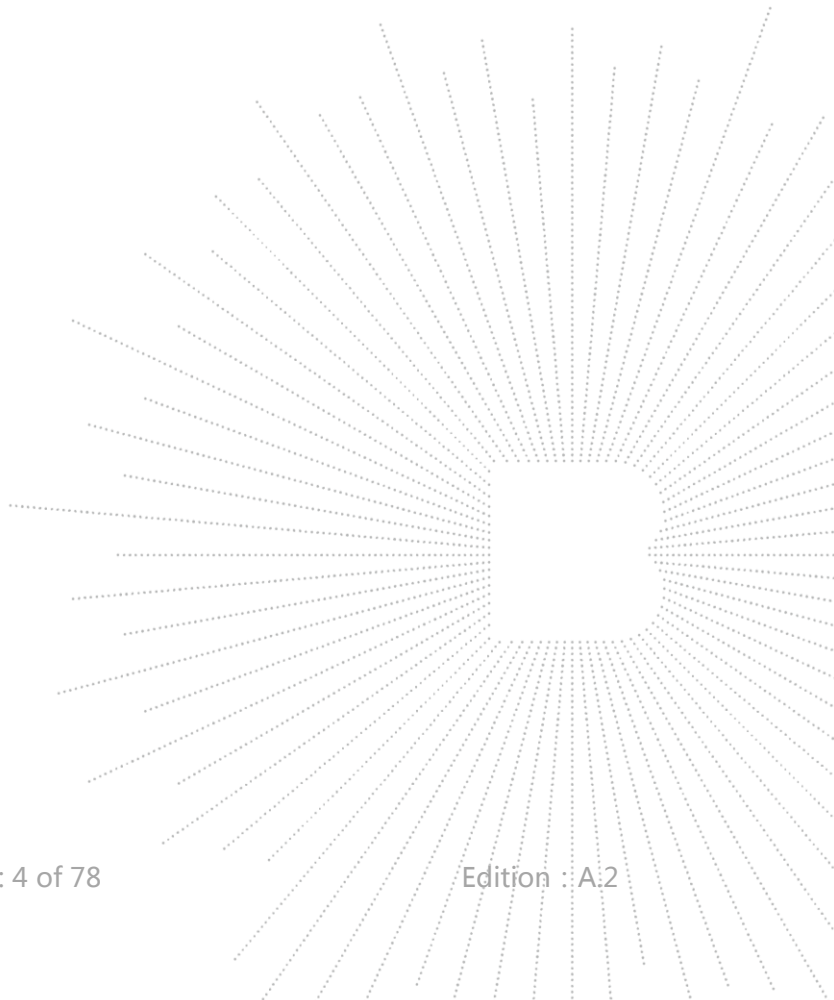

1. VERSION

Report No.	Issue Date	Description	Approved
BCTC2011021764-2E	2020-12-23	Original	Valid

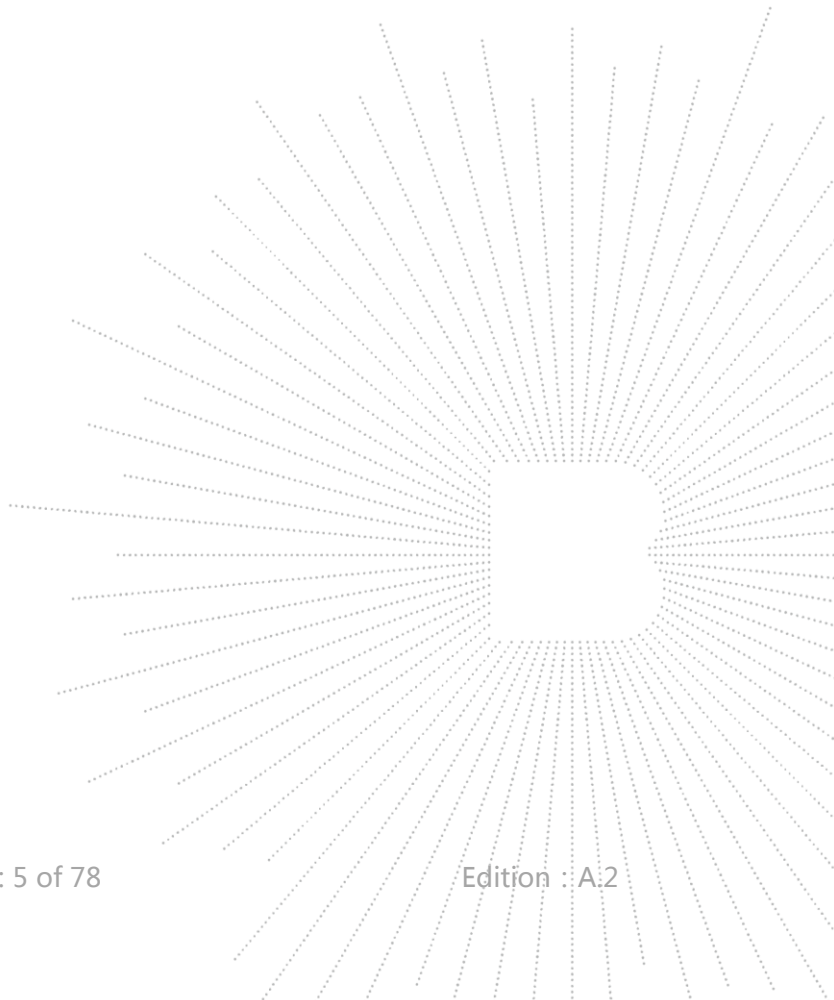

2. TEST SUMMARY

The Product has been tested according to the following specifications:

No.	Test Parameter	Clause No	Results
1	Conducted Emission	15.207	PASS
2	6dB Bandwidth	15.247 (a)(2)	PASS
3	Peak Output Power	15.247 (b)	PASS
4	Radiated Spurious Emission	15.247 (d)	PASS
5	Power Spectral Density	15.247 (e)	PASS
6	Restricted Band of Operation	15.205	PASS
7	Band Edge (Out of Band Emissions)	15.247 (d)	PASS
8	Antenna Requirement	15.203	PASS

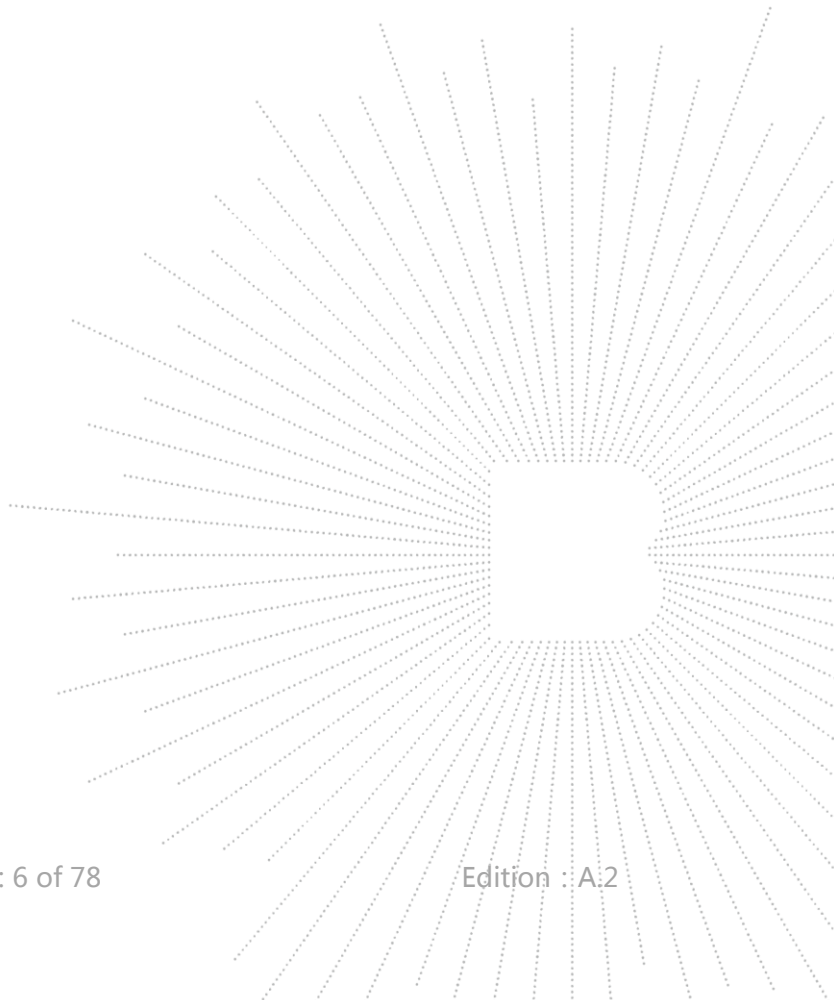

3. MEASUREMENT UNCERTAINTY

Where relevant, the following measurement uncertainty levels have been estimated for tests performed on the Product as specified in CISPR 16-4-2. This uncertainty represents an expanded uncertainty expressed at approximately the 95% confidence level using a coverage factor of $k=2$.

No.	Item	Uncertainty
1	3m chamber Radiated spurious emission(30MHz-1GHz)	U=4.3dB
2	3m chamber Radiated spurious emission(1GHz-18GHz)	U=4.5dB
3	3m chamber Radiated spurious emission(18GHz-40GHz)	U=3.34dB
4	Conducted Adjacent channel power	U=1.38dB
5	Conducted output power uncertainty Above 1G	U=1.576dB
6	Conducted output power uncertainty below 1G	U=1.28dB
7	humidity uncertainty	U=5.3%
8	Temperature uncertainty	U=0.59°C

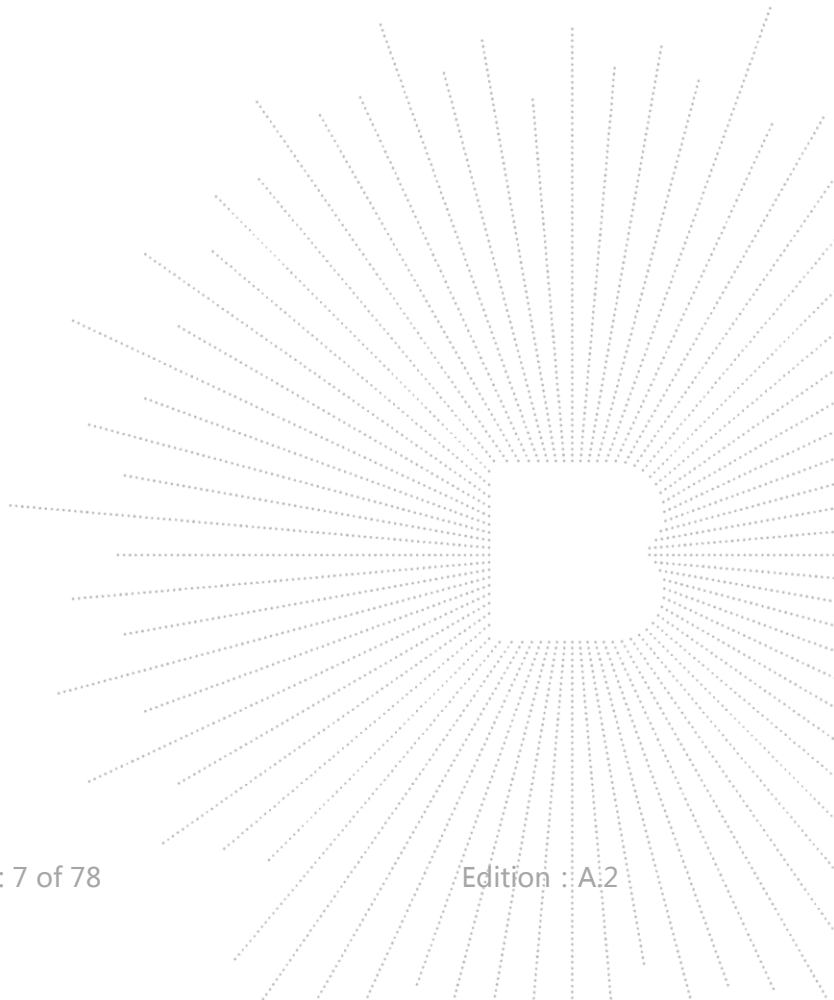

4. PRODUCT INFORMATION AND TEST SETUP

4.1 Product Information

Model/Type Ref.:	X19 X19A, X19B, X19C, X20, X20A, X20B, X20C
Model differences:	All the model are the same circuit and RF module, except model names and output AC cable length and port number.
Operation Frequency:	802.11b/g/n20MHz:2412~2462 MHz 802.11n40MHz:2422~2452 MHz
Bit Rate of Transmitter	802.11b:11/5.5/2/1 Mbps 802.11g:54/48/36/24/18/12/9/6Mbps 802.11n Up to 150Mbps
Type of Modulation:	WIFI: OFDM/DSSS
Number Of Channel	802.11b/g/n20MHz:11 CH 802.11n40MHz: 7 CH
Antenna installation:	Internal antenna
Antenna Gain:	1dBi
Ratings:	AC 120V 60Hz 400W

4.2 Test Setup Configuration

See test photographs attached in *EUT TEST SETUP PHOTOGRAPHS* for the actual connections between Product and support equipment.

Conducted Emission:

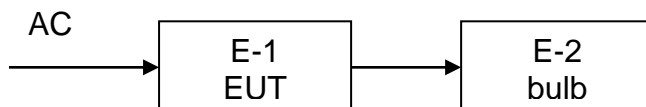

Radiated Spurious Emission:

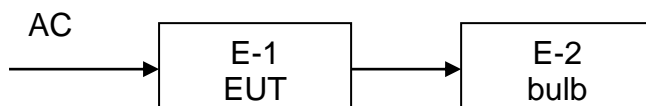

4.3 Support Equipment

No.	Device Type	Brand	Model	Series No.	Data Cable	Remark
E-1	Smart Plug-in Dimmer	N/A	X19	N/A	EUT	N/A
E-2	bulb	N/A	BCTC001	N/A	Auxiliary	N/A

Notes:

1. All the equipment/cables were placed in the worst-case configuration to maximize the emission during the test.
2. Grounding was established in accordance with the manufacturer's requirements and conditions for the intended use.

4.4 Channel List

Channel List for 802.11b/g/n(20)					
Channel	Frequency (MHz)	Channel	Frequency (MHz)	Channel	Frequency (MHz)
01	2412	02	2417	03	2422
04	2427	05	2432	06	2437
07	2442	08	2447	09	2452
10	2457	11	2462		

Channel List for 802.11n(40)					
Channel	Frequency (MHz)	Channel	Frequency (MHz)	Channel	Frequency (MHz)
03	2422	04	2427	05	2432
06	2437	07	2442	08	2447
09	2452				

4.5 Test Mode

To investigate the maximum EMI emission characteristics generates from EUT, the test system was pre-scanning tested base on the consideration of following EUT operation mode or test configuration mode which possible have effect on EMI emission level. Each of these EUT operation mode(s) or test configuration mode(s) mentioned above was evaluated respectively.

Pretest Mode	Description
Mode 1	802.11b CH1/ CH6/ CH11
Mode 2	802.11g CH1/ CH6/ CH11
Mode 3	802.11n20 CH1/ CH6/ CH11
Mode 4	802.11n40 CH3/ CH6/ CH9
Mode 5	Link Mode

Radiated Emission	
Final Test Mode	Description
Mode 5	Link Mode

For Radiated Emission	
Final Test Mode	Description
Mode 1	802.11b CH1/ CH6/ CH11
Mode 2	802.11g CH1/ CH6/ CH11
Mode 3	802.11n20 CH1/ CH6/ CH11
Mode 4	802.11n40 CH3/ CH6/ CH9

Note:

- (1) The measurements are performed at all Bit Rate of Transmitter, the worst data was reported.

4.6 table of parameters of text software setting

During testing channel & power controlling software provided by the customer was used to control the operating channel as well as the output power level. The RF output power selection is for the setting of RF output power expected by the customer and is going to be fixed on the firmware of the final end product power parameters

Test software Version	SecureCRT		
Frequency	2412 MHz	2437 MHz	2462 MHz
Parameters	DEF	DEF	DEF
Frequency	2422MHz	2437MHz	2452MHz
Parameters	DEF	DEF	DEF

5. TEST FACILITY AND TEST INSTRUMENT USED

5.1 Test Facility

All measurement facilities used to collect the measurement data are located at Shenzhen BCTC Testing Co., Ltd. Address: 1-2/F., East of B Building, Pengzhou Industrial Park, Fuyuan 1st Road, Qiaotou, Fuyong Street, Bao'an District, Shenzhen, Guangdong, China. The site and apparatus are constructed in conformance with the requirements of ANSI C63.4 and CISPR 16-1-1 other equivalent standards.

FCC Test Firm Registration Number: 712850

IC Registered No.: 23583

5.2 Test Instrument Used

Conducted emissions Test					
Equipment	Manufacturer	Model#	Serial#	Last Cal.	Next Cal.
Receiver	R&S	ESR3	102075	Jun. 08, 2020	Jun. 07, 2021
LISN	R&S	ENV216	101375	Jun. 04, 2020	Jun. 03, 2021
ISN	HPX	ISN T800	S150900 1	Jun. 04, 2020	Jun. 03, 2021
Software	Frad	EZ-EMC	EMC-CO N 3A1	\	\

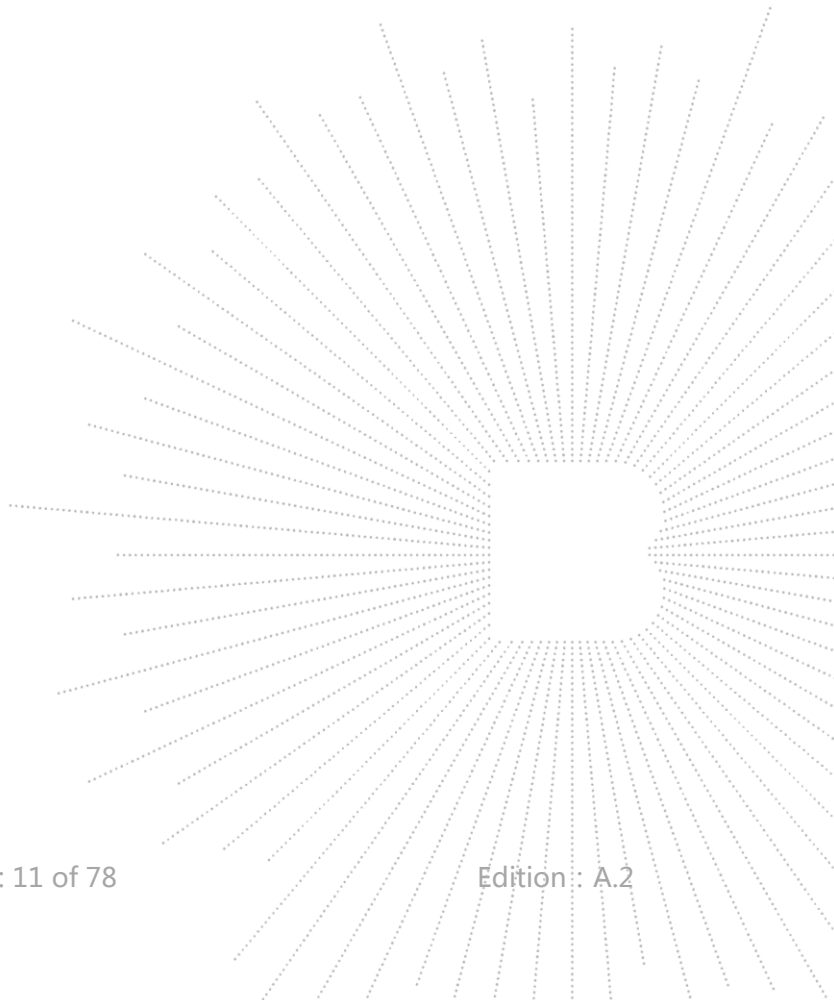

Radiated emissions Test (966 chamber)					
Equipment	Manufacturer	Model#	Serial#	Last Cal.	Next Cal.
966 chamber	ChengYu	966 Room	966	Jun. 06, 2020	Jun. 05, 2023
Receiver	R&S	ESR3	102075	Jun. 08, 2020	Jun. 07, 2021
Receiver	R&S	ESRP	101154	Jun. 08, 2020	Jun. 07, 2021
Amplifier	Schwarzbeck	BBV9718	9718-309	Jun. 04, 2020	Jun. 03, 2021
Amplifier	Schwarzbeck	BBV9744	9744-0037	Jun. 04, 2020	Jun. 03, 2021
TRILOG Broadband Antenna	schwarzbeck	VULB 9163	VULB9163-942	Jun. 08, 2020	Jun. 07, 2021
Horn Antenna	SCHWARZBECK	BBHA9120 D	1541	Jun. 10, 2020	Jun. 09, 2021
Horn Antenna (18GHz-40 GHz)	SCHWARZBECK	BBHA9170	822	Jun. 10, 2020	Jun. 09, 2021
Amplifier (18GHz-40 GHz)	MITEQ	TTA1840-3 5-HG	2034381	Jun. 08, 2020	Jun. 07, 2021
Loop Antenna (9KHz-30M Hz)	SCHWARZBECK	FMZB1519 B	014	Jun. 08, 2020	Jun. 07, 2021
RF cables1 (9kHz-30MHz)	Huber+Suhnar	9kHz-30M Hz	B1702988-0008	Jun. 08, 2020	Jun. 07, 2021
RF cables2 (30MHz-1G Hz)	Huber+Suhnar	30MHz-1G Hz	1486150	Jun. 08, 2020	Jun. 07, 2021
RF cables3 (1GHz-40G Hz)	Huber+Suhnar	1GHz-40G Hz	1607106	Jun. 08, 2020	Jun. 07, 2021
Power Metter	Keysight	E4419B	\	Jun. 08, 2020	Jun. 07, 2021
Power Sensor (AV)	Keysight	E9 300A	\	Jun. 08, 2020	Jun. 07, 2021
Signal Analyzer 20kHz-26.5 GHz	KEYSIGHT	N9020A	MY491000 60	Jun. 04, 2020	Jun. 03, 2021
Spectrum Analyzer 9kHz-40G Hz	Agilent	FSP40	100363	Jun. 08, 2020	Jun. 07, 2021
Software	Frad	EZ-EMC	FA-03A2 RE	\	\

6. CONDUCTED EMISSIONS

6.1 Block Diagram Of Test Setup

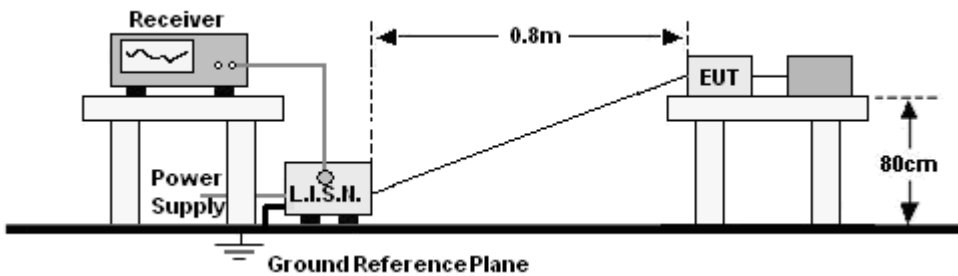

6.2 Limit

FREQUENCY (MHz)	Limit (dBuV)	
	Quas-peak	Average
0.15 -0.5	66 - 56 *	56 - 46 *
0.50 -5.0	56.00	46.00
5.0 -30.0	60.00	50.00

Notes:
 1. *Decreasing linearly with logarithm of frequency.
 2. The lower limit shall apply at the transition frequencies.

6.3 Test procedure

Receiver Parameters	Setting
Attenuation	10 dB
Start Frequency	0.15 MHz
Stop Frequency	30 MHz
IF Bandwidth	9 kHz

- The Product was placed on a nonconductive table 0.8 m above the horizontal ground reference plane, and 0.4 m from the vertical ground reference plane, and connected to the main through Line Impedance Stability Network (L.I.S.N).
- The RBW of the receiver was set at 9 kHz in 150 kHz ~ 30MHz with Peak and AVG detector in Max Hold mode. Run the receiver's pre-scan to record the maximum disturbance generated from Product in all power lines in the full band.
- For each frequency whose maximum record was higher or close to limit, measure its QP and AVG values and record.

6.4 EUT operating Conditions

The EUT was configured for testing in a typical fashion (as a customer would normally use it). The EUT has been programmed to continuously transmit during test. This operating condition was tested and used to collect the included data.

6.5 Test Result

Model: X19

Temperature :	26 °C	Relative Humidity :	54%
Pressure :	101kPa	Phase :	L
Test Voltage :	AC 120V/60Hz	Test Mode :	Mode 5

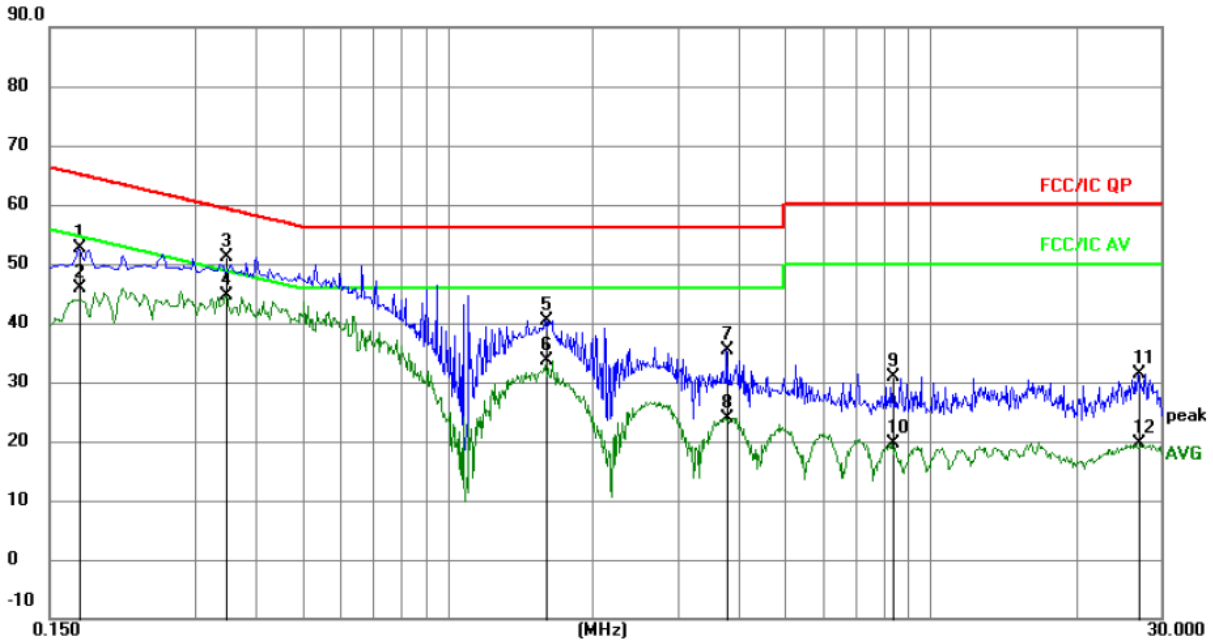

Remark:

1. All readings are Quasi-Peak and Average values.
2. Factor = Insertion Loss + Cable Loss.

No.	Mk.	Freq.	Reading Level	Correct Factor	Measurement	Limit	Over	Detector	Comment
		MHz		dB	dBuV	dBuV	dB		
1		0.1725	43.02	9.49	52.51	64.84	-12.33	QP	
2		0.1725	36.37	9.49	45.86	54.84	-8.98	AVG	
3		0.3480	41.66	9.54	51.20	59.01	-7.81	QP	
4	*	0.3480	35.12	9.54	44.66	49.01	-4.35	AVG	
5		1.5945	30.72	9.58	40.30	56.00	-15.70	QP	
6		1.5945	24.14	9.58	33.72	46.00	-12.28	AVG	
7		3.7950	25.64	9.72	35.36	56.00	-20.64	QP	
8		3.7950	14.21	9.72	23.93	46.00	-22.07	AVG	
9		8.3265	21.23	9.71	30.94	60.00	-29.06	QP	
10		8.3265	9.82	9.71	19.53	50.00	-30.47	AVG	
11		26.9115	21.74	9.73	31.47	60.00	-28.53	QP	
12		26.9115	9.88	9.73	19.61	50.00	-30.39	AVG	

Temperature :	26 °C	Relative Humidity :	54%
Pressure :	101kPa	Phase :	N
Test Voltage :	AC 120V/60Hz	Test Mode :	Mode 5

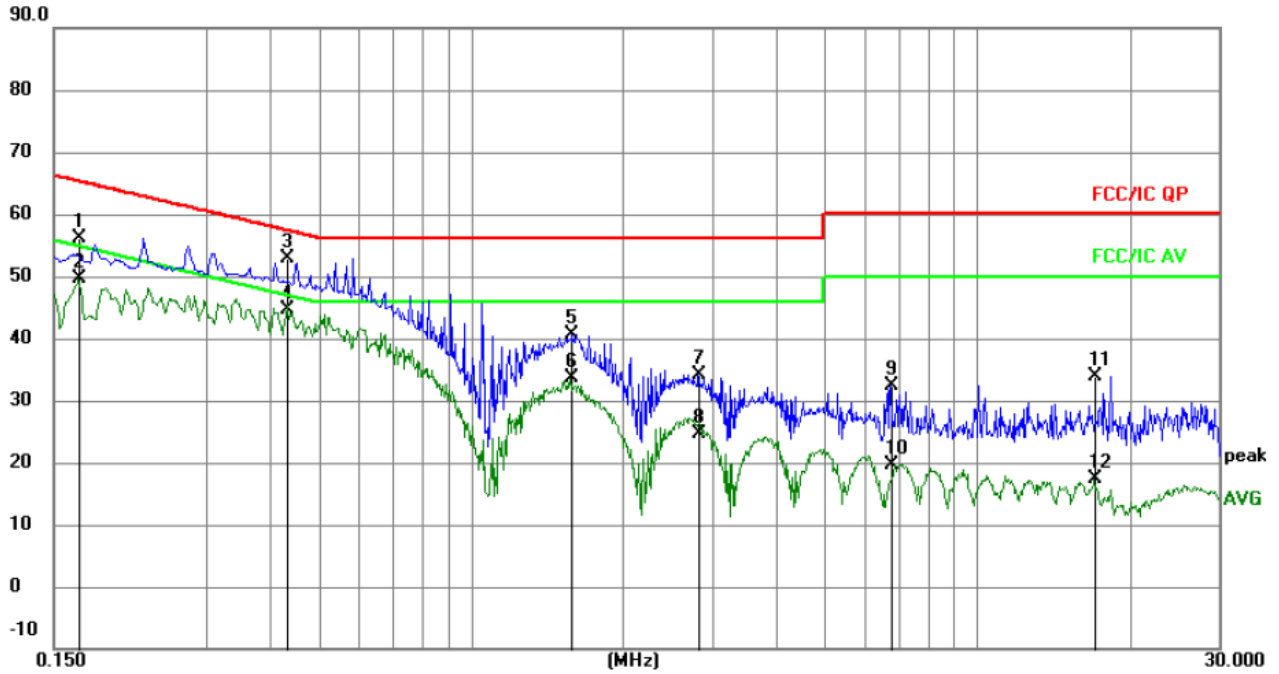

Remark:

1. All readings are Quasi-Peak and Average values.
2. Factor = Insertion Loss + Cable Loss.

No.	Mk.	Freq. MHz	Reading Level	Correct Factor	Measure- ment	Limit	Over	Detector	Comment
				dB	dBuV	dBuV	dB		
1		0.1680	46.55	9.50	56.05	65.06	-9.01	QP	
2		0.1680	40.09	9.50	49.59	55.06	-5.47	AVG	
3		0.4351	43.42	9.53	52.95	57.15	-4.20	QP	
4	*	0.4351	35.04	9.53	44.57	47.15	-2.58	AVG	
5		1.5720	31.05	9.58	40.63	56.00	-15.37	QP	
6		1.5720	24.00	9.58	33.58	46.00	-12.42	AVG	
7		2.8140	24.60	9.65	34.25	56.00	-21.75	QP	
8		2.8140	14.87	9.65	24.52	46.00	-21.48	AVG	
9		6.7560	22.61	9.73	32.34	60.00	-27.66	QP	
10		6.7560	10.01	9.73	19.74	50.00	-30.26	AVG	
11		17.1060	24.20	9.74	33.94	60.00	-26.06	QP	
12		17.1060	7.68	9.74	17.42	50.00	-32.58	AVG	

Model: X19A

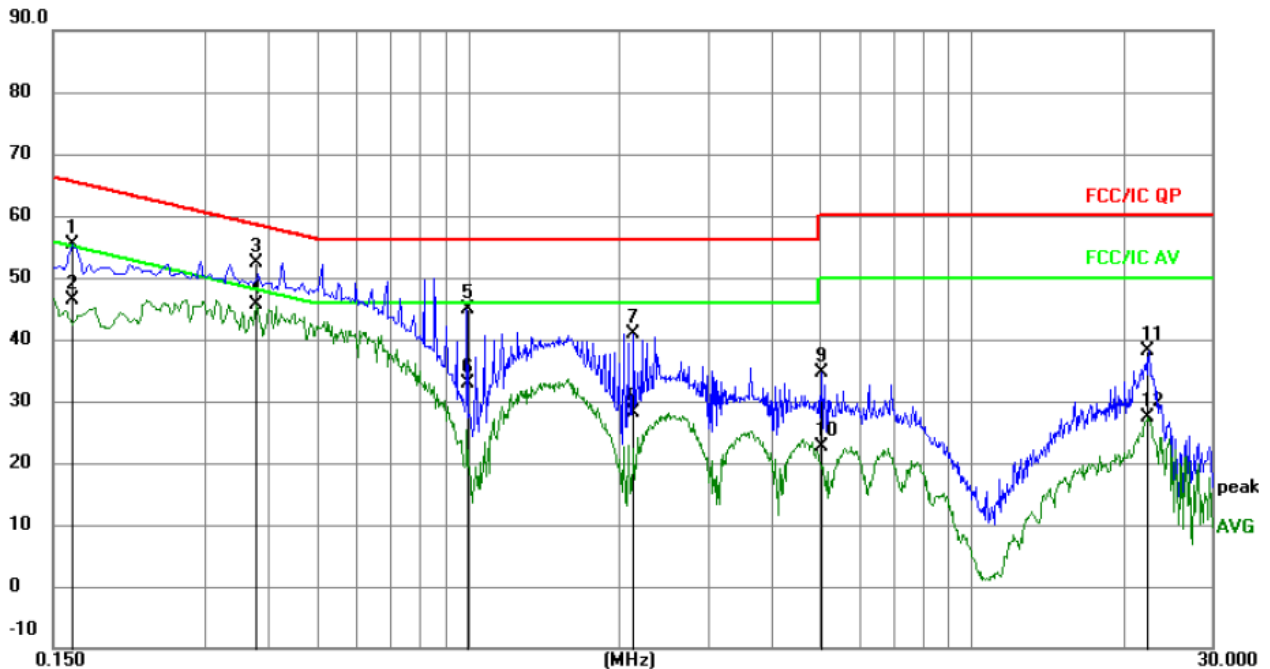
Temperature :	26 °C	Relative Humidity :	54%
Pressure :	101kPa	Phase :	L
Test Voltage :	AC 120V/60Hz	Test Mode :	Mode 5

Remark:

1. All readings are Quasi-Peak and Average values.
2. Factor = Insertion Loss + Cable Loss.

No.	Mk.	Freq. MHz	Reading Level	Correct Factor dB	Measure- ment dBuV	Limit dBuV	Over dB	Detector	Comment
1		0.1635	45.83	9.50	55.33	65.28	-9.95	QP	
2		0.1635	36.80	9.50	46.30	55.28	-8.98	AVG	
3		0.3791	42.96	9.52	52.48	58.30	-5.82	QP	
4	*	0.3791	36.12	9.52	45.64	48.30	-2.66	AVG	
5		0.9960	35.38	9.57	44.95	56.00	-11.05	QP	
6		0.9960	23.34	9.57	32.91	46.00	-13.09	AVG	
7		2.1325	31.32	9.60	40.92	56.00	-15.08	QP	
8		2.1325	18.42	9.60	28.02	46.00	-17.98	AVG	
9		5.0312	24.73	9.80	34.53	60.00	-25.47	QP	
10		5.0312	12.72	9.80	22.52	50.00	-27.48	AVG	
11		22.4163	28.27	9.77	38.04	60.00	-21.96	QP	
12		22.4163	17.54	9.77	27.31	50.00	-22.69	AVG	

Temperature :	26 °C	Relative Humidity :	54%
Pressure :	101kPa	Phase :	N
Test Voltage :	AC 120V/60Hz	Test Mode :	Mode 5

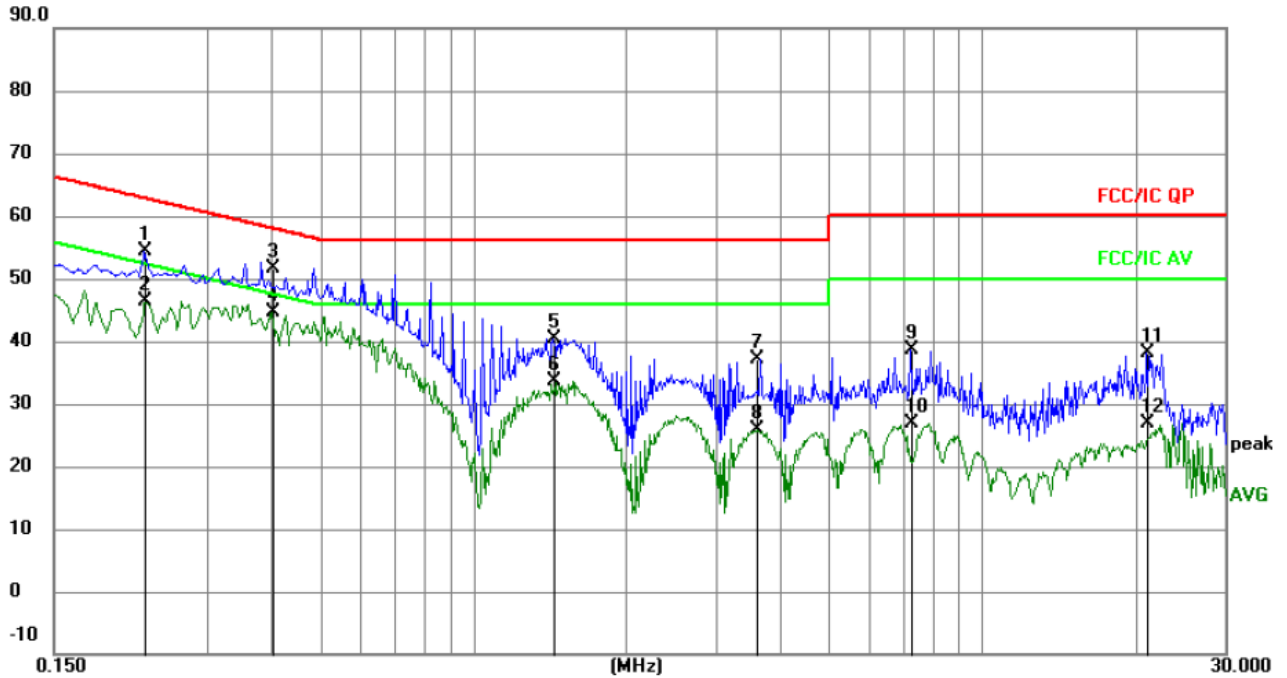

Remark:

1. All readings are Quasi-Peak and Average values.
2. Factor = Insertion Loss + Cable Loss.

No.	Mk.	Freq. MHz	Reading Level	Correct Factor	Measure- ment	Limit	Over	Detector	Comment
					dBuV	dBuV	dB		
1		0.2265	44.80	9.49	54.29	62.58	-8.29	QP	
2		0.2265	36.89	9.49	46.38	52.58	-6.20	AVG	
3		0.4020	42.04	9.50	51.54	57.81	-6.27	QP	
4	*	0.4020	35.17	9.50	44.67	47.81	-3.14	AVG	
5		1.4370	30.81	9.58	40.39	56.00	-15.61	QP	
6		1.4370	24.04	9.58	33.62	46.00	-12.38	AVG	
7		3.6150	27.35	9.70	37.05	56.00	-18.95	QP	
8		3.6150	16.22	9.70	25.92	46.00	-20.08	AVG	
9		7.2240	28.87	9.72	38.59	60.00	-21.41	QP	
10		7.2240	17.05	9.72	26.77	50.00	-23.23	AVG	
11		21.0975	28.47	9.78	38.25	60.00	-21.75	QP	
12		21.0975	17.15	9.78	26.93	50.00	-23.07	AVG	

Model: X19B

Temperature :	26 °C	Relative Humidity :	54%
Pressure :	101kPa	Phase :	L
Test Voltage :	AC 120V/60Hz	Test Mode :	Mode 5

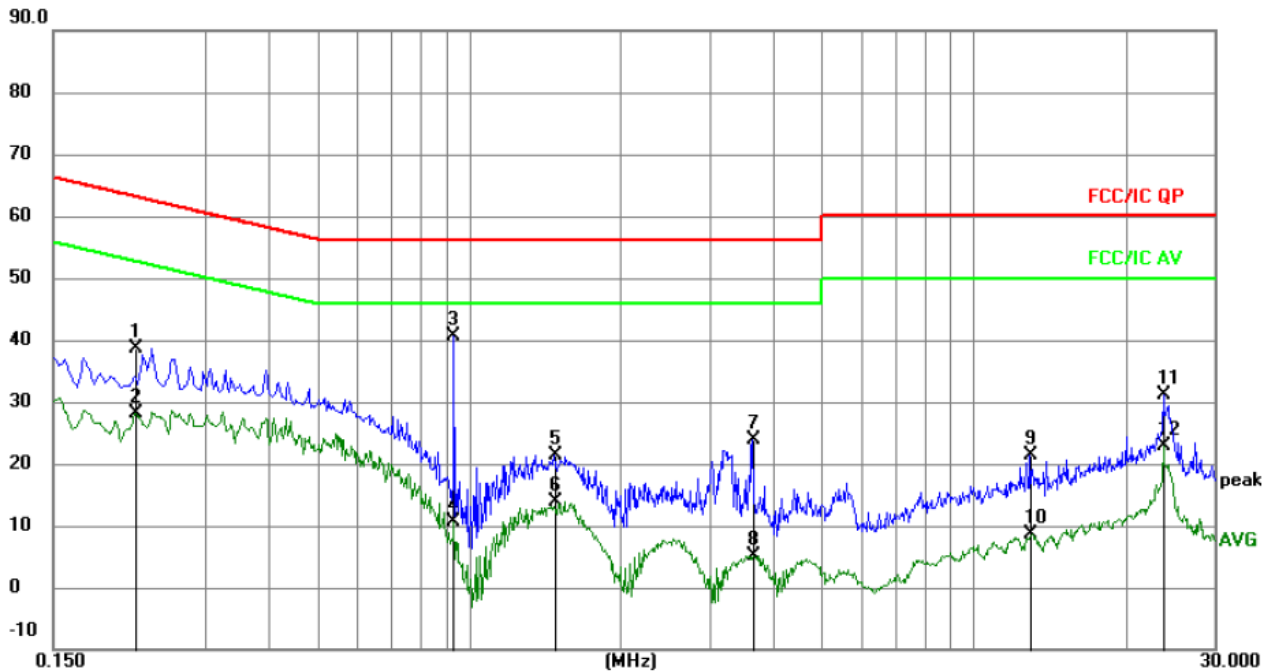
Remark:

1. All readings are Quasi-Peak and Average values.
2. Factor = Insertion Loss + Cable Loss.

No.	Mk.	Freq. MHz	Reading Level	Correct Factor	Measure- ment	Limit	Over	Detector	Comment
					dBuV	dBuV	dB		
1		0.2174	29.11	9.48	38.59	62.92	-24.33	QP	
2		0.2174	18.75	9.48	28.23	52.92	-24.69	AVG	
3	*	0.9331	31.08	9.59	40.67	56.00	-15.33	QP	
4		0.9331	0.95	9.59	10.54	46.00	-35.46	AVG	
5		1.4718	11.91	9.58	21.49	56.00	-34.51	QP	
6		1.4718	4.27	9.58	13.85	46.00	-32.15	AVG	
7		3.6418	14.06	9.70	23.76	56.00	-32.24	QP	
8		3.6418	-4.50	9.70	5.20	46.00	-40.80	AVG	
9		12.9199	11.66	9.70	21.36	60.00	-38.64	QP	
10		12.9199	-1.17	9.70	8.53	50.00	-41.47	AVG	
11		23.7615	21.41	9.76	31.17	60.00	-28.83	QP	
12		23.7615	13.09	9.76	22.85	50.00	-27.15	AVG	

Temperature :	26 °C	Relative Humidity :	54%
Pressure :	101kPa	Phase :	N
Test Voltage :	AC 120V/60Hz	Test Mode :	Mode 5

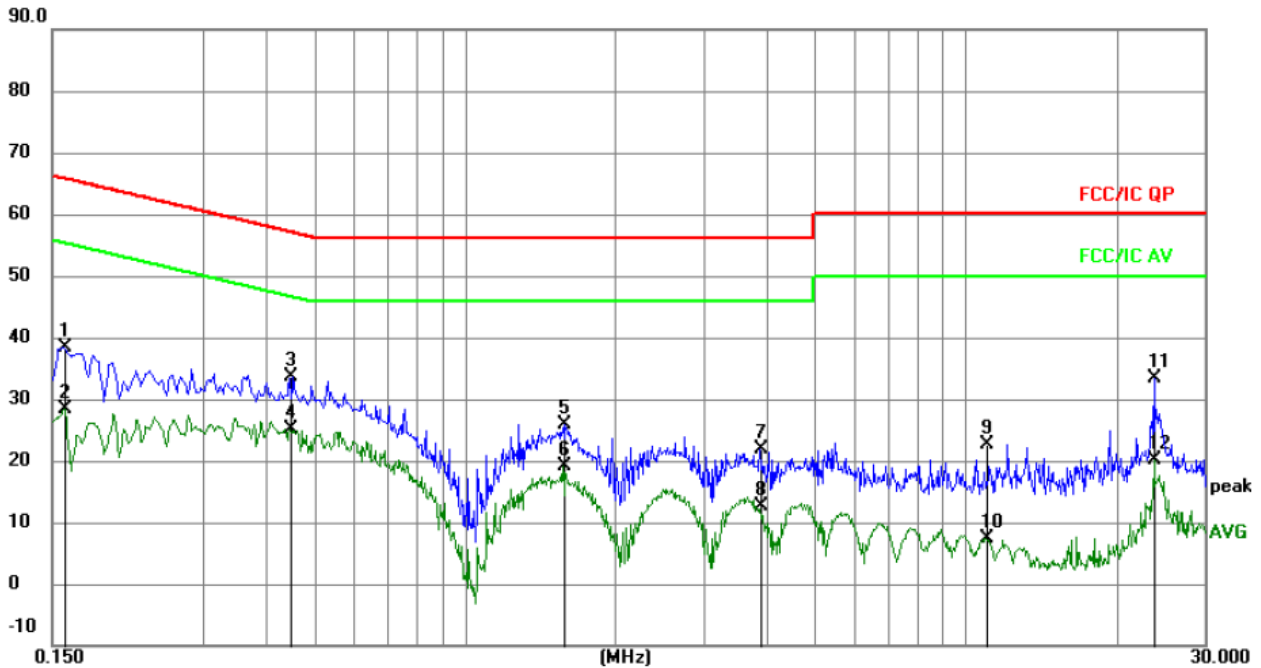
Remark:

1. All readings are Quasi-Peak and Average values.
2. Factor = Insertion Loss + Cable Loss.

No.	Mk.	Freq. MHz	Reading Level	Correct Factor dB	Measure- ment dBuV	Limit dBuV	Over dB	Detector	Comment
1		0.1590	28.92	9.51	38.43	65.52	-27.09	QP	
2		0.1590	18.80	9.51	28.31	55.52	-27.21	AVG	
3		0.4470	24.19	9.54	33.73	56.93	-23.20	QP	
4	*	0.4470	15.57	9.54	25.11	46.93	-21.82	AVG	
5		1.5764	16.33	9.58	25.91	56.00	-30.09	QP	
6		1.5764	9.45	9.58	19.03	46.00	-26.97	AVG	
7		3.8849	12.23	9.72	21.95	56.00	-34.05	QP	
8		3.8849	2.91	9.72	12.63	46.00	-33.37	AVG	
9		10.9679	12.90	9.69	22.59	60.00	-37.41	QP	
10		10.9679	-2.31	9.69	7.38	50.00	-42.62	AVG	
11		23.8649	23.51	9.75	33.26	60.00	-26.74	QP	
12		23.8649	10.49	9.75	20.24	50.00	-29.76	AVG	

7. RADIATED EMISSIONS

7.1 Block Diagram Of Test Setup

(A) Radiated Emission Test-Up Frequency Below 30MHz

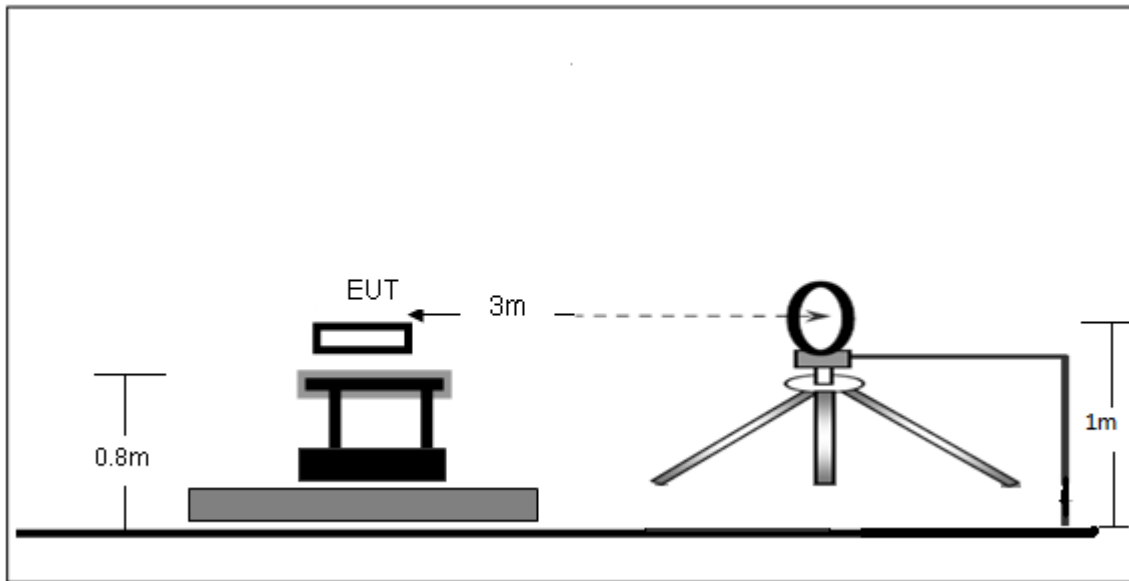

(B) Radiated Emission Test-Up Frequency 30MHz~1GHz

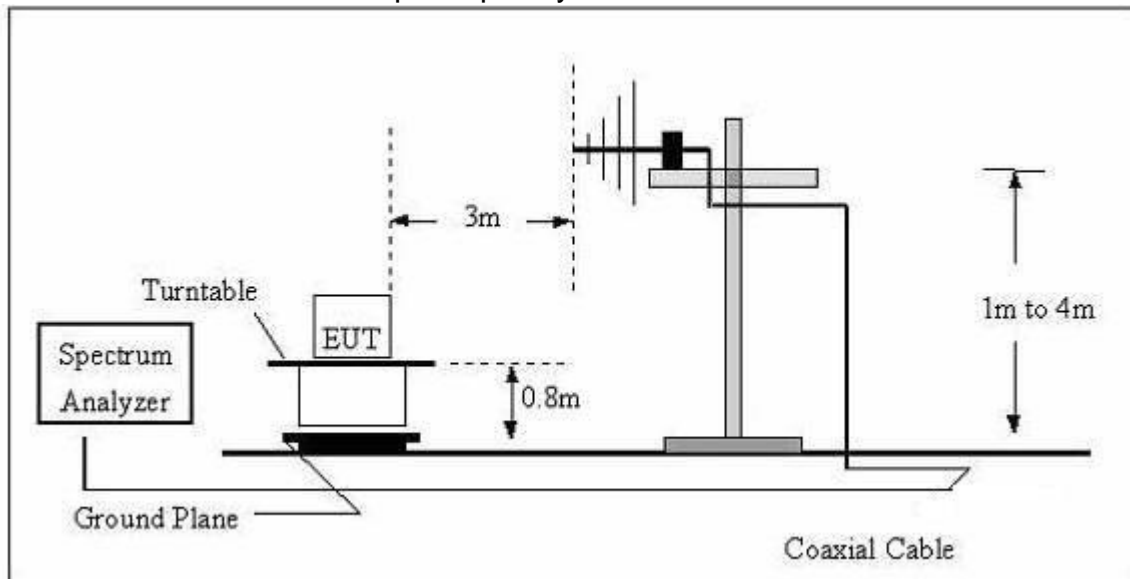

(C) Radiated Emission Test-Up Frequency Above 1GHz

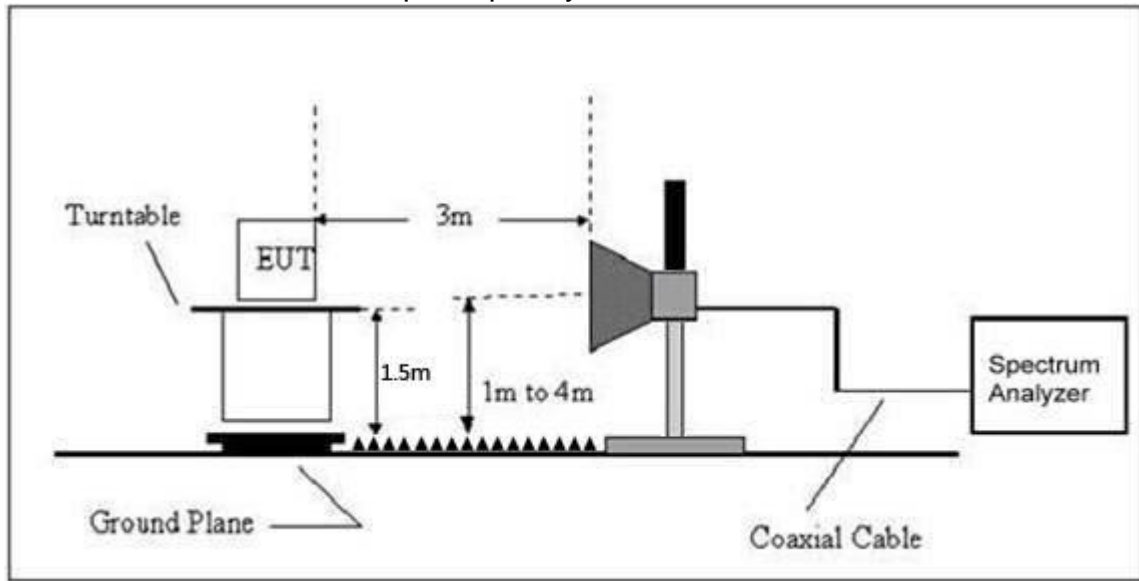

7.2 Limit

20dBc in any 100 kHz bandwidth outside the operating frequency band. In case the emission fall within the restricted band specified on 15.205(a), then the 15.209(a) limit in the table below has to be followed.

Frequency (MHz)	Field Strength (uV/m)	Distance (m)	Field Strength Limit at 3m Distance	
			uV/m	dBuV/m
0.009 ~ 0.490	2400/F(kHz)	300	10000 * 2400/F(kHz)	20log ^{(2400/F(kHz))} + 80
0.490 ~ 1.705	24000/F(kHz)	30	100 * 24000/F(kHz)	20log ^{(24000/F(kHz))} + 40
1.705 ~ 30	30	30	100 * 30	20log ⁽³⁰⁾ + 40
30 ~ 88	100	3	100	20log ⁽¹⁰⁰⁾
88 ~ 216	150	3	150	20log ⁽¹⁵⁰⁾
216 ~ 960	200	3	200	20log ⁽²⁰⁰⁾
Above 960	500	3	500	20log ⁽⁵⁰⁰⁾

LIMITS OF RADIATED EMISSION MEASUREMENT (Above 1000MHz)

FREQUENCY (MHz)	Limit (dBuV/m) (at 3M)	
	PEAK	AVERAGE
Above 1000	74	54

Notes:

- (1)The limit for radiated test was performed according to FCC PART 15C.
- (2)The tighter limit applies at the band edges.
- (3) Emission level (dBuV/m)=20log Emission level (uV/m).

FREQUENCY RANGE OF RADIATED MEASUREMENT (For unintentional radiators)

Highest frequency generated or Upper frequency of measurement used in the device or on which the device operates or tunes (MHz)	Range (MHz)
Below 1.705	30
1.705 – 108	1000
108 – 500	2000
500 – 1000	5000
Above 1000	5 th harmonic of the highest frequency or 40 GHz, whichever is lower

7.3 Test procedure

Receiver Parameter	Setting
Attenuation	Auto
9kHz~150kHz	RBW 200Hz for QP
150kHz~30MHz	RBW 9kHz for QP
30MHz~1000MHz	RBW 120kHz for QP

Spectrum Parameter	Setting
1-25GHz	RBW 1 MHz /VBW 1 MHz for Peak, RBW 1 MHz / VBW 10Hz for Average

Below 1GHz test procedure as below:

- a. The EUT was placed on the top of a rotating table 0.8 meters above the ground at a 3 meter semi-anechoic chamber. The table was rotated 360 degrees to determine the position of the highest radiation.
- b. The EUT was set 3 meters away from the interference-receiving antenna, which was mounted on the top of a variable-height antenna tower.
- c. The antenna height is varied from one meter to four meters above the ground to determine the maximum value of the field strength. Both horizontal and vertical polarizations of the antenna are set to make the measurement.
- d. For each suspected emission, the EUT was arranged to its worst case and then the antenna was tuned to heights from 1 meter to 4 meters (for the test frequency of below 30MHz, the antenna was tuned to heights 1 meter) and the rotatable table was turned from 0 degrees to 360 degrees to find the maximum reading.
- e. The test-receiver system was set to Peak Detect Function and Specified Bandwidth with Maximum Hold Mode.
- f. If the emission level of the EUT in peak mode was 10dB lower than the limit specified, then testing could be stopped and the peak values of the EUT would be reported. Otherwise the emissions that did not have 10dB margin would be re-tested one by one using peak, quasi-peak or average method as specified and then reported in a data sheet.

Above 1GHz test procedure as below:

g. Different between above is the test site, change from Semi- Anechoic Chamber to fully Anechoic Chamber and change form table 0.8 metre to 1.5 metre(Above 18GHz the distance is 1 meter and table is 1.5 metre).

h. Test the EUT in the lowest channel ,the middle channel ,the Highest channel.

Note:

Both horizontal and vertical antenna polarities were tested and performed pretest to three orthogonal axis. The worst case emissions were reported.

Above 1GHz test procedure as below:

a.The EUT was placed on the top of a rotating table 1.5 meters above the ground at a 3 meter camber. The table was rotated 360 degrees to determine the position of the highest radiation.

b.The EUT was set 3 meters away from the interference-receiving antenna, which was mounted on the top of a variable-height antenna tower.

c.The antenna height is varied from one meter to four meters above the ground to determine the maximum value of the field strength. Both horizontal and vertical polarizations of the antenna are set to make the measurement.

d.For each suspected emission, the EUT was arranged to its worst case and then the antenna was tuned to heights from 1 meter to 4 meters and the rota table was turned from 0 degrees to 360 degrees to find the maximum reading.

e.The test-receiver system was set to Peak Detect Function and Specified Bandwidth with Maximum Hold Mode.

f. If the emission level of the EUT in peak mode was 10dB lower than the limit specified, then testing could be stopped and the peak values of the EUT would be reported. Otherwise the emissions that did not have 10dB margin would be re-tested one by one using peak, quasi-peak or average method as specified and then reported in a data sheet.

g.Test the EUT in the lowest channel,the Highest channel.

Note:

Both horizontal and vertical antenna polarities were tested and performed pretest to three orthogonal axis. The worst case emissions were reported.

7.4 EUT operating Conditions

The EUT was configured for testing in a typical fashion (as a customer would normally use it). The EUT has been programmed to continuously transmit during test. This operating condition was tested and used to collect the included data.

7.5 Test Result

Below 30MHz

Temperature:	26°C	Relative Humidity:	24%
Pressure:	101 kPa	Test Voltage :	AC120V/60Hz
Test Mode :	Mode 5	Polarization :	--

Freq. (MHz)	Reading (dBuV/m)	Limit (dBuV/m)	Margin (dB)	State P/F
--	--	--	--	PASS
--	--	--	--	PASS

Note:

The amplitude of spurious emissions which are attenuated by more than 20dB below the permissible value has no need to be reported.

Distance extrapolation factor = $40 \log(\text{specific distance}/\text{test distance})$ (dB);

Limit line = specific limits(dBuv) + distance extrapolation factor.

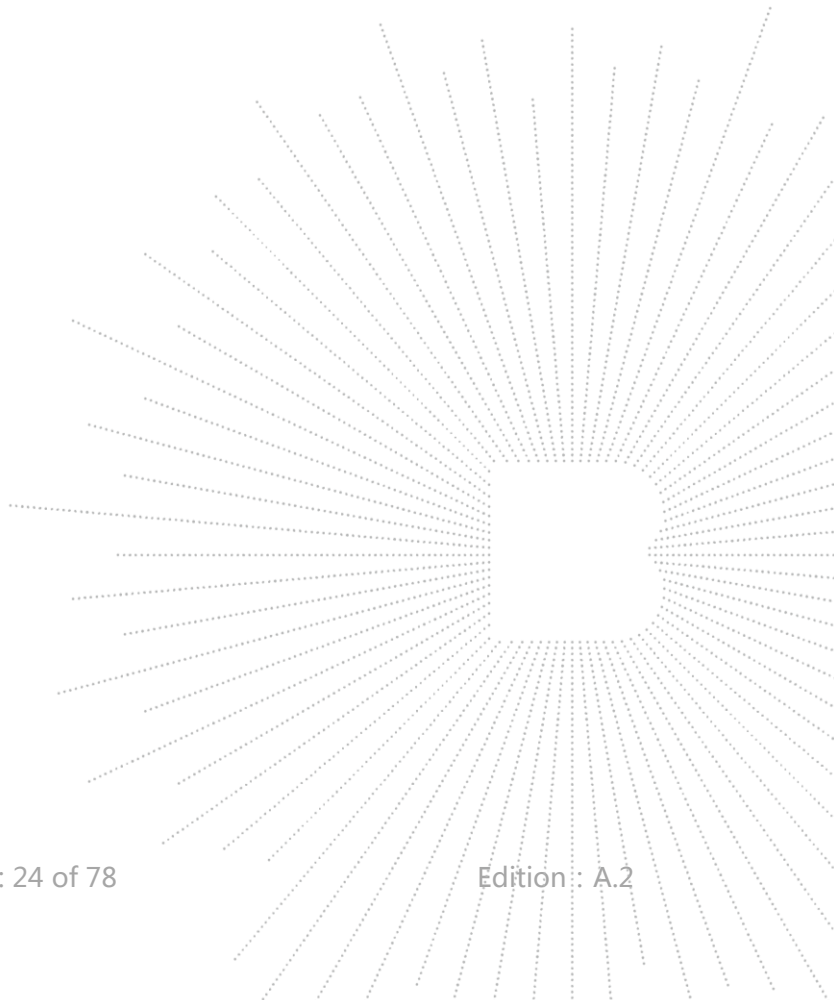

Between 30MHz – 1GHz

Model: X19

Temperature:	26°C	Relative Humidity:	54%
Pressure:	101 kPa	Test Voltage :	AC120V/60Hz
Test Mode :	Mode 5	Polarization :	Horizontal

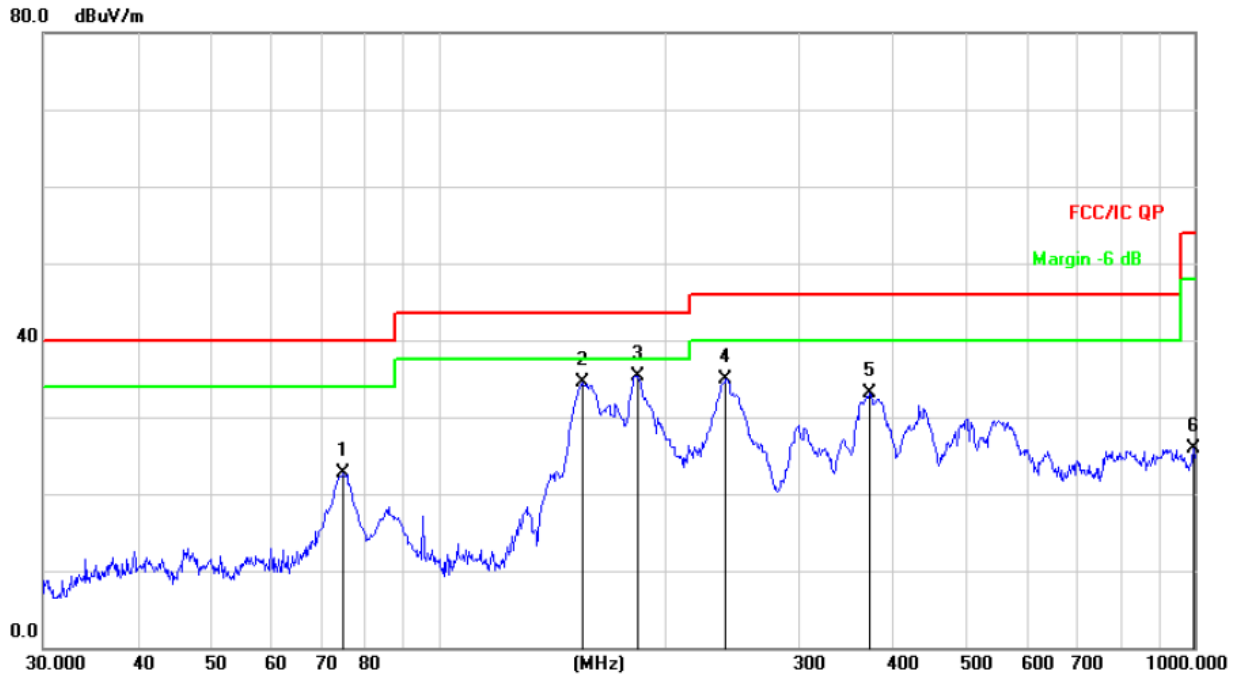

Remark:

Factor = Antenna Factor + Cable Loss – Pre-amplifier.

No.	Mk.	Freq.	Reading Level	Correct Factor	Measurement	Limit	Over	Detector
		MHz	dBuV	dB	dBuV/m	dB/m	dB	
1		74.9191	41.07	-18.36	22.71	40.00	-17.29	QP
2		155.3644	52.92	-18.34	34.58	43.50	-8.92	QP
3	*	183.8440	51.68	-16.37	35.31	43.50	-8.19	QP
4		239.9874	49.35	-14.44	34.91	46.00	-11.09	QP
5		372.0045	43.65	-10.46	33.19	46.00	-12.81	QP
6		996.4996	26.97	-1.01	25.96	54.00	-28.04	QP

Temperature:	26°C	Relative Humidity:	54%
Pressure:	101 kpa	Test Voltage :	AC120V/60Hz
Test Mode :	Mode 5	Polarization :	Vertical

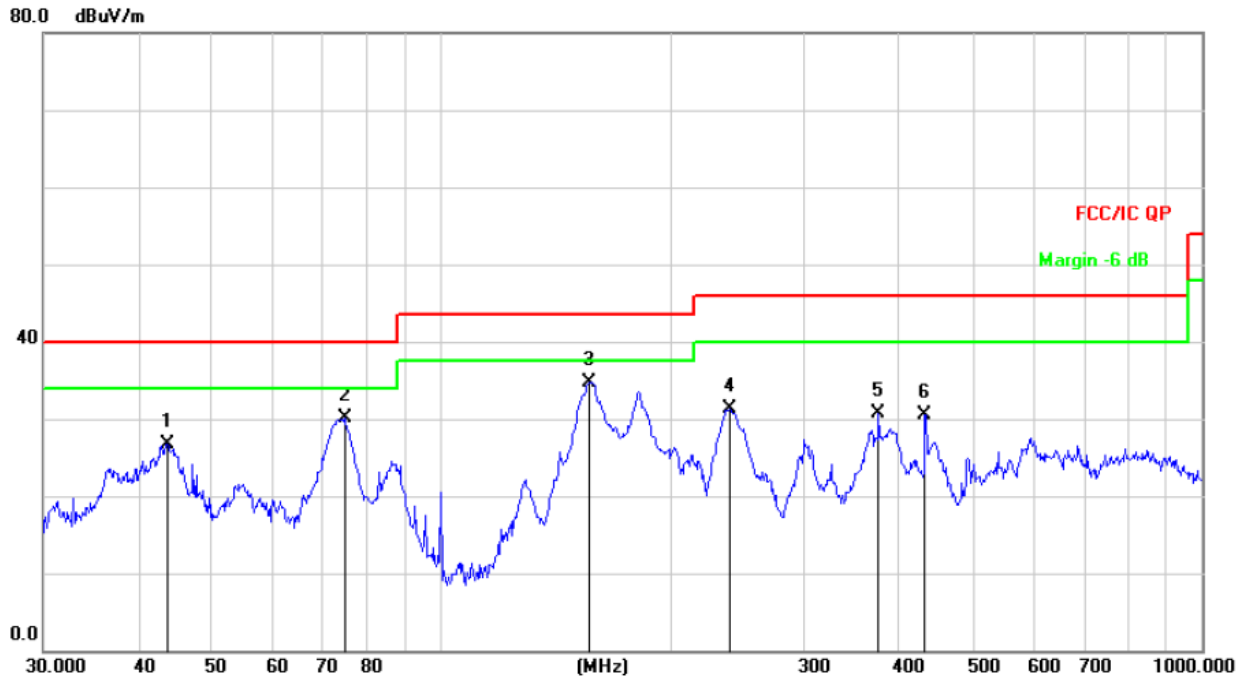

Remark:

Factor = Antenna Factor + Cable Loss – Pre-amplifier.

No.	Mk.	Freq.	Reading Level	Correct Factor	Measurement	Limit	Over	Detector
		MHz	dBuV	dB	dBuV/m	dB/m	dB	
1		43.6584	41.41	-14.63	26.78	40.00	-13.22	QP
2		74.6569	48.31	-18.30	30.01	40.00	-9.99	QP
3	*	156.4578	53.04	-18.26	34.78	43.50	-8.72	QP
4		239.9874	45.71	-14.44	31.27	46.00	-14.73	QP
5		375.9385	40.99	-10.35	30.64	46.00	-15.36	QP
6		432.5457	39.57	-8.99	30.58	46.00	-15.42	QP

Model: X19A

Temperature:	26°C	Relative Humidity:	54%
Pressure:	101 kPa	Test Voltage :	AC120V/60Hz
Test Mode :	Mode 5	Polarization :	Horizontal



Remark:

Factor = Antenna Factor + Cable Loss – Pre-amplifier.

No.	Mk.	Freq.	Reading Level	Correct Factor	Measurement	Limit	Over	Detector
		MHz	dBuV	dB	dBuV/m	dB/m	dB	
1		44.1202	28.47	-14.59	13.88	40.00	-26.12	QP
2		95.4270	35.94	-16.39	19.55	43.50	-23.95	QP
3	*	194.4534	51.85	-15.64	36.21	43.50	-7.29	QP
4		240.8304	48.03	-14.42	33.61	46.00	-12.39	QP
5		300.3672	43.35	-12.39	30.96	46.00	-15.04	QP
6		451.1350	42.53	-8.60	33.93	46.00	-12.07	QP

Temperature:	26°C	Relative Humidity:	54%
Pressure:	101 kpa	Test Voltage :	AC120V/60Hz
Test Mode :	Mode 5	Polarization :	Vertical

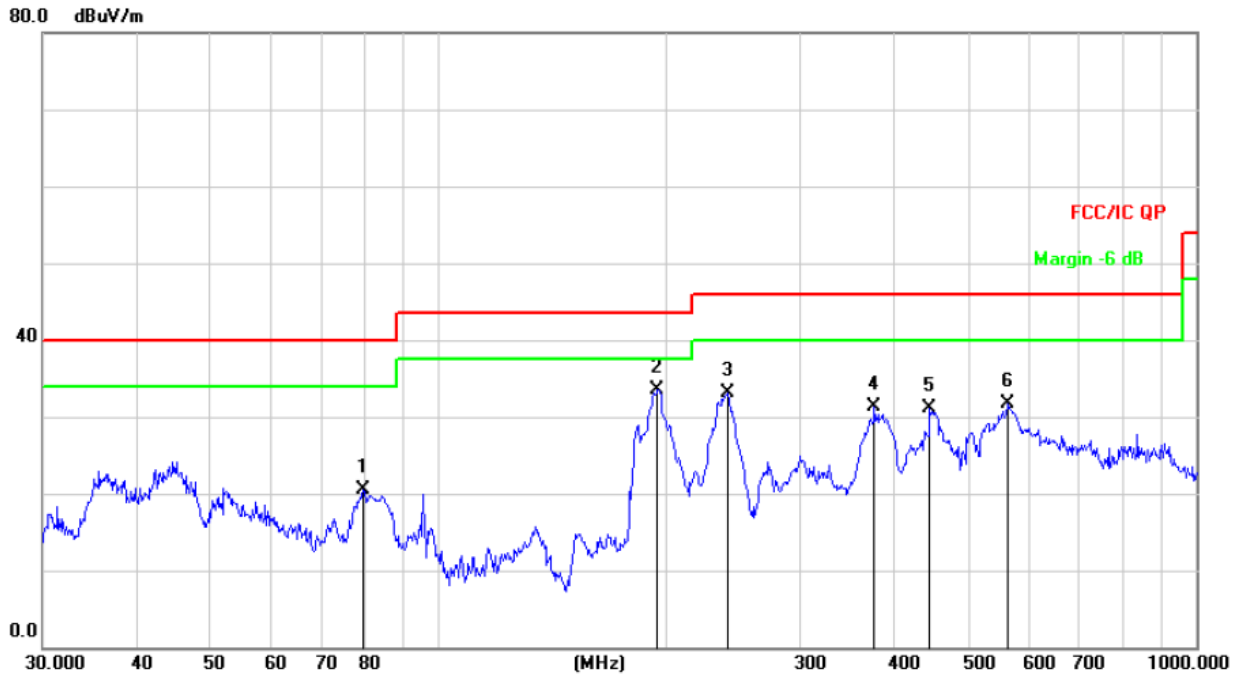

Remark:

Factor = Antenna Factor + Cable Loss – Pre-amplifier.

No.	Mk.	Freq.	Reading Level	Correct Factor	Measurement	Limit	Over	Detector
		MHz	dBuV	dB	dBuV/m	dB/m	dB	
1		79.5209	39.90	-19.40	20.50	40.00	-19.50	QP
2	*	194.4534	49.10	-15.64	33.46	43.50	-10.04	QP
3		240.8304	47.49	-14.42	33.07	46.00	-12.93	QP
4		375.9385	41.57	-10.35	31.22	46.00	-14.78	QP
5		444.8514	39.78	-8.73	31.05	46.00	-14.95	QP
6		564.6389	37.69	-5.94	31.75	46.00	-14.25	QP

Model: X19B

Temperature:	26°C	Relative Humidity:	54%
Pressure:	101 kPa	Test Voltage :	AC120V/60Hz
Test Mode :	Mode 5	Polarization :	Horizontal

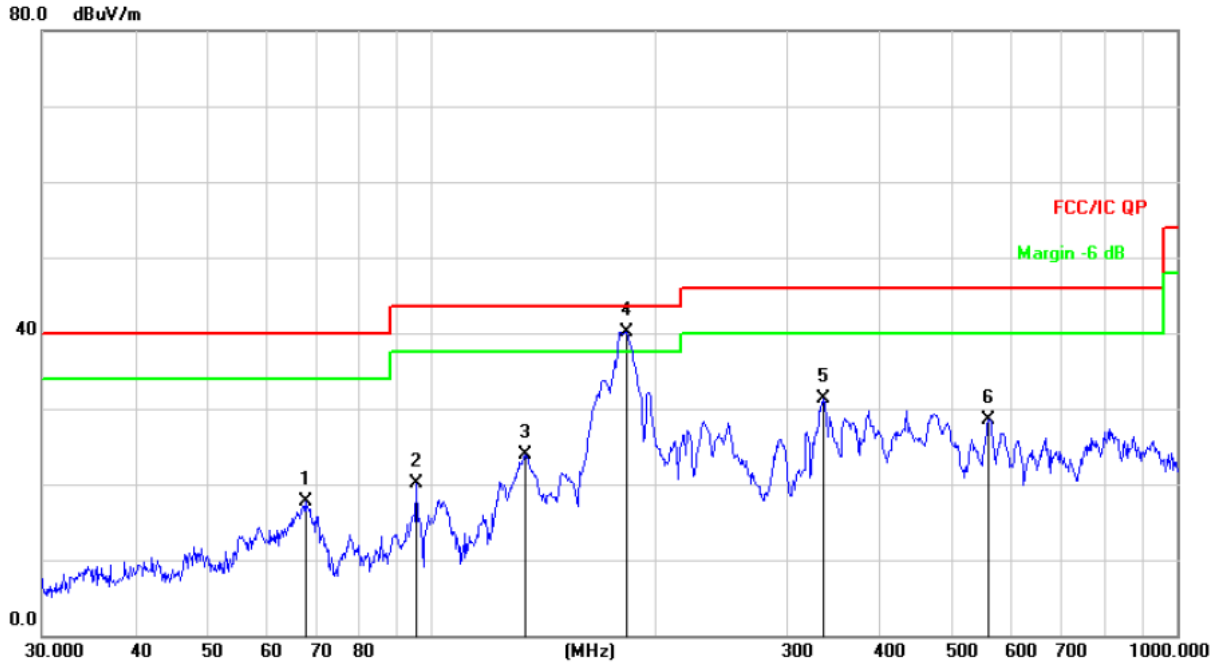
Remark:

Factor = Antenna Factor + Cable Loss – Pre-amplifier.

No.	Mk.	Freq.	Reading Level	Correct Factor	Measurement	Limit	Over	Detector
		MHz	dBuV	dB	dBuV/m	dB/m	dB	
1		67.6751	34.30	-16.64	17.66	40.00	-22.34	QP
2		95.4270	36.43	-16.39	20.04	43.50	-23.46	QP
3		133.6188	41.61	-17.65	23.96	43.50	-19.54	QP
4	*	182.5592	56.56	-16.46	40.10	43.50	-3.40	QP
5		336.0352	42.74	-11.44	31.30	46.00	-14.70	QP
6		558.7302	34.60	-6.09	28.51	46.00	-17.49	QP

Temperature:	26°C	Relative Humidity:	54%
Pressure:	101 kpa	Test Voltage :	AC120V/60Hz
Test Mode :	Mode 5	Polarization :	Vertical

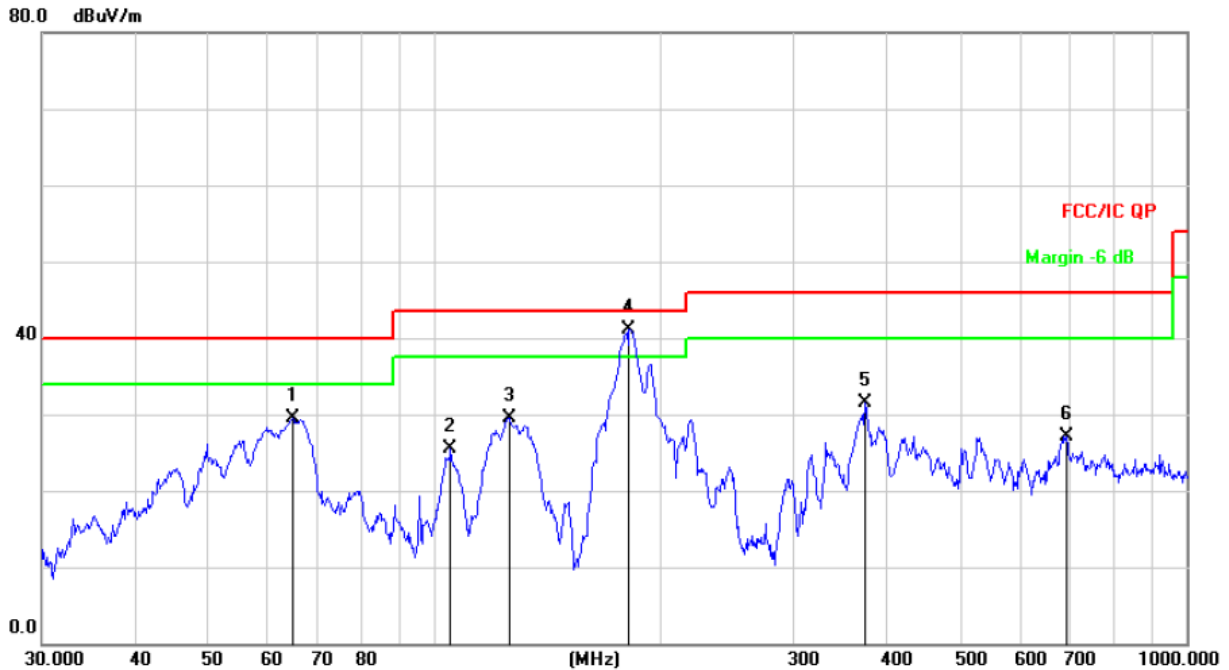

Remark:

Factor = Antenna Factor + Cable Loss – Pre-amplifier.

No.	Mk.	Freq.	Reading Level	Correct Factor	Measurement	Limit	Over	Detector
		MHz	dBuV	dB	dBuV/m	dB/m	dB	
1		64.6594	45.28	-15.86	29.42	40.00	-10.58	QP
2		104.9033	41.34	-15.79	25.55	43.50	-17.95	QP
3		125.4457	46.71	-17.12	29.59	43.50	-13.91	QP
4	*	181.2834	57.74	-16.55	41.19	43.50	-2.31	QP
5		373.3112	41.90	-10.42	31.48	46.00	-14.52	QP
6		691.9867	30.84	-3.73	27.11	46.00	-18.89	QP

Between 1GHz – 25GHz
802.11b

Polar (H/V)	Frequency	Reading Level	Correct Factor	Measure- ment	Limits	Over	Detector Type
	(MHz)	(dBuV/m)	(dB)	(dBuV/m)	(dBuV/m)	(dB)	
Low channel:2412MHz							
V	4824.00	52.20	-0.43	51.77	74.00	-22.23	PK
V	4824.00	42.83	-0.43	42.40	54.00	-11.60	AV
V	7236.00	43.62	8.31	51.93	74.00	-22.07	PK
V	7236.00	32.81	8.31	41.12	54.00	-12.88	AV
H	4804.00	51.16	-0.43	50.73	74.00	-23.27	PK
H	4804.00	41.58	-0.43	41.15	54.00	-12.85	AV
H	7236.00	42.24	8.31	50.55	74.00	-23.45	PK
H	7236.00	34.76	8.31	43.07	54.00	-10.93	AV
Middle channel:2437MHz							
V	4874.00	49.42	-0.38	49.04	74.00	-24.96	PK
V	4874.00	42.34	-0.38	41.96	54.00	-12.04	AV
V	7311.00	39.73	8.83	48.56	74.00	-25.44	PK
V	7311.00	31.37	8.83	40.20	54.00	-13.80	AV
H	4874.00	47.49	-0.38	47.11	74.00	-26.89	PK
H	4874.00	36.90	-0.38	36.52	54.00	-17.48	AV
H	7311.00	36.89	8.83	45.72	74.00	-28.28	PK
H	7311.00	29.15	8.83	37.98	54.00	-16.02	AV
High channel:2462MHz							
V	4924.00	51.95	-0.32	51.63	74.00	-22.37	PK
V	4924.00	42.21	-0.32	41.89	54.00	-12.11	AV
V	7386.00	43.61	9.35	52.96	74.00	-21.04	PK
V	7386.00	34.27	9.35	43.62	54.00	-10.38	AV
H	4924.00	49.48	-0.32	49.16	74.00	-24.84	PK
H	4924.00	38.53	-0.32	38.21	54.00	-15.79	AV
H	7386.00	40.70	9.35	50.05	74.00	-23.95	PK
H	7386.00	32.40	9.35	41.75	54.00	-12.25	AV

Remark:

1. Emission Level = Meter Reading + Factor,
 Factor = Antenna Factor + Cable Loss – Pre-amplifier.
 Over = Emission Level - Limit
2. If peak below the average limit, the average emission was no test.
3. In restricted bands of operation, The spurious emissions below the permissible value more than 20dB
4. The amplitude of spurious emissions which are attenuated by more than 20dB below the permissible value has no need to be reported.

802.11g

Polar (H/V)	Frequency	Reading Level	Correct Factor	Measure- ment	Limits	Over	Detector Type
	(MHz)	(dBuV/m)	(dB)	(dBuV/m)	(dBuV/ m)	(dB)	
Low channel:2412MHz							
V	4824.00	54.26	-0.43	53.83	74.00	-20.17	PK
V	4824.00	45.68	-0.43	45.25	54.00	-8.75	AV
V	7236.00	46.99	8.31	55.30	74.00	-18.70	PK
V	7236.00	37.15	8.31	45.46	54.00	-8.54	AV
H	4804.00	51.90	-0.43	51.47	74.00	-22.53	PK
H	4804.00	41.32	-0.43	40.89	54.00	-13.11	AV
H	7236.00	44.09	8.31	52.40	74.00	-21.60	PK
H	7236.00	36.50	8.31	44.81	54.00	-9.19	AV
Middle channel:2437MHz							
V	4874.00	51.68	-0.38	51.30	74.00	-22.70	PK
V	4874.00	43.55	-0.38	43.17	54.00	-10.83	AV
V	7311.00	44.37	8.83	53.20	74.00	-20.80	PK
V	7311.00	34.65	8.83	43.48	54.00	-10.52	AV
H	4874.00	48.73	-0.38	48.35	74.00	-25.65	PK
H	4874.00	37.80	-0.38	37.42	54.00	-16.58	AV
H	7311.00	43.02	8.83	51.85	74.00	-22.15	PK
H	7311.00	35.56	8.83	44.39	54.00	-9.61	AV
High channel:2462MHz							
V	4924.00	54.24	-0.32	53.92	74.00	-20.08	PK
V	4924.00	45.84	-0.32	45.52	54.00	-8.48	AV
V	7386.00	46.71	9.35	56.06	74.00	-17.94	PK
V	7386.00	36.31	9.35	45.66	54.00	-8.34	AV
H	4924.00	51.87	-0.32	51.55	74.00	-22.45	PK
H	4924.00	42.23	-0.32	41.91	54.00	-12.09	AV
H	7386.00	44.60	9.35	53.95	74.00	-20.05	PK
H	7386.00	37.59	9.35	46.94	54.00	-7.06	AV

Remark:

1. Emission Level = Meter Reading + Factor,
 Factor = Antenna Factor + Cable Loss – Pre-amplifier.
 Over = Emission Level - Limit
2. If peak below the average limit, the average emission was no test.
3. In restricted bands of operation, The spurious emissions below the permissible value more than 20dB
4. The amplitude of spurious emissions which are attenuated by more than 20dB below the permissible value has no need to be reported.

802.11n20

Polar (H/V)	Frequency	Reading Level	Correct Factor	Measure- ment	Limits	Over	Detector Type
	(MHz)	(dBuV/m)	(dB)	(dBuV/m)	(dBuV/ m)	(dB)	
Low channel:2412MHz							
V	4824.00	53.63	-0.43	53.20	74.00	-20.80	PK
V	4824.00	43.46	-0.43	43.03	54.00	-10.97	AV
V	7236.00	44.74	8.31	53.05	74.00	-20.95	PK
V	7236.00	35.40	8.31	43.71	54.00	-10.29	AV
H	4804.00	52.28	-0.43	51.85	74.00	-22.15	PK
H	4804.00	43.25	-0.43	42.82	54.00	-11.18	AV
H	7236.00	42.47	8.31	50.78	74.00	-23.22	PK
H	7236.00	33.58	8.31	41.89	54.00	-12.11	AV
Middle channel:2437MHz							
V	4874.00	50.62	-0.38	50.24	74.00	-23.76	PK
V	4874.00	43.83	-0.38	43.45	54.00	-10.55	AV
V	7311.00	42.62	8.83	51.45	74.00	-22.55	PK
V	7311.00	32.92	8.83	41.75	54.00	-12.25	AV
H	4874.00	46.57	-0.38	46.19	74.00	-27.81	PK
H	4874.00	36.65	-0.38	36.27	54.00	-17.73	AV
H	7311.00	40.73	8.83	49.56	74.00	-24.44	PK
H	7311.00	33.72	8.83	42.55	54.00	-11.45	AV
High channel:2462MHz							
V	4924.00	52.90	-0.32	52.58	74.00	-21.42	PK
V	4924.00	42.85	-0.32	42.53	54.00	-11.47	AV
V	7386.00	45.92	9.35	55.27	74.00	-18.73	PK
V	7386.00	35.47	9.35	44.82	54.00	-9.18	AV
H	4924.00	50.78	-0.32	50.46	74.00	-23.54	PK
H	4924.00	41.63	-0.32	41.31	54.00	-12.69	AV
H	7386.00	43.22	9.35	52.57	74.00	-21.43	PK
H	7386.00	35.51	9.35	44.86	54.00	-9.14	AV

Remark:

1. Emission Level = Meter Reading + Factor,
 Factor = Antenna Factor + Cable Loss – Pre-amplifier.
 Over = Emission Level - Limit
2. If peak below the average limit, the average emission was no test.
3. In restricted bands of operation, The spurious emissions below the permissible value more than 20dB
4. The amplitude of spurious emissions which are attenuated by more than 20dB below the permissible value has no need to be reported.

802.11n40

Polar (H/V)	Frequency	Reading Level	Correct Factor	Measure- ment	Limits	Over	Detector Type
	(MHz)	(dBuV/m)	(dB)	(dBuV/m)	(dBuV/ m)	(dB)	
Low channel:2422MHz							
V	4844.00	54.79	-0.43	54.36	74.00	-19.64	PK
V	4844.00	46.39	-0.43	45.96	54.00	-8.04	AV
V	7266.00	46.70	8.31	55.01	74.00	-18.99	PK
V	7266.00	37.35	8.31	45.66	54.00	-8.34	AV
H	4844.00	52.54	-0.43	52.11	74.00	-21.89	PK
H	4844.00	42.39	-0.43	41.96	54.00	-12.04	AV
H	7266.00	43.87	8.31	52.18	74.00	-21.82	PK
H	7266.00	36.25	8.31	44.56	54.00	-9.44	AV
Middle channel:2437MHz							
V	4874.00	50.88	-0.38	50.50	74.00	-23.50	PK
V	4874.00	43.77	-0.38	43.39	54.00	-10.61	AV
V	7311.00	41.32	8.83	50.15	74.00	-23.85	PK
V	7311.00	31.61	8.83	40.44	54.00	-13.56	AV
H	4874.00	46.20	-0.38	45.82	74.00	-28.18	PK
H	4874.00	36.40	-0.38	36.02	54.00	-17.98	AV
H	7311.00	39.06	8.83	47.89	74.00	-26.11	PK
H	7311.00	30.11	8.83	38.94	54.00	-15.06	AV
High channel:2452MHz							
V	4904.00	52.21	-0.32	51.89	74.00	-22.11	PK
V	4904.00	43.28	-0.32	42.96	54.00	-11.04	AV
V	7356.00	44.30	9.35	53.65	74.00	-20.35	PK
V	7356.00	34.94	9.35	44.29	54.00	-9.71	AV
H	4904.00	49.69	-0.32	49.37	74.00	-24.63	PK
H	4904.00	39.18	-0.32	38.86	54.00	-15.14	AV
H	7356.00	42.88	9.35	52.23	74.00	-21.77	PK
H	7356.00	35.79	9.35	45.14	54.00	-8.86	AV

Remark:

1. Emission Level = Meter Reading + Factor,
Factor = Antenna Factor + Cable Loss – Pre-amplifier.
Over = Emission Level - Limit
2. If peak below the average limit, the average emission was no test.
3. In restricted bands of operation, The spurious emissions below the permissible value more than 20dB
4. The amplitude of spurious emissions which are attenuated by more than 20dB below the permissible value has no need to be reported.

8. RADIATED BAND EMISSION MEASUREMENT AND RESTRICTED BANDS OF OPERATION

8.1 Block Diagram Of Test Setup

Radiated Emission Test-Up Frequency Above 1GHz

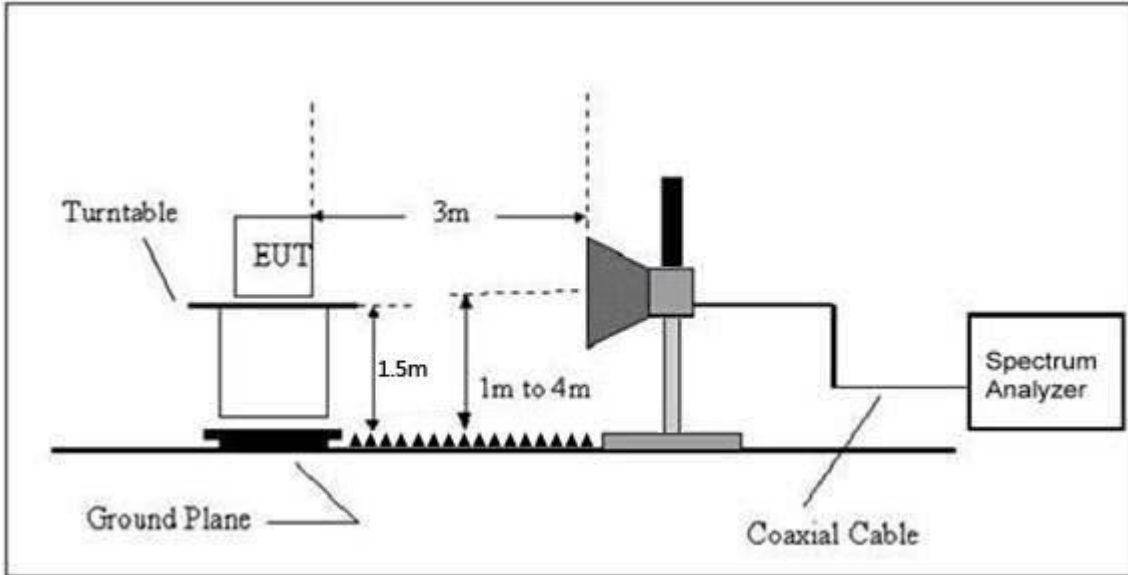

8.2 Limit

FCC Part15 C Section 15.209 and 15.205

(a) Except as shown in paragraph (d) of this section, only spurious emissions are permitted in any of the frequency bands listed below:

MHz	MHz	MHz	GHz
0.090-0.110	16.42-16.423	399.9-410	4.5-5.15
0.495-0.505	16.69475-16.69525	608-614	5.35-5.46
2.1735-2.1905	16.80425-16.80475	960-1240	7.25-7.75
4.125-4.128	25.5-25.67	1300-1427	8.025-8.5
4.17725-4.17775	37.5-38.25	1435-1626.5	9.0-9.2
4.20725-4.20775	73-74.6	1645.5-1646.5	9.3-9.5
6.215-6.218	74.8-75.2	1660-1710	10.6-12.7
6.26775-6.26825	108-121.94	1718.8-1722.2	13.25-13.4
6.31175-6.31225	123-138	2200-2300	14.47-14.5
8.291-8.294	149.9-150.05	2310-2390	15.35-16.2
8.362-8.366	156.52475-156.52525	2483.5-2500	17.7-21.4
8.37625-8.38675	156.7-156.9	2690-2900	22.01-23.12
8.41425-8.41475	162.0125-167.17	3260-3267	23.6-24.0
12.29-12.293	167.72-173.2	3332-3339	31.2-31.8
12.51975-12.52025	240-285	3345.8-3358	36.43-36.5
12.57675-12.57725	322-335.4	3600-4400	(2)
13.36-13.41			

LIMITS OF RADIATED EMISSION MEASUREMENT (Above 1000MHz)

FREQUENCY (MHz)	Limit (dBuV/m) (at 3M)	
	PEAK	AVERAGE
Above 1000	74	54

Notes:

- (1) The limit for radiated test was performed according to FCC PART 15C.
- (2) The tighter limit applies at the band edges.
- (3) Emission level (dBuV/m) = 20log Emission level (uV/m).

8.3 Test procedure

Receiver Parameter	Setting
Attenuation	Auto
Start Frequency	2300MHz
Stop Frequency	2520
RB / VB (emission in restricted band)	1 MHz / 1 MHz for Peak, 1 MHz / 10Hz for Average

Above 1GHz test procedure as below:

- a. The EUT was placed on the top of a rotating table 1.5 meters above the ground at a 3 meter camber. The table was rotated 360 degrees to determine the position of the highest radiation.
- b. The EUT was set 3 meters away from the interference-receiving antenna, which was mounted on the top of a variable-height antenna tower.
- c. The antenna height is varied from one meter to four meters above the ground to determine the maximum value of the field strength. Both horizontal and vertical polarizations of the antenna are set to make the measurement.
- d. For each suspected emission, the EUT was arranged to its worst case and then the antenna was tuned to heights from 1 meter to 4 meters and the rota table was turned from 0 degrees to 360 degrees to find the maximum reading.
- e. The test-receiver system was set to Peak Detect Function and Specified Bandwidth with Maximum Hold Mode.
- f. If the emission level of the EUT in peak mode was 10dB lower than the limit specified, then testing could be stopped and the peak values of the EUT would be reported. Otherwise the emissions that did not have 10dB margin would be re-tested one by one using peak, quasi-peak or average method as specified and then reported in a data sheet.
- g. Test the EUT in the lowest channel, the Highest channel.

Note:

Both horizontal and vertical antenna polarities were tested and performed pretest to three orthogonal axis. The worst case emissions were reported.

8.4 EUT operating Conditions

The EUT was configured for testing in a typical fashion (as a customer would normally use it). The EUT has been programmed to continuously transmit during test. This operating condition was tested and used to collect the included data.

8.5 Test Result

	Polar (H/V)	Frequency (MHz)	Reading Level (dBuV/m)	Correct Factor (dB)	Measurement (dBuV/m)	Limits (dBuV/m)		Result	
					PK	PK	AV		
802.11b	Low Channel 2412MHz								
	H	2390.00	57.30	-6.70	50.60	74.00	54.00	PASS	
	H	2400.00	49.87	-6.71	43.16	74.00	54.00	PASS	
	V	2390.00	58.20	-6.70	51.50	74.00	54.00	PASS	
	V	2400.00	50.50	-6.71	43.79	74.00	54.00	PASS	
	High Channel 2462MHz								
	H	2483.50	57.63	-6.79	50.84	74.00	54.00	PASS	
	H	2485.00	48.49	-6.81	41.68	74.00	54.00	PASS	
	V	2483.50	57.68	-6.79	50.89	74.00	54.00	PASS	
	V	2485.00	49.71	-6.81	42.90	74.00	54.00	PASS	
	802.11g	Low Channel 2412MHz							
		H	2390.00	56.73	-6.70	50.03	74.00	54.00	PASS
H		2400.00	49.36	-6.71	42.65	74.00	54.00	PASS	
V		2390.00	55.90	-6.70	49.20	74.00	54.00	PASS	
V		2400.00	48.05	-6.71	41.34	74.00	54.00	PASS	
High Channel 2462MHz									
H		2483.50	57.02	-6.79	50.23	74.00	54.00	PASS	
H		2485.00	47.84	-6.81	41.03	74.00	54.00	PASS	
V		2483.50	55.93	-6.79	49.14	74.00	54.00	PASS	
V		2485.00	47.67	-6.81	40.86	74.00	54.00	PASS	

Remark:

1. Emission Level = Meter Reading + Factor,
Factor = Antenna Factor + Cable Loss – Pre-amplifier.
Over= Emission Level - Limit
2. If the PK measured levels comply with average limit, then the average level were deemed to comply with average limit.
- 3 In restricted bands of operation, The spurious emissions below the permissible value more than 20dB
4. The amplitude of spurious emissions which are attenuated by more than 20dB below the permissible value has no need to be reported.

	Polar (H/V)	Frequency (MHz)	Reading Level (dBuV/m)	Correct Factor (dB)	Measurement (dBuV/m)	Limits (dBuV/m)		Result	
					PK	PK	AV		
802.11 n20	Low Channel 2412MHz								
	H	2390.00	57.85	-6.70	51.15	74.00	54.00	PASS	
	H	2400.00	49.13	-6.71	42.42	74.00	54.00	PASS	
	V	2390.00	58.41	-6.70	51.71	74.00	54.00	PASS	
	V	2400.00	49.87	-6.71	43.16	74.00	54.00	PASS	
	High Channel 2462MHz								
	H	2483.50	57.20	-6.79	50.41	74.00	54.00	PASS	
	H	2500.00	48.85	-6.81	42.04	74.00	54.00	PASS	
	V	2483.50	57.66	-6.79	50.87	74.00	54.00	PASS	
	V	2500.00	49.16	-6.81	42.35	74.00	54.00	PASS	
	802.11 n40	Low Channel 2422MHz							
		H	2390.00	56.66	-6.70	49.96	74.00	54.00	PASS
H		2400.00	47.87	-6.71	41.16	74.00	54.00	PASS	
V		2390.00	56.25	-6.70	49.55	74.00	54.00	PASS	
V		2400.00	48.23	-6.71	41.52	74.00	54.00	PASS	
High Channel 2452MHz									
H		2483.50	56.54	-6.79	49.75	74.00	54.00	PASS	
H		2500.00	48.80	-6.81	41.99	74.00	54.00	PASS	
V		2483.50	54.96	-6.79	48.17	74.00	54.00	PASS	
V		2500.00	46.93	-6.81	40.12	74.00	54.00	PASS	

Remark:

1. Emission Level = Meter Reading + Factor,
Factor = Antenna Factor + Cable Loss – Pre-amplifier.
Over= Emission Level - Limit
2. If the PK measured levels comply with average limit, then the average level were deemed to comply with average limit.
- 3 In restricted bands of operation, The spurious emissions below the permissible value more than 20dB
4. The amplitude of spurious emissions which are attenuated by more than 20dB below the permissible value has no need to be reported.

9. POWER SPECTRAL DENSITY TEST

9.1 Block Diagram Of Test Setup

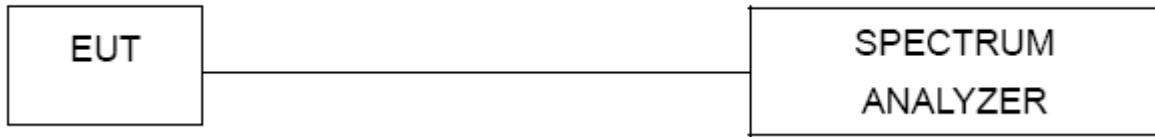

9.2 Limit

FCC Part15 (15.247) , Subpart C				
Section	Test Item	Limit	Frequency Range (MHz)	Result
15.247	Power Spectral Density	8 dBm (in any 3KHz)	2400-2483.5	PASS

LIMITS OF RADIATED EMISSION MEASUREMENT (Above 1000MHz)

9.3 Test procedure

1. Set analyzer center frequency to DTS channel center frequency.
2. Set the span to 1.5 times the DTS bandwidth.
3. Set the RBW to: 3 kHz
4. Set the VBW $\geq 3 \times$ RBW.
5. Detector = peak.
6. Sweep time = auto couple.
7. Trace mode = max hold.
8. Allow trace to fully stabilize.
9. Use the peak marker function to determine the maximum amplitude level within the RBW.
10. If measured value exceeds limit, reduce RBW (no less than 3 kHz) and repeat.

9.4 EUT operating Conditions

The EUT tested system was configured as the statements of 4.6 Unless otherwise a special operating condition is specified in the follows during the testing.

Note: Power Spectral Density(dBm)=Reading+Cable Loss

9.5 Test Result

Temperature :	26°C	Relative Humidity :	54%
Pressure :	101kPa	Test Voltage :	AC120V/60Hz
Test Mode :	TX b Mode		

Frequency	Power Spectral Density(dBm/3k Hz)	Limit (dBm/3kHz)	Result
2412 MHz	-17.310	8	PASS
2437 MHz	-17.558	8	PASS
2462 MHz	-17.791	8	PASS

TX CH01

