



RADIO TEST REPORT

Test Report No. : 12742873H-A-R1

Applicant : Sumitomo Wiring Systems, Ltd.
Type of Equipment : UNIT ASSY, BCM
Model No. : HAR0004
FCC ID : 2AKB8HAR0004
Test regulation : FCC Part 15 Subpart C: 2018
Test Result : Complied (Refer to SECTION 3.2)

1. This test report shall not be reproduced in full or partial, without the written approval of UL Japan, Inc.
2. The results in this report apply only to the sample tested.
3. This sample tested is in compliance with above regulation.
4. The test results in this report are traceable to the national or international standards.
5. This test report covers Radio technical requirements. It does not cover administrative issues such as Manual or non-Radio test related Requirements. (if applicable)
6. The all test items in this test report are conducted by UL Japan, Inc. Ise EMC Lab.
7. This test report must not be used by the customer to claim product certification, approval, or endorsement by NVLAP, NIST, or any agency of the Federal Government.
8. The information provided from the customer for this report is identified in SECTION 1.
9. This report is a revised version of 12742873H-A. 12742873H-A is replaced with this report.

Date of test: March 20 to April 18, 2019

Representative test engineer: K. Yamamoto
Koji Yamamoto
Engineer
Consumer Technology Division

Approved by: S. Miyazono
Shinichi Miyazono
Engineer
Consumer Technology Division

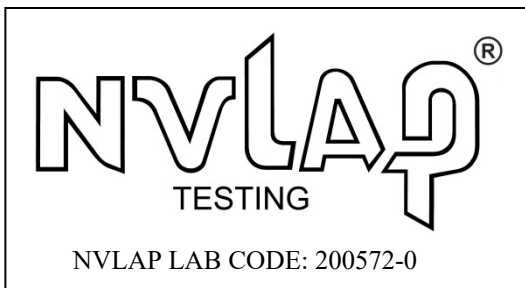

This laboratory is accredited by the NVLAP LAB CODE 200572-0, U.S.A. The tests reported herein have been performed in accordance with its terms of accreditation.
*As for the range of Accreditation in NVLAP, you may refer to the WEB address,
http://japan.ul.com/resources/emc_accredited/

- The testing in which "Non-accreditation" is displayed is outside the accreditation scopes in UL Japan.
 There is no testing item of "Non-accreditation".

UL Japan, Inc.
Ise EMC Lab.

4383-326 Asama-cho, Ise-shi, Mie-ken 516-0021 JAPAN
Telephone : +81 596 24 8999
Facsimile : +81 596 24 8124

REVISION HISTORY

Original Test Report No.: 12742873H-A

Revision	Test report No.	Date	Page revised	Contents
- (Original)	12742873H-A	May 9, 2019	-	-
1	12742873H-A-R1	May 20, 2019	P.4	Addition of "Coil Antenna" to Antenna type in Clause 2.2
1	12742873H-A-R1	May 20, 2019	P.4	Correction of Receiver Bandwidth in Clause 2.2
1	12742873H-A-R1	May 20, 2019	P.4	Addition of Intermediate Frequency in Clause 2.2

CONTENTS	PAGE
SECTION 1: Customer information	4
SECTION 2: Equipment under test (E.U.T.).....	4
SECTION 3: Test specification, procedures & results	5
SECTION 4: Operation of E.U.T. during testing.....	8
SECTION 5: Radiated emission (Fundamental and Spurious Emission).....	10
SECTION 6: -26dB Bandwidth.....	13
SECTION 7: 99% Occupied Bandwidth.....	13
APPENDIX 1: Test data	14
Radiated Emission below 30 MHz (Fundamental and Spurious Emission)	14
Radiated Emission above 30 MHz (Spurious Emission).....	18
-26 dB Bandwidth and 99 % Occupied Bandwidth	21
APPENDIX 2: Test instruments	24
APPENDIX 3: Photographs of test setup.....	25
Radiated Emission.....	25
Worst Case Position	26

UL Japan, Inc.

Ise EMC Lab.

4383-326 Asama-cho, Ise-shi, Mie-ken 516-0021 JAPAN

Telephone : +81 596 24 8999

Facsimile : +81 596 24 8124

SECTION 1: Customer information

Company Name : Sumitomo Wiring Systems, Ltd.
Address : 1820 Nakanoike, Mikkaichi-cho, Suzuka-City, Mie Pref. 513-8631
JAPAN
Telephone Number : +81-59-382-8711
Facsimile Number : +81-59-383-3943
Contact Person : Mamoru Nakanishi

The information provided from the customer is as follows;

- Applicant, Type of Equipment, Model No. on the cover and other relevant pages
- SECTION 1: Customer information
- SECTION 2: Equipment under test (E.U.T.)
- SECTION 4: Operation of E.U.T. during testing

* The laboratory is exempted from liability of any test results affected from the above information in SECTION 2 and 4.

SECTION 2: Equipment under test (E.U.T.)

2.1 Identification of E.U.T.

Type of Equipment : UNIT ASSY, BCM
Model No. : HAR0004
Serial No. : Refer to Section 4, Clause 4.2
Rating : DC 12 V
Receipt Date of Sample : February 24, 2019
(Information from test lab.)
Country of Mass-production : United States of America , China , Thailand, Japan
Condition of EUT : Production prototype
(Not for Sale: This sample is equivalent to mass-produced items.)
Modification of EUT : No Modification by the test lab

2.2 Product Description

Model No: HAR0004 (referred to as the EUT in this report) is the UNIT ASSY, BCM.

General Specification

Clock frequencies in the system : LF Transmitter: 9.000 MHz
RF Receiver: 24.305 MHz

Radio Specification

[LF Transmitter]

Radio Type : Transmitter
Frequency of Operation : 125 kHz
Modulation : OOK (ASK)
Antenna Type : BAR Antenna, COIL Antenna

[RF Receiver]*

Radio Type : Receiver
Frequency of Operation : 433.92 MHz
Receiver Bandwidth : ±146 kHz
Intermediate Frequency : 250 kHz

*The test of receiver part was performed separately from this test report, and the conformability is confirmed.

UL Japan, Inc.

Ise EMC Lab.

4383-326 Asama-cho, Ise-shi, Mie-ken 516-0021 JAPAN

Telephone : +81 596 24 8999

Facsimile : +81 596 24 8124

SECTION 3: Test specification, procedures & results

3.1 Test Specification

Test Specification : FCC Part 15 Subpart C
FCC Part 15 final revised on March 12, 2018 and effective April 11, 2018

Title : FCC 47CFR Part15 Radio Frequency Device Subpart C Intentional Radiators
Section 15.207 Conducted limits
Section 15.209 Radiated emission limits; general requirements.

* Also the EUT complies with FCC Part 15 Subpart B.

3.2 Procedures and results

Item	Test Procedure	Specification	Remarks	Deviation	Worst margin	Results
Conducted Emission	<FCC> ANSI C63.10:2013 6 Standard test methods <IC> RSS-Gen 8.8	<FCC> Section 15.207 <IC> RSS-Gen 8.8	-	N/A	N/A *1)	N/A
Electric Field Strength of Fundamental Emission	<FCC> ANSI C63.10:2013 6 Standard test methods <IC> RSS-Gen 6.5, 6.12	<FCC> Section 15.209 <IC> RSS-210 4.4 RSS-Gen 8.9	Radiated	N/A	2.2 dB 125 kHz, 0 deg. PK with Duty factor	Complied# a)
Electric Field Strength of Spurious Emission	<FCC> ANSI C63.10:2013 6 Standard test methods <IC> RSS-Gen 6.5, 6.6, 6.13	<FCC> Section 15.209 <IC> RSS-210 4.4 RSS-Gen 8.9	Radiated	N/A	12.36 dB 297.348 MHz, Horizontal, QP	Complied a)
-26dB Bandwidth	<FCC> ANSI C63.10:2013 6 Standard test methods <IC> -	<FCC> Reference data <IC> -	Radiated	N/A	N/A	Complied b)
Note: UL Japan, Inc.'s EMI Work Procedures No. 13-EM-W0420 and 13-EM-W0422.						
*1) The test is not applicable since the EUT is not the device that is designed to be connected to the public utility (AC) power line.						
a) Refer to APPENDIX 1 (data of Radiated emission)						
b) Refer to APPENDIX 1 (data of -26 dB Bandwidth and 99 % Occupied Bandwidth)						
Symbols:						
Complied The data of this test item has enough margin, more than the measurement uncertainty.						
Complied# The data of this test item meets the limits unless the measurement uncertainty is taken into consideration.						

FCC Part 15.31 (e)

This EUT provides stable voltage constantly to RF Part regardless of input voltage. Therefore, this EUT complies with the requirement.

FCC Part 15.203 Antenna requirement

It is impossible for end users to replace the antenna, because the antenna is mounted inside of the vehicle. Therefore, the equipment complies with the antenna requirement of Section 15.203.

UL Japan, Inc.

Ise EMC Lab.

4383-326 Asama-cho, Ise-shi, Mie-ken 516-0021 JAPAN

Telephone : +81 596 24 8999

Facsimile : +81 596 24 8124

3.3 Addition to standard

Item	Test Procedure	Specification	Remarks	Deviation	Worst margin	Results
99 % Occupied Band Width	RSS-Gen 6.7	-	Radiated	N/A	N/A	-
Note: UL Japan, Inc.'s EMI Work Procedures No. 13-EM-W0420 and 13-EM-W0422.						

Other than above, no addition, exclusion nor deviation has been made from the standard.

3.4 Uncertainty

There is no applicable rule of uncertainty in this applied standard. Therefore, the following results are derived depending on whether or not laboratory uncertainty is applied.

The following uncertainties have been calculated to provide a confidence level of 95% using a coverage factor k=2.

Test distance	Radiated emission (+/-)
	9 kHz to 30 MHz
3 m	3.3 dB
10 m	3.2 dB

*Measurement distance

Polarity	Radiated emission (Below 1 GHz)			
	(3 m*)(+/-)		(10 m*)(+/-)	
	30 MHz to 200 MHz	200 MHz to 1000 MHz	30 MHz to 200 MHz	200 MHz to 1000 MHz
Horizontal	4.8 dB	5.2 dB	4.8 dB	5.0 dB
Vertical	5.0 dB	6.3 dB	4.9 dB	5.0 dB

Radiated emission (Above 1 GHz)				
(3 m*)(+/-)		(1 m*)(+/-)		(10 m*)(+/-)
1 GHz to 6 GHz	6 GHz to 18 GHz	10 GHz to 26.5 GHz	26.5 GHz to 40 GHz	1 GHz to 18 GHz
5.0 dB	5.3 dB	5.8 dB	5.8 dB	5.2 dB

* Measurement distance

Bandwidth
0.96 %

3.5 Test Location

UL Japan, Inc. Ise EMC Lab.
4383-326 Asama-cho, Ise-shi, Mie-ken 516-0021 JAPAN
Telephone: +81 596 24 8999, Facsimile: +81 596 24 8124
NVLAP Lab. code: 200572-0 / FCC Test Firm Registration Number: 199967

Test site	IC Registration Number	Width x Depth x Height (m)	Size of reference ground plane (m) / horizontal conducting plane	Other rooms	Maximum measurement distance
No.1 semi-anechoic chamber	2973C-1	19.2 x 11.2 x 7.7	7.0 x 6.0	No.1 Power source room	10 m
No.2 semi-anechoic chamber	2973C-2	7.5 x 5.8 x 5.2	4.0 x 4.0	-	3 m
No.3 semi-anechoic chamber	2973C-3	12.0 x 8.5 x 5.9	6.8 x 5.75	No.3 Preparation room	3 m
No.3 shielded room	-	4.0 x 6.0 x 2.7	N/A	-	-
No.4 semi-anechoic chamber	2973C-4	12.0 x 8.5 x 5.9	6.8 x 5.75	No.4 Preparation room	3 m
No.4 shielded room	-	4.0 x 6.0 x 2.7	N/A	-	-
No.5 semi-anechoic chamber	-	6.0 x 6.0 x 3.9	6.0 x 6.0	-	-
No.6 shielded room	-	4.0 x 4.5 x 2.7	4.0 x 4.5	-	-
No.6 measurement room	-	4.75 x 5.4 x 3.0	4.75 x 4.15	-	-
No.7 shielded room	-	4.7 x 7.5 x 2.7	4.7 x 7.5	-	-
No.8 measurement room	-	3.1 x 5.0 x 2.7	3.1 x 5.0	-	-
No.9 measurement room	-	8.8 x 4.6 x 2.8	2.4 x 2.4	-	-
No.11 measurement room	-	6.2 x 4.7 x 3.0	4.8 x 4.6	-	-

* Size of vertical conducting plane (for Conducted Emission test) : 2.0 m x 2.0m for No.1, No.2, No.3, and No.4 semi-anechoic chambers and No.3 and No.4 shielded rooms.

3.6 Test data, Test instruments, and Test set up

Refer to APPENDIX.

SECTION 4: Operation of E.U.T. during testing

4.1 Operating Modes

Test mode	Remarks
Transmitting mode (Tx) 125 kHz	-

Justification : The system was configured in typical fashion (as a user would normally use it) for testing.

4.2 Configuration and peripherals

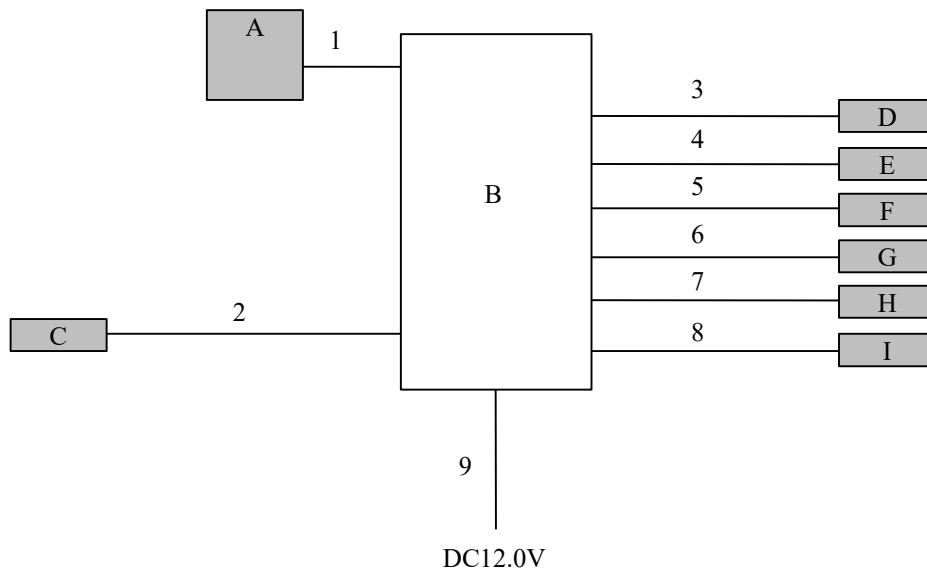

* Cabling and setup were taken into consideration and test data was taken under worse case conditions.

* The EUT does not transmit simultaneously from multiple antennas.

* Antenna was evaluated with the worst duty respectively.

* The EUT was set to transmit the data continuously from one antenna as a worst case, not to transmit it randomly from each antenna.

* According to the result of pre-check to five antennas(M, F, TR, FRAS, FRDR), it was confirmed that there was no difference in RF characteristics among antennas.

* The test was performed with LF Antenna M as a representative.

UL Japan, Inc.

Ise EMC Lab.

4383-326 Asama-cho, Ise-shi, Mie-ken 516-0021 JAPAN

Telephone : +81 596 24 8999

Facsimile : +81 596 24 8124

Description of EUT and Support equipment

No.	Item	Model number	Serial number	Manufacturer	Remark
A	UNIT ASSY, BCM	HAR0004	001	Sumitomo Wiring Systems, Ltd.	EUT
B	Checker Box	TVA-001	-	Sumitomo Wiring Systems, Ltd.	-
C	Start Button	35881-TBA-A010-M1	290616AG G400041A	Sumitomo Wiring Systems, Ltd.	EUT
D	LF Antenna (R)	38387-T00-Z010-M1	001	Sumitomo Wiring Systems, Ltd.	EUT
E	LF Antenna (M)	38387-TVA-A310-M1	R16MC644007	Sumitomo Wiring Systems, Ltd.	EUT
F	LF Antenna (F)	38387-TVA-A310-M1	R16MC644031	Sumitomo Wiring Systems, Ltd.	EUT
G	LF Antenna (TR)	38387-TVA-A310-M1	R16MC644015	Sumitomo Wiring Systems, Ltd.	EUT
H	LF Antenna (FRAS)	38387-TVA-A310-M1	R16MC6510008	Sumitomo Wiring Systems, Ltd.	EUT
I	LF Antenna (FRDR)	38387-TVA-A310-M1	R16MC6510043	Sumitomo Wiring Systems, Ltd.	EUT

List of cables used

No.	Name	Length (m)	Shield		Remark
			Cable	Connector	
1	Signal Cable	2.5	Unshielded	Unshielded	-
2	Antenna Cable	2.5	Unshielded	Unshielded	-
3	Antenna Cable	2.5	Unshielded	Unshielded	-
4	Antenna Cable	2.5	Unshielded	Unshielded	-
5	Antenna Cable	2.5	Unshielded	Unshielded	-
6	Antenna Cable	2.5	Unshielded	Unshielded	-
7	Antenna Cable	2.5	Unshielded	Unshielded	-
8	Antenna Cable	2.5	Unshielded	Unshielded	-
9	DC Cable	0.9	Unshielded	Unshielded	-

UL Japan, Inc.

Ise EMC Lab.

4383-326 Asama-cho, Ise-shi, Mie-ken 516-0021 JAPAN

Telephone : +81 596 24 8999

Facsimile : +81 596 24 8124

SECTION 5: Radiated emission (Fundamental and Spurious Emission)

Test Procedure

EUT was placed on a urethane platform of nominal size, 0.5 m by 1.0 m, raised 0.8 m above the conducting ground plane.

The Radiated Electric Field Strength has been measured in a Semi Anechoic Chamber with a ground plane.

Frequency : From 9 kHz to 30 MHz

The EUT was rotated a full revolution in order to obtain the maximum value of the electric field intensity.

The measurements were performed for vertical polarization (antenna angle: 0 deg., 45 deg., 90 deg., and 135 deg.) and horizontal polarization.

*Refer to Figure 1 about Direction of the Loop Antenna.

Frequency: From 30 MHz to 1 GHz

The measuring antenna height varied between 1 and 4 m and EUT was rotated a full revolution in order to obtain the maximum value of the electric field intensity.

The measurements were performed for both vertical and horizontal antenna polarization.

The test was made with the detector (RBW / VBW) in the following table.

When using Spectrum analyzer, the test was made with adjusting span to zero by using peak hold.

Test Antennas are used as below;

Frequency	Below 30 MHz	30 MHz to 200 MHz	200 MHz to 1 GHz
Antenna Type	Loop	Biconical	Logperiodic

Frequency	From 9 kHz to 90 kHz and From 110 kHz to 150 kHz	From 90 kHz to 110 kHz	From 150 kHz to 490 kHz	From 490 kHz to 30 MHz	From 30 MHz to 1 GHz
Instrument used	Test Receiver				
Detector	PK / AV	QP	PK / AV	QP	QP
IF Bandwidth	200 Hz	200 Hz	9 kHz	9 kHz	120 kHz
Test Distance	3 m *1)	3 m *1)	3 m *1)	3 m *2)	3 m

*1) Distance Factor: $40 \times \log(3 \text{ m} / 300 \text{ m}) = -80 \text{ dB}$

*2) Distance Factor: $40 \times \log(3 \text{ m} / 30 \text{ m}) = -40 \text{ dB}$

Although these tests were performed other than open field test site, adequate comparison measurements were confirmed against 30 m open field test site. Therefore sufficient tests were made to demonstrate that the alternative site produces results that correlate with the ones of tests made in an open field based on KDB 414788.

These tests were performed in semi anechoic chamber. Therefore the measured level of emissions may be higher than if measurements were made without a ground plane.

However test results were confirmed to pass against standard limit.

UL Japan, Inc.

Ise EMC Lab.

4383-326 Asama-cho, Ise-shi, Mie-ken 516-0021 JAPAN

Telephone : +81 596 24 8999

Facsimile : +81 596 24 8124

[Test Setup]
Below 1 GHz

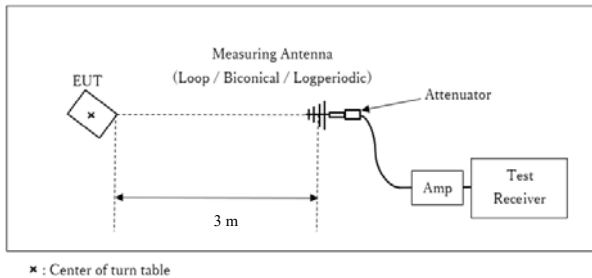

Test Distance: 3 m

- The carrier level and noise levels were confirmed at each position of X, Y and Z axes of EUT to see the position of maximum noise, and the test was made at the position that has the maximum noise.

This EUT has two modes which transponder key is inserted or not. The worst case was confirmed with and without transponder key, as a result, the test without transponder key was the worst case. Therefore the test without transponder key was performed only.

The test results and limit are rounded off to one decimal place, so some differences might be observed.

Measurement range : 9 kHz - 1 GHz
Test data : APPENDIX 1
Test result : Pass

Date: March 20, 2019
April 10, 2019

Test engineer: Koji Yamamoto
Tomohisa Nakagawa

Figure 1: Direction of the Loop Antenna

Side View (Vertical)

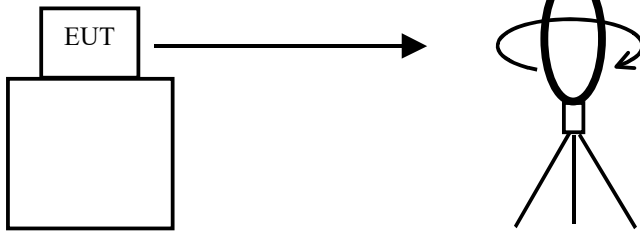

.....
Top View (Horizontal)

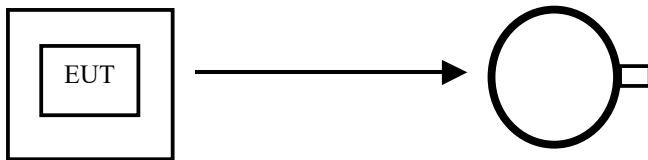

Antenna was not rotated.

.....
Top View (Vertical)

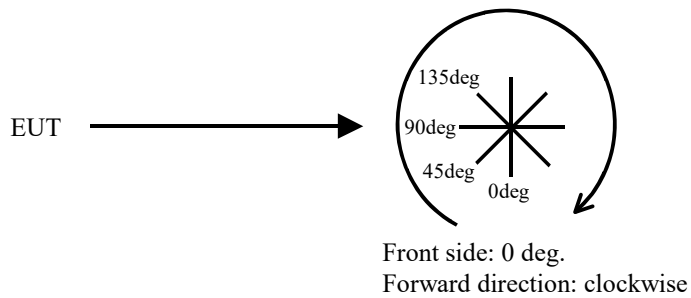

SECTION 6: -26dB Bandwidth

Test Procedure

The test was measured with a spectrum analyzer using a test fixture.

< LF Antenna (M) >

Test	Span	RBW	VBW	Sweep	Detector	Trace	Instrument used
-26 dB Bandwidth	80 kHz	130 Hz	390 kHz	Auto	Peak	Max Hold	Spectrum Analyzer

< LF Antenna (R) >

Test	Span	RBW	VBW	Sweep	Detector	Trace	Instrument used
-26 dB Bandwidth	110 kHz	820 Hz	2.4 kHz	Auto	Peak	Max Hold	Spectrum Analyzer

< Start Button >

Test	Span	RBW	VBW	Sweep	Detector	Trace	Instrument used
-26 dB Bandwidth	90 kHz	110 Hz	330 kHz	Auto	Peak	Max Hold	Spectrum Analyzer

Test data : APPENDIX 1
Test result : Pass

SECTION 7: 99% Occupied Bandwidth

Test Procedure

The test was measured with a spectrum analyzer using a test fixture.

Test	Span	RBW	VBW	Sweep	Detector	Trace	Instrument used
99 % Occupied Bandwidth	Enough width to display emission skirts	1 to 5 % of OBW	Three times of RBW	Auto	Peak *1)	Max Hold *1)	Spectrum Analyzer

*1) The measurement was performed with Peak detector, Max Hold since the duty cycle was not 100 %.
Peak hold was applied as Worst-case measurement.

Test data : APPENDIX 1
Test result : Pass

UL Japan, Inc.

Ise EMC Lab.

4383-326 Asama-cho, Ise-shi, Mie-ken 516-0021 JAPAN

Telephone : +81 596 24 8999

Facsimile : +81 596 24 8124

APPENDIX 1: Test data

Radiated Emission below 30 MHz (Fundamental and Spurious Emission)

Report No. 12742873H
Test place Ise EMC Lab. No.4 Semi Anechoic Chamber
Date March 20, 2019
Temperature/ Humidity 21 deg. C / 35 % RH
Engineer Koji Yamamoto
Mode Tx 125 kHz, LF Antenna (M)

PK or QP

Ant Deg [deg] or Polarity [Hori/Vert]	Frequency [MHz]	Detector	Reading [dBuV]	Ant Factor [dB/m]	Loss [dB]	Gain [dB]	Duty Factor [dB]	Result [dBuV/m]	Limit [dBuV/m]	Margin [dB]	Remark
0deg	0.125	PK	105.8	19.7	-69.9	32.2	-	23.4	45.6	22.2	Fundamental
0deg	0.250	PK	78.7	19.7	-69.9	32.2	-	-3.7	39.6	43.3	
0deg	0.375	PK	67.4	19.6	-69.9	32.2	-	-15.0	36.1	51.1	
0deg	0.500	QP	35.9	19.6	-29.8	32.1	-	-6.4	33.6	40.0	
0deg	0.625	QP	39.8	19.6	-29.8	32.2	-	-2.5	31.7	34.2	
0deg	0.750	QP	28.4	19.6	-29.8	32.2	-	-14.0	30.1	44.1	
0deg	0.875	QP	33.6	19.6	-29.8	32.2	-	-8.8	28.7	37.5	
0deg	1.000	QP	27.5	19.6	-29.8	32.2	-	-14.9	27.6	42.5	
0deg	1.125	QP	27.1	19.6	-29.8	32.2	-	-15.3	26.5	41.8	
0deg	1.250	QP	26.7	19.6	-29.8	32.2	-	-15.6	25.6	41.2	

Result = Reading + Ant Factor + Loss (Cable + Attenuator + Filter + D.Factor) - Gain(Amplifier)

PK with Duty factor

Ant Deg [deg]	Frequency [MHz]	Detector	Reading [dBuV]	Ant Factor [dB/m]	Loss [dB]	Gain [dB]	Duty Factor [dB]	Result [dBuV/m]	Limit [dBuV/m]	Margin [dB]	Remark
0deg	0.1250	PK	105.8	19.7	-69.9	32.2	0.0	23.4	25.6	2.2	Fundamental
0deg	0.2500	PK	78.7	19.7	-69.9	32.2	0.0	-3.7	19.6	23.3	
0deg	0.3750	PK	67.4	19.6	-69.9	32.2	0.0	-15.0	16.1	31.1	

Result = Reading + Ant Factor + Loss (Cable + Attenuator + Filter + D.Factor) - Gain(Amplifier) + Duty factor *

* Since the peak emission result satisfied the average limit, duty factor was omitted.

Result of the fundamental emission at 3m without Distance factor

PK or QP

Ant Deg [deg]	Frequency [MHz]	Detector	Reading [dBuV]	Ant Factor [dB/m]	Loss [dB]	Gain [dB]	Duty Factor [dB]	Result [dBuV/m]	Limit [dBuV/m]	Margin [dB]	Remark
0	0.1250	PK	105.8	19.7	10.1	32.2	-	103.4	-	-	Fundamental

Result = Reading + Ant Factor + Loss (Cable+Attenuator+Filter) - Gain(Amplifier)

* All spurious emissions lower than this result.

*The test result is rounded off to one or two decimal places, so some differences might be observed.

UL Japan, Inc.

Ise EMC Lab.

4383-326 Asama-cho, Ise-shi, Mie-ken 516-0021 JAPAN

Telephone : +81 596 24 8999

Facsimile : +81 596 24 8124

Radiated Emission below 30 MHz (Fundamental and Spurious Emission)

Report No. 12742873H
Test place Ise EMC Lab. No.4 Semi Anechoic Chamber
Date March 20, 2019
Temperature/ Humidity 21 deg. C / 35 % RH
Engineer Koji Yamamoto
Mode Tx 125 kHz, LF Antenna (R)

PK or QP

Ant Deg [deg] or Polarity [Hori/Vert]	Frequency [MHz]	Detector	Reading [dBuV]	Ant Factor [dB/m]	Loss [dB]	Gain [dB]	Duty Factor [dB]	Result [dBuV/m]	Limit [dBuV/m]	Margin [dB]	Remark
0deg	0.125	PK	99.4	19.7	-69.9	32.2	-	17.0	45.6	28.6	Fundamental
0deg	0.250	PK	65.0	19.7	-69.9	32.2	-	-17.4	39.6	57.0	
0deg	0.375	PK	58.3	19.6	-69.9	32.2	-	-24.1	36.1	60.2	
0deg	0.500	QP	31.6	19.6	-29.8	32.1	-	-10.7	33.6	44.3	
0deg	0.625	QP	35.0	19.6	-29.8	32.2	-	-7.4	31.7	39.1	
0deg	0.750	QP	27.5	19.6	-29.8	32.2	-	-14.9	30.1	45.0	
0deg	0.875	QP	32.9	19.6	-29.8	32.2	-	-9.5	28.7	38.2	
0deg	1.000	QP	27.7	19.6	-29.8	32.2	-	-14.7	27.6	42.3	
0deg	1.125	QP	27.1	19.6	-29.8	32.2	-	-15.3	26.5	41.8	
0deg	1.250	QP	26.9	19.6	-29.8	32.2	-	-15.4	25.6	41.0	

Result = Reading + Ant Factor + Loss (Cable + Attenuator + Filter + D.Factor) - Gain(Amprifier)

PK with Duty factor

Ant Deg [deg]	Frequency [MHz]	Detector	Reading [dBuV]	Ant Factor [dB/m]	Loss [dB]	Gain [dB]	Duty Factor [dB]	Result [dBuV/m]	Limit [dBuV/m]	Margin [dB]	Remark
0deg	0.1250	PK	99.4	19.7	-69.9	32.2	0.0	17.0	25.6	8.6	Fundamental
0deg	0.2500	PK	65.0	19.7	-69.9	32.2	0.0	-17.4	19.6	37.0	
0deg	0.3750	PK	58.3	19.6	-69.9	32.2	0.0	-24.1	16.1	40.2	

Result = Reading + Ant Factor + Loss (Cable + Attenuator + Filter + D.Factor) - Gain(Amprifier) + Duty factor *

* Since the peak emission result satisfied the average limit, duty factor was omitted.

Result of the fundamental emission at 3m without Distance factor

PK or QP

Ant Deg [deg]	Frequency [MHz]	Detector	Reading [dBuV]	Ant Factor [dB/m]	Loss [dB]	Gain [dB]	Duty Factor [dB]	Result [dBuV/m]	Limit [dBuV/m]	Margin [dB]	Remark
0	0.1250	PK	99.4	19.7	10.1	32.2	-	97.0	-	-	Fundamental

Result = Reading + Ant Factor + Loss (Cable+Attenuator+Filter) - Gain(Amprifier)

* All spurious emissions lower than this result.

*The test result is rounded off to one or two decimal places, so some differences might be observed.

UL Japan, Inc.

Ise EMC Lab.

4383-326 Asama-cho, Ise-shi, Mie-ken 516-0021 JAPAN

Telephone : +81 596 24 8999

Facsimile : +81 596 24 8124

Radiated Emission below 30 MHz (Fundamental and Spurious Emission)

Report No. 12742873H
Test place Ise EMC Lab. No.1 Semi Anechoic Chamber
Date April 10, 2019
Temperature/ Humidity 23 deg. C / 31 % RH
Engineer Tomohisa Nakagawa
Mode Tx 125 kHz, Start Button

PK or QP

Ant Deg [deg] or Polarity [Hori/Vert]	Frequency [MHz]	Detector	Reading [dBuV]	Ant Factor [dB/m]	Loss [dB]	Gain [dB]	Duty Factor [dB]	Result [dBuV/m]	Limit [dBuV/m]	Margin [dB]	Remark
0deg	0.125	PK	88.0	19.7	-74.0	32.2	-	1.5	45.6	44.1	Fundamental
0deg	0.250	PK	50.3	19.7	-74.0	32.2	-	-36.2	39.6	75.8	
0deg	0.375	PK	61.6	19.6	-73.9	32.2	-	-24.9	36.1	61.0	
0deg	0.500	QP	32.8	19.6	-33.9	32.1	-	-13.6	33.6	47.2	
0deg	0.625	QP	32.3	19.6	-33.9	32.2	-	-14.1	31.7	45.8	
0deg	0.750	QP	31.6	19.6	-33.9	32.2	-	-14.8	30.1	44.9	
0deg	0.875	QP	31.4	19.6	-33.9	32.2	-	-15.0	28.7	43.7	
0deg	1.000	QP	31.1	19.6	-33.8	32.2	-	-15.3	27.6	42.9	
0deg	1.125	QP	31.1	19.6	-33.8	32.2	-	-15.3	26.5	41.8	
0deg	1.250	QP	31.1	19.6	-33.8	32.2	-	-15.3	25.6	40.9	

Result = Reading + Ant Factor + Loss (Cable + Attenuator + Filter + D.Factor) - Gain(Amplifier)

PK with Duty factor

Ant Deg [deg]	Frequency [MHz]	Detector	Reading [dBuV]	Ant Factor [dB/m]	Loss [dB]	Gain [dB]	Duty Factor [dB]	Result [dBuV/m]	Limit [dBuV/m]	Margin [dB]	Remark
0deg	0.1250	PK	88.0	19.7	-74.0	32.2	0.0	1.5	25.6	24.1	Fundamental
0deg	0.2500	PK	50.3	19.7	-74.0	32.2	0.0	-36.2	19.6	55.8	
0deg	0.3750	PK	61.6	19.6	-73.9	32.2	0.0	-24.9	16.1	41.0	

Result = Reading + Ant Factor + Loss (Cable + Attenuator + Filter + D.Factor) - Gain(Amplifier) + Duty factor *

* Since the peak emission result satisfied the average limit, duty factor was omitted.

Result of the fundamental emission at 3m without Distance factor

PK or QP

Ant Deg [deg]	Frequency [MHz]	Detector	Reading [dBuV]	Ant Factor [dB/m]	Loss [dB]	Gain [dB]	Duty Factor [dB]	Result [dBuV/m]	Limit [dBuV/m]	Margin [dB]	Remark
0	0.1250	PK	88.0	19.7	10.1	32.2	-	85.6	-	-	Fundamental

Result = Reading + Ant Factor + Loss (Cable+Attenuator+Filter) - Gain(Amplifier)

* All spurious emissions lower than this result.

*The test result is rounded off to one or two decimal places, so some differences might be observed.

UL Japan, Inc.

Ise EMC Lab.

4383-326 Asama-cho, Ise-shi, Mie-ken 516-0021 JAPAN

Telephone : +81 596 24 8999

Facsimile : +81 596 24 8124

Radiated Emission below 30 MHz (Fundamental and Spurious Emission)
(Plot data, Worst case)

Report No. 12742873H
Test place Ise EMC Lab. No.4 Semi Anechoic Chamber
Date March 20, 2019
Temperature/ Humidity 21 deg. C / 35 % RH
Engineer Koji Yamamoto
Mode Tx 125 kHz, LF Antenna (M)

Limit : FCC15.209(a), 9-90kHz:PK, 110-490kHz:PK, other:QP

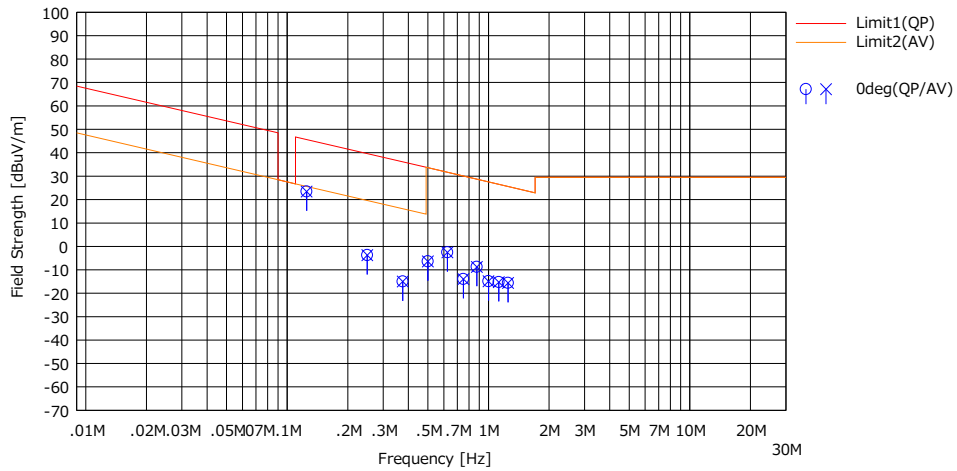

*These plots data contains sufficient number to show the trend of characteristic features for EUT.

UL Japan, Inc.

Ise EMC Lab.

4383-326 Asama-cho, Ise-shi, Mie-ken 516-0021 JAPAN

Telephone : +81 596 24 8999

Facsimile : +81 596 24 8124

Radiated Emission above 30 MHz (Spurious Emission)

Report No. 12742873H
Test place Ise EMC Lab.
Semi Anechoic Chamber No.4
Date March 20, 2019
Temperature / Humidity 21 deg. C / 35 % RH
Engineer Koji Yamamoto
(Below 1 GHz)
Mode Tx 125 kHz, LF Antenna (M)

Limit : FCC15.209 3 m, below 1 GHz:QP, above 1 GHz:AV/PK

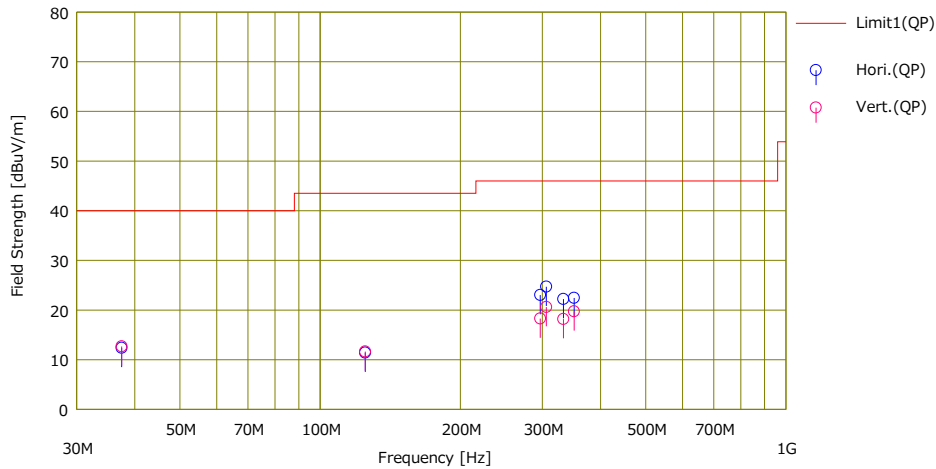

No.	Freq. [MHz]	Reading	AntFoc [dB/m]	Loss [dB]	Gain [dB]	Result	Limit	Margin	Pda. [H/V]	Height [cm]	Angle [deg]	Ant. Type	Comment
		[dBuV]				[dBuV/m]	[QP]	[QP]					
1	37.500	21.57	15.67	7.33	32.19	12.38	40.00	27.62	Hori.	300	0	BC	
2	125.000	21.81	13.23	8.46	32.09	11.41	43.50	32.09	Hori.	300	0	BC	
3	296.954	31.53	13.49	9.94	31.92	23.04	46.00	22.96	Hori.	100	218	LA23	
4	305.950	32.82	13.79	10.00	31.92	24.69	46.00	21.31	Hori.	100	290	LA23	
5	332.940	29.38	14.60	10.16	31.93	22.21	46.00	23.79	Hori.	100	290	LA23	
6	350.938	29.10	15.02	10.28	31.94	22.46	46.00	23.54	Hori.	100	227	LA23	
7	37.500	21.88	15.67	7.33	32.19	12.69	40.00	27.31	Vert.	100	0	BC	
8	125.000	22.03	13.23	8.46	32.09	11.63	43.50	31.87	Vert.	100	0	BC	
9	296.954	26.78	13.49	9.94	31.92	18.29	46.00	27.71	Vert.	100	158	LA23	
10	305.950	28.73	13.79	10.00	31.92	20.60	46.00	25.40	Vert.	100	158	LA23	
11	332.940	25.35	14.60	10.16	31.93	18.18	46.00	27.82	Vert.	100	151	LA23	
12	350.938	26.37	15.02	10.28	31.94	19.73	46.00	26.27	Vert.	100	130	LA23	

CHART: WITH FACTOR

ANT TYPE: - 30 MHz: LOOP, 30 MHz - 200 MHz: BICONICAL, 200 MHz - 1000 MHz: LOGPERIODIC, 1000 MHz -: HORN
CALCULATION: RESULT = READING + ANT FACTOR + LOSS & GAIN (CABLE - GAIN(AMP))

Radiated Emission above 30 MHz (Spurious Emission)

Report No. 12742873H
Test place Ise EMC Lab.
Semi Anechoic Chamber No.4
Date March 20, 2019
Temperature / Humidity 21 deg. C / 35 % RH
Engineer Koji Yamamoto
(Below 1 GHz)
Mode Tx 125 kHz, LF Antenna (R)

Limit : FCC15.209 3 m, below 1 GHz:QP, above 1 GHz:AV/PK

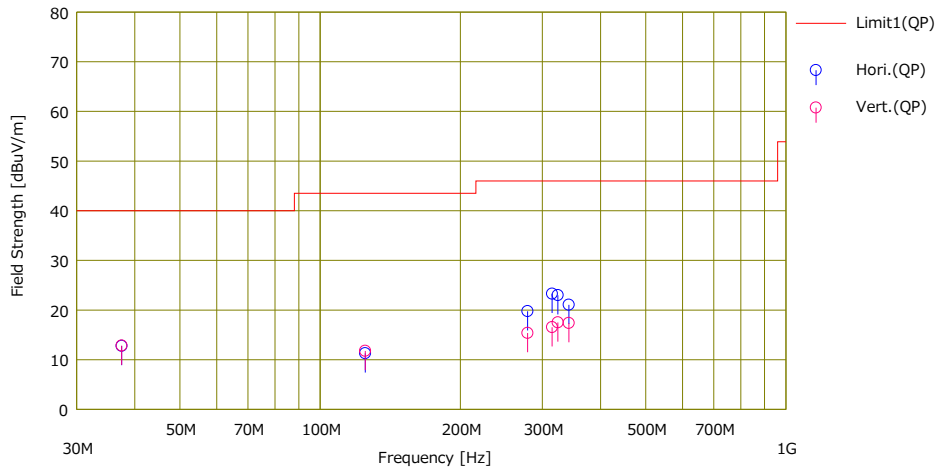

No.	Freq. [MHz]	Reading	AntFoc [dB/m]	Loss [dB]	Gain [dB]	Result	Limit	Margin	Pda. [H/V]	Height [cm]	Angle [deg]	Ant. Type	Comment
		[dBuV]				[dBuV/m]	[dBuV/m]	[dBuV/m]					
1	37.500	21.95	15.67	7.33	32.19	12.76	40.00	27.24	Hori.	300	0	BC	
2	125.000	21.68	13.23	8.46	32.09	11.28	43.50	32.22	Hori.	300	0	BC	
3	278.957	28.66	13.24	9.80	31.93	19.77	46.00	26.23	Hori.	100	215	LA23	
4	314.952	31.11	14.05	10.05	31.92	23.29	46.00	22.71	Hori.	100	108	LA23	
5	323.949	30.53	14.29	10.11	31.93	23.00	46.00	23.00	Hori.	100	313	LA23	
6	341.940	27.89	14.88	10.22	31.93	21.06	46.00	24.94	Hori.	100	226	LA23	
7	37.500	22.02	15.67	7.33	32.19	12.83	40.00	27.17	Vert.	100	0	BC	
8	125.000	22.17	13.23	8.46	32.09	11.77	43.50	31.73	Vert.	100	0	BC	
9	278.957	24.27	13.24	9.80	31.93	15.38	46.00	30.62	Vert.	100	228	LA23	
10	314.952	24.38	14.05	10.05	31.92	16.56	46.00	29.44	Vert.	100	169	LA23	
11	323.949	25.03	14.29	10.11	31.93	17.50	46.00	28.50	Vert.	100	242	LA23	
12	341.940	24.21	14.88	10.22	31.93	17.38	46.00	28.62	Vert.	100	238	LA23	

CHART: WITH FACTOR

ANT TYPE: - 30 MHz: LOOP, 30 MHz - 200 MHz: BICONICAL, 200 MHz - 1000 MHz: LOGPERIODIC, 1000 MHz -: HORN
CALCULATION: RESULT = READING + ANT FACTOR + LOSS & GAIN (CABLE - GAIN(AMP))

UL Japan, Inc.

Ise EMC Lab.

4383-326 Asama-cho, Ise-shi, Mie-ken 516-0021 JAPAN

Telephone : +81 596 24 8999

Facsimile : +81 596 24 8124

Radiated Emission above 30 MHz (Spurious Emission)

Report No. 12742873H
Test place Ise EMC Lab. No.4 Semi Anechoic Chamber
Date April 10, 2019
Temperature/ Humidity 23 deg. C / 31 % RH
Engineer Tomohisa Nakagawa
(Below 1 GHz)
Mode Tx 125 kHz, Start Button

Limit : FCC15.209 3 m, below 1 GHz:QP, above 1 GHz:AV/PK

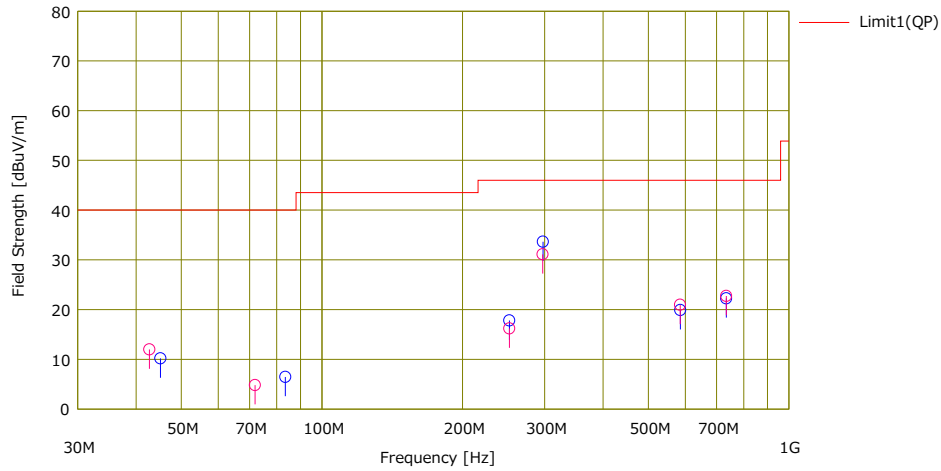

No.	Freq. [MHz]	Reading	AntFac	Loss	Gain	Result	Limit	Margin	Pol.	Height	Angle	Ant. Type	Comment
		(QP) [dBuV]	[dB/m]	[dB]	[dB]	(QP) [dBuV/m]	(QP) [dBuV/m]	(QP) [dB]	[H/V]	[m]	[deg]		
1	45.123	28.70	12.78	7.63	38.94	10.17	40.00	29.83	Hori.	28.3	346	BA	
2	83.521	30.40	6.79	8.31	39.04	6.46	40.00	33.54	Hori.	29.1	7	BA	
3	251.964	34.70	11.84	10.25	39.00	17.79	46.00	28.21	Hori.	100	281	LA20	
4	297.348	48.30	13.57	10.67	38.90	33.64	46.00	12.36	Hori.	100	12	LA20	
5	585.523	26.70	18.82	12.76	38.40	19.88	46.00	26.12	Hori.	100	51	LA20	
6	734.165	26.60	20.33	13.68	38.38	22.23	46.00	23.77	Hori.	21.1	132	LA20	
7	42.723	29.70	13.62	7.58	38.94	11.96	40.00	28.04	Vert.	100	28	BA	
8	71.922	29.30	6.38	8.13	39.01	4.80	40.00	35.20	Vert.	100	303	BA	
9	251.970	33.10	11.84	10.25	39.00	16.19	46.00	29.81	Vert.	100	161	LA20	
10	296.945	45.80	13.55	10.66	38.90	31.11	46.00	14.89	Vert.	100	194	LA20	
11	584.901	27.80	18.78	12.76	38.40	20.94	46.00	25.06	Vert.	173	103	LA20	
12	734.158	27.10	20.33	13.68	38.38	22.73	46.00	23.27	Vert.	100	132	LA20	

CHART: WITH FACTOR

ANT TYPE: - 30 MHz: LOOP, 30 MHz - 200 MHz: BICONICAL, 200 MHz - 1000 MHz: LOGPERIODIC, 1000 MHz -: HORN
CALCULATION: RESULT = READING + ANT FACTOR + LOSS & GAIN (CABLE - GAIN(AMP))

UL Japan, Inc.

Ise EMC Lab.

4383-326 Asama-cho, Ise-shi, Mie-ken 516-0021 JAPAN

Telephone : +81 596 24 8999

Facsimile : +81 596 24 8124

-26 dB Bandwidth and 99 % Occupied Bandwidth

Report No. 12742873H
 Test place Ise EMC Lab.
 Semi Anechoic Chamber No.1
 Date April 18, 2019
 Temperature / Humidity 22 deg. C / 35 % RH
 Engineer Ken Fujita
 Mode Tx 125 kHz, LF Antenna (M)

-26 dB Bandwidth [kHz]	99 % Occupied Bandwidth [kHz]
11.169	11.4322

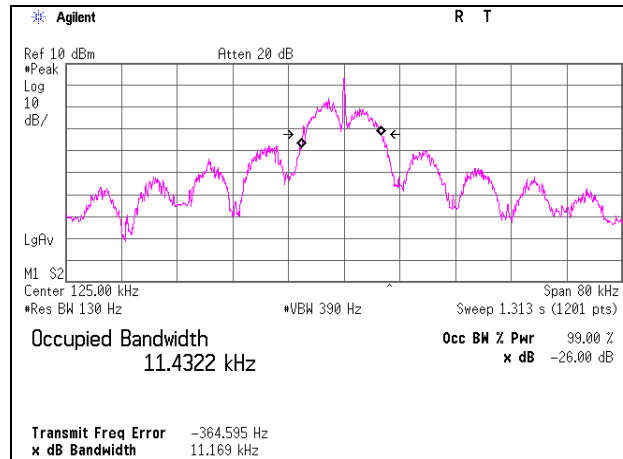

UL Japan, Inc.

Ise EMC Lab.

4383-326 Asama-cho, Ise-shi, Mie-ken 516-0021 JAPAN

Telephone : +81 596 24 8999

Facsimile : +81 596 24 8124

-26 dB Bandwidth and 99 % Occupied Bandwidth

Report No. 12742873H
 Test place Ise EMC Lab.
 Semi Anechoic Chamber No.1
 Date April 10, 2019
 Temperature / Humidity 23 deg. C / 31 % RH
 Engineer Tomohisa Nakagawa
 Mode Tx 125 kHz, LF Antenna (R)

-26 dB Bandwidth [kHz]	99 % Occupied Bandwidth [kHz]
25.231	21.6120

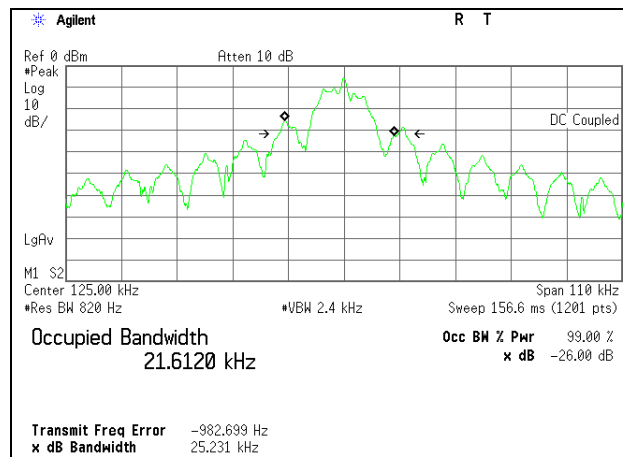

UL Japan, Inc.

Ise EMC Lab.

4383-326 Asama-cho, Ise-shi, Mie-ken 516-0021 JAPAN

Telephone : +81 596 24 8999

Facsimile : +81 596 24 8124

-26 dB Bandwidth and 99 % Occupied Bandwidth

Report No. 12742873H
 Test place Ise EMC Lab.
 Semi Anechoic Chamber No.1
 Date April 18, 2019
 Temperature / Humidity 22 deg. C / 35 % RH
 Engineer Ken Fujita
 Mode Tx 125 kHz, Start Button

-26 dB Bandwidth [kHz]	99 % Occupied Bandwidth [kHz]
5.013	10.5783

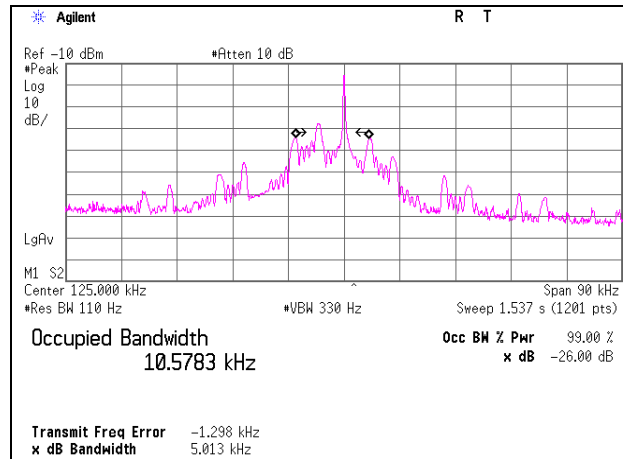

UL Japan, Inc.

Ise EMC Lab.

4383-326 Asama-cho, Ise-shi, Mie-ken 516-0021 JAPAN

Telephone : +81 596 24 8999

Facsimile : +81 596 24 8124

APPENDIX 2: Test instruments

Test Instruments

Test Item	LIMS ID	Description	Manufacturer	Model	Serial	Last Calibration Date	Calibration Due Date	Cal Int
RE	142011	AC4_Semi Anechoic Chamber(NSA)	TDK	Semi Anechoic Chamber 3m	DA-10005	2018/6/28	2020/6/30	24
RE	148898	Attenuator	KEYSIGHT	8491A	MY52462282	2018/10/3	2019/10/31	12
RE	142227	Measure	KOMELON	KMC-36	-	-	-	-
RE	141152	EMI measurement program	TSJ	TEPTO-DV	-	-	-	-
RE	141949	Test Receiver	Rohde & Schwarz	ESCI	100767	2018/8/6	2019/8/31	12
RE	141425	Biconical Antenna	Schwarzbeck	BBA9106	1302	2018/6/1	2019/6/30	12
RE	141267	Logperiodic Antenna(200-1000MHz)	Schwarzbeck	VUSLP9111B	911B-192	2018/6/1	2019/6/30	12
RE	141397	Coaxial Cable	UL Japan	-	-	2018/6/13	2019/6/30	12
RE	141583	Pre Amplifier	SONOMA INSTRUMENT	310	260833	2019/2/8	2020/2/29	12
RE	141545	DIGITAL HiTESTER	HIOKI	3805	51201148	2019/1/29	2020/1/31	12
RE	141254	Loop Antenna	Rohde & Schwarz	HFH2-Z2	100017	2018/10/11	2019/10/31	12
RE	141156	Attenuator(10dB)	Weinschel Corp	2	BL1173	2018/11/2	2019/11/30	12
RE	141217	Coaxial cable	Fujikura/Suhner/TSJ	5D-2W/SFM141/421-010/sucoform141-P	-/04178	2018/6/13	2019/6/30	12
RE	141562	Thermo-Hygrometer	CUSTOM	CTH-201	10	2019/1/11	2020/1/31	12
RE	141901	Spectrum Analyzer	AGILENT	E4440A	MY48250080	2018/10/4	2019/10/31	12
RE	141998	AC1_Semi Anechoic Chamber(NSA)	TDK	Semi Anechoic Chamber 10m	DA-06881	6/18/2018	6/30/2020	24
RE	141582	Pre Amplifier	SONOMA INSTRUMENT	310	260834	2/8/2019	2/29/2020	12
RE	142226	Measure	KOMELON	KMC-36	-	-	-	-
RE	141566	Thermo-Hygrometer	CUSTOM	CTH-201	A08Q26	1/11/2019	1/31/2020	12
RE	141530	Digital Tester	Fluke Corporation	FLUKE 26-3	78030621	8/21/2018	8/31/2019	12
RE	141215	Coaxial Cable	Fujikura/Suhner/TSJ	5D-2W/3D-2W/RG400u/RFM-E421(SW)	-/01068(Switcher)	6/4/2018	6/30/2019	12
RE	141413	Coaxial Cable	UL Japan	-	-	6/12/2018	6/30/2019	12
RE	141213	Attenuator(6dB)	Weinschel Corp	2	BK7971	11/5/2018	11/30/2019	12
RE	141950	EMI Test Receiver	Rohde & Schwarz	ESU26	100412	6/15/2018	6/30/2019	12

*Hyphens for Last Calibration Date, Calibration Due Date and Cal Int (month) are instruments that Calibration is not required (e.g. software), or instruments checked in advance before use.

The expiration date of the calibration is the end of the expired month.

All equipment is calibrated with valid calibrations. Each measurement data is traceable to the national or international standards.

As for some calibrations performed after the tested dates, those test equipment have been controlled by means of an unbroken chains of calibrations.

Test item:

RE: Spurious emission

UL Japan, Inc.

Ise EMC Lab.

4383-326 Asama-cho, Ise-shi, Mie-ken 516-0021 JAPAN

Telephone : +81 596 24 8999

Facsimile : +81 596 24 8124