



WAYLENS

QUICK START GUIDE

WAYLENS CAMERA



- ① Power button
- ② MicroSD card cover



- ③ 5-pin power & data port
- ④ Mount release button

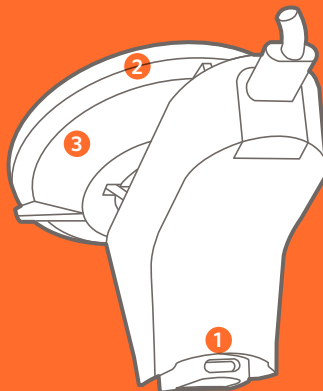

CAR MOUNT

- ① 5-pin power & data connector
- ② Suction cup
- ③ Locking wheel

REMOTE CONTROL

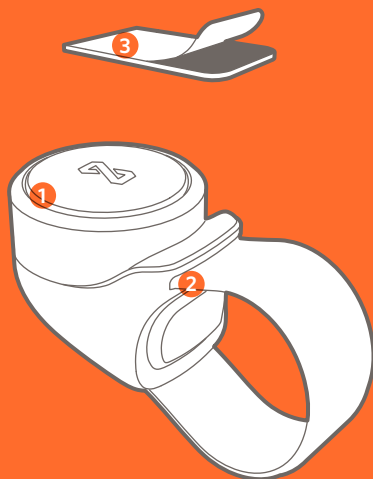

- ① Highlight button
- ② Separable strap case
- ③ Double-sided tape

**CAR
CHARGER**

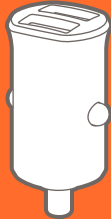

**USB
ADAPTER**

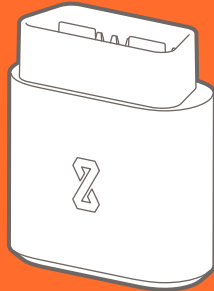

**OBD
TRANSMITTER**

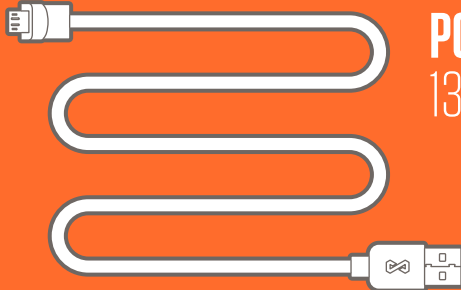

POWER CABLE
13ft (4m)

**POWER&DATA
CABLE**
4ft (1.2m)



CABLE HOLDER × 12

Install microSD card

Waylens camera doesn't ship with a microSD card. It is necessary to install one before using the camera.

Open the microSD card cover right below the Power button to locate the card slot.

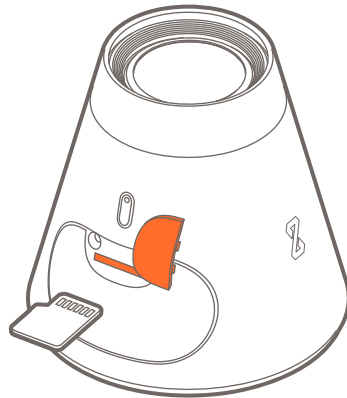

Set up Waylens camera in your car

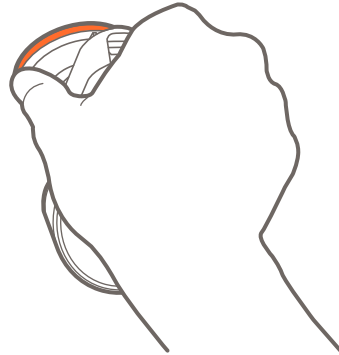
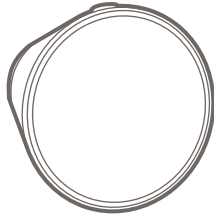

1. Make sure the locking wheel is relaxed; firmly conjoin the camera and the mount through the 5-pin port.

2. Clean the glass surface where you'd like to place the camera; firmly press the suction cup to secure it on the surface.

Set up Waylens camera in your car

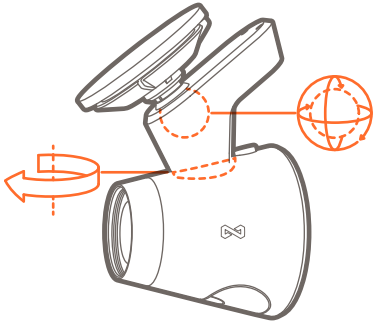

3. Adjust orientation of the camera.*

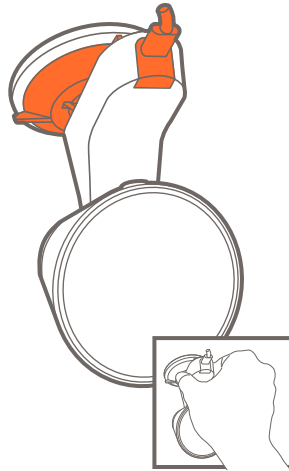

4. Rotate the wheel until the mount is locked, the suction cup will be fastened as a result; insert the charging cable.**

* The camera can be still rotated horizontally after the mount is locked.

** While rotating wheel, holding the mount with one hand could help stabilize it.

Set up Waylens camera in your car

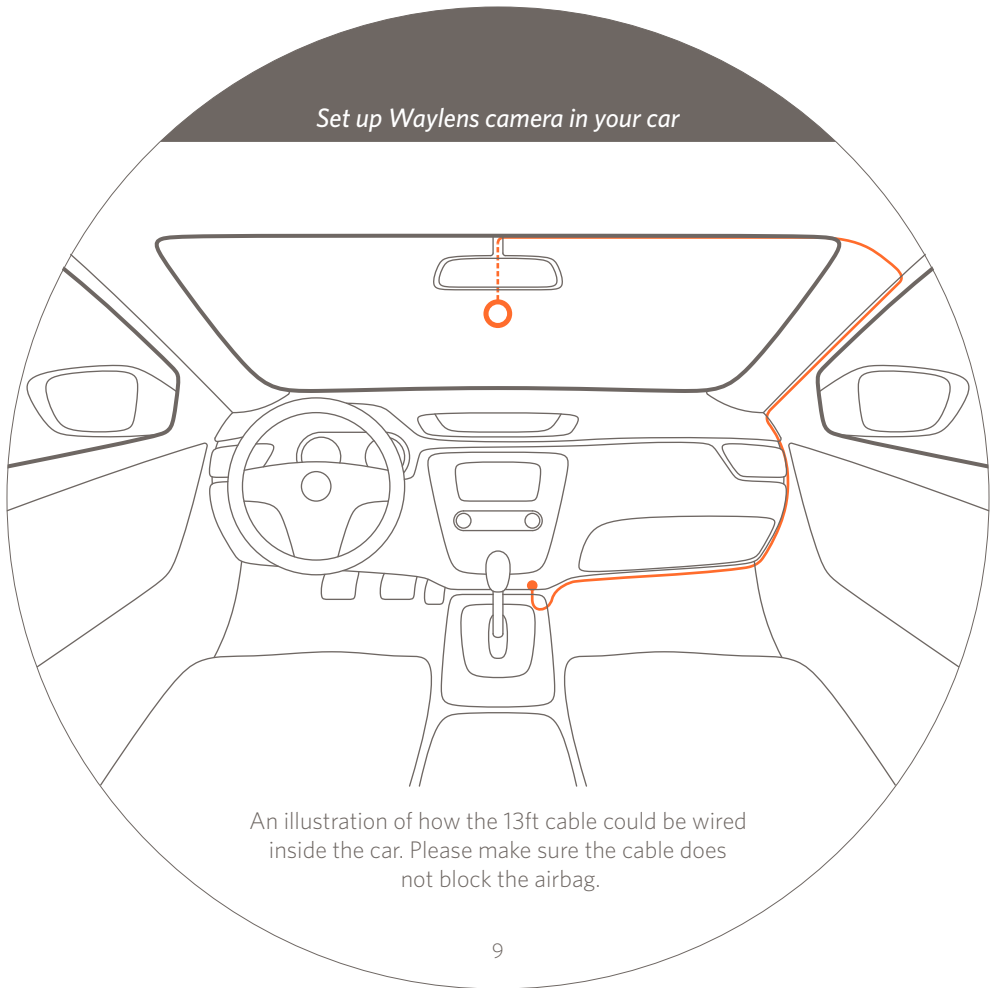

An illustration of how the 13ft cable could be wired inside the car. Please make sure the cable does not block the airbag.

Set up the OBD Transmitter in your car

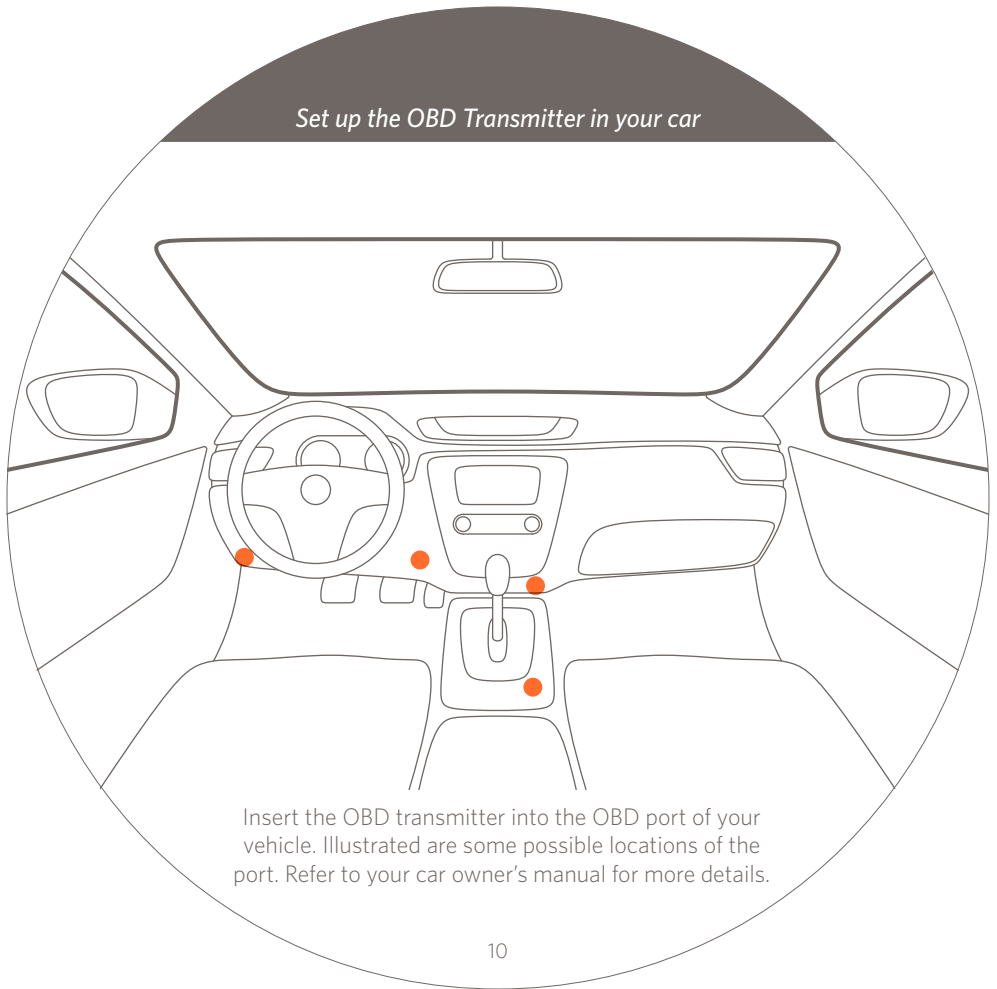

Insert the OBD transmitter into the OBD port of your vehicle. Illustrated are some possible locations of the port. Refer to your car owner's manual for more details.

Using the Remote Control

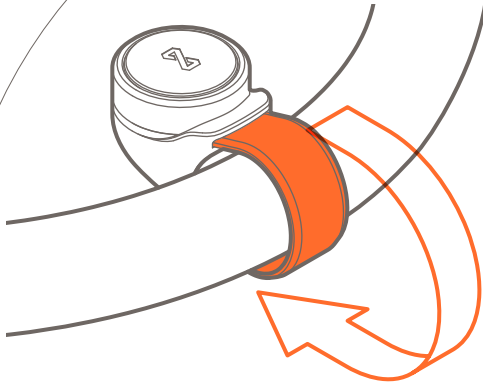

The Waylens remote control allows you to highlight videos behind the wheel without touching the camera or the smartphone.

Fasten the strap to secure the remote on the wheel.

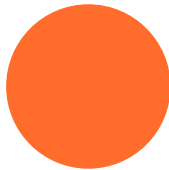

● Single-click to highlight.

▬ Long-press function is customizable

Using the Remote Control

The remote control can be mounted to your steering wheel with the included strap. Alternatively, the remote can be detached from the strap case and mounted to any flat surface using the included double-sided tape.

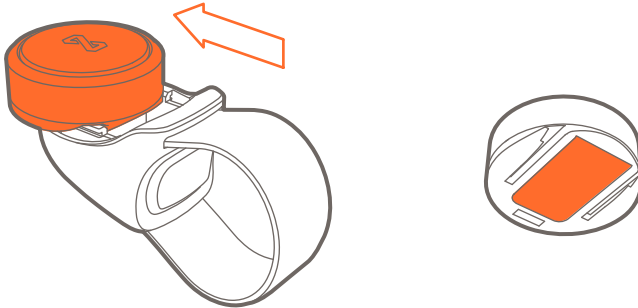

1. To detach the remote from the strap case, slide the remote control as shown.

2. Attach the adhesive to the highlighted area.

Using Waylens Camera outside the car

With the USB adapter, you could charge the camera or manage content of the camera using your computer at home.

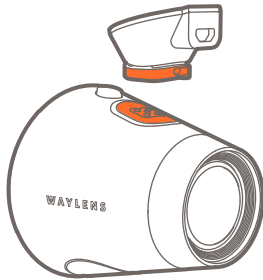

1. Insert the USB Adapter into the camera's power and data port.

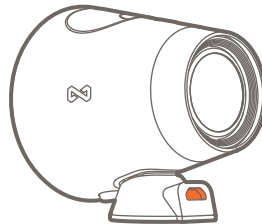

2. Flip it to the flat surface; connect the camera through a micro-USB cable to a USB charger or a computer.*

*USB charger is not included.

Waylens app is available on App Store and Google Play.

There is also a Waylens desktop app available on our website:

www.waylens.com/desktop

FCC Radiation Exposure Statement:

This equipment complies with FCC radiation exposure limits set forth for an uncontrolled environment. This equipment should be installed and operated with minimum distance 20cm between the radiator & your body.

FCC Warning

This device complies with Part 15 of the FCC Rules. Operation is subject to the following two conditions: (1) This device may not cause harmful interference, and (2) this device must accept any interference received, including interference that may cause undesired operation.

NOTE 1: This equipment has been tested and found to comply with the limits for a Class B digital device, pursuant to part 15 of the FCC Rules. These limits are designed to provide reasonable protection against harmful interference in a residential installation. This equipment generates, uses and can radiate radio frequency energy and, if not installed and used in accordance with the instructions, may cause harmful interference to radio communications. However, there is no guarantee that interference will not occur in a particular installation. If this equipment does cause harmful interference to radio or television reception, which can be determined by turning the equipment off and on, the user is encouraged to try to correct the interference by one or more of the following measures:

- Reorient or relocate the receiving antenna.
- Increase the separation between the equipment and receiver.
- Connect the equipment into an outlet on a circuit different from that to which the receiver is connected.
- Consult the dealer or an experienced radio/TV technician for help.

NOTE 2: Any changes or modifications to this unit not expressly approved by the party responsible for compliance could void the user's authority to operate the equipment.

Waylens Inc., 50 Milk St., 16th Fl., Boston, MA 02109, USA

© 2016 Waylens Inc. All rights reserved.

Waylens™ is a trademark of Waylens Inc.